

CHAPTER 1 PRELIMINARIES

1.1 REAL NUMBERS AND THE REAL LINE

- Executing long division, $\frac{1}{9} = 0.\overline{1}$, $\frac{2}{9} = 0.\overline{2}$, $\frac{3}{9} = 0.\overline{3}$, $\frac{8}{9} = 0.\overline{8}$, $\frac{9}{9} = 0.\overline{9}$
- Executing long division, $\frac{1}{11} = 0.\overline{09}$, $\frac{2}{11} = 0.\overline{18}$, $\frac{3}{11} = 0.\overline{27}$, $\frac{9}{11} = 0.\overline{81}$, $\frac{11}{11} = 0.\overline{99}$
- NT = necessarily true, NNT = Not necessarily true. Given: $2 < x < 6$.
 - NNT. 5 is a counter example.
 - NT. $2 < x < 6 \Rightarrow 2 - 2 < x - 2 < 6 - 2 \Rightarrow 0 < x - 2 < 2$.
 - NT. $2 < x < 6 \Rightarrow 2/2 < x/2 < 6/2 \Rightarrow 1 < x < 3$.
 - NT. $2 < x < 6 \Rightarrow 1/2 > 1/x > 1/6 \Rightarrow 1/6 < 1/x < 1/2$.
 - NT. $2 < x < 6 \Rightarrow 1/2 > 1/x > 1/6 \Rightarrow 1/6 < 1/x < 1/2 \Rightarrow 6(1/6) < 6(1/x) < 6(1/2) \Rightarrow 1 < 6/x < 3$.
 - NT. $2 < x < 6 \Rightarrow x < 6 \Rightarrow (x - 4) < 2$ and $2 < x < 6 \Rightarrow x > 2 \Rightarrow -x < -2 \Rightarrow -x + 4 < 2 \Rightarrow -(x - 4) < 2$.
The pair of inequalities $(x - 4) < 2$ and $-(x - 4) < 2 \Rightarrow |x - 4| < 2$.
 - NT. $2 < x < 6 \Rightarrow -2 > -x > -6 \Rightarrow -6 < -x < -2$. But $-2 < 2$. So $-6 < -x < -2 < 2$ or $-6 < -x < 2$.
 - NT. $2 < x < 6 \Rightarrow -1(2) > -1(x) < -1(6) \Rightarrow -6 < -x < -2$

- NT = necessarily true, NNT = Not necessarily true. Given: $-1 < y - 5 < 1$.
 - NT. $-1 < y - 5 < 1 \Rightarrow -1 + 5 < y - 5 + 5 < 1 + 5 \Rightarrow 4 < y < 6$.
 - NNT. $y = 5$ is a counter example. (Actually, never true given that $4 < y < 6$)
 - NT. From a), $-1 < y - 5 < 1, \Rightarrow 4 < y < 6 \Rightarrow y > 4$.
 - NT. From a), $-1 < y - 5 < 1, \Rightarrow 4 < y < 6 \Rightarrow y < 6$.
 - NT. $-1 < y - 5 < 1 \Rightarrow -1 + 1 < y - 5 + 1 < 1 + 1 \Rightarrow 0 < y - 4 < 2$.
 - NT. $-1 < y - 5 < 1 \Rightarrow (1/2)(-1 + 5) < (1/2)(y - 5 + 5) < (1/2)(1 + 5) \Rightarrow 2 < y/2 < 3$.
 - NT. From a), $4 < y < 6 \Rightarrow 1/4 > 1/y > 1/6 \Rightarrow 1/6 < 1/y < 1/4$.
 - NT. $-1 < y - 5 < 1 \Rightarrow y - 5 > -1 \Rightarrow y > 4 \Rightarrow -y < -4 \Rightarrow -y + 5 < 1 \Rightarrow -(y - 5) < 1$.
Also, $-1 < y - 5 < 1 \Rightarrow y - 5 < 1$. The pair of inequalities $-(y - 5) < 1$ and $(y - 5) < 1 \Rightarrow |y - 5| < 1$.

5. $-2x > 4 \Rightarrow x < -2$

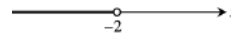

6. $8 - 3x \geq 5 \Rightarrow -3x \geq -3 \Rightarrow x \leq 1$

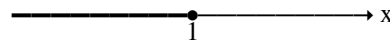

7. $5x - 3 \leq 7 - 3x \Rightarrow 8x \leq 10 \Rightarrow x \leq \frac{5}{4}$

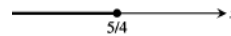

8. $3(2 - x) > 2(3 + x) \Rightarrow 6 - 3x > 6 + 2x$
 $\Rightarrow 0 > 5x \Rightarrow 0 > x$

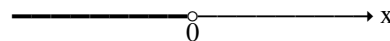

9. $2x - \frac{1}{2} \geq 7x + \frac{7}{6} \Rightarrow -\frac{1}{2} - \frac{7}{6} \geq 5x$
 $\Rightarrow \frac{1}{5} \left(-\frac{10}{6}\right) \geq x$ or $-\frac{1}{3} \geq x$

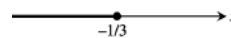

10. $\frac{6-x}{4} < \frac{3x-4}{2} \Rightarrow 12 - 2x < 12x - 16$
 $\Rightarrow 28 < 14x \Rightarrow 2 < x$

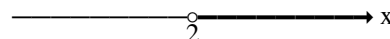

2 Chapter 1 Preliminaries

11. $\frac{4}{5}(x-2) < \frac{1}{3}(x-6) \Rightarrow 12(x-2) < 5(x-6)$
 $\Rightarrow 12x - 24 < 5x - 30 \Rightarrow 7x < -6$ or $x < -\frac{6}{7}$

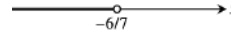

12. $-\frac{x+5}{2} \leq \frac{12+3x}{4} \Rightarrow -(4x+20) \leq 24+6x$
 $\Rightarrow -44 \leq 10x \Rightarrow -\frac{22}{5} \leq x$

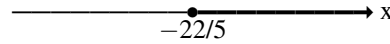

13. $y = 3$ or $y = -3$

14. $y - 3 = 7$ or $y - 3 = -7 \Rightarrow y = 10$ or $y = -4$

15. $2t + 5 = 4$ or $2t + 5 = -4 \Rightarrow 2t = -1$ or $2t = -9 \Rightarrow t = -\frac{1}{2}$ or $t = -\frac{9}{2}$

16. $1 - t = 1$ or $1 - t = -1 \Rightarrow -t = 0$ or $-t = -2 \Rightarrow t = 0$ or $t = 2$

17. $8 - 3s = \frac{9}{2}$ or $8 - 3s = -\frac{9}{2} \Rightarrow -3s = -\frac{7}{2}$ or $-3s = -\frac{25}{2} \Rightarrow s = \frac{7}{6}$ or $s = \frac{25}{6}$

18. $\frac{s}{2} - 1 = 1$ or $\frac{s}{2} - 1 = -1 \Rightarrow \frac{s}{2} = 2$ or $\frac{s}{2} = 0 \Rightarrow s = 4$ or $s = 0$

19. $-2 < x < 2$; solution interval $(-2, 2)$

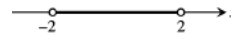

20. $-2 \leq x \leq 2$; solution interval $[-2, 2]$



21. $-3 \leq t - 1 \leq 3 \Rightarrow -2 \leq t \leq 4$; solution interval $[-2, 4]$

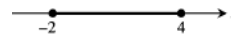

22. $-1 < t + 2 < 1 \Rightarrow -3 < t < -1$;
 solution interval $(-3, -1)$



23. $-4 < 3y - 7 < 4 \Rightarrow 3 < 3y < 11 \Rightarrow 1 < y < \frac{11}{3}$;
 solution interval $(1, \frac{11}{3})$



24. $-1 < 2y + 5 < 1 \Rightarrow -6 < 2y < -4 \Rightarrow -3 < y < -2$;
 solution interval $(-3, -2)$



25. $-1 \leq \frac{z}{5} - 1 \leq 1 \Rightarrow 0 \leq \frac{z}{5} \leq 2 \Rightarrow 0 \leq z \leq 10$;
 solution interval $[0, 10]$

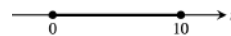

26. $-2 \leq \frac{3z}{2} - 1 \leq 2 \Rightarrow -1 \leq \frac{3z}{2} \leq 3 \Rightarrow -\frac{2}{3} \leq z \leq 2$;
 solution interval $[-\frac{2}{3}, 2]$



27. $-\frac{1}{2} < 3 - \frac{1}{x} < \frac{1}{2} \Rightarrow -\frac{7}{2} < -\frac{1}{x} < -\frac{5}{2} \Rightarrow \frac{7}{2} > \frac{1}{x} > \frac{5}{2}$
 $\Rightarrow \frac{2}{7} < x < \frac{2}{5}$; solution interval $(\frac{2}{7}, \frac{2}{5})$

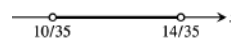

28. $-3 < \frac{2}{x} - 4 < 3 \Rightarrow 1 < \frac{2}{x} < 7 \Rightarrow 1 > \frac{x}{2} > \frac{1}{7}$
 $\Rightarrow 2 > x > \frac{2}{7} \Rightarrow \frac{2}{7} < x < 2$; solution interval $(\frac{2}{7}, 2)$



29. $2s \geq 4$ or $-2s \geq 4 \Rightarrow s \geq 2$ or $s \leq -2$;

solution intervals $(-\infty, -2] \cup [2, \infty)$



30. $s + 3 \geq \frac{1}{2}$ or $-(s + 3) \geq \frac{1}{2} \Rightarrow s \geq -\frac{5}{2}$ or $-s \geq \frac{7}{2}$

$\Rightarrow s \geq -\frac{5}{2}$ or $s \leq -\frac{7}{2}$;

solution intervals $(-\infty, -\frac{7}{2}] \cup [-\frac{5}{2}, \infty)$



31. $1 - x > 1$ or $-(1 - x) > 1 \Rightarrow -x > 0$ or $x > 2$

$\Rightarrow x < 0$ or $x > 2$; solution intervals $(-\infty, 0) \cup (2, \infty)$



32. $2 - 3x > 5$ or $-(2 - 3x) > 5 \Rightarrow -3x > 3$ or $3x > 7$

$\Rightarrow x < -1$ or $x > \frac{7}{3}$;

solution intervals $(-\infty, -1) \cup (\frac{7}{3}, \infty)$

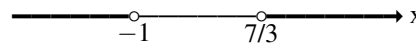

33. $\frac{r+1}{2} \geq 1$ or $-\left(\frac{r+1}{2}\right) \geq 1 \Rightarrow r + 1 \geq 2$ or $r + 1 \leq -2$

$\Rightarrow r \geq 1$ or $r \leq -3$; solution intervals $(-\infty, -3] \cup [1, \infty)$



34. $\frac{3r}{5} - 1 > \frac{2}{5}$ or $-\left(\frac{3r}{5} - 1\right) > \frac{2}{5}$

$\Rightarrow \frac{3r}{5} > \frac{7}{5}$ or $-\frac{3r}{5} > -\frac{3}{5} \Rightarrow r > \frac{7}{3}$ or $r < 1$

solution intervals $(-\infty, 1) \cup (\frac{7}{3}, \infty)$

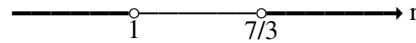

35. $x^2 < 2 \Rightarrow |x| < \sqrt{2} \Rightarrow -\sqrt{2} < x < \sqrt{2}$;

solution interval $(-\sqrt{2}, \sqrt{2})$



36. $4 \leq x^2 \Rightarrow 2 \leq |x| \Rightarrow x \geq 2$ or $x \leq -2$;

solution interval $(-\infty, -2] \cup [2, \infty)$

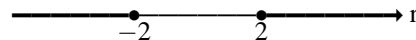

37. $4 < x^2 < 9 \Rightarrow 2 < |x| < 3 \Rightarrow 2 < x < 3$ or $2 < -x < 3$

$\Rightarrow 2 < x < 3$ or $-3 < x < -2$;

solution intervals $(-3, -2) \cup (2, 3)$

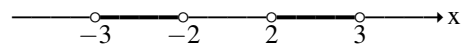

38. $\frac{1}{9} < x^2 < \frac{1}{4} \Rightarrow \frac{1}{3} < |x| < \frac{1}{2} \Rightarrow \frac{1}{3} < x < \frac{1}{2}$ or $\frac{1}{3} < -x < \frac{1}{2}$

$\Rightarrow \frac{1}{3} < x < \frac{1}{2}$ or $-\frac{1}{2} < x < -\frac{1}{3}$;

solution intervals $(-\frac{1}{2}, -\frac{1}{3}) \cup (\frac{1}{3}, \frac{1}{2})$

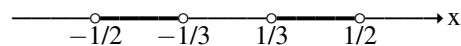

39. $(x - 1)^2 < 4 \Rightarrow |x - 1| < 2 \Rightarrow -2 < x - 1 < 2$

$\Rightarrow -1 < x < 3$; solution interval $(-1, 3)$



40. $(x + 3)^2 < 2 \Rightarrow |x + 3| < \sqrt{2}$

$\Rightarrow -\sqrt{2} < x + 3 < \sqrt{2}$ or $-3 - \sqrt{2} < x < -3 + \sqrt{2}$;

solution interval $(-3 - \sqrt{2}, -3 + \sqrt{2})$



4 Chapter 1 Preliminaries

41. $x^2 - x < 0 \Rightarrow x^2 - x + \frac{1}{4} < \frac{1}{4} \Rightarrow (x - \frac{1}{2})^2 < \frac{1}{4} \Rightarrow |x - \frac{1}{2}| < \frac{1}{2} \Rightarrow -\frac{1}{2} < x - \frac{1}{2} < \frac{1}{2} \Rightarrow 0 < x < 1.$

So the solution is the interval (0, 1)

42. $x^2 - x - 2 \geq 0 \Rightarrow x^2 - x + \frac{1}{4} \geq \frac{9}{4} \Rightarrow |x - \frac{1}{2}| \geq \frac{3}{2} \Rightarrow x - \frac{1}{2} \geq \frac{3}{2} \text{ or } -(x - \frac{1}{2}) \geq \frac{3}{2} \Rightarrow x \geq 2 \text{ or } x \leq -1.$

The solution interval is $(-\infty, -1] \cup [2, \infty)$

43. True if $a \geq 0$; False if $a < 0$.

44. $|x - 1| = 1 - x \Leftrightarrow |-(x - 1)| = 1 - x \Leftrightarrow 1 - x \geq 0 \Leftrightarrow x \leq 1$

45. (1) $|a + b| = (a + b)$ or $|a + b| = -(a + b)$;

both squared equal $(a + b)^2$

(2) $ab \leq |ab| = |a| |b|$

(3) $|a| = a$ or $|a| = -a$, so $|a|^2 = a^2$; likewise, $|b|^2 = b^2$

(4) $x^2 \leq y^2$ implies $\sqrt{x^2} \leq \sqrt{y^2}$ or $x \leq y$ for all nonnegative real numbers x and y . Let $x = |a + b|$ and $y = |a| + |b|$ so that $|a + b|^2 \leq (|a| + |b|)^2 \Rightarrow |a + b| \leq |a| + |b|.$

46. If $a \geq 0$ and $b \geq 0$, then $ab \geq 0$ and $|ab| = ab = |a| |b|.$

If $a < 0$ and $b < 0$, then $ab > 0$ and $|ab| = ab = (-a)(-b) = |a| |b|.$

If $a \geq 0$ and $b < 0$, then $ab \leq 0$ and $|ab| = -(ab) = (a)(-b) = |a| |b|.$

If $a < 0$ and $b \geq 0$, then $ab \leq 0$ and $|ab| = -(ab) = (-a)(b) = |a| |b|.$

47. $-3 \leq x \leq 3$ and $x > -\frac{1}{2} \Rightarrow -\frac{1}{2} < x \leq 3.$

48. Graph of $|x| + |y| \leq 1$ is the interior of "diamond-shaped" region.

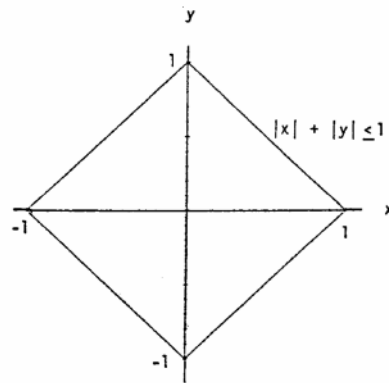

49. Let δ be a real number > 0 and $f(x) = 2x + 1$. Suppose that $|x - 1| < \delta$. Then $|x - 1| < \delta \Rightarrow 2|x - 1| < 2\delta \Rightarrow |2x - 2| < 2\delta \Rightarrow |(2x + 1) - 3| < 2\delta \Rightarrow |f(x) - f(1)| < 2\delta$

50. Let $\epsilon > 0$ be any positive number and $f(x) = 2x + 3$. Suppose that $|x - 0| < \epsilon/2$. Then $2|x - 0| < \epsilon$ and $|2x + 3 - 3| < \epsilon$. But $f(x) = 2x + 3$ and $f(0) = 3$. Thus $|f(x) - f(0)| < \epsilon$.

51. Consider: i) $a > 0$; ii) $a < 0$; iii) $a = 0$.

i) For $a > 0$, $|a| = a$ by definition. Now, $a > 0 \Rightarrow -a < 0$. Let $-a = b$. By definition, $|b| = -b$. Since $b = -a$, $|-a| = -(-a) = a$ and $|a| = |-a| = a$.

ii) For $a < 0$, $|a| = -a$. Now, $a < 0 \Rightarrow -a > 0$. Let $-a = b$. By definition, $|b| = b$ and thus $|-a| = -a$. So again $|a| = |-a|$.

iii) By definition $|0| = 0$ and since $-0 = 0$, $|-0| = 0$. Thus, by i), ii), and iii) $|a| = |-a|$ for any real number.

52. i) Prove $|x| > 0 \Rightarrow x > a$ or $x < -a$ for any positive number, a .

For $x \geq 0$, $|x| = x$. $|x| > a \Rightarrow x > a$.

For $x < 0$, $|x| = -x$. $|x| > a \Rightarrow -x > a \Rightarrow x < -a$.

ii) Prove $x > a$ or $x < -a \Rightarrow |x| > 0$ for any positive number, a .

$a > 0$ and $x > a \Rightarrow |x| = x$. So $x > a \Rightarrow |x| > a$.

For $a > 0$, $-a < 0$ and $x < -a \Rightarrow x < 0 \Rightarrow |x| = -x$. So $x < -a \Rightarrow -x > a \Rightarrow |x| > a$.

$$53. a) \quad 1 = 1 \Rightarrow |1| = 1 \Rightarrow \left| b \cdot \frac{1}{b} \right| = \frac{|b|}{|b|} \Rightarrow |b| \cdot \left| \frac{1}{b} \right| = \frac{|b|}{|b|} \Rightarrow \frac{|b| \cdot \left| \frac{1}{b} \right|}{|b|} = \frac{|b|}{|b \cdot \frac{1}{b}|} \Rightarrow \left| \frac{1}{b} \right| = \frac{1}{|b|}$$

$$b) \quad \frac{|a|}{|b|} = \left| a \cdot \frac{1}{b} \right| = \left| a \right| \cdot \left| \frac{1}{b} \right| = \left| a \right| \cdot \frac{1}{|b|} = \frac{|a|}{|b|}$$

54. Prove $S_n = |a^n| = |a|^n$ for any real number a and any positive integer n .

$|a^1| = |a|^1 = a$, so S_1 is true. Now, assume that $S_k = |a^k| = |a|^k$ is true for some positive integer k .

Since $|a^1| = |a|^1$ and $|a^k| = |a|^k$, we have $|a^{k+1}| = |a^k \cdot a^1| = |a^k| |a^1| = |a|^k |a|^1 = |a|^{k+1}$. Thus,

$S_{k+1} = |a^{k+1}| = |a|^{k+1}$ is also true. Thus by the Principle of Mathematical Induction, $S_n = |a^n| = |a|^n$ is true for all n positive integers.

1.2 LINES, CIRCLES, AND PARABOLAS

1. $\Delta x = -1 - (-3) = 2$, $\Delta y = -2 - 2 = -4$; $d = \sqrt{(\Delta x)^2 + (\Delta y)^2} = \sqrt{4 + 16} = 2\sqrt{5}$

2. $\Delta x = -3 - (-1) = -2$, $\Delta y = 2 - (-2) = 4$; $d = \sqrt{(-2)^2 + 4^2} = 2\sqrt{5}$

3. $\Delta x = -8.1 - (-3.2) = -4.9$, $\Delta y = -2 - (-2) = 0$; $d = \sqrt{(-4.9)^2 + 0^2} = 4.9$

4. $\Delta x = 0 - \sqrt{2} = -\sqrt{2}$, $\Delta y = 1.5 - 4 = -2.5$; $d = \sqrt{(-\sqrt{2})^2 + (-2.5)^2} = \sqrt{8.25}$

5. Circle with center $(0, 0)$ and radius 1.

6. Circle with center $(0, 0)$ and radius $\sqrt{2}$.

7. Disk (i.e., circle together with its interior points) with center $(0, 0)$ and radius $\sqrt{3}$.

8. The origin (a single point).

9. $m = \frac{\Delta y}{\Delta x} = \frac{-1-2}{-2-(-1)} = 3$

perpendicular slope = $-\frac{1}{3}$

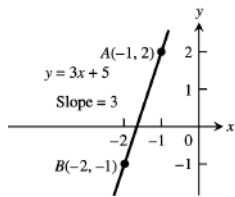

10. $m = \frac{\Delta y}{\Delta x} = \frac{-2-1}{2-(-2)} = -\frac{3}{4}$

perpendicular slope = $\frac{4}{3}$

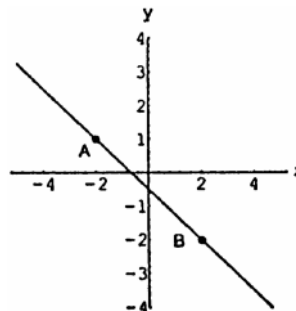

6 Chapter 1 Preliminaries

11. $m = \frac{\Delta y}{\Delta x} = \frac{3-3}{-1-2} = 0$

perpendicular slope does not exist

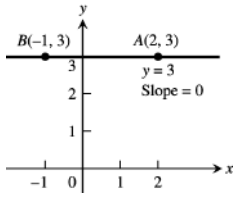

12. $m = \frac{\Delta y}{\Delta x} = \frac{-2-0}{-2-(-2)}$; no slope

perpendicular slope = 0

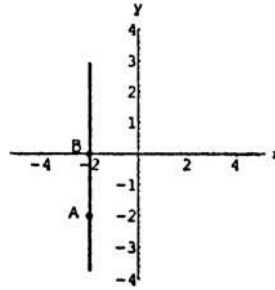

13. (a) $x = -1$

(b) $y = \frac{4}{3}$

14. (a) $x = \sqrt{2}$

(b) $y = -1.3$

15. (a) $x = 0$

(b) $y = -\sqrt{2}$

16. (a) $x = -\pi$

(b) $y = 0$

17. $P(-1, 1), m = -1 \Rightarrow y - 1 = -1(x - (-1)) \Rightarrow y = -x$

18. $P(2, -3), m = \frac{1}{2} \Rightarrow y - (-3) = \frac{1}{2}(x - 2) \Rightarrow y = \frac{1}{2}x - 4$

19. $P(3, 4), Q(-2, 5) \Rightarrow m = \frac{\Delta y}{\Delta x} = \frac{5-4}{-2-3} = -\frac{1}{5} \Rightarrow y - 4 = -\frac{1}{5}(x - 3) \Rightarrow y = -\frac{1}{5}x + \frac{23}{5}$

20. $P(-8, 0), Q(-1, 3) \Rightarrow m = \frac{\Delta y}{\Delta x} = \frac{3-0}{-1-(-8)} = \frac{3}{7} \Rightarrow y - 0 = \frac{3}{7}(x - (-8)) \Rightarrow y = \frac{3}{7}x + \frac{24}{7}$

21. $m = -\frac{5}{4}, b = 6 \Rightarrow y = -\frac{5}{4}x + 6$

22. $m = \frac{1}{2}, b = -3 \Rightarrow y = \frac{1}{2}x - 3$

23. $m = 0, P(-12, -9) \Rightarrow y = -9$

24. No slope, $P(\frac{1}{3}, 4) \Rightarrow x = \frac{1}{3}$

25. $a = -1, b = 4 \Rightarrow (0, 4)$ and $(-1, 0)$ are on the line $\Rightarrow m = \frac{\Delta y}{\Delta x} = \frac{0-4}{-1-0} = 4 \Rightarrow y = 4x + 4$

26. $a = 2, b = -6 \Rightarrow (2, 0)$ and $(0, -6)$ are on the line $\Rightarrow m = \frac{\Delta y}{\Delta x} = \frac{-6-0}{0-2} = 3 \Rightarrow y = 3x - 6$

27. $P(5, -1), L: 2x + 5y = 15 \Rightarrow m_L = -\frac{2}{5} \Rightarrow$ parallel line is $y - (-1) = -\frac{2}{5}(x - 5) \Rightarrow y = -\frac{2}{5}x + 1$

28. $P(-\sqrt{2}, 2), L: \sqrt{2}x + 5y = \sqrt{3} \Rightarrow m_L = -\frac{\sqrt{2}}{5} \Rightarrow$ parallel line is $y - 2 = -\frac{\sqrt{2}}{5}(x - (-\sqrt{2})) \Rightarrow y = -\frac{\sqrt{2}}{5}x + \frac{8}{5}$

29. $P(4, 10), L: 6x - 3y = 5 \Rightarrow m_L = 2 \Rightarrow m_{\perp} = -\frac{1}{2} \Rightarrow$ perpendicular line is $y - 10 = -\frac{1}{2}(x - 4) \Rightarrow y = -\frac{1}{2}x + 12$

30. $P(0, 1), L: 8x - 13y = 13 \Rightarrow m_L = \frac{8}{13} \Rightarrow m_{\perp} = -\frac{13}{8} \Rightarrow$ perpendicular line is $y = -\frac{13}{8}x + 1$

31. x-intercept = 4, y-intercept = 3

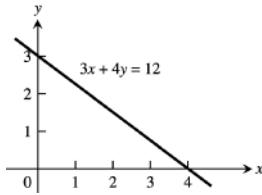

32. x-intercept = -4, y-intercept = -2

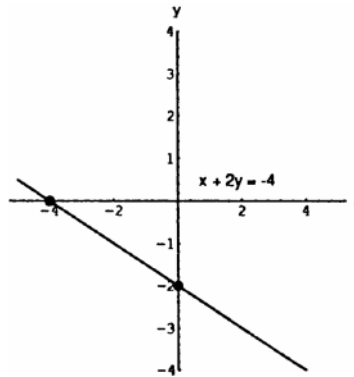

33. x-intercept =
- $\sqrt{3}$
- , y-intercept =
- $-\sqrt{2}$

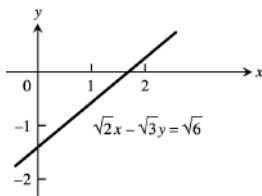

34. x-intercept = -2, y-intercept = 3

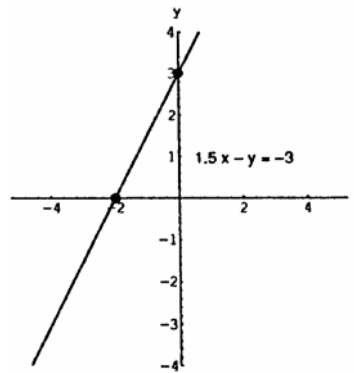

35. $Ax + By = C_1 \Leftrightarrow y = -\frac{A}{B}x + \frac{C_1}{B}$ and $Bx - Ay = C_2 \Leftrightarrow y = \frac{B}{A}x - \frac{C_2}{A}$. Since $(-\frac{A}{B})(\frac{B}{A}) = -1$ is the product of the slopes, the lines are perpendicular.
36. $Ax + By = C_1 \Leftrightarrow y = -\frac{A}{B}x + \frac{C_1}{B}$ and $Ax + By = C_2 \Leftrightarrow y = -\frac{A}{B}x + \frac{C_2}{B}$. Since the lines have the same slope $-\frac{A}{B}$, they are parallel.
37. New position = $(x_{\text{old}} + \Delta x, y_{\text{old}} + \Delta y) = (-2 + 5, 3 + (-6)) = (3, -3)$.
38. New position = $(x_{\text{old}} + \Delta x, y_{\text{old}} + \Delta y) = (6 + (-6), 0 + 0) = (0, 0)$.
39. $\Delta x = 5, \Delta y = 6, B(3, -3)$. Let $A = (x, y)$. Then $\Delta x = x_2 - x_1 \Rightarrow 5 = 3 - x \Rightarrow x = -2$ and $\Delta y = y_2 - y_1 \Rightarrow 6 = -3 - y \Rightarrow y = -9$. Therefore, $A = (-2, -9)$.
40. $\Delta x = 1 - 1 = 0, \Delta y = 0 - 0 = 0$

8 Chapter 1 Preliminaries

41. $C(0, 2), a = 2 \Rightarrow x^2 + (y - 2)^2 = 4$

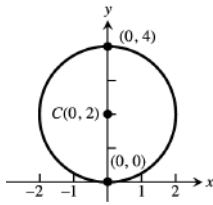

42. $C(-3, 0), a = 3 \Rightarrow (x + 3)^2 + y^2 = 9$

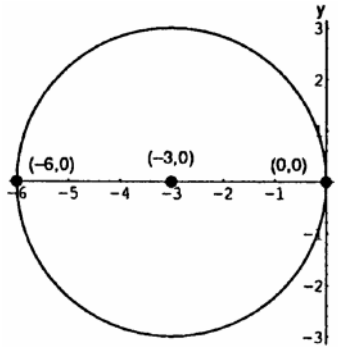

43. $C(-1, 5), a = \sqrt{10} \Rightarrow (x + 1)^2 + (y - 5)^2 = 10$

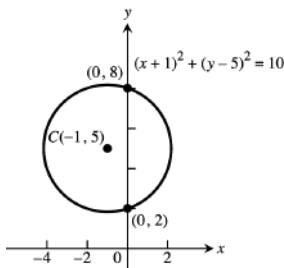

44. $C(1, 1), a = \sqrt{2} \Rightarrow (x - 1)^2 + (y - 1)^2 = 2$
 $x = 0 \Rightarrow (0 - 1)^2 + (y - 1)^2 = 2 \Rightarrow (y - 1)^2 = 1$
 $\Rightarrow y - 1 = \pm 1 \Rightarrow y = 0 \text{ or } y = 2.$
 Similarly, $y = 0 \Rightarrow x = 0 \text{ or } x = 2$

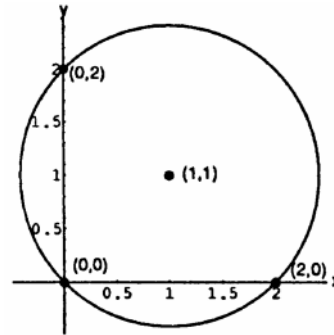

45. $C(-\sqrt{3}, -2), a = 2 \Rightarrow (x + \sqrt{3})^2 + (y + 2)^2 = 4,$
 $x = 0 \Rightarrow (0 + \sqrt{3})^2 + (y + 2)^2 = 4 \Rightarrow (y + 2)^2 = 1$
 $\Rightarrow y + 2 = \pm 1 \Rightarrow y = -1 \text{ or } y = -3.$ Also, $y = 0$
 $\Rightarrow (x + \sqrt{3})^2 + (0 + 2)^2 = 4 \Rightarrow (x + \sqrt{3})^2 = 0$
 $\Rightarrow x = -\sqrt{3}$

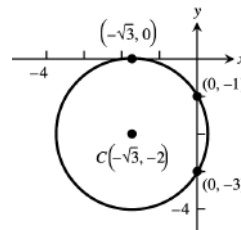

46. $C(3, \frac{1}{2}), a = 5 \Rightarrow (x - 3)^2 + (y - \frac{1}{2})^2 = 25,$ so
 $x = 0 \Rightarrow (0 - 3)^2 + (y - \frac{1}{2})^2 = 25$
 $\Rightarrow (y - \frac{1}{2})^2 = 16 \Rightarrow y - \frac{1}{2} = \pm 4 \Rightarrow y = \frac{9}{2}$
 or $y = -\frac{7}{2}$. Also, $y = 0 \Rightarrow (x - 3)^2 + (0 - \frac{1}{2})^2 = 25$
 $\Rightarrow (x - 3)^2 = \frac{99}{4} \Rightarrow x - 3 = \pm \frac{3\sqrt{11}}{2}$
 $\Rightarrow x = 3 \pm \frac{3\sqrt{11}}{2}$

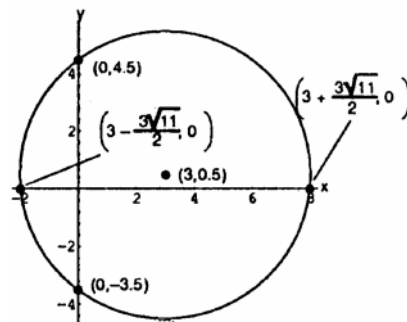

$$\begin{aligned}
 47. \quad & x^2 + y^2 + 4x - 4y + 4 = 0 \\
 & \Rightarrow x^2 + 4x + y^2 - 4y = -4 \\
 & \Rightarrow x^2 + 4x + 4 + y^2 - 4y + 4 = 4 \\
 & \Rightarrow (x + 2)^2 + (y - 2)^2 = 4 \Rightarrow C = (-2, 2), a = 2.
 \end{aligned}$$

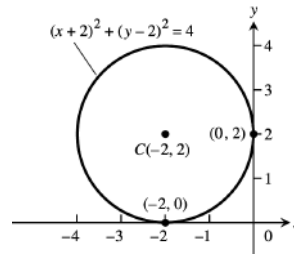

$$\begin{aligned}
 48. \quad & x^2 + y^2 - 8x + 4y + 16 = 0 \\
 & \Rightarrow x^2 - 8x + y^2 + 4y = -16 \\
 & \Rightarrow x^2 - 8x + 16 + y^2 + 4y + 4 = 4 \\
 & \Rightarrow (x - 4)^2 + (y + 2)^2 = 4 \\
 & \Rightarrow C = (4, -2), a = 2.
 \end{aligned}$$

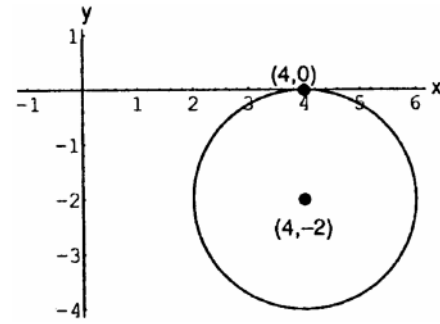

$$\begin{aligned}
 49. \quad & x^2 + y^2 - 3y - 4 = 0 \Rightarrow x^2 + y^2 - 3y = 4 \\
 & \Rightarrow x^2 + y^2 - 3y + \frac{9}{4} = \frac{25}{4} \\
 & \Rightarrow x^2 + (y - \frac{3}{2})^2 = \frac{25}{4} \Rightarrow C = (0, \frac{3}{2}), \\
 & a = \frac{5}{2}.
 \end{aligned}$$

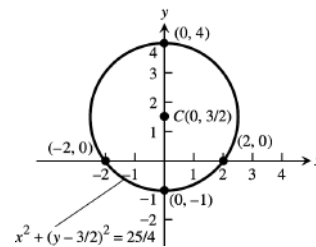

$$\begin{aligned}
 50. \quad & x^2 + y^2 - 4x - \frac{9}{4} = 0 \\
 & \Rightarrow x^2 - 4x + y^2 = \frac{9}{4} \\
 & \Rightarrow x^2 - 4x + 4 + y^2 = \frac{25}{4} \\
 & \Rightarrow (x - 2)^2 + y^2 = \frac{25}{4} \\
 & \Rightarrow C = (2, 0), a = \frac{5}{2}.
 \end{aligned}$$

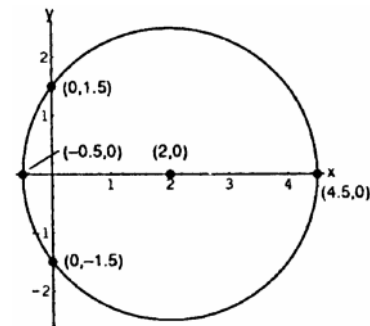

$$\begin{aligned}
 51. \quad & x^2 + y^2 - 4x + 4y = 0 \\
 & \Rightarrow x^2 - 4x + y^2 + 4y = 0 \\
 & \Rightarrow x^2 - 4x + 4 + y^2 + 4y + 4 = 8 \\
 & \Rightarrow (x - 2)^2 + (y + 2)^2 = 8 \\
 & \Rightarrow C(2, -2), a = \sqrt{8}.
 \end{aligned}$$

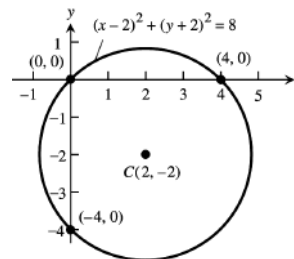

10 Chapter 1 Preliminaries

52. $x^2 + y^2 + 2x = 3$
 $\Rightarrow x^2 + 2x + 1 + y^2 = 4$
 $\Rightarrow (x + 1)^2 + y^2 = 4$
 $\Rightarrow C = (-1, 0), a = 2.$

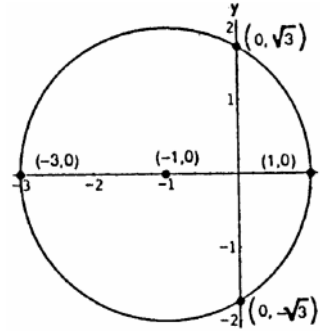

53. $x = -\frac{b}{2a} = -\frac{-2}{2(1)} = 1$
 $\Rightarrow y = (1)^2 - 2(1) - 3 = -4$
 $\Rightarrow V = (1, -4).$ If $x = 0$ then $y = -3$.
 Also, $y = 0 \Rightarrow x^2 - 2x - 3 = 0$
 $\Rightarrow (x - 3)(x + 1) = 0 \Rightarrow x = 3$ or $x = -1$. Axis of parabola is $x = 1$.

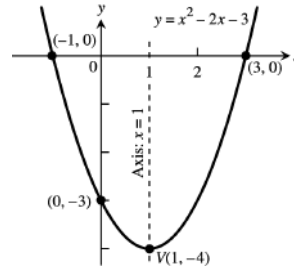

54. $x = -\frac{b}{2a} = -\frac{4}{2(1)} = -2$
 $\Rightarrow y = (-2)^2 + 4(-2) + 3 = -1$
 $\Rightarrow V = (-2, -1).$ If $x = 0$ then $y = 3$.
 Also, $y = 0 \Rightarrow x^2 + 4x + 3 = 0$
 $\Rightarrow (x + 1)(x + 3) = 0 \Rightarrow x = -1$ or $x = -3$. Axis of parabola is $x = -2$.

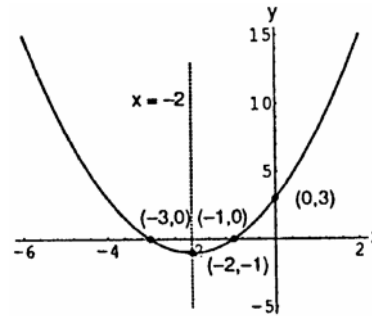

55. $x = -\frac{b}{2a} = -\frac{4}{2(-1)} = 2$
 $\Rightarrow y = -(2)^2 + 4(2) = 4$
 $\Rightarrow V = (2, 4).$ If $x = 0$ then $y = 0$.
 Also, $y = 0 \Rightarrow -x^2 + 4x = 0$
 $\Rightarrow -x(x - 4) = 0 \Rightarrow x = 4$ or $x = 0$.
 Axis of parabola is $x = 2$.

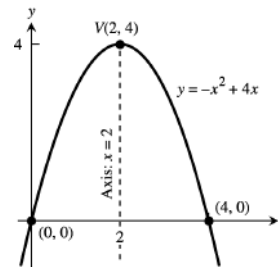

56. $x = -\frac{b}{2a} = -\frac{4}{2(-1)} = 2$
 $\Rightarrow y = -(2)^2 + 4(2) - 5 = -1$
 $\Rightarrow V = (2, -1).$ If $x = 0$ then $y = -5$.
 Also, $y = 0 \Rightarrow -x^2 + 4x - 5 = 0$
 $\Rightarrow x^2 - 4x + 5 = 0 \Rightarrow x = \frac{4 \pm \sqrt{-4}}{2}$
 \Rightarrow no x intercepts. Axis of parabola is $x = 2$.

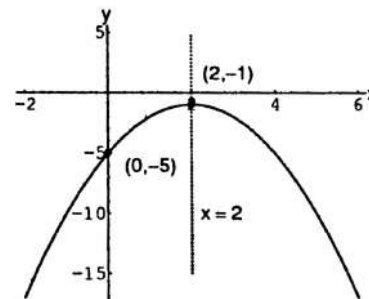

57. $x = -\frac{b}{2a} = -\frac{-6}{2(-1)} = -3$
 $\Rightarrow y = -(-3)^2 - 6(-3) - 5 = 4$
 $\Rightarrow V = (-3, 4)$. If $x = 0$ then $y = -5$.
 Also, $y = 0 \Rightarrow -x^2 - 6x - 5 = 0$
 $\Rightarrow (x + 5)(x + 1) = 0 \Rightarrow x = -5$ or
 $x = -1$. Axis of parabola is $x = -3$.

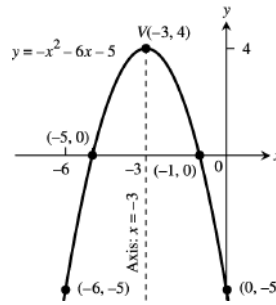

58. $x = -\frac{b}{2a} = -\frac{-1}{2(2)} = \frac{1}{4}$
 $\Rightarrow y = 2\left(\frac{1}{4}\right)^2 - \frac{1}{4} + 3 = \frac{23}{8}$
 $\Rightarrow V = \left(\frac{1}{4}, \frac{23}{8}\right)$. If $x = 0$ then $y = 3$.
 Also, $y = 0 \Rightarrow 2x^2 - x + 3 = 0$
 $\Rightarrow x = \frac{1 \pm \sqrt{-23}}{4} \Rightarrow$ no x intercepts.
 Axis of parabola is $x = \frac{1}{4}$.

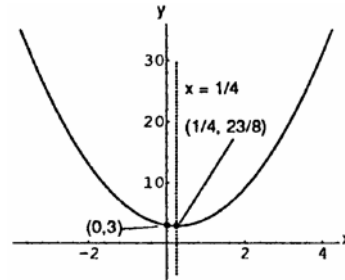

59. $x = -\frac{b}{2a} = -\frac{1}{2(1/2)} = -1$
 $\Rightarrow y = \frac{1}{2}(-1)^2 + (-1) + 4 = \frac{7}{2}$
 $\Rightarrow V = \left(-1, \frac{7}{2}\right)$. If $x = 0$ then $y = 4$.
 Also, $y = 0 \Rightarrow \frac{1}{2}x^2 + x + 4 = 0$
 $\Rightarrow x = \frac{-1 \pm \sqrt{-7}}{1} \Rightarrow$ no x intercepts.
 Axis of parabola is $x = -1$.

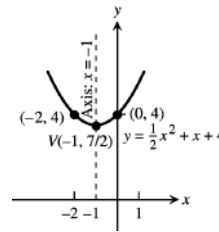

60. $x = -\frac{b}{2a} = -\frac{2}{2(-1/4)} = 4$
 $\Rightarrow y = -\frac{1}{4}(4)^2 + 2(4) + 4 = 8$
 $\Rightarrow V = (4, 8)$. If $x = 0$ then $y = 4$.
 Also, $y = 0 \Rightarrow -\frac{1}{4}x^2 + 2x + 4 = 0$
 $\Rightarrow x = \frac{-2 \pm \sqrt{8}}{-1/2} = 4 \pm 4\sqrt{2}$.
 Axis of parabola is $x = 4$.

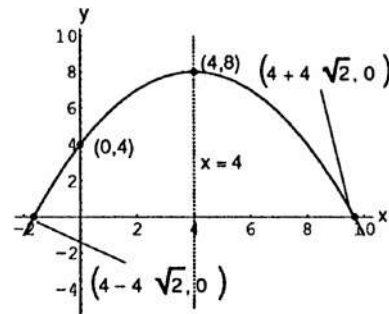

61. The points that lie outside the circle with center $(0, 0)$ and radius $\sqrt{7}$.
62. The points that lie inside the circle with center $(0, 0)$ and radius $\sqrt{5}$.
63. The points that lie on or inside the circle with center $(1, 0)$ and radius 2.
64. The points lying on or outside the circle with center $(0, 2)$ and radius 2.
65. The points lying outside the circle with center $(0, 0)$ and radius 1, but inside the circle with center $(0, 0)$, and radius 2 (i.e., a washer).

12 Chapter 1 Preliminaries

66. The points on or inside the circle centered at $(0, 0)$ with radius 2 and on or inside the circle centered at $(-2, 0)$ with radius 2.

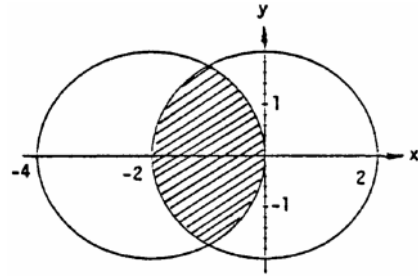

67. $x^2 + y^2 + 6y < 0 \Rightarrow x^2 + (y + 3)^2 < 9$.
The interior points of the circle centered at $(0, -3)$ with radius 3, but above the line $y = -3$.

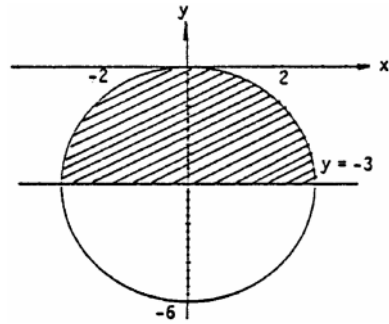

68. $x^2 + y^2 - 4x + 2y > 4 \Rightarrow (x - 2)^2 + (y + 1)^2 > 9$.
The points exterior to the circle centered at $(2, -1)$ with radius 3 and to the right of the line $x = 2$.

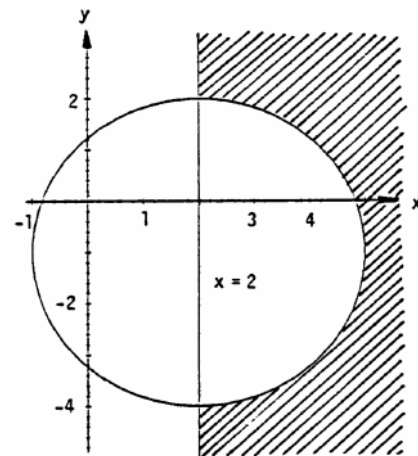

69. $(x + 2)^2 + (y - 1)^2 < 6$

70. $(x + 4)^2 + (y - 2)^2 > 16$

71. $x^2 + y^2 \leq 2, x \geq 1$

72. $x^2 + y^2 > 4, (x - 1)^2 + (y - 3)^2 < 10$

73. $x^2 + y^2 = 1$ and $y = 2x \Rightarrow 1 = x^2 + 4x^2 = 5x^2$
 $\Rightarrow \left(x = \frac{1}{\sqrt{5}} \text{ and } y = \frac{2}{\sqrt{5}}\right)$ or $\left(x = -\frac{1}{\sqrt{5}} \text{ and } y = -\frac{2}{\sqrt{5}}\right)$.

Thus, $A\left(\frac{1}{\sqrt{5}}, \frac{2}{\sqrt{5}}\right)$, $B\left(-\frac{1}{\sqrt{5}}, -\frac{2}{\sqrt{5}}\right)$ are the points of intersection.

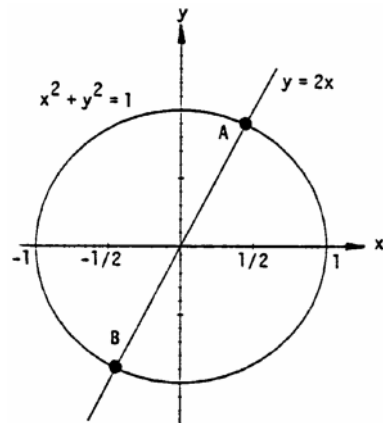

74. $x + y = 1$ and $(x - 1)^2 + y^2 = 1$
 $\Rightarrow 1 = (-y)^2 + y^2 = 2y^2$
 $\Rightarrow \left(y = \frac{1}{\sqrt{2}} \text{ and } x = 1 - \frac{1}{\sqrt{2}}\right)$ or
 $\left(y = -\frac{1}{\sqrt{2}} \text{ and } x = 1 + \frac{1}{\sqrt{2}}\right)$. Thus,
 A $\left(1 - \frac{1}{\sqrt{2}}, \frac{1}{\sqrt{2}}\right)$ and B $\left(1 + \frac{1}{\sqrt{2}}, -\frac{1}{\sqrt{2}}\right)$
 are intersection points.

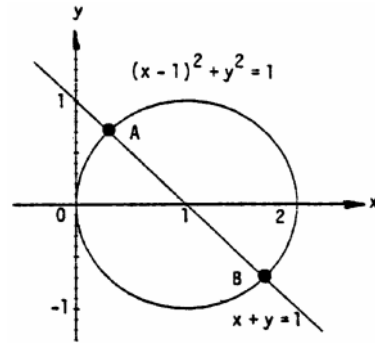

75. $y - x = 1$ and $y = x^2 \Rightarrow x^2 - x = 1$
 $\Rightarrow x^2 - x - 1 = 0 \Rightarrow x = \frac{1 \pm \sqrt{5}}{2}$.
 If $x = \frac{1 + \sqrt{5}}{2}$, then $y = x + 1 = \frac{3 + \sqrt{5}}{2}$.
 If $x = \frac{1 - \sqrt{5}}{2}$, then $y = x + 1 = \frac{3 - \sqrt{5}}{2}$.
 Thus, A $\left(\frac{1 + \sqrt{5}}{2}, \frac{3 + \sqrt{5}}{2}\right)$ and B $\left(\frac{1 - \sqrt{5}}{2}, \frac{3 - \sqrt{5}}{2}\right)$
 are the intersection points.

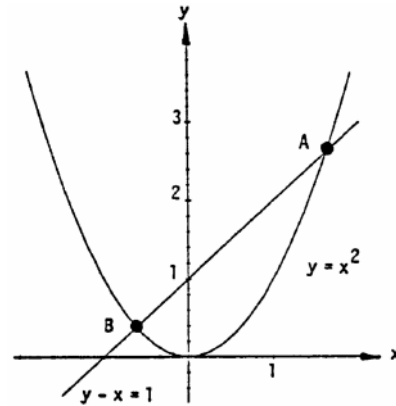

76. $y = -x$ and $y = -(x - 1)^2 \Rightarrow (x - 1)^2 = x$
 $\Rightarrow x^2 - 3x + 1 = 0 \Rightarrow x = \frac{3 \pm \sqrt{5}}{2}$. If
 $x = \frac{3 - \sqrt{5}}{2}$, then $y = -x = \frac{\sqrt{5} - 3}{2}$. If
 $x = \frac{3 + \sqrt{5}}{2}$, then $y = -x = -\frac{3 + \sqrt{5}}{2}$.
 Thus, A $\left(\frac{3 - \sqrt{5}}{2}, \frac{\sqrt{5} - 3}{2}\right)$ and B $\left(\frac{3 + \sqrt{5}}{2}, -\frac{3 + \sqrt{5}}{2}\right)$
 are the intersection points.

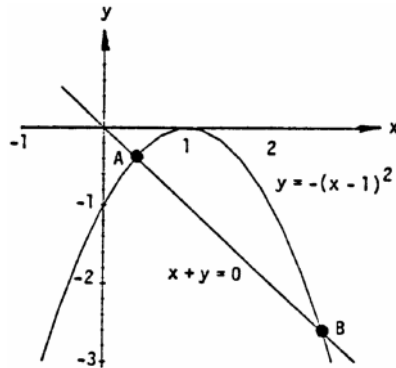

77. $y = 2x^2 - 1 = -x^2 \Rightarrow 3x^2 = 1$
 $\Rightarrow x = \frac{1}{\sqrt{3}}$ and $y = -\frac{1}{3}$ or $x = -\frac{1}{\sqrt{3}}$ and $y = -\frac{1}{3}$.
 Thus, A $\left(\frac{1}{\sqrt{3}}, -\frac{1}{3}\right)$ and B $\left(-\frac{1}{\sqrt{3}}, -\frac{1}{3}\right)$ are the
 intersection points.

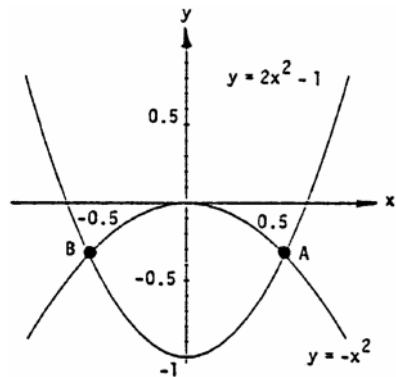

14 Chapter 1 Preliminaries

78. $y = \frac{x^2}{4} = (x-1)^2 \Rightarrow 0 = \frac{3x^2}{4} - 2x + 1$
 $\Rightarrow 0 = 3x^2 - 8x + 4 = (3x-2)(x-2)$
 $\Rightarrow x = 2$ and $y = \frac{x^2}{4} = 1$, or $x = \frac{2}{3}$ and
 $y = \frac{x^2}{4} = \frac{1}{9}$. Thus, A(2, 1) and B($\frac{2}{3}, \frac{1}{9}$)
 are the intersection points.

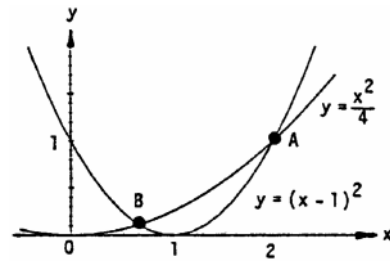

79. $x^2 + y^2 = 1 = (x-1)^2 + y^2$
 $\Rightarrow x^2 = (x-1)^2 = x^2 - 2x + 1$
 $\Rightarrow 0 = -2x + 1 \Rightarrow x = \frac{1}{2}$. Hence
 $y^2 = 1 - x^2 = \frac{3}{4}$ or $y = \pm \frac{\sqrt{3}}{2}$. Thus,
 A($\frac{1}{2}, \frac{\sqrt{3}}{2}$) and B($\frac{1}{2}, -\frac{\sqrt{3}}{2}$) are the
 intersection points.

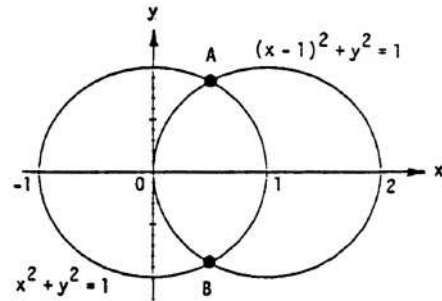

80. $x^2 + y^2 = 1 = x^2 + y \Rightarrow y^2 = y$
 $\Rightarrow y(y-1) = 0 \Rightarrow y = 0$ or $y = 1$.
 If $y = 1$, then $x^2 = 1 - y^2 = 0$ or $x = 0$.
 If $y = 0$, then $x^2 = 1 - y^2 = 1$ or $x = \pm 1$.
 Thus, A(0, 1), B(1, 0), and C(-1, 0) are the
 intersection points.

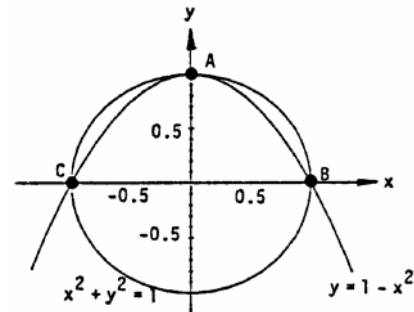

81. (a) A $\approx (69^\circ, 0 \text{ in})$, B $\approx (68^\circ, .4 \text{ in}) \Rightarrow m = \frac{68^\circ - 69^\circ}{.4 - 0} \approx -2.5^\circ/\text{in}$.
 (b) A $\approx (68^\circ, .4 \text{ in})$, B $\approx (10^\circ, 4 \text{ in}) \Rightarrow m = \frac{10^\circ - 68^\circ}{4 - .4} \approx -16.1^\circ/\text{in}$.
 (c) A $\approx (10^\circ, 4 \text{ in})$, B $\approx (5^\circ, 4.6 \text{ in}) \Rightarrow m = \frac{5^\circ - 10^\circ}{4.6 - 4} \approx -8.3^\circ/\text{in}$.

82. The time rate of heat transfer across a material, $\frac{\Delta Q}{\Delta t}$, is directly proportional to the cross-sectional area, A, of the material, to the temperature gradient across the material, $\frac{\Delta T}{\Delta x}$ (the slopes from the previous problem), and to a constant characteristic of the material. $\frac{\Delta Q}{\Delta t} = -kA \frac{\Delta T}{\Delta x} \Rightarrow k = -\frac{\Delta Q / A}{\Delta T / \Delta x}$. Note that $\frac{\Delta Q}{\Delta t}$ and $\frac{\Delta T}{\Delta x}$ are of opposite sign because heat flow is toward lower temperature. So a small value of k corresponds to low heat flow through the material and thus the material is a good insulator. Since all three materials have the same cross section and the heat flow across each is the same (temperatures are not changing), we may define another constant, K, characteristics of the material: $K = -\frac{1}{\Delta T}$. Using the values of $\frac{\Delta T}{\Delta x}$ from the previous problem, fiberglass has the smallest K at 0.06 and thus is the best insulator. Likewise, the wallboard is the poorest insulator, with K = 0.4.

83. $p = kd + 1$ and $p = 10.94$ at $d = 100 \Rightarrow k = \frac{10.94 - 1}{100} = 0.0994$. Then $p = 0.0994d + 1$ is the diver's pressure equation so that $d = 50 \Rightarrow p = (0.0994)(50) + 1 = 5.97$ atmospheres.

84. The line of incidence passes through (0, 1) and (1, 0) \Rightarrow The line of reflection passes through (1, 0) and (2, 1)
 $\Rightarrow m = \frac{1-0}{2-1} = 1 \Rightarrow y - 0 = 1(x - 1) \Rightarrow y = x - 1$ is the line of reflection.

85. $C = \frac{5}{9}(F - 32)$ and $C = F \Rightarrow F = \frac{5}{9}F - \frac{160}{9} \Rightarrow \frac{4}{9}F = -\frac{160}{9}$ or $F = -40^\circ$ gives the same numerical reading.

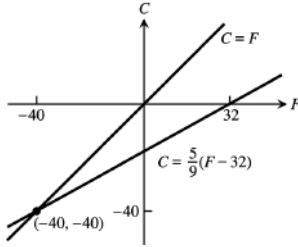

86. $m = \frac{37.1}{100} = \frac{14}{\Delta x} \Rightarrow \Delta x = \frac{14}{.371}$. Therefore, distance between first and last rows is $\sqrt{(14)^2 + \left(\frac{14}{.371}\right)^2} \approx 40.25$ ft.

87. length $AB = \sqrt{(5-1)^2 + (5-2)^2} = \sqrt{16+9} = 5$
 length $AC = \sqrt{(4-1)^2 + (-2-2)^2} = \sqrt{9+16} = 5$
 length $BC = \sqrt{(4-5)^2 + (-2-5)^2} = \sqrt{1+49} = \sqrt{50} = 5\sqrt{2} \neq 5$

88. length $AB = \sqrt{(1-0)^2 + (\sqrt{3}-0)^2} = \sqrt{1+3} = 2$
 length $AC = \sqrt{(2-0)^2 + (0-0)^2} = \sqrt{4+0} = 2$
 length $BC = \sqrt{(2-1)^2 + (0-\sqrt{3})^2} = \sqrt{1+3} = 2$

89. Length $AB = \sqrt{(\Delta x)^2 + (\Delta y)^2} = \sqrt{1^2 + 4^2} = \sqrt{17}$ and length $BC = \sqrt{(\Delta x)^2 + (\Delta y)^2} = \sqrt{4^2 + 1^2} = \sqrt{17}$.
 Also, slope $AB = \frac{4}{1}$ and slope $BC = \frac{1}{4}$, so $AB \perp BC$. Thus, the points are vertices of a square. The coordinate increments from the fourth vertex $D(x, y)$ to A must equal the increments from C to $B \Rightarrow 2 - x = \Delta x = 4$ and $-1 - y = \Delta y = 1 \Rightarrow x = -2$ and $y = -2$. Thus $D(-2, -2)$ is the fourth vertex.

90. Let $A = (x, 2)$ and $C = (9, y) \Rightarrow B = (x, y)$. Then $9 - x = |AD|$ and $2 - y = |DC| \Rightarrow 2(9 - x) + 2(2 - y) = 56$ and $9 - x = 3(2 - y) \Rightarrow 2(3(2 - y)) + 2(2 - y) = 56 \Rightarrow y = -5 \Rightarrow 9 - x = 3(2 - (-5)) \Rightarrow x = -12$.
 Therefore, $A = (-12, 2)$, $C = (9, -5)$, and $B = (-12, -5)$.

91. Let $A(-1, 1)$, $B(2, 3)$, and $C(2, 0)$ denote the points.
 Since BC is vertical and has length $|BC| = 3$, let $D_1(-1, 4)$ be located vertically upward from A and $D_2(-1, -2)$ be located vertically downward from A so that $|BC| = |AD_1| = |AD_2| = 3$. Denote the point $D_3(x, y)$. Since the slope of AB equals the slope of CD_3 we have $\frac{y-3}{x-2} = -\frac{1}{3} \Rightarrow 3y - 9 = -x + 2$ or $x + 3y = 11$. Likewise, the slope of AC equals the slope of BD_3 so that $\frac{y-0}{x-2} = \frac{2}{3} \Rightarrow 3y = 2x - 4$ or $2x - 3y = 4$.

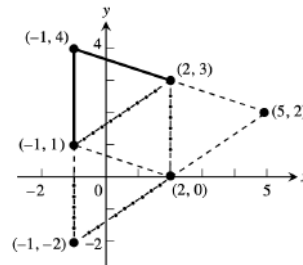

Solving the system of equations $\left. \begin{array}{l} x + 3y = 11 \\ 2x - 3y = 4 \end{array} \right\}$ we find $x = 5$ and $y = 2$ yielding the vertex $D_3(5, 2)$.

92. Let (x, y) , $x \neq 0$ and/or $y \neq 0$ be a point on the coordinate plane. The slope, m , of the segment $(0, 0)$ to (x, y) is $\frac{y}{x}$. A 90° rotation gives a segment with slope $m' = -\frac{1}{m} = -\frac{x}{y}$. If this segment has length equal to the original segment, its endpoint will be $(-y, x)$ or $(y, -x)$, the first of these corresponds to a counter-clockwise rotation, the latter to a clockwise rotation.

- (a) $(-1, 4)$; (b) $(3, -2)$; (c) $(5, 2)$; (d) $(0, x)$;

- (e) $(-y, 0)$; (f) $(-y, x)$; (g) $(3, -10)$

93. $2x + ky = 3$ has slope $-\frac{2}{k}$ and $4x + y = 1$ has slope -4 . The lines are perpendicular when $-\frac{2}{k}(-4) = -1$ or $k = -8$ and parallel when $-\frac{2}{k} = -4$ or $k = \frac{1}{2}$.
94. At the point of intersection, $2x + 4y = 6$ and $2x - 3y = -1$. Subtracting these equations we find $7y = 7$ or $y = 1$. Substitution into either equation gives $x = 1 \Rightarrow (1, 1)$ is the intersection point. The line through $(1, 1)$ and $(1, 2)$ is vertical with equation $x = 1$.

95. Let $M(a, b)$ be the midpoint. Since the two triangles shown in the figure are congruent, the value a must lie midway between x_1 and x_2 , so $a = \frac{x_1 + x_2}{2}$.

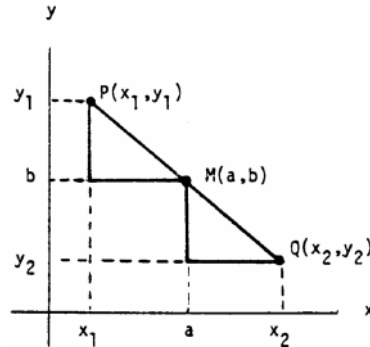

Similarly, $b = \frac{y_1 + y_2}{2}$.

96. (a) L has slope 1 so M is the line through $P(2, 1)$ with slope -1 ; or the line $y = -x + 3$. At the intersection point, Q, we have equal y-values, $y = x + 2 = -x + 3$. Thus, $2x = 1$ or $x = \frac{1}{2}$. Hence Q has coordinates $(\frac{1}{2}, \frac{5}{2})$. The distance from P to L = the distance from P to Q = $\sqrt{(\frac{3}{2})^2 + (-\frac{3}{2})^2} = \sqrt{\frac{18}{4}} = \frac{3\sqrt{2}}{2}$.
- (b) L has slope $-\frac{4}{3}$ so M has slope $\frac{3}{4}$ and M has the equation $4y - 3x = 12$. We can rewrite the equations of the lines as L: $x + \frac{3}{4}y = 3$ and M: $-x + \frac{4}{3}y = 4$. Adding these we get $\frac{25}{12}y = 7$ so $y = \frac{84}{25}$. Substitution into either equation gives $x = \frac{4}{3}(\frac{84}{25}) - 4 = \frac{12}{25}$ so that $Q(\frac{12}{25}, \frac{84}{25})$ is the point of intersection. The distance from P to L = $\sqrt{(4 - \frac{12}{25})^2 + (6 - \frac{84}{25})^2} = \frac{22}{5}$.
- (c) M is a horizontal line with equation $y = b$. The intersection point of L and M is $Q(-1, b)$. Thus, the distance from P to L is $\sqrt{(a + 1)^2 + 0^2} = |a + 1|$.
- (d) If $B = 0$ and $A \neq 0$, then the distance from P to L is $|\frac{C}{A} - x_0|$ as in (c). Similarly, if $A = 0$ and $B \neq 0$, the distance is $|\frac{C}{B} - y_0|$. If both A and B are $\neq 0$ then L has slope $-\frac{A}{B}$ so M has slope $\frac{B}{A}$. Thus, L: $Ax + By = C$ and M: $-Bx + Ay = -Bx_0 + Ay_0$. Solving these equations simultaneously we find the point of intersection $Q(x, y)$ with $x = \frac{AC - B(Ay_0 - Bx_0)}{A^2 + B^2}$ and $y = \frac{BC + A(Ay_0 - Bx_0)}{A^2 + B^2}$. The distance from P to Q equals $\sqrt{(\Delta x)^2 + (\Delta y)^2}$, where $(\Delta x)^2 = \left(\frac{x_0(A^2 + B^2) - AC + AB y_0 - B^2 x_0}{A^2 + B^2}\right)^2$
 $= \frac{A^2(Ax_0 + By_0 + C)^2}{(A^2 + B^2)^2}$, and $(\Delta y)^2 = \left(\frac{y_0(A^2 + B^2) - BC - A^2 y_0 + AB x_0}{A^2 + B^2}\right)^2 = \frac{B^2(Ax_0 + By_0 + C)^2}{(A^2 + B^2)^2}$.
 Thus, $\sqrt{(\Delta x)^2 + (\Delta y)^2} = \sqrt{\frac{(Ax_0 + By_0 + C)^2}{A^2 + B^2}} = \frac{|Ax_0 + By_0 + C|}{\sqrt{A^2 + B^2}}$.

1.3 FUNCTIONS AND THEIR GRAPHS

- domain = $(-\infty, \infty)$; range = $[1, \infty)$
- domain = $[0, \infty)$; range = $(-\infty, 1]$
- domain = $(0, \infty)$; y in range $\Rightarrow y = \frac{1}{\sqrt{t}}, t > 0 \Rightarrow y^2 = \frac{1}{t}$ and $y > 0 \Rightarrow y$ can be any positive real number \Rightarrow range = $(0, \infty)$.

4. domain = $[0, \infty)$; y in range $\Rightarrow y = \frac{1}{1+\sqrt{t}}$, $t > 0$. If $t = 0$, then $y = 1$ and as t increases, y becomes a smaller and smaller positive real number \Rightarrow range = $(0, 1]$.
5. $4 - z^2 = (2 - z)(2 + z) \geq 0 \Leftrightarrow z \in [-2, 2] =$ domain. Largest value is $g(0) = \sqrt{4} = 2$ and smallest value is $g(-2) = g(2) = \sqrt{0} = 0 \Rightarrow$ range = $[0, 2]$.
6. domain = $(-2, 2)$ from Exercise 5; smallest value is $g(0) = \frac{1}{2}$ and as $0 < z$ increases to 2, $g(z)$ gets larger and larger (also true as $z < 0$ decreases to -2) \Rightarrow range = $[\frac{1}{2}, \infty)$.
7. (a) Not the graph of a function of x since it fails the vertical line test.
(b) Is the graph of a function of x since any vertical line intersects the graph at most once.
8. (a) Not the graph of a function of x since it fails the vertical line test.
(b) Not the graph of a function of x since it fails the vertical line test.
9. $y = \sqrt{\frac{1}{x}} - 1 \Rightarrow \frac{1}{x} - 1 \geq 0 \Rightarrow x \leq 1$ and $x > 0$. So,
(a) No ($x > 0$); (b) No; division by 0 undefined;
(c) No; if $x \geq 1$, $\frac{1}{x} < 1 \Rightarrow \frac{1}{x} - 1 < 0$; (d) $(0, 1]$
10. $y = \sqrt{2 - \sqrt{x}} \Rightarrow 2 - \sqrt{x} \geq 0 \Rightarrow \sqrt{x} \geq 0$ and $\sqrt{x} \leq 2$. $\sqrt{x} \geq 0 \Rightarrow x \geq 0$ and $\sqrt{x} \leq 2 \Rightarrow x \leq 4$. So, $0 \leq x \leq 4$.
(a) No; (b) No; (c) $[0, 4]$
11. base = x ; $(\text{height})^2 + (\frac{x}{2})^2 = x^2 \Rightarrow \text{height} = \frac{\sqrt{3}}{2}x$; area is $a(x) = \frac{1}{2}(\text{base})(\text{height}) = \frac{1}{2}(x)\left(\frac{\sqrt{3}}{2}x\right) = \frac{\sqrt{3}}{4}x^2$;
perimeter is $p(x) = x + x + x = 3x$.
12. $s =$ side length $\Rightarrow s^2 + s^2 = d^2 \Rightarrow s = \frac{d}{\sqrt{2}}$; and area is $a = s^2 \Rightarrow a = \frac{1}{2}d^2$
13. Let $D =$ diagonal of a face of the cube and $\ell =$ the length of an edge. Then $\ell^2 + D^2 = d^2$ and (by Exercise 10)
 $D^2 = 2\ell^2 \Rightarrow 3\ell^2 = d^2 \Rightarrow \ell = \frac{d}{\sqrt{3}}$. The surface area is $6\ell^2 = \frac{6d^2}{3} = 2d^2$ and the volume is $\ell^3 = \left(\frac{d}{\sqrt{3}}\right)^3 = \frac{d^3}{3\sqrt{3}}$.
14. The coordinates of P are (x, \sqrt{x}) so the slope of the line joining P to the origin is $m = \frac{\sqrt{x}}{x} = \frac{1}{\sqrt{x}}$ ($x > 0$). Thus,
 $(x, \sqrt{x}) = \left(\frac{1}{m^2}, \frac{1}{m}\right)$.
15. The domain is $(-\infty, \infty)$.
16. The domain is $(-\infty, \infty)$.

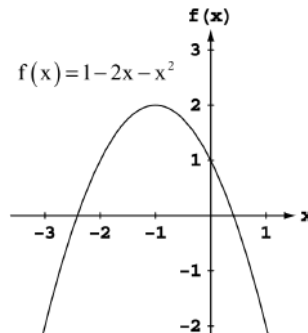
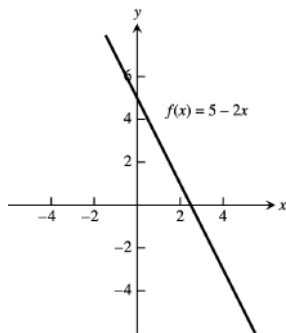

17. The domain is $(-\infty, \infty)$.

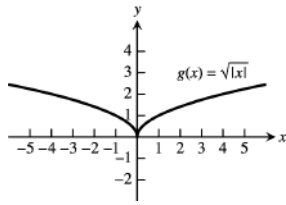

18. The domain is $(-\infty, 0]$.

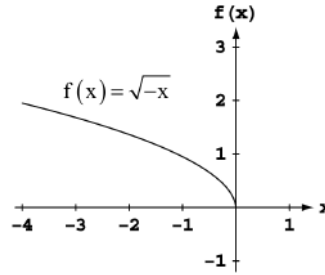

19. The domain is $(-\infty, 0) \cup (0, \infty)$.

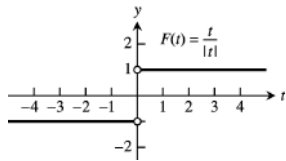

20. The domain is $(-\infty, 0) \cup (0, \infty)$.

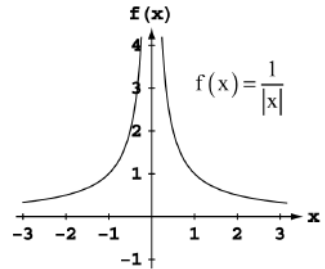

21. Neither graph passes the vertical line test

(a)

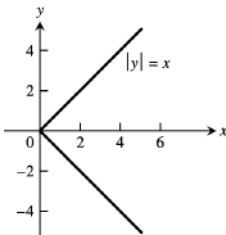

(b)

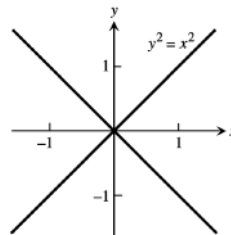

22. Neither graph passes the vertical line test

(a)

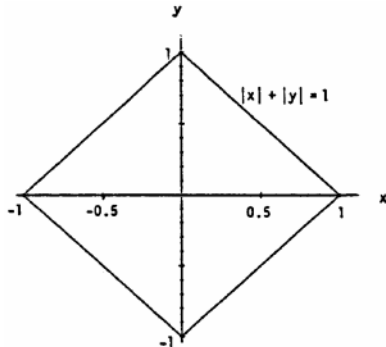

(b)

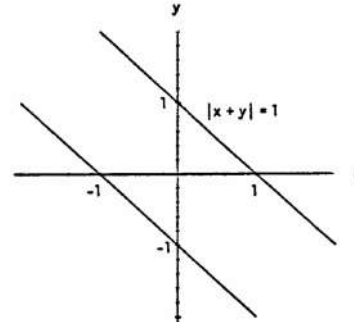

$$|x + y| = 1 \Leftrightarrow \left\{ \begin{array}{l} x + y = 1 \\ \text{or} \\ x + y = -1 \end{array} \right\} \Leftrightarrow \left\{ \begin{array}{l} y = 1 - x \\ \text{or} \\ y = -1 - x \end{array} \right\}$$

x	0	1	2
y	0	1	0

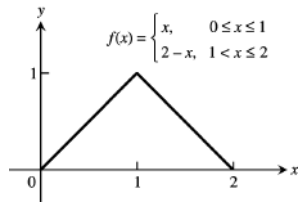

x	0	1	2
y	1	0	0

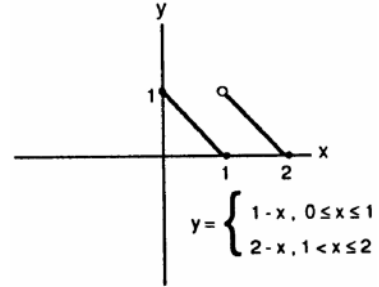

$$25. y = \begin{cases} 3 - x, & x \leq 1 \\ 2x, & 1 < x \end{cases}$$

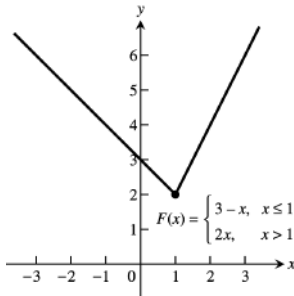

$$26. y = \begin{cases} \frac{1}{x}, & x < 0 \\ x, & 0 \leq x \end{cases}$$

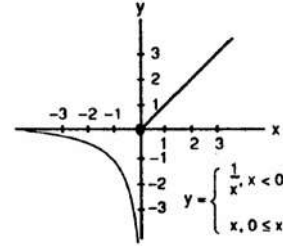

27. (a) Line through (0, 0) and (1, 1): $y = x$
Line through (1, 1) and (2, 0): $y = -x + 2$

$$f(x) = \begin{cases} x, & 0 \leq x \leq 1 \\ -x + 2, & 1 < x \leq 2 \end{cases}$$

(b) $f(x) = \begin{cases} 2, & 0 \leq x < 1 \\ 0, & 1 \leq x < 2 \\ 2, & 2 \leq x < 3 \\ 0, & 3 \leq x \leq 4 \end{cases}$

28. (a) Line through (0, 2) and (2, 0): $y = -x + 2$

Line through (2, 1) and (5, 0): $m = \frac{0-1}{5-2} = \frac{-1}{3} = -\frac{1}{3}$, so $y = -\frac{1}{3}(x - 2) + 1 = -\frac{1}{3}x + \frac{5}{3}$

$$f(x) = \begin{cases} -x + 2, & 0 < x \leq 2 \\ -\frac{1}{3}x + \frac{5}{3}, & 2 < x \leq 5 \end{cases}$$

- (b) Line through (-1, 0) and (0, -3): $m = \frac{-3-0}{0-(-1)} = -3$, so $y = -3x - 3$

Line through (0, 3) and (2, -1): $m = \frac{-1-3}{2-0} = \frac{-4}{2} = -2$, so $y = -2x + 3$

$$f(x) = \begin{cases} -3x - 3, & -1 < x \leq 0 \\ -2x + 3, & 0 < x \leq 2 \end{cases}$$

29. (a) Line through (-1, 1) and (0, 0): $y = -x$

Line through (0, 1) and (1, 1): $y = 1$

Line through (1, 1) and (3, 0): $m = \frac{0-1}{3-1} = \frac{-1}{2} = -\frac{1}{2}$, so $y = -\frac{1}{2}(x - 1) + 1 = -\frac{1}{2}x + \frac{3}{2}$

$$f(x) = \begin{cases} -x & -1 \leq x < 0 \\ 1 & 0 < x \leq 1 \\ -\frac{1}{2}x + \frac{3}{2} & 1 < x < 3 \end{cases}$$

- (b) Line through (-2, -1) and (0, 0): $y = \frac{1}{2}x$

Line through (0, 2) and (1, 0): $y = -2x + 2$

Line through (1, -1) and (3, -1): $y = -1$

$$f(x) = \begin{cases} \frac{1}{2}x & -2 \leq x \leq 0 \\ -2x + 2 & 0 < x \leq 1 \\ -1 & 1 < x \leq 3 \end{cases}$$

30. (a) Line through $(\frac{T}{2}, 0)$ and $(T, 1)$: $m = \frac{1-0}{T-(T/2)} = \frac{2}{T}$, so $y = \frac{2}{T}(x - \frac{T}{2}) + 0 = \frac{2}{T}x - 1$

$$f(x) = \begin{cases} 0, & 0 \leq x \leq \frac{T}{2} \\ \frac{2}{T}x - 1, & \frac{T}{2} < x \leq T \end{cases}$$

$$(b) f(x) = \begin{cases} A, & 0 \leq x < \frac{T}{2} \\ -A, & \frac{T}{2} \leq x < T \\ A, & T \leq x < \frac{3T}{2} \\ -A, & \frac{3T}{2} \leq x \leq 2T \end{cases}$$

31. (a) From the graph, $\frac{x}{2} > 1 + \frac{4}{x} \Rightarrow x \in (-2, 0) \cup (4, \infty)$

(b) $\frac{x}{2} > 1 + \frac{4}{x} \Rightarrow \frac{x}{2} - 1 - \frac{4}{x} > 0$

$x > 0$: $\frac{x}{2} - 1 - \frac{4}{x} > 0 \Rightarrow \frac{x^2 - 2x - 8}{2x} > 0 \Rightarrow \frac{(x-4)(x+2)}{2x} > 0$
 $\Rightarrow x > 4$ since x is positive;

$x < 0$: $\frac{x}{2} - 1 - \frac{4}{x} > 0 \Rightarrow \frac{x^2 - 2x - 8}{2x} < 0 \Rightarrow \frac{(x-4)(x+2)}{2x} < 0$
 $\Rightarrow x < -2$ since x is negative;

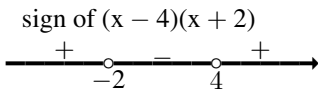

Solution interval: $(-2, 0) \cup (4, \infty)$

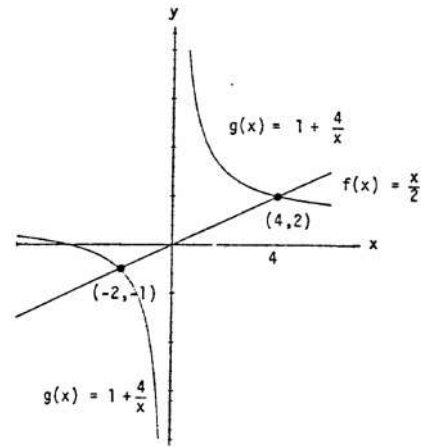

32. (a) From the graph, $\frac{3}{x-1} < \frac{2}{x+1} \Rightarrow x \in (-\infty, -5) \cup (-1, 1)$

(b) Case $x < -1$: $\frac{3}{x-1} < \frac{2}{x+1} \Rightarrow \frac{3(x+1)}{x-1} > 2$
 $\Rightarrow 3x + 3 < 2x - 2 \Rightarrow x < -5$.

Thus, $x \in (-\infty, -5)$ solves the inequality.

Case $-1 < x < 1$: $\frac{3}{x-1} < \frac{2}{x+1} \Rightarrow \frac{3(x+1)}{x-1} < 2$
 $\Rightarrow 3x + 3 > 2x - 2 \Rightarrow x > -5$ which is true
 if $x > -1$. Thus, $x \in (-1, 1)$ solves the
 inequality.

Case $1 < x$: $\frac{3}{x-1} < \frac{2}{x+1} \Rightarrow 3x + 3 < 2x - 2 \Rightarrow x < -5$
 which is never true if $1 < x$, so no solution
 here.

In conclusion, $x \in (-\infty, -5) \cup (-1, 1)$.

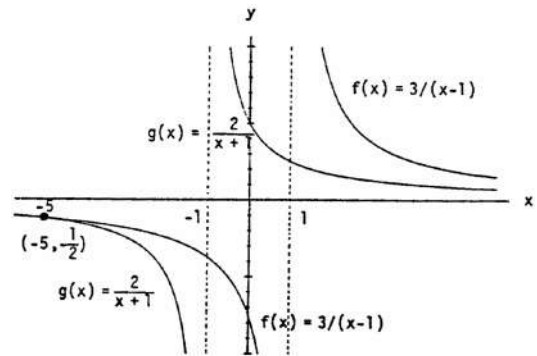

33. (a) $\lfloor x \rfloor = 0$ for $x \in [0, 1)$

(b) $\lceil x \rceil = 0$ for $x \in (-1, 0]$

34. $\lfloor x \rfloor = \lceil x \rceil$ only when x is an integer.

35. For any real number x , $n \leq x \leq n + 1$, where n is an integer. Now: $n \leq x \leq n + 1 \Rightarrow -(n + 1) \leq -x \leq -n$. By definition: $\lceil -x \rceil = -n$ and $\lfloor x \rfloor = n \Rightarrow -\lfloor x \rfloor = -n$. So $\lceil -x \rceil = -\lfloor x \rfloor$ for all $x \in \mathbb{R}$.

36. To find $f(x)$ you delete the decimal or fractional portion of x , leaving only the integer part.

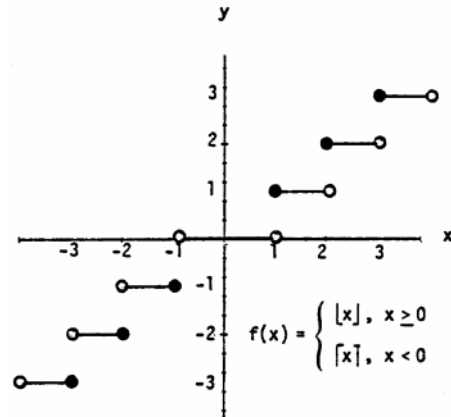

37. $v = f(x) = x(14 - 2x)(22 - 2x) = 4x^3 - 72x^2 + 308x; 0 < x < 7.$

38. (a) Let h = height of the triangle. Since the triangle is isosceles, $\overline{AB}^2 + \overline{AB}^2 = 2^2 \Rightarrow \overline{AB} = \sqrt{2}$. So,

$$h^2 + 1^2 = (\sqrt{2})^2 \Rightarrow h = 1 \Rightarrow B \text{ is at } (0, 1) \Rightarrow \text{slope of } AB = -1 \Rightarrow \text{The equation of } AB \text{ is}$$

$$y = f(x) = -x + 1; x \in [0, 1].$$

(b) $A(x) = 2xy = 2x(-x + 1) = -2x^2 + 2x; x \in [0, 1].$

39. (a) Because the circumference of the original circle was 8π and a piece of length x was removed.

(b) $r = \frac{8\pi - x}{2\pi} = 4 - \frac{x}{2\pi}$

(c) $h = \sqrt{16 - r^2} = \sqrt{16 - \left(4 - \frac{x}{2\pi}\right)^2} = \sqrt{16 - \left(16 - \frac{4x}{\pi} + \frac{x^2}{4\pi^2}\right)} = \sqrt{\frac{4x}{\pi} - \frac{x^2}{4\pi^2}} = \sqrt{\frac{16\pi x}{4\pi^2} - \frac{x^2}{4\pi^2}} = \frac{\sqrt{16\pi x - x^2}}{2\pi}$

(d) $V = \frac{1}{3}\pi r^2 h = \frac{1}{3}\pi \left(\frac{8\pi - x}{2\pi}\right)^2 \cdot \frac{\sqrt{16\pi x - x^2}}{2\pi} = \frac{(8\pi - x)^2 \sqrt{16\pi x - x^2}}{24\pi^2}$

40. (a) Note that 2 mi = 10,560 ft, so there are $\sqrt{800^2 + x^2}$ feet of river cable at \$180 per foot and $(10,560 - x)$ feet of land cable at \$100 per foot. The cost is $C(x) = 180\sqrt{800^2 + x^2} + 100(10,560 - x)$.

(b) $C(0) = \$1,200,000$

$C(500) \approx \$1,175,812$

$C(1000) \approx \$1,186,512$

$C(1500) \approx \$1,212,000$

$C(2000) \approx \$1,243,732$

$C(2500) \approx \$1,278,479$

$C(3000) \approx \$1,314,870$

Values beyond this are all larger. It would appear that the least expensive location is less than 2000 feet from the point P.

41. A curve symmetric about the x -axis will not pass the vertical line test because the points (x, y) and $(x, -y)$ lie on the same vertical line. The graph of the function $y = f(x) = 0$ is the x -axis, a horizontal line for which there is a single y -value, 0, for any x .

42. Pick 11, for example: $11 + 5 = 16 \rightarrow 2 \cdot 16 = 32 \rightarrow 32 - 6 = 26 \rightarrow \frac{26}{2} = 13 \rightarrow 13 - 2 = 11$, the original number.

$$f(x) = \frac{2(x+5)-6}{2} - 2 = x, \text{ the number you started with.}$$

1.4 IDENTIFYING FUNCTIONS; MATHEMATICAL MODELS

1. (a) linear, polynomial of degree 1, algebraic. (b) power, algebraic.
(c) rational, algebraic. (d) exponential.
2. (a) polynomial of degree 4, algebraic. (b) exponential.
(c) algebraic. (d) power, algebraic.
3. (a) rational, algebraic. (b) algebraic.
(c) trigonometric. (d) logarithmic.
4. (a) logarithmic. (b) algebraic.
(c) exponential. (d) trigonometric.
5. (a) Graph h because it is an even function and rises less rapidly than does Graph g.
(b) Graph f because it is an odd function.
(c) Graph g because it is an even function and rises more rapidly than does Graph h.
6. (a) Graph f because it is linear.
(b) Graph g because it contains (0, 1).
(c) Graph h because it is a nonlinear odd function.

7. Symmetric about the origin

Dec: $-\infty < x < \infty$

Inc: nowhere

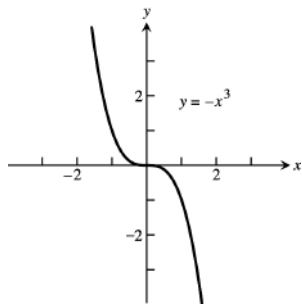

8. Symmetric about the y-axis

Dec: $-\infty < x < 0$

Inc: $0 < x < \infty$

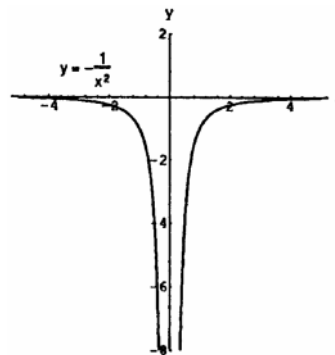

9. Symmetric about the origin

Dec: nowhere

Inc: $-\infty < x < 0$
 $0 < x < \infty$

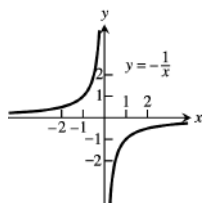

10. Symmetric about the y-axis

Dec: $0 < x < \infty$

Inc: $-\infty < x < 0$

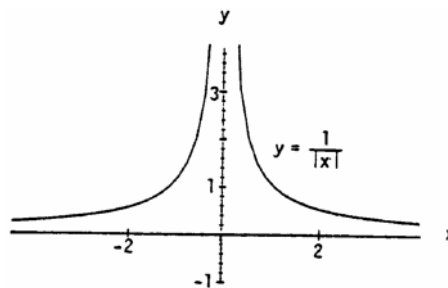

11. Symmetric about the y-axis

Dec: $-\infty < x \leq 0$

Inc: $0 < x < \infty$

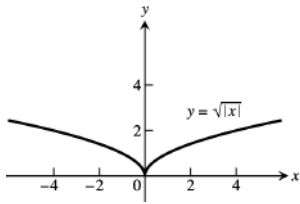

12. No symmetry

Dec: $-\infty < x \leq 0$

Inc: nowhere

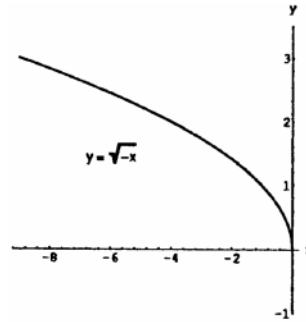

13. Symmetric about the origin

Dec: nowhere

Inc: $-\infty < x < \infty$

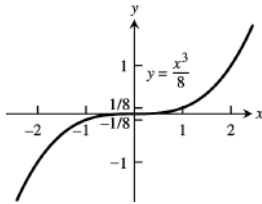

14. No symmetry

Dec: $0 \leq x < \infty$

Inc: nowhere

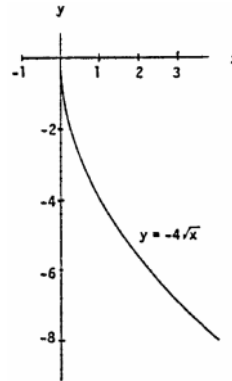

15. No symmetry

Dec: $0 \leq x < \infty$

Inc: nowhere

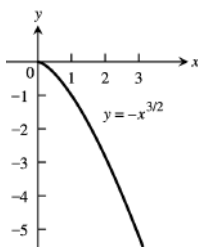

16. No symmetry

Dec: $-\infty < x \leq 0$

Inc: nowhere

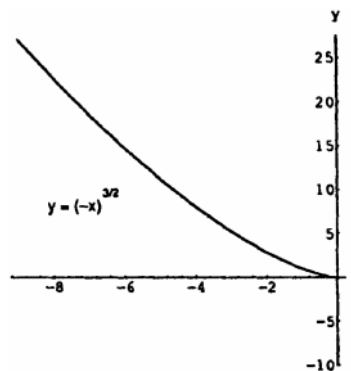

17. Symmetric about the y-axis

Dec: $-\infty < x \leq 0$

Inc: $0 < x < \infty$

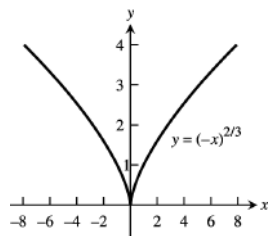

18. Symmetric about the y-axis

Dec: $0 \leq x < \infty$

Inc: $-\infty < x < 0$

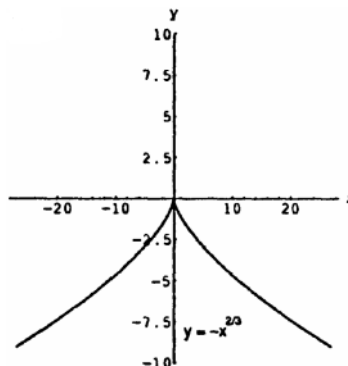

19. Since a horizontal line not through the origin is symmetric with respect to the y-axis, but not with respect to the origin, the function is even.

20. $f(x) = x^{-5} = \frac{1}{x^5}$ and $f(-x) = (-x)^{-5} = \frac{1}{(-x)^5} = -\left(\frac{1}{x^5}\right) = -f(x)$. Thus the function is odd.

21. Since $f(x) = x^2 + 1 = (-x)^2 + 1 = f(x)$. The function is even.

22. Since $[f(x) = x^2 + x] \neq [f(-x) = (-x)^2 - x]$ and $[f(x) = x^2 + x] \neq [-f(x) = -(x^2) - x]$ the function is neither even nor odd.

23. Since $g(x) = x^3 + x$, $g(-x) = -x^3 - x = -(x^3 + x) = -g(x)$. So the function is odd.

24. $g(x) = x^4 + 3x^2 + 1 = (-x)^4 + 3(-x)^2 + 1 = g(x)$, thus the function is even.

25. $g(x) = \frac{1}{x^2 - 1} = \frac{1}{(-x)^2 - 1} = g(-x)$. Thus the function is even.

26. $g(x) = \frac{x}{x^2 - 1}$; $g(-x) = \frac{-x}{x^2 - 1} = -g(x)$. So the function is odd.

27. $h(t) = \frac{1}{t-1}$; $h(-t) = \frac{1}{-t-1}$; $-h(t) = \frac{1}{1-t}$. Since $h(t) \neq -h(t)$ and $h(t) \neq h(-t)$, the function is neither even nor odd.

28. Since $|t^3| = |(-t)^3|$, $h(t) = h(-t)$ and the function is even.

29. $h(t) = 2t + 1$, $h(-t) = -2t + 1$. So $h(t) \neq h(-t)$. $-h(t) = -2t - 1$, so $h(t) \neq -h(t)$. The function is neither even nor odd.

30. $h(t) = 2|t| + 1$ and $h(-t) = 2|-t| + 1 = 2|t| + 1$. So $h(t) = h(-t)$ and the function is even.

31. (a)

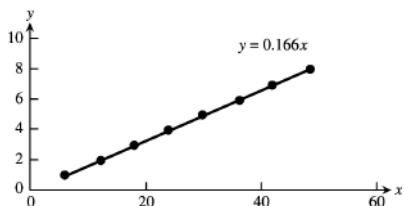

The graph supports the assumption that y is proportional to x . The constant of proportionality is estimated from the slope of the regression line, which is 0.166.

(b)

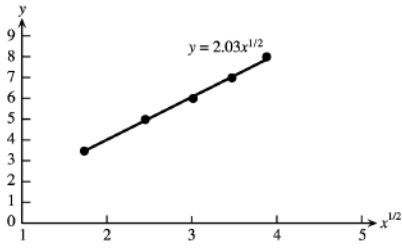

The graph supports the assumption that y is proportional to $x^{1/2}$. The constant of proportionality is estimated from the slope of the regression line, which is 2.03.

32. (a) Because of the wide range of values of the data, two graphs are needed to observe all of the points in relation to the regression line.

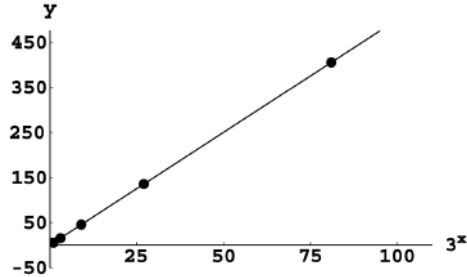
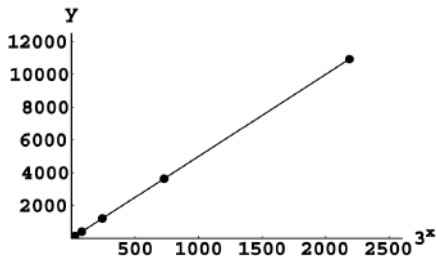

The graphs support the assumption that y is proportional to 3^x . The constant of proportionality is estimated from the slope of the regression line, which is 5.00.

(b) The graph supports the assumption that y is proportional to $\ln x$. The constant of proportionality is estimated from the slope of the regression line, which is 2.99.

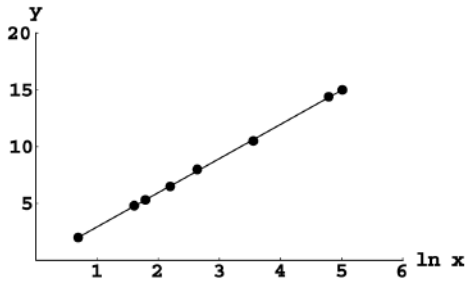

33. (a) The scatterplot of $y =$ reaction distance versus $x =$ speed is

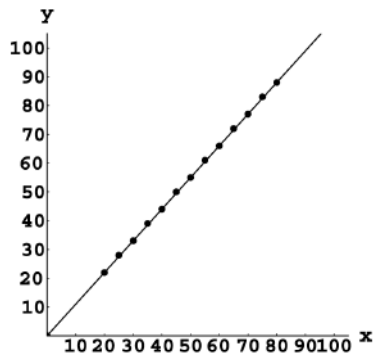

Answers for the constant of proportionality may vary. The constant of proportionality is the slope of the line, which is approximately 1.1.

(b) Calculate $x' = \text{speed squared}$. The scatterplot of x' versus $y = \text{braking distance}$ is:

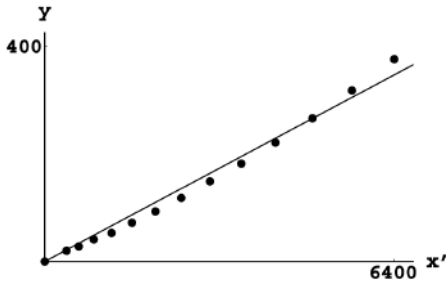

Answers for the constant of proportionality may vary. The constant of proportionality is the slope of the line, which is approximately 0.059.

34. Kepler's 3rd Law is $T(\text{days}) = 0.41R^{3/2}$, R in millions of miles. "Quaoar" is 4×10^9 miles from Earth, or about $4 \times 10^9 + 93 \times 10^6 \approx 4 \times 10^9$ miles from the sun. Let $R = 4000$ (millions of miles) and $T = (0.41)(4000)^{3/2}$ days $\approx 103,723$ days.

35. (a)

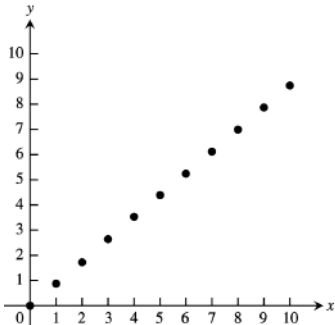

The hypothesis is reasonable.

(b) The constant of proportionality is the slope of the line $\approx \frac{8.741 - 0}{10 - 0}$ in./unit mass = 0.874 in./unit mass.

(c) $y(\text{in.}) = (0.87 \text{ in./unit mass})(13 \text{ unit mass}) = 11.31 \text{ in.}$

36. (a)

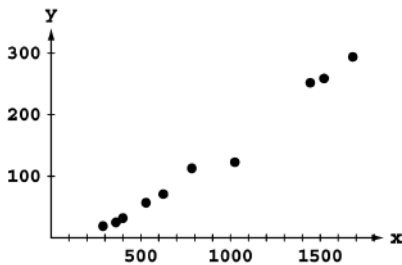

(b)

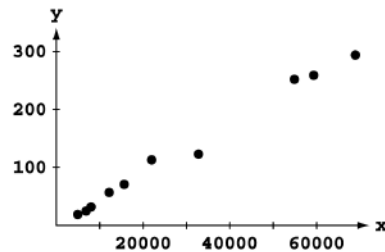

Graph (b) suggests that $y = kx^3$ is the better model. This graph is more linear than is graph (a).

1.5 COMBINING FUNCTIONS; SHIFTING AND SCALING GRAPHS

1. $D_f: -\infty < x < \infty, D_g: x \geq 1 \Rightarrow D_{f+g} = D_g: x \geq 1. R_f: -\infty < y < \infty, R_g: y \geq 0, R_{f+g}: y \geq 1, R_{fg}: y \geq 0$

2. $D_f: x + 1 \geq 0 \Rightarrow x \geq -1, D_g: x - 1 \geq 0 \Rightarrow x \geq 1. \text{ Therefore } D_{f+g} = D_{fg}: x \geq 1.$

$R_f = R_g: y \geq 0, R_{f+g}: y \geq \sqrt{2}, R_{fg}: y \geq 0$

3. $D_f: -\infty < x < \infty, D_g: -\infty < x < \infty \Rightarrow D_{f/g}: -\infty < x < \infty$ since $g(x) \neq 0$ for any x ; $D_{g/f}: -\infty < x < \infty$ since $f(x) \neq 0$ for any x . $R_f: y = 2, R_g: y \geq 1, R_{f/g}: 0 < y \leq 2, R_{g/f}: y \geq \frac{1}{2}$
4. $D_f: -\infty < x < \infty, D_g: x \geq 0 \Rightarrow D_{f/g}: x \geq 0$ since $g(x) \neq 0$ for any $x \geq 0$; $D_{g/f}: x \geq 0$ since $f(x) \neq 0$ for any $x \geq 0$. $R_f: y = 1, R_g: y \geq 1, R_{f/g}: 0 < y \leq 1, R_{g/f}: y \geq 1$
5. (a) $f(g(0)) = f(-3) = 2$
 (b) $g(f(0)) = g(5) = 22$
 (c) $f(g(x)) = f(x^2 - 3) = x^2 - 3 + 5 = x^2 + 2$
 (d) $g(f(x)) = g(x + 5) = (x + 5)^2 - 3 = x^2 + 10x + 22$
 (e) $f(f(-5)) = f(0) = 5$
 (f) $g(g(2)) = g(1) = -2$
 (g) $f(f(x)) = f(x + 5) = (x + 5) + 5 = x + 10$
 (h) $g(g(x)) = g(x^2 - 3) = (x^2 - 3)^2 - 3 = x^4 - 6x^2 + 6$
6. (a) $f\left(g\left(\frac{1}{2}\right)\right) = f\left(\frac{2}{3}\right) = -\frac{1}{3}$
 (b) $g\left(f\left(\frac{1}{2}\right)\right) = g\left(-\frac{1}{2}\right) = 2$
 (c) $f(g(x)) = f\left(\frac{1}{x+1}\right) = \frac{1}{x+1} - 1 = \frac{-x}{x+1}$
 (d) $g(f(x)) = g(x - 1) = \frac{1}{(x-1)+1} = \frac{1}{x}$
 (e) $f(f(2)) = f(1) = 0$
 (f) $g(g(2)) = g\left(\frac{1}{3}\right) = \frac{1}{\frac{1}{3}+1} = \frac{3}{4}$
 (g) $f(f(x)) = f(x - 1) = (x - 1) - 1 = x - 2$
 (h) $g(g(x)) = g\left(\frac{1}{x+1}\right) = \frac{1}{\frac{1}{x+1}+1} = \frac{x+1}{x+2}$ ($x \neq -1$ and $x \neq -2$)
7. (a) $u(v(f(x))) = u\left(v\left(\frac{1}{x}\right)\right) = u\left(\frac{1}{x^2}\right) = 4\left(\frac{1}{x^2}\right) - 5 = \frac{4}{x^2} - 5$
 (b) $u(f(v(x))) = u\left(f\left(x^2\right)\right) = u\left(\frac{1}{x^2}\right) = 4\left(\frac{1}{x^2}\right) - 5 = \frac{4}{x^2} - 5$
 (c) $v(u(f(x))) = v\left(u\left(\frac{1}{x}\right)\right) = v\left(4\left(\frac{1}{x}\right) - 5\right) = \left(\frac{4}{x} - 5\right)^2$
 (d) $v(f(u(x))) = v\left(f(4x - 5)\right) = v\left(\frac{1}{4x-5}\right) = \left(\frac{1}{4x-5}\right)^2$
 (e) $f(u(v(x))) = f\left(u\left(x^2\right)\right) = f\left(4\left(x^2\right) - 5\right) = \frac{1}{4x^2-5}$
 (f) $f(v(u(x))) = f\left(v(4x - 5)\right) = f\left(\frac{1}{(4x-5)^2}\right) = \frac{1}{(4x-5)^2}$
8. (a) $h(g(f(x))) = h\left(g\left(\sqrt{x}\right)\right) = h\left(\frac{\sqrt{x}}{4}\right) = 4\left(\frac{\sqrt{x}}{4}\right) - 8 = \sqrt{x} - 8$
 (b) $h(f(g(x))) = h\left(f\left(\frac{x}{4}\right)\right) = h\left(\sqrt{\frac{x}{4}}\right) = 4\sqrt{\frac{x}{4}} - 8 = 2\sqrt{x} - 8$
 (c) $g(h(f(x))) = g\left(h\left(\sqrt{x}\right)\right) = g\left(4\sqrt{x} - 8\right) = \frac{4\sqrt{x}-8}{4} = \sqrt{x} - 2$
 (d) $g(f(h(x))) = g\left(f(4x - 8)\right) = g\left(\sqrt{4x-8}\right) = \frac{\sqrt{4x-8}}{4} = \frac{\sqrt{x-2}}{2}$
 (e) $f(g(h(x))) = f\left(g(4x - 8)\right) = f\left(\frac{4x-8}{4}\right) = f(x - 2) = \sqrt{x-2}$
 (f) $f(h(g(x))) = f\left(h\left(\frac{x}{4}\right)\right) = f\left(4\left(\frac{x}{4}\right) - 8\right) = f(x - 8) = \sqrt{x-8}$
9. (a) $y = f(g(x))$ (b) $y = j(g(x))$
 (c) $y = g(g(x))$ (d) $y = j(j(x))$
 (e) $y = g(h(f(x)))$ (f) $y = h(j(f(x)))$
10. (a) $y = f(j(x))$ (b) $y = h(g(x)) = g(h(x))$
 (c) $y = h(h(x))$ (d) $y = f(f(x))$
 (e) $y = j(g(f(x)))$ (f) $y = g(f(h(x)))$

11.	$g(x)$	$f(x)$	$(f \circ g)(x)$
(a)	$x - 7$	\sqrt{x}	$\sqrt{x - 7}$
(b)	$x + 2$	$3x$	$3(x + 2) = 3x + 6$
(c)	x^2	$\sqrt{x - 5}$	$\sqrt{x^2 - 5}$
(d)	$\frac{x}{x-1}$	$\frac{x}{x-1}$	$\frac{\frac{x}{x-1}}{\frac{x}{x-1}-1} = \frac{x}{x-(x-1)} = x$
(e)	$\frac{1}{x-1}$	$1 + \frac{1}{x}$	x
(f)	$\frac{1}{x}$	$\frac{1}{x}$	x

12. (a) $(f \circ g)(x) = |g(x)| = \frac{1}{|x-1|}$.
 (b) $(f \circ g)(x) = \frac{g(x)-1}{g(x)} = \frac{x}{x+1} \Rightarrow 1 - \frac{1}{g(x)} = \frac{x}{x+1} \Rightarrow 1 - \frac{x}{x+1} = \frac{1}{g(x)} \Rightarrow \frac{1}{x+1} = \frac{1}{g(x)}$, so $g(x) = x + 1$.
 (c) Since $(f \circ g)(x) = \sqrt{g(x)} = |x|$, $g(x) = x^2$.
 (d) Since $(f \circ g)(x) = f(\sqrt{x}) = |x|$, $f(x) = x^2$. (Note that the domain of the composite is $[0, \infty)$.)

The completed table is shown. Note that the absolute value sign in part (d) is optional.

$g(x)$	$f(x)$	$(f \circ g)(x)$
$\frac{1}{x-1}$	$ x $	$\frac{1}{ x-1 }$
$x + 1$	$\frac{x-1}{x}$	$\frac{x}{x+1}$
x^2	\sqrt{x}	$ x $
\sqrt{x}	x^2	$ x $

13. (a) $f(g(x)) = \sqrt{\frac{1}{x} + 1} = \sqrt{\frac{1+x}{x}}$
 $g(f(x)) = \frac{1}{\sqrt{x+1}}$
 (b) Domain $(f \circ g)$: $(0, \infty)$, domain $(g \circ f)$: $(-1, \infty)$
 (c) Range $(f \circ g)$: $(1, \infty)$, range $(g \circ f)$: $(0, \infty)$

14. (a) $f(g(x)) = 1 - 2\sqrt{x} + x$
 $g(f(x)) = 1 - |x|$
 (b) Domain $(f \circ g)$: $(0, \infty)$, domain $(g \circ f)$: $(0, \infty)$
 (c) Range $(f \circ g)$: $(0, \infty)$, range $(g \circ f)$: $(-\infty, 1)$

15. (a) $y = -(x + 7)^2$ (b) $y = -(x - 4)^2$
 16. (a) $y = x^2 + 3$ (b) $y = x^2 - 5$
 17. (a) Position 4 (b) Position 1 (c) Position 2 (d) Position 3
 18. (a) $y = -(x - 1)^2 + 4$ (b) $y = -(x + 2)^2 + 3$ (c) $y = -(x + 4)^2 - 1$ (d) $y = -(x - 2)^2$

19.

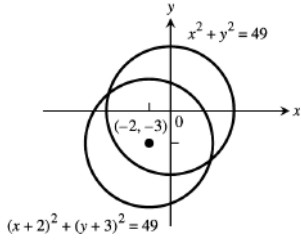

20.

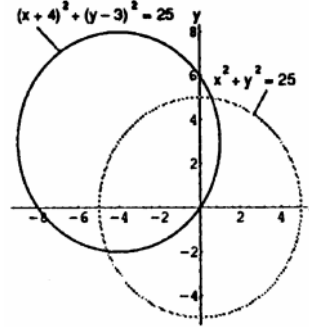

21.

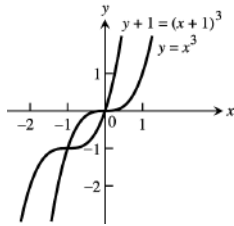

22.

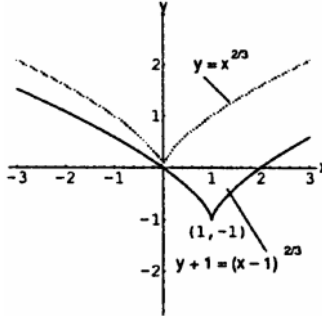

23.

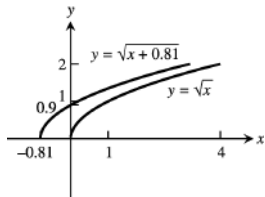

24.

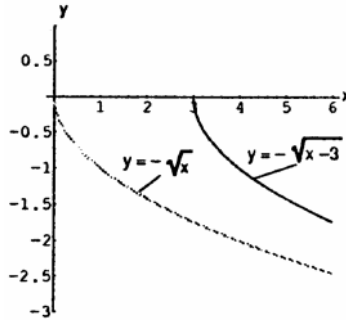

25.

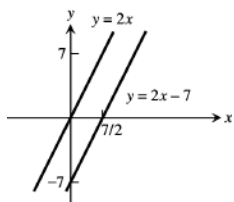

26.

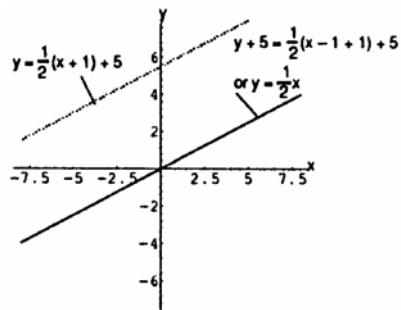

27.

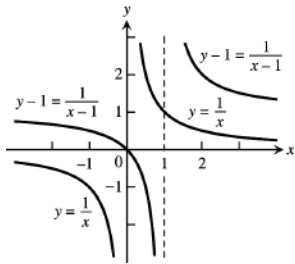

28.

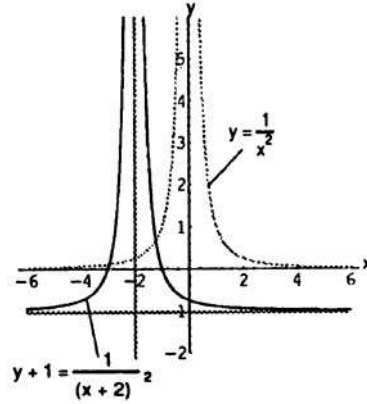

29.

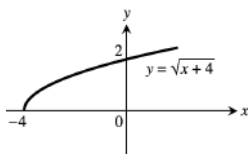

30.

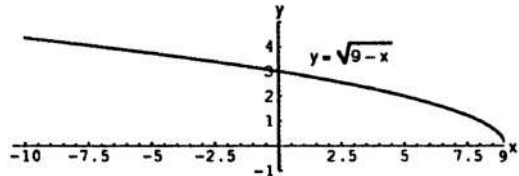

31.

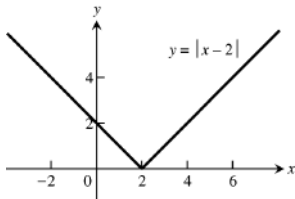

32.

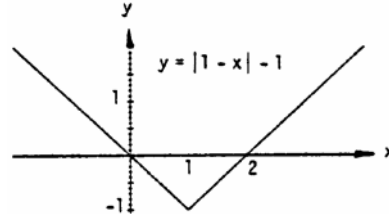

33.

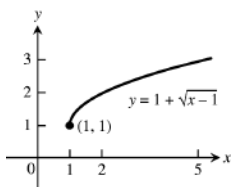

34.

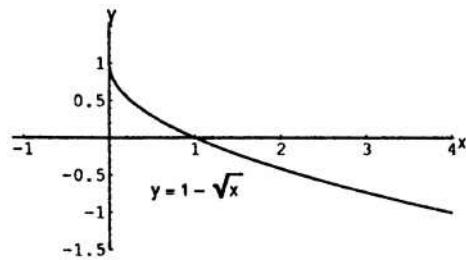

35.

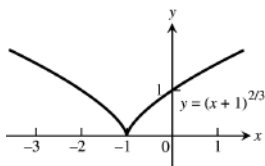

36.

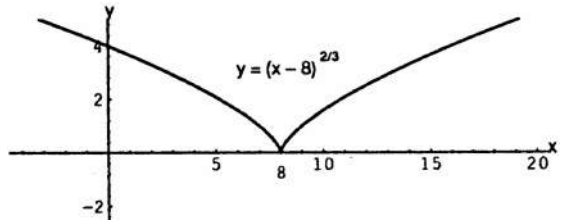

37.

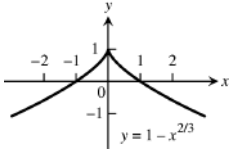

38.

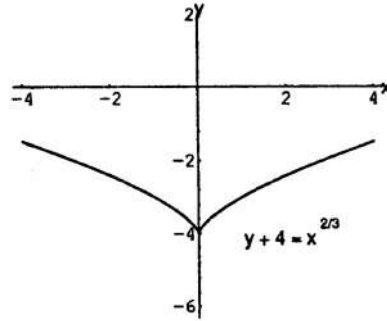

39.

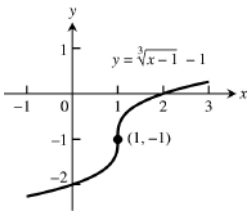

40.

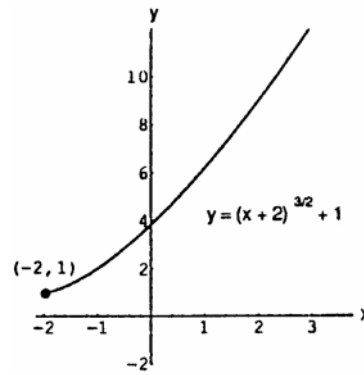

41.

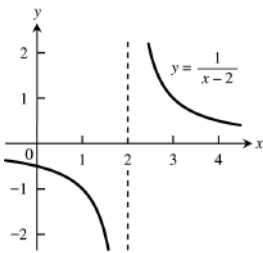

42.

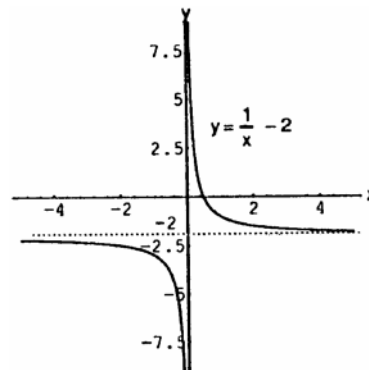

43.

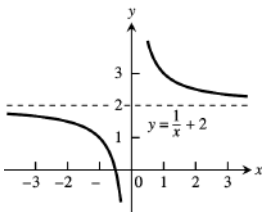

44.

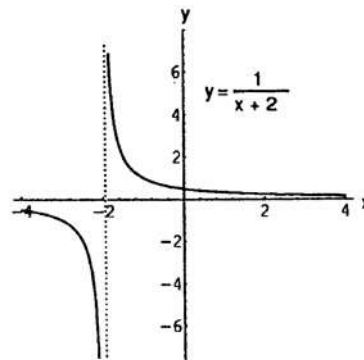

45.

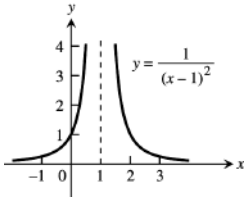

46.

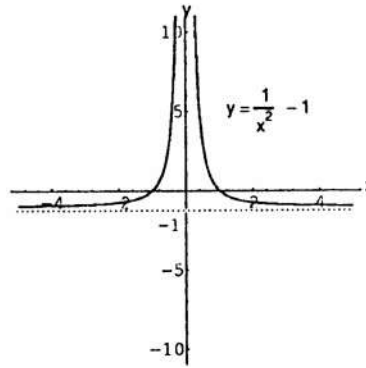

47.

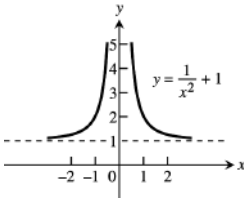

48.

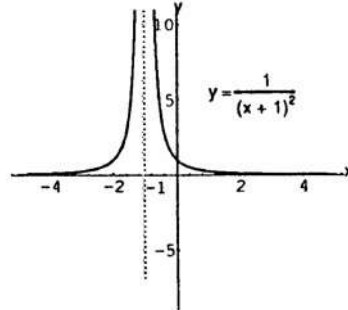

49. (a) domain: $[0, 2]$; range: $[2, 3]$

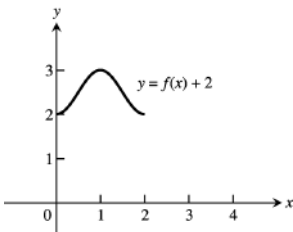

(b) domain: $[0, 2]$; range: $[-1, 0]$

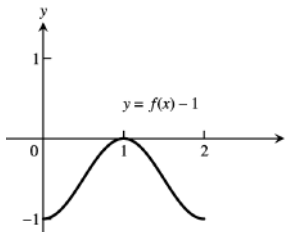

(c) domain: $[0, 2]$; range: $[0, 2]$

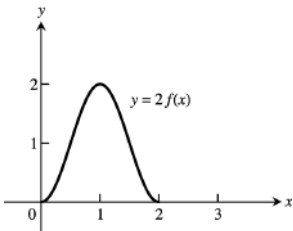

(d) domain: $[0, 2]$; range: $[-1, 0]$

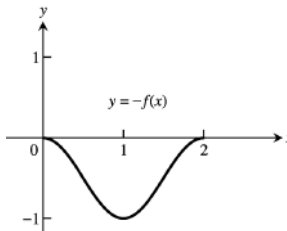

(e) domain: $[-2, 0]$; range: $[0, 1]$

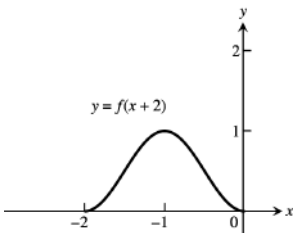

(f) domain: $[1, 3]$; range: $[0, 1]$

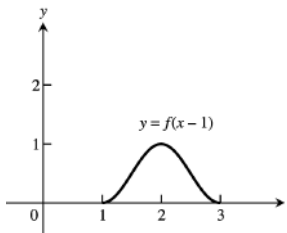

(g) domain: $[-2, 0]$; range: $[0, 1]$

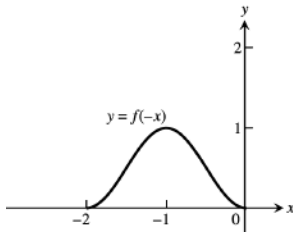

(h) domain: $[-1, 1]$; range: $[0, 1]$

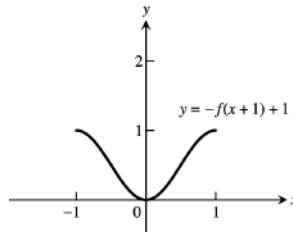

50. (a) domain: $[0, 4]$; range: $[-3, 0]$

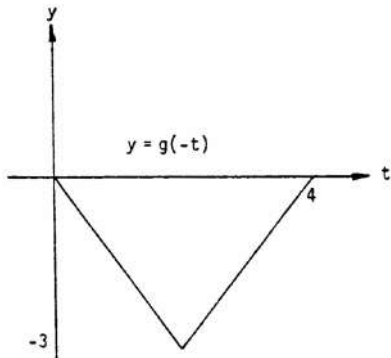

(b) domain: $[-4, 0]$; range: $[0, 3]$

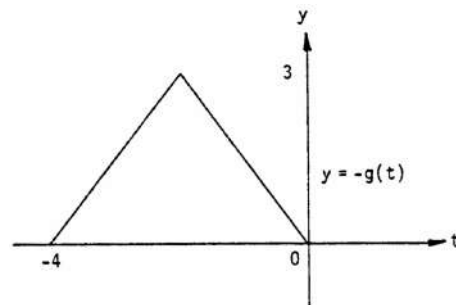

(c) domain: $[-4, 0]$; range: $[0, 3]$

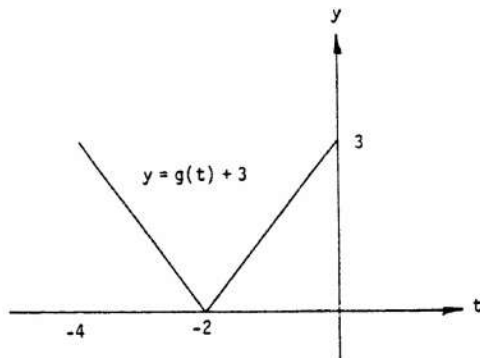

(d) domain: $[-4, 0]$; range: $[1, 4]$

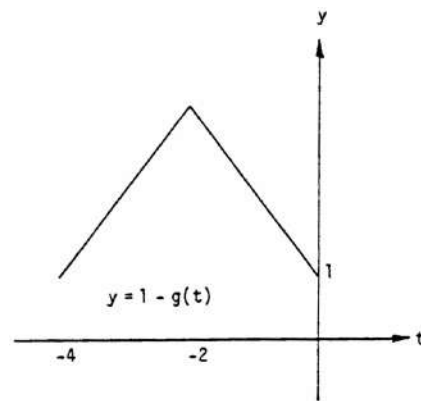

(e) domain: $[2, 4]$; range: $[-3, 0]$

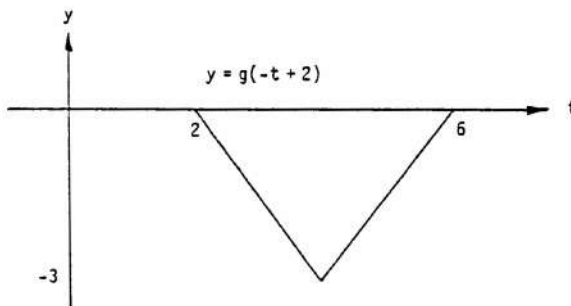

(f) domain: $[-2, 2]$; range: $[-3, 0]$

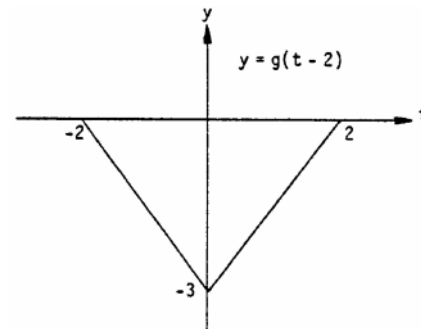

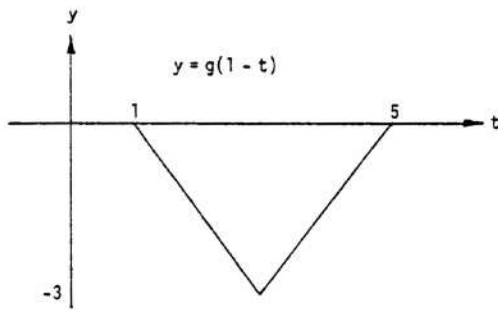
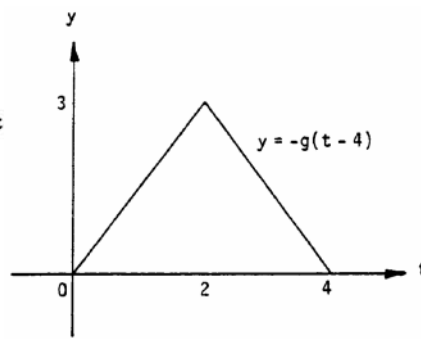
(g) domain: $[1, 5]$; range: $[-3, 0]$ (h) domain: $[0, 4]$; range: $[0, 3]$ 

51. $y = 3x^2 - 3$

52. $y = (2x)^2 - 1 = 4x^2 - 1$

53. $y = \frac{1}{2}\left(1 + \frac{1}{x^2}\right) = \frac{1}{2} + \frac{1}{2x^2}$

54. $y = 1 + \frac{1}{(x/3)^2} = 1 + \frac{9}{x^2}$

55. $y = \sqrt{4x + 1}$

56. $y = 3\sqrt{x + 1}$

57. $y = \sqrt{4 - \left(\frac{x}{2}\right)^2} = \frac{1}{2}\sqrt{16 - x^2}$

58. $y = \frac{1}{3}\sqrt{4 - x^2}$

59. $y = 1 - (3x)^3 = 1 - 27x^3$

60. $y = 1 - \left(\frac{x}{2}\right)^3 = 1 - \frac{x^3}{8}$

61. Let $y = -\sqrt{2x + 1} = f(x)$ and let $g(x) = x^{1/2}$, $h(x) = \left(x + \frac{1}{2}\right)^{1/2}$, $i(x) = \sqrt{2}\left(x + \frac{1}{2}\right)^{1/2}$, and

$j(x) = -\left[\sqrt{2}\left(x + \frac{1}{2}\right)^{1/2}\right] = f(x)$. The graph of $h(x)$ is the graph of $g(x)$ shifted left $\frac{1}{2}$ unit; the graph of $i(x)$ is the graph of $h(x)$ stretched vertically by a factor of $\sqrt{2}$; and the graph of $j(x) = f(x)$ is the graph of $i(x)$ reflected across the x -axis.

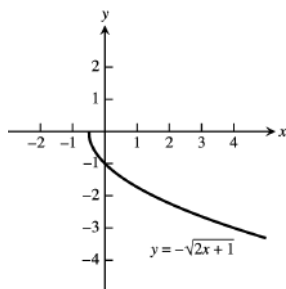

62. Let $y = \sqrt{1 - \frac{x}{2}} = f(x)$. Let $g(x) = (-x)^{1/2}$, $h(x) = (-x + 2)^{1/2}$, and $i(x) = \frac{1}{\sqrt{2}}(-x + 2)^{1/2} = \sqrt{1 - \frac{x}{2}} = f(x)$.

The graph of $g(x)$ is the graph of $y = \sqrt{x}$ reflected across the x -axis. The graph of $h(x)$ is the graph of $g(x)$ shifted right two units. And the graph of $i(x)$ is the graph of $h(x)$ compressed vertically by a factor of $\sqrt{2}$.

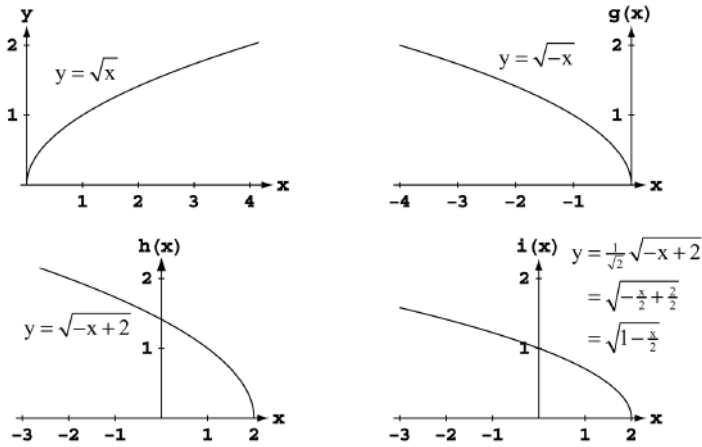

63. $y = f(x) = x^3$. Shift $f(x)$ one unit right followed by a shift two units up to get $g(x) = (x - 1)^3 + 2$.

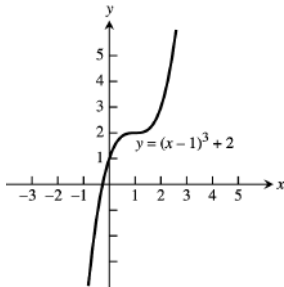

64. $y = (1 - x)^3 + 2 = -[(x - 1)^3 + (-2)] = f(x)$. Let $g(x) = x^3$, $h(x) = (x - 1)^3$, $i(x) = (x - 1)^3 + (-2)$, and $j(x) = -[(x - 1)^3 + (-2)]$. The graph of $h(x)$ is the graph of $g(x)$ shifted right one unit; the graph of $i(x)$ is the graph of $h(x)$ shifted down two units; and the graph of $f(x)$ is the graph of $i(x)$ reflected across the x -axis.

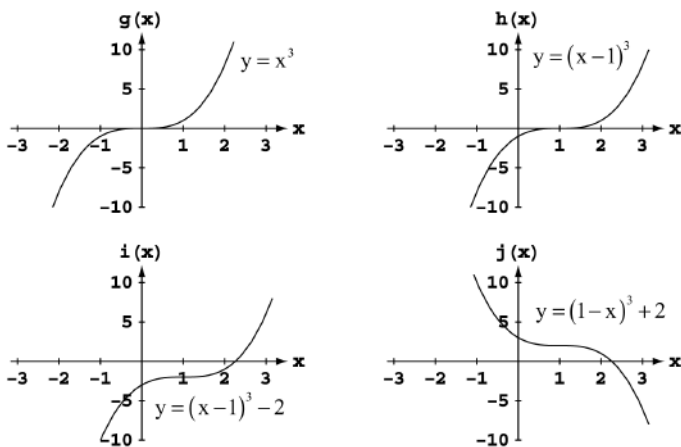

65. Compress the graph of $f(x) = \frac{1}{x}$ horizontally by a factor of 2 to get $g(x) = \frac{1}{2x}$. Then shift $g(x)$ vertically down 1 unit to get $h(x) = \frac{1}{2x} - 1$.

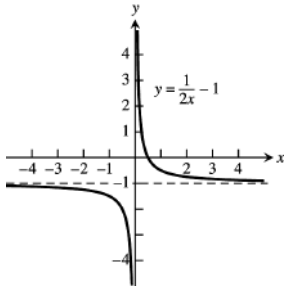

66. Let $f(x) = \frac{1}{x^2}$ and $g(x) = \frac{2}{x^2} + 1 = \frac{1}{(\frac{\sqrt{2}}{2})^2} + 1 = \frac{1}{(x/\sqrt{2})^2} + 1 = \frac{1}{[(1/\sqrt{2})x]^2} + 1$. Since $\sqrt{2} \approx 1.4$, we see that the graph of $f(x)$ stretched horizontally by a factor of 1.4 and shifted up 1 unit is the graph of $g(x)$.

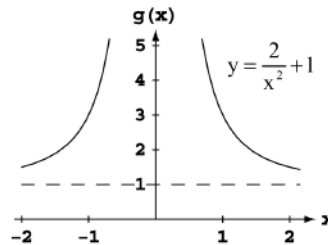
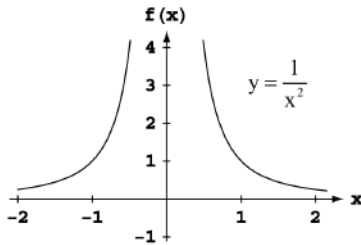

67. Reflect the graph of $y = f(x) = \sqrt[3]{x}$ across the x -axis to get $g(x) = -\sqrt[3]{x}$.

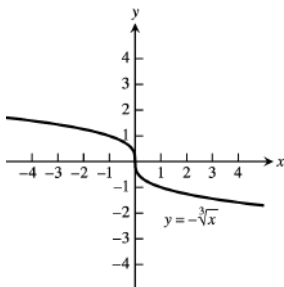

68. $y = f(x) = (-2x)^{2/3} = [(-1)(2)x]^{2/3} = (-1)^{2/3}(2x)^{2/3} = (2x)^{2/3}$. So the graph of $f(x)$ is the graph of $g(x) = x^{2/3}$ compressed horizontally by a factor of 2.

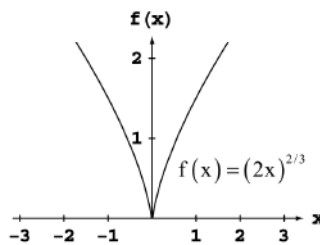
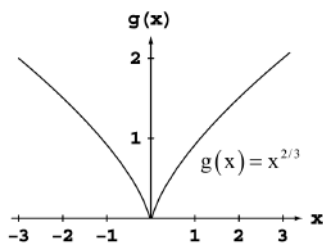

69.

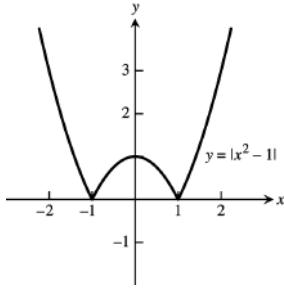

70.

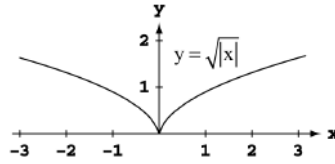

71. $9x^2 + 25y^2 = 225 \Rightarrow \frac{x^2}{3^2} + \frac{y^2}{3^2} = 1$

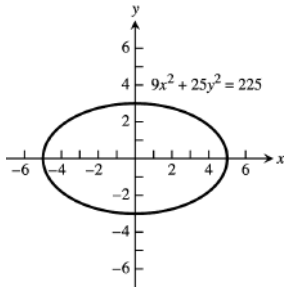

72. $16x^2 + 7y^2 = 112 \Rightarrow \frac{x^2}{(\sqrt{7})^2} + \frac{y^2}{4^2} = 1$

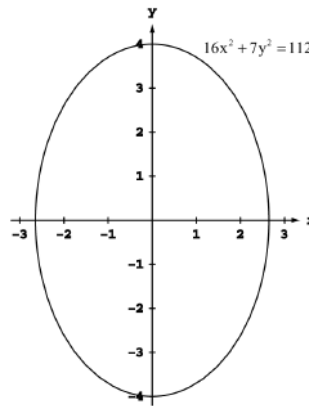

73. $3x^2 + (y - 2)^2 = 3 \Rightarrow \frac{x^2}{1^2} + \frac{(y - 2)^2}{(\sqrt{3})^2} = 1$

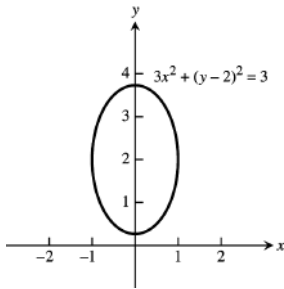

74. $(x + 1)^2 + 2y^2 = 4 \Rightarrow \frac{[x - (-1)]^2}{2^2} + \frac{y^2}{(\sqrt{2})^2} = 1$

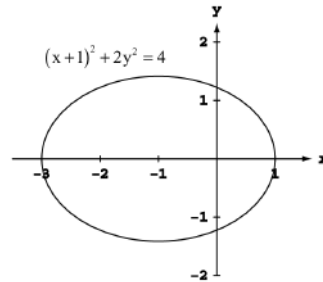

75. $3(x - 1)^2 + 2(y + 2)^2 = 6$
 $\Rightarrow \frac{(x - 1)^2}{(\sqrt{2})^2} + \frac{[y - (-2)]^2}{(\sqrt{3})^2} = 1$

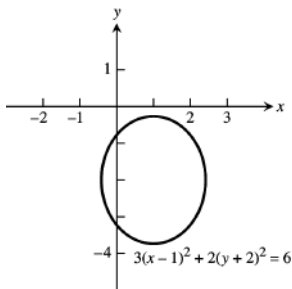

76. $6(x + \frac{3}{2})^2 + 9(y - \frac{1}{2})^2 = 54$
 $\Rightarrow \frac{[x - (-\frac{3}{2})]^2}{3^2} + \frac{(y - \frac{1}{2})^2}{(\sqrt{6})^2} = 1$

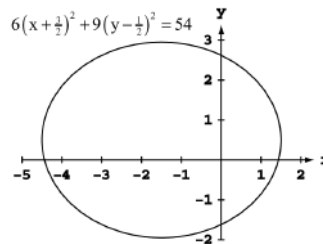

77. $\frac{x^2}{16} + \frac{y^2}{9} = 1$ has its center at $(0, 0)$. Shifting 4 units left and 3 units up gives the center at $(h, k) = (-4, 3)$. So the equation is $\frac{[x - (-4)]^2}{4^2} + \frac{(y - 3)^2}{3^2} = 1 \Rightarrow \frac{(x + 4)^2}{4^2} + \frac{(y - 3)^2}{3^2} = 1$. Center, C , is $(-4, 3)$, and major axis, \overline{AB} , is the segment from $(-8, 3)$ to $(0, 3)$.

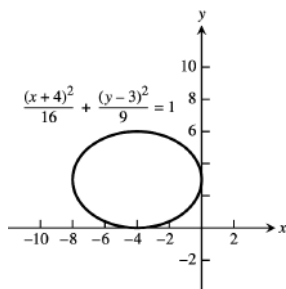

78. The ellipse $\frac{x^2}{4} + \frac{y^2}{25} = 1$ has center $(h, k) = (0, 0)$. Shifting the ellipse 3 units right and 2 units down produces an ellipse with center at $(h, k) = (3, -2)$ and an equation $\frac{(x - 3)^2}{4} + \frac{[y - (-2)]^2}{25} = 1$. Center, C , is $(3, -2)$, and \overline{AB} , the segment from $(3, 3)$ to $(3, -7)$ is the major axis.

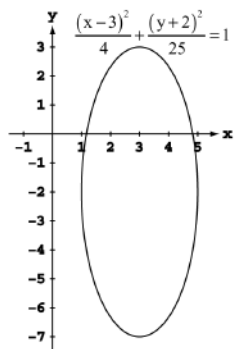

79. (a) $(fg)(-x) = f(-x)g(-x) = f(x)(-g(x)) = -(fg)(x)$, odd
 (b) $\left(\frac{f}{g}\right)(-x) = \frac{f(-x)}{g(-x)} = \frac{f(x)}{-g(x)} = -\left(\frac{f}{g}\right)(x)$, odd
 (c) $\left(\frac{g}{f}\right)(-x) = \frac{g(-x)}{f(-x)} = \frac{-g(x)}{f(x)} = -\left(\frac{g}{f}\right)(x)$, odd
 (d) $f^2(-x) = f(-x)f(-x) = f(x)f(x) = f^2(x)$, even
 (e) $g^2(-x) = (g(-x))^2 = (-g(x))^2 = g^2(x)$, even
 (f) $(f \circ g)(-x) = f(g(-x)) = f(-g(x)) = f(g(x)) = (f \circ g)(x)$, even
 (g) $(g \circ f)(-x) = g(f(-x)) = g(f(x)) = (g \circ f)(x)$, even
 (h) $(f \circ f)(-x) = f(f(-x)) = f(f(x)) = (f \circ f)(x)$, even
 (i) $(g \circ g)(-x) = g(g(-x)) = g(-g(x)) = -g(g(x)) = -(g \circ g)(x)$, odd

80. Yes, $f(x) = 0$ is both even and odd since $f(-x) = 0 = f(x)$ and $f(-x) = 0 = -f(x)$.

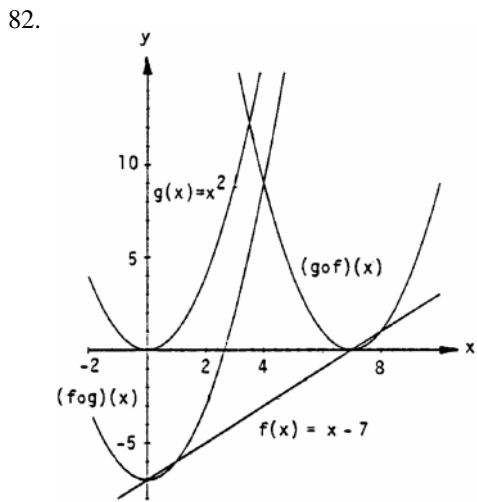
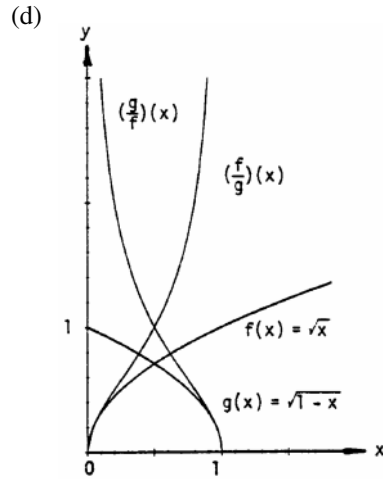
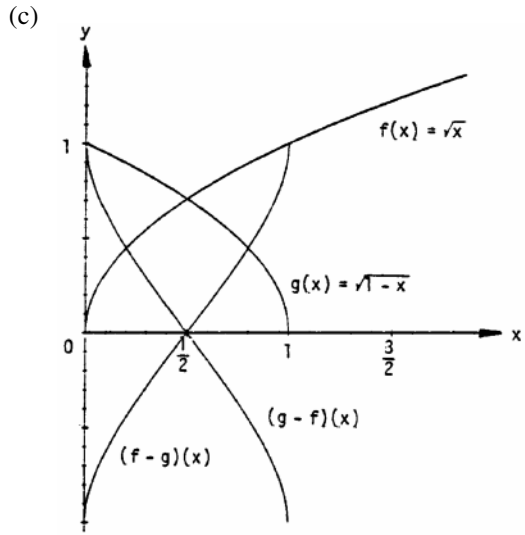
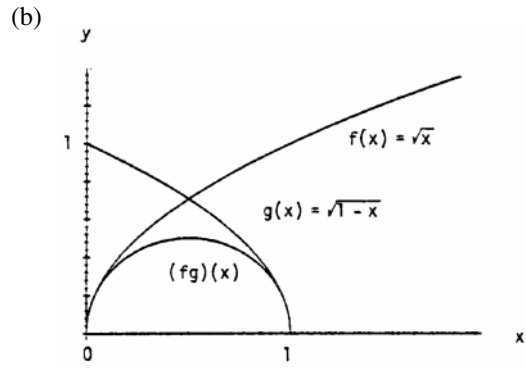
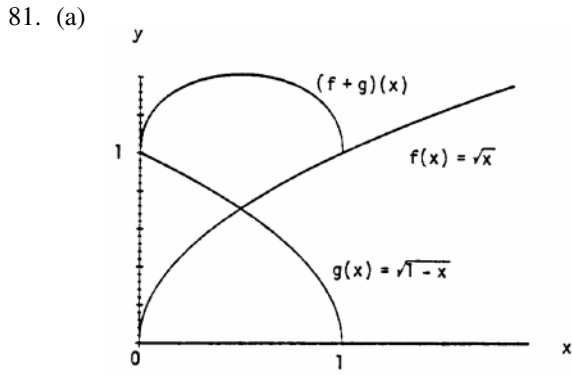

1.6 TRIGONOMETRIC FUNCTIONS

1. (a) $s = r\theta = (10) \left(\frac{4\pi}{5}\right) = 8\pi$ m
- (b) $s = r\theta = (10)(110^\circ) \left(\frac{\pi}{180^\circ}\right) = \frac{110\pi}{18} = \frac{55\pi}{9}$ m
2. $\theta = \frac{s}{r} = \frac{10\pi}{8} = \frac{5\pi}{4}$ radians and $\frac{5\pi}{4} \left(\frac{180^\circ}{\pi}\right) = 225^\circ$
3. $\theta = 80^\circ \Rightarrow \theta = 80^\circ \left(\frac{\pi}{180^\circ}\right) = \frac{4\pi}{9} \Rightarrow s = (6) \left(\frac{4\pi}{9}\right) = 8.4$ in. (since the diameter = 12 in. \Rightarrow radius = 6 in.)

4. $d = 1 \text{ meter} \Rightarrow r = 50 \text{ cm} \Rightarrow \theta = \frac{s}{r} = \frac{30}{50} = 0.6 \text{ rad or } 0.6 \left(\frac{180^\circ}{\pi}\right) \approx 34^\circ$

5.

θ	$-\pi$	$-\frac{2\pi}{3}$	0	$\frac{\pi}{2}$	$\frac{3\pi}{4}$
$\sin \theta$	0	$-\frac{\sqrt{3}}{2}$	0	1	$\frac{1}{\sqrt{2}}$
$\cos \theta$	-1	$-\frac{1}{2}$	1	0	$-\frac{1}{\sqrt{2}}$
$\tan \theta$	0	$\sqrt{3}$	0	und.	-1
$\cot \theta$	und.	$\frac{1}{\sqrt{3}}$	und.	0	-1
$\sec \theta$	-1	-2	1	und.	$-\sqrt{2}$
$\csc \theta$	und.	$-\frac{2}{\sqrt{3}}$	und.	1	$\sqrt{2}$

6.

θ	$-\frac{3\pi}{2}$	$-\frac{\pi}{3}$	$-\frac{\pi}{6}$	$\frac{\pi}{4}$	$\frac{5\pi}{6}$
$\sin \theta$	1	$-\frac{\sqrt{3}}{2}$	$-\frac{1}{2}$	$\frac{1}{\sqrt{2}}$	$\frac{1}{2}$
$\cos \theta$	0	$\frac{1}{2}$	$\frac{\sqrt{3}}{2}$	$\frac{1}{\sqrt{2}}$	$-\frac{\sqrt{3}}{2}$
$\tan \theta$	und.	$-\sqrt{3}$	$-\frac{1}{\sqrt{3}}$	1	$-\frac{1}{\sqrt{3}}$
$\cot \theta$	0	$-\frac{1}{\sqrt{3}}$	$-\sqrt{3}$	1	$-\sqrt{3}$
$\sec \theta$	und.	2	$\frac{2}{\sqrt{3}}$	$\sqrt{2}$	$-\frac{2}{\sqrt{3}}$
$\csc \theta$	1	$-\frac{2}{\sqrt{3}}$	-2	$\sqrt{2}$	2

7. $\cos x = -\frac{4}{5}, \tan x = -\frac{3}{4}$

8. $\sin x = \frac{2}{\sqrt{5}}, \cos x = \frac{1}{\sqrt{5}}$

9. $\sin x = -\frac{\sqrt{8}}{3}, \tan x = -\sqrt{8}$

10. $\sin x = \frac{12}{13}, \tan x = -\frac{12}{5}$

11. $\sin x = -\frac{1}{\sqrt{5}}, \cos x = -\frac{2}{\sqrt{5}}$

12. $\cos x = -\frac{\sqrt{3}}{2}, \tan x = \frac{1}{\sqrt{3}}$

13.

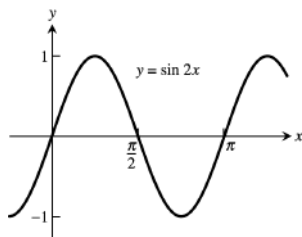

period = π

14.

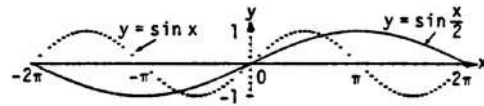

period = 4π

15.

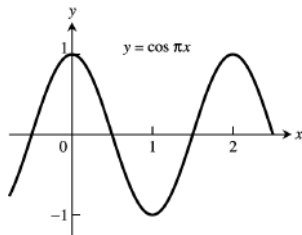

period = 2

16.

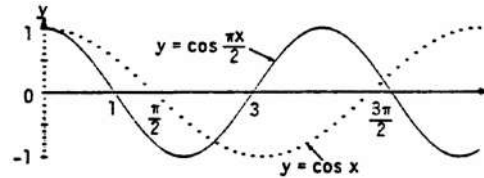

period = 4

17.

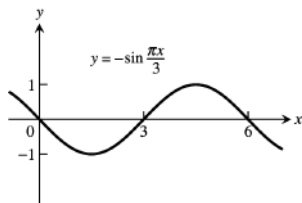

period = 6

18.

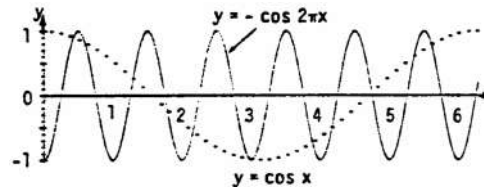

period = 1

19.

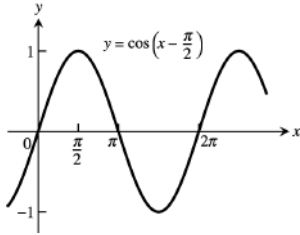

period = 2π

20.

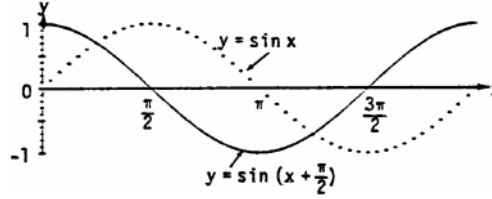

period = 2π

21.

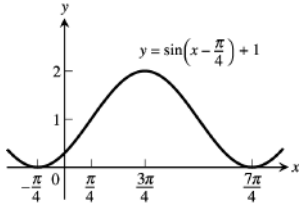

period = 2π

22.

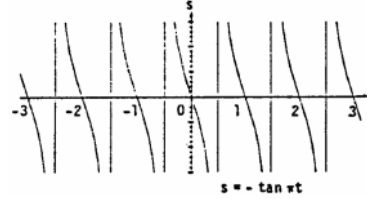

period = 2π

23. period = $\frac{\pi}{2}$, symmetric about the origin

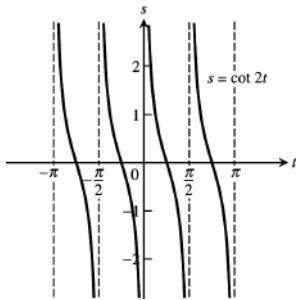

24. period = 1, symmetric about the origin

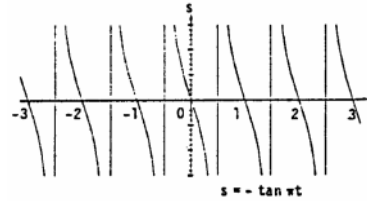

25. period = 4, symmetric about the y-axis

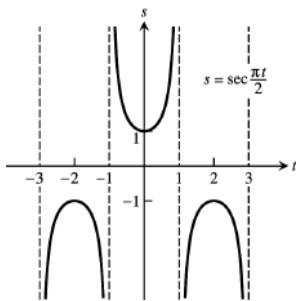

26. period = 4π , symmetric about the origin

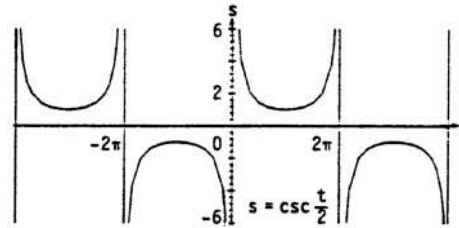

27. (a) $\cos x$ and $\sec x$ are positive in QI and QIV and negative in QII and QIII. $\sec x$ is undefined when $\cos x$ is 0. The range of $\sec x$ is $(-\infty, -1] \cup [1, \infty)$; the range of $\cos x$ is $[-1, 1]$.

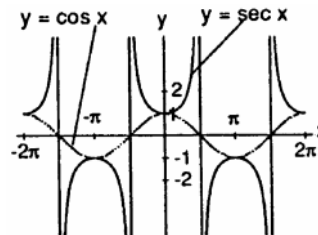

- (b) $\sin x$ and $\csc x$ are positive in QI and QII and negative in QIII and QIV. $\csc x$ is undefined when $\sin x$ is 0. The range of $\csc x$ is $(-\infty, -1] \cup [1, \infty)$; the range of $\sin x$ is $[-1, 1]$.

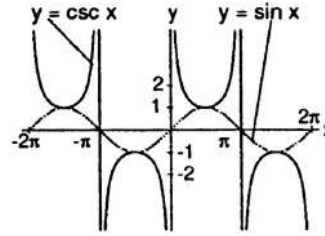

28. Since $\cot x = \frac{1}{\tan x}$, $\cot x$ is undefined when $\tan x = 0$ and is zero when $\tan x$ is undefined. As $\tan x$ approaches zero through positive values, $\cot x$ approaches infinity. Also, $\cot x$ approaches negative infinity as $\tan x$ approaches zero through negative values.

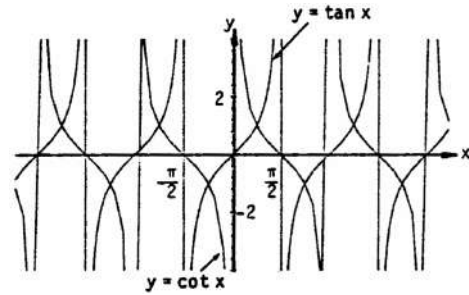

29. D: $-\infty < x < \infty$; R: $y = -1, 0, 1$

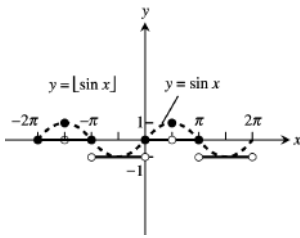

30. D: $-\infty < x < \infty$; R: $y = -1, 0, 1$

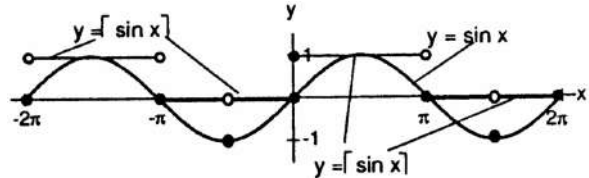

31. $\cos\left(x - \frac{\pi}{2}\right) = \cos x \cos\left(-\frac{\pi}{2}\right) - \sin x \sin\left(-\frac{\pi}{2}\right) = (\cos x)(0) - (\sin x)(-1) = \sin x$
32. $\cos\left(x + \frac{\pi}{2}\right) = \cos x \cos\left(\frac{\pi}{2}\right) - \sin x \sin\left(\frac{\pi}{2}\right) = (\cos x)(0) - (\sin x)(1) = -\sin x$
33. $\sin\left(x + \frac{\pi}{2}\right) = \sin x \cos\left(\frac{\pi}{2}\right) + \cos x \sin\left(\frac{\pi}{2}\right) = (\sin x)(0) + (\cos x)(1) = \cos x$
34. $\sin\left(x - \frac{\pi}{2}\right) = \sin x \cos\left(-\frac{\pi}{2}\right) + \cos x \sin\left(-\frac{\pi}{2}\right) = (\sin x)(0) + (\cos x)(-1) = -\cos x$
35. $\cos(A - B) = \cos(A + (-B)) = \cos A \cos(-B) - \sin A \sin(-B) = \cos A \cos B - \sin A(-\sin B)$
 $= \cos A \cos B + \sin A \sin B$
36. $\sin(A - B) = \sin(A + (-B)) = \sin A \cos(-B) + \cos A \sin(-B) = \sin A \cos B + \cos A(-\sin B)$
 $= \sin A \cos B - \cos A \sin B$
37. If $B = A$, $A - B = 0 \Rightarrow \cos(A - B) = \cos 0 = 1$. Also $\cos(A - B) = \cos(A - A) = \cos A \cos A + \sin A \sin A$
 $= \cos^2 A + \sin^2 A$. Therefore, $\cos^2 A + \sin^2 A = 1$.
38. If $B = 2\pi$, then $\cos(A + 2\pi) = \cos A \cos 2\pi - \sin A \sin 2\pi = (\cos A)(1) - (\sin A)(0) = \cos A$ and
 $\sin(A + 2\pi) = \sin A \cos 2\pi + \cos A \sin 2\pi = (\sin A)(1) + (\cos A)(0) = \sin A$. The result agrees with the fact that the cosine and sine functions have period 2π .
39. $\cos(\pi + x) = \cos \pi \cos x - \sin \pi \sin x = (-1)(\cos x) - (0)(\sin x) = -\cos x$

$$40. \sin(2\pi - x) = \sin 2\pi \cos(-x) + \cos(2\pi) \sin(-x) = (0)(\cos(-x)) + (1)(\sin(-x)) = -\sin x$$

$$41. \sin\left(\frac{3\pi}{2} - x\right) = \sin\left(\frac{3\pi}{2}\right) \cos(-x) + \cos\left(\frac{3\pi}{2}\right) \sin(-x) = (-1)(\cos x) + (0)(\sin(-x)) = -\cos x$$

$$42. \cos\left(\frac{3\pi}{2} + x\right) = \cos\left(\frac{3\pi}{2}\right) \cos x - \sin\left(\frac{3\pi}{2}\right) \sin x = (0)(\cos x) - (-1)(\sin x) = \sin x$$

$$43. \sin \frac{7\pi}{12} = \sin\left(\frac{\pi}{4} + \frac{\pi}{3}\right) = \sin \frac{\pi}{4} \cos \frac{\pi}{3} + \cos \frac{\pi}{4} \sin \frac{\pi}{3} = \left(\frac{\sqrt{2}}{2}\right)\left(\frac{1}{2}\right) + \left(\frac{\sqrt{2}}{2}\right)\left(\frac{\sqrt{3}}{2}\right) = \frac{\sqrt{6} + \sqrt{2}}{4}$$

$$44. \cos \frac{11\pi}{12} = \cos\left(\frac{\pi}{4} + \frac{2\pi}{3}\right) = \cos \frac{\pi}{4} \cos \frac{2\pi}{3} - \sin \frac{\pi}{4} \sin \frac{2\pi}{3} = \left(\frac{\sqrt{2}}{2}\right)\left(-\frac{1}{2}\right) - \left(\frac{\sqrt{2}}{2}\right)\left(\frac{\sqrt{3}}{2}\right) = -\frac{\sqrt{2} + \sqrt{6}}{4}$$

$$45. \cos \frac{\pi}{12} = \cos\left(\frac{\pi}{3} - \frac{\pi}{4}\right) = \cos \frac{\pi}{3} \cos\left(-\frac{\pi}{4}\right) - \sin \frac{\pi}{3} \sin\left(-\frac{\pi}{4}\right) = \left(\frac{1}{2}\right)\left(\frac{\sqrt{2}}{2}\right) - \left(\frac{\sqrt{3}}{2}\right)\left(-\frac{\sqrt{2}}{2}\right) = \frac{1 + \sqrt{3}}{2\sqrt{2}}$$

$$46. \sin \frac{5\pi}{12} = \sin\left(\frac{2\pi}{3} - \frac{\pi}{4}\right) = \sin\left(\frac{2\pi}{3}\right) \cos\left(-\frac{\pi}{4}\right) + \cos\left(\frac{2\pi}{3}\right) \sin\left(-\frac{\pi}{4}\right) = \left(\frac{\sqrt{3}}{2}\right)\left(\frac{\sqrt{2}}{2}\right) + \left(-\frac{1}{2}\right)\left(-\frac{\sqrt{2}}{2}\right) = \frac{1 + \sqrt{3}}{2\sqrt{2}}$$

$$47. \cos^2 \frac{\pi}{8} = \frac{1 + \cos\left(\frac{2\pi}{8}\right)}{2} = \frac{1 + \frac{\sqrt{2}}{2}}{2} = \frac{2 + \sqrt{2}}{4}$$

$$48. \cos^2 \frac{\pi}{12} = \frac{1 + \cos\left(\frac{2\pi}{12}\right)}{2} = \frac{1 + \frac{\sqrt{3}}{2}}{2} = \frac{2 + \sqrt{3}}{4}$$

$$49. \sin^2 \frac{\pi}{12} = \frac{1 - \cos\left(\frac{2\pi}{12}\right)}{2} = \frac{1 - \frac{\sqrt{3}}{2}}{2} = \frac{2 - \sqrt{3}}{4}$$

$$50. \sin^2 \frac{\pi}{8} = \frac{1 - \cos\left(\frac{2\pi}{8}\right)}{2} = \frac{1 - \frac{\sqrt{2}}{2}}{2} = \frac{2 - \sqrt{2}}{4}$$

$$51. \tan(A + B) = \frac{\sin(A+B)}{\cos(A+B)} = \frac{\sin A \cos B + \cos A \sin B}{\cos A \cos B - \sin A \sin B} = \frac{\frac{\sin A \cos B}{\cos A \cos B} + \frac{\cos A \sin B}{\cos A \cos B}}{\frac{\cos A \cos B}{\cos A \cos B} - \frac{\sin A \sin B}{\cos A \cos B}} = \frac{\tan A + \tan B}{1 - \tan A \tan B}$$

$$52. \tan(A - B) = \frac{\sin(A-B)}{\cos(A-B)} = \frac{\sin A \cos B - \cos A \sin B}{\cos A \cos B + \sin A \sin B} = \frac{\frac{\sin A \cos B}{\cos A \cos B} - \frac{\cos A \sin B}{\cos A \cos B}}{\frac{\cos A \cos B}{\cos A \cos B} + \frac{\sin A \sin B}{\cos A \cos B}} = \frac{\tan A - \tan B}{1 + \tan A \tan B}$$

53. According to the figure in the text, we have the following: By the law of cosines, $c^2 = a^2 + b^2 - 2ab \cos \theta$
 $= 1^2 + 1^2 - 2 \cos(A - B) = 2 - 2 \cos(A - B)$. By distance formula, $c^2 = (\cos A - \cos B)^2 + (\sin A - \sin B)^2$
 $= \cos^2 A - 2 \cos A \cos B + \cos^2 B + \sin^2 A - 2 \sin A \sin B + \sin^2 B = 2 - 2(\cos A \cos B + \sin A \sin B)$. Thus
 $c^2 = 2 - 2 \cos(A - B) = 2 - 2(\cos A \cos B + \sin A \sin B) \Rightarrow \cos(A - B) = \cos A \cos B + \sin A \sin B$.

$$54. (a) \cos(A - B) = \cos A \cos B + \sin A \sin B$$

$$\sin \theta = \cos\left(\frac{\pi}{2} - \theta\right) \text{ and } \cos \theta = \sin\left(\frac{\pi}{2} - \theta\right)$$

$$\text{Let } \theta = A + B$$

$$\sin(A + B) = \cos\left[\frac{\pi}{2} - (A + B)\right] = \cos\left[\left(\frac{\pi}{2} - A\right) - B\right] = \cos\left(\frac{\pi}{2} - A\right) \cos B + \sin\left(\frac{\pi}{2} - A\right) \sin B$$

$$= \sin A \cos B + \cos A \sin B$$

$$(b) \cos(A - B) = \cos A \cos B + \sin A \sin B$$

$$\cos(A - (-B)) = \cos A \cos(-B) + \sin A \sin(-B)$$

$$\Rightarrow \cos(A + B) = \cos A \cos(-B) + \sin A \sin(-B) = \cos A \cos B + \sin A(-\sin B)$$

$$= \cos A \cos B - \sin A \sin B$$

Because the cosine function is even and the sine functions is odd.

$$55. c^2 = a^2 + b^2 - 2ab \cos C = 2^2 + 3^2 - 2(2)(3) \cos(60^\circ) = 4 + 9 - 12 \cos(60^\circ) = 13 - 12\left(\frac{1}{2}\right) = 7.$$

$$\text{Thus, } c = \sqrt{7} \approx 2.65.$$

$$56. c^2 = a^2 + b^2 - 2ab \cos C = 2^2 + 3^2 - 2(2)(3) \cos(40^\circ) = 13 - 12 \cos(40^\circ). \text{ Thus, } c = \sqrt{13 - 12 \cos 40^\circ} \approx 1.951.$$

57. From the figures in the text, we see that $\sin B = \frac{h}{c}$. If C is an acute angle, then $\sin C = \frac{h}{b}$. On the other hand, if C is obtuse (as in the figure on the right), then $\sin C = \sin(\pi - C) = \frac{h}{b}$. Thus, in either case, $h = b \sin C = c \sin B \Rightarrow ah = ab \sin C = ac \sin B$.

By the law of cosines, $\cos C = \frac{a^2+b^2-c^2}{2ab}$ and $\cos B = \frac{a^2+c^2-b^2}{2ac}$. Moreover, since the sum of the interior angles of a triangle is π , we have $\sin A = \sin(\pi - (B + C)) = \sin(B + C) = \sin B \cos C + \cos B \sin C$
 $= \left(\frac{h}{c}\right) \left[\frac{a^2+b^2-c^2}{2ab}\right] + \left[\frac{a^2+c^2-b^2}{2ac}\right] \left(\frac{h}{b}\right) = \left(\frac{h}{2abc}\right) (2a^2 + b^2 - c^2 + c^2 - b^2) = \frac{ah}{bc} \Rightarrow ah = bc \sin A$.

Combining our results we have $ah = ab \sin C$, $ah = ac \sin B$, and $ah = bc \sin A$. Dividing by abc gives

$$\frac{h}{bc} = \underbrace{\frac{\sin A}{a} = \frac{\sin C}{c} = \frac{\sin B}{b}}_{\text{law of sines}}.$$

58. By the law of sines, $\frac{\sin A}{2} = \frac{\sin B}{3} = \frac{\sqrt{3}/2}{c}$. By Exercise 55 we know that $c = \sqrt{7}$.

Thus $\sin B = \frac{3\sqrt{3}}{2\sqrt{7}} \approx 0.982$.

59. From the figure at the right and the law of cosines,

$$b^2 = a^2 + 2^2 - 2(2a) \cos B$$

$$= a^2 + 4 - 4a \left(\frac{1}{2}\right) = a^2 - 2a + 4.$$

Applying the law of sines to the figure, $\frac{\sin A}{a} = \frac{\sin B}{b}$

$$\Rightarrow \frac{\sqrt{2}/2}{a} = \frac{\sqrt{3}/2}{b} \Rightarrow b = \sqrt{\frac{3}{2}} a.$$

Thus, combining results,

$$a^2 - 2a + 4 = b^2 = \frac{3}{2} a^2 \Rightarrow 0 = \frac{1}{2} a^2 + 2a - 4$$

$\Rightarrow 0 = a^2 + 4a - 8$. From the quadratic formula and the fact that $a > 0$, we have

$$a = \frac{-4 + \sqrt{4^2 - 4(1)(-8)}}{2} = \frac{4\sqrt{3}-4}{2} \approx 1.464.$$

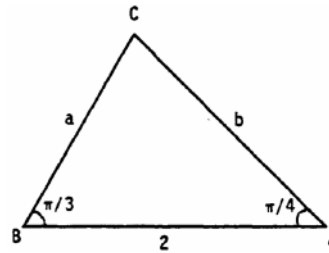

60. (a) The graphs of $y = \sin x$ and $y = x$ nearly coincide when x is near the origin (when the calculator is in radians mode).

(b) In degree mode, when x is near zero degrees the sine of x is much closer to zero than x itself. The curves look like intersecting straight lines near the origin when the calculator is in degree mode.

61. $A = 2, B = 2\pi, C = -\pi, D = -1$

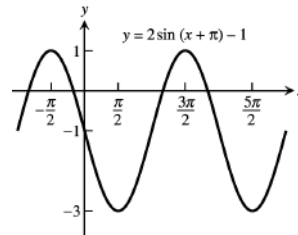

62. $A = \frac{1}{2}, B = 2, C = 1, D = \frac{1}{2}$

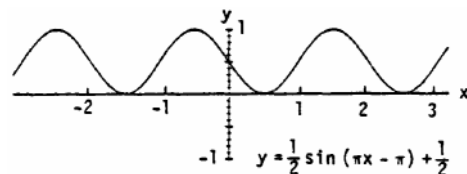

63. $A = -\frac{2}{\pi}, B = 4, C = 0, D = \frac{1}{\pi}$

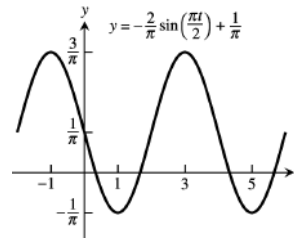

64. $A = \frac{L}{2\pi}, B = L, C = 0, D = 0$

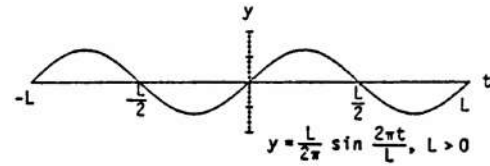

65. (a) amplitude = $|A| = 37$ (b) period = $|B| = 365$
 (c) right horizontal shift = $C = 101$ (d) upward vertical shift = $D = 25$
66. (a) It is highest when the value of the sine is 1 at $f(101) = 37 \sin(0) + 25 = 62^\circ \text{ F}$.
 The lowest mean daily temp is $37(-1) + 25 = -12^\circ \text{ F}$.
 (b) The average of the highest and lowest mean daily temperatures = $\frac{62^\circ + (-12)^\circ}{2} = 25^\circ \text{ F}$.
 The average of the sine function is its horizontal axis, $y = 25$.

67-70. Example CAS commands:

Maple

```
f := x -> A*sin((2*Pi/B)*(x-C))+D1;
A:=3; C:=0; D1:=0;
f_list := [seq( f(x), B=[1,3,2*Pi,5*Pi] )];
plot( f_list, x=-4*Pi..4*Pi, scaling=constrained,
      color=[red,blue,green,cyan], linestyle=[1,3,4,7],
      legend=["B=1", "B=3", "B=2*Pi", "B=3*Pi"],
      title="#67 (Section 1.6)");
```

Mathematica

```
Clear[a, b, c, d, f, x]
f[x_]:=a Sin[2π/b (x - c)] + d
Plot[f[x]/.{a -> 3, b -> 1, c -> 0, d -> 0}, {x, -4π, 4π}]
```

67. (a) The graph stretches horizontally.

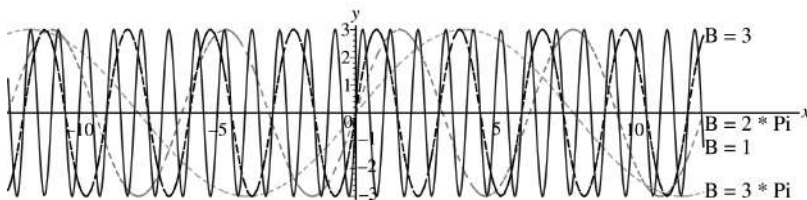

- (b) The period remains the same: period = $|B|$. The graph has a horizontal shift of $\frac{1}{2}$ period.

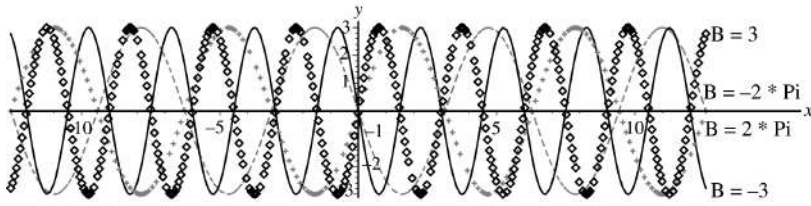

68. (a) The graph is shifted right C units.

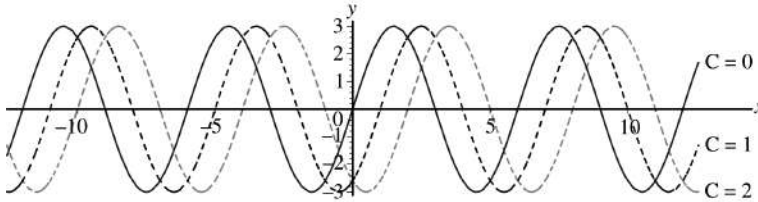

- (b) The graph is shifted left C units.
 (c) A shift of \pm one period will produce no apparent shift. $|C| = 6$

69. The graph shifts upwards $|D|$ units for $D > 0$ and down $|D|$ units for $D < 0$.

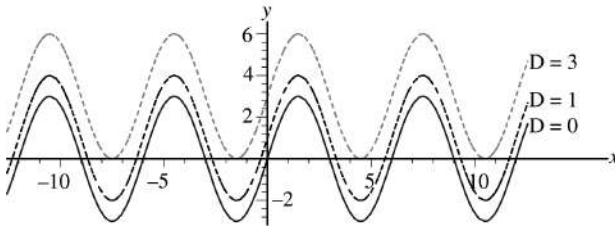

70. (a) The graph stretches $|A|$ units.

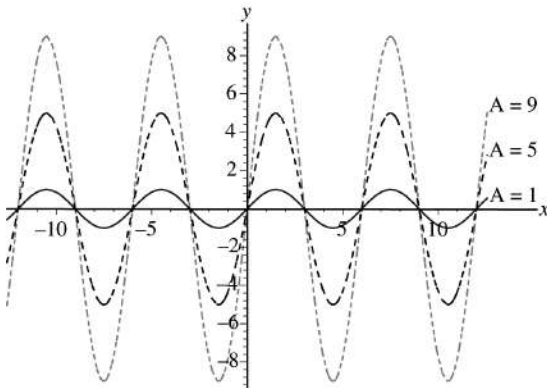

- (b) For $A < 0$, the graph is inverted.

1.7 GRAPHING WITH CALCULATORS AND COMPUTERS

- 1-4. The most appropriate viewing window displays the maxima, minima, intercepts, and end behavior of the graphs and has little unused space.

1. d.

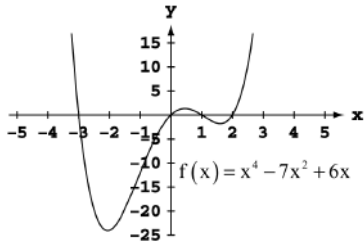

2. c.

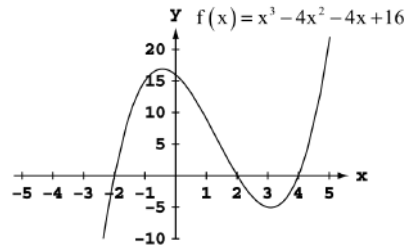

3. d.

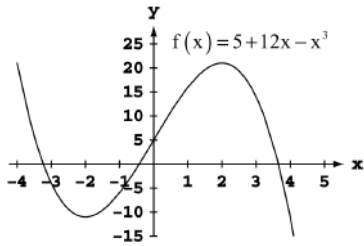

4. b.

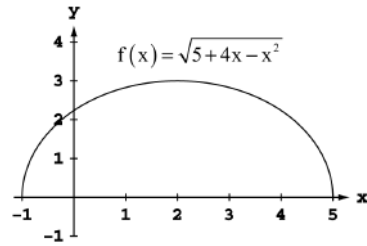

5-30. For any display there are many appropriate display widows. The graphs given as answers in Exercises 5–30 are not unique in appearance.

5. $[-2, 5]$ by $[-15, 40]$

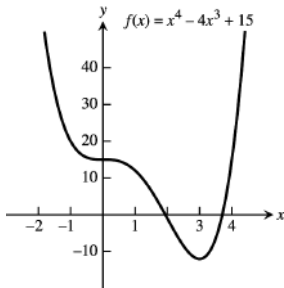

6. $[-4, 4]$ by $[-4, 4]$

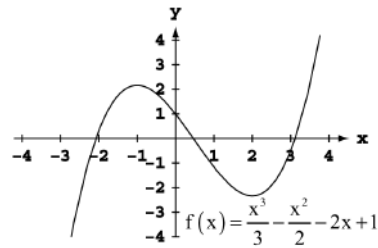

7. $[-2, 6]$ by $[-250, 50]$

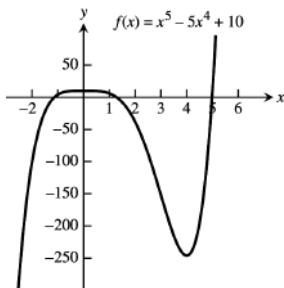

8. $[-1, 5]$ by $[-5, 30]$

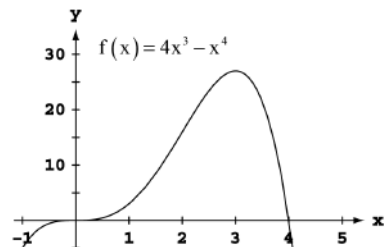

9. $[-4, 4]$ by $[-5, 5]$

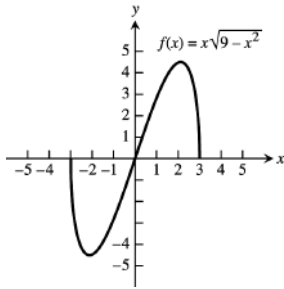

10. $[-2, 2]$ by $[-2, 8]$

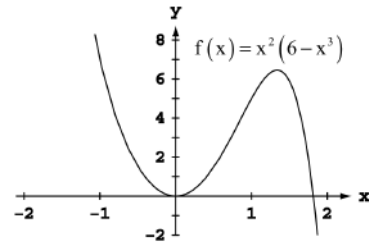

11. $[-2, 6]$ by $[-5, 4]$

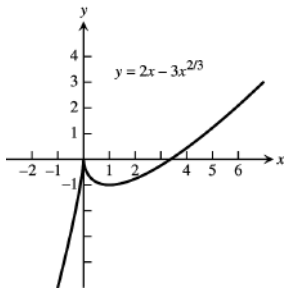

12. $[-4, 4]$ by $[-8, 8]$

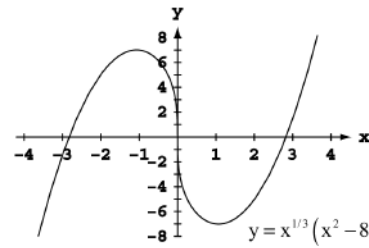

13. $[-1, 6]$ by $[-1, 4]$

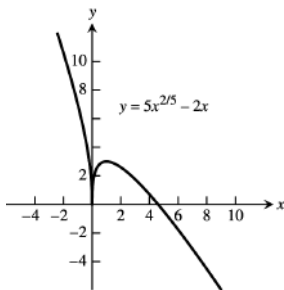

14. $[-1, 6]$ by $[-1, 5]$

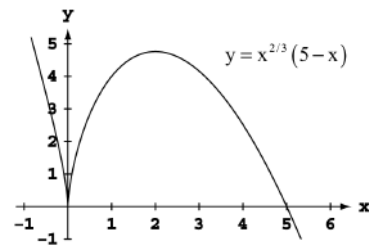

15. $[-3, 3]$ by $[0, 10]$

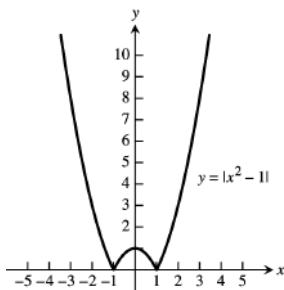

16. $[-1, 2]$ by $[0, 1]$

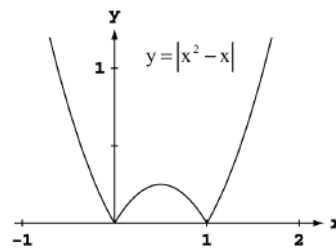

17. $[-5, 1]$ by $[-5, 5]$

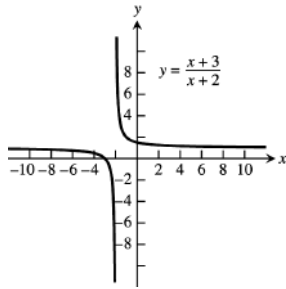

18. $[-5, 1]$ by $[-2, 4]$

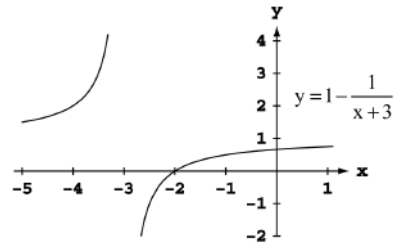

19. $[-4, 4]$ by $[0, 3]$

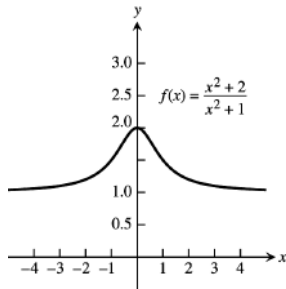

20. $[-5, 5]$ by $[-2, 2]$

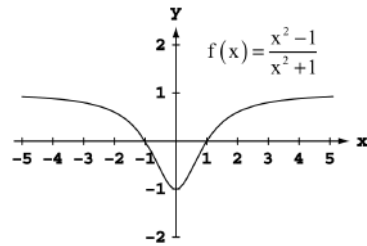

21. $[-10, 10]$ by $[-6, 6]$

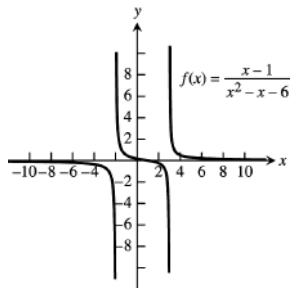

22. $[-5, 5]$ by $[-2, 2]$

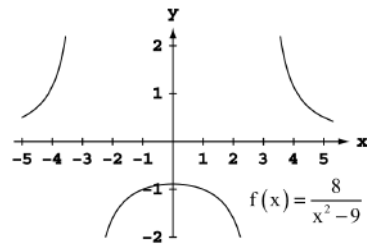

23. $[-6, 10]$ by $[-6, 6]$

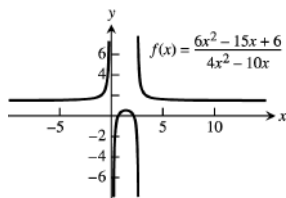

24. $[-3, 5]$ by $[-2, 10]$

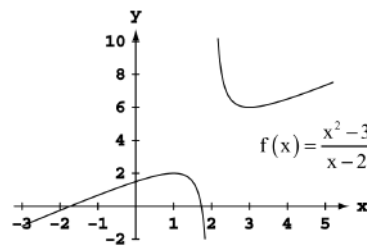

25. $[-0.03, 0.03]$ by $[-1.25, 1.25]$

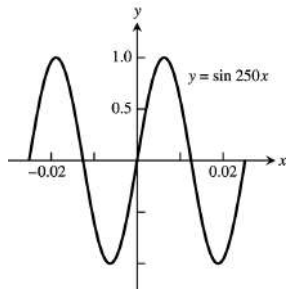

26. $[-0.1, 0.1]$ by $[-3, 3]$

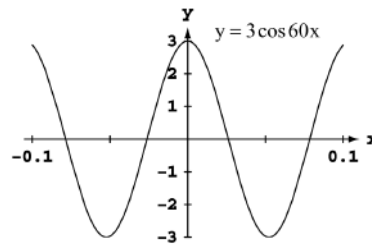

27. $[-300, 300]$ by $[-1.25, 1.25]$

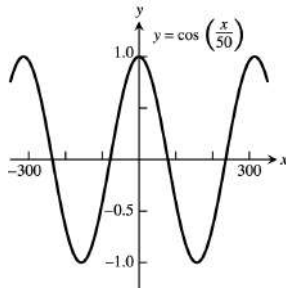

28. $[-50, 50]$ by $[-0.1, 0.1]$

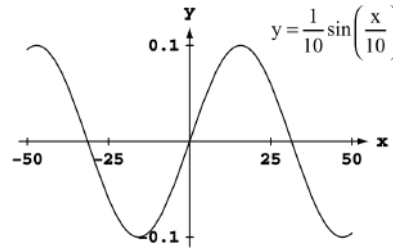

29. $[-0.25, 0.25]$ by $[-0.3, 0.3]$

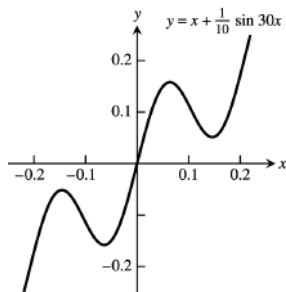

30. $[-0.15, 0.15]$ by $[-0.02, 0.05]$

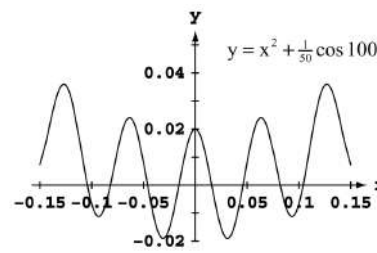

31. $x^2 + 2x = 4 + 4y - y^2 \Rightarrow y = 2 \pm \sqrt{-x^2 - 2x + 8}$.

The lower half is produced by graphing

$$y = 2 - \sqrt{-x^2 - 2x + 8}.$$

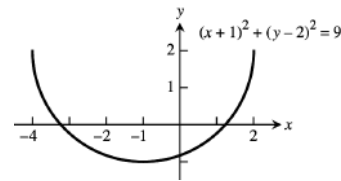

32. $y^2 - 16x^2 = 1 \Rightarrow y = \pm \sqrt{1 + 16x^2}$. The upper branch is produced by graphing $y = \sqrt{1 + 16x^2}$.

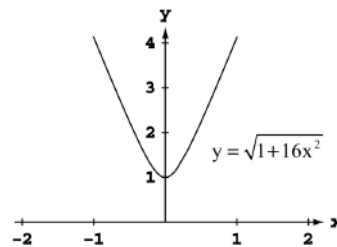

33.

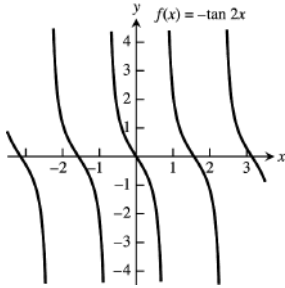

34.

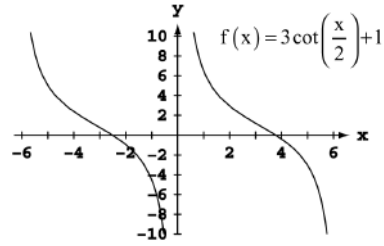

35.

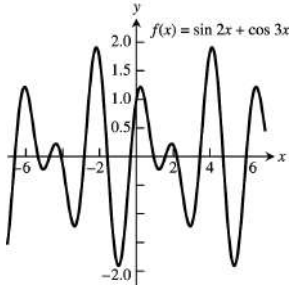

36.

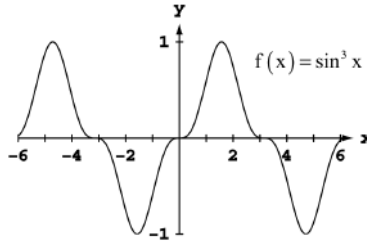

37.

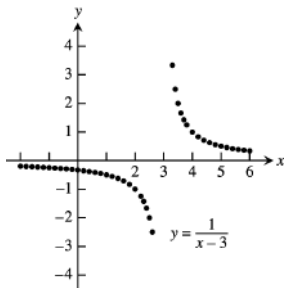

38.

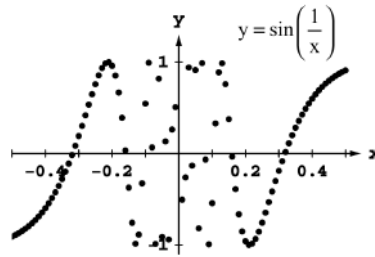

39.

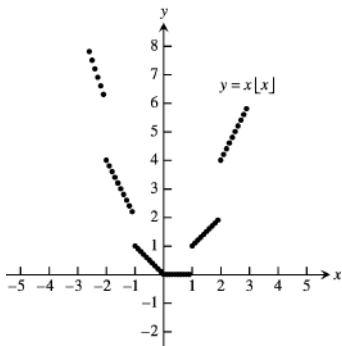

40.

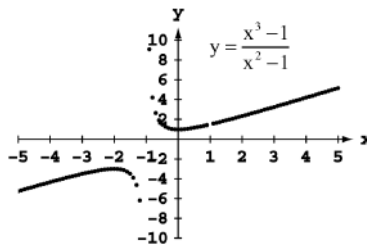

41. (a) $y = 1059.14x - 2074972$

(b) $m = 1059.14$ dollars/year, which is the yearly increase in compensation.

(c)

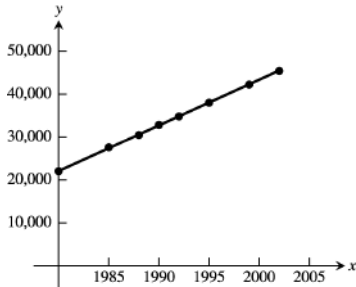

(d) Answers may vary slightly. $y = (1059.14)(2010) - 2074972 = \$53,899$

42. (a) Let $C =$ cost and $x =$ year.

$$C = (7960.71)x - 1.6 \times 10^7$$

(b) Slope represents increase in cost per year

(c) $C = (2637.14)x - 5.2 \times 10^6$

(d) The median price is rising faster in the northeast (the slope is larger).

43. (a) Let x represent the speed in miles per hour and d the stopping distance in feet. The quadratic regression function is

$$d = 0.0866x^2 - 1.97x + 50.1.$$

(b)

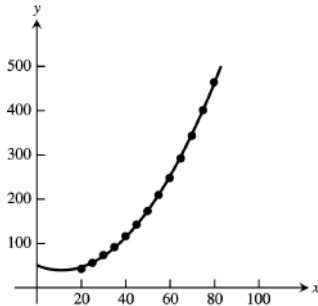

(c) From the graph in part (b), the stopping distance is about 370 feet when the vehicle is 72 mph and it is about 525 feet when the speed is 85 mph.

Algebraically: $d_{\text{quadratic}}(72) = 0.0866(72)^2 - 1.97(72) + 50.1 = 367.6$ ft.

$$d_{\text{quadratic}}(85) = 0.0866(85)^2 - 1.97(85) + 50.1 = 522.8$$
 ft.

(d) The linear regression function is $d = 6.89x - 140.4 \Rightarrow d_{\text{linear}}(72) = 6.89(72) - 140.4 = 355.7$ ft and

$d_{\text{linear}}(85) = 6.89(85) - 140.4 = 445.2$ ft. The linear regression line is shown on the graph in part (b). The quadratic regression curve clearly gives the better fit.

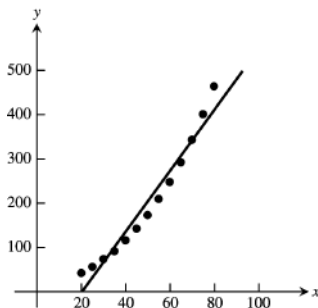

44. (a) The power regression function is $y = 4.44647x^{0.511414}$.

(b)

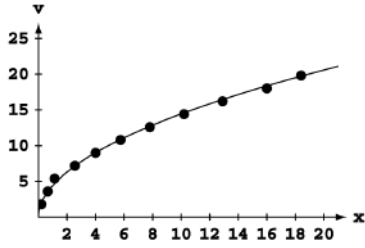

(c) 15.2 km/h

(d) The linear regression function is $y = 0.913675x + 4.189976$ and it is shown on the graph in part (b). The linear regression function gives a speed of 14.2 km/h when $y = 11$ m. The power regression curve in part (a) better fits the data.

CHAPTER 1 PRACTICE EXERCISES

1. $7 + 2x \geq 3 \Rightarrow 2x \geq -4 \Rightarrow x \geq -2$

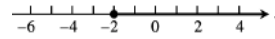

2. $-3x < 10 \Rightarrow x > -\frac{10}{3}$

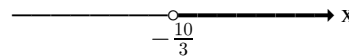

3. $\frac{1}{5}(x - 1) < \frac{1}{4}(x - 2) \Rightarrow 4(x - 1) < 5(x - 2)$
 $\Rightarrow 4x - 4 < 5x - 10 \Rightarrow 6 < x$

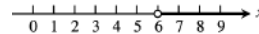

4. $\frac{x-3}{2} \geq -\frac{4+x}{3} \Rightarrow 3(x - 3) \geq -2(4 + x)$
 $\Rightarrow 3x - 9 \geq -8 - 2x \Rightarrow 5x \geq 1 \Rightarrow x \geq \frac{1}{5}$

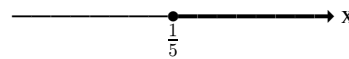

5. $|x + 1| = 7 \Rightarrow x + 1 = 7$ or $-(x + 1) = 7 \Rightarrow x = 6$ or $x = -8$

6. $|y - 3| < 4 \Rightarrow -4 < y - 3 < 4 \Rightarrow -1 < y < 7$

7. $\left|1 - \frac{x}{2}\right| > \frac{3}{2} \Rightarrow 1 - \frac{x}{2} < -\frac{3}{2}$ or $1 - \frac{x}{2} > \frac{3}{2} \Rightarrow -\frac{x}{2} < -\frac{5}{2}$ or $-\frac{x}{2} > \frac{1}{2} \Rightarrow -x < -5$ or $-x > 1$
 $\Rightarrow x > 5$ or $x < -1$

8. $\left|\frac{2x+7}{3}\right| \leq 5 \Rightarrow -5 \leq \frac{2x+7}{3} \leq 5 \Rightarrow -15 \leq 2x + 7 \leq 15 \Rightarrow -22 \leq 2x \leq 8 \Rightarrow -11 \leq x \leq 4$

9. Since the particle moved to the y-axis, $-2 + \Delta x = 0 \Rightarrow \Delta x = 2$. Since $\Delta y = 3\Delta x = 6$, the new coordinates are $(x + \Delta x, y + \Delta y) = (-2 + 2, 5 + 6) = (0, 11)$.

10. (a)

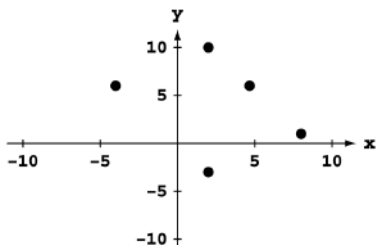

(b)

<u>line</u>	<u>slope</u>
AB	$\frac{10-1}{2-8} = \frac{9}{-6} = -\frac{3}{2}$
BC	$\frac{10-6}{2-(-4)} = \frac{4}{6} = \frac{2}{3}$
CD	$\frac{6-(-3)}{-4-2} = \frac{9}{-6} = -\frac{3}{2}$
DA	$\frac{1-(-3)}{8-2} = \frac{4}{6} = \frac{2}{3}$
CE	$\frac{6-6}{-4-\frac{14}{3}} = 0$

BD is vertical and has no slope

(c) Yes; A, B, C and D form a parallelogram.

(d) Yes. The line AB has equation $y - 1 = -\frac{3}{2}(x - 8)$. Replacing x by $\frac{14}{3}$ gives $y = -\frac{3}{2}\left(\frac{14}{3} - 8\right) + 1 = -\frac{3}{2}\left(-\frac{10}{3}\right) + 1 = 5 + 1 = 6$. Thus, $E\left(\frac{14}{3}, 6\right)$ lies on the line AB and the points A, B and E are collinear.

(e) The line CD has equation $y + 3 = -\frac{3}{2}(x - 2)$ or $y = -\frac{3}{2}x$. Thus the line passes through the origin.

11. The triangle ABC is neither an isosceles triangle nor is it a right triangle. The lengths of AB, BC and AC are $\sqrt{53}$, $\sqrt{72}$ and $\sqrt{65}$, respectively. The slopes of AB, BC and AC are $\frac{7}{2}$, -1 and $\frac{1}{8}$, respectively.

12. $P(x, 3x + 1)$ is a point on the line $y = 3x + 1$. If the distance from P to $(0, 0)$ equals the distance from P to $(-3, 4)$, then $x^2 + (3x + 1)^2 = (x + 3)^2 + (3 - 3x)^2 \Rightarrow x^2 + 9x^2 + 6x + 1 = x^2 + 6x + 9 + 9 - 18x + 9x^2 \Rightarrow 18x = 17$ or $x = \frac{17}{18} \Rightarrow y = 3x + 1 = 3\left(\frac{17}{18}\right) + 1 = \frac{23}{6}$. Thus the point is $P\left(\frac{17}{18}, \frac{23}{6}\right)$.

13. $y = 3(x - 1) + (-6) \Rightarrow y = 3x - 9$

14. $y = -\frac{1}{2}(x + 1) + 2 \Rightarrow y = -\frac{1}{2}x + \frac{3}{2}$

15. $x = 0$

16. $m = \frac{-2-6}{1-(-3)} = \frac{-8}{4} = -2 \Rightarrow y = -2(x + 3) + 6 \Rightarrow y = -2x$

17. $y = 2$

18. $m = \frac{5-3}{-2-3} = \frac{2}{-5} = -\frac{2}{5} \Rightarrow y = -\frac{2}{5}(x - 3) + 3 \Rightarrow y = -\frac{2}{5}x + \frac{21}{5}$

19. $y = -3x + 3$

20. Since $2x - y = -2$ is equivalent to $y = 2x + 2$, the slope of the given line (and hence the slope of the desired line) is 2.
 $y = 2(x - 1) + 1 \Rightarrow y = 2x - 5$

21. Since $4x + 3y = 12$ is equivalent to $y = -\frac{4}{3}x + 4$, the slope of the given line (and hence the slope of the desired line) is $-\frac{4}{3}$.
 $y = -\frac{4}{3}(x - 4) - 12 \Rightarrow y = -\frac{4}{3}x - \frac{20}{3}$

22. Since $3x - 5y = 1$ is equivalent to $y = \frac{3}{5}x - \frac{1}{5}$, the slope of the given line is $\frac{3}{5}$ and the slope of the perpendicular line is $-\frac{5}{3}$.
 $y = -\frac{5}{3}(x + 2) - 3 \Rightarrow y = -\frac{5}{3}x - \frac{19}{3}$

23. Since $\frac{1}{2}x + \frac{1}{3}y = 1$ is equivalent to $y = -\frac{3}{2}x + 3$, the slope of the given line is $-\frac{3}{2}$ and the slope of the perpendicular line is $\frac{2}{3}$.
 $y = \frac{2}{3}(x + 1) + 2 \Rightarrow y = \frac{2}{3}x + \frac{8}{3}$

24. The line passes through $(0, -5)$ and $(3, 0)$. $m = \frac{0-(-5)}{3-0} = \frac{5}{3} \Rightarrow y = \frac{5}{3}x - 5$

25. The area is $A = \pi r^2$ and the circumference is $C = 2\pi r$. Thus, $r = \frac{C}{2\pi} \Rightarrow A = \pi\left(\frac{C}{2\pi}\right)^2 = \frac{C^2}{4\pi}$.

26. The surface area is $S = 4\pi r^2 \Rightarrow r = \left(\frac{S}{4\pi}\right)^{1/2}$. The volume is $V = \frac{4}{3}\pi r^3 \Rightarrow r = \sqrt[3]{\frac{3V}{4\pi}}$. Substitution into the formula for surface area gives $S = 4\pi r^2 = 4\pi\left(\frac{3V}{4\pi}\right)^{2/3}$.

27. The coordinates of a point on the parabola are (x, x^2) . The angle of inclination θ joining this point to the origin satisfies the equation $\tan \theta = \frac{x^2}{x} = x$. Thus the point has coordinates $(x, x^2) = (\tan \theta, \tan^2 \theta)$.

28. $\tan \theta = \frac{\text{rise}}{\text{run}} = \frac{h}{500} \Rightarrow h = 500 \tan \theta$ ft.

29.

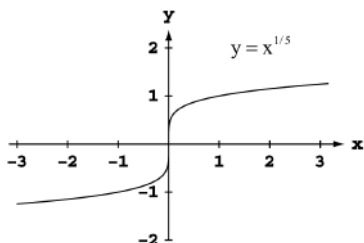

Symmetric about the origin.

30.

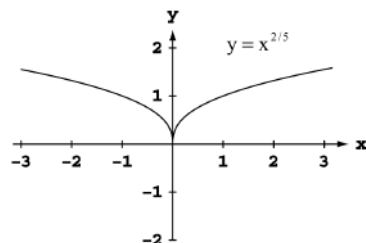

Symmetric about the y-axis.

31.

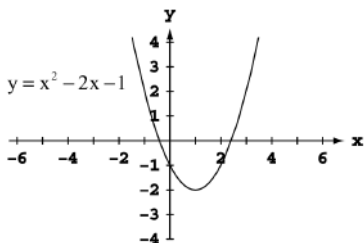

Neither

32.

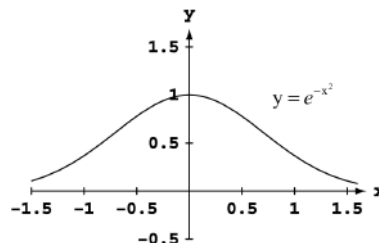

Symmetric about the y-axis.

33. $y(-x) = (-x)^2 + 1 = x^2 + 1 = y(x)$. Even.

34. $y(-x) = (-x)^5 - (-x)^3 - (-x) = -x^5 + x^3 + x = -y(x)$. Odd.

35. $y(-x) = 1 - \cos(-x) = 1 - \cos x = y(x)$. Even.

36. $y(-x) = \sec(-x) \tan(-x) = \frac{\sin(-x)}{\cos^2(-x)} = \frac{-\sin x}{\cos^2 x} = -\sec x \tan x = -y(x)$. Odd.

37. $y(-x) = \frac{(-x)^4 + 1}{(-x)^3 - 2(-x)} = \frac{x^4 + 1}{-x^3 + 2x} = -\frac{x^4 + 1}{x^3 - 2x} = -y(x)$. Odd.

38. $y(-x) = 1 - \sin(-x) = 1 + \sin x$. Neither even nor odd.

39. $y(-x) = -x + \cos(-x) = -x + \cos x$. Neither even nor odd.

40. $y(-x) = \sqrt{(-x)^4 - 1} = \sqrt{x^4 - 1} = y(x)$. Even.

56 Chapter 1 Preliminaries

41. (a) The function is defined for all values of x , so the domain is $(-\infty, \infty)$.
 (b) Since $|x|$ attains all nonnegative values, the range is $[-2, \infty)$.
42. (a) Since the square root requires $1 - x \geq 0$, the domain is $(-\infty, 1]$.
 (b) Since $\sqrt{1 - x}$ attains all nonnegative values, the range is $[-2, \infty)$.
43. (a) Since the square root requires $16 - x^2 \geq 0$, the domain is $[-4, 4]$.
 (b) For values of x in the domain, $0 \leq 16 - x^2 \leq 16$, so $0 \leq \sqrt{16 - x^2} \leq 4$. The range is $[0, 4]$.
44. (a) The function is defined for all values of x , so the domain is $(-\infty, \infty)$.
 (b) Since 3^{2-x} attains all positive values, the range is $(1, \infty)$.
45. (a) The function is defined for all values of x , so the domain is $(-\infty, \infty)$.
 (b) Since $2e^{-x}$ attains all positive values, the range is $(-3, \infty)$.
46. (a) The function is equivalent to $y = \tan 2x$, so we require $2x \neq \frac{k\pi}{2}$ for odd integers k . The domain is given by $x \neq \frac{k\pi}{4}$ for odd integers k .
 (b) Since the tangent function attains all values, the range is $(-\infty, \infty)$.
47. (a) The function is defined for all values of x , so the domain is $(-\infty, \infty)$.
 (b) The sine function attains values from -1 to 1 , so $-2 \leq 2\sin(3x + \pi) \leq 2$ and hence $-3 \leq 2\sin(3x + \pi) - 1 \leq 1$. The range is $[-3, 1]$.
48. (a) The function is defined for all values of x , so the domain is $(-\infty, \infty)$.
 (b) The function is equivalent to $y = \sqrt[5]{x^2}$, which attains all nonnegative values. The range is $[0, \infty)$.
49. (a) The logarithm requires $x - 3 > 0$, so the domain is $(3, \infty)$.
 (b) The logarithm attains all real values, so the range is $(-\infty, \infty)$.
50. (a) The function is defined for all values of x , so the domain is $(-\infty, \infty)$.
 (b) The cube root attains all real values, so the range is $(-\infty, \infty)$.
51. (a) The function is defined for $-4 \leq x \leq 4$, so the domain is $[-4, 4]$.
 (b) The function is equivalent to $y = \sqrt{|x|}$, $-4 \leq x \leq 4$, which attains values from 0 to 2 for x in the domain. The range is $[0, 2]$.
52. (a) The function is defined for $-2 \leq x \leq 2$, so the domain is $[-2, 2]$.
 (b) The range is $[-1, 1]$.

53. First piece: Line through $(0, 1)$ and $(1, 0)$. $m = \frac{0-1}{1-0} = \frac{-1}{1} = -1 \Rightarrow y = -x + 1 = 1 - x$
 Second piece: Line through $(1, 1)$ and $(2, 0)$. $m = \frac{0-1}{2-1} = \frac{-1}{1} = -1 \Rightarrow y = -(x - 1) + 1 = -x + 2 = 2 - x$

$$f(x) = \begin{cases} 1 - x, & 0 \leq x < 1 \\ 2 - x, & 1 \leq x \leq 2 \end{cases}$$

54. First piece: Line through $(0, 0)$ and $(2, 5)$. $m = \frac{5-0}{2-0} = \frac{5}{2} \Rightarrow y = \frac{5}{2}x$
 Second piece: Line through $(2, 5)$ and $(4, 0)$. $m = \frac{0-5}{4-2} = \frac{-5}{2} = -\frac{5}{2} \Rightarrow y = -\frac{5}{2}(x - 2) + 5 = -\frac{5}{2}x + 10 = 10 - \frac{5x}{2}$

$$f(x) = \begin{cases} \frac{5}{2}x, & 0 \leq x < 2 \\ 10 - \frac{5x}{2}, & 2 \leq x \leq 4 \end{cases} \quad (\text{Note: } x = 2 \text{ can be included on either piece.})$$

55. (a) $(f \circ g)(-1) = f(g(-1)) = f\left(\frac{1}{\sqrt{-1+2}}\right) = f(1) = \frac{1}{1} = 1$
 (b) $(g \circ f)(2) = g(f(2)) = g\left(\frac{1}{2}\right) = \frac{1}{\sqrt{\frac{1}{2}+2}} = \frac{1}{\sqrt{2.5}}$ or $\sqrt{\frac{2}{5}}$
 (c) $(f \circ f)(x) = f(f(x)) = f\left(\frac{1}{x}\right) = \frac{1}{1/x} = x, x \neq 0$
 (d) $(g \circ g)(x) = g(g(x)) = g\left(\frac{1}{\sqrt{x+2}}\right) = \frac{1}{\sqrt{\frac{1}{\sqrt{x+2}}+2}} = \frac{\sqrt[4]{x+2}}{\sqrt{1+2\sqrt{x+2}}}$

56. (a) $(f \circ g)(-1) = f(g(-1)) = f(\sqrt[3]{-1+1}) = f(0) = 2 - 0 = 2$
 (b) $(g \circ f)(2) = f(g(2)) = g(2-2) = g(0) = \sqrt[3]{0+1} = 1$
 (c) $(f \circ f)(x) = f(f(x)) = f(2-x) = 2 - (2-x) = x$
 (d) $(g \circ g)(x) = g(g(x)) = g(\sqrt[3]{x+1}) = \sqrt[3]{\sqrt[3]{x+1}+1}$

57. (a) $(f \circ g)(x) = f(g(x)) = f(\sqrt{x+2}) = 2 - (\sqrt{x+2})^2 = -x, x \geq -2$.
 $(g \circ f)(x) = f(g(x)) = g(2-x^2) = \sqrt{(2-x^2)+2} = \sqrt{4-x^2}$
 (b) Domain of $f \circ g$: $[-2, \infty)$.
 Domain of $g \circ f$: $[-2, 2]$.
 (c) Range of $f \circ g$: $(-\infty, 2]$.
 Range of $g \circ f$: $[0, 2]$.

58. (a) $(f \circ g)(x) = f(g(x)) = f(\sqrt{1-x}) = \sqrt{\sqrt{1-x}} = \sqrt[4]{1-x}$.
 $(g \circ f)(x) = f(g(x)) = g(\sqrt{x}) = \sqrt{1-\sqrt{x}}$
 (b) Domain of $f \circ g$: $(-\infty, 1]$.
 Domain of $g \circ f$: $[0, 1]$.
 (c) Range of $f \circ g$: $[0, \infty)$.
 Range of $g \circ f$: $[0, 1]$.

59.

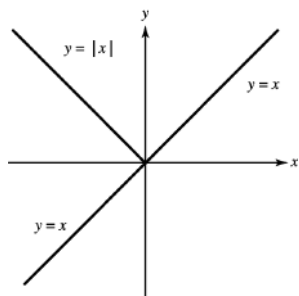

The graph of $f_2(x) = f_1(|x|)$ is the same as the graph of $f_1(x)$ to the right of the y -axis. The graph of $f_2(x)$ to the left of the y -axis is the reflection of $y = f_1(x), x \geq 0$ across the y -axis.

60.

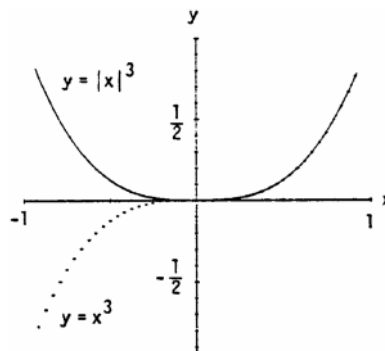

The graph of $f_2(x) = f_1(|x|)$ is the same as the graph of $f_1(x)$ to the right of the y -axis. The graph of $f_2(x)$ to the left of the y -axis is the reflection of $y = f_1(x), x \geq 0$ across the y -axis.

61.

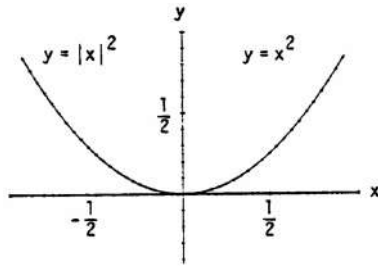

It does not change the graph.

62.

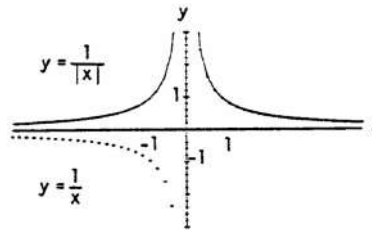

The graph of $f_2(x) = f_1(|x|)$ is the same as the graph of $f_1(x)$ to the right of the y -axis. The graph of $f_2(x)$ to the left of the y -axis is the reflection of $y = f_1(x)$, $x \geq 0$ across the y -axis.

63.

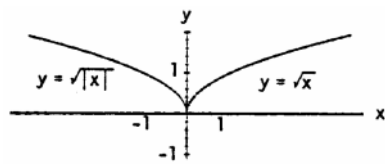

The graph of $f_2(x) = f_1(|x|)$ is the same as the graph of $f_1(x)$ to the right of the y -axis. The graph of $f_2(x)$ to the left of the y -axis is the reflection of $y = f_1(x)$, $x \geq 0$ across the y -axis.

64.

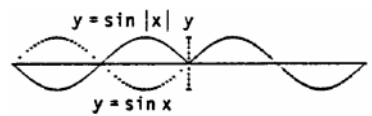

The graph of $f_2(x) = f_1(|x|)$ is the same as the graph of $f_1(x)$ to the right of the y -axis. The graph of $f_2(x)$ to the left of the y -axis is the reflection of $y = f_1(x)$, $x \geq 0$ across the y -axis.

65.

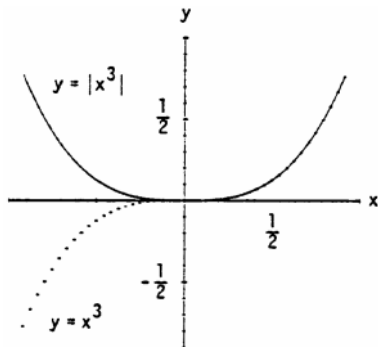

Whenever $g_1(x)$ is positive, the graph of $y = g_2(x) = |g_1(x)|$ is the same as the graph of $y = g_1(x)$. When $g_1(x)$ is negative, the graph of $y = g_2(x)$ is the reflection of the graph of $y = g_1(x)$ across the x -axis.

66.

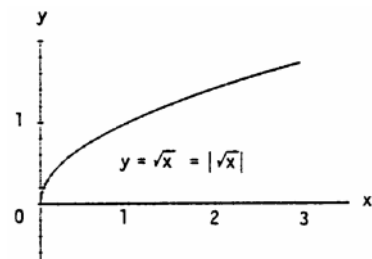

It does not change the graph.

67.

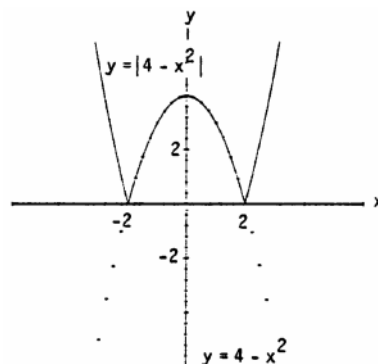

Whenever $g_1(x)$ is positive, the graph of $y = g_2(x) = |g_1(x)|$ is the same as the graph of $y = g_1(x)$. When $g_1(x)$ is negative, the graph of $y = g_2(x)$ is the reflection of the graph of $y = g_1(x)$ across the x -axis.

68.

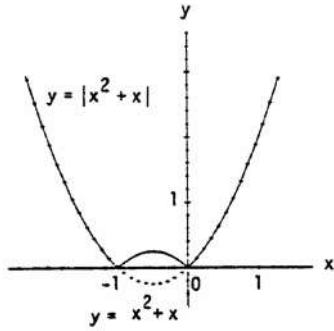

Whenever $g_1(x)$ is positive, the graph of $y = g_2(x) = |g_1(x)|$ is the same as the graph of $y = g_1(x)$. When $g_1(x)$ is negative, the graph of $y = g_2(x)$ is the reflection of the graph of $y = g_1(x)$ across the x -axis.

69.

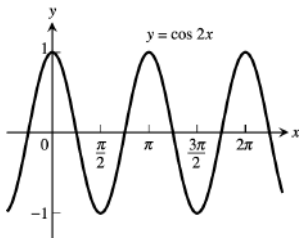

period = π

70.

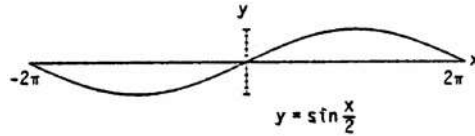

period = 4π

71.

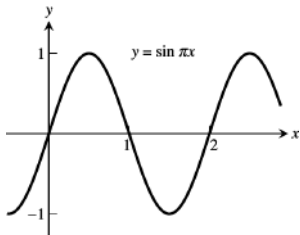

period = 2

72.

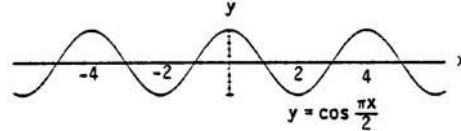

period = 4

73.

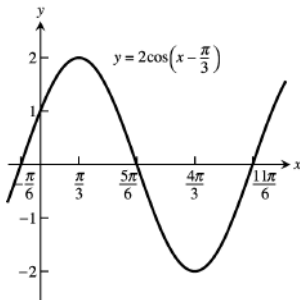

period = 2π

74.

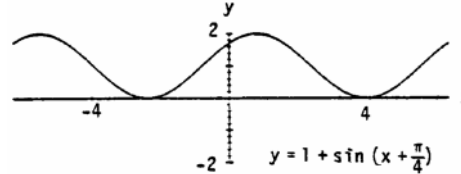

period = 2π

75. (a) $\sin B = \sin \frac{\pi}{3} = \frac{b}{c} = \frac{b}{2} \Rightarrow b = 2 \sin \frac{\pi}{3} = 2 \left(\frac{\sqrt{3}}{2} \right) = \sqrt{3}$. By the theorem of Pythagoras,
 $a^2 + b^2 = c^2 \Rightarrow a = \sqrt{c^2 - b^2} = \sqrt{4 - 3} = 1$.

(b) $\sin B = \sin \frac{\pi}{3} = \frac{b}{c} = \frac{2}{c} \Rightarrow c = \frac{2}{\sin \frac{\pi}{3}} = \frac{2}{(\frac{\sqrt{3}}{2})} = \frac{4}{\sqrt{3}}$. Thus, $a = \sqrt{c^2 - b^2} = \sqrt{\left(\frac{4}{\sqrt{3}}\right)^2 - (2)^2} = \sqrt{\frac{16}{3} - 4} = \sqrt{\frac{4}{3}} = \frac{2}{\sqrt{3}}$.

76. (a) $\sin A = \frac{a}{c} \Rightarrow a = c \sin A$

(b) $\tan A = \frac{a}{b} \Rightarrow a = b \tan A$

77. (a) $\tan B = \frac{b}{a} \Rightarrow a = \frac{b}{\tan B}$

(b) $\sin A = \frac{a}{c} \Rightarrow c = \frac{a}{\sin A}$

78. (a) $\sin A = \frac{a}{c}$

(c) $\sin A = \frac{a}{c} = \frac{\sqrt{c^2 - b^2}}{c}$

79. Let h = height of vertical pole, and let b and c denote the distances of points B and C from the base of the pole, measured along the flatground, respectively. Then, $\tan 50^\circ = \frac{h}{c}$, $\tan 35^\circ = \frac{h}{b}$, and $b - c = 10$.

Thus, $h = c \tan 50^\circ$ and $h = b \tan 35^\circ = (c + 10) \tan 35^\circ$
 $\Rightarrow c \tan 50^\circ = (c + 10) \tan 35^\circ$
 $\Rightarrow c (\tan 50^\circ - \tan 35^\circ) = 10 \tan 35^\circ$
 $\Rightarrow c = \frac{10 \tan 35^\circ}{\tan 50^\circ - \tan 35^\circ} \Rightarrow h = c \tan 50^\circ$
 $= \frac{10 \tan 35^\circ \tan 50^\circ}{\tan 50^\circ - \tan 35^\circ} \approx 16.98 \text{ m.}$

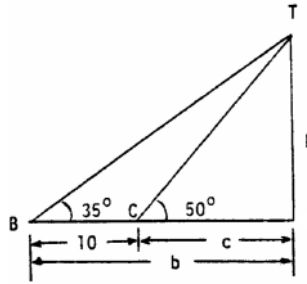

80. Let h = height of balloon above ground. From the figure at the right, $\tan 40^\circ = \frac{h}{a}$, $\tan 70^\circ = \frac{h}{b}$, and $a + b = 2$. Thus, $h = b \tan 70^\circ \Rightarrow h = (2 - a) \tan 70^\circ$ and $h = a \tan 40^\circ$
 $\Rightarrow (2 - a) \tan 70^\circ = a \tan 40^\circ \Rightarrow a(\tan 40^\circ + \tan 70^\circ)$
 $= 2 \tan 70^\circ \Rightarrow a = \frac{2 \tan 70^\circ}{\tan 40^\circ + \tan 70^\circ} \Rightarrow h = a \tan 40^\circ$
 $= \frac{2 \tan 70^\circ \tan 40^\circ}{\tan 40^\circ + \tan 70^\circ} \approx 1.3 \text{ km.}$

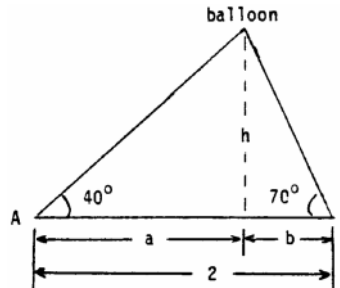

81. (a)

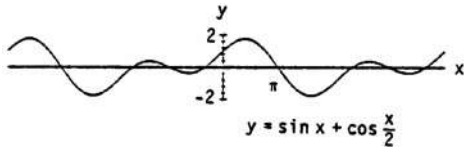

(b) The period appears to be 4π .

(c) $f(x + 4\pi) = \sin(x + 4\pi) + \cos\left(\frac{x+4\pi}{2}\right) = \sin(x + 2\pi) + \cos\left(\frac{x}{2} + 2\pi\right) = \sin x + \cos \frac{x}{2}$
 since the period of sine and cosine is 2π . Thus, $f(x)$ has period 4π .

82. (a)

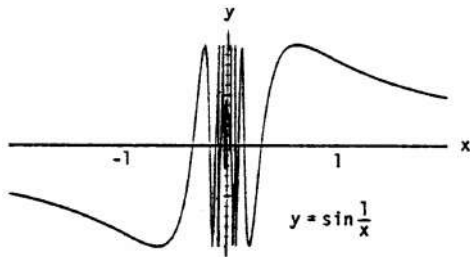

(b) $D = (-\infty, 0) \cup (0, \infty)$; $R = [-1, 1]$

(c) f is not periodic. For suppose f has period p . Then $f\left(\frac{1}{2\pi} + kp\right) = f\left(\frac{1}{2\pi}\right) = \sin 2\pi = 0$ for all integers k . Choose k so large that $\frac{1}{2\pi} + kp > \frac{1}{\pi} \Rightarrow 0 < \frac{1}{(1/2\pi) + kp} < \pi$. But then $f\left(\frac{1}{2\pi} + kp\right) = \sin\left(\frac{1}{(1/2\pi) + kp}\right) > 0$ which is a contradiction. Thus f has no period, as claimed.

CHAPTER 1 ADDITIONAL AND ADVANCED EXERCISES

1. (a) The given graph is reflected about the y-axis.

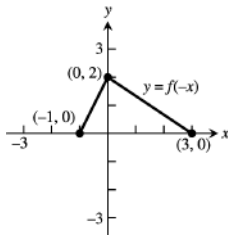

- (b) The given graph is reflected about the x-axis.

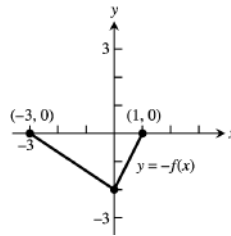

- (c) The given graph is shifted left 1 unit, stretched vertically by a factor of 2, reflected about the x-axis, and then shifted upward 1 unit.

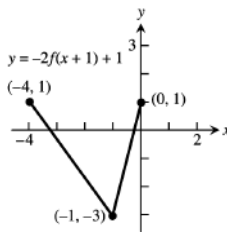

- (d) The given graph is shifted right 2 units, stretched vertically by a factor of 3, and then shifted downward 2 units.

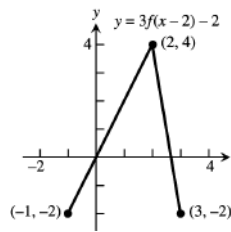

2. (a)

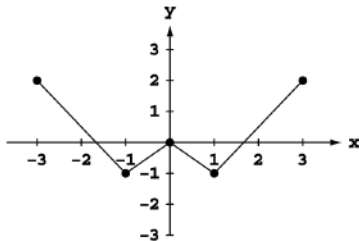

- (b)

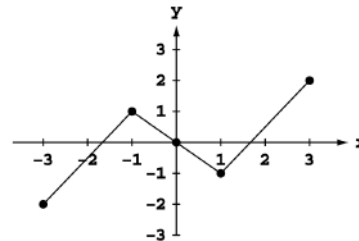

3. There are (infinitely) many such function pairs. For example,
- $f(x) = 3x$
- and
- $g(x) = 4x$
- satisfy
- $f(g(x)) = f(4x) = 3(4x) = 12x = 4(3x) = g(3x) = g(f(x))$
- .

4. Yes, there are many such function pairs. For example, if
- $g(x) = (2x + 3)^3$
- and
- $f(x) = x^{1/3}$
- , then
- $(f \circ g)(x) = f(g(x)) = f((2x + 3)^3) = ((2x + 3)^3)^{1/3} = 2x + 3$
- .

5. If
- f
- is odd and defined at
- x
- , then
- $f(-x) = -f(x)$
- . Thus
- $g(-x) = f(-x) - 2 = -f(x) - 2$
- whereas
- $-g(x) = -(f(x) - 2) = -f(x) + 2$
- . Then
- g
- cannot be odd because
- $g(-x) = -g(x) \Rightarrow -f(x) - 2 = -f(x) + 2 \Rightarrow 4 = 0$
- , which is a contradiction. Also,
- $g(x)$
- is not even unless
- $f(x) = 0$
- for all
- x
- . On the other hand, if
- f
- is even, then
- $g(x) = f(x) - 2$
- is also even:
- $g(-x) = f(-x) - 2 = f(x) - 2 = g(x)$
- .

6. If
- g
- is odd and
- $g(0)$
- is defined, then
- $g(0) = g(-0) = -g(0)$
- . Therefore,
- $2g(0) = 0 \Rightarrow g(0) = 0$
- .

7. For (x, y) in the 1st quadrant, $|x| + |y| = 1 + x$
 $\Leftrightarrow x + y = 1 + x \Leftrightarrow y = 1$. For (x, y) in the 2nd quadrant, $|x| + |y| = x + 1 \Leftrightarrow -x + y = x + 1$
 $\Leftrightarrow y = 2x + 1$. In the 3rd quadrant, $|x| + |y| = x + 1$
 $\Leftrightarrow -x - y = x + 1 \Leftrightarrow y = -2x - 1$. In the 4th quadrant, $|x| + |y| = x + 1 \Leftrightarrow x + (-y) = x + 1$
 $\Leftrightarrow y = -1$. The graph is given at the right.

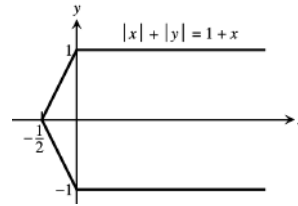

8. We use reasoning similar to Exercise 7.

- (1) 1st quadrant: $y + |y| = x + |x|$
 $\Leftrightarrow 2y = 2x \Leftrightarrow y = x$.
- (2) 2nd quadrant: $y + |y| = x + |x|$
 $\Leftrightarrow 2y = x + (-x) = 0 \Leftrightarrow y = 0$.
- (3) 3rd quadrant: $y + |y| = x + |x|$
 $\Leftrightarrow y + (-y) = x + (-x) \Leftrightarrow 0 = 0$
 \Rightarrow all points in the 3rd quadrant satisfy the equation.
- (4) 4th quadrant: $y + |y| = x + |x|$
 $\Leftrightarrow y + (-y) = 2x \Leftrightarrow 0 = x$. Combining these results we have the graph given at the right:

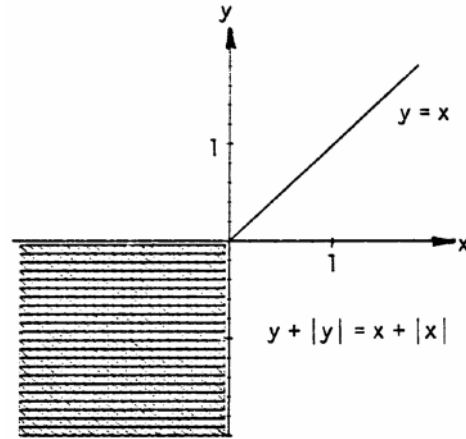

9. By the law of sines, $\frac{\sin \frac{\pi}{3}}{\sqrt{3}} = \frac{\sin A}{a} = \frac{\sin B}{b} = \frac{\sin \frac{\pi}{4}}{b} \Rightarrow b = \frac{\sqrt{3} \sin(\pi/4)}{\sin(\pi/3)} = \frac{\sqrt{3}(\frac{\sqrt{2}}{2})}{\frac{\sqrt{3}}{2}} = \sqrt{2}$.
10. By the law of sines, $\frac{\sin \frac{\pi}{4}}{4} = \frac{\sin A}{a} = \frac{\sin B}{b} = \frac{\sin B}{3} \Rightarrow \sin B = \frac{3}{4} \sin \frac{\pi}{4} = \frac{3}{4} \left(\frac{\sqrt{2}}{2} \right) = \frac{3\sqrt{2}}{8}$.
11. By the law of cosines, $a^2 = b^2 + c^2 - 2bc \cos A \Rightarrow \cos A = \frac{b^2 + c^2 - a^2}{2bc} = \frac{2^2 + 3^2 - 2^2}{2(2)(3)} = \frac{3}{4}$.
12. By the law of cosines, $c^2 = a^2 + b^2 - 2ab \cos C = 2^2 + 3^2 - (2)(2)(3) \cos \frac{\pi}{4} = 4 + 9 - 12 \left(\frac{\sqrt{2}}{2} \right) = 13 - 6\sqrt{2} \Rightarrow c = \sqrt{13 - 6\sqrt{2}}$, since $c > 0$.
13. By the law of cosines, $b^2 = a^2 + c^2 - 2ac \cos B \Rightarrow \cos B = \frac{a^2 + c^2 - b^2}{2ac} = \frac{2^2 + 4^2 - 3^2}{(2)(2)(4)} = \frac{4 + 16 - 9}{16} = \frac{11}{16}$. Since $0 < B < \pi$, $\sin B = \sqrt{1 - \cos^2 B} = \sqrt{1 - \frac{121}{256}} = \frac{\sqrt{135}}{16} = \frac{3\sqrt{15}}{16}$.
14. By the law of cosines, $c^2 = a^2 + b^2 - 2ab \cos C \Rightarrow \cos C = \frac{a^2 + b^2 - c^2}{2ab} = \frac{2^2 + 4^2 - 5^2}{(2)(2)(4)} = \frac{4 + 16 - 25}{16} = -\frac{5}{16}$. Since $0 < C < \pi$, $\sin C = \sqrt{1 - \cos^2 C} = \sqrt{1 - \frac{25}{256}} = \frac{\sqrt{231}}{16}$.
15. (a) $\sin^2 x + \cos^2 x = 1 \Rightarrow \sin^2 x = 1 - \cos^2 x = (1 - \cos x)(1 + \cos x) \Rightarrow (1 - \cos x) = \frac{\sin^2 x}{1 + \cos x}$
 $\Rightarrow \frac{1 - \cos x}{\sin x} = \frac{\sin x}{1 + \cos x}$
- (b) Using the definition of the tangent function and the double angle formulas, we have
 $\tan^2 \left(\frac{x}{2} \right) = \frac{\sin^2 \left(\frac{x}{2} \right)}{\cos^2 \left(\frac{x}{2} \right)} = \frac{\frac{1 - \cos x}{2}}{\frac{1 + \cos x}{2}} = \frac{1 - \cos x}{1 + \cos x}$.

16. The angles labeled γ in the accompanying figure are equal since both angles subtend arc CD. Similarly, the two angles labeled α are equal since they both subtend arc AB. Thus, triangles AED and BEC are similar which implies $\frac{a-c}{b} = \frac{2a \cos \theta - b}{a+c}$

$$\begin{aligned} \Rightarrow (a-c)(a+c) &= b(2a \cos \theta - b) \\ \Rightarrow a^2 - c^2 &= 2ab \cos \theta - b^2 \\ \Rightarrow c^2 &= a^2 + b^2 - 2ab \cos \theta. \end{aligned}$$

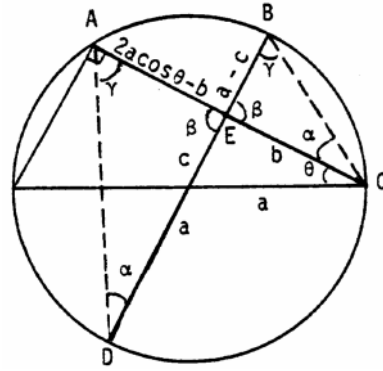

17. As in the proof of the law of sines of Section P.5, Exercise 57, $ah = bc \sin A = ab \sin C = ac \sin B$
 \Rightarrow the area of ABC = $\frac{1}{2}$ (base)(height) = $\frac{1}{2} ah = \frac{1}{2} bc \sin A = \frac{1}{2} ab \sin C = \frac{1}{2} ac \sin B$.

18. As in Section P.5, Exercise 57, $(\text{Area of ABC})^2 = \frac{1}{4} (\text{base})^2 (\text{height})^2 = \frac{1}{4} a^2 h^2 = \frac{1}{4} a^2 b^2 \sin^2 C$
 $= \frac{1}{4} a^2 b^2 (1 - \cos^2 C)$. By the law of cosines, $c^2 = a^2 + b^2 - 2ab \cos C \Rightarrow \cos C = \frac{a^2 + b^2 - c^2}{2ab}$.

$$\begin{aligned} \text{Thus, } (\text{area of ABC})^2 &= \frac{1}{4} a^2 b^2 (1 - \cos^2 C) = \frac{1}{4} a^2 b^2 \left(1 - \left(\frac{a^2 + b^2 - c^2}{2ab} \right)^2 \right) = \frac{a^2 b^2}{4} \left(1 - \frac{(a^2 + b^2 - c^2)^2}{4a^2 b^2} \right) \\ &= \frac{1}{16} (4a^2 b^2 - (a^2 + b^2 - c^2)^2) = \frac{1}{16} [(2ab + (a^2 + b^2 - c^2))(2ab - (a^2 + b^2 - c^2))] \\ &= \frac{1}{16} [(a+b)^2 - c^2)(c^2 - (a-b)^2)] = \frac{1}{16} [(a+b+c)(a+b-c)(c+(a-b))(c-(a-b))] \\ &= \left[\left(\frac{a+b+c}{2} \right) \left(\frac{-a+b+c}{2} \right) \left(\frac{a-b+c}{2} \right) \left(\frac{a+b-c}{2} \right) \right] = s(s-a)(s-b)(s-c), \text{ where } s = \frac{a+b+c}{2}. \end{aligned}$$

Therefore, the area of ABC equals $\sqrt{s(s-a)(s-b)(s-c)}$.

19. 1. $b+c-(a+c) = b-a$, which is positive since $a < b$. Thus, $a+c < b+c$.
 2. $b-c-(a-c) = b-a$, which is positive since $a < b$. Thus, $a-c < b-c$.
 3. $c > 0$ and $a < b \Rightarrow c-0 = c$ and $b-a$ are positive $\Rightarrow (b-a)c = bc - ac$ is positive $\Rightarrow ac < bc$.
 4. $a < b$ and $c < 0 \Rightarrow b-a$ and $-c$ are positive $\Rightarrow (b-a)(-c) = ac - bc$ is positive $\Rightarrow bc < ac$.
 5. Since $a > 0$, a and $\frac{1}{a}$ are positive $\Rightarrow \frac{1}{a} > 0$.
 6. Since $0 < a < b$, both $\frac{1}{a}$ and $\frac{1}{b}$ are positive. By (3), $a < b$ and $\frac{1}{a} > 0 \Rightarrow a\left(\frac{1}{a}\right) < b\left(\frac{1}{a}\right)$ or $1 < \frac{b}{a}$
 $\Rightarrow 1\left(\frac{1}{b}\right) < \frac{b}{a}\left(\frac{1}{b}\right)$ by (3) since $\frac{1}{b} > 0 \Rightarrow \frac{1}{b} < \frac{1}{a}$.
 7. $a < b < 0 \Rightarrow \frac{1}{a}$ and $\frac{1}{b}$ are both negative, i.e., $\frac{1}{a} < 0$ and $\frac{1}{b} < 0$. By (4), $a < b$ and $\frac{1}{a} < 0 \Rightarrow b\left(\frac{1}{a}\right) < a\left(\frac{1}{a}\right)$
 $\Rightarrow \frac{b}{a} < 1 \Rightarrow 1\left(\frac{1}{b}\right) < \frac{b}{a}\left(\frac{1}{b}\right)$ by (4) since $\frac{1}{b} < 0 \Rightarrow \frac{1}{b} < \frac{1}{a}$.

20. (a) If $a = 0$, then $0 = |a| < |b| \Leftrightarrow b \neq 0 \Leftrightarrow 0 = |a|^2 < |b|^2$. Since $|a|^2 = |a||a| = |a^2| = a^2$ and $|b|^2 = b^2$ we obtain $a^2 < b^2$. If $a \neq 0$ then $|a| > 0$ and $|a| < |b| \Rightarrow a^2 < b^2$. On the other hand, if $a^2 < b^2$ then $a^2 = |a|^2 < |b|^2 = b^2 \Rightarrow 0 < |b|^2 - |a|^2 = (|b| - |a|)(|b| + |a|)$. Since $(|b| + |a|) > 0$ and the product $(|b| - |a|)(|b| + |a|)$ is positive, we must have $(|b| - |a|) > 0 \Rightarrow |b| > |a|$. Thus $|a| < |b| \Leftrightarrow a^2 < b^2$.
 (b) $ab \leq |ab| \Rightarrow -ab \geq -2|ab|$ by Exercise 19(4) above $\Rightarrow a^2 - 2ab + b^2 \geq |a|^2 - 2|a||b| + |b|^2$, since $|a|^2 = a^2$ and $|b|^2 = b^2$. Factoring both sides, $(a-b)^2 \geq (|a| - |b|)^2 \Rightarrow |a-b| \geq ||a| - |b||$, by part (a).

21. The fact that $|a_1 + a_2 + \dots + a_n| \leq |a_1| + |a_2| + \dots + |a_n|$ holds for $n = 1$ is obvious. It also holds for $n = 2$ by the triangle inequality. We now show it holds for all positive integers n , by induction.

Suppose it holds for $n = k \geq 1$: $|a_1 + a_2 + \dots + a_k| \leq |a_1| + |a_2| + \dots + |a_k|$ (this is the induction hypothesis). Then $|a_1 + a_2 + \dots + a_k + a_{k+1}| = |(a_1 + a_2 + \dots + a_k) + a_{k+1}| \leq |a_1 + a_2 + \dots + a_k| + |a_{k+1}|$ (by the triangle inequality) $\leq |a_1| + |a_2| + \dots + |a_k| + |a_{k+1}|$ (by the induction hypothesis) and the inequality holds for $n = k + 1$. Hence it holds for all n by induction.

22. The fact that $|a_1 + a_2 + \dots + a_n| \geq |a_1| - |a_2| - \dots - |a_n|$ holds for $n = 1$ is obvious. It holds for $n = 2$ by Exercise 21(b), since $|a_1 + a_2| = |a_1 - (-a_2)| \geq ||a_1| - |-a_2|| = ||a_1| - |a_2|| \geq |a_1| - |a_2|$.

We now show it holds for all positive integers n by induction.

Suppose the inequality holds for $n = k \geq 1$. Then $|a_1 + a_2 + \dots + a_k| \geq |a_1| - |a_2| - \dots - |a_k|$ (this is the induction hypothesis). Thus $|a_1 + \dots + a_k + a_{k+1}| = |(a_1 + \dots + a_k) - (-a_{k+1})| \geq ||(a_1 + \dots + a_k)| - |-a_{k+1}||$ (by Exercise 21(b)) $= ||a_1 + \dots + a_k| - |a_{k+1}|| \geq |a_1 + \dots + a_k| - |a_{k+1}| \geq |a_1| - |a_2| - \dots - |a_k| - |a_{k+1}|$ (by the induction hypothesis). Hence the inequality holds for all n by induction.

23. If f is even and odd, then $f(-x) = -f(x)$ and $f(-x) = f(x) \Rightarrow f(x) = -f(x)$ for all x in the domain of f . Thus $2f(x) = 0 \Rightarrow f(x) = 0$.

24. (a) As suggested, let $E(x) = \frac{f(x)+f(-x)}{2} \Rightarrow E(-x) = \frac{f(-x)+f(-(-x))}{2} = \frac{f(-x)+f(x)}{2} = E(x) \Rightarrow E$ is an even function. Define $O(x) = f(x) - E(x) = f(x) - \frac{f(x)+f(-x)}{2} = \frac{f(x)-f(-x)}{2}$. Then

$$O(-x) = \frac{f(-x)-f(-(-x))}{2} = \frac{f(-x)-f(x)}{2} = -\left(\frac{f(x)-f(-x)}{2}\right) = -O(x) \Rightarrow O \text{ is an odd function}$$

$\Rightarrow f(x) = E(x) + O(x)$ is the sum of an even and an odd function.

- (b) Part (a) shows that $f(x) = E(x) + O(x)$ is the sum of an even and an odd function. If also $f(x) = E_1(x) + O_1(x)$, where E_1 is even and O_1 is odd, then $f(x) - f(x) = 0 = (E_1(x) + O_1(x)) - (E(x) + O(x))$. Thus, $E(x) - E_1(x) = O_1(x) - O(x)$ for all x in the domain of f (which is the same as the domain of $E - E_1$ and $O - O_1$). Now $(E - E_1)(-x) = E(-x) - E_1(-x) = E(x) - E_1(x)$ (since E and E_1 are even) $= (E - E_1)(x) \Rightarrow E - E_1$ is even. Likewise, $(O_1 - O)(-x) = O_1(-x) - O(-x) = -O_1(x) - (-O(x))$ (since O and O_1 are odd) $= -(O_1(x) - O(x)) = -(O_1 - O)(x) \Rightarrow O_1 - O$ is odd. Therefore, $E - E_1$ and $O_1 - O$ are both even and odd so they must be zero at each x in the domain of f by Exercise 23. That is, $E_1 = E$ and $O_1 = O$, so the decomposition of f found in part (a) is unique.

25. $y = ax^2 + bx + c = a\left(x^2 + \frac{b}{a}x + \frac{b^2}{4a^2}\right) - \frac{b^2}{4a} + c = a\left(x + \frac{b}{2a}\right)^2 - \frac{b^2}{4a} + c$

- (a) If $a > 0$ the graph is a parabola that opens upward. Increasing a causes a vertical stretching and a shift of the vertex toward the y -axis and upward. If $a < 0$ the graph is a parabola that opens downward. Decreasing a causes a vertical stretching and a shift of the vertex toward the y -axis and downward.
- (b) If $a > 0$ the graph is a parabola that opens upward. If also $b > 0$, then increasing b causes a shift of the graph downward to the left; if $b < 0$, then decreasing b causes a shift of the graph downward and to the right.

If $a < 0$ the graph is a parabola that opens downward. If $b > 0$, increasing b shifts the graph upward to the right. If $b < 0$, decreasing b shifts the graph upward to the left.

- (c) Changing c (for fixed a and b) by Δc shifts the graph upward Δc units if $\Delta c > 0$, and downward $-\Delta c$ units if $\Delta c < 0$.

26. (a) If $a > 0$, the graph rises to the right of the vertical line $x = -b$ and falls to the left. If $a < 0$, the graph falls to the right of the line $x = -b$ and rises to the left. If $a = 0$, the graph reduces to the horizontal line $y = c$. As $|a|$ increases, the slope at any given point $x = x_0$ increases in magnitude and the graph becomes steeper. As $|a|$ decreases, the slope at x_0 decreases in magnitude and the graph rises or falls more gradually.
- (b) Increasing b shifts the graph to the left; decreasing b shifts it to the right.
- (c) Increasing c shifts the graph upward; decreasing c shifts it downward.

27. If $m > 0$, the x -intercept of $y = mx + 2$ must be negative. If $m < 0$, then the x -intercept exceeds $\frac{1}{2} \Rightarrow 0 = mx + 2$ and $x > \frac{1}{2} \Rightarrow x = -\frac{2}{m} > \frac{1}{2} \Rightarrow 0 > m > -4$.

28. Each of the triangles pictured has the same base $b = v\Delta t = v(1 \text{ sec})$. Moreover, the height of each triangle is the same value h . Thus $\frac{1}{2}(\text{base})(\text{height}) = \frac{1}{2}bh = A_1 = A_2 = A_3 = \dots$. In conclusion, the object sweeps out equal areas in each one second interval.

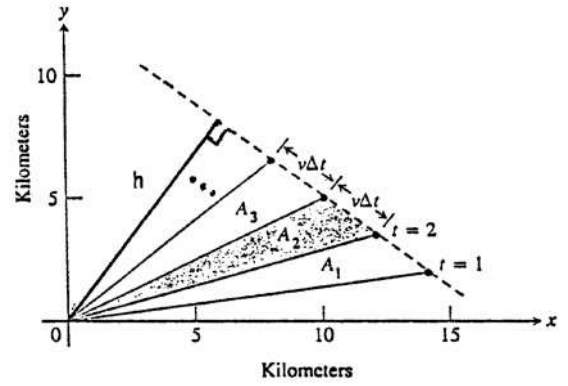

29. (a) By Exercise #95 of Section 1.2, the coordinates of P are $(\frac{a+0}{2}, \frac{b+0}{2}) = (\frac{a}{2}, \frac{b}{2})$. Thus the slope of OP = $\frac{\Delta y}{\Delta x} = \frac{b/2}{a/2} = \frac{b}{a}$.

(b) The slope of AB = $\frac{b-0}{0-a} = -\frac{b}{a}$. The line segments AB and OP are perpendicular when the product of their slopes is $-1 = (\frac{b}{a})(-\frac{b}{a}) = -\frac{b^2}{a^2}$. Thus, $b^2 = a^2 \Rightarrow a = b$ (since both are positive). Therefore, AB is perpendicular to OP when $a = b$.

NOTES:

CHAPTER 2 LIMITS AND CONTINUITY

2.1 RATES OF CHANGE AND LIMITS

- (a) Does not exist. As x approaches 1 from the right, $g(x)$ approaches 0. As x approaches 1 from the left, $g(x)$ approaches 1. There is no single number L that all the values $g(x)$ get arbitrarily close to as $x \rightarrow 1$.

(b) 1
(c) 0
- (a) 0
(b) -1
(c) Does not exist. As t approaches 0 from the left, $f(t)$ approaches -1 . As t approaches 0 from the right, $f(t)$ approaches 1. There is no single number L that $f(t)$ gets arbitrarily close to as $t \rightarrow 0$.
- (a) True (b) True (c) False
(d) False (e) False (f) True
- (a) False (b) False (c) True
(d) True (e) True
- $\lim_{x \rightarrow 0} \frac{x}{|x|}$ does not exist because $\frac{x}{|x|} = \frac{x}{x} = 1$ if $x > 0$ and $\frac{x}{|x|} = \frac{x}{-x} = -1$ if $x < 0$. As x approaches 0 from the left, $\frac{x}{|x|}$ approaches -1 . As x approaches 0 from the right, $\frac{x}{|x|}$ approaches 1. There is no single number L that all the function values get arbitrarily close to as $x \rightarrow 0$.
- As x approaches 1 from the left, the values of $\frac{1}{x-1}$ become increasingly large and negative. As x approaches 1 from the right, the values become increasingly large and positive. There is no one number L that all the function values get arbitrarily close to as $x \rightarrow 1$, so $\lim_{x \rightarrow 1} \frac{1}{x-1}$ does not exist.
- Nothing can be said about $f(x)$ because the existence of a limit as $x \rightarrow x_0$ does not depend on how the function is defined at x_0 . In order for a limit to exist, $f(x)$ must be arbitrarily close to a single real number L when x is close enough to x_0 . That is, the existence of a limit depends on the values of $f(x)$ for x near x_0 , not on the definition of $f(x)$ at x_0 itself.
- Nothing can be said. In order for $\lim_{x \rightarrow 0} f(x)$ to exist, $f(x)$ must close to a single value for x near 0 regardless of the value $f(0)$ itself.
- No, the definition does not require that f be defined at $x = 1$ in order for a limiting value to exist there. If $f(1)$ is defined, it can be any real number, so we can conclude nothing about $f(1)$ from $\lim_{x \rightarrow 1} f(x) = 5$.
- No, because the existence of a limit depends on the values of $f(x)$ when x is near 1, not on $f(1)$ itself. If $\lim_{x \rightarrow 1} f(x)$ exists, its value may be some number other than $f(1) = 5$. We can conclude nothing about $\lim_{x \rightarrow 1} f(x)$, whether it exists or what its value is if it does exist, from knowing the value of $f(1)$ alone.

11. (a) $f(x) = (x^2 - 9)/(x + 3)$

x	-3.1	-3.01	-3.001	-3.0001	-3.00001	-3.000001
f(x)	-6.1	-6.01	-6.001	-6.0001	-6.00001	-6.000001

x	-2.9	-2.99	-2.999	-2.9999	-2.99999	-2.999999
f(x)	-5.9	-5.99	-5.999	-5.9999	-5.99999	-5.999999

The estimate is $\lim_{x \rightarrow -3} f(x) = -6$.

(b)

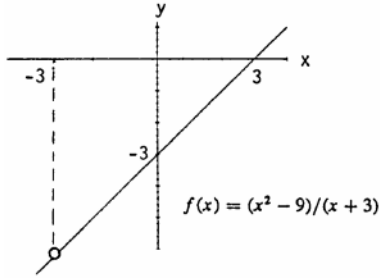

(c) $f(x) = \frac{x^2 - 9}{x + 3} = \frac{(x + 3)(x - 3)}{x + 3} = x - 3$ if $x \neq -3$, and $\lim_{x \rightarrow -3} (x - 3) = -3 - 3 = -6$.

12. (a) $g(x) = (x^2 - 2)/(x - \sqrt{2})$

x	1.4	1.41	1.414	1.4142	1.41421	1.414213
g(x)	2.81421	2.82421	2.82821	2.828413	2.828423	2.828426

(b)

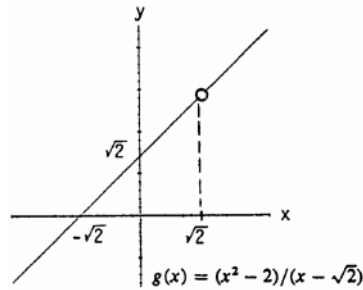

(c) $g(x) = \frac{x^2 - 2}{x - \sqrt{2}} = \frac{(x + \sqrt{2})(x - \sqrt{2})}{x - \sqrt{2}} = x + \sqrt{2}$ if $x \neq \sqrt{2}$, and $\lim_{x \rightarrow \sqrt{2}} (x + \sqrt{2}) = \sqrt{2} + \sqrt{2} = 2\sqrt{2}$.

13. (a) $G(x) = (x + 6)/(x^2 + 4x - 12)$

x	-5.9	-5.99	-5.999	-5.9999	-5.99999	-5.999999
G(x)	-.126582	-.1251564	-.1250156	-.1250015	-.1250001	-.1250000

x	-6.1	-6.01	-6.001	-6.0001	-6.00001	-6.000001
G(x)	-.123456	-.124843	-.124984	-.124998	-.124999	-.124999

(b)

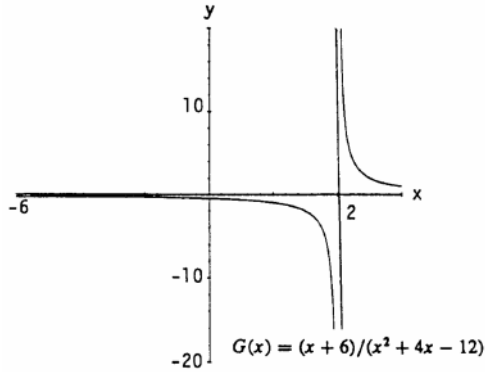

(c) $G(x) = \frac{x+6}{(x^2+4x-12)} = \frac{x+6}{(x+6)(x-2)} = \frac{1}{x-2}$ if $x \neq -6$, and $\lim_{x \rightarrow -6} \frac{1}{x-2} = \frac{1}{-6-2} = -\frac{1}{8} = -0.125$.

14. (a) $h(x) = (x^2 - 2x - 3)/(x^2 - 4x + 3)$

x	2.9	2.99	2.999	2.9999	2.99999	2.999999
h(x)	2.052631	2.005025	2.000500	2.000050	2.000005	2.0000005

x	3.1	3.01	3.001	3.0001	3.00001	3.000001
h(x)	1.952380	1.995024	1.999500	1.999950	1.999995	1.999999

(b)

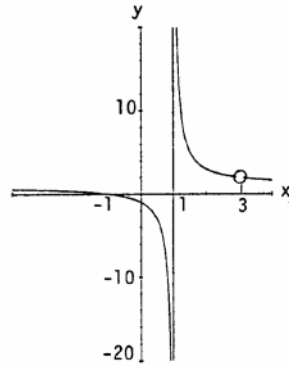

$h(x) = (x^2 - 2x - 3)/(x^2 - 4x + 3)$

(c) $h(x) = \frac{x^2-2x-3}{x^2-4x+3} = \frac{(x-3)(x+1)}{(x-3)(x-1)} = \frac{x+1}{x-1}$ if $x \neq 3$, and $\lim_{x \rightarrow 3} \frac{x+1}{x-1} = \frac{3+1}{3-1} = \frac{4}{2} = 2$.

15. (a) $f(x) = (x^2 - 1)/(|x| - 1)$

x	-1.1	-1.01	-1.001	-1.0001	-1.00001	-1.000001
f(x)	2.1	2.01	2.001	2.0001	2.00001	2.000001

x	-.9	-.99	-.999	-.9999	-.99999	-.999999
f(x)	1.9	1.99	1.999	1.9999	1.99999	1.999999

(b)

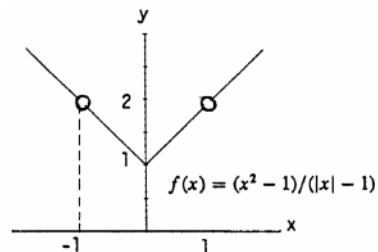

(c) $f(x) = \frac{x^2-1}{|x|-1} = \begin{cases} \frac{(x+1)(x-1)}{x-1} = x+1, & x \geq 0 \text{ and } x \neq 1 \\ \frac{(x+1)(x-1)}{-(x+1)} = 1-x, & x < 0 \text{ and } x \neq -1 \end{cases}$, and $\lim_{x \rightarrow -1} (1-x) = 1 - (-1) = 2$.

16. (a) $F(x) = (x^2 + 3x + 2) / (2 - |x|)$

x	-2.1	-2.01	-2.001	-2.0001	-2.00001	-2.000001
F(x)	-1.1	-1.01	-1.001	-1.0001	-1.00001	-1.000001

x	-1.9	-1.99	-1.999	-1.9999	-1.99999	-1.999999
F(x)	-.9	-.99	-.999	-.9999	-.99999	-.999999

(b)

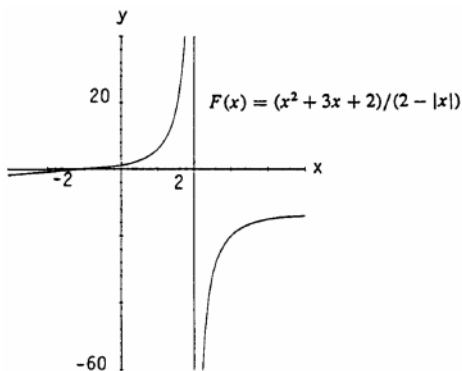

(c) $F(x) = \frac{x^2+3x+2}{2-|x|} = \begin{cases} \frac{(x+2)(x+1)}{2-x}, & x \geq 0 \\ \frac{(x+2)(x+1)}{2+x} = x+1, & x < 0 \text{ and } x \neq -2 \end{cases}$, and $\lim_{x \rightarrow -2} (x+1) = -2+1 = -1$.

17. (a) $g(\theta) = (\sin \theta) / \theta$

θ	.1	.01	.001	.0001	.00001	.000001
$g(\theta)$.998334	.999983	.999999	.999999	.999999	.999999

θ	-.1	-.01	-.001	-.0001	-.00001	-.000001
$g(\theta)$.998334	.999983	.999999	.999999	.999999	.999999

$\lim_{\theta \rightarrow 0} g(\theta) = 1$

(b)

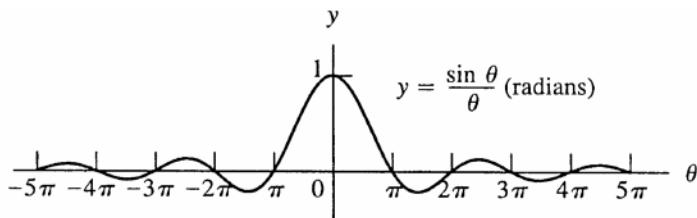

NOT TO SCALE

18. (a) $G(t) = (1 - \cos t) / t^2$

t	.1	.01	.001	.0001	.00001	.000001
G(t)	.499583	.499995	.499999	.5	.5	.5

t	-.1	-.01	-.001	-.0001	-.00001	-.000001
G(t)	.499583	.499995	.499999	.5	.5	.5

$\lim_{t \rightarrow 0} G(t) = 0.5$

(b)

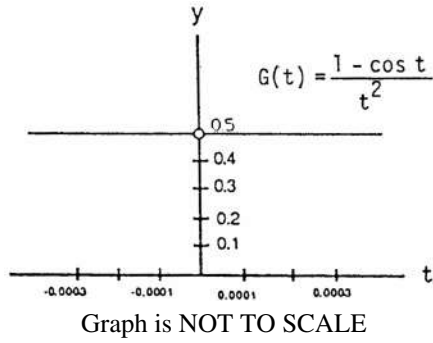

19. (a) $f(x) = x^{1/(1-x)}$

x	.9	.99	.999	.9999	.99999	.999999
f(x)	.348678	.366032	.367695	.367861	.367877	.367879

x	1.1	1.01	1.001	1.0001	1.00001	1.000001
f(x)	.385543	.369711	.368063	.367897	.367881	.367878

$\lim_{x \rightarrow 1} f(x) \approx 0.36788$

(b)

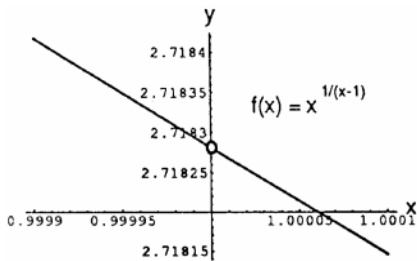

Graph is NOT TO SCALE. Also the intersection of the axes is not the origin: the axes intersect at the point (1, 2.71820).

20. (a) $f(x) = (3^x - 1)/x$

x	.1	.01	.001	.0001	.00001	.000001
f(x)	1.161231	1.104669	1.099215	1.098672	1.098618	1.098612

x	-.1	-.01	-.001	-.0001	-.00001	-.000001
f(x)	1.040415	1.092599	1.098009	1.098551	1.098606	1.098611

$\lim_{x \rightarrow 0} f(x) \approx 1.0986$

(b)

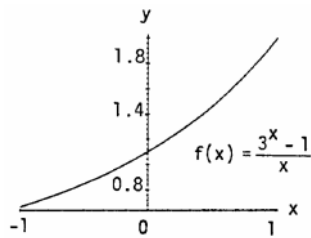

21. $\lim_{x \rightarrow 2} 2x = 2(2) = 4$

22. $\lim_{x \rightarrow 0} 2x = 2(0) = 0$

23. $\lim_{x \rightarrow \frac{1}{3}} (3x - 1) = 3\left(\frac{1}{3}\right) - 1 = 0$

24. $\lim_{x \rightarrow 1} \frac{-1}{3x-1} = \frac{-1}{3(1)-1} = -\frac{1}{2}$

72 Chapter 2 Limits and Continuity

25. $\lim_{x \rightarrow -1} 3x(2x - 1) = 3(-1)(2(-1) - 1) = 9$

26. $\lim_{x \rightarrow -1} \frac{3x^2}{2x-1} = \frac{3(-1)^2}{2(-1)-1} = \frac{3}{-3} = -1$

27. $\lim_{x \rightarrow \frac{\pi}{2}} x \sin x = \frac{\pi}{2} \sin \frac{\pi}{2} = \frac{\pi}{2}$

28. $\lim_{x \rightarrow \pi} \frac{\cos x}{1-\pi} = \frac{\cos \pi}{1-\pi} = \frac{-1}{1-\pi} = \frac{1}{\pi-1}$

29. (a) $\frac{\Delta f}{\Delta x} = \frac{f(3)-f(2)}{3-2} = \frac{28-9}{1} = 19$

(b) $\frac{\Delta f}{\Delta x} = \frac{f(1)-f(-1)}{1-(-1)} = \frac{2-0}{2} = 1$

30. (a) $\frac{\Delta g}{\Delta x} = \frac{g(1)-g(-1)}{1-(-1)} = \frac{1-1}{2} = 0$

(b) $\frac{\Delta g}{\Delta x} = \frac{g(0)-g(-2)}{0-(-2)} = \frac{0-4}{2} = -2$

31. (a) $\frac{\Delta h}{\Delta t} = \frac{h(\frac{3\pi}{4})-h(\frac{\pi}{4})}{\frac{3\pi}{4}-\frac{\pi}{4}} = \frac{-1-1}{\frac{\pi}{2}} = -\frac{4}{\pi}$

(b) $\frac{\Delta h}{\Delta t} = \frac{h(\frac{\pi}{2})-h(\frac{\pi}{6})}{\frac{\pi}{2}-\frac{\pi}{6}} = \frac{0-\sqrt{3}}{\frac{\pi}{3}} = \frac{-3\sqrt{3}}{\pi}$

32. (a) $\frac{\Delta g}{\Delta t} = \frac{g(\pi)-g(0)}{\pi-0} = \frac{(2-1)-(2+1)}{\pi-0} = -\frac{2}{\pi}$

(b) $\frac{\Delta g}{\Delta t} = \frac{g(\pi)-g(-\pi)}{\pi-(-\pi)} = \frac{(2-1)-(2-1)}{2\pi} = 0$

33. $\frac{\Delta R}{\Delta \theta} = \frac{R(2)-R(0)}{2-0} = \frac{\sqrt{8+1}-\sqrt{1}}{2} = \frac{3-1}{2} = 1$

34. $\frac{\Delta P}{\Delta \theta} = \frac{P(2)-P(1)}{2-1} = \frac{(8-16+10)-(1-4+5)}{1} = 2-2 = 0$

35. (a)

Q	Slope of PQ = $\frac{\Delta p}{\Delta t}$
Q ₁ (10, 225)	$\frac{650-225}{20-10} = 42.5$ m/sec
Q ₂ (14, 375)	$\frac{650-375}{20-14} = 45.83$ m/sec
Q ₃ (16.5, 475)	$\frac{650-475}{20-16.5} = 50.00$ m/sec
Q ₄ (18, 550)	$\frac{650-550}{20-18} = 50.00$ m/sec

(b) At t = 20, the Cobra was traveling approximately 50 m/sec or 180 km/h.

36. (a)

Q	Slope of PQ = $\frac{\Delta p}{\Delta t}$
Q ₁ (5, 20)	$\frac{80-20}{10-5} = 12$ m/sec
Q ₂ (7, 39)	$\frac{80-39}{10-7} = 13.7$ m/sec
Q ₃ (8.5, 58)	$\frac{80-58}{10-8.5} = 14.7$ m/sec
Q ₄ (9.5, 72)	$\frac{80-72}{10-9.5} = 16$ m/sec

(b) Approximately 16 m/sec

37. (a)

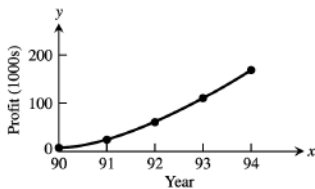

(b) $\frac{\Delta p}{\Delta t} = \frac{174-62}{1994-1992} = \frac{112}{2} = 56$ thousand dollars per year

(c) The average rate of change from 1991 to 1992 is $\frac{\Delta p}{\Delta t} = \frac{62-27}{1992-1991} = 35$ thousand dollars per year.

The average rate of change from 1992 to 1993 is $\frac{\Delta p}{\Delta t} = \frac{111-62}{1993-1992} = 49$ thousand dollars per year.

So, the rate at which profits were changing in 1992 is approximately $\frac{1}{2}(35 + 49) = 42$ thousand dollars per year.

38. (a) $F(x) = (x + 2)/(x - 2)$

x	1.2	1.1	1.01	1.001	1.0001	1
F(x)	-4.0	-3.4	-3.04	-3.004	-3.0004	-3
$\frac{\Delta F}{\Delta x} = \frac{-4.0 - (-3)}{1.2 - 1}$	= -5.0;		$\frac{\Delta F}{\Delta x} = \frac{-3.4 - (-3)}{1.1 - 1} = -4.4$;			
$\frac{\Delta F}{\Delta x} = \frac{-3.04 - (-3)}{1.01 - 1}$	= -4.04;		$\frac{\Delta F}{\Delta x} = \frac{-3.004 - (-3)}{1.001 - 1} = -4.004$;			
$\frac{\Delta F}{\Delta x} = \frac{-3.0004 - (-3)}{1.0001 - 1}$	= -4.0004;					

(b) The rate of change of $F(x)$ at $x = 1$ is -4 .

39. (a) $\frac{\Delta g}{\Delta x} = \frac{g(2) - g(1)}{2 - 1} = \frac{\sqrt{2} - 1}{2 - 1} \approx 0.414213$

$\frac{\Delta g}{\Delta x} = \frac{g(1.5) - g(1)}{1.5 - 1} = \frac{\sqrt{1.5} - 1}{0.5} \approx 0.449489$

$\frac{\Delta g}{\Delta x} = \frac{g(1+h) - g(1)}{(1+h) - 1} = \frac{\sqrt{1+h} - 1}{h}$

(b) $g(x) = \sqrt{x}$

$\frac{1+h}{\sqrt{1+h}}$	1.1	1.01	1.001	1.0001	1.00001	1.000001
$\frac{1+h}{\sqrt{1+h}}$	1.04880	1.004987	1.0004998	1.0000499	1.000005	1.0000005
$(\sqrt{1+h} - 1)/h$	0.4880	0.4987	0.4998	0.499	0.5	0.5

(c) The rate of change of $g(x)$ at $x = 1$ is 0.5.(d) The calculator gives $\lim_{h \rightarrow 0} \frac{\sqrt{1+h} - 1}{h} = \frac{1}{2}$.

40. (a) i) $\frac{f(3) - f(2)}{3 - 2} = \frac{\frac{1}{3} - \frac{1}{2}}{1} = \frac{-\frac{1}{6}}{1} = -\frac{1}{6}$

ii) $\frac{f(T) - f(2)}{T - 2} = \frac{\frac{1}{T} - \frac{1}{2}}{T - 2} = \frac{\frac{2-T}{2T}}{T-2} = \frac{2-T}{2T(T-2)} = -\frac{1}{2T}, T \neq 2$

T	2.1	2.01	2.001	2.0001	2.00001	2.000001
f(T)	0.476190	0.497512	0.499750	0.4999750	0.499997	0.499999
$(f(T) - f(2))/(T - 2)$	-0.2381	-0.2488	-0.2500	-0.2500	-0.2500	-0.2500

(c) The table indicates the rate of change is -0.25 at $t = 2$.

(d) $\lim_{T \rightarrow 2} \left(\frac{1}{-2T} \right) = -\frac{1}{4}$

41-46. Example CAS commands:

Maple:

```
f := x -> (x^4 - 16)/(x - 2);
x0 := 2;
plot( f(x), x = x0-1..x0+1, color = black,
      title = "Section 2.1, #41(a)");
limit( f(x), x = x0 );
```

In Exercise 43, note that the standard cube root, $x^{1/3}$, is not defined for $x < 0$ in many CASs. This can be overcome in Maple by entering the function as $f := x \rightarrow (\text{surd}(x+1, 3) - 1)/x$.

Mathematica: (assigned function and values for x_0 and h may vary)

```
Clear[f, x]
f[x_]:= (x^3 - x^2 - 5x - 3)/(x + 1)^2
x0 = -1; h = 0.1;
Plot[f[x], {x, x0 - h, x0 + h}]
Limit[f[x], x -> x0]
```

2.2 CALCULATING LIMITS USING THE LIMIT LAWS

1. $\lim_{x \rightarrow -7} (2x + 5) = 2(-7) + 5 = -14 + 5 = -9$
2. $\lim_{x \rightarrow 12} (10 - 3x) = 10 - 3(12) = 10 - 36 = -26$
3. $\lim_{x \rightarrow 2} (-x^2 + 5x - 2) = -(2)^2 + 5(2) - 2 = -4 + 10 - 2 = 4$
4. $\lim_{x \rightarrow -2} (x^3 - 2x^2 + 4x + 8) = (-2)^3 - 2(-2)^2 + 4(-2) + 8 = -8 - 8 - 8 + 8 = -16$
5. $\lim_{t \rightarrow 6} 8(t - 5)(t - 7) = 8(6 - 5)(6 - 7) = -8$
6. $\lim_{s \rightarrow \frac{2}{3}} 3s(2s - 1) = 3\left(\frac{2}{3}\right) \left[2\left(\frac{2}{3}\right) - 1\right] = 2\left(\frac{4}{3} - 1\right) = \frac{2}{3}$
7. $\lim_{x \rightarrow 2} \frac{x+3}{x+6} = \frac{2+3}{2+6} = \frac{5}{8}$
8. $\lim_{x \rightarrow 5} \frac{4}{x-7} = \frac{4}{5-7} = \frac{4}{-2} = -2$
9. $\lim_{y \rightarrow -5} \frac{y^2}{5-y} = \frac{(-5)^2}{5-(-5)} = \frac{25}{10} = \frac{5}{2}$
10. $\lim_{y \rightarrow 2} \frac{y+2}{y^2+5y+6} = \frac{2+2}{(2)^2+5(2)+6} = \frac{4}{4+10+6} = \frac{4}{20} = \frac{1}{5}$
11. $\lim_{x \rightarrow -1} 3(2x - 1)^2 = 3(2(-1) - 1)^2 = 3(-3)^2 = 27$
12. $\lim_{x \rightarrow -4} (x + 3)^{1984} = (-4 + 3)^{1984} = (-1)^{1984} = 1$
13. $\lim_{y \rightarrow -3} (5 - y)^{4/3} = [5 - (-3)]^{4/3} = (8)^{4/3} = ((8)^{1/3})^4 = 2^4 = 16$
14. $\lim_{z \rightarrow 0} (2z - 8)^{1/3} = (2(0) - 8)^{1/3} = (-8)^{1/3} = -2$
15. $\lim_{h \rightarrow 0} \frac{3}{\sqrt{3h+1}+1} = \frac{3}{\sqrt{3(0)+1}+1} = \frac{3}{\sqrt{1}+1} = \frac{3}{2}$
16. $\lim_{h \rightarrow 0} \frac{5}{\sqrt{5h+4}+2} = \frac{5}{\sqrt{5(0)+4}+2} = \frac{5}{\sqrt{4}+2} = \frac{5}{4}$
17. $\lim_{h \rightarrow 0} \frac{\sqrt{3h+1}-1}{h} = \lim_{h \rightarrow 0} \frac{\sqrt{3h+1}-1}{h} \cdot \frac{\sqrt{3h+1}+1}{\sqrt{3h+1}+1} = \lim_{h \rightarrow 0} \frac{(3h+1)-1}{h(\sqrt{3h+1}+1)} = \lim_{h \rightarrow 0} \frac{3h}{h(\sqrt{3h+1}+1)} = \lim_{h \rightarrow 0} \frac{3}{\sqrt{3h+1}+1} = \frac{3}{\sqrt{1}+1} = \frac{3}{2}$
18. $\lim_{h \rightarrow 0} \frac{\sqrt{5h+4}-2}{h} = \lim_{h \rightarrow 0} \frac{\sqrt{5h+4}-2}{h} \cdot \frac{\sqrt{5h+4}+2}{\sqrt{5h+4}+2} = \lim_{h \rightarrow 0} \frac{(5h+4)-4}{h(\sqrt{5h+4}+2)} = \lim_{h \rightarrow 0} \frac{5h}{h(\sqrt{5h+4}+2)} = \lim_{h \rightarrow 0} \frac{5}{\sqrt{5h+4}+2} = \frac{5}{\sqrt{4}+2} = \frac{5}{4}$
19. $\lim_{x \rightarrow 5} \frac{x-5}{x^2-25} = \lim_{x \rightarrow 5} \frac{x-5}{(x+5)(x-5)} = \lim_{x \rightarrow 5} \frac{1}{x+5} = \frac{1}{5+5} = \frac{1}{10}$
20. $\lim_{x \rightarrow -3} \frac{x+3}{x^2+4x+3} = \lim_{x \rightarrow -3} \frac{x+3}{(x+3)(x+1)} = \lim_{x \rightarrow -3} \frac{1}{x+1} = \frac{1}{-3+1} = -\frac{1}{2}$
21. $\lim_{x \rightarrow -5} \frac{x^2+3x-10}{x+5} = \lim_{x \rightarrow -5} \frac{(x+5)(x-2)}{x+5} = \lim_{x \rightarrow -5} (x-2) = -5-2 = -7$

22. $\lim_{x \rightarrow 2} \frac{x^2 - 7x + 10}{x - 2} = \lim_{x \rightarrow 2} \frac{(x - 5)(x - 2)}{x - 2} = \lim_{x \rightarrow 2} (x - 5) = 2 - 5 = -3$
23. $\lim_{t \rightarrow 1} \frac{t^2 + t - 2}{t^2 - 1} = \lim_{t \rightarrow 1} \frac{(t + 2)(t - 1)}{(t - 1)(t + 1)} = \lim_{t \rightarrow 1} \frac{t + 2}{t + 1} = \frac{1 + 2}{1 + 1} = \frac{3}{2}$
24. $\lim_{t \rightarrow -1} \frac{t^2 + 3t + 2}{t^2 - t - 2} = \lim_{t \rightarrow -1} \frac{(t + 2)(t + 1)}{(t - 2)(t + 1)} = \lim_{t \rightarrow -1} \frac{t + 2}{t - 2} = \frac{-1 + 2}{-1 - 2} = -\frac{1}{3}$
25. $\lim_{x \rightarrow -2} \frac{-2x - 4}{x^3 + 2x^2} = \lim_{x \rightarrow -2} \frac{-2(x + 2)}{x^2(x + 2)} = \lim_{x \rightarrow -2} \frac{-2}{x^2} = \frac{-2}{4} = -\frac{1}{2}$
26. $\lim_{y \rightarrow 0} \frac{5y^3 + 8y^2}{3y^4 - 16y^2} = \lim_{y \rightarrow 0} \frac{y^2(5y + 8)}{y^2(3y^2 - 16)} = \lim_{y \rightarrow 0} \frac{5y + 8}{3y^2 - 16} = \frac{8}{-16} = -\frac{1}{2}$
27. $\lim_{u \rightarrow 1} \frac{u^4 - 1}{u^3 - 1} = \lim_{u \rightarrow 1} \frac{(u^2 + 1)(u + 1)(u - 1)}{(u^2 + u + 1)(u - 1)} = \lim_{u \rightarrow 1} \frac{(u^2 + 1)(u + 1)}{u^2 + u + 1} = \frac{(1 + 1)(1 + 1)}{1 + 1 + 1} = \frac{4}{3}$
28. $\lim_{v \rightarrow 2} \frac{v^3 - 8}{v^4 - 16} = \lim_{v \rightarrow 2} \frac{(v - 2)(v^2 + 2v + 4)}{(v - 2)(v + 2)(v^2 + 4)} = \lim_{v \rightarrow 2} \frac{v^2 + 2v + 4}{(v + 2)(v^2 + 4)} = \frac{4 + 4 + 4}{(4)(8)} = \frac{12}{32} = \frac{3}{8}$
29. $\lim_{x \rightarrow 9} \frac{\sqrt{x} - 3}{x - 9} = \lim_{x \rightarrow 9} \frac{\sqrt{x} - 3}{(\sqrt{x} - 3)(\sqrt{x} + 3)} = \lim_{x \rightarrow 9} \frac{1}{\sqrt{x} + 3} = \frac{1}{\sqrt{9} + 3} = \frac{1}{6}$
30. $\lim_{x \rightarrow 4} \frac{4x - x^2}{2 - \sqrt{x}} = \lim_{x \rightarrow 4} \frac{x(4 - x)}{2 - \sqrt{x}} = \lim_{x \rightarrow 4} \frac{x(2 + \sqrt{x})(2 - \sqrt{x})}{2 - \sqrt{x}} = \lim_{x \rightarrow 4} x(2 + \sqrt{x}) = 4(2 + 2) = 16$
31. $\lim_{x \rightarrow 1} \frac{x - 1}{\sqrt{x + 3} - 2} = \lim_{x \rightarrow 1} \frac{(x - 1)(\sqrt{x + 3} + 2)}{(\sqrt{x + 3} - 2)(\sqrt{x + 3} + 2)} = \lim_{x \rightarrow 1} \frac{(x - 1)(\sqrt{x + 3} + 2)}{(x + 3) - 4} = \lim_{x \rightarrow 1} (\sqrt{x + 3} + 2)$
 $= \sqrt{4} + 2 = 4$
32. $\lim_{x \rightarrow -1} \frac{\sqrt{x^2 + 8} - 3}{x + 1} = \lim_{x \rightarrow -1} \frac{(\sqrt{x^2 + 8} - 3)(\sqrt{x^2 + 8} + 3)}{(x + 1)(\sqrt{x^2 + 8} + 3)} = \lim_{x \rightarrow -1} \frac{(x^2 + 8) - 9}{(x + 1)(\sqrt{x^2 + 8} + 3)}$
 $= \lim_{x \rightarrow -1} \frac{(x + 1)(x - 1)}{(x + 1)(\sqrt{x^2 + 8} + 3)} = \lim_{x \rightarrow -1} \frac{x - 1}{\sqrt{x^2 + 8} + 3} = \frac{-2}{3 + 3} = -\frac{1}{3}$
33. $\lim_{x \rightarrow 2} \frac{\sqrt{x^2 + 12} - 4}{x - 2} = \lim_{x \rightarrow 2} \frac{(\sqrt{x^2 + 12} - 4)(\sqrt{x^2 + 12} + 4)}{(x - 2)(\sqrt{x^2 + 12} + 4)} = \lim_{x \rightarrow 2} \frac{(x^2 + 12) - 16}{(x - 2)(\sqrt{x^2 + 12} + 4)}$
 $= \lim_{x \rightarrow 2} \frac{(x - 2)(x + 2)}{(x - 2)(\sqrt{x^2 + 12} + 4)} = \lim_{x \rightarrow 2} \frac{x + 2}{\sqrt{x^2 + 12} + 4} = \frac{4}{\sqrt{16} + 4} = \frac{1}{2}$
34. $\lim_{x \rightarrow -2} \frac{x + 2}{\sqrt{x^2 + 5} - 3} = \lim_{x \rightarrow -2} \frac{(x + 2)(\sqrt{x^2 + 5} + 3)}{(\sqrt{x^2 + 5} - 3)(\sqrt{x^2 + 5} + 3)} = \lim_{x \rightarrow -2} \frac{(x + 2)(\sqrt{x^2 + 5} + 3)}{(x^2 + 5) - 9}$
 $= \lim_{x \rightarrow -2} \frac{(x + 2)(\sqrt{x^2 + 5} + 3)}{(x + 2)(x - 2)} = \lim_{x \rightarrow -2} \frac{\sqrt{x^2 + 5} + 3}{x - 2} = \frac{\sqrt{9} + 3}{-4} = -\frac{3}{2}$
35. $\lim_{x \rightarrow -3} \frac{2 - \sqrt{x^2 - 5}}{x + 3} = \lim_{x \rightarrow -3} \frac{(2 - \sqrt{x^2 - 5})(2 + \sqrt{x^2 - 5})}{(x + 3)(2 + \sqrt{x^2 - 5})} = \lim_{x \rightarrow -3} \frac{4 - (x^2 - 5)}{(x + 3)(2 + \sqrt{x^2 - 5})}$
 $= \lim_{x \rightarrow -3} \frac{9 - x^2}{(x + 3)(2 + \sqrt{x^2 - 5})} = \lim_{x \rightarrow -3} \frac{(3 - x)(3 + x)}{(x + 3)(2 + \sqrt{x^2 - 5})} = \lim_{x \rightarrow -3} \frac{3 - x}{2 + \sqrt{x^2 - 5}} = \frac{6}{2 + \sqrt{4}} = \frac{3}{2}$

$$\begin{aligned}
36. \lim_{x \rightarrow 4} \frac{4-x}{5-\sqrt{x^2+9}} &= \lim_{x \rightarrow 4} \frac{(4-x)(5+\sqrt{x^2+9})}{(5-\sqrt{x^2+9})(5+\sqrt{x^2+9})} = \lim_{x \rightarrow 4} \frac{(4-x)(5+\sqrt{x^2+9})}{25-(x^2+9)} \\
&= \lim_{x \rightarrow 4} \frac{(4-x)(5+\sqrt{x^2+9})}{16-x^2} = \lim_{x \rightarrow 4} \frac{(4-x)(5+\sqrt{x^2+9})}{(4-x)(4+x)} = \lim_{x \rightarrow 4} \frac{5+\sqrt{x^2+9}}{4+x} = \frac{5+\sqrt{25}}{8} = \frac{5}{4}
\end{aligned}$$

37. (a) quotient rule
 (b) difference and power rules
 (c) sum and constant multiple rules

38. (a) quotient rule
 (b) power and product rules
 (c) difference and constant multiple rules

$$\begin{aligned}
39. (a) \lim_{x \rightarrow c} f(x)g(x) &= \left[\lim_{x \rightarrow c} f(x) \right] \left[\lim_{x \rightarrow c} g(x) \right] = (5)(-2) = -10 \\
(b) \lim_{x \rightarrow c} 2f(x)g(x) &= 2 \left[\lim_{x \rightarrow c} f(x) \right] \left[\lim_{x \rightarrow c} g(x) \right] = 2(5)(-2) = -20 \\
(c) \lim_{x \rightarrow c} [f(x) + 3g(x)] &= \lim_{x \rightarrow c} f(x) + 3 \lim_{x \rightarrow c} g(x) = 5 + 3(-2) = -1 \\
(d) \lim_{x \rightarrow c} \frac{f(x)}{f(x)-g(x)} &= \frac{\lim_{x \rightarrow c} f(x)}{\lim_{x \rightarrow c} f(x) - \lim_{x \rightarrow c} g(x)} = \frac{5}{5-(-2)} = \frac{5}{7}
\end{aligned}$$

$$\begin{aligned}
40. (a) \lim_{x \rightarrow 4} [g(x) + 3] &= \lim_{x \rightarrow 4} g(x) + \lim_{x \rightarrow 4} 3 = -3 + 3 = 0 \\
(b) \lim_{x \rightarrow 4} xf(x) &= \lim_{x \rightarrow 4} x \cdot \lim_{x \rightarrow 4} f(x) = (4)(0) = 0 \\
(c) \lim_{x \rightarrow 4} [g(x)]^2 &= \left[\lim_{x \rightarrow 4} g(x) \right]^2 = [-3]^2 = 9 \\
(d) \lim_{x \rightarrow 4} \frac{g(x)}{f(x)-1} &= \frac{\lim_{x \rightarrow 4} g(x)}{\lim_{x \rightarrow 4} f(x) - \lim_{x \rightarrow 4} 1} = \frac{-3}{0-1} = 3
\end{aligned}$$

$$\begin{aligned}
41. (a) \lim_{x \rightarrow b} [f(x) + g(x)] &= \lim_{x \rightarrow b} f(x) + \lim_{x \rightarrow b} g(x) = 7 + (-3) = 4 \\
(b) \lim_{x \rightarrow b} f(x) \cdot g(x) &= \left[\lim_{x \rightarrow b} f(x) \right] \left[\lim_{x \rightarrow b} g(x) \right] = (7)(-3) = -21 \\
(c) \lim_{x \rightarrow b} 4g(x) &= \left[\lim_{x \rightarrow b} 4 \right] \left[\lim_{x \rightarrow b} g(x) \right] = (4)(-3) = -12 \\
(d) \lim_{x \rightarrow b} f(x)/g(x) &= \lim_{x \rightarrow b} f(x) / \lim_{x \rightarrow b} g(x) = \frac{7}{-3} = -\frac{7}{3}
\end{aligned}$$

$$\begin{aligned}
42. (a) \lim_{x \rightarrow -2} [p(x) + r(x) + s(x)] &= \lim_{x \rightarrow -2} p(x) + \lim_{x \rightarrow -2} r(x) + \lim_{x \rightarrow -2} s(x) = 4 + 0 + (-3) = 1 \\
(b) \lim_{x \rightarrow -2} p(x) \cdot r(x) \cdot s(x) &= \left[\lim_{x \rightarrow -2} p(x) \right] \left[\lim_{x \rightarrow -2} r(x) \right] \left[\lim_{x \rightarrow -2} s(x) \right] = (4)(0)(-3) = 0 \\
(c) \lim_{x \rightarrow -2} [-4p(x) + 5r(x)]/s(x) &= \left[-4 \lim_{x \rightarrow -2} p(x) + 5 \lim_{x \rightarrow -2} r(x) \right] / \lim_{x \rightarrow -2} s(x) = [-4(4) + 5(0)] / -3 = \frac{16}{3}
\end{aligned}$$

$$43. \lim_{h \rightarrow 0} \frac{(1+h)^2 - 1^2}{h} = \lim_{h \rightarrow 0} \frac{1+2h+h^2-1}{h} = \lim_{h \rightarrow 0} \frac{h(2+h)}{h} = \lim_{h \rightarrow 0} (2+h) = 2$$

$$44. \lim_{h \rightarrow 0} \frac{(-2+h)^2 - (-2)^2}{h} = \lim_{h \rightarrow 0} \frac{4-4h+h^2-4}{h} = \lim_{h \rightarrow 0} \frac{h(h-4)}{h} = \lim_{h \rightarrow 0} (h-4) = -4$$

$$45. \lim_{h \rightarrow 0} \frac{[3(2+h)-4] - [3(2)-4]}{h} = \lim_{h \rightarrow 0} \frac{3h}{h} = 3$$

$$46. \lim_{h \rightarrow 0} \frac{\left(\frac{1}{-2+h}\right) - \left(\frac{1}{-2}\right)}{h} = \lim_{h \rightarrow 0} \frac{\frac{-2}{-2+h} - 1}{-2h} = \lim_{h \rightarrow 0} \frac{-2 - (-2+h)}{-2h(-2+h)} = \lim_{h \rightarrow 0} \frac{-h}{h(4-2h)} = -\frac{1}{4}$$

$$47. \lim_{h \rightarrow 0} \frac{\sqrt{7+h} - \sqrt{7}}{h} = \lim_{h \rightarrow 0} \frac{(\sqrt{7+h} - \sqrt{7})(\sqrt{7+h} + \sqrt{7})}{h(\sqrt{7+h} + \sqrt{7})} = \lim_{h \rightarrow 0} \frac{(7+h) - 7}{h(\sqrt{7+h} + \sqrt{7})}$$

$$= \lim_{h \rightarrow 0} \frac{h}{h(\sqrt{7+h} + \sqrt{7})} = \lim_{h \rightarrow 0} \frac{1}{\sqrt{7+h} + \sqrt{7}} = \frac{1}{2\sqrt{7}}$$

$$48. \lim_{h \rightarrow 0} \frac{\sqrt{3(0+h)+1} - \sqrt{3(0)+1}}{h} = \lim_{h \rightarrow 0} \frac{(\sqrt{3h+1}-1)(\sqrt{3h+1}+1)}{h(\sqrt{3h+1}+1)} = \lim_{h \rightarrow 0} \frac{(3h+1)-1}{h(\sqrt{3h+1}+1)}$$

$$= \lim_{h \rightarrow 0} \frac{3h}{h(\sqrt{3h+1}+1)} = \lim_{h \rightarrow 0} \frac{3}{\sqrt{3h+1}+1} = \frac{3}{2}$$

$$49. \lim_{x \rightarrow 0} \sqrt{5-2x^2} = \sqrt{5-2(0)^2} = \sqrt{5} \text{ and } \lim_{x \rightarrow 0} \sqrt{5-x^2} = \sqrt{5-(0)^2} = \sqrt{5}; \text{ by the sandwich theorem,}$$

$$\lim_{x \rightarrow 0} f(x) = \sqrt{5}$$

$$50. \lim_{x \rightarrow 0} (2-x^2) = 2-0 = 2 \text{ and } \lim_{x \rightarrow 0} 2 \cos x = 2(1) = 2; \text{ by the sandwich theorem, } \lim_{x \rightarrow 0} g(x) = 2$$

$$51. (a) \lim_{x \rightarrow 0} \left(1 - \frac{x^2}{6}\right) = 1 - \frac{0}{6} = 1 \text{ and } \lim_{x \rightarrow 0} 1 = 1; \text{ by the sandwich theorem, } \lim_{x \rightarrow 0} \frac{x \sin x}{2-2 \cos x} = 1$$

(b) For $x \neq 0$, $y = (x \sin x)/(2 - 2 \cos x)$ lies between the other two graphs in the figure, and the graphs converge as $x \rightarrow 0$.

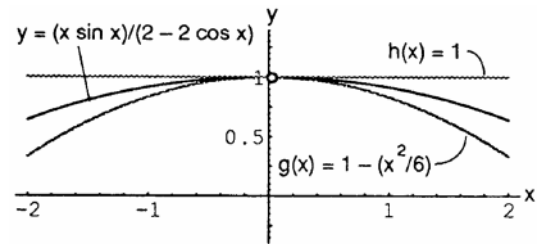

$$52. (a) \lim_{x \rightarrow 0} \left(\frac{1}{2} - \frac{x^2}{24}\right) = \lim_{x \rightarrow 0} \frac{1}{2} - \lim_{x \rightarrow 0} \frac{x^2}{24} = \frac{1}{2} - 0 = \frac{1}{2} \text{ and } \lim_{x \rightarrow 0} \frac{1}{2} = \frac{1}{2}; \text{ by the sandwich theorem,}$$

$$\lim_{x \rightarrow 0} \frac{1 - \cos x}{x^2} = \frac{1}{2}.$$

(b) For all $x \neq 0$, the graph of $f(x) = (1 - \cos x)/x^2$ lies between the line $y = \frac{1}{2}$ and the parabola $y = \frac{1}{2} - x^2/24$, and the graphs converge as $x \rightarrow 0$.

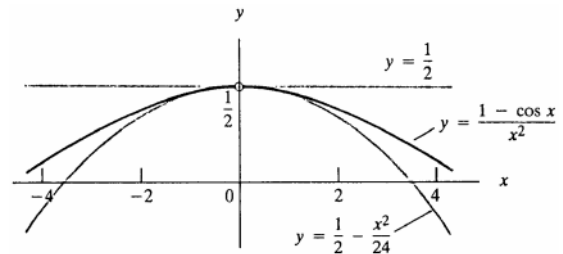

$$53. \lim_{x \rightarrow c} f(x) \text{ exists at those points } c \text{ where } \lim_{x \rightarrow c} x^4 = \lim_{x \rightarrow c} x^2. \text{ Thus, } c^4 = c^2 \Rightarrow c^2(1 - c^2) = 0$$

$$\Rightarrow c = 0, 1, \text{ or } -1. \text{ Moreover, } \lim_{x \rightarrow 0} f(x) = \lim_{x \rightarrow 0} x^2 = 0 \text{ and } \lim_{x \rightarrow -1} f(x) = \lim_{x \rightarrow 1} f(x) = 1.$$

54. Nothing can be concluded about the values of f , g , and h at $x = 2$. Yes, $f(2)$ could be 0. Since the conditions of the sandwich theorem are satisfied, $\lim_{x \rightarrow 2} f(x) = -5 \neq 0$.

$$55. 1 = \lim_{x \rightarrow 4} \frac{f(x)-5}{x-2} = \frac{\lim_{x \rightarrow 4} f(x) - \lim_{x \rightarrow 4} 5}{\lim_{x \rightarrow 4} x - \lim_{x \rightarrow 4} 2} = \frac{\lim_{x \rightarrow 4} f(x) - 5}{4 - 2} \Rightarrow \lim_{x \rightarrow 4} f(x) - 5 = 2(1) \Rightarrow \lim_{x \rightarrow 4} f(x) = 2 + 5 = 7.$$

56. (a) $1 = \lim_{x \rightarrow -2} \frac{f(x)}{x^2} = \frac{\lim_{x \rightarrow -2} f(x)}{\lim_{x \rightarrow -2} x^2} = \frac{\lim_{x \rightarrow -2} f(x)}{4} \Rightarrow \lim_{x \rightarrow -2} f(x) = 4.$

(b) $1 = \lim_{x \rightarrow -2} \frac{f(x)}{x^2} = \left[\lim_{x \rightarrow -2} \frac{f(x)}{x} \right] \left[\lim_{x \rightarrow -2} \frac{1}{x} \right] = \left[\lim_{x \rightarrow -2} \frac{f(x)}{x} \right] \left(\frac{1}{-2} \right) \Rightarrow \lim_{x \rightarrow -2} \frac{f(x)}{x} = -2.$

57. (a) $0 = 3 \cdot 0 = \left[\lim_{x \rightarrow 2} \frac{f(x)-5}{x-2} \right] \left[\lim_{x \rightarrow 2} (x-2) \right] = \lim_{x \rightarrow 2} \left[\left(\frac{f(x)-5}{x-2} \right) (x-2) \right] = \lim_{x \rightarrow 2} [f(x) - 5] = \lim_{x \rightarrow 2} f(x) - 5$
 $\Rightarrow \lim_{x \rightarrow 2} f(x) = 5.$

(b) $0 = 4 \cdot 0 = \left[\lim_{x \rightarrow 2} \frac{f(x)-5}{x-2} \right] \left[\lim_{x \rightarrow 2} (x-2) \right] \Rightarrow \lim_{x \rightarrow 2} f(x) = 5$ as in part (a).

58. (a) $0 = 1 \cdot 0 = \left[\lim_{x \rightarrow 0} \frac{f(x)}{x^2} \right] \left[\lim_{x \rightarrow 0} x \right]^2 = \left[\lim_{x \rightarrow 0} \frac{f(x)}{x^2} \right] \left[\lim_{x \rightarrow 0} x^2 \right] = \lim_{x \rightarrow 0} \left[\frac{f(x)}{x^2} \cdot x^2 \right] = \lim_{x \rightarrow 0} f(x).$ That is, $\lim_{x \rightarrow 0} f(x) = 0.$

(b) $0 = 1 \cdot 0 = \left[\lim_{x \rightarrow 0} \frac{f(x)}{x^2} \right] \left[\lim_{x \rightarrow 0} x \right] = \lim_{x \rightarrow 0} \left[\frac{f(x)}{x^2} \cdot x \right] = \lim_{x \rightarrow 0} \frac{f(x)}{x}.$ That is, $\lim_{x \rightarrow 0} \frac{f(x)}{x} = 0.$

59. (a) $\lim_{x \rightarrow 0} x \sin \frac{1}{x} = 0$

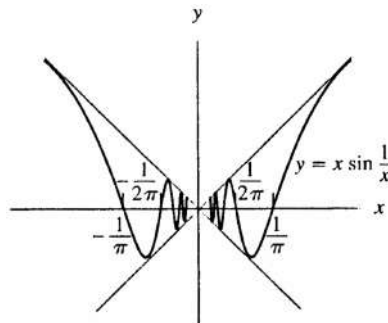

(b) $-1 \leq \sin \frac{1}{x} \leq 1$ for $x \neq 0$:

$x > 0 \Rightarrow -x \leq x \sin \frac{1}{x} \leq x \Rightarrow \lim_{x \rightarrow 0} x \sin \frac{1}{x} = 0$ by the sandwich theorem;

$x < 0 \Rightarrow -x \geq x \sin \frac{1}{x} \geq x \Rightarrow \lim_{x \rightarrow 0} x \sin \frac{1}{x} = 0$ by the sandwich theorem.

60. (a) $\lim_{x \rightarrow 0} x^2 \cos \left(\frac{1}{x^3} \right) = 0$

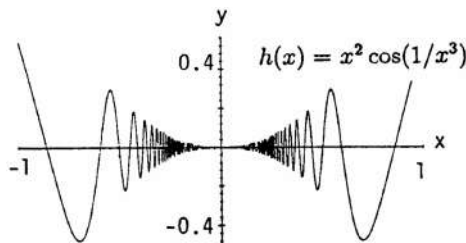

(b) $-1 \leq \cos \left(\frac{1}{x^3} \right) \leq 1$ for $x \neq 0 \Rightarrow -x^2 \leq x^2 \cos \left(\frac{1}{x^3} \right) \leq x^2 \Rightarrow \lim_{x \rightarrow 0} x^2 \cos \left(\frac{1}{x^3} \right) = 0$ by the sandwich theorem since $\lim_{x \rightarrow 0} x^2 = 0.$

2.3 PRECISE DEFINITION OF A LIMIT

1. $\left(\frac{1}{1} \quad \frac{1}{5} \quad \frac{1}{7} \right) \rightarrow x$

Step 1: $|x - 5| < \delta \Rightarrow -\delta < x - 5 < \delta \Rightarrow -\delta + 5 < x < \delta + 5$

Step 2: $\delta + 5 = 7 \Rightarrow \delta = 2$, or $-\delta + 5 = 1 \Rightarrow \delta = 4.$

The value of δ which assures $|x - 5| < \delta \Rightarrow 1 < x < 7$ is the smaller value, $\delta = 2.$

2.



Step 1: $|x - 2| < \delta \Rightarrow -\delta < x - 2 < \delta \Rightarrow -\delta + 2 < x < \delta + 2$

Step 2: $-\delta + 2 = 1 \Rightarrow \delta = 1$, or $\delta + 2 = 7 \Rightarrow \delta = 5$.

The value of δ which assures $|x - 2| < \delta \Rightarrow 1 < x < 7$ is the smaller value, $\delta = 1$.

3.



Step 1: $|x - (-3)| < \delta \Rightarrow -\delta < x + 3 < \delta \Rightarrow -\delta - 3 < x < \delta - 3$

Step 2: $-\delta - 3 = -\frac{7}{2} \Rightarrow \delta = \frac{1}{2}$, or $\delta - 3 = -\frac{1}{2} \Rightarrow \delta = \frac{5}{2}$.

The value of δ which assures $|x - (-3)| < \delta \Rightarrow -\frac{7}{2} < x < -\frac{1}{2}$ is the smaller value, $\delta = \frac{1}{2}$.

4.

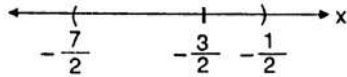

Step 1: $|x - (-\frac{3}{2})| < \delta \Rightarrow -\delta < x + \frac{3}{2} < \delta \Rightarrow -\delta - \frac{3}{2} < x < \delta - \frac{3}{2}$

Step 2: $-\delta - \frac{3}{2} = -\frac{7}{2} \Rightarrow \delta = 2$, or $\delta - \frac{3}{2} = -\frac{1}{2} \Rightarrow \delta = 1$.

The value of δ which assures $|x - (-\frac{3}{2})| < \delta \Rightarrow -\frac{7}{2} < x < -\frac{1}{2}$ is the smaller value, $\delta = 1$.

5.

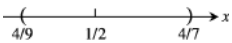

Step 1: $|x - \frac{1}{2}| < \delta \Rightarrow -\delta < x - \frac{1}{2} < \delta \Rightarrow -\delta + \frac{1}{2} < x < \delta + \frac{1}{2}$

Step 2: $-\delta + \frac{1}{2} = \frac{4}{9} \Rightarrow \delta = \frac{1}{18}$, or $\delta + \frac{1}{2} = \frac{4}{7} \Rightarrow \delta = \frac{1}{14}$.

The value of δ which assures $|x - \frac{1}{2}| < \delta \Rightarrow \frac{4}{9} < x < \frac{4}{7}$ is the smaller value, $\delta = \frac{1}{18}$.

6.

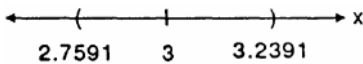

Step 1: $|x - 3| < \delta \Rightarrow -\delta < x - 3 < \delta \Rightarrow -\delta + 3 < x < \delta + 3$

Step 2: $-\delta + 3 = 2.7591 \Rightarrow \delta = 0.2409$, or $\delta + 3 = 3.2391 \Rightarrow \delta = 0.2391$.

The value of δ which assures $|x - 3| < \delta \Rightarrow 2.7591 < x < 3.2391$ is the smaller value, $\delta = 0.2391$.

7. Step 1:

$$|x - 5| < \delta \Rightarrow -\delta < x - 5 < \delta \Rightarrow -\delta + 5 < x < \delta + 5$$

Step 2: From the graph, $-\delta + 5 = 4.9 \Rightarrow \delta = 0.1$, or $\delta + 5 = 5.1 \Rightarrow \delta = 0.1$; thus $\delta = 0.1$ in either case.

8. Step 1:

$$|x - (-3)| < \delta \Rightarrow -\delta < x + 3 < \delta \Rightarrow -\delta - 3 < x < \delta - 3$$

Step 2: From the graph, $-\delta - 3 = -3.1 \Rightarrow \delta = 0.1$, or $\delta - 3 = -2.9 \Rightarrow \delta = 0.1$; thus $\delta = 0.1$.

9. Step 1:

$$|x - 1| < \delta \Rightarrow -\delta < x - 1 < \delta \Rightarrow -\delta + 1 < x < \delta + 1$$

Step 2: From the graph, $-\delta + 1 = \frac{9}{16} \Rightarrow \delta = \frac{7}{16}$, or $\delta + 1 = \frac{25}{16} \Rightarrow \delta = \frac{9}{16}$; thus $\delta = \frac{7}{16}$.

10. Step 1:

$$|x - 3| < \delta \Rightarrow -\delta < x - 3 < \delta \Rightarrow -\delta + 3 < x < \delta + 3$$

Step 2: From the graph, $-\delta + 3 = 2.61 \Rightarrow \delta = 0.39$, or $\delta + 3 = 3.41 \Rightarrow \delta = 0.41$; thus $\delta = 0.39$.

11. Step 1:

$$|x - 2| < \delta \Rightarrow -\delta < x - 2 < \delta \Rightarrow -\delta + 2 < x < \delta + 2$$

Step 2: From the graph, $-\delta + 2 = \sqrt{3} \Rightarrow \delta = 2 - \sqrt{3} \approx 0.2679$, or $\delta + 2 = \sqrt{5} \Rightarrow \delta = \sqrt{5} - 2 \approx 0.2361$; thus $\delta = \sqrt{5} - 2$.

12. Step 1: $|x - (-1)| < \delta \Rightarrow -\delta < x + 1 < \delta \Rightarrow -\delta - 1 < x < \delta - 1$
 Step 2: From the graph, $-\delta - 1 = -\frac{\sqrt{5}}{2} \Rightarrow \delta = \frac{\sqrt{5}-2}{2} \approx 0.1180$, or $\delta - 1 = -\frac{\sqrt{3}}{2} \Rightarrow \delta = \frac{2-\sqrt{3}}{2} \approx 0.1340$;
 thus $\delta = \frac{\sqrt{5}-2}{2}$.
13. Step 1: $|x - (-1)| < \delta \Rightarrow -\delta < x + 1 < \delta \Rightarrow -\delta - 1 < x < \delta - 1$
 Step 2: From the graph, $-\delta - 1 = -\frac{16}{9} \Rightarrow \delta = \frac{7}{9} \approx 0.77$, or $\delta - 1 = -\frac{16}{25} \Rightarrow \frac{9}{25} = 0.36$; thus $\delta = \frac{9}{25} = 0.36$.
14. Step 1: $|x - \frac{1}{2}| < \delta \Rightarrow -\delta < x - \frac{1}{2} < \delta \Rightarrow -\delta + \frac{1}{2} < x < \delta + \frac{1}{2}$
 Step 2: From the graph, $-\delta + \frac{1}{2} = \frac{1}{2.01} \Rightarrow \delta = \frac{1}{2} - \frac{1}{2.01} \approx 0.00248$, or $\delta + \frac{1}{2} = \frac{1}{1.99} \Rightarrow \delta = \frac{1}{1.99} - \frac{1}{2} \approx 0.00251$;
 thus $\delta = 0.00248$.
15. Step 1: $|(x + 1) - 5| < 0.01 \Rightarrow |x - 4| < 0.01 \Rightarrow -0.01 < x - 4 < 0.01 \Rightarrow 3.99 < x < 4.01$
 Step 2: $|x - 4| < \delta \Rightarrow -\delta < x - 4 < \delta \Rightarrow -\delta + 4 < x < \delta + 4 \Rightarrow \delta = 0.01$.
16. Step 1: $|(2x - 2) - (-6)| < 0.02 \Rightarrow |2x + 4| < 0.02 \Rightarrow -0.02 < 2x + 4 < 0.02 \Rightarrow -4.02 < 2x < -3.98$
 $\Rightarrow -2.01 < x < -1.99$
 Step 2: $|x - (-2)| < \delta \Rightarrow -\delta < x + 2 < \delta \Rightarrow -\delta - 2 < x < \delta - 2 \Rightarrow \delta = 0.01$.
17. Step 1: $|\sqrt{x+1} - 1| < 0.1 \Rightarrow -0.1 < \sqrt{x+1} - 1 < 0.1 \Rightarrow 0.9 < \sqrt{x+1} < 1.1 \Rightarrow 0.81 < x + 1 < 1.21$
 $\Rightarrow -0.19 < x < 0.21$
 Step 2: $|x - 0| < \delta \Rightarrow -\delta < x < \delta$. Then, $-\delta = -0.19 \Rightarrow \delta = 0.19$ or $\delta = 0.21$; thus, $\delta = 0.19$.
18. Step 1: $|\sqrt{x} - \frac{1}{2}| < 0.1 \Rightarrow -0.1 < \sqrt{x} - \frac{1}{2} < 0.1 \Rightarrow 0.4 < \sqrt{x} < 0.6 \Rightarrow 0.16 < x < 0.36$
 Step 2: $|x - \frac{1}{4}| < \delta \Rightarrow -\delta < x - \frac{1}{4} < \delta \Rightarrow -\delta + \frac{1}{4} < x < \delta + \frac{1}{4}$.
 Then, $-\delta + \frac{1}{4} = 0.16 \Rightarrow \delta = 0.09$ or $\delta + \frac{1}{4} = 0.36 \Rightarrow \delta = 0.11$; thus $\delta = 0.09$.
19. Step 1: $|\sqrt{19-x} - 3| < 1 \Rightarrow -1 < \sqrt{19-x} - 3 < 1 \Rightarrow 2 < \sqrt{19-x} < 4 \Rightarrow 4 < 19 - x < 16$
 $\Rightarrow -4 > x - 19 > -16 \Rightarrow 15 > x > 3$ or $3 < x < 15$
 Step 2: $|x - 10| < \delta \Rightarrow -\delta < x - 10 < \delta \Rightarrow -\delta + 10 < x < \delta + 10$.
 Then $-\delta + 10 = 3 \Rightarrow \delta = 7$, or $\delta + 10 = 15 \Rightarrow \delta = 5$; thus $\delta = 5$.
20. Step 1: $|\sqrt{x-7} - 4| < 1 \Rightarrow -1 < \sqrt{x-7} - 4 < 1 \Rightarrow 3 < \sqrt{x-7} < 5 \Rightarrow 9 < x - 7 < 25 \Rightarrow 16 < x < 32$
 Step 2: $|x - 23| < \delta \Rightarrow -\delta < x - 23 < \delta \Rightarrow -\delta + 23 < x < \delta + 23$.
 Then $-\delta + 23 = 16 \Rightarrow \delta = 7$, or $\delta + 23 = 32 \Rightarrow \delta = 9$; thus $\delta = 7$.
21. Step 1: $|\frac{1}{x} - \frac{1}{4}| < 0.05 \Rightarrow -0.05 < \frac{1}{x} - \frac{1}{4} < 0.05 \Rightarrow 0.2 < \frac{1}{x} < 0.3 \Rightarrow \frac{10}{2} > x > \frac{10}{3}$ or $\frac{10}{3} < x < 5$.
 Step 2: $|x - 4| < \delta \Rightarrow -\delta < x - 4 < \delta \Rightarrow -\delta + 4 < x < \delta + 4$.
 Then $-\delta + 4 = \frac{10}{3}$ or $\delta = \frac{2}{3}$, or $\delta + 4 = 5$ or $\delta = 1$; thus $\delta = \frac{2}{3}$.
22. Step 1: $|x^2 - 3| < 0.1 \Rightarrow -0.1 < x^2 - 3 < 0.1 \Rightarrow 2.9 < x^2 < 3.1 \Rightarrow \sqrt{2.9} < x < \sqrt{3.1}$
 Step 2: $|x - \sqrt{3}| < \delta \Rightarrow -\delta < x - \sqrt{3} < \delta \Rightarrow -\delta + \sqrt{3} < x < \delta + \sqrt{3}$.
 Then $-\delta + \sqrt{3} = \sqrt{2.9} \Rightarrow \delta = \sqrt{3} - \sqrt{2.9} \approx 0.0291$, or $\delta + \sqrt{3} = \sqrt{3.1} \Rightarrow \delta = \sqrt{3.1} - \sqrt{3} \approx 0.0286$;
 thus $\delta = 0.0286$.

23. Step 1: $|x^2 - 4| < 0.5 \Rightarrow -0.5 < x^2 - 4 < 0.5 \Rightarrow 3.5 < x^2 < 4.5 \Rightarrow \sqrt{3.5} < |x| < \sqrt{4.5} \Rightarrow -\sqrt{4.5} < x < -\sqrt{3.5}$,
for x near -2 .
Step 2: $|x - (-2)| < \delta \Rightarrow -\delta < x + 2 < \delta \Rightarrow -\delta - 2 < x < \delta - 2$.
Then $-\delta - 2 = -\sqrt{4.5} \Rightarrow \delta = \sqrt{4.5} - 2 \approx 0.1213$, or $\delta - 2 = -\sqrt{3.5} \Rightarrow \delta = 2 - \sqrt{3.5} \approx 0.1292$;
thus $\delta = \sqrt{4.5} - 2 \approx 0.12$.
24. Step 1: $|\frac{1}{x} - (-1)| < 0.1 \Rightarrow -0.1 < \frac{1}{x} + 1 < 0.1 \Rightarrow -\frac{11}{10} < \frac{1}{x} < -\frac{9}{10} \Rightarrow -\frac{10}{11} > x > -\frac{10}{9}$ or $-\frac{10}{9} < x < -\frac{10}{11}$.
Step 2: $|x - (-1)| < \delta \Rightarrow -\delta < x + 1 < \delta \Rightarrow -\delta - 1 < x < \delta - 1$.
Then $-\delta - 1 = -\frac{10}{9} \Rightarrow \delta = \frac{1}{9}$, or $\delta - 1 = -\frac{10}{11} \Rightarrow \delta = \frac{1}{11}$; thus $\delta = \frac{1}{11}$.
25. Step 1: $|(x^2 - 5) - 11| < 1 \Rightarrow |x^2 - 16| < 1 \Rightarrow -1 < x^2 - 16 < 1 \Rightarrow 15 < x^2 < 17 \Rightarrow \sqrt{15} < x < \sqrt{17}$.
Step 2: $|x - 4| < \delta \Rightarrow -\delta < x - 4 < \delta \Rightarrow -\delta + 4 < x < \delta + 4$.
Then $-\delta + 4 = \sqrt{15} \Rightarrow \delta = 4 - \sqrt{15} \approx 0.1270$, or $\delta + 4 = \sqrt{17} \Rightarrow \delta = \sqrt{17} - 4 \approx 0.1231$;
thus $\delta = \sqrt{17} - 4 \approx 0.12$.
26. Step 1: $|\frac{120}{x} - 5| < 1 \Rightarrow -1 < \frac{120}{x} - 5 < 1 \Rightarrow 4 < \frac{120}{x} < 6 \Rightarrow \frac{1}{4} > \frac{x}{120} > \frac{1}{6} \Rightarrow 30 > x > 20$ or $20 < x < 30$.
Step 2: $|x - 24| < \delta \Rightarrow -\delta < x - 24 < \delta \Rightarrow -\delta + 24 < x < \delta + 24$.
Then $-\delta + 24 = 20 \Rightarrow \delta = 4$, or $\delta + 24 = 30 \Rightarrow \delta = 6$; thus $\delta = 4$.
27. Step 1: $|mx - 2m| < 0.03 \Rightarrow -0.03 < mx - 2m < 0.03 \Rightarrow -0.03 + 2m < mx < 0.03 + 2m \Rightarrow$
 $2 - \frac{0.03}{m} < x < 2 + \frac{0.03}{m}$.
Step 2: $|x - 2| < \delta \Rightarrow -\delta < x - 2 < \delta \Rightarrow -\delta + 2 < x < \delta + 2$.
Then $-\delta + 2 = 2 - \frac{0.03}{m} \Rightarrow \delta = \frac{0.03}{m}$, or $\delta + 2 = 2 + \frac{0.03}{m} \Rightarrow \delta = \frac{0.03}{m}$. In either case, $\delta = \frac{0.03}{m}$.
28. Step 1: $|mx - 3m| < c \Rightarrow -c < mx - 3m < c \Rightarrow -c + 3m < mx < c + 3m \Rightarrow 3 - \frac{c}{m} < x < 3 + \frac{c}{m}$
Step 2: $|x - 3| < \delta \Rightarrow -\delta < x - 3 < \delta \Rightarrow -\delta + 3 < x < \delta + 3$.
Then $-\delta + 3 = 3 - \frac{c}{m} \Rightarrow \delta = \frac{c}{m}$, or $\delta + 3 = 3 + \frac{c}{m} \Rightarrow \delta = \frac{c}{m}$. In either case, $\delta = \frac{c}{m}$.
29. Step 1: $|(mx + b) - (\frac{m}{2} + b)| < c \Rightarrow -c < mx - \frac{m}{2} < c \Rightarrow -c + \frac{m}{2} < mx < c + \frac{m}{2} \Rightarrow \frac{1}{2} - \frac{c}{m} < x < \frac{1}{2} + \frac{c}{m}$.
Step 2: $|x - \frac{1}{2}| < \delta \Rightarrow -\delta < x - \frac{1}{2} < \delta \Rightarrow -\delta + \frac{1}{2} < x < \delta + \frac{1}{2}$.
Then $-\delta + \frac{1}{2} = \frac{1}{2} - \frac{c}{m} \Rightarrow \delta = \frac{c}{m}$, or $\delta + \frac{1}{2} = \frac{1}{2} + \frac{c}{m} \Rightarrow \delta = \frac{c}{m}$. In either case, $\delta = \frac{c}{m}$.
30. Step 1: $|(mx + b) - (m + b)| < 0.05 \Rightarrow -0.05 < mx - m < 0.05 \Rightarrow -0.05 + m < mx < 0.05 + m$
 $\Rightarrow 1 - \frac{0.05}{m} < x < 1 + \frac{0.05}{m}$.
Step 2: $|x - 1| < \delta \Rightarrow -\delta < x - 1 < \delta \Rightarrow -\delta + 1 < x < \delta + 1$.
Then $-\delta + 1 = 1 - \frac{0.05}{m} \Rightarrow \delta = \frac{0.05}{m}$, or $\delta + 1 = 1 + \frac{0.05}{m} \Rightarrow \delta = \frac{0.05}{m}$. In either case, $\delta = \frac{0.05}{m}$.
31. $\lim_{x \rightarrow 3} (3 - 2x) = 3 - 2(3) = -3$
Step 1: $|(3 - 2x) - (-3)| < 0.02 \Rightarrow -0.02 < 6 - 2x < 0.02 \Rightarrow -6.02 < -2x < -5.98 \Rightarrow 3.01 > x > 2.99$ or
 $2.99 < x < 3.01$.
Step 2: $0 < |x - 3| < \delta \Rightarrow -\delta < x - 3 < \delta \Rightarrow -\delta + 3 < x < \delta + 3$.
Then $-\delta + 3 = 2.99 \Rightarrow \delta = 0.01$, or $\delta + 3 = 3.01 \Rightarrow \delta = 0.01$; thus $\delta = 0.01$.
32. $\lim_{x \rightarrow -1} (-3x - 2) = (-3)(-1) - 2 = 1$
Step 1: $|(-3x - 2) - 1| < 0.03 \Rightarrow -0.03 < -3x - 3 < 0.03 \Rightarrow 0.01 > x + 1 > -0.01 \Rightarrow -1.01 < x < -0.99$.

82 Chapter 2 Limits and Continuity

Step 2: $|x - (-1)| < \delta \Rightarrow -\delta < x + 1 < \delta \Rightarrow -\delta - 1 < x < \delta - 1$.
Then $-\delta - 1 = -1.01 \Rightarrow \delta = 0.01$, or $\delta - 1 = -0.99 \Rightarrow \delta = 0.01$; thus $\delta = 0.01$.

33. $\lim_{x \rightarrow 2} \frac{x^2 - 4}{x - 2} = \lim_{x \rightarrow 2} \frac{(x+2)(x-2)}{(x-2)} = \lim_{x \rightarrow 2} (x + 2) = 2 + 2 = 4, x \neq 2$

Step 1: $\left| \left(\frac{x^2 - 4}{x - 2} \right) - 4 \right| < 0.05 \Rightarrow -0.05 < \frac{(x+2)(x-2)}{(x-2)} - 4 < 0.05 \Rightarrow 3.95 < x + 2 < 4.05, x \neq 2$
 $\Rightarrow 1.95 < x < 2.05, x \neq 2$.

Step 2: $|x - 2| < \delta \Rightarrow -\delta < x - 2 < \delta \Rightarrow -\delta + 2 < x < \delta + 2$.
Then $-\delta + 2 = 1.95 \Rightarrow \delta = 0.05$, or $\delta + 2 = 2.05 \Rightarrow \delta = 0.05$; thus $\delta = 0.05$.

34. $\lim_{x \rightarrow -5} \frac{x^2 + 6x + 5}{x + 5} = \lim_{x \rightarrow -5} \frac{(x+5)(x+1)}{(x+5)} = \lim_{x \rightarrow -5} (x + 1) = -4, x \neq -5$.

Step 1: $\left| \left(\frac{x^2 + 6x + 5}{x + 5} \right) - (-4) \right| < 0.05 \Rightarrow -0.05 < \frac{(x+5)(x+1)}{(x+5)} + 4 < 0.05 \Rightarrow -4.05 < x + 1 < -3.95, x \neq -5$
 $\Rightarrow -5.05 < x < -4.95, x \neq -5$.

Step 2: $|x - (-5)| < \delta \Rightarrow -\delta < x + 5 < \delta \Rightarrow -\delta - 5 < x < \delta - 5$.
Then $-\delta - 5 = -5.05 \Rightarrow \delta = 0.05$, or $\delta - 5 = -4.95 \Rightarrow \delta = 0.05$; thus $\delta = 0.05$.

35. $\lim_{x \rightarrow -3} \sqrt{1 - 5x} = \sqrt{1 - 5(-3)} = \sqrt{16} = 4$

Step 1: $\left| \sqrt{1 - 5x} - 4 \right| < 0.5 \Rightarrow -0.5 < \sqrt{1 - 5x} - 4 < 0.5 \Rightarrow 3.5 < \sqrt{1 - 5x} < 4.5 \Rightarrow 12.25 < 1 - 5x < 20.25$
 $\Rightarrow 11.25 < -5x < 19.25 \Rightarrow -3.85 < x < -2.25$.

Step 2: $|x - (-3)| < \delta \Rightarrow -\delta < x + 3 < \delta \Rightarrow -\delta - 3 < x < \delta - 3$.
Then $-\delta - 3 = -3.85 \Rightarrow \delta = 0.85$, or $\delta - 3 = -2.25 \Rightarrow \delta = 0.75$; thus $\delta = 0.75$.

36. $\lim_{x \rightarrow 2} \frac{4}{x} = \frac{4}{2} = 2$

Step 1: $\left| \frac{4}{x} - 2 \right| < 0.4 \Rightarrow -0.4 < \frac{4}{x} - 2 < 0.4 \Rightarrow 1.6 < \frac{4}{x} < 2.4 \Rightarrow \frac{10}{16} > \frac{x}{4} > \frac{10}{24} \Rightarrow \frac{10}{4} > x > \frac{10}{6}$ or $\frac{5}{3} < x < \frac{5}{2}$.

Step 2: $|x - 2| < \delta \Rightarrow -\delta < x - 2 < \delta \Rightarrow -\delta + 2 < x < \delta + 2$.
Then $-\delta + 2 = \frac{5}{3} \Rightarrow \delta = \frac{1}{3}$, or $\delta + 2 = \frac{5}{2} \Rightarrow \delta = \frac{1}{2}$; thus $\delta = \frac{1}{3}$.

37. Step 1: $|(9 - x) - 5| < \epsilon \Rightarrow -\epsilon < 4 - x < \epsilon \Rightarrow -\epsilon - 4 < -x < \epsilon - 4 \Rightarrow \epsilon + 4 > x > 4 - \epsilon \Rightarrow 4 - \epsilon < x < 4 + \epsilon$.

Step 2: $|x - 4| < \delta \Rightarrow -\delta < x - 4 < \delta \Rightarrow -\delta + 4 < x < \delta + 4$.
Then $-\delta + 4 = -\epsilon + 4 \Rightarrow \delta = \epsilon$, or $\delta + 4 = \epsilon + 4 \Rightarrow \delta = \epsilon$. Thus choose $\delta = \epsilon$.

38. Step 1: $|(3x - 7) - 2| < \epsilon \Rightarrow -\epsilon < 3x - 9 < \epsilon \Rightarrow 9 - \epsilon < 3x < 9 + \epsilon \Rightarrow 3 - \frac{\epsilon}{3} < x < 3 + \frac{\epsilon}{3}$.

Step 2: $|x - 3| < \delta \Rightarrow -\delta < x - 3 < \delta \Rightarrow -\delta + 3 < x < \delta + 3$.
Then $-\delta + 3 = 3 - \frac{\epsilon}{3} \Rightarrow \delta = \frac{\epsilon}{3}$, or $\delta + 3 = 3 + \frac{\epsilon}{3} \Rightarrow \delta = \frac{\epsilon}{3}$. Thus choose $\delta = \frac{\epsilon}{3}$.

39. Step 1: $\left| \sqrt{x - 5} - 2 \right| < \epsilon \Rightarrow -\epsilon < \sqrt{x - 5} - 2 < \epsilon \Rightarrow 2 - \epsilon < \sqrt{x - 5} < 2 + \epsilon \Rightarrow (2 - \epsilon)^2 < x - 5 < (2 + \epsilon)^2$
 $\Rightarrow (2 - \epsilon)^2 + 5 < x < (2 + \epsilon)^2 + 5$.

Step 2: $|x - 9| < \delta \Rightarrow -\delta < x - 9 < \delta \Rightarrow -\delta + 9 < x < \delta + 9$.
Then $-\delta + 9 = \epsilon^2 - 4\epsilon + 9 \Rightarrow \delta = 4\epsilon - \epsilon^2$, or $\delta + 9 = \epsilon^2 + 4\epsilon + 9 \Rightarrow \delta = 4\epsilon + \epsilon^2$. Thus choose the smaller distance, $\delta = 4\epsilon - \epsilon^2$.

40. Step 1: $\left| \sqrt{4 - x} - 2 \right| < \epsilon \Rightarrow -\epsilon < \sqrt{4 - x} - 2 < \epsilon \Rightarrow 2 - \epsilon < \sqrt{4 - x} < 2 + \epsilon \Rightarrow (2 - \epsilon)^2 < 4 - x < (2 + \epsilon)^2$
 $\Rightarrow -(2 + \epsilon)^2 < x - 4 < -(2 - \epsilon)^2 \Rightarrow -(2 + \epsilon)^2 + 4 < x < -(2 - \epsilon)^2 + 4$.

Step 2: $|x - 0| < \delta \Rightarrow -\delta < x < \delta$.

Then $-\delta = -(2 + \epsilon)^2 + 4 = -\epsilon^2 - 4\epsilon \Rightarrow \delta = 4\epsilon + \epsilon^2$, or $\delta = -(2 - \epsilon)^2 + 4 = 4\epsilon - \epsilon^2$. Thus choose the smaller distance, $\delta = 4\epsilon - \epsilon^2$.

41. Step 1: For $x \neq 1$, $|x^2 - 1| < \epsilon \Rightarrow -\epsilon < x^2 - 1 < \epsilon \Rightarrow 1 - \epsilon < x^2 < 1 + \epsilon \Rightarrow \sqrt{1 - \epsilon} < |x| < \sqrt{1 + \epsilon}$
 $\Rightarrow \sqrt{1 - \epsilon} < x < \sqrt{1 + \epsilon}$ near $x = 1$.

Step 2: $|x - 1| < \delta \Rightarrow -\delta < x - 1 < \delta \Rightarrow -\delta + 1 < x < \delta + 1$.

Then $-\delta + 1 = \sqrt{1 - \epsilon} \Rightarrow \delta = 1 - \sqrt{1 - \epsilon}$, or $\delta + 1 = \sqrt{1 + \epsilon} \Rightarrow \delta = \sqrt{1 + \epsilon} - 1$. Choose

$\delta = \min \left\{ 1 - \sqrt{1 - \epsilon}, \sqrt{1 + \epsilon} - 1 \right\}$, that is, the smaller of the two distances.

42. Step 1: For $x \neq -2$, $|x^2 - 4| < \epsilon \Rightarrow -\epsilon < x^2 - 4 < \epsilon \Rightarrow 4 - \epsilon < x^2 < 4 + \epsilon \Rightarrow \sqrt{4 - \epsilon} < |x| < \sqrt{4 + \epsilon}$
 $\Rightarrow -\sqrt{4 + \epsilon} < x < -\sqrt{4 - \epsilon}$ near $x = -2$.

Step 2: $|x - (-2)| < \delta \Rightarrow -\delta < x + 2 < \delta \Rightarrow -\delta - 2 < x < \delta - 2$.

Then $-\delta - 2 = -\sqrt{4 + \epsilon} \Rightarrow \delta = \sqrt{4 + \epsilon} - 2$, or $\delta - 2 = -\sqrt{4 - \epsilon} \Rightarrow \delta = 2 - \sqrt{4 - \epsilon}$. Choose

$\delta = \min \left\{ \sqrt{4 + \epsilon} - 2, 2 - \sqrt{4 - \epsilon} \right\}$.

43. Step 1: $\left| \frac{1}{x} - 1 \right| < \epsilon \Rightarrow -\epsilon < \frac{1}{x} - 1 < \epsilon \Rightarrow 1 - \epsilon < \frac{1}{x} < 1 + \epsilon \Rightarrow \frac{1}{1 + \epsilon} < x < \frac{1}{1 - \epsilon}$.

Step 2: $|x - 1| < \delta \Rightarrow -\delta < x - 1 < \delta \Rightarrow 1 - \delta < x < 1 + \delta$.

Then $1 - \delta = \frac{1}{1 + \epsilon} \Rightarrow \delta = 1 - \frac{1}{1 + \epsilon} = \frac{\epsilon}{1 + \epsilon}$, or $1 + \delta = \frac{1}{1 - \epsilon} \Rightarrow \delta = \frac{1}{1 - \epsilon} - 1 = \frac{\epsilon}{1 - \epsilon}$.

Choose $\delta = \frac{\epsilon}{1 + \epsilon}$, the smaller of the two distances.

44. Step 1: $\left| \frac{1}{x^2} - \frac{1}{3} \right| < \epsilon \Rightarrow -\epsilon < \frac{1}{x^2} - \frac{1}{3} < \epsilon \Rightarrow \frac{1}{3} - \epsilon < \frac{1}{x^2} < \frac{1}{3} + \epsilon \Rightarrow \frac{1 - 3\epsilon}{3} < \frac{1}{x^2} < \frac{1 + 3\epsilon}{3} \Rightarrow \frac{3}{1 - 3\epsilon} > x^2 > \frac{3}{1 + 3\epsilon}$
 $\Rightarrow \sqrt{\frac{3}{1 + 3\epsilon}} < |x| < \sqrt{\frac{3}{1 - 3\epsilon}}$, or $\sqrt{\frac{3}{1 + 3\epsilon}} < x < \sqrt{\frac{3}{1 - 3\epsilon}}$ for x near $\sqrt{3}$.

Step 2: $|x - \sqrt{3}| < \delta \Rightarrow -\delta < x - \sqrt{3} < \delta \Rightarrow \sqrt{3} - \delta < x < \sqrt{3} + \delta$.

Then $\sqrt{3} - \delta = \sqrt{\frac{3}{1 + 3\epsilon}} \Rightarrow \delta = \sqrt{3} - \sqrt{\frac{3}{1 + 3\epsilon}}$, or $\sqrt{3} + \delta = \sqrt{\frac{3}{1 - 3\epsilon}} \Rightarrow \delta = \sqrt{\frac{3}{1 - 3\epsilon}} - \sqrt{3}$.

Choose $\delta = \min \left\{ \sqrt{3} - \sqrt{\frac{3}{1 + 3\epsilon}}, \sqrt{\frac{3}{1 - 3\epsilon}} - \sqrt{3} \right\}$.

45. Step 1: $\left| \left(\frac{x^2 - 9}{x + 3} \right) - (-6) \right| < \epsilon \Rightarrow -\epsilon < (x - 3) + 6 < \epsilon, x \neq -3 \Rightarrow -\epsilon < x + 3 < \epsilon \Rightarrow -\epsilon - 3 < x < \epsilon - 3$.

Step 2: $|x - (-3)| < \delta \Rightarrow -\delta < x + 3 < \delta \Rightarrow -\delta - 3 < x < \delta - 3$.

Then $-\delta - 3 = -\epsilon - 3 \Rightarrow \delta = \epsilon$, or $\delta - 3 = \epsilon - 3 \Rightarrow \delta = \epsilon$. Choose $\delta = \epsilon$.

46. Step 1: $\left| \left(\frac{x^2 - 1}{x - 1} \right) - 2 \right| < \epsilon \Rightarrow -\epsilon < (x + 1) - 2 < \epsilon, x \neq 1 \Rightarrow 1 - \epsilon < x < 1 + \epsilon$.

Step 2: $|x - 1| < \delta \Rightarrow -\delta < x - 1 < \delta \Rightarrow 1 - \delta < x < 1 + \delta$.

Then $1 - \delta = 1 - \epsilon \Rightarrow \delta = \epsilon$, or $1 + \delta = 1 + \epsilon \Rightarrow \delta = \epsilon$. Choose $\delta = \epsilon$.

47. Step 1: $x < 1$: $|(4 - 2x) - 2| < \epsilon \Rightarrow 0 < 2 - 2x < \epsilon$ since $x < 1$. Thus, $1 - \frac{\epsilon}{2} < x < 0$;

$x \geq 1$: $|(6x - 4) - 2| < \epsilon \Rightarrow 0 \leq 6x - 6 < \epsilon$ since $x \geq 1$. Thus, $1 \leq x < 1 + \frac{\epsilon}{6}$.

Step 2: $|x - 1| < \delta \Rightarrow -\delta < x - 1 < \delta \Rightarrow 1 - \delta < x < 1 + \delta$.

Then $1 - \delta = 1 - \frac{\epsilon}{2} \Rightarrow \delta = \frac{\epsilon}{2}$, or $1 + \delta = 1 + \frac{\epsilon}{6} \Rightarrow \delta = \frac{\epsilon}{6}$. Choose $\delta = \frac{\epsilon}{6}$.

48. Step 1: $x < 0$: $|2x - 0| < \epsilon \Rightarrow -\epsilon < 2x < 0 \Rightarrow -\frac{\epsilon}{2} < x < 0$;

$x \geq 0$: $\left| \frac{x}{2} - 0 \right| < \epsilon \Rightarrow 0 \leq x < 2\epsilon$.

84 Chapter 2 Limits and Continuity

Step 2: $|x - 0| < \delta \Rightarrow -\delta < x < \delta$.

Then $-\delta = -\frac{\epsilon}{2} \Rightarrow \delta = \frac{\epsilon}{2}$, or $\delta = 2\epsilon \Rightarrow \delta = 2\epsilon$. Choose $\delta = \frac{\epsilon}{2}$.

49. By the figure, $-x \leq x \sin \frac{1}{x} \leq x$ for all $x > 0$ and $-x \geq x \sin \frac{1}{x} \geq x$ for $x < 0$. Since $\lim_{x \rightarrow 0} (-x) = \lim_{x \rightarrow 0} x = 0$, then by the sandwich theorem, in either case, $\lim_{x \rightarrow 0} x \sin \frac{1}{x} = 0$.

50. By the figure, $-x^2 \leq x^2 \sin \frac{1}{x} \leq x^2$ for all x except possibly at $x = 0$. Since $\lim_{x \rightarrow 0} (-x^2) = \lim_{x \rightarrow 0} x^2 = 0$, then by the sandwich theorem, $\lim_{x \rightarrow 0} x^2 \sin \frac{1}{x} = 0$.

51. As x approaches the value 0, the values of $g(x)$ approach k . Thus for every number $\epsilon > 0$, there exists a $\delta > 0$ such that $0 < |x - 0| < \delta \Rightarrow |g(x) - k| < \epsilon$.

52. Write $x = h + c$. Then $0 < |x - c| < \delta \Leftrightarrow -\delta < x - c < \delta, x \neq c \Leftrightarrow -\delta < (h + c) - c < \delta, h + c \neq c$
 $\Leftrightarrow -\delta < h < \delta, h \neq 0 \Leftrightarrow 0 < |h - 0| < \delta$.

Thus, $\lim_{x \rightarrow c} f(x) = L \Leftrightarrow$ for any $\epsilon > 0$, there exists $\delta > 0$ such that $|f(x) - L| < \epsilon$ whenever $0 < |x - c| < \delta$
 $\Leftrightarrow |f(h + c) - L| < \epsilon$ whenever $0 < |h - 0| < \delta \Leftrightarrow \lim_{h \rightarrow 0} f(h + c) = L$.

53. Let $f(x) = x^2$. The function values do get closer to -1 as x approaches 0, but $\lim_{x \rightarrow 0} f(x) = 0$, not -1 . The function $f(x) = x^2$ never gets arbitrarily close to -1 for x near 0.

54. Let $f(x) = \sin x, L = \frac{1}{2}$, and $x_0 = 0$. There exists a value of x (namely, $x = \frac{\pi}{6}$) for which $|\sin x - \frac{1}{2}| < \epsilon$ for any given $\epsilon > 0$. However, $\lim_{x \rightarrow 0} \sin x = 0$, not $\frac{1}{2}$. The wrong statement does not require x to be arbitrarily close to x_0 . As another example, let $g(x) = \sin \frac{1}{x}, L = \frac{1}{2}$, and $x_0 = 0$. We can choose infinitely many values of x near 0 such that $\sin \frac{1}{x} = \frac{1}{2}$ as you can see from the accompanying figure. However, $\lim_{x \rightarrow 0} \sin \frac{1}{x}$ fails to exist. The wrong statement does not require all values of x arbitrarily close to $x_0 = 0$ to lie within $\epsilon > 0$ of $L = \frac{1}{2}$. Again you can see from the figure that there are also infinitely many values of x near 0 such that $\sin \frac{1}{x} = 0$. If we choose $\epsilon < \frac{1}{4}$ we cannot satisfy the inequality $|\sin \frac{1}{x} - \frac{1}{2}| < \epsilon$ for all values of x sufficiently near $x_0 = 0$.

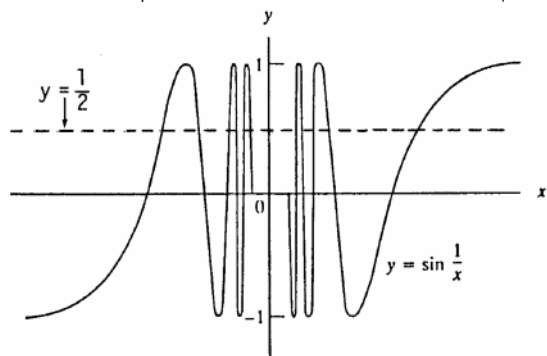

55. $|A - 9| \leq 0.01 \Rightarrow -0.01 \leq \pi \left(\frac{x}{2}\right)^2 - 9 \leq 0.01 \Rightarrow 8.99 \leq \frac{\pi x^2}{4} \leq 9.01 \Rightarrow \frac{4}{\pi}(8.99) \leq x^2 \leq \frac{4}{\pi}(9.01)$
 $\Rightarrow 2\sqrt{\frac{8.99}{\pi}} \leq x \leq 2\sqrt{\frac{9.01}{\pi}}$ or $3.384 \leq x \leq 3.387$. To be safe, the left endpoint was rounded up and the right endpoint was rounded down.

56. $V = RI \Rightarrow \frac{V}{R} = I \Rightarrow \left|\frac{V}{R} - 5\right| \leq 0.1 \Rightarrow -0.1 \leq \frac{120}{R} - 5 \leq 0.1 \Rightarrow 4.9 \leq \frac{120}{R} \leq 5.1 \Rightarrow \frac{10}{49} \geq \frac{R}{120} \geq \frac{10}{51} \Rightarrow$

$$\frac{(120)(10)}{51} \leq R \leq \frac{(120)(10)}{49} \Rightarrow 23.53 \leq R \leq 24.48.$$

To be safe, the left endpoint was rounded up and the right endpoint was rounded down.

57. (a) $-\delta < x - 1 < 0 \Rightarrow 1 - \delta < x < 1 \Rightarrow f(x) = x$. Then $|f(x) - 2| = |x - 2| = 2 - x > 2 - 1 = 1$. That is, $|f(x) - 2| \geq 1 \geq \frac{1}{2}$ no matter how small δ is taken when $1 - \delta < x < 1 \Rightarrow \lim_{x \rightarrow 1} f(x) \neq 2$.
- (b) $0 < x - 1 < \delta \Rightarrow 1 < x < 1 + \delta \Rightarrow f(x) = x + 1$. Then $|f(x) - 1| = |(x + 1) - 1| = |x| = x > 1$. That is, $|f(x) - 1| \geq 1$ no matter how small δ is taken when $1 < x < 1 + \delta \Rightarrow \lim_{x \rightarrow 1} f(x) \neq 1$.
- (c) $-\delta < x - 1 < 0 \Rightarrow 1 - \delta < x < 1 \Rightarrow f(x) = x$. Then $|f(x) - 1.5| = |x - 1.5| = 1.5 - x > 1.5 - 1 = 0.5$. Also, $0 < x - 1 < \delta \Rightarrow 1 < x < 1 + \delta \Rightarrow f(x) = x + 1$. Then $|f(x) - 1.5| = |(x + 1) - 1.5| = |x - 0.5| = x - 0.5 > 1 - 0.5 = 0.5$. Thus, no matter how small δ is taken, there exists a value of x such that $-\delta < x - 1 < \delta$ but $|f(x) - 1.5| \geq \frac{1}{2} \Rightarrow \lim_{x \rightarrow 1} f(x) \neq 1.5$.
58. (a) For $2 < x < 2 + \delta \Rightarrow h(x) = 2 \Rightarrow |h(x) - 4| = 2$. Thus for $\epsilon < 2$, $|h(x) - 4| \geq \epsilon$ whenever $2 < x < 2 + \delta$ no matter how small we choose $\delta > 0 \Rightarrow \lim_{x \rightarrow 2} h(x) \neq 4$.
- (b) For $2 < x < 2 + \delta \Rightarrow h(x) = 2 \Rightarrow |h(x) - 3| = 1$. Thus for $\epsilon < 1$, $|h(x) - 3| \geq \epsilon$ whenever $2 < x < 2 + \delta$ no matter how small we choose $\delta > 0 \Rightarrow \lim_{x \rightarrow 2} h(x) \neq 3$.
- (c) For $2 - \delta < x < 2 \Rightarrow h(x) = x^2$ so $|h(x) - 2| = |x^2 - 2|$. No matter how small $\delta > 0$ is chosen, x^2 is close to 4 when x is near 2 and to the left on the real line $\Rightarrow |x^2 - 2|$ will be close to 2. Thus if $\epsilon < 1$, $|h(x) - 2| \geq \epsilon$ whenever $2 - \delta < x < 2$ no matter how small we choose $\delta > 0 \Rightarrow \lim_{x \rightarrow 2} h(x) \neq 2$.
59. (a) For $3 - \delta < x < 3 \Rightarrow f(x) > 4.8 \Rightarrow |f(x) - 4| \geq 0.8$. Thus for $\epsilon < 0.8$, $|f(x) - 4| \geq \epsilon$ whenever $3 - \delta < x < 3$ no matter how small we choose $\delta > 0 \Rightarrow \lim_{x \rightarrow 3} f(x) \neq 4$.
- (b) For $3 < x < 3 + \delta \Rightarrow f(x) < 3 \Rightarrow |f(x) - 4.8| \geq 1.8$. Thus for $\epsilon < 1.8$, $|f(x) - 4.8| \geq \epsilon$ whenever $3 < x < 3 + \delta$ no matter how small we choose $\delta > 0 \Rightarrow \lim_{x \rightarrow 3} f(x) \neq 4.8$.
- (c) For $3 - \delta < x < 3 \Rightarrow f(x) > 4.8 \Rightarrow |f(x) - 3| \geq 1.8$. Again, for $\epsilon < 1.8$, $|f(x) - 3| \geq \epsilon$ whenever $3 - \delta < x < 3$ no matter how small we choose $\delta > 0 \Rightarrow \lim_{x \rightarrow 3} f(x) \neq 3$.
60. (a) No matter how small we choose $\delta > 0$, for x near -1 satisfying $-1 - \delta < x < -1 + \delta$, the values of $g(x)$ are near 1 $\Rightarrow |g(x) - 2|$ is near 1. Then, for $\epsilon = \frac{1}{2}$ we have $|g(x) - 2| \geq \frac{1}{2}$ for some x satisfying $-1 - \delta < x < -1 + \delta$, or $0 < |x + 1| < \delta \Rightarrow \lim_{x \rightarrow -1} g(x) \neq 2$.
- (b) Yes, $\lim_{x \rightarrow -1} g(x) = 1$ because from the graph we can find a $\delta > 0$ such that $|g(x) - 1| < \epsilon$ if $0 < |x - (-1)| < \delta$.

61-66. Example CAS commands (values of del may vary for a specified eps):

Maple:

```
f := x -> (x^4-81)/(x-3); x0 := 3;
plot( f(x), x=x0-1..x0+1, color=black, # (a)
      title="Section 2.3, #61(a)" );
L := limit( f(x), x=x0 ); # (b)
epsilon := 0.2; # (c)
plot( [f(x), L-epsilon, L+epsilon], x=x0-0.01..x0+0.01,
      color=black, linestyle=[1,3,3], title="Section 2.3, #61(c)" );
q := fsolve( abs( f(x)-L ) = epsilon, x=x0-1..x0+1 ); # (d)
delta := abs(x0-q);
plot( [f(x), L-epsilon, L+epsilon], x=x0-delta..x0+delta, color=black, title="Section 2.3, #61(d)" );
for eps in [0.1, 0.005, 0.001 ] do # (e)
```

```

q := fsolve( abs( f(x)-L ) = eps, x=x0-1..x0+1 );
delta := abs(x0-q);
head := sprintf("Section 2.3, #61(e)\n epsilon = %5f, delta = %5f\n", eps, delta );
print(plot( [f(x),L-eps,L+eps], x=x0-delta..x0+delta,
           color=black, linestyle=[1,3,3], title=head ));
end do:

```

Mathematica (assigned function and values for x_0 , ϵ s and δ may vary):

```

Clear[f, x]
y1 = L - eps; y2 = L + eps; x0 = 1;
f[x_] := (3x^2 - (7x + 1)Sqrt[x] + 5)/(x - 1)
Plot[f[x], {x, x0 - 0.2, x0 + 0.2}]
L = Limit[f[x], x -> x0]
eps = 0.1; del = 0.2;
Plot[{f[x], y1, y2}, {x, x0 - del, x0 + del}, PlotRange -> {L - 2eps, L + 2eps}]

```

2.4 ONE-SIDED LIMITS AND LIMITS AT INFINITY

- | | | | |
|-----------|-----------|-----------|-----------|
| (a) True | (b) True | (c) False | (d) True |
| (e) True | (f) True | (g) False | (h) False |
| (i) False | (j) False | (k) True | (l) False |
- | | | | |
|----------|-----------|-----------|----------|
| (a) True | (b) False | (c) False | (d) True |
| (e) True | (f) True | (g) True | (h) True |
| (i) True | (j) False | (k) True | |
- (a) $\lim_{x \rightarrow 2^+} f(x) = \frac{2}{2} + 1 = 2$, $\lim_{x \rightarrow 2^-} f(x) = 3 - 2 = 1$

(b) No, $\lim_{x \rightarrow 2} f(x)$ does not exist because $\lim_{x \rightarrow 2^+} f(x) \neq \lim_{x \rightarrow 2^-} f(x)$

(c) $\lim_{x \rightarrow 4^-} f(x) = \frac{4}{2} + 1 = 3$, $\lim_{x \rightarrow 4^+} f(x) = \frac{4}{2} + 1 = 3$

(d) Yes, $\lim_{x \rightarrow 4} f(x) = 3$ because $3 = \lim_{x \rightarrow 4^-} f(x) = \lim_{x \rightarrow 4^+} f(x)$
- (a) $\lim_{x \rightarrow 2^+} f(x) = \frac{2}{2} = 1$, $\lim_{x \rightarrow 2^-} f(x) = 3 - 2 = 1$, $f(2) = 2$

(b) Yes, $\lim_{x \rightarrow 2} f(x) = 1$ because $1 = \lim_{x \rightarrow 2^+} f(x) = \lim_{x \rightarrow 2^-} f(x)$

(c) $\lim_{x \rightarrow -1^-} f(x) = 3 - (-1) = 4$, $\lim_{x \rightarrow -1^+} f(x) = 3 - (-1) = 4$

(d) Yes, $\lim_{x \rightarrow -1} f(x) = 4$ because $4 = \lim_{x \rightarrow -1^-} f(x) = \lim_{x \rightarrow -1^+} f(x)$
- (a) No, $\lim_{x \rightarrow 0^+} f(x)$ does not exist since $\sin\left(\frac{1}{x}\right)$ does not approach any single value as x approaches 0

(b) $\lim_{x \rightarrow 0^-} f(x) = \lim_{x \rightarrow 0^-} 0 = 0$

(c) $\lim_{x \rightarrow 0} f(x)$ does not exist because $\lim_{x \rightarrow 0^+} f(x)$ does not exist
- (a) Yes, $\lim_{x \rightarrow 0^+} g(x) = 0$ by the sandwich theorem since $-\sqrt{x} \leq g(x) \leq \sqrt{x}$ when $x > 0$

(b) No, $\lim_{x \rightarrow 0^-} g(x)$ does not exist since \sqrt{x} is not defined for $x < 0$

(c) No, $\lim_{x \rightarrow 0} g(x)$ does not exist since $\lim_{x \rightarrow 0^-} g(x)$ does not exist

7. (a)

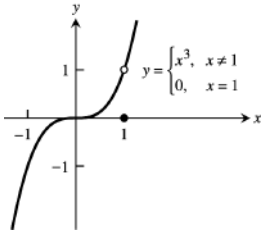

(b) $\lim_{x \rightarrow 1^-} f(x) = 1 = \lim_{x \rightarrow 1^+} f(x)$

(c) Yes, $\lim_{x \rightarrow 1} f(x) = 1$ since the right-hand and left-hand limits exist and equal 1

8. (a)

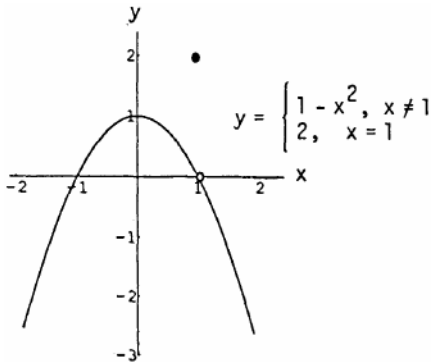

(b) $\lim_{x \rightarrow 1^+} f(x) = 0 = \lim_{x \rightarrow 1^-} f(x)$

(c) Yes, $\lim_{x \rightarrow 1} f(x) = 0$ since the right-hand and left-hand limits exist and equal 0

9. (a) domain: $0 \leq x \leq 2$

range: $0 < y \leq 1$ and $y = 2$

(b) $\lim_{x \rightarrow c} f(x)$ exists for c belonging to

$(0, 1) \cup (1, 2)$

(c) $x = 2$

(d) $x = 0$

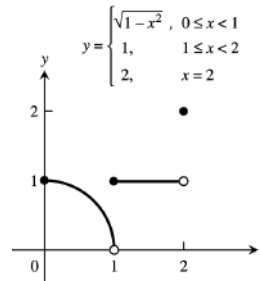

10. (a) domain: $-\infty < x < \infty$

range: $-1 \leq y \leq 1$

(b) $\lim_{x \rightarrow c} f(x)$ exists for c belonging to

$(-\infty, -1) \cup (-1, 1) \cup (1, \infty)$

(c) none

(d) none

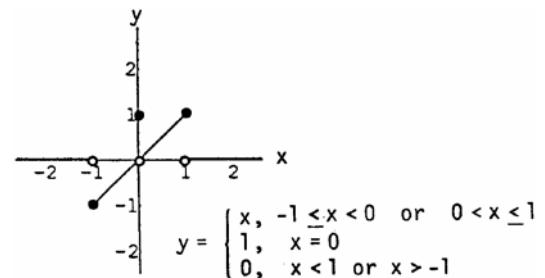

11. $\lim_{x \rightarrow -0.5^-} \sqrt{\frac{x+2}{x-1}} = \sqrt{\frac{-0.5+2}{-0.5-1}} = \sqrt{\frac{3/2}{-3/2}} = \sqrt{3}$

12. $\lim_{x \rightarrow 1^+} \sqrt{\frac{x-1}{x+2}} = \sqrt{\frac{1-1}{1+2}} = \sqrt{0} = 0$

13. $\lim_{x \rightarrow -2^+} \left(\frac{x}{x+1}\right) \left(\frac{2x+5}{x^2+x}\right) = \left(\frac{-2}{-2+1}\right) \left(\frac{2(-2)+5}{(-2)^2+(-2)}\right) = (2) \left(\frac{1}{2}\right) = 1$

14. $\lim_{x \rightarrow 1^-} \left(\frac{1}{x+1}\right) \left(\frac{x+6}{x}\right) \left(\frac{3-x}{7}\right) = \left(\frac{1}{1+1}\right) \left(\frac{1+6}{1}\right) \left(\frac{3-1}{7}\right) = \left(\frac{1}{2}\right) \left(\frac{7}{1}\right) \left(\frac{2}{7}\right) = 1$

15. $\lim_{h \rightarrow 0^+} \frac{\sqrt{h^2+4h+5}-\sqrt{5}}{h} = \lim_{h \rightarrow 0^+} \left(\frac{\sqrt{h^2+4h+5}-\sqrt{5}}{h}\right) \left(\frac{\sqrt{h^2+4h+5}+\sqrt{5}}{\sqrt{h^2+4h+5}+\sqrt{5}}\right)$
 $= \lim_{h \rightarrow 0^+} \frac{(h^2+4h+5)-5}{h(\sqrt{h^2+4h+5}+\sqrt{5})} = \lim_{h \rightarrow 0^+} \frac{h(h+4)}{h(\sqrt{h^2+4h+5}+\sqrt{5})} = \frac{0+4}{\sqrt{5}+\sqrt{5}} = \frac{2}{\sqrt{5}}$

$$16. \lim_{h \rightarrow 0^-} \frac{\sqrt{6} - \sqrt{5h^2 + 11h + 6}}{h} = \lim_{h \rightarrow 0^-} \left(\frac{\sqrt{6} - \sqrt{5h^2 + 11h + 6}}{h} \right) \left(\frac{\sqrt{6} + \sqrt{5h^2 + 11h + 6}}{\sqrt{6} + \sqrt{5h^2 + 11h + 6}} \right)$$

$$= \lim_{h \rightarrow 0^-} \frac{6 - (5h^2 + 11h + 6)}{h(\sqrt{6} + \sqrt{5h^2 + 11h + 6})} = \lim_{h \rightarrow 0^-} \frac{-h(5h + 11)}{h(\sqrt{6} + \sqrt{5h^2 + 11h + 6})} = \frac{-(0 + 11)}{\sqrt{6} + \sqrt{6}} = -\frac{11}{2\sqrt{6}}$$

$$17. (a) \lim_{x \rightarrow -2^+} (x + 3) \frac{|x+2|}{x+2} = \lim_{x \rightarrow -2^+} (x + 3) \frac{(x+2)}{(x+2)} \quad (|x + 2| = x + 2 \text{ for } x > -2)$$

$$= \lim_{x \rightarrow -2^+} (x + 3) = (-2) + 3 = 1$$

$$(b) \lim_{x \rightarrow -2^-} (x + 3) \frac{|x+2|}{x+2} = \lim_{x \rightarrow -2^-} (x + 3) \left[\frac{-(x+2)}{(x+2)} \right] \quad (|x + 2| = -(x + 2) \text{ for } x < -2)$$

$$= \lim_{x \rightarrow -2^-} (x + 3)(-1) = -(-2 + 3) = -1$$

$$18. (a) \lim_{x \rightarrow 1^+} \frac{\sqrt{2x(x-1)}}{|x-1|} = \lim_{x \rightarrow 1^+} \frac{\sqrt{2x(x-1)}}{(x-1)} \quad (|x - 1| = x - 1 \text{ for } x > 1)$$

$$= \lim_{x \rightarrow 1^+} \sqrt{2x} = \sqrt{2}$$

$$(b) \lim_{x \rightarrow 1^-} \frac{\sqrt{2x(x-1)}}{|x-1|} = \lim_{x \rightarrow 1^-} \frac{\sqrt{2x(x-1)}}{-(x-1)} \quad (|x - 1| = -(x - 1) \text{ for } x < 1)$$

$$= \lim_{x \rightarrow 1^-} -\sqrt{2x} = -\sqrt{2}$$

$$19. (a) \lim_{\theta \rightarrow 3^+} \frac{|\theta|}{\theta} = \frac{3}{3} = 1 \quad (b) \lim_{\theta \rightarrow 3^-} \frac{|\theta|}{\theta} = \frac{2}{3}$$

$$20. (a) \lim_{t \rightarrow 4^+} (t - [t]) = 4 - 4 = 0 \quad (b) \lim_{t \rightarrow 4^-} (t - [t]) = 4 - 3 = 1$$

$$21. \lim_{\theta \rightarrow 0} \frac{\sin \sqrt{2\theta}}{\sqrt{2\theta}} = \lim_{x \rightarrow 0} \frac{\sin x}{x} = 1 \quad (\text{where } x = \sqrt{2\theta})$$

$$22. \lim_{t \rightarrow 0} \frac{\sin kt}{t} = \lim_{t \rightarrow 0} \frac{k \sin kt}{kt} = \lim_{\theta \rightarrow 0} \frac{k \sin \theta}{\theta} = k \lim_{\theta \rightarrow 0} \frac{\sin \theta}{\theta} = k \cdot 1 = k \quad (\text{where } \theta = kt)$$

$$23. \lim_{y \rightarrow 0} \frac{\sin 3y}{4y} = \frac{1}{4} \lim_{y \rightarrow 0} \frac{3 \sin 3y}{3y} = \frac{3}{4} \lim_{y \rightarrow 0} \frac{\sin 3y}{3y} = \frac{3}{4} \lim_{\theta \rightarrow 0} \frac{\sin \theta}{\theta} = \frac{3}{4} \quad (\text{where } \theta = 3y)$$

$$24. \lim_{h \rightarrow 0^-} \frac{h}{\sin 3h} = \lim_{h \rightarrow 0^-} \left(\frac{1}{3} \cdot \frac{3h}{\sin 3h} \right) = \frac{1}{3} \lim_{h \rightarrow 0^-} \frac{1}{\left(\frac{\sin 3h}{3h} \right)} = \frac{1}{3} \left(\frac{1}{\lim_{\theta \rightarrow 0^-} \frac{\sin \theta}{\theta}} \right) = \frac{1}{3} \cdot 1 = \frac{1}{3} \quad (\text{where } \theta = 3h)$$

$$25. \lim_{x \rightarrow 0} \frac{\tan 2x}{x} = \lim_{x \rightarrow 0} \frac{\left(\frac{\sin 2x}{\cos 2x} \right)}{x} = \lim_{x \rightarrow 0} \frac{\sin 2x}{x \cos 2x} = \left(\lim_{x \rightarrow 0} \frac{1}{\cos 2x} \right) \left(\lim_{x \rightarrow 0} \frac{2 \sin 2x}{2x} \right) = 1 \cdot 2 = 2$$

$$26. \lim_{t \rightarrow 0} \frac{2t}{\tan t} = 2 \lim_{t \rightarrow 0} \frac{t}{\left(\frac{\sin t}{\cos t} \right)} = 2 \lim_{t \rightarrow 0} \frac{t \cos t}{\sin t} = 2 \left(\lim_{t \rightarrow 0} \cos t \right) \left(\frac{1}{\lim_{t \rightarrow 0} \frac{\sin t}{t}} \right) = 2 \cdot 1 \cdot 1 = 2$$

$$27. \lim_{x \rightarrow 0} \frac{x \csc 2x}{\cos 5x} = \lim_{x \rightarrow 0} \left(\frac{x}{\sin 2x} \cdot \frac{1}{\cos 5x} \right) = \left(\frac{1}{2} \lim_{x \rightarrow 0} \frac{2x}{\sin 2x} \right) \left(\lim_{x \rightarrow 0} \frac{1}{\cos 5x} \right) = \left(\frac{1}{2} \cdot 1 \right) (1) = \frac{1}{2}$$

$$28. \lim_{x \rightarrow 0} 6x^2(\cot x)(\csc 2x) = \lim_{x \rightarrow 0} \frac{6x^2 \cos x}{\sin x \sin 2x} = \lim_{x \rightarrow 0} \left(3 \cos x \cdot \frac{x}{\sin x} \cdot \frac{2x}{\sin 2x} \right) = 3 \cdot 1 \cdot 1 = 3$$

$$29. \lim_{x \rightarrow 0} \frac{x + x \cos x}{\sin x \cos x} = \lim_{x \rightarrow 0} \left(\frac{x}{\sin x \cos x} + \frac{x \cos x}{\sin x \cos x} \right) = \lim_{x \rightarrow 0} \left(\frac{x}{\sin x} \cdot \frac{1}{\cos x} \right) + \lim_{x \rightarrow 0} \frac{x}{\sin x}$$

$$= \lim_{x \rightarrow 0} \left(\frac{1}{\frac{\sin x}{x}} \right) \cdot \lim_{x \rightarrow 0} \left(\frac{1}{\cos x} \right) + \lim_{x \rightarrow 0} \left(\frac{1}{\frac{\sin x}{x}} \right) = (1)(1) + 1 = 2$$

$$30. \lim_{x \rightarrow 0} \frac{x^2 - x + \sin x}{2x} = \lim_{x \rightarrow 0} \left(\frac{x}{2} - \frac{1}{2} + \frac{1}{2} \left(\frac{\sin x}{x} \right) \right) = 0 - \frac{1}{2} + \frac{1}{2} (1) = 0$$

$$31. \lim_{t \rightarrow 0} \frac{\sin(1 - \cos t)}{1 - \cos t} = \lim_{\theta \rightarrow 0} \frac{\sin \theta}{\theta} = 1 \text{ since } \theta = 1 - \cos t \rightarrow 0 \text{ as } t \rightarrow 0$$

$$32. \lim_{h \rightarrow 0} \frac{\sin(\sin h)}{\sin h} = \lim_{\theta \rightarrow 0} \frac{\sin \theta}{\theta} = 1 \text{ since } \theta = \sin h \rightarrow 0 \text{ as } h \rightarrow 0$$

$$33. \lim_{\theta \rightarrow 0} \frac{\sin \theta}{\sin 2\theta} = \lim_{\theta \rightarrow 0} \left(\frac{\sin \theta}{\sin 2\theta} \cdot \frac{2\theta}{2\theta} \right) = \frac{1}{2} \lim_{\theta \rightarrow 0} \left(\frac{\sin \theta}{\theta} \cdot \frac{2\theta}{\sin 2\theta} \right) = \frac{1}{2} \cdot 1 \cdot 1 = \frac{1}{2}$$

$$34. \lim_{x \rightarrow 0} \frac{\sin 5x}{\sin 4x} = \lim_{x \rightarrow 0} \left(\frac{\sin 5x}{\sin 4x} \cdot \frac{4x}{5x} \cdot \frac{5}{4} \right) = \frac{5}{4} \lim_{x \rightarrow 0} \left(\frac{\sin 5x}{5x} \cdot \frac{4x}{\sin 4x} \right) = \frac{5}{4} \cdot 1 \cdot 1 = \frac{5}{4}$$

$$35. \lim_{x \rightarrow 0} \frac{\tan 3x}{\sin 8x} = \lim_{x \rightarrow 0} \left(\frac{\sin 3x}{\cos 3x} \cdot \frac{1}{\sin 8x} \right) = \lim_{x \rightarrow 0} \left(\frac{\sin 3x}{\cos 3x} \cdot \frac{1}{\sin 8x} \cdot \frac{8x}{3x} \cdot \frac{3}{8} \right) \\ = \frac{3}{8} \lim_{x \rightarrow 0} \left(\frac{1}{\cos 3x} \right) \left(\frac{\sin 3x}{3x} \right) \left(\frac{8x}{\sin 8x} \right) = \frac{3}{8} \cdot 1 \cdot 1 \cdot 1 = \frac{3}{8}$$

$$36. \lim_{y \rightarrow 0} \frac{\sin 3y \cot 5y}{y \cot 4y} = \lim_{y \rightarrow 0} \frac{\sin 3y \sin 4y \cos 5y}{y \cos 4y \sin 5y} = \lim_{y \rightarrow 0} \left(\frac{\sin 3y}{y} \right) \left(\frac{\sin 4y}{\cos 4y} \right) \left(\frac{\cos 5y}{\sin 5y} \right) \left(\frac{3 \cdot 4 \cdot 5y}{3 \cdot 4 \cdot 5y} \right) \\ = \lim_{y \rightarrow 0} \left(\frac{\sin 3y}{3y} \right) \left(\frac{\sin 4y}{4y} \right) \left(\frac{5y}{\sin 5y} \right) \left(\frac{\cos 5y}{\cos 4y} \right) \left(\frac{3 \cdot 4}{5} \right) = 1 \cdot 1 \cdot 1 \cdot 1 \cdot \frac{12}{5} = \frac{12}{5}$$

Note: In these exercises we use the result $\lim_{x \rightarrow \pm\infty} \frac{1}{x^{m/n}} = 0$ whenever $\frac{m}{n} > 0$. This result follows immediately from

Example 6 and the power rule in Theorem 8: $\lim_{x \rightarrow \pm\infty} \left(\frac{1}{x^{m/n}} \right) = \lim_{x \rightarrow \pm\infty} \left(\frac{1}{x} \right)^{m/n} = \left(\lim_{x \rightarrow \pm\infty} \frac{1}{x} \right)^{m/n} = 0^{m/n} = 0$.

$$37. \text{(a) } -3 \qquad \text{(b) } -3$$

$$38. \text{(a) } \pi \qquad \text{(b) } \pi$$

$$39. \text{(a) } \frac{1}{2} \qquad \text{(b) } \frac{1}{2}$$

$$40. \text{(a) } \frac{1}{8} \qquad \text{(b) } \frac{1}{8}$$

$$41. \text{(a) } -\frac{5}{3} \qquad \text{(b) } -\frac{5}{3}$$

$$42. \text{(a) } \frac{3}{4} \qquad \text{(b) } \frac{3}{4}$$

$$43. -\frac{1}{x} \leq \frac{\sin 2x}{x} \leq \frac{1}{x} \Rightarrow \lim_{x \rightarrow \infty} \frac{\sin 2x}{x} = 0 \text{ by the Sandwich Theorem}$$

$$44. -\frac{1}{3\theta} \leq \frac{\cos \theta}{3\theta} \leq \frac{1}{3\theta} \Rightarrow \lim_{\theta \rightarrow -\infty} \frac{\cos \theta}{3\theta} = 0 \text{ by the Sandwich Theorem}$$

$$45. \lim_{t \rightarrow \infty} \frac{2-t+\sin t}{t+\cos t} = \lim_{t \rightarrow \infty} \frac{\frac{2}{t}-1+\left(\frac{\sin t}{t}\right)}{1+\left(\frac{\cos t}{t}\right)} = \frac{0-1+0}{1+0} = -1$$

$$46. \lim_{r \rightarrow \infty} \frac{r+\sin r}{2r+7-5 \sin r} = \lim_{r \rightarrow \infty} \frac{1+\left(\frac{\sin r}{r}\right)}{2+\frac{7}{r}-5\left(\frac{\sin r}{r}\right)} = \lim_{r \rightarrow \infty} \frac{1+0}{2+0-0} = \frac{1}{2}$$

$$47. \text{(a) } \lim_{x \rightarrow \infty} \frac{2x+3}{5x+7} = \lim_{x \rightarrow \infty} \frac{2+\frac{3}{x}}{5+\frac{7}{x}} = \frac{2}{5} \qquad \text{(b) } \frac{2}{5} \text{ (same process as part (a))}$$

$$48. \text{(a) } \lim_{x \rightarrow \infty} \frac{2x^3+7}{x^3-x^2+x+7} = \lim_{x \rightarrow \infty} \frac{2+\left(\frac{7}{x^3}\right)}{1-\frac{1}{x}+\frac{1}{x^2}+\frac{7}{x^3}} = 2$$

(b) 2 (same process as part (a))

90 Chapter 2 Limits and Continuity

49. (a) $\lim_{x \rightarrow \infty} \frac{x+1}{x^2+3} = \lim_{x \rightarrow \infty} \frac{\frac{1}{x} + \frac{1}{x^2}}{1 + \frac{3}{x^2}} = 0$

(b) 0 (same process as part (a))

50. (a) $\lim_{x \rightarrow \infty} \frac{3x+7}{x^2-2} = \lim_{x \rightarrow \infty} \frac{\frac{3}{x} + \frac{7}{x^2}}{1 - \frac{2}{x^2}} = 0$

(b) 0 (same process as part (a))

51. (a) $\lim_{x \rightarrow \infty} \frac{7x^3}{x^3-3x^2+6x} = \lim_{x \rightarrow \infty} \frac{7}{1 - \frac{3}{x} + \frac{6}{x^2}} = 7$

(b) 7 (same process as part (a))

52. (a) $\lim_{x \rightarrow \infty} \frac{1}{x^3-4x+1} = \lim_{x \rightarrow \infty} \frac{\frac{1}{x^3}}{1 - \frac{4}{x^2} + \frac{1}{x^3}} = 0$

(b) 0 (same process as part (a))

53. (a) $\lim_{x \rightarrow \infty} \frac{10x^5+x^4+31}{x^6} = \lim_{x \rightarrow \infty} \frac{\frac{10}{x} + \frac{1}{x^2} + \frac{31}{x^6}}{1} = 0$

(b) 0 (same process as part (a))

54. (a) $\lim_{x \rightarrow \infty} \frac{9x^4+x}{2x^4+5x^2-x+6} = \lim_{x \rightarrow \infty} \frac{9 + \frac{1}{x^3}}{2 + \frac{5}{x^2} - \frac{1}{x^3} + \frac{6}{x^4}} = \frac{9}{2}$

(b) $\frac{9}{2}$ (same process as part (a))

55. (a) $\lim_{x \rightarrow \infty} \frac{-2x^3-2x+3}{3x^3+3x^2-5x} = \lim_{x \rightarrow \infty} \frac{-2 - \frac{2}{x^2} + \frac{3}{x^3}}{3 + \frac{3}{x} - \frac{5}{x^2}} = -\frac{2}{3}$

(b) $-\frac{2}{3}$ (same process as part (a))

56. (a) $\lim_{x \rightarrow \infty} \frac{-x^4}{x^4-7x^3+7x^2+9} = \lim_{x \rightarrow \infty} \frac{-1}{1 - \frac{7}{x} + \frac{7}{x^2} + \frac{9}{x^4}} = -1$

(b) -1 (same process as part (a))

57. $\lim_{x \rightarrow \infty} \frac{2\sqrt{x}+x^{-1}}{3x-7} = \lim_{x \rightarrow \infty} \frac{\left(\frac{2}{x^{1/2}}\right) + \left(\frac{1}{x^2}\right)}{3 - \frac{7}{x}} = 0$

58. $\lim_{x \rightarrow \infty} \frac{2+\sqrt{x}}{2-\sqrt{x}} = \lim_{x \rightarrow \infty} \frac{\left(\frac{2}{x^{1/2}}\right) + 1}{\left(\frac{2}{x^{1/2}}\right) - 1} = -1$

59. $\lim_{x \rightarrow -\infty} \frac{\sqrt[3]{x}-\sqrt[5]{x}}{\sqrt{x}+\sqrt{x}} = \lim_{x \rightarrow -\infty} \frac{1-x^{(1/5)-(1/3)}}{1+x^{(1/5)-(1/3)}} = \lim_{x \rightarrow -\infty} \frac{1-\left(\frac{1}{x^{2/15}}\right)}{1+\left(\frac{1}{x^{2/15}}\right)} = 1$

60. $\lim_{x \rightarrow \infty} \frac{x^{-1}+x^{-4}}{x^{-2}-x^{-3}} = \lim_{x \rightarrow \infty} \frac{x + \frac{1}{x^5}}{1 - \frac{1}{x}} = \infty$

61. $\lim_{x \rightarrow \infty} \frac{2x^{5/3}-x^{1/3}+7}{x^{8/5}+3x+\sqrt{x}} = \lim_{x \rightarrow \infty} \frac{2x^{1/15}-\frac{1}{x^{19/15}}+\frac{7}{x^{8/5}}}{1+\frac{3}{x^{3/5}}+\frac{1}{x^{11/10}}} = \infty$

62. $\lim_{x \rightarrow \infty} \frac{\sqrt[3]{x}-5x+3}{2x+x^{2/3}-4} = \lim_{x \rightarrow \infty} \frac{\frac{1}{x^{2/3}}-5+\frac{3}{x}}{2+\frac{1}{x^{1/3}}-\frac{4}{x}} = -\frac{5}{2}$

63. Yes. If $\lim_{x \rightarrow a^+} f(x) = L = \lim_{x \rightarrow a^-} f(x)$, then $\lim_{x \rightarrow a} f(x) = L$. If $\lim_{x \rightarrow a^+} f(x) \neq \lim_{x \rightarrow a^-} f(x)$, then $\lim_{x \rightarrow a} f(x)$ does not exist.

64. Since $\lim_{x \rightarrow c} f(x) = L$ if and only if $\lim_{x \rightarrow c^+} f(x) = L$ and $\lim_{x \rightarrow c^-} f(x) = L$, then $\lim_{x \rightarrow c} f(x)$ can be found by calculating $\lim_{x \rightarrow c^+} f(x)$.

65. If f is an odd function of x , then $f(-x) = -f(x)$. Given $\lim_{x \rightarrow 0^+} f(x) = 3$, then $\lim_{x \rightarrow 0^-} f(x) = -3$.

66. If f is an even function of x , then $f(-x) = f(x)$. Given $\lim_{x \rightarrow 2^-} f(x) = 7$ then $\lim_{x \rightarrow -2^+} f(x) = 7$. However, nothing can be said about $\lim_{x \rightarrow -2^-} f(x)$ because we don't know $\lim_{x \rightarrow 2^+} f(x)$.

67. Yes. If $\lim_{x \rightarrow \infty} \frac{f(x)}{g(x)} = 2$ then the ratio of the polynomials' leading coefficients is 2, so $\lim_{x \rightarrow -\infty} \frac{f(x)}{g(x)} = 2$ as well.

68. Yes, it can have a horizontal or oblique asymptote.

69. At most 1 horizontal asymptote: If $\lim_{x \rightarrow \infty} \frac{f(x)}{g(x)} = L$, then the ratio of the polynomials' leading coefficients is L , so $\lim_{x \rightarrow -\infty} \frac{f(x)}{g(x)} = L$ as well.

$$\begin{aligned} 70. \quad \lim_{x \rightarrow \infty} \sqrt{x^2 + x} - \sqrt{x^2 - x} &= \lim_{x \rightarrow \infty} \left[\sqrt{x^2 + x} - \sqrt{x^2 - x} \right] \cdot \left[\frac{\sqrt{x^2 + x} + \sqrt{x^2 - x}}{\sqrt{x^2 + x} + \sqrt{x^2 - x}} \right] = \lim_{x \rightarrow \infty} \frac{(x^2 + x) - (x^2 - x)}{\sqrt{x^2 + x} + \sqrt{x^2 - x}} \\ &= \lim_{x \rightarrow \infty} \frac{2x}{\sqrt{x^2 + x} + \sqrt{x^2 - x}} = \lim_{x \rightarrow \infty} \frac{2}{\sqrt{1 + \frac{1}{x}} + \sqrt{1 - \frac{1}{x}}} = \frac{2}{1+1} = 1 \end{aligned}$$

71. For any $\epsilon > 0$, take $N = 1$. Then for all $x > N$ we have that $|f(x) - k| = |k - k| = 0 < \epsilon$.

72. For any $\epsilon > 0$, take $N = 1$. Then for all $y < -N$ we have that $|f(x) - k| = |k - k| = 0 < \epsilon$.

73. $I = (5, 5 + \delta) \Rightarrow 5 < x < 5 + \delta$. Also, $\sqrt{x - 5} < \epsilon \Rightarrow x - 5 < \epsilon^2 \Rightarrow x < 5 + \epsilon^2$. Choose $\delta = \epsilon^2$
 $\Rightarrow \lim_{x \rightarrow 5^+} \sqrt{x - 5} = 0$.

74. $I = (4 - \delta, 4) \Rightarrow 4 - \delta < x < 4$. Also, $\sqrt{4 - x} < \epsilon \Rightarrow 4 - x < \epsilon^2 \Rightarrow x > 4 - \epsilon^2$. Choose $\delta = \epsilon^2$
 $\Rightarrow \lim_{x \rightarrow 4^-} \sqrt{4 - x} = 0$.

75. As $x \rightarrow 0^-$ the number x is always negative. Thus, $\left| \frac{x}{|x|} - (-1) \right| < \epsilon \Rightarrow \left| \frac{x}{-x} + 1 \right| < \epsilon \Rightarrow 0 < \epsilon$ which is always true independent of the value of x . Hence we can choose any $\delta > 0$ with $-\delta < x < 0 \Rightarrow \lim_{x \rightarrow 0^-} \frac{x}{|x|} = -1$.

76. Since $x \rightarrow 2^+$ we have $x > 2$ and $|x - 2| = x - 2$. Then, $\left| \frac{x-2}{|x-2|} - 1 \right| = \left| \frac{x-2}{x-2} - 1 \right| < \epsilon \Rightarrow 0 < \epsilon$
 which is always true so long as $x > 2$. Hence we can choose any $\delta > 0$, and thus $2 < x < 2 + \delta$
 $\Rightarrow \left| \frac{x-2}{|x-2|} - 1 \right| < \epsilon$. Thus, $\lim_{x \rightarrow 2^+} \frac{x-2}{|x-2|} = 1$.

77. (a) $\lim_{x \rightarrow 400^+} [x] = 400$. Just observe that if $400 < x < 401$, then $[x] = 400$. Thus if we choose $\delta = 1$, we have for any number $\epsilon > 0$ that $400 < x < 400 + \delta \Rightarrow |[x] - 400| = |400 - 400| = 0 < \epsilon$.

(b) $\lim_{x \rightarrow 400^-} [x] = 399$. Just observe that if $399 < x < 400$ then $[x] = 399$. Thus if we choose $\delta = 1$, we have for any number $\epsilon > 0$ that $400 - \delta < x < 400 \Rightarrow |[x] - 399| = |399 - 399| = 0 < \epsilon$.

(c) Since $\lim_{x \rightarrow 400^+} [x] \neq \lim_{x \rightarrow 400^-} [x]$ we conclude that $\lim_{x \rightarrow 400} [x]$ does not exist.

78. (a) $\lim_{x \rightarrow 0^+} f(x) = \lim_{x \rightarrow 0^+} \sqrt{x} = \sqrt{0} = 0$; $|\sqrt{x} - 0| < \epsilon \Rightarrow -\epsilon < \sqrt{x} < \epsilon \Rightarrow 0 < x < \epsilon^2$ for x positive. Choose $\delta = \epsilon^2$
 $\Rightarrow \lim_{x \rightarrow 0^+} f(x) = 0$.

(b) $\lim_{x \rightarrow 0^-} f(x) = \lim_{x \rightarrow 0^-} x^2 \sin\left(\frac{1}{x}\right) = 0$ by the sandwich theorem since $-x^2 \leq x^2 \sin\left(\frac{1}{x}\right) \leq x^2$ for all $x \neq 0$.
 Since $|x^2 - 0| = |-x^2 - 0| = x^2 < \epsilon$ whenever $|x| < \sqrt{\epsilon}$, we choose $\delta = \sqrt{\epsilon}$ and obtain $|x^2 \sin\left(\frac{1}{x}\right) - 0| < \epsilon$
 if $-\delta < x < 0$.

(c) The function f has limit 0 at $x_0 = 0$ since both the right-hand and left-hand limits exist and equal 0.

79. $\lim_{x \rightarrow \pm\infty} x \sin \frac{1}{x} = \lim_{\theta \rightarrow 0} \frac{1}{\theta} \sin \theta = 1, (\theta = \frac{1}{x})$ 80. $\lim_{x \rightarrow -\infty} \frac{\cos \frac{1}{x}}{1 + \frac{1}{x}} = \lim_{\theta \rightarrow 0^-} \frac{\cos \theta}{1 + \theta} = \frac{1}{1} = 1, (\theta = \frac{1}{x})$

81. $\lim_{x \rightarrow \pm\infty} \frac{3x+4}{2x-5} = \lim_{x \rightarrow \pm\infty} \frac{3+\frac{4}{x}}{2-\frac{5}{x}} = \lim_{t \rightarrow 0} \frac{3+4t}{2-5t} = \frac{3}{2}, (t = \frac{1}{x})$

82. $\lim_{x \rightarrow \infty} (\frac{1}{x})^{1/x} = \lim_{z \rightarrow 0^+} z^z = 1, (z = \frac{1}{x})$

83. $\lim_{x \rightarrow \pm\infty} (3 + \frac{2}{x}) (\cos \frac{1}{x}) = \lim_{\theta \rightarrow 0} (3 + 2\theta)(\cos \theta) = (3)(1) = 3, (\theta = \frac{1}{x})$

84. $\lim_{x \rightarrow \infty} (\frac{3}{x^2} - \cos \frac{1}{x}) (1 + \sin \frac{1}{x}) = \lim_{\theta \rightarrow 0^+} (3\theta^2 - \cos \theta)(1 + \sin \theta) = (0 - 1)(1 + 0) = -1, (\theta = \frac{1}{x})$

2.5 INFINITE LIMITS AND VERTICAL ASYMPTOTES

- | | |
|---|---|
| 1. $\lim_{x \rightarrow 0^+} \frac{1}{3x} = \infty$ $\left(\frac{\text{positive}}{\text{positive}}\right)$ | 2. $\lim_{x \rightarrow 0^-} \frac{5}{2x} = -\infty$ $\left(\frac{\text{positive}}{\text{negative}}\right)$ |
| 3. $\lim_{x \rightarrow 2^-} \frac{3}{x-2} = -\infty$ $\left(\frac{\text{positive}}{\text{negative}}\right)$ | 4. $\lim_{x \rightarrow 3^+} \frac{1}{x-3} = \infty$ $\left(\frac{\text{positive}}{\text{positive}}\right)$ |
| 5. $\lim_{x \rightarrow -8^+} \frac{2x}{x+8} = -\infty$ $\left(\frac{\text{negative}}{\text{positive}}\right)$ | 6. $\lim_{x \rightarrow -5^-} \frac{3x}{2x+10} = \infty$ $\left(\frac{\text{negative}}{\text{negative}}\right)$ |
| 7. $\lim_{x \rightarrow 7} \frac{4}{(x-7)^2} = \infty$ $\left(\frac{\text{positive}}{\text{positive}}\right)$ | 8. $\lim_{x \rightarrow 0} \frac{-1}{x^2(x+1)} = -\infty$ $\left(\frac{\text{negative}}{\text{positive-positive}}\right)$ |
| 9. (a) $\lim_{x \rightarrow 0^+} \frac{2}{3x^{1/3}} = \infty$ | (b) $\lim_{x \rightarrow 0^-} \frac{2}{3x^{1/3}} = -\infty$ |
| 10. (a) $\lim_{x \rightarrow 0^+} \frac{2}{x^{1/5}} = \infty$ | (b) $\lim_{x \rightarrow 0^-} \frac{2}{x^{1/5}} = -\infty$ |
| 11. $\lim_{x \rightarrow 0} \frac{4}{x^{2/5}} = \lim_{x \rightarrow 0} \frac{4}{(x^{1/5})^2} = \infty$ | 12. $\lim_{x \rightarrow 0} \frac{1}{x^{2/3}} = \lim_{x \rightarrow 0} \frac{1}{(x^{1/3})^2} = \infty$ |
| 13. $\lim_{x \rightarrow (\frac{\pi}{2})^-} \tan x = \infty$ | 14. $\lim_{x \rightarrow (\frac{-\pi}{2})^+} \sec x = \infty$ |
| 15. $\lim_{\theta \rightarrow 0^-} (1 + \csc \theta) = -\infty$ | |
| 16. $\lim_{\theta \rightarrow 0^+} (2 - \cot \theta) = -\infty$ and $\lim_{\theta \rightarrow 0^-} (2 - \cot \theta) = \infty$, so the limit does not exist | |
| 17. (a) $\lim_{x \rightarrow 2^+} \frac{1}{x^2-4} = \lim_{x \rightarrow 2^+} \frac{1}{(x+2)(x-2)} = \infty$ $\left(\frac{1}{\text{positive-positive}}\right)$ | |
| (b) $\lim_{x \rightarrow 2^-} \frac{1}{x^2-4} = \lim_{x \rightarrow 2^-} \frac{1}{(x+2)(x-2)} = -\infty$ $\left(\frac{1}{\text{positive-negative}}\right)$ | |
| (c) $\lim_{x \rightarrow -2^+} \frac{1}{x^2-4} = \lim_{x \rightarrow -2^+} \frac{1}{(x+2)(x-2)} = -\infty$ $\left(\frac{1}{\text{positive-negative}}\right)$ | |
| (d) $\lim_{x \rightarrow -2^-} \frac{1}{x^2-4} = \lim_{x \rightarrow -2^-} \frac{1}{(x+2)(x-2)} = \infty$ $\left(\frac{1}{\text{negative-negative}}\right)$ | |

18. (a) $\lim_{x \rightarrow 1^+} \frac{x}{x^2-1} = \lim_{x \rightarrow 1^+} \frac{x}{(x+1)(x-1)} = \infty$ $\left(\frac{\text{positive}}{\text{positive-positive}} \right)$
 (b) $\lim_{x \rightarrow 1^-} \frac{x}{x^2-1} = \lim_{x \rightarrow 1^-} \frac{x}{(x+1)(x-1)} = -\infty$ $\left(\frac{\text{positive}}{\text{positive-negative}} \right)$
 (c) $\lim_{x \rightarrow -1^+} \frac{x}{x^2-1} = \lim_{x \rightarrow -1^+} \frac{x}{(x+1)(x-1)} = \infty$ $\left(\frac{\text{negative}}{\text{positive-negative}} \right)$
 (d) $\lim_{x \rightarrow -1^-} \frac{x}{x^2-1} = \lim_{x \rightarrow -1^-} \frac{x}{(x+1)(x-1)} = -\infty$ $\left(\frac{\text{negative}}{\text{negative-negative}} \right)$
19. (a) $\lim_{x \rightarrow 0^+} \frac{x^2}{2} - \frac{1}{x} = 0 + \lim_{x \rightarrow 0^+} \frac{1}{-x} = -\infty$ $\left(\frac{1}{\text{negative}} \right)$
 (b) $\lim_{x \rightarrow 0^-} \frac{x^2}{2} - \frac{1}{x} = 0 + \lim_{x \rightarrow 0^-} \frac{1}{-x} = \infty$ $\left(\frac{1}{\text{positive}} \right)$
 (c) $\lim_{x \rightarrow \sqrt[3]{2}} \frac{x^2}{2} - \frac{1}{x} = \frac{2^{2/3}}{2} - \frac{1}{2^{1/3}} = 2^{-1/3} - 2^{-1/3} = 0$
 (d) $\lim_{x \rightarrow -1} \frac{x^2}{2} - \frac{1}{x} = \frac{1}{2} - \left(\frac{1}{-1} \right) = \frac{3}{2}$
20. (a) $\lim_{x \rightarrow -2^+} \frac{x^2-1}{2x+4} = \infty$ $\left(\frac{\text{positive}}{\text{positive}} \right)$ (b) $\lim_{x \rightarrow -2^-} \frac{x^2-1}{2x+4} = -\infty$ $\left(\frac{\text{positive}}{\text{negative}} \right)$
 (c) $\lim_{x \rightarrow 1^+} \frac{x^2-1}{2x+4} = \lim_{x \rightarrow 1^+} \frac{(x+1)(x-1)}{2x+4} = \frac{2 \cdot 0}{2+4} = 0$
 (d) $\lim_{x \rightarrow 0^-} \frac{x^2-1}{2x+4} = \frac{-1}{4}$
21. (a) $\lim_{x \rightarrow 0^+} \frac{x^2-3x+2}{x^3-2x^2} = \lim_{x \rightarrow 0^+} \frac{(x-2)(x-1)}{x^2(x-2)} = -\infty$ $\left(\frac{\text{negative-negative}}{\text{positive-negative}} \right)$
 (b) $\lim_{x \rightarrow 2^+} \frac{x^2-3x+2}{x^3-2x^2} = \lim_{x \rightarrow 2^+} \frac{(x-2)(x-1)}{x^2(x-2)} = \lim_{x \rightarrow 2^+} \frac{x-1}{x^2} = \frac{1}{4}, x \neq 2$
 (c) $\lim_{x \rightarrow 2^-} \frac{x^2-3x+2}{x^3-2x^2} = \lim_{x \rightarrow 2^-} \frac{(x-2)(x-1)}{x^2(x-2)} = \lim_{x \rightarrow 2^-} \frac{x-1}{x^2} = \frac{1}{4}, x \neq 2$
 (d) $\lim_{x \rightarrow 2} \frac{x^2-3x+2}{x^3-2x^2} = \lim_{x \rightarrow 2} \frac{(x-2)(x-1)}{x^2(x-2)} = \lim_{x \rightarrow 2} \frac{x-1}{x^2} = \frac{1}{4}, x \neq 2$
 (e) $\lim_{x \rightarrow 0} \frac{x^2-3x+2}{x^3-2x^2} = \lim_{x \rightarrow 0} \frac{(x-2)(x-1)}{x^2(x-2)} = -\infty$ $\left(\frac{\text{negative-negative}}{\text{positive-negative}} \right)$
22. (a) $\lim_{x \rightarrow 2^+} \frac{x^2-3x+2}{x^3-4x} = \lim_{x \rightarrow 2^+} \frac{(x-2)(x-1)}{x(x-2)(x+2)} = \lim_{x \rightarrow 2^+} \frac{(x-1)}{x(x+2)} = \frac{1}{2(4)} = \frac{1}{8}$
 (b) $\lim_{x \rightarrow -2^+} \frac{x^2-3x+2}{x^3-4x} = \lim_{x \rightarrow -2^+} \frac{(x-2)(x-1)}{x(x-2)(x+2)} = \lim_{x \rightarrow -2^+} \frac{(x-1)}{x(x+2)} = \infty$ $\left(\frac{\text{negative}}{\text{negative-positive}} \right)$
 (c) $\lim_{x \rightarrow 0^-} \frac{x^2-3x+2}{x^3-4x} = \lim_{x \rightarrow 0^-} \frac{(x-2)(x-1)}{x(x-2)(x+2)} = \lim_{x \rightarrow 0^-} \frac{(x-1)}{x(x+2)} = \infty$ $\left(\frac{\text{negative}}{\text{negative-positive}} \right)$
 (d) $\lim_{x \rightarrow 1^+} \frac{x^2-3x+2}{x^3-4x} = \lim_{x \rightarrow 1^+} \frac{(x-2)(x-1)}{x(x-2)(x+2)} = \lim_{x \rightarrow 1^+} \frac{(x-1)}{x(x+2)} = \frac{0}{(1)(3)} = 0$
 (e) $\lim_{x \rightarrow 0^+} \frac{x-1}{x(x+2)} = -\infty$ $\left(\frac{\text{negative}}{\text{positive-positive}} \right)$
 and $\lim_{x \rightarrow 0^-} \frac{x-1}{x(x+2)} = \infty$ $\left(\frac{\text{negative}}{\text{negative-positive}} \right)$
 so the function has no limit as $x \rightarrow 0$.
23. (a) $\lim_{t \rightarrow 0^+} \left[2 - \frac{3}{t^{1/3}} \right] = -\infty$ (b) $\lim_{t \rightarrow 0^-} \left[2 - \frac{3}{t^{1/3}} \right] = \infty$
24. (a) $\lim_{t \rightarrow 0^+} \left[\frac{1}{t^{3/5}} + 7 \right] = \infty$ (b) $\lim_{t \rightarrow 0^-} \left[\frac{1}{t^{3/5}} + 7 \right] = -\infty$
25. (a) $\lim_{x \rightarrow 0^+} \left[\frac{1}{x^{2/3}} + \frac{2}{(x-1)^{2/3}} \right] = \infty$ (b) $\lim_{x \rightarrow 0^-} \left[\frac{1}{x^{2/3}} + \frac{2}{(x-1)^{2/3}} \right] = \infty$
 (c) $\lim_{x \rightarrow 1^+} \left[\frac{1}{x^{2/3}} + \frac{2}{(x-1)^{2/3}} \right] = \infty$ (d) $\lim_{x \rightarrow 1^-} \left[\frac{1}{x^{2/3}} + \frac{2}{(x-1)^{2/3}} \right] = \infty$

26. (a) $\lim_{x \rightarrow 0^+} \left[\frac{1}{x^{1/3}} - \frac{1}{(x-1)^{1/3}} \right] = \infty$

(c) $\lim_{x \rightarrow 1^+} \left[\frac{1}{x^{1/3}} - \frac{1}{(x-1)^{1/3}} \right] = -\infty$

(b) $\lim_{x \rightarrow 0^-} \left[\frac{1}{x^{1/3}} - \frac{1}{(x-1)^{1/3}} \right] = -\infty$

(d) $\lim_{x \rightarrow 1^-} \left[\frac{1}{x^{1/3}} - \frac{1}{(x-1)^{1/3}} \right] = -\infty$

27. $y = \frac{1}{x-1}$

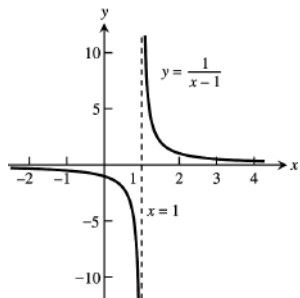

28. $y = \frac{1}{x+1}$

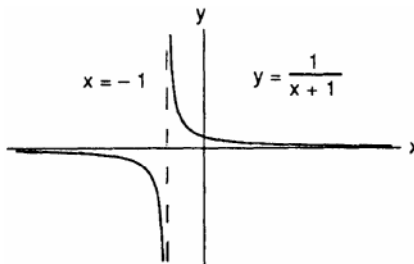

29. $y = \frac{1}{2x+4}$

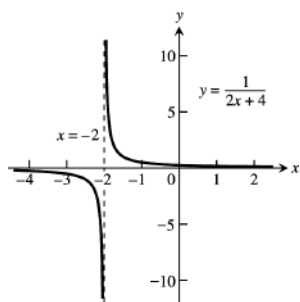

30. $y = \frac{-3}{x-3}$

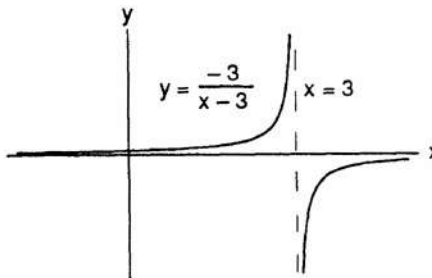

31. $y = \frac{x+3}{x+2} = 1 + \frac{1}{x+2}$

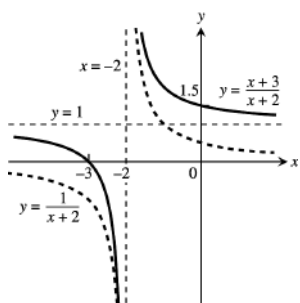

32. $y = \frac{2x}{x+1} = 2 - \frac{2}{x+1}$

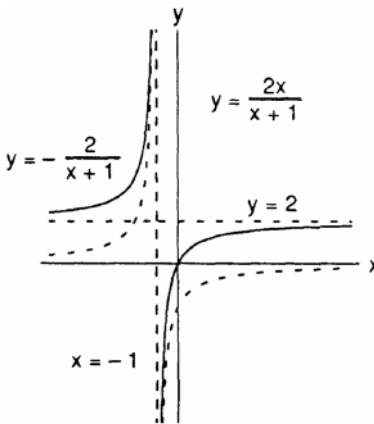

33. $y = \frac{x^2}{x-1} = x + 1 + \frac{1}{x-1}$

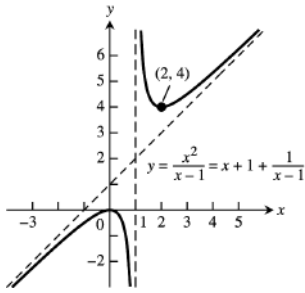

34. $y = \frac{x^2+1}{x-1} = x + 1 + \frac{2}{x-1}$

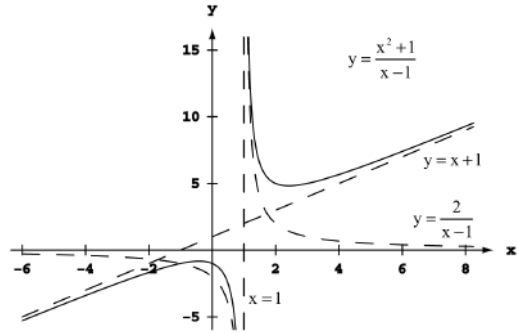

35. $y = \frac{x^2-4}{x-1} = x + 1 - \frac{3}{x-1}$

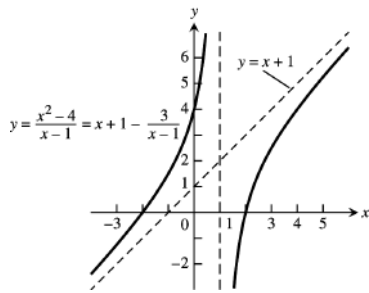

36. $y = \frac{x^2-1}{2x+4} = \frac{1}{2}x - 1 + \frac{3}{2x+4}$

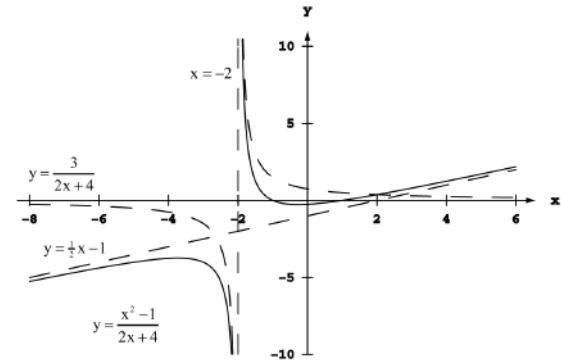

37. $y = \frac{x^2-1}{x} = x - \frac{1}{x}$

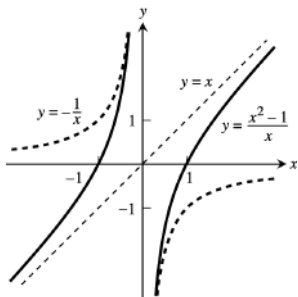

38. $y = \frac{x^3+1}{x^2} = x + \frac{1}{x^2}$

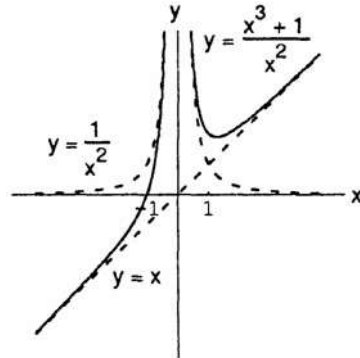

39. Here is one possibility.

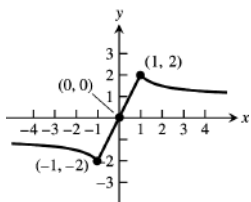

40. Here is one possibility.

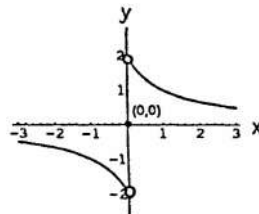

41. Here is one possibility.

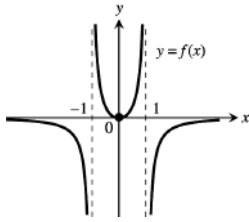

42. Here is one possibility.

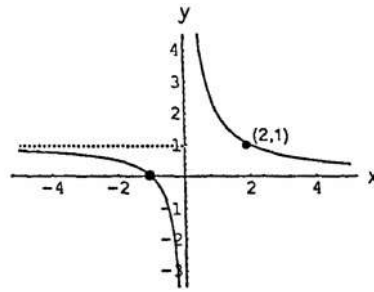

43. Here is one possibility.

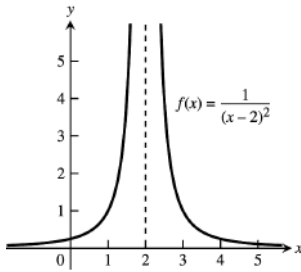

44. Here is one possibility.

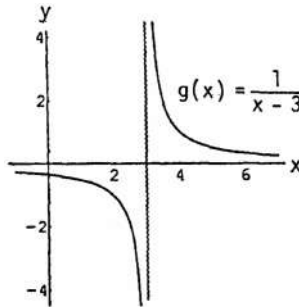

45. Here is one possibility.

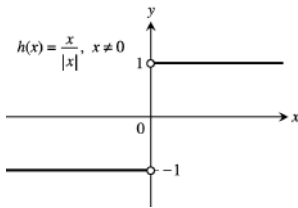

46. Here is one possibility.

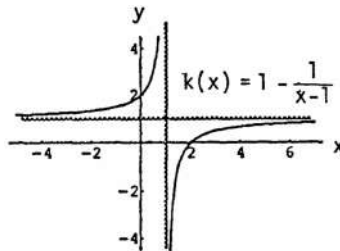

47. For every real number $-B < 0$, we must find a $\delta > 0$ such that for all x , $0 < |x - 0| < \delta \Rightarrow \frac{-1}{x^2} < -B$. Now, $-\frac{1}{x^2} < -B < 0 \Leftrightarrow \frac{1}{x^2} > B > 0 \Leftrightarrow x^2 < \frac{1}{B} \Leftrightarrow |x| < \frac{1}{\sqrt{B}}$. Choose $\delta = \frac{1}{\sqrt{B}}$, then $0 < |x| < \delta \Rightarrow |x| < \frac{1}{\sqrt{B}} \Rightarrow \frac{-1}{x^2} < -B$ so that $\lim_{x \rightarrow 0} -\frac{1}{x^2} = -\infty$.

48. For every real number $B > 0$, we must find a $\delta > 0$ such that for all x , $0 < |x - 0| < \delta \Rightarrow \frac{1}{|x|} > B$. Now, $\frac{1}{|x|} > B > 0 \Leftrightarrow |x| < \frac{1}{B}$. Choose $\delta = \frac{1}{B}$. Then $0 < |x - 0| < \delta \Rightarrow |x| < \frac{1}{B} \Rightarrow \frac{1}{|x|} > B$ so that $\lim_{x \rightarrow 0} \frac{1}{|x|} = \infty$.

49. For every real number $-B < 0$, we must find a $\delta > 0$ such that for all x , $0 < |x - 3| < \delta \Rightarrow \frac{-2}{(x-3)^2} < -B$. Now, $\frac{-2}{(x-3)^2} < -B < 0 \Leftrightarrow \frac{2}{(x-3)^2} > B > 0 \Leftrightarrow \frac{(x-3)^2}{2} < \frac{1}{B} \Leftrightarrow (x-3)^2 < \frac{2}{B} \Leftrightarrow 0 < |x - 3| < \sqrt{\frac{2}{B}}$. Choose $\delta = \sqrt{\frac{2}{B}}$, then $0 < |x - 3| < \delta \Rightarrow \frac{-2}{(x-3)^2} < -B < 0$ so that $\lim_{x \rightarrow 3} \frac{-2}{(x-3)^2} = -\infty$.

50. For every real number $B > 0$, we must find a $\delta > 0$ such that for all x , $0 < |x - (-5)| < \delta \Rightarrow \frac{1}{(x+5)^2} > B$. Now, $\frac{1}{(x+5)^2} > B > 0 \Leftrightarrow (x+5)^2 < \frac{1}{B} \Leftrightarrow |x+5| < \frac{1}{\sqrt{B}}$. Choose $\delta = \frac{1}{\sqrt{B}}$. Then $0 < |x - (-5)| < \delta \Rightarrow |x+5| < \frac{1}{\sqrt{B}} \Rightarrow \frac{1}{(x+5)^2} > B$ so that $\lim_{x \rightarrow -5} \frac{1}{(x+5)^2} = \infty$.

51. (a) We say that $f(x)$ approaches infinity as x approaches x_0 from the left, and write $\lim_{x \rightarrow x_0^-} f(x) = \infty$, if for every positive number B , there exists a corresponding number $\delta > 0$ such that for all x , $x_0 - \delta < x < x_0 \Rightarrow f(x) > B$.
- (b) We say that $f(x)$ approaches minus infinity as x approaches x_0 from the right, and write $\lim_{x \rightarrow x_0^+} f(x) = -\infty$, if for every positive number B (or negative number $-B$) there exists a corresponding number $\delta > 0$ such that for all x , $x_0 < x < x_0 + \delta \Rightarrow f(x) < -B$.
- (c) We say that $f(x)$ approaches minus infinity as x approaches x_0 from the left, and write $\lim_{x \rightarrow x_0^-} f(x) = -\infty$, if for every positive number B (or negative number $-B$) there exists a corresponding number $\delta > 0$ such that for all x , $x_0 - \delta < x < x_0 \Rightarrow f(x) < -B$.

52. For $B > 0$, $\frac{1}{x} > B > 0 \Leftrightarrow x < \frac{1}{B}$. Choose $\delta = \frac{1}{B}$. Then $0 < x < \delta \Rightarrow 0 < x < \frac{1}{B} \Rightarrow \frac{1}{x} > B$ so that $\lim_{x \rightarrow 0^+} \frac{1}{x} = \infty$.

53. For $B > 0$, $\frac{1}{x} < -B < 0 \Leftrightarrow -\frac{1}{x} > B > 0 \Leftrightarrow -x < \frac{1}{B} \Leftrightarrow -\frac{1}{B} < x$. Choose $\delta = \frac{1}{B}$. Then $-\delta < x < 0 \Rightarrow -\frac{1}{B} < x \Rightarrow \frac{1}{x} < -B$ so that $\lim_{x \rightarrow 0^-} \frac{1}{x} = -\infty$.

54. For $B > 0$, $\frac{1}{x-2} < -B \Leftrightarrow -\frac{1}{x-2} > B \Leftrightarrow -(x-2) < \frac{1}{B} \Leftrightarrow x-2 > -\frac{1}{B} \Leftrightarrow x > 2 - \frac{1}{B}$. Choose $\delta = \frac{1}{B}$. Then $2 - \delta < x < 2 \Rightarrow -\delta < x - 2 < 0 \Rightarrow -\frac{1}{B} < x - 2 < 0 \Rightarrow \frac{1}{x-2} < -B < 0$ so that $\lim_{x \rightarrow 2^-} \frac{1}{x-2} = -\infty$.

55. For $B > 0$, $\frac{1}{x-2} > B \Leftrightarrow 0 < x - 2 < \frac{1}{B}$. Choose $\delta = \frac{1}{B}$. Then $2 < x < 2 + \delta \Rightarrow 0 < x - 2 < \delta \Rightarrow 0 < x - 2 < \frac{1}{B} \Rightarrow \frac{1}{x-2} > B > 0$ so that $\lim_{x \rightarrow 2^+} \frac{1}{x-2} = \infty$.

56. For $B > 0$ and $0 < x < 1$, $\frac{1}{1-x^2} > B \Leftrightarrow 1 - x^2 < \frac{1}{B} \Leftrightarrow (1-x)(1+x) < \frac{1}{B}$. Now $\frac{1+x}{2} < 1$ since $x < 1$. Choose $\delta < \frac{1}{2B}$. Then $1 - \delta < x < 1 \Rightarrow -\delta < x - 1 < 0 \Rightarrow 1 - x < \delta < \frac{1}{2B} \Rightarrow (1-x)(1+x) < \frac{1}{B} \left(\frac{1+x}{2}\right) < \frac{1}{B} \Rightarrow \frac{1}{1-x^2} > B$ for $0 < x < 1$ and x near 1 $\Rightarrow \lim_{x \rightarrow 1^-} \frac{1}{1-x^2} = \infty$.

57. $y = \sec x + \frac{1}{x}$

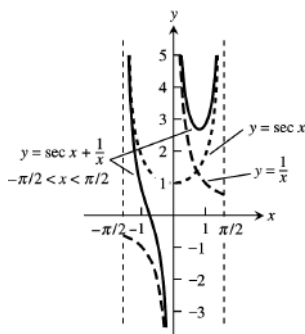

58. $y = \sec x - \frac{1}{x^2}$

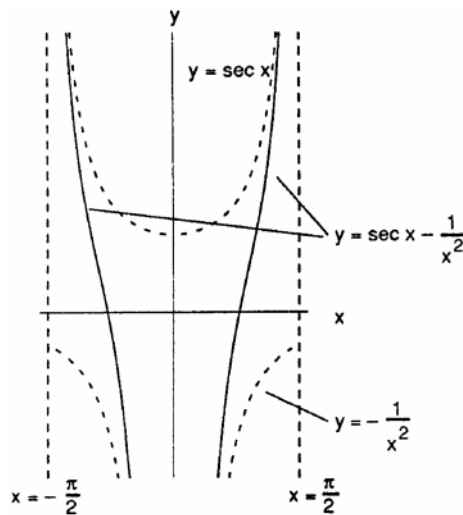

59. $y = \tan x + \frac{1}{x^2}$

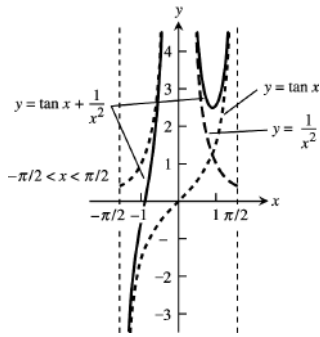

60. $y = \frac{1}{x} - \tan x$

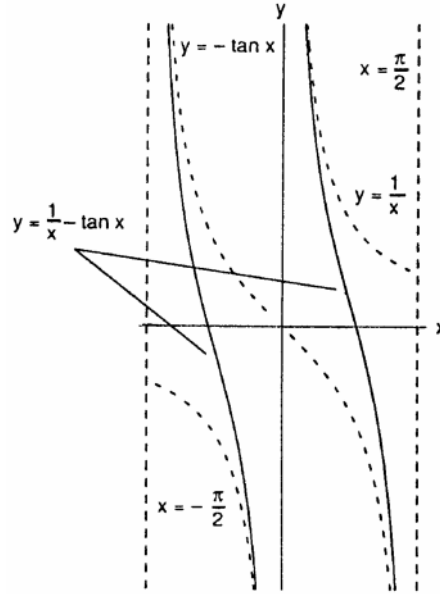

61. $y = \frac{x}{\sqrt{4-x^2}}$

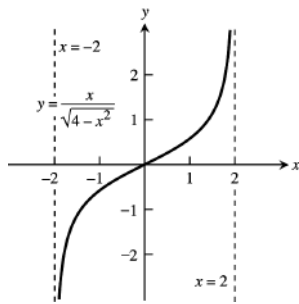

62. $y = \frac{-1}{\sqrt{4-x^2}}$

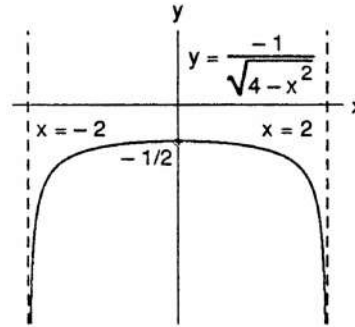

63. $y = x^{2/3} + \frac{1}{x^{1/3}}$

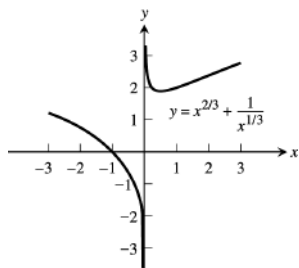

64. $y = \sin\left(\frac{\pi}{x^2+1}\right)$

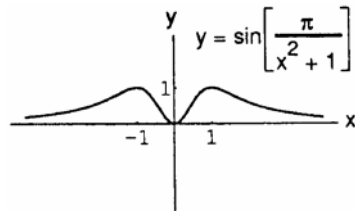

2.6 CONTINUITY

1. No, discontinuous at $x = 2$, not defined at $x = 2$
2. No, discontinuous at $x = 3$, $1 = \lim_{x \rightarrow 3^-} g(x) \neq g(3) = 1.5$

3. Continuous on $[-1, 3]$
4. No, discontinuous at $x = 1$, $1.5 = \lim_{x \rightarrow 1^-} k(x) \neq \lim_{x \rightarrow 1^+} k(x) = 0$
5. (a) Yes (b) Yes, $\lim_{x \rightarrow -1^+} f(x) = 0$
(c) Yes (d) Yes
6. (a) Yes, $f(1) = 1$ (b) Yes, $\lim_{x \rightarrow 1} f(x) = 2$
(c) No (d) No
7. (a) No (b) No
8. $[-1, 0) \cup (0, 1) \cup (1, 2) \cup (2, 3)$
9. $f(2) = 0$, since $\lim_{x \rightarrow 2^-} f(x) = -2(2) + 4 = 0 = \lim_{x \rightarrow 2^+} f(x)$
10. $f(1)$ should be changed to $2 = \lim_{x \rightarrow 1} f(x)$
11. Nonremovable discontinuity at $x = 1$ because $\lim_{x \rightarrow 1} f(x)$ fails to exist ($\lim_{x \rightarrow 1^-} f(x) = 1$ and $\lim_{x \rightarrow 1^+} f(x) = 0$).
Removable discontinuity at $x = 0$ by assigning the number $\lim_{x \rightarrow 0} f(x) = 0$ to be the value of $f(0)$ rather than $f(0) = 1$.
12. Nonremovable discontinuity at $x = 1$ because $\lim_{x \rightarrow 1} f(x)$ fails to exist ($\lim_{x \rightarrow 1^-} f(x) = 2$ and $\lim_{x \rightarrow 1^+} f(x) = 1$).
Removable discontinuity at $x = 2$ by assigning the number $\lim_{x \rightarrow 2} f(x) = 1$ to be the value of $f(2)$ rather than $f(2) = 2$.
13. Discontinuous only when $x - 2 = 0 \Rightarrow x = 2$ 14. Discontinuous only when $(x + 2)^2 = 0 \Rightarrow x = -2$
15. Discontinuous only when $x^2 - 4x + 3 = 0 \Rightarrow (x - 3)(x - 1) = 0 \Rightarrow x = 3$ or $x = 1$
16. Discontinuous only when $x^2 - 3x - 10 = 0 \Rightarrow (x - 5)(x + 2) = 0 \Rightarrow x = 5$ or $x = -2$
17. Continuous everywhere. ($|x - 1| + \sin x$ defined for all x ; limits exist and are equal to function values.)
18. Continuous everywhere. ($|x| + 1 \neq 0$ for all x ; limits exist and are equal to function values.)
19. Discontinuous only at $x = 0$
20. Discontinuous at odd integer multiples of $\frac{\pi}{2}$, i.e., $x = (2n - 1)\frac{\pi}{2}$, n an integer, but continuous at all other x .
21. Discontinuous when $2x$ is an integer multiple of π , i.e., $2x = n\pi$, n an integer $\Rightarrow x = \frac{n\pi}{2}$, n an integer, but continuous at all other x .
22. Discontinuous when $\frac{\pi x}{2}$ is an odd integer multiple of $\frac{\pi}{2}$, i.e., $\frac{\pi x}{2} = (2n - 1)\frac{\pi}{2}$, n an integer $\Rightarrow x = 2n - 1$, n an integer (i.e., x is an odd integer). Continuous everywhere else.

100 Chapter 2 Limits and Continuity

23. Discontinuous at odd integer multiples of $\frac{\pi}{2}$, i.e., $x = (2n - 1)\frac{\pi}{2}$, n an integer, but continuous at all other x .
24. Continuous everywhere since $x^4 + 1 \geq 1$ and $-1 \leq \sin x \leq 1 \Rightarrow 0 \leq \sin^2 x \leq 1 \Rightarrow 1 + \sin^2 x \geq 1$; limits exist and are equal to the function values.
25. Discontinuous when $2x + 3 < 0$ or $x < -\frac{3}{2} \Rightarrow$ continuous on the interval $[-\frac{3}{2}, \infty)$.
26. Discontinuous when $3x - 1 < 0$ or $x < \frac{1}{3} \Rightarrow$ continuous on the interval $[\frac{1}{3}, \infty)$.
27. Continuous everywhere: $(2x - 1)^{1/3}$ is defined for all x ; limits exist and are equal to function values.
28. Continuous everywhere: $(2 - x)^{1/5}$ is defined for all x ; limits exist and are equal to function values.
29. $\lim_{x \rightarrow \pi} \sin(x - \sin x) = \sin(\pi - \sin \pi) = \sin(\pi - 0) = \sin \pi = 0$, and function continuous at $x = \pi$.
30. $\lim_{t \rightarrow 0} \sin(\frac{\pi}{2} \cos(\tan t)) = \sin(\frac{\pi}{2} \cos(\tan(0))) = \sin(\frac{\pi}{2} \cos(0)) = \sin(\frac{\pi}{2}) = 1$, and function continuous at $t = 0$.
31. $\lim_{y \rightarrow 1} \sec(y \sec^2 y - \tan^2 y - 1) = \lim_{y \rightarrow 1} \sec(y \sec^2 y - \sec^2 y) = \lim_{y \rightarrow 1} \sec((y - 1) \sec^2 y) = \sec((1 - 1) \sec^2 1) = \sec 0 = 1$, and function continuous at $y = 1$.
32. $\lim_{x \rightarrow 0} \tan[\frac{\pi}{4} \cos(\sin x^{1/3})] = \tan[\frac{\pi}{4} \cos(\sin(0))] = \tan(\frac{\pi}{4} \cos(0)) = \tan(\frac{\pi}{4}) = 1$, and function continuous at $x = 0$.
33. $\lim_{t \rightarrow 0} \cos[\frac{\pi}{\sqrt{19-3 \sec 2t}}] = \cos[\frac{\pi}{\sqrt{19-3 \sec 0}}] = \cos \frac{\pi}{\sqrt{16}} = \cos \frac{\pi}{4} = \frac{\sqrt{2}}{2}$, and function continuous at $t = 0$.
34. $\lim_{x \rightarrow \frac{\pi}{6}} \sqrt{\csc^2 x + 5\sqrt{3} \tan x} = \sqrt{\csc^2(\frac{\pi}{6}) + 5\sqrt{3} \tan(\frac{\pi}{6})} = \sqrt{4 + 5\sqrt{3}(\frac{1}{\sqrt{3}})} = \sqrt{9} = 3$, and function continuous at $x = \frac{\pi}{6}$.
35. $g(x) = \frac{x^2 - 9}{x - 3} = \frac{(x+3)(x-3)}{(x-3)} = x + 3, x \neq 3 \Rightarrow g(3) = \lim_{x \rightarrow 3} (x + 3) = 6$
36. $h(t) = \frac{t^2 + 3t - 10}{t - 2} = \frac{(t+5)(t-2)}{t-2} = t + 5, t \neq 2 \Rightarrow h(2) = \lim_{t \rightarrow 2} (t + 5) = 7$
37. $f(s) = \frac{s^3 - 1}{s^2 - 1} = \frac{(s^2 + s + 1)(s - 1)}{(s + 1)(s - 1)} = \frac{s^2 + s + 1}{s + 1}, s \neq 1 \Rightarrow f(1) = \lim_{s \rightarrow 1} \left(\frac{s^2 + s + 1}{s + 1}\right) = \frac{3}{2}$
38. $g(x) = \frac{x^2 - 16}{x^2 - 3x - 4} = \frac{(x+4)(x-4)}{(x-4)(x+1)} = \frac{x+4}{x+1}, x \neq 4 \Rightarrow g(4) = \lim_{x \rightarrow 4} \left(\frac{x+4}{x+1}\right) = \frac{8}{5}$
39. As defined, $\lim_{x \rightarrow 3^-} f(x) = (3)^2 - 1 = 8$ and $\lim_{x \rightarrow 3^+} (2a)(3) = 6a$. For $f(x)$ to be continuous we must have $6a = 8 \Rightarrow a = \frac{4}{3}$.
40. As defined, $\lim_{x \rightarrow -2^-} g(x) = -2$ and $\lim_{x \rightarrow -2^+} g(x) = b(-2)^2 = 4b$. For $g(x)$ to be continuous we must have $4b = -2 \Rightarrow b = -\frac{1}{2}$.

41. The function can be extended: $f(0) \approx 2.3$.

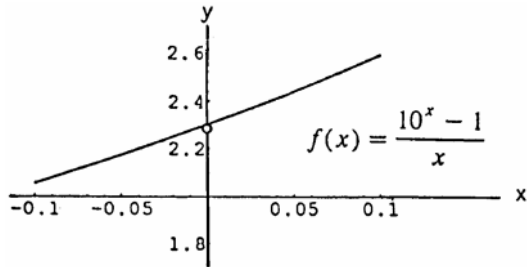

42. The function cannot be extended to be continuous at $x = 0$. If $f(0) \approx 2.3$, it will be continuous from the right. Or if $f(0) \approx -2.3$, it will be continuous from the left.

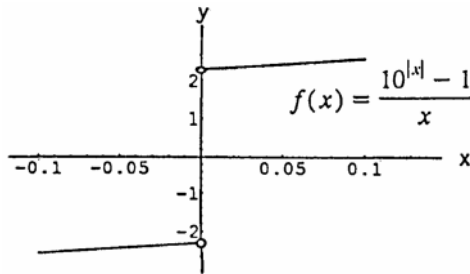

43. The function cannot be extended to be continuous at $x = 0$. If $f(0) = 1$, it will be continuous from the right. Or if $f(0) = -1$, it will be continuous from the left.

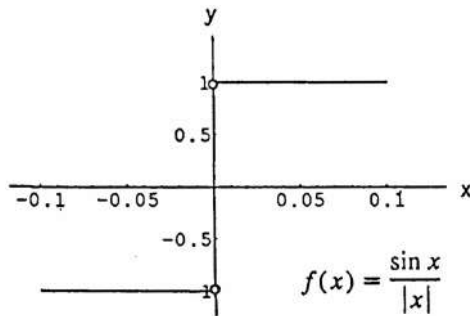

44. The function can be extended: $f(0) \approx 7.39$.

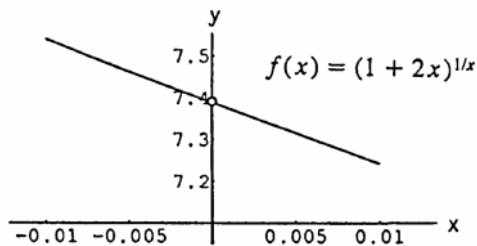

45. $f(x)$ is continuous on $[0, 1]$ and $f(0) < 0, f(1) > 0$
 \Rightarrow by the Intermediate Value Theorem $f(x)$ takes on every value between $f(0)$ and $f(1)$ \Rightarrow the equation $f(x) = 0$ has at least one solution between $x = 0$ and $x = 1$.

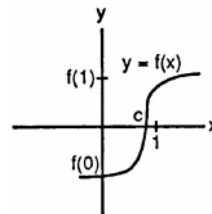

46. $\cos x = x \Rightarrow (\cos x) - x = 0$. If $x = -\frac{\pi}{2}$, $\cos(-\frac{\pi}{2}) - (-\frac{\pi}{2}) > 0$. If $x = \frac{\pi}{2}$, $\cos(\frac{\pi}{2}) - \frac{\pi}{2} < 0$. Thus $\cos x - x = 0$ for some x between $-\frac{\pi}{2}$ and $\frac{\pi}{2}$ according to the Intermediate Value Theorem.

47. Let $f(x) = x^3 - 15x + 1$ which is continuous on $[-4, 4]$. Then $f(-4) = -3, f(-1) = 15, f(1) = -13$, and $f(4) = 5$. By the Intermediate Value Theorem, $f(x) = 0$ for some x in each of the intervals $-4 < x < -1, -1 < x < 1$, and $1 < x < 4$. That is, $x^3 - 15x + 1 = 0$ has three solutions in $[-4, 4]$. Since a polynomial of degree 3 can have at most 3 solutions, these are the only solutions.

48. Without loss of generality, assume that $a < b$. Then $F(x) = (x - a)^2(x - b)^2 + x$ is continuous for all values of x , so it is continuous on the interval $[a, b]$. Moreover $F(a) = a$ and $F(b) = b$. By the Intermediate Value Theorem, since $a < \frac{a+b}{2} < b$, there is a number c between a and b such that $F(x) = \frac{a+b}{2}$.

102 Chapter 2 Limits and Continuity

49. Answers may vary. Note that f is continuous for every value of x .

- (a) $f(0) = 10$, $f(1) = 1^3 - 8(1) + 10 = 3$. Since $3 < \pi < 10$, by the Intermediate Value Theorem, there exists a c so that $0 < c < 1$ and $f(c) = \pi$.
- (b) $f(0) = 10$, $f(-4) = (-4)^3 - 8(-4) + 10 = -22$. Since $-22 < -\sqrt{3} < 10$, by the Intermediate Value Theorem, there exists a c so that $-4 < c < 0$ and $f(c) = -\sqrt{3}$.
- (c) $f(0) = 10$, $f(1000) = (1000)^3 - 8(1000) + 10 = 999,992,010$. Since $10 < 5,000,000 < 999,992,010$, by the Intermediate Value Theorem, there exists a c so that $0 < c < 1000$ and $f(c) = 5,000,000$.

50. All five statements ask for the same information because of the intermediate value property of continuous functions.

- (a) A root of $f(x) = x^3 - 3x - 1$ is a point c where $f(c) = 0$.
- (b) The points where $y = x^3$ crosses $y = 3x + 1$ have the same y -coordinate, or $y = x^3 = 3x + 1$
 $\Rightarrow f(x) = x^3 - 3x - 1 = 0$.
- (c) $x^3 - 3x = 1 \Rightarrow x^3 - 3x - 1 = 0$. The solutions to the equation are the roots of $f(x) = x^3 - 3x - 1$.
- (d) The points where $y = x^3 - 3x$ crosses $y = 1$ have common y -coordinates, or $y = x^3 - 3x = 1$
 $\Rightarrow f(x) = x^3 - 3x - 1 = 0$.
- (e) The solutions of $x^3 - 3x - 1 = 0$ are those points where $f(x) = x^3 - 3x - 1$ has value 0.

51. Answers may vary. For example, $f(x) = \frac{\sin(x-2)}{x-2}$ is discontinuous at $x = 2$ because it is not defined there. However, the discontinuity can be removed because f has a limit (namely 1) as $x \rightarrow 2$.

52. Answers may vary. For example, $g(x) = \frac{1}{x+1}$ has a discontinuity at $x = -1$ because $\lim_{x \rightarrow -1} g(x)$ does not exist.

$$\left(\lim_{x \rightarrow -1^-} g(x) = -\infty \text{ and } \lim_{x \rightarrow -1^+} g(x) = +\infty. \right)$$

53. (a) Suppose x_0 is rational $\Rightarrow f(x_0) = 1$. Choose $\epsilon = \frac{1}{2}$. For any $\delta > 0$ there is an irrational number x (actually infinitely many) in the interval $(x_0 - \delta, x_0 + \delta) \Rightarrow f(x) = 0$. Then $0 < |x - x_0| < \delta$ but $|f(x) - f(x_0)| = 1 > \frac{1}{2} = \epsilon$, so $\lim_{x \rightarrow x_0} f(x)$ fails to exist $\Rightarrow f$ is discontinuous at x_0 rational.

On the other hand, x_0 irrational $\Rightarrow f(x_0) = 0$ and there is a rational number x in $(x_0 - \delta, x_0 + \delta) \Rightarrow f(x) = 1$. Again $\lim_{x \rightarrow x_0} f(x)$ fails to exist $\Rightarrow f$ is discontinuous at x_0 irrational. That is, f is discontinuous at every point.

(b) f is neither right-continuous nor left-continuous at any point x_0 because in every interval $(x_0 - \delta, x_0)$ or $(x_0, x_0 + \delta)$ there exist both rational and irrational real numbers. Thus neither limits $\lim_{x \rightarrow x_0^-} f(x)$ and

$\lim_{x \rightarrow x_0^+} f(x)$ exist by the same arguments used in part (a).

54. Yes. Both $f(x) = x$ and $g(x) = x - \frac{1}{2}$ are continuous on $[0, 1]$. However $\frac{f(x)}{g(x)}$ is undefined at $x = \frac{1}{2}$ since $g\left(\frac{1}{2}\right) = 0 \Rightarrow \frac{f(x)}{g(x)}$ is discontinuous at $x = \frac{1}{2}$.

55. No. For instance, if $f(x) = 0$, $g(x) = \lceil x \rceil$, then $h(x) = 0(\lceil x \rceil) = 0$ is continuous at $x = 0$ and $g(x)$ is not.

56. Let $f(x) = \frac{1}{x-1}$ and $g(x) = x + 1$. Both functions are continuous at $x = 0$. The composition $f \circ g = f(g(x)) = \frac{1}{(x+1)-1} = \frac{1}{x}$ is discontinuous at $x = 0$, since it is not defined there. Theorem 10 requires that $f(x)$ be continuous at $g(0)$, which is not the case here since $g(0) = 1$ and f is undefined at 1.

57. Yes, because of the Intermediate Value Theorem. If $f(a)$ and $f(b)$ did have different signs then f would have to equal zero at some point between a and b since f is continuous on $[a, b]$.

58. Let $f(x)$ be the new position of point x and let $d(x) = f(x) - x$. The displacement function d is negative if x is the left-hand point of the rubber band and positive if x is the right-hand point of the rubber band. By the Intermediate Value Theorem, $d(x) = 0$ for some point in between. That is, $f(x) = x$ for some point x , which is then in its original position.
59. If $f(0) = 0$ or $f(1) = 1$, we are done (i.e., $c = 0$ or $c = 1$ in those cases). Then let $f(0) = a > 0$ and $f(1) = b < 1$ because $0 \leq f(x) \leq 1$. Define $g(x) = f(x) - x \Rightarrow g$ is continuous on $[0, 1]$. Moreover, $g(0) = f(0) - 0 = a > 0$ and $g(1) = f(1) - 1 = b - 1 < 0 \Rightarrow$ by the Intermediate Value Theorem there is a number c in $(0, 1)$ such that $g(c) = 0 \Rightarrow f(c) - c = 0$ or $f(c) = c$.
60. Let $\epsilon = \frac{|f(c)|}{2} > 0$. Since f is continuous at $x = c$ there is a $\delta > 0$ such that $|x - c| < \delta \Rightarrow |f(x) - f(c)| < \epsilon \Rightarrow f(c) - \epsilon < f(x) < f(c) + \epsilon$.
 If $f(c) > 0$, then $\epsilon = \frac{1}{2} f(c) \Rightarrow \frac{1}{2} f(c) < f(x) < \frac{3}{2} f(c) \Rightarrow f(x) > 0$ on the interval $(c - \delta, c + \delta)$.
 If $f(c) < 0$, then $\epsilon = -\frac{1}{2} f(c) \Rightarrow \frac{3}{2} f(c) < f(x) < \frac{1}{2} f(c) \Rightarrow f(x) < 0$ on the interval $(c - \delta, c + \delta)$.

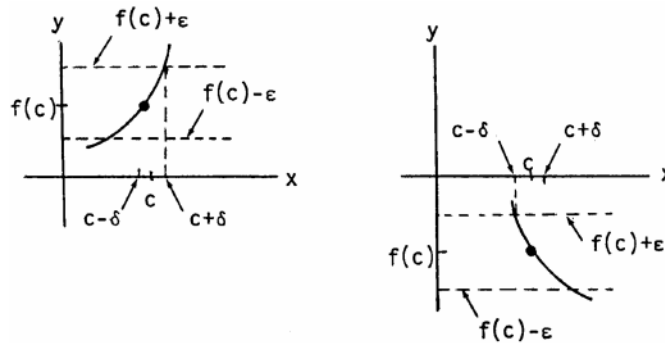

61. By Exercises 52 in Section 2.3, we have $\lim_{x \rightarrow c} f(x) = L \Leftrightarrow \lim_{h \rightarrow 0} f(c + h) = L$.
 Thus, $f(x)$ is continuous at $x = c \Leftrightarrow \lim_{x \rightarrow c} f(x) = f(c) \Leftrightarrow \lim_{h \rightarrow 0} f(c + h) = f(c)$.
62. By Exercise 61, it suffices to show that $\lim_{h \rightarrow 0} \sin(c + h) = \sin c$ and $\lim_{h \rightarrow 0} \cos(c + h) = \cos c$.
 Now $\lim_{h \rightarrow 0} \sin(c + h) = \lim_{h \rightarrow 0} [(\sin c)(\cos h) + (\cos c)(\sin h)] = (\sin c) \left(\lim_{h \rightarrow 0} \cos h \right) + (\cos c) \left(\lim_{h \rightarrow 0} \sin h \right)$
 By Example 6 Section 2.2, $\lim_{h \rightarrow 0} \cos h = 1$ and $\lim_{h \rightarrow 0} \sin h = 0$. So $\lim_{h \rightarrow 0} \sin(c + h) = \sin c$ and thus $f(x) = \sin x$ is continuous at $x = c$. Similarly,
 $\lim_{h \rightarrow 0} \cos(c + h) = \lim_{h \rightarrow 0} [(\cos c)(\cos h) - (\sin c)(\sin h)] = (\cos c) \left(\lim_{h \rightarrow 0} \cos h \right) - (\sin c) \left(\lim_{h \rightarrow 0} \sin h \right) = \cos c$.
 Thus, $g(x) = \cos x$ is continuous at $x = c$.

63. $x \approx 1.8794, -1.5321, -0.3473$ 64. $x \approx 1.4516, -0.8547, 0.4030$
65. $x \approx 1.7549$ 66. $x \approx 1.5596$
67. $x \approx 3.5156$ 68. $x \approx -3.9058, 3.8392, 0.0667$
69. $x \approx 0.7391$ 70. $x \approx -1.8955, 0, 1.8955$

2.7 TANGENTS AND DERIVATIVES

1. $P_1: m_1 = 1, P_2: m_2 = 5$ 2. $P_1: m_1 = -2, P_2: m_2 = 0$

3. $P_1: m_1 = \frac{5}{2}, P_2: m_2 = -\frac{1}{2}$

4. $P_1: m_1 = 3, P_2: m_2 = -3$

5.
$$m = \lim_{h \rightarrow 0} \frac{[4 - (-1+h)^2] - [4 - (-1)^2]}{h}$$

$$= \lim_{h \rightarrow 0} \frac{-(1-2h+h^2)+1}{h} = \lim_{h \rightarrow 0} \frac{h(2-h)}{h} = 2;$$
 at $(-1, 3): y = 3 + 2(x - (-1)) \Rightarrow y = 2x + 5,$
 tangent line

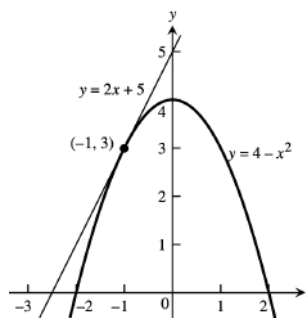

6.
$$m = \lim_{h \rightarrow 0} \frac{[(1+h-1)^2+1] - [(1-1)^2+1]}{h} = \lim_{h \rightarrow 0} \frac{h^2}{h}$$

$$= \lim_{h \rightarrow 0} h = 0; \text{ at } (1, 1): y = 1 + 0(x - 1) \Rightarrow y = 1,$$

 tangent line

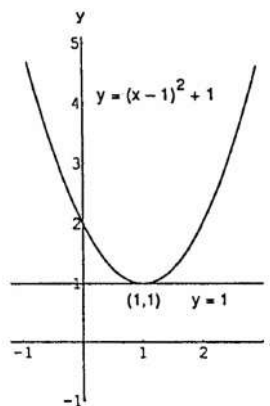

7.
$$m = \lim_{h \rightarrow 0} \frac{2\sqrt{1+h} - 2\sqrt{1}}{h} = \lim_{h \rightarrow 0} \frac{2\sqrt{1+h} - 2}{h} \cdot \frac{2\sqrt{1+h} + 2}{2\sqrt{1+h} + 2}$$

$$= \lim_{h \rightarrow 0} \frac{4(1+h) - 4}{2h(\sqrt{1+h} + 1)} = \lim_{h \rightarrow 0} \frac{2}{\sqrt{1+h} + 1} = 1;$$
 at $(1, 2): y = 2 + 1(x - 1) \Rightarrow y = x + 1,$ tangent line

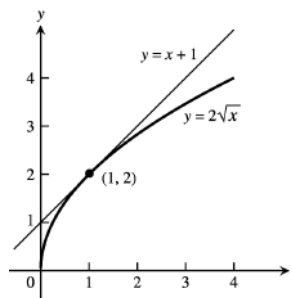

8.
$$m = \lim_{h \rightarrow 0} \frac{\frac{1}{(-1+h)^2} - \frac{1}{(-1)^2}}{h} = \lim_{h \rightarrow 0} \frac{1 - (-1+h)^2}{h(-1+h)^2}$$

$$= \lim_{h \rightarrow 0} \frac{-(-2h+h^2)}{h(-1+h)^2} = \lim_{h \rightarrow 0} \frac{2-h}{(-1+h)^2} = 2;$$
 at $(-1, 1): y = 1 + 2(x - (-1)) \Rightarrow y = 2x + 3,$
 tangent line

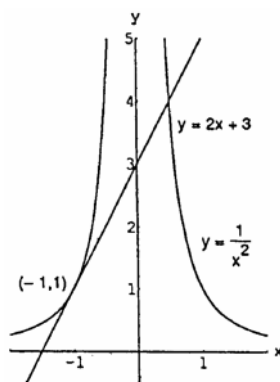

$$\begin{aligned}
 9. \quad m &= \lim_{h \rightarrow 0} \frac{(-2+h)^3 - (-2)^3}{h} = \lim_{h \rightarrow 0} \frac{-8 + 12h - 6h^2 + h^3 + 8}{h} \\
 &= \lim_{h \rightarrow 0} (12 - 6h + h^2) = 12; \\
 \text{at } (-2, -8): \quad y &= -8 + 12(x - (-2)) \Rightarrow y = 12x + 16, \\
 &\text{tangent line}
 \end{aligned}$$

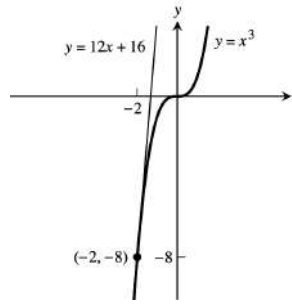

$$\begin{aligned}
 10. \quad m &= \lim_{h \rightarrow 0} \frac{\frac{1}{(-2+h)^3} - \frac{1}{(-2)^3}}{h} = \lim_{h \rightarrow 0} \frac{-8 - (-2+h)^3}{-8h(-2+h)^3} \\
 &= \lim_{h \rightarrow 0} \frac{-(12h - 6h^2 + h^3)}{-8h(-2+h)^3} = \lim_{h \rightarrow 0} \frac{12 - 6h + h^2}{8(-2+h)^3} \\
 &= \frac{12}{8(-8)} = -\frac{3}{16}; \\
 \text{at } (-2, -\frac{1}{8}): \quad y &= -\frac{1}{8} - \frac{3}{16}(x - (-2)) \\
 \Rightarrow y &= -\frac{3}{16}x - \frac{1}{2}, \text{ tangent line}
 \end{aligned}$$

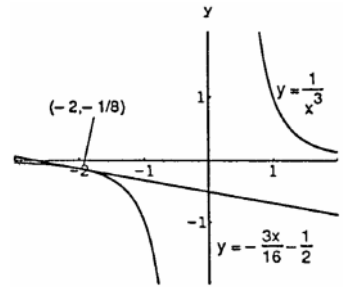

$$\begin{aligned}
 11. \quad m &= \lim_{h \rightarrow 0} \frac{[(2+h)^2 + 1] - 5}{h} = \lim_{h \rightarrow 0} \frac{(5+4h+h^2) - 5}{h} = \lim_{h \rightarrow 0} \frac{h(4+h)}{h} = 4; \\
 \text{at } (2, 5): \quad y - 5 &= 4(x - 2), \text{ tangent line}
 \end{aligned}$$

$$\begin{aligned}
 12. \quad m &= \lim_{h \rightarrow 0} \frac{[(1+h) - 2(1+h)^2] - (-1)}{h} = \lim_{h \rightarrow 0} \frac{(1+h-2-4h-2h^2)+1}{h} = \lim_{h \rightarrow 0} \frac{h(-3-2h)}{h} = -3; \\
 \text{at } (1, -1): \quad y + 1 &= -3(x - 1), \text{ tangent line}
 \end{aligned}$$

$$\begin{aligned}
 13. \quad m &= \lim_{h \rightarrow 0} \frac{\frac{3+h}{(3+h)-2} - 3}{h} = \lim_{h \rightarrow 0} \frac{(3+h) - 3(h+1)}{h(h+1)} = \lim_{h \rightarrow 0} \frac{-2h}{h(h+1)} = -2; \\
 \text{at } (3, 3): \quad y - 3 &= -2(x - 3), \text{ tangent line}
 \end{aligned}$$

$$\begin{aligned}
 14. \quad m &= \lim_{h \rightarrow 0} \frac{\frac{8}{(2+h)^2} - 2}{h} = \lim_{h \rightarrow 0} \frac{8 - 2(2+h)^2}{h(2+h)^2} = \lim_{h \rightarrow 0} \frac{8 - 2(4+4h+h^2)}{h(2+h)^2} = \lim_{h \rightarrow 0} \frac{-2h(4+h)}{h(2+h)^2} = \frac{-8}{4} = -2; \\
 \text{at } (2, 2): \quad y - 2 &= -2(x - 2)
 \end{aligned}$$

$$\begin{aligned}
 15. \quad m &= \lim_{h \rightarrow 0} \frac{(2+h)^3 - 8}{h} = \lim_{h \rightarrow 0} \frac{(8+12h+6h^2+h^3) - 8}{h} = \lim_{h \rightarrow 0} \frac{h(12+6h+h^2)}{h} = 12; \\
 \text{at } (2, 8): \quad y - 8 &= 12(t - 2), \text{ tangent line}
 \end{aligned}$$

$$\begin{aligned}
 16. \quad m &= \lim_{h \rightarrow 0} \frac{[(1+h)^3 + 3(1+h)] - 4}{h} = \lim_{h \rightarrow 0} \frac{(1+3h+3h^2+h^3+3+3h) - 4}{h} = \lim_{h \rightarrow 0} \frac{h(6+3h+h^2)}{h} = 6; \\
 \text{at } (1, 4): \quad y - 4 &= 6(t - 1), \text{ tangent line}
 \end{aligned}$$

$$\begin{aligned}
 17. \quad m &= \lim_{h \rightarrow 0} \frac{\sqrt{4+h} - 2}{h} = \lim_{h \rightarrow 0} \frac{\sqrt{4+h} - 2}{h} \cdot \frac{\sqrt{4+h} + 2}{\sqrt{4+h} + 2} = \lim_{h \rightarrow 0} \frac{(4+h) - 4}{h(\sqrt{4+h} + 2)} = \lim_{h \rightarrow 0} \frac{h}{h(\sqrt{4+h} + 2)} = \frac{1}{\sqrt{4+2}} \\
 &= \frac{1}{4}; \text{ at } (4, 2): \quad y - 2 = \frac{1}{4}(x - 4), \text{ tangent line}
 \end{aligned}$$

$$\begin{aligned}
 18. \quad m &= \lim_{h \rightarrow 0} \frac{\sqrt{(8+h)+1} - 3}{h} = \lim_{h \rightarrow 0} \frac{\sqrt{9+h} - 3}{h} \cdot \frac{\sqrt{9+h} + 3}{\sqrt{9+h} + 3} = \lim_{h \rightarrow 0} \frac{(9+h) - 9}{h(\sqrt{9+h} + 3)} = \lim_{h \rightarrow 0} \frac{h}{h(\sqrt{9+h} + 3)} \\
 &= \frac{1}{\sqrt{9+3}} = \frac{1}{6}; \text{ at } (8, 3): \quad y - 3 = \frac{1}{6}(x - 8), \text{ tangent line}
 \end{aligned}$$

$$19. \quad \text{At } x = -1, y = 5 \Rightarrow m = \lim_{h \rightarrow 0} \frac{5(-1+h)^2 - 5}{h} = \lim_{h \rightarrow 0} \frac{5(1-2h+h^2) - 5}{h} = \lim_{h \rightarrow 0} \frac{5h(-2+h)}{h} = -10, \text{ slope}$$

$$20. \text{ At } x = 2, y = -3 \Rightarrow m = \lim_{h \rightarrow 0} \frac{[1 - (2+h)^2] - (-3)}{h} = \lim_{h \rightarrow 0} \frac{(1 - 4 - 4h - h^2) + 3}{h} = \lim_{h \rightarrow 0} \frac{-h(4+h)}{h} = -4, \text{ slope}$$

$$21. \text{ At } x = 3, y = \frac{1}{2} \Rightarrow m = \lim_{h \rightarrow 0} \frac{\frac{1}{(3+h)-1} - \frac{1}{2}}{h} = \lim_{h \rightarrow 0} \frac{2 - (2+h)}{2h(2+h)} = \lim_{h \rightarrow 0} \frac{-h}{2h(2+h)} = -\frac{1}{4}, \text{ slope}$$

$$22. \text{ At } x = 0, y = -1 \Rightarrow m = \lim_{h \rightarrow 0} \frac{\frac{h-1}{h+1} - (-1)}{h} = \lim_{h \rightarrow 0} \frac{(h-1) + (h+1)}{h(h+1)} = \lim_{h \rightarrow 0} \frac{2h}{h(h+1)} = 2, \text{ slope}$$

$$23. \text{ At a horizontal tangent the slope } m = 0 \Rightarrow 0 = m = \lim_{h \rightarrow 0} \frac{[(x+h)^2 + 4(x+h) - 1] - (x^2 + 4x - 1)}{h} \\ = \lim_{h \rightarrow 0} \frac{(x^2 + 2xh + h^2 + 4x + 4h - 1) - (x^2 + 4x - 1)}{h} = \lim_{h \rightarrow 0} \frac{(2xh + h^2 + 4h)}{h} = \lim_{h \rightarrow 0} (2x + h + 4) = 2x + 4;$$

$2x + 4 = 0 \Rightarrow x = -2$. Then $f(-2) = 4 - 8 - 1 = -5 \Rightarrow (-2, -5)$ is the point on the graph where there is a horizontal tangent.

$$24. 0 = m = \lim_{h \rightarrow 0} \frac{[(x+h)^3 - 3(x+h)] - (x^3 - 3x)}{h} = \lim_{h \rightarrow 0} \frac{(x^3 + 3x^2h + 3xh^2 + h^3 - 3x - 3h) - (x^3 - 3x)}{h} \\ = \lim_{h \rightarrow 0} \frac{3x^2h + 3xh^2 + h^3 - 3h}{h} = \lim_{h \rightarrow 0} (3x^2 + 3xh + h^2 - 3) = 3x^2 - 3; 3x^2 - 3 = 0 \Rightarrow x = -1 \text{ or } x = 1. \text{ Then} \\ f(-1) = 2 \text{ and } f(1) = -2 \Rightarrow (-1, 2) \text{ and } (1, -2) \text{ are the points on the graph where a horizontal tangent exists.}$$

$$25. -1 = m = \lim_{h \rightarrow 0} \frac{\frac{1}{(x+h)-1} - \frac{1}{x-1}}{h} = \lim_{h \rightarrow 0} \frac{(x-1) - (x+h-1)}{h(x-1)(x+h-1)} = \lim_{h \rightarrow 0} \frac{-h}{h(x-1)(x+h-1)} = -\frac{1}{(x-1)^2} \\ \Rightarrow (x-1)^2 = 1 \Rightarrow x^2 - 2x = 0 \Rightarrow x(x-2) = 0 \Rightarrow x = 0 \text{ or } x = 2. \text{ If } x = 0, \text{ then } y = -1 \text{ and } m = -1 \\ \Rightarrow y = -1 - (x-0) = -(x+1). \text{ If } x = 2, \text{ then } y = 1 \text{ and } m = -1 \Rightarrow y = 1 - (x-2) = -(x-3).$$

$$26. \frac{1}{4} = m = \lim_{h \rightarrow 0} \frac{\sqrt{x+h} - \sqrt{x}}{h} = \lim_{h \rightarrow 0} \frac{\sqrt{x+h} - \sqrt{x}}{h} \cdot \frac{\sqrt{x+h} + \sqrt{x}}{\sqrt{x+h} + \sqrt{x}} = \lim_{h \rightarrow 0} \frac{(x+h) - x}{h(\sqrt{x+h} + \sqrt{x})} \\ = \lim_{h \rightarrow 0} \frac{h}{h(\sqrt{x+h} + \sqrt{x})} = \frac{1}{2\sqrt{x}}. \text{ Thus, } \frac{1}{4} = \frac{1}{2\sqrt{x}} \Rightarrow \sqrt{x} = 2 \Rightarrow x = 4 \Rightarrow y = 2. \text{ The tangent line is} \\ y = 2 + \frac{1}{4}(x-4) = \frac{x}{4} + 1.$$

$$27. \lim_{h \rightarrow 0} \frac{f(2+h) - f(2)}{h} = \lim_{h \rightarrow 0} \frac{(100 - 4.9(2+h)^2) - (100 - 4.9(2)^2)}{h} = \lim_{h \rightarrow 0} \frac{-4.9(4 + 4h + h^2) + 4.9(4)}{h} \\ = \lim_{h \rightarrow 0} (-19.6 - 4.9h) = -19.6. \text{ The minus sign indicates the object is falling } \underline{\text{downward}} \text{ at a speed of} \\ 19.6 \text{ m/sec.}$$

$$28. \lim_{h \rightarrow 0} \frac{f(10+h) - f(10)}{h} = \lim_{h \rightarrow 0} \frac{3(10+h)^2 - 3(10)^2}{h} = \lim_{h \rightarrow 0} \frac{3(20h + h^2)}{h} = 60 \text{ ft/sec.}$$

$$29. \lim_{h \rightarrow 0} \frac{f(3+h) - f(3)}{h} = \lim_{h \rightarrow 0} \frac{\pi(3+h)^2 - \pi(3)^2}{h} = \lim_{h \rightarrow 0} \frac{\pi[9 + 6h + h^2 - 9]}{h} = \lim_{h \rightarrow 0} \pi(6+h) = 6\pi$$

$$30. \lim_{h \rightarrow 0} \frac{f(2+h) - f(2)}{h} = \lim_{h \rightarrow 0} \frac{\frac{4\pi}{3}(2+h)^3 - \frac{4\pi}{3}(2)^3}{h} = \lim_{h \rightarrow 0} \frac{\frac{4\pi}{3}[12h + 6h^2 + h^3]}{h} = \lim_{h \rightarrow 0} \frac{4\pi}{3}[12 + 6h + h^2] = 16\pi$$

$$31. \text{ Slope at origin} = \lim_{h \rightarrow 0} \frac{f(0+h) - f(0)}{h} = \lim_{h \rightarrow 0} \frac{h^2 \sin(\frac{1}{h})}{h} = \lim_{h \rightarrow 0} h \sin(\frac{1}{h}) = 0 \Rightarrow \text{yes, } f(x) \text{ does have a tangent at} \\ \text{the origin with slope } 0.$$

$$32. \lim_{h \rightarrow 0} \frac{g(0+h) - g(0)}{h} = \lim_{h \rightarrow 0} \frac{h \sin(\frac{1}{h})}{h} = \lim_{h \rightarrow 0} \sin \frac{1}{h}. \text{ Since } \lim_{h \rightarrow 0} \sin \frac{1}{h} \text{ does not exist, } f(x) \text{ has no tangent at} \\ \text{the origin.}$$

33. $\lim_{h \rightarrow 0^-} \frac{f(0+h)-f(0)}{h} = \lim_{h \rightarrow 0^-} \frac{-1-0}{h} = \infty$, and $\lim_{h \rightarrow 0^+} \frac{f(0+h)-f(0)}{h} = \lim_{h \rightarrow 0^+} \frac{1-0}{h} = \infty$. Therefore,
 $\lim_{h \rightarrow 0} \frac{f(0+h)-f(0)}{h} = \infty \Rightarrow$ yes, the graph of f has a vertical tangent at the origin.

34. $\lim_{h \rightarrow 0^-} \frac{U(0+h)-U(0)}{h} = \lim_{h \rightarrow 0^-} \frac{0-1}{h} = \infty$, and $\lim_{h \rightarrow 0^+} \frac{U(0+h)-U(0)}{h} = \lim_{h \rightarrow 0^+} \frac{1-1}{h} = 0 \Rightarrow$ no, the graph of f does not have a vertical tangent at $(0, 1)$ because the limit does not exist.

35. (a) The graph appears to have a cusp at $x = 0$.

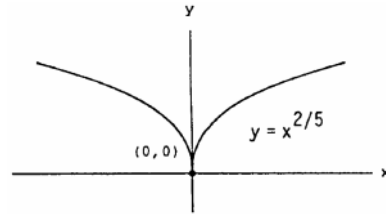

(b) $\lim_{h \rightarrow 0^-} \frac{f(0+h)-f(0)}{h} = \lim_{h \rightarrow 0^-} \frac{h^{2/5}-0}{h} = \lim_{h \rightarrow 0^-} \frac{1}{h^{3/5}} = -\infty$ and $\lim_{h \rightarrow 0^+} \frac{1}{h^{3/5}} = \infty \Rightarrow$ limit does not exist
 \Rightarrow the graph of $y = x^{2/5}$ does not have a vertical tangent at $x = 0$.

36. (a) The graph appears to have a cusp at $x = 0$.

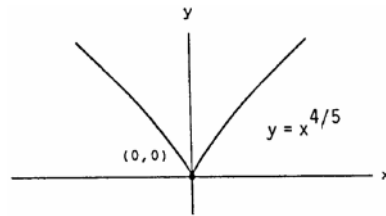

(b) $\lim_{h \rightarrow 0^-} \frac{f(0+h)-f(0)}{h} = \lim_{h \rightarrow 0^-} \frac{h^{4/5}-0}{h} = \lim_{h \rightarrow 0^-} \frac{1}{h^{1/5}} = -\infty$ and $\lim_{h \rightarrow 0^+} \frac{1}{h^{1/5}} = \infty \Rightarrow$ limit does not exist
 $\Rightarrow y = x^{4/5}$ does not have a vertical tangent at $x = 0$.

37. (a) The graph appears to have a vertical tangent at $x = 0$.

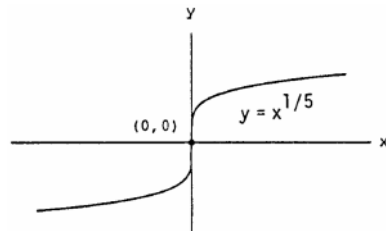

(b) $\lim_{h \rightarrow 0} \frac{f(0+h)-f(0)}{h} = \lim_{h \rightarrow 0} \frac{h^{1/5}-0}{h} = \lim_{h \rightarrow 0} \frac{1}{h^{4/5}} = \infty \Rightarrow y = x^{1/5}$ has a vertical tangent at $x = 0$.

38. (a) The graph appears to have a vertical tangent at $x = 0$.

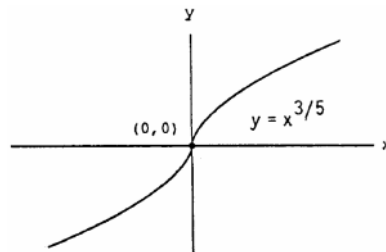

(b) $\lim_{h \rightarrow 0} \frac{f(0+h)-f(0)}{h} = \lim_{h \rightarrow 0} \frac{h^{3/5}-0}{h} = \lim_{h \rightarrow 0} \frac{1}{h^{2/5}} = \infty \Rightarrow$ the graph of $y = x^{3/5}$ has a vertical tangent at $x = 0$.

39. (a) The graph appears to have a cusp at $x = 0$.

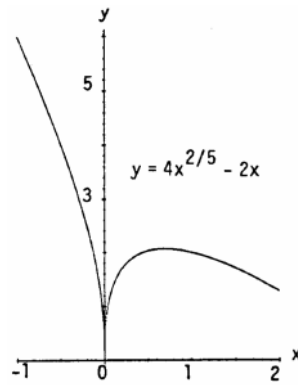

(b) $\lim_{h \rightarrow 0^-} \frac{f(0+h) - f(0)}{h} = \lim_{h \rightarrow 0^-} \frac{4h^{2/5} - 2h}{h} = \lim_{h \rightarrow 0^-} \frac{4}{h^{3/5}} - 2 = -\infty$ and $\lim_{h \rightarrow 0^+} \frac{4}{h^{3/5}} - 2 = \infty$
 \Rightarrow limit does not exist \Rightarrow the graph of $y = 4x^{2/5} - 2x$ does not have a vertical tangent at $x = 0$.

40. (a) The graph appears to have a cusp at $x = 0$.

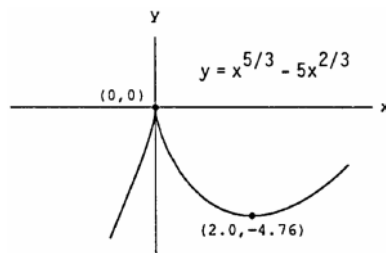

(b) $\lim_{h \rightarrow 0} \frac{f(0+h) - f(0)}{h} = \lim_{h \rightarrow 0} \frac{h^{5/3} - 5h^{2/3}}{h} = \lim_{h \rightarrow 0} h^{2/3} - \frac{5}{h^{1/3}} = 0 - \lim_{h \rightarrow 0} \frac{5}{h^{1/3}}$ does not exist \Rightarrow the graph of $y = x^{5/3} - 5x^{2/3}$ does not have a vertical tangent at $x = 0$.

41. (a) The graph appears to have a vertical tangent at $x = 1$ and a cusp at $x = 0$.

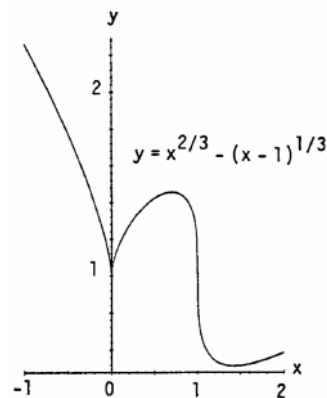

(b) $x = 1$: $\lim_{h \rightarrow 0} \frac{(1+h)^{2/3} - (1+h-1)^{1/3} - 1}{h} = \lim_{h \rightarrow 0} \frac{(1+h)^{2/3} - h^{1/3} - 1}{h} = -\infty$
 $\Rightarrow y = x^{2/3} - (x-1)^{1/3}$ has a vertical tangent at $x = 1$;
 $x = 0$: $\lim_{h \rightarrow 0} \frac{f(0+h) - f(0)}{h} = \lim_{h \rightarrow 0} \frac{h^{2/3} - (h-1)^{1/3} - (-1)^{1/3}}{h} = \lim_{h \rightarrow 0} \left[\frac{1}{h^{1/3}} - \frac{(h-1)^{1/3}}{h} + \frac{1}{h} \right]$
 does not exist $\Rightarrow y = x^{2/3} - (x-1)^{1/3}$ does not have a vertical tangent at $x = 0$.

42. (a) The graph appears to have vertical tangents at $x = 0$ and $x = 1$.

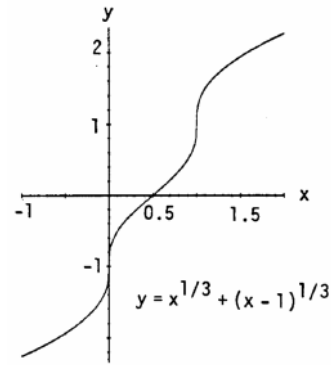

- (b) $x = 0$: $\lim_{h \rightarrow 0} \frac{f(0+h) - f(0)}{h} = \lim_{h \rightarrow 0} \frac{h^{1/3} + (h-1)^{1/3} - (-1)^{1/3}}{h} = \infty \Rightarrow y = x^{1/3} + (x-1)^{1/3}$ has a vertical tangent at $x = 0$;
 $x = 1$: $\lim_{h \rightarrow 0} \frac{f(1+h) - f(1)}{h} = \lim_{h \rightarrow 0} \frac{(1+h)^{1/3} + (1+h-1)^{1/3} - 1}{h} = \infty \Rightarrow y = x^{1/3} + (x-1)^{1/3}$ has a vertical tangent at $x = 1$.

43. (a) The graph appears to have a vertical tangent at $x = 0$.

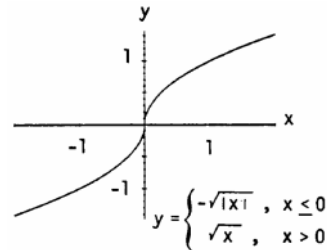

- (b) $\lim_{h \rightarrow 0^+} \frac{f(0+h) - f(0)}{h} = \lim_{x \rightarrow 0^+} \frac{\sqrt{h} - 0}{h} = \lim_{h \rightarrow 0^+} \frac{1}{\sqrt{h}} = \infty$;
 $\lim_{h \rightarrow 0^-} \frac{f(0+h) - f(0)}{h} = \lim_{h \rightarrow 0^-} \frac{-\sqrt{|h|} - 0}{h} = \lim_{h \rightarrow 0^-} \frac{-\sqrt{|h|}}{-|h|} = \lim_{h \rightarrow 0^-} \frac{1}{\sqrt{|h|}} = \infty$
 $\Rightarrow y$ has a vertical tangent at $x = 0$.

44. (a) The graph appears to have a cusp at $x = 4$.

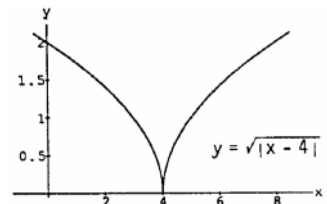

- (b) $\lim_{h \rightarrow 0^+} \frac{f(4+h) - f(4)}{h} = \lim_{h \rightarrow 0^+} \frac{\sqrt{4 - (4+h)} - 0}{h} = \lim_{h \rightarrow 0^+} \frac{\sqrt{|h|}}{h} = \lim_{h \rightarrow 0^+} \frac{1}{\sqrt{h}} = \infty$;
 $\lim_{h \rightarrow 0^-} \frac{f(4+h) - f(4)}{h} = \lim_{h \rightarrow 0^-} \frac{\sqrt{4 - (4+h)}}{h} = \lim_{h \rightarrow 0^-} \frac{\sqrt{|h|}}{-|h|} = \lim_{h \rightarrow 0^-} \frac{-1}{\sqrt{|h|}} = -\infty$
 $\Rightarrow y = \sqrt{4 - x}$ does not have a vertical tangent at $x = 4$.

45-48. Example CAS commands:

Maple:

```
f := x -> x^3 + 2*x; x0 := 0;
plot( f(x), x=x0-1/2..x0+3, color=black,          # part (a)
      title="Section 2.7, #45(a)" );
q := unapply( (f(x0+h)-f(x0))/h, h );              # part (b)
L := limit( q(h), h=0 );                           # part (c)
sec_lines := seq( f(x0)+q(h)*(x-x0), h=1..3 );     # part (d)
tan_line := f(x0) + L*(x-x0);
plot( [f(x),tan_line,sec_lines], x=x0-1/2..x0+3, color=black,
```

```
linestyle={1,2,5,6,7}, title="Section 2.7, #45(d)",
legend={"y=f(x)", "Tangent line at x=0", "Secant line (h=1)",
"Secant line (h=2)", "Secant line (h=3)"}];
```

Mathematica: (function and value for x0 may change)

```
Clear[f, m, x, h]
x0 = p;
f[x_] := Cos[x] + 4Sin[2x]
Plot[f[x], {x, x0 - 1, x0 + 3}]
dq[h_] := (f[x0+h] - f[x0])/h
m = Limit[dq[h], h -> 0]
ytan := f[x0] + m(x - x0)
y1 := f[x0] + dq[1](x - x0)
y2 := f[x0] + dq[2](x - x0)
y3 := f[x0] + dq[3](x - x0)
Plot[{f[x], ytan, y1, y2, y3}, {x, x0 - 1, x0 + 3}]
```

CHAPTER 2 PRACTICE EXERCISES

1. At $x = -1$: $\lim_{x \rightarrow -1^-} f(x) = \lim_{x \rightarrow -1^+} f(x) = 1$
 $\Rightarrow \lim_{x \rightarrow -1} f(x) = 1 = f(-1)$
 $\Rightarrow f$ is continuous at $x = -1$.

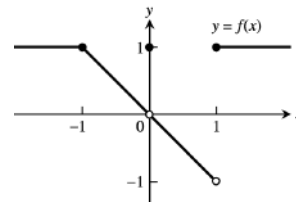

- At $x = 0$: $\lim_{x \rightarrow 0^-} f(x) = \lim_{x \rightarrow 0^+} f(x) = 0 \Rightarrow \lim_{x \rightarrow 0} f(x) = 0$.
 But $f(0) = 1 \neq \lim_{x \rightarrow 0} f(x)$
 $\Rightarrow f$ is discontinuous at $x = 0$.
 If we define $f(0) = 0$, then the discontinuity at $x = 0$ is removable.

- At $x = 1$: $\lim_{x \rightarrow 1^-} f(x) = -1$ and $\lim_{x \rightarrow 1^+} f(x) = 1$
 $\Rightarrow \lim_{x \rightarrow 1} f(x)$ does not exist
 $\Rightarrow f$ is discontinuous at $x = 1$.

2. At $x = -1$: $\lim_{x \rightarrow -1^-} f(x) = 0$ and $\lim_{x \rightarrow -1^+} f(x) = -1$
 $\Rightarrow \lim_{x \rightarrow -1} f(x)$ does not exist
 $\Rightarrow f$ is discontinuous at $x = -1$.

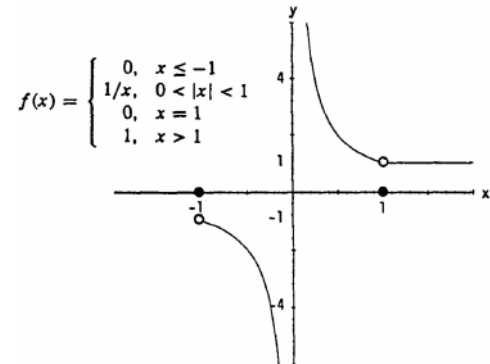

- At $x = 0$: $\lim_{x \rightarrow 0^-} f(x) = -\infty$ and $\lim_{x \rightarrow 0^+} f(x) = \infty$
 $\Rightarrow \lim_{x \rightarrow 0} f(x)$ does not exist
 $\Rightarrow f$ is discontinuous at $x = 0$.
- At $x = 1$: $\lim_{x \rightarrow 1^-} f(x) = \lim_{x \rightarrow 1^+} f(x) = 1 \Rightarrow \lim_{x \rightarrow 1} f(x) = 1$.
 But $f(1) = 0 \neq \lim_{x \rightarrow 1} f(x)$
 $\Rightarrow f$ is discontinuous at $x = 1$.
 If we define $f(1) = 1$, then the discontinuity at $x = 1$ is removable.

3. (a) $\lim_{t \rightarrow t_0} (3f(t)) = 3 \lim_{t \rightarrow t_0} f(t) = 3(-7) = -21$
 (b) $\lim_{t \rightarrow t_0} (f(t))^2 = \left(\lim_{t \rightarrow t_0} f(t) \right)^2 = (-7)^2 = 49$

$$(c) \lim_{t \rightarrow t_0} (f(t) \cdot g(t)) = \lim_{t \rightarrow t_0} f(t) \cdot \lim_{t \rightarrow t_0} g(t) = (-7)(0) = 0$$

$$(d) \lim_{t \rightarrow t_0} \frac{f(t)}{g(t)-7} = \frac{\lim_{t \rightarrow t_0} f(t)}{\lim_{t \rightarrow t_0} (g(t)-7)} = \frac{\lim_{t \rightarrow t_0} f(t)}{\lim_{t \rightarrow t_0} g(t) - \lim_{t \rightarrow t_0} 7} = \frac{-7}{0-7} = 1$$

$$(e) \lim_{t \rightarrow t_0} \cos(g(t)) = \cos\left(\lim_{t \rightarrow t_0} g(t)\right) = \cos 0 = 1$$

$$(f) \lim_{t \rightarrow t_0} |f(t)| = \left| \lim_{t \rightarrow t_0} f(t) \right| = |-7| = 7$$

$$(g) \lim_{t \rightarrow t_0} (f(t) + g(t)) = \lim_{t \rightarrow t_0} f(t) + \lim_{t \rightarrow t_0} g(t) = -7 + 0 = -7$$

$$(h) \lim_{t \rightarrow t_0} \left(\frac{1}{f(t)}\right) = \frac{1}{\lim_{t \rightarrow t_0} f(t)} = \frac{1}{-7} = -\frac{1}{7}$$

$$4. (a) \lim_{x \rightarrow 0} -g(x) = -\lim_{x \rightarrow 0} g(x) = -\sqrt{2}$$

$$(b) \lim_{x \rightarrow 0} (g(x) \cdot f(x)) = \lim_{x \rightarrow 0} g(x) \cdot \lim_{x \rightarrow 0} f(x) = (\sqrt{2})\left(\frac{1}{2}\right) = \frac{\sqrt{2}}{2}$$

$$(c) \lim_{x \rightarrow 0} (f(x) + g(x)) = \lim_{x \rightarrow 0} f(x) + \lim_{x \rightarrow 0} g(x) = \frac{1}{2} + \sqrt{2}$$

$$(d) \lim_{x \rightarrow 0} \frac{1}{f(x)} = \frac{1}{\lim_{x \rightarrow 0} f(x)} = \frac{1}{\frac{1}{2}} = 2$$

$$(e) \lim_{x \rightarrow 0} (x + f(x)) = \lim_{x \rightarrow 0} x + \lim_{x \rightarrow 0} f(x) = 0 + \frac{1}{2} = \frac{1}{2}$$

$$(f) \lim_{x \rightarrow 0} \frac{f(x) \cdot \cos x}{x-1} = \frac{\lim_{x \rightarrow 0} f(x) \cdot \lim_{x \rightarrow 0} \cos x}{\lim_{x \rightarrow 0} x - \lim_{x \rightarrow 0} 1} = \frac{\left(\frac{1}{2}\right)(1)}{0-1} = -\frac{1}{2}$$

5. Since $\lim_{x \rightarrow 0} x = 0$ we must have that $\lim_{x \rightarrow 0} (4 - g(x)) = 0$. Otherwise, if $\lim_{x \rightarrow 0} (4 - g(x))$ is a finite positive number, we would have $\lim_{x \rightarrow 0^-} \left[\frac{4-g(x)}{x}\right] = -\infty$ and $\lim_{x \rightarrow 0^+} \left[\frac{4-g(x)}{x}\right] = \infty$ so the limit could not equal 1 as $x \rightarrow 0$. Similar reasoning holds if $\lim_{x \rightarrow 0} (4 - g(x))$ is a finite negative number. We conclude that $\lim_{x \rightarrow 0} g(x) = 4$.

$$6. 2 = \lim_{x \rightarrow -4} \left[x \lim_{x \rightarrow 0} g(x)\right] = \lim_{x \rightarrow -4} x \cdot \lim_{x \rightarrow -4} \left[\lim_{x \rightarrow 0} g(x)\right] = -4 \lim_{x \rightarrow -4} \left[\lim_{x \rightarrow 0} g(x)\right] = -4 \lim_{x \rightarrow 0} g(x)$$

(since $\lim_{x \rightarrow 0} g(x)$ is a constant) $\Rightarrow \lim_{x \rightarrow 0} g(x) = \frac{2}{-4} = -\frac{1}{2}$.

$$7. (a) \lim_{x \rightarrow c} f(x) = \lim_{x \rightarrow c} x^{1/3} = c^{1/3} = f(c) \text{ for every real number } c \Rightarrow f \text{ is continuous on } (-\infty, \infty).$$

$$(b) \lim_{x \rightarrow c} g(x) = \lim_{x \rightarrow c} x^{3/4} = c^{3/4} = g(c) \text{ for every nonnegative real number } c \Rightarrow g \text{ is continuous on } [0, \infty).$$

$$(c) \lim_{x \rightarrow c} h(x) = \lim_{x \rightarrow c} x^{-2/3} = \frac{1}{c^{2/3}} = h(c) \text{ for every nonzero real number } c \Rightarrow h \text{ is continuous on } (-\infty, 0) \text{ and } (0, \infty).$$

$$(d) \lim_{x \rightarrow c} k(x) = \lim_{x \rightarrow c} x^{-1/6} = \frac{1}{c^{1/6}} = k(c) \text{ for every positive real number } c \Rightarrow k \text{ is continuous on } (0, \infty)$$

$$8. (a) \bigcup_{n \in I} \left((n - \frac{1}{2})\pi, (n + \frac{1}{2})\pi\right), \text{ where } I = \text{the set of all integers.}$$

$$(b) \bigcup_{n \in I} (n\pi, (n+1)\pi), \text{ where } I = \text{the set of all integers.}$$

$$(c) (-\infty, \pi) \cup (\pi, \infty)$$

$$(d) (-\infty, 0) \cup (0, \infty)$$

$$9. (a) \lim_{x \rightarrow 0} \frac{x^2 - 4x + 4}{x^3 + 5x^2 - 14x} = \lim_{x \rightarrow 0} \frac{(x-2)(x-2)}{x(x+7)(x-2)} = \lim_{x \rightarrow 0} \frac{x-2}{x(x+7)}, x \neq 2; \text{ the limit does not exist because}$$

$$\lim_{x \rightarrow 0^-} \frac{x-2}{x(x+7)} = \infty \text{ and } \lim_{x \rightarrow 0^+} \frac{x-2}{x(x+7)} = -\infty$$

$$(b) \lim_{x \rightarrow 2} \frac{x^2 - 4x + 4}{x^3 + 5x^2 - 14x} = \lim_{x \rightarrow 2} \frac{(x-2)(x-2)}{x(x+7)(x-2)} = \lim_{x \rightarrow 2} \frac{x-2}{x(x+7)}, x \neq 2, \text{ and } \lim_{x \rightarrow 2} \frac{x-2}{x(x+7)} = \frac{0}{2(9)} = 0$$

$$10. (a) \lim_{x \rightarrow 0} \frac{x^2 + x}{x^3 + 2x^4 + x^3} = \lim_{x \rightarrow 0} \frac{x(x+1)}{x^3(x^2 + 2x + 1)} = \lim_{x \rightarrow 0} \frac{x+1}{x^2(x+1)(x+1)} = \lim_{x \rightarrow 0} \frac{1}{x^2(x+1)}, x \neq 0 \text{ and } x \neq -1.$$

$$\text{Now } \lim_{x \rightarrow 0^-} \frac{1}{x^2(x+1)} = \infty \text{ and } \lim_{x \rightarrow 0^+} \frac{1}{x^2(x+1)} = \infty \Rightarrow \lim_{x \rightarrow 0} \frac{x^2 + x}{x^3 + 2x^4 + x^3} = \infty.$$

112 Chapter 2 Limits and Continuity

(b) $\lim_{x \rightarrow -1} \frac{x^2 + x}{x^5 + 2x^4 + x^3} = \lim_{x \rightarrow -1} \frac{x(x+1)}{x^3(x^2 + 2x + 1)} = \lim_{x \rightarrow -1} \frac{1}{x^2(x+1)}$, $x \neq 0$ and $x \neq -1$. The limit does not exist because $\lim_{x \rightarrow -1^-} \frac{1}{x^2(x+1)} = -\infty$ and $\lim_{x \rightarrow -1^+} \frac{1}{x^2(x+1)} = \infty$.

$$11. \lim_{x \rightarrow 1} \frac{1 - \sqrt{x}}{1 - x} = \lim_{x \rightarrow 1} \frac{1 - \sqrt{x}}{(1 - \sqrt{x})(1 + \sqrt{x})} = \lim_{x \rightarrow 1} \frac{1}{1 + \sqrt{x}} = \frac{1}{2}$$

$$12. \lim_{x \rightarrow a} \frac{x^2 - a^2}{x^4 - a^4} = \lim_{x \rightarrow a} \frac{(x^2 - a^2)}{(x^2 + a^2)(x^2 - a^2)} = \lim_{x \rightarrow a} \frac{1}{x^2 + a^2} = \frac{1}{2a^2}$$

$$13. \lim_{h \rightarrow 0} \frac{(x+h)^2 - x^2}{h} = \lim_{h \rightarrow 0} \frac{(x^2 + 2hx + h^2) - x^2}{h} = \lim_{h \rightarrow 0} (2x + h) = 2x$$

$$14. \lim_{x \rightarrow 0} \frac{(x+h)^2 - x^2}{h} = \lim_{x \rightarrow 0} \frac{(x^2 + 2hx + h^2) - x^2}{h} = \lim_{x \rightarrow 0} (2x + h) = h$$

$$15. \lim_{x \rightarrow 0} \frac{\frac{1}{2+x} - \frac{1}{2}}{x} = \lim_{x \rightarrow 0} \frac{2 - (2+x)}{2x(2+x)} = \lim_{x \rightarrow 0} \frac{-1}{4+2x} = -\frac{1}{4}$$

$$16. \lim_{x \rightarrow 0} \frac{(2+x)^3 - 8}{x} = \lim_{x \rightarrow 0} \frac{(x^3 + 6x^2 + 12x + 8) - 8}{x} = \lim_{x \rightarrow 0} (x^2 + 6x + 12) = 12$$

$$17. \lim_{x \rightarrow 0^+} [4g(x)]^{1/3} = 2 \Rightarrow \left[\lim_{x \rightarrow 0^+} 4g(x) \right]^{1/3} = 2 \Rightarrow \lim_{x \rightarrow 0^+} 4g(x) = 8, \text{ since } 2^3 = 8. \text{ Then } \lim_{x \rightarrow 0^+} g(x) = 2.$$

$$18. \lim_{x \rightarrow \sqrt{5}} \frac{1}{x + g(x)} = 2 \Rightarrow \lim_{x \rightarrow \sqrt{5}} (x + g(x)) = \frac{1}{2} \Rightarrow \sqrt{5} + \lim_{x \rightarrow \sqrt{5}} g(x) = \frac{1}{2} \Rightarrow \lim_{x \rightarrow \sqrt{5}} g(x) = \frac{1}{2} - \sqrt{5}$$

$$19. \lim_{x \rightarrow 1} \frac{3x^2 + 1}{g(x)} = \infty \Rightarrow \lim_{x \rightarrow 1} g(x) = 0 \text{ since } \lim_{x \rightarrow 1} (3x^2 + 1) = 4$$

$$20. \lim_{x \rightarrow -2} \frac{5 - x^2}{\sqrt{g(x)}} = 0 \Rightarrow \lim_{x \rightarrow -2} g(x) = \infty \text{ since } \lim_{x \rightarrow -2} (5 - x^2) = 1$$

$$21. \lim_{x \rightarrow \infty} \frac{2x+3}{5x+7} = \lim_{x \rightarrow \infty} \frac{2 + \frac{3}{x}}{5 + \frac{7}{x}} = \frac{2+0}{5+0} = \frac{2}{5}$$

$$22. \lim_{x \rightarrow -\infty} \frac{2x^2+3}{5x^2+7} = \lim_{x \rightarrow -\infty} \frac{2 + \frac{3}{x^2}}{5 + \frac{7}{x^2}} = \frac{2+0}{5+0} = \frac{2}{5}$$

$$23. \lim_{x \rightarrow -\infty} \frac{x^2 - 4x + 8}{3x^3} = \lim_{x \rightarrow -\infty} \left(\frac{1}{3x} - \frac{4}{3x^2} + \frac{8}{3x^3} \right) = 0 - 0 + 0 = 0$$

$$24. \lim_{x \rightarrow \infty} \frac{1}{x^2 - 7x + 1} = \lim_{x \rightarrow \infty} \frac{\frac{1}{x^2}}{1 - \frac{7}{x} + \frac{1}{x^2}} = \frac{0}{1-0+0} = 0$$

$$25. \lim_{x \rightarrow -\infty} \frac{x^2 - 7x}{x+1} = \lim_{x \rightarrow -\infty} \frac{x-7}{1 + \frac{1}{x}} = -\infty$$

$$26. \lim_{x \rightarrow \infty} \frac{x^4 + x^3}{12x^3 + 128} = \lim_{x \rightarrow \infty} \frac{x+1}{12 + \frac{128}{x^3}} = \infty$$

$$27. \lim_{x \rightarrow \infty} \frac{|\sin x|}{|x|} \leq \lim_{x \rightarrow \infty} \frac{1}{|x|} = 0 \text{ since } \text{int } x \rightarrow \infty \text{ as } x \rightarrow \infty \Rightarrow \lim_{x \rightarrow \infty} \frac{|\sin x|}{|x|} = 0.$$

$$28. \lim_{\theta \rightarrow \infty} \frac{|\cos \theta - 1|}{\theta} \leq \lim_{\theta \rightarrow \infty} \frac{|-2|}{\theta} = 0 \Rightarrow \lim_{\theta \rightarrow \infty} \frac{|\cos \theta - 1|}{\theta} = 0.$$

$$29. \lim_{x \rightarrow \infty} \frac{x + \sin x + 2\sqrt{x}}{x + \sin x} = \lim_{x \rightarrow \infty} \frac{1 + \frac{\sin x}{x} + \frac{2}{\sqrt{x}}}{1 + \frac{\sin x}{x}} = \frac{1+0+0}{1+0} = 1$$

$$30. \lim_{x \rightarrow \infty} \frac{x^{2/3} + x^{-1}}{x^{2/3} + \cos^2 x} = \lim_{x \rightarrow \infty} \left(\frac{1 + x^{-5/3}}{1 + \frac{\cos^2 x}{x^{2/3}}} \right) = \frac{1+0}{1+0} = 1$$

31. At $x = -1$: $\lim_{x \rightarrow -1^-} f(x) = \lim_{x \rightarrow -1^-} \frac{x(x^2-1)}{|x^2-1|}$
 $= \lim_{x \rightarrow -1^-} \frac{x(x^2-1)}{x^2-1} = \lim_{x \rightarrow -1^-} x = -1$, and
 $\lim_{x \rightarrow -1^+} f(x) = \lim_{x \rightarrow -1^+} \frac{x(x^2-1)}{|x^2-1|} = \lim_{x \rightarrow -1^+} \frac{x(x^2-1)}{-(x^2-1)}$
 $= \lim_{x \rightarrow -1^+} (-x) = -(-1) = 1$. Since
 $\lim_{x \rightarrow -1^-} f(x) \neq \lim_{x \rightarrow -1^+} f(x)$
 $\Rightarrow \lim_{x \rightarrow -1} f(x)$ does not exist, the function f cannot be
 extended to a continuous function at $x = -1$.

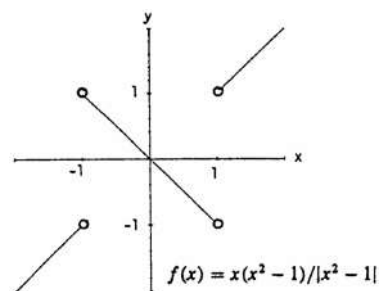

- At $x = 1$: $\lim_{x \rightarrow 1^-} f(x) = \lim_{x \rightarrow 1^-} \frac{x(x^2-1)}{|x^2-1|} = \lim_{x \rightarrow 1^-} \frac{x(x^2-1)}{-(x^2-1)} = \lim_{x \rightarrow 1^-} (-x) = -1$, and

$$\lim_{x \rightarrow 1^+} f(x) = \lim_{x \rightarrow 1^+} \frac{x(x^2-1)}{|x^2-1|} = \lim_{x \rightarrow 1^+} \frac{x(x^2-1)}{x^2-1} = \lim_{x \rightarrow 1^+} x = 1. \text{ Again } \lim_{x \rightarrow 1} f(x) \text{ does not exist so } f$$

cannot be extended to a continuous function at $x = 1$ either.

32. The discontinuity at $x = 0$ of $f(x) = \sin\left(\frac{1}{x}\right)$ is nonremovable because $\lim_{x \rightarrow 0} \sin\frac{1}{x}$ does not exist.

33. Yes, f does have a continuous extension to $a = 1$:

$$\text{define } f(1) = \lim_{x \rightarrow 1} \frac{x-1}{x-\sqrt{x}} = \frac{4}{3}.$$

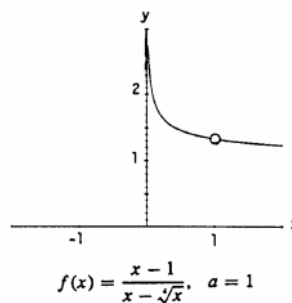

34. Yes, g does have a continuous extension to $a = \frac{\pi}{2}$:

$$g\left(\frac{\pi}{2}\right) = \lim_{\theta \rightarrow \frac{\pi}{2}} \frac{5 \cos \theta}{4\theta - 2\pi} = -\frac{5}{4}.$$

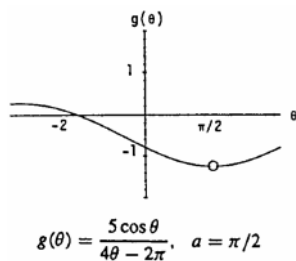

35. From the graph we see that $\lim_{t \rightarrow 0^-} h(t) \neq \lim_{t \rightarrow 0^+} h(t)$
 so h cannot be extended to a continuous function
 at $a = 0$.

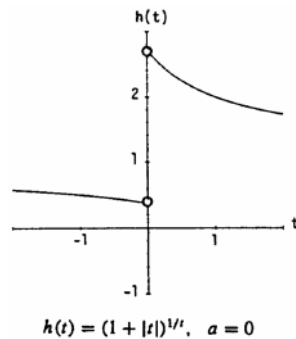

36. From the graph we see that $\lim_{x \rightarrow 0^-} k(x) \neq \lim_{x \rightarrow 0^+} k(x)$
 so k cannot be extended to a continuous function
 at $a = 0$.

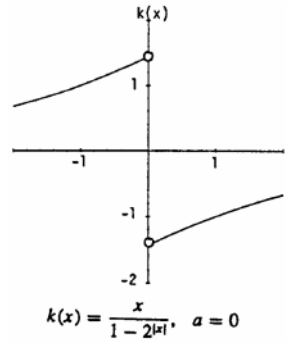

37. (a) $f(-1) = -1$ and $f(2) = 5 \Rightarrow f$ has a root between -1 and 2 by the Intermediate Value Theorem.
 (b), (c) root is 1.32471795724
38. (a) $f(-2) = -2$ and $f(0) = 2 \Rightarrow f$ has a root between -2 and 0 by the Intermediate Value Theorem.
 (b), (c) root is -1.76929235424

CHAPTER 2 ADDITIONAL AND ADVANCED EXERCISES

1. (a)

x	0.1	0.01	0.001	0.0001	0.00001
x^x	0.7943	0.9550	0.9931	0.9991	0.9999

Apparently, $\lim_{x \rightarrow 0^+} x^x = 1$

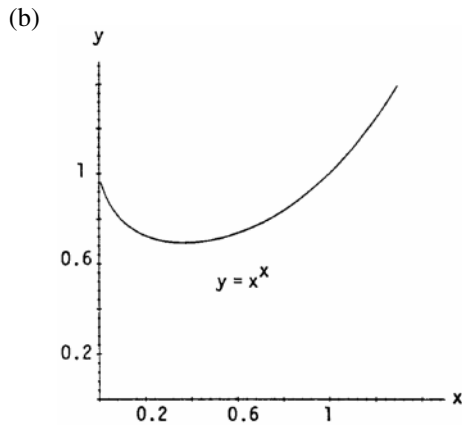

2. (a)

x	10	100	1000
$(\frac{1}{x})^{1/(\ln x)}$	0.3679	0.3679	0.3679

Apparently, $\lim_{x \rightarrow \infty} (\frac{1}{x})^{1/(\ln x)} = 0.3678 = \frac{1}{e}$

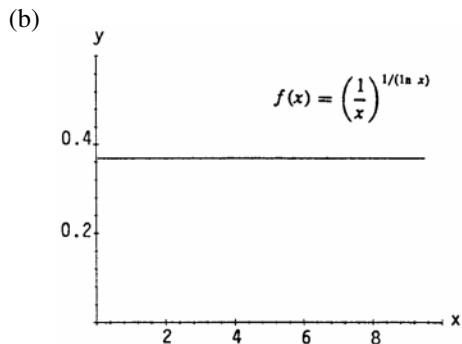

$$3. \lim_{v \rightarrow c^-} L = \lim_{v \rightarrow c^-} L_0 \sqrt{1 - \frac{v^2}{c^2}} = L_0 \sqrt{1 - \frac{\lim_{v \rightarrow c^-} v^2}{c^2}} = L_0 \sqrt{1 - \frac{c^2}{c^2}} = 0$$

The left-hand limit was needed because the function L is undefined if $v > c$ (the rocket cannot move faster than the speed of light).

$$4. \left| \frac{\sqrt{x}}{2} - 1 \right| < 0.2 \Rightarrow -0.2 < \frac{\sqrt{x}}{2} - 1 < 0.2 \Rightarrow 0.8 < \frac{\sqrt{x}}{2} < 1.2 \Rightarrow 1.6 < \sqrt{x} < 2.4 \Rightarrow 2.56 < x < 5.76.$$

$$\left| \frac{\sqrt{x}}{2} - 1 \right| < 0.1 \Rightarrow -0.1 < \frac{\sqrt{x}}{2} - 1 < 0.1 \Rightarrow 0.9 < \frac{\sqrt{x}}{2} < 1.1 \Rightarrow 1.8 < \sqrt{x} < 2.2 \Rightarrow 3.24 < x < 4.84.$$

$$5. |10 + (t - 70) \times 10^{-4} - 10| < 0.0005 \Rightarrow |(t - 70) \times 10^{-4}| < 0.0005 \Rightarrow -0.0005 < (t - 70) \times 10^{-4} < 0.0005$$

$$\Rightarrow -5 < t - 70 < 5 \Rightarrow 65^\circ < t < 75^\circ \Rightarrow \text{Within } 5^\circ \text{ F.}$$

6. We want to know in what interval to hold values of h to make V satisfy the inequality

$|V - 1000| = |36\pi h - 1000| \leq 10$. To find out, we solve the inequality:

$$|36\pi h - 1000| \leq 10 \Rightarrow -10 \leq 36\pi h - 1000 \leq 10 \Rightarrow 990 \leq 36\pi h \leq 1010 \Rightarrow \frac{990}{36\pi} \leq h \leq \frac{1010}{36\pi}$$

$$\Rightarrow 8.8 \leq h \leq 8.9. \text{ where } 8.8 \text{ was rounded up, to be safe, and } 8.9 \text{ was rounded down, to be safe.}$$

The interval in which we should hold h is about $8.9 - 8.8 = 0.1$ cm wide (1 mm). With stripes 1 mm wide, we can expect to measure a liter of water with an accuracy of 1%, which is more than enough accuracy for cooking.

$$7. \text{ Show } \lim_{x \rightarrow 1} f(x) = \lim_{x \rightarrow 1} (x^2 - 7) = -6 = f(1).$$

$$\text{Step 1: } |(x^2 - 7) + 6| < \epsilon \Rightarrow -\epsilon < x^2 - 1 < \epsilon \Rightarrow 1 - \epsilon < x^2 < 1 + \epsilon \Rightarrow \sqrt{1 - \epsilon} < x < \sqrt{1 + \epsilon}.$$

$$\text{Step 2: } |x - 1| < \delta \Rightarrow -\delta < x - 1 < \delta \Rightarrow -\delta + 1 < x < \delta + 1.$$

Then $-\delta + 1 = \sqrt{1 - \epsilon}$ or $\delta + 1 = \sqrt{1 + \epsilon}$. Choose $\delta = \min \left\{ 1 - \sqrt{1 - \epsilon}, \sqrt{1 + \epsilon} - 1 \right\}$, then

$0 < |x - 1| < \delta \Rightarrow |(x^2 - 7) - 6| < \epsilon$ and $\lim_{x \rightarrow 1} f(x) = -6$. By the continuity test, $f(x)$ is continuous at $x = 1$.

$$8. \text{ Show } \lim_{x \rightarrow \frac{1}{4}} g(x) = \lim_{x \rightarrow \frac{1}{4}} \frac{1}{2x} = 2 = g\left(\frac{1}{4}\right).$$

$$\text{Step 1: } \left| \frac{1}{2x} - 2 \right| < \epsilon \Rightarrow -\epsilon < \frac{1}{2x} - 2 < \epsilon \Rightarrow 2 - \epsilon < \frac{1}{2x} < 2 + \epsilon \Rightarrow \frac{1}{4 - 2\epsilon} > x > \frac{1}{4 + 2\epsilon}.$$

$$\text{Step 2: } \left| x - \frac{1}{4} \right| < \delta \Rightarrow -\delta < x - \frac{1}{4} < \delta \Rightarrow -\delta + \frac{1}{4} < x < \delta + \frac{1}{4}.$$

$$\text{Then } -\delta + \frac{1}{4} = \frac{1}{4 + 2\epsilon} \Rightarrow \delta = \frac{1}{4} - \frac{1}{4 + 2\epsilon} = \frac{\epsilon}{4(2 + \epsilon)}, \text{ or } \delta + \frac{1}{4} = \frac{1}{4 - 2\epsilon} \Rightarrow \delta = \frac{1}{4 - 2\epsilon} - \frac{1}{4} = \frac{\epsilon}{4(2 - \epsilon)}.$$

Choose $\delta = \frac{\epsilon}{4(2 + \epsilon)}$, the smaller of the two values. Then $0 < \left| x - \frac{1}{4} \right| < \delta \Rightarrow \left| \frac{1}{2x} - 2 \right| < \epsilon$ and $\lim_{x \rightarrow \frac{1}{4}} \frac{1}{2x} = 2$.

By the continuity test, $g(x)$ is continuous at $x = \frac{1}{4}$.

$$9. \text{ Show } \lim_{x \rightarrow 2} h(x) = \lim_{x \rightarrow 2} \sqrt{2x - 3} = 1 = h(2).$$

$$\text{Step 1: } \left| \sqrt{2x - 3} - 1 \right| < \epsilon \Rightarrow -\epsilon < \sqrt{2x - 3} - 1 < \epsilon \Rightarrow 1 - \epsilon < \sqrt{2x - 3} < 1 + \epsilon \Rightarrow \frac{(1 - \epsilon)^2 + 3}{2} < x < \frac{(1 + \epsilon)^2 + 3}{2}.$$

$$\text{Step 2: } |x - 2| < \delta \Rightarrow -\delta < x - 2 < \delta \text{ or } -\delta + 2 < x < \delta + 2.$$

$$\text{Then } -\delta + 2 = \frac{(1 - \epsilon)^2 + 3}{2} \Rightarrow \delta = 2 - \frac{(1 - \epsilon)^2 + 3}{2} = \frac{1 - (1 - \epsilon)^2}{2} = \epsilon - \frac{\epsilon^2}{2}, \text{ or } \delta + 2 = \frac{(1 + \epsilon)^2 + 3}{2}$$

$$\Rightarrow \delta = \frac{(1 + \epsilon)^2 + 3}{2} - 2 = \frac{(1 + \epsilon)^2 - 1}{2} = \epsilon + \frac{\epsilon^2}{2}. \text{ Choose } \delta = \epsilon - \frac{\epsilon^2}{2}, \text{ the smaller of the two values. Then,}$$

$0 < |x - 2| < \delta \Rightarrow \left| \sqrt{2x - 3} - 1 \right| < \epsilon$, so $\lim_{x \rightarrow 2} \sqrt{2x - 3} = 1$. By the continuity test, $h(x)$ is continuous at $x = 2$.

$$10. \text{ Show } \lim_{x \rightarrow 5} F(x) = \lim_{x \rightarrow 5} \sqrt{9 - x} = 2 = F(5).$$

$$\text{Step 1: } \left| \sqrt{9 - x} - 2 \right| < \epsilon \Rightarrow -\epsilon < \sqrt{9 - x} - 2 < \epsilon \Rightarrow 9 - (2 - \epsilon)^2 > x > 9 - (2 + \epsilon)^2.$$

$$\text{Step 2: } 0 < |x - 5| < \delta \Rightarrow -\delta < x - 5 < \delta \Rightarrow -\delta + 5 < x < \delta + 5.$$

$$\text{Then } -\delta + 5 = 9 - (2 + \epsilon)^2 \Rightarrow \delta = (2 + \epsilon)^2 - 4 = \epsilon^2 + 2\epsilon, \text{ or } \delta + 5 = 9 - (2 - \epsilon)^2 \Rightarrow \delta = 4 - (2 - \epsilon)^2 = \epsilon^2 - 2\epsilon.$$

Choose $\delta = \epsilon^2 - 2\epsilon$, the smaller of the two values. Then, $0 < |x - 5| < \delta \Rightarrow \left| \sqrt{9 - x} - 2 \right| < \epsilon$, so

$\lim_{x \rightarrow 5} \sqrt{9 - x} = 2$. By the continuity test, $F(x)$ is continuous at $x = 5$.

11. Suppose L_1 and L_2 are two different limits. Without loss of generality assume $L_2 > L_1$. Let $\epsilon = \frac{1}{3}(L_2 - L_1)$. Since $\lim_{x \rightarrow x_0} f(x) = L_1$ there is a $\delta_1 > 0$ such that $0 < |x - x_0| < \delta_1 \Rightarrow |f(x) - L_1| < \epsilon \Rightarrow -\epsilon < f(x) - L_1 < \epsilon$
 $\Rightarrow -\frac{1}{3}(L_2 - L_1) + L_1 < f(x) < \frac{1}{3}(L_2 - L_1) + L_1 \Rightarrow 4L_1 - L_2 < 3f(x) < 2L_1 + L_2$. Likewise, $\lim_{x \rightarrow x_0} f(x) = L_2$ so there is a δ_2 such that $0 < |x - x_0| < \delta_2 \Rightarrow |f(x) - L_2| < \epsilon \Rightarrow -\epsilon < f(x) - L_2 < \epsilon$
 $\Rightarrow -\frac{1}{3}(L_2 - L_1) + L_2 < f(x) < \frac{1}{3}(L_2 - L_1) + L_2 \Rightarrow 2L_2 + L_1 < 3f(x) < 4L_2 - L_1$
 $\Rightarrow L_1 - 4L_2 < -3f(x) < -2L_2 - L_1$. If $\delta = \min\{\delta_1, \delta_2\}$ both inequalities must hold for $0 < |x - x_0| < \delta$:
 $\left. \begin{array}{l} 4L_1 - L_2 < 3f(x) < 2L_1 + L_2 \\ L_1 - 4L_2 < -3f(x) < -2L_2 - L_1 \end{array} \right\} \Rightarrow 5(L_1 - L_2) < 0 < L_1 - L_2$. That is, $L_1 - L_2 < 0$ and $L_1 - L_2 > 0$, a contradiction.

12. Suppose $\lim_{x \rightarrow c} f(x) = L$. If $k = 0$, then $\lim_{x \rightarrow c} kf(x) = \lim_{x \rightarrow c} 0 = 0 = 0 \cdot \lim_{x \rightarrow c} f(x)$ and we are done. If $k \neq 0$, then given any $\epsilon > 0$, there is a $\delta > 0$ so that $0 < |x - c| < \delta \Rightarrow |f(x) - L| < \frac{\epsilon}{|k|} \Rightarrow |k||f(x) - L| < \epsilon$
 $\Rightarrow |k(f(x) - L)| < \epsilon \Rightarrow |(kf(x)) - (kL)| < \epsilon$. Thus, $\lim_{x \rightarrow c} kf(x) = kL = k\left(\lim_{x \rightarrow c} f(x)\right)$.

13. (a) Since $x \rightarrow 0^+$, $0 < x^3 < x < 1 \Rightarrow (x^3 - x) \rightarrow 0^- \Rightarrow \lim_{x \rightarrow 0^+} f(x^3 - x) = \lim_{y \rightarrow 0^-} f(y) = B$ where $y = x^3 - x$.
 (b) Since $x \rightarrow 0^-$, $-1 < x < x^3 < 0 \Rightarrow (x^3 - x) \rightarrow 0^+ \Rightarrow \lim_{x \rightarrow 0^-} f(x^3 - x) = \lim_{y \rightarrow 0^+} f(y) = A$ where $y = x^3 - x$.
 (c) Since $x \rightarrow 0^+$, $0 < x^4 < x^2 < 1 \Rightarrow (x^2 - x^4) \rightarrow 0^+ \Rightarrow \lim_{x \rightarrow 0^+} f(x^2 - x^4) = \lim_{y \rightarrow 0^+} f(y) = A$ where $y = x^2 - x^4$.
 (d) Since $x \rightarrow 0^-$, $-1 < x < 0 \Rightarrow 0 < x^4 < x^2 < 1 \Rightarrow (x^2 - x^4) \rightarrow 0^+ \Rightarrow \lim_{x \rightarrow 0^-} f(x^2 - x^4) = A$ as in part (c).

14. (a) True, because if $\lim_{x \rightarrow a} (f(x) + g(x))$ exists then $\lim_{x \rightarrow a} (f(x) + g(x)) - \lim_{x \rightarrow a} f(x) = \lim_{x \rightarrow a} [(f(x) + g(x)) - f(x)] = \lim_{x \rightarrow a} g(x)$ exists, contrary to assumption.
 (b) False; for example take $f(x) = \frac{1}{x}$ and $g(x) = -\frac{1}{x}$. Then neither $\lim_{x \rightarrow 0} f(x)$ nor $\lim_{x \rightarrow 0} g(x)$ exists, but $\lim_{x \rightarrow 0} (f(x) + g(x)) = \lim_{x \rightarrow 0} \left(\frac{1}{x} - \frac{1}{x}\right) = \lim_{x \rightarrow 0} 0 = 0$ exists.
 (c) True, because $g(x) = |x|$ is continuous $\Rightarrow g(f(x)) = |f(x)|$ is continuous (it is the composite of continuous functions).
 (d) False; for example let $f(x) = \begin{cases} -1, & x \leq 0 \\ 1, & x > 0 \end{cases} \Rightarrow f(x)$ is discontinuous at $x = 0$. However $|f(x)| = 1$ is continuous at $x = 0$.

15. Show $\lim_{x \rightarrow -1} f(x) = \lim_{x \rightarrow -1} \frac{x^2 - 1}{x + 1} = \lim_{x \rightarrow -1} \frac{(x+1)(x-1)}{(x+1)} = -2, x \neq -1$.

Define the continuous extension of $f(x)$ as $F(x) = \begin{cases} \frac{x^2 - 1}{x + 1}, & x \neq -1 \\ -2, & x = -1 \end{cases}$. We now prove the limit of $f(x)$ as $x \rightarrow -1$

exists and has the correct value.

Step 1: $\left| \frac{x^2 - 1}{x + 1} - (-2) \right| < \epsilon \Rightarrow -\epsilon < \frac{(x+1)(x-1)}{(x+1)} + 2 < \epsilon \Rightarrow -\epsilon < (x - 1) + 2 < \epsilon, x \neq -1 \Rightarrow -\epsilon - 1 < x < \epsilon - 1$.

Step 2: $|x - (-1)| < \delta \Rightarrow -\delta < x + 1 < \delta \Rightarrow -\delta - 1 < x < \delta - 1$.

Then $-\delta - 1 = -\epsilon - 1 \Rightarrow \delta = \epsilon$, or $\delta - 1 = \epsilon - 1 \Rightarrow \delta = \epsilon$. Choose $\delta = \epsilon$. Then $0 < |x - (-1)| < \delta$

$\Rightarrow \left| \frac{x^2 - 1}{x + 1} - (-2) \right| < \epsilon \Rightarrow \lim_{x \rightarrow -1} F(x) = -2$. Since the conditions of the continuity test are met by $F(x)$, then $f(x)$ has a continuous extension to $F(x)$ at $x = -1$.

16. Show $\lim_{x \rightarrow 3} g(x) = \lim_{x \rightarrow 3} \frac{x^2 - 2x - 3}{2x - 6} = \lim_{x \rightarrow 3} \frac{(x-3)(x+1)}{2(x-3)} = 2, x \neq 3$.

Define the continuous extension of $g(x)$ as $G(x) = \begin{cases} \frac{x^2 - 2x - 3}{2x - 6}, & x \neq 3 \\ 2, & x = 3 \end{cases}$. We now prove the limit of $g(x)$ as

$x \rightarrow 3$ exists and has the correct value.

Step 1: $\left| \frac{x^2 - 2x - 3}{2x - 6} - 2 \right| < \epsilon \Rightarrow -\epsilon < \frac{(x-3)(x+1)}{2(x-3)} - 2 < \epsilon \Rightarrow -\epsilon < \frac{x+1}{2} - 2 < \epsilon, x \neq 3 \Rightarrow 3 - 2\epsilon < x < 3 + 2\epsilon$.

Step 2: $|x - 3| < \delta \Rightarrow -\delta < x - 3 < \delta \Rightarrow 3 - \delta < x < \delta + 3$.

Then, $3 - \delta = 3 - 2\epsilon \Rightarrow \delta = 2\epsilon$, or $\delta + 3 = 3 + 2\epsilon \Rightarrow \delta = 2\epsilon$. Choose $\delta = 2\epsilon$. Then $0 < |x - 3| < \delta$

$\Rightarrow \left| \frac{x^2 - 2x - 3}{2x - 6} - 2 \right| < \epsilon \Rightarrow \lim_{x \rightarrow 3} \frac{(x-3)(x+1)}{2(x-3)} = 2$. Since the conditions of the continuity test hold for $G(x)$,

$g(x)$ can be continuously extended to $G(x)$ at $x = 3$.

17. (a) Let $\epsilon > 0$ be given. If x is rational, then $f(x) = x \Rightarrow |f(x) - 0| = |x - 0| < \epsilon \Leftrightarrow |x - 0| < \epsilon$; i.e., choose $\delta = \epsilon$. Then $|x - 0| < \delta \Rightarrow |f(x) - 0| < \epsilon$ for x rational. If x is irrational, then $f(x) = 0 \Rightarrow |f(x) - 0| < \epsilon \Leftrightarrow 0 < \epsilon$ which is true no matter how close irrational x is to 0, so again we can choose $\delta = \epsilon$. In either case, given $\epsilon > 0$ there is a $\delta = \epsilon > 0$ such that $0 < |x - 0| < \delta \Rightarrow |f(x) - 0| < \epsilon$. Therefore, f is continuous at $x = 0$.

(b) Choose $x = c > 0$. Then within any interval $(c - \delta, c + \delta)$ there are both rational and irrational numbers. If c is rational, pick $\epsilon = \frac{c}{2}$. No matter how small we choose $\delta > 0$ there is an irrational number x in $(c - \delta, c + \delta) \Rightarrow |f(x) - f(c)| = |0 - c| = c > \frac{c}{2} = \epsilon$. That is, f is not continuous at any rational $c > 0$. On the other hand, suppose c is irrational $\Rightarrow f(c) = 0$. Again pick $\epsilon = \frac{c}{2}$. No matter how small we choose $\delta > 0$ there is a rational number x in $(c - \delta, c + \delta)$ with $|x - c| < \frac{c}{2} = \epsilon \Leftrightarrow \frac{c}{2} < x < \frac{3c}{2}$. Then $|f(x) - f(c)| = |x - 0| = |x| > \frac{c}{2} = \epsilon \Rightarrow f$ is not continuous at any irrational $c > 0$.

If $x = c < 0$, repeat the argument picking $\epsilon = \frac{|c|}{2} = \frac{-c}{2}$. Therefore f fails to be continuous at any nonzero value $x = c$.

18. (a) Let $c = \frac{m}{n}$ be a rational number in $[0, 1]$ reduced to lowest terms $\Rightarrow f(c) = \frac{1}{n}$. Pick $\epsilon = \frac{1}{2n}$. No matter how small $\delta > 0$ is taken, there is an irrational number x in the interval $(c - \delta, c + \delta) \Rightarrow |f(x) - f(c)| = \left| 0 - \frac{1}{n} \right| = \frac{1}{n} > \frac{1}{2n} = \epsilon$. Therefore f is discontinuous at $x = c$, a rational number.

(b) Now suppose c is an irrational number $\Rightarrow f(c) = 0$. Let $\epsilon > 0$ be given. Notice that $\frac{1}{2}$ is the only rational number reduced to lowest terms with denominator 2 and belonging to $[0, 1]$; $\frac{1}{3}$ and $\frac{2}{3}$ the only rationals with denominator 3 belonging to $[0, 1]$; $\frac{1}{4}$ and $\frac{3}{4}$ with denominator 4 in $[0, 1]$; $\frac{1}{5}, \frac{2}{5}, \frac{3}{5}$ and $\frac{4}{5}$ with denominator 5 in $[0, 1]$; etc. In general, choose N so that $\frac{1}{N} < \epsilon \Rightarrow$ there exist only finitely many rationals in $[0, 1]$ having denominator $\leq N$, say r_1, r_2, \dots, r_p . Let $\delta = \min \{ |c - r_i| : i = 1, \dots, p \}$. Then the interval $(c - \delta, c + \delta)$ contains no rational numbers with denominator $\leq N$. Thus, $0 < |x - c| < \delta \Rightarrow |f(x) - f(c)| = |f(x) - 0| = |f(x)| \leq \frac{1}{N} < \epsilon \Rightarrow f$ is continuous at $x = c$ irrational.

- (c) The graph looks like the markings on a typical ruler when the points $(x, f(x))$ on the graph of $f(x)$ are connected to the x -axis with vertical lines.

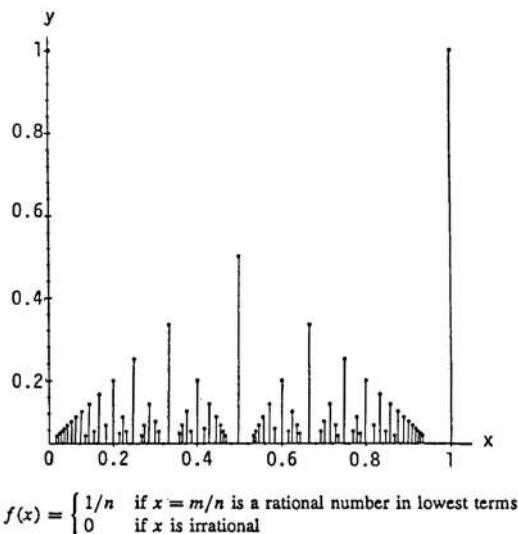

19. Yes. Let R be the radius of the equator (earth) and suppose at a fixed instant of time we label noon as the zero point, 0 , on the equator $\Rightarrow 0 + \pi R$ represents the midnight point (at the same exact time). Suppose x_1 is a point on the equator "just after" noon $\Rightarrow x_1 + \pi R$ is simultaneously "just after" midnight. It seems reasonable that the temperature T at a point just after noon is hotter than it would be at the diametrically opposite point just after midnight: That is, $T(x_1) - T(x_1 + \pi R) > 0$. At exactly the same moment in time pick x_2 to be a point just before midnight $\Rightarrow x_2 + \pi R$ is just before noon. Then $T(x_2) - T(x_2 + \pi R) < 0$. Assuming the temperature function T is continuous along the equator (which is reasonable), the Intermediate Value Theorem says there is a point c between 0 (noon) and πR (simultaneously midnight) such that $T(c) - T(c + \pi R) = 0$; i.e., there is always a pair of antipodal points on the earth's equator where the temperatures are the same.

$$20. \lim_{x \rightarrow c} f(x)g(x) = \lim_{x \rightarrow c} \frac{1}{4} \left[(f(x) + g(x))^2 - (f(x) - g(x))^2 \right] = \frac{1}{4} \left[\left(\lim_{x \rightarrow c} (f(x) + g(x)) \right)^2 - \left(\lim_{x \rightarrow c} (f(x) - g(x)) \right)^2 \right]$$

$$= \frac{1}{4} (3^2 - (-1)^2) = 2.$$

$$21. (a) \text{ At } x = 0: \lim_{a \rightarrow 0} r_+(a) = \lim_{a \rightarrow 0} \frac{-1 + \sqrt{1+a}}{a} = \lim_{a \rightarrow 0} \left(\frac{-1 + \sqrt{1+a}}{a} \right) \left(\frac{-1 - \sqrt{1+a}}{-1 - \sqrt{1+a}} \right)$$

$$= \lim_{a \rightarrow 0} \frac{1 - (1+a)}{a(-1 - \sqrt{1+a})} = \frac{-1}{-1 - \sqrt{1+0}} = \frac{1}{2}$$

$$\text{At } x = -1: \lim_{a \rightarrow -1^+} r_+(a) = \lim_{a \rightarrow -1^+} \frac{1 - (1+a)}{a(-1 - \sqrt{1+a})} = \lim_{a \rightarrow -1^+} \frac{-a}{a(-1 - \sqrt{1+a})} = \frac{-1}{-1 - \sqrt{0}} = 1$$

$$(b) \text{ At } x = 0: \lim_{a \rightarrow 0^-} r_-(a) = \lim_{a \rightarrow 0^-} \frac{-1 - \sqrt{1+a}}{a} = \lim_{a \rightarrow 0^-} \left(\frac{-1 - \sqrt{1+a}}{a} \right) \left(\frac{-1 + \sqrt{1+a}}{-1 + \sqrt{1+a}} \right)$$

$$= \lim_{a \rightarrow 0^-} \frac{1 - (1+a)}{a(-1 + \sqrt{1+a})} = \lim_{a \rightarrow 0^-} \frac{-a}{a(-1 + \sqrt{1+a})} = \lim_{a \rightarrow 0^-} \frac{-1}{-1 + \sqrt{1+a}} = \infty \text{ (because the denominator is always negative);}$$

$$\lim_{a \rightarrow 0^+} r_-(a) = \lim_{a \rightarrow 0^+} \frac{-1}{-1 + \sqrt{1+a}} = -\infty \text{ (because the denominator is always positive). Therefore, } \lim_{a \rightarrow 0} r_-(a) \text{ does not exist.}$$

$$\text{At } x = -1: \lim_{a \rightarrow -1^+} r_-(a) = \lim_{a \rightarrow -1^+} \frac{-1 - \sqrt{1+a}}{a} = \lim_{a \rightarrow -1^+} \frac{-1}{-1 + \sqrt{1+a}} = 1$$

(c)

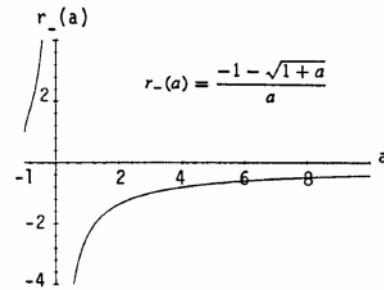
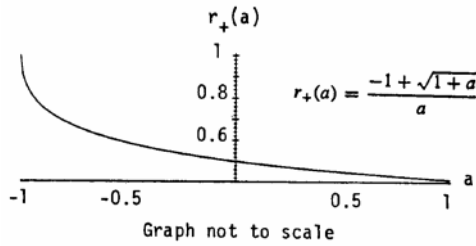

(d)

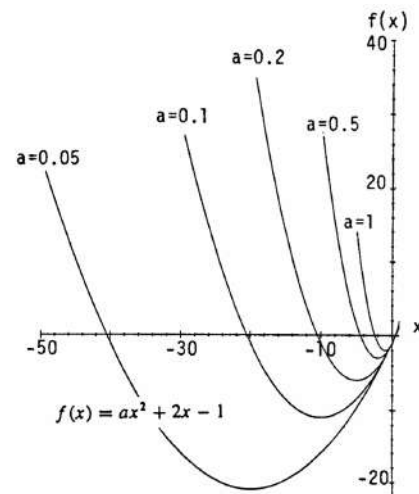
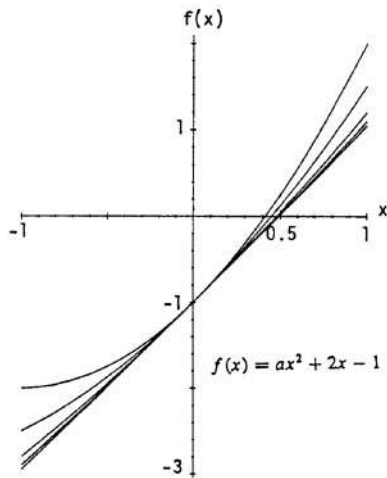

22. $f(x) = x + 2 \cos x \Rightarrow f(0) = 0 + 2 \cos 0 = 2 > 0$ and $f(-\pi) = -\pi + 2 \cos(-\pi) = -\pi - 2 < 0$. Since $f(x)$ is continuous on $[-\pi, 0]$, by the Intermediate Value Theorem, $f(x)$ must take on every value between $[-\pi - 2, 2]$. Thus there is some number c in $[-\pi, 0]$ such that $f(c) = 0$; i.e., c is a solution to $x + 2 \cos x = 0$.

23. (a) The function f is bounded on D if $f(x) \geq M$ and $f(x) \leq N$ for all x in D . This means $M \leq f(x) \leq N$ for all x in D . Choose B to be $\max\{|M|, |N|\}$. Then $|f(x)| \leq B$. On the other hand, if $|f(x)| \leq B$, then $-B \leq f(x) \leq B \Rightarrow f(x) \geq -B$ and $f(x) \leq B \Rightarrow f(x)$ is bounded on D with $N = B$ an upper bound and $M = -B$ a lower bound.

(b) Assume $f(x) \leq N$ for all x and that $L > N$. Let $\epsilon = \frac{L-N}{2}$. Since $\lim_{x \rightarrow x_0} f(x) = L$ there is a $\delta > 0$ such that $0 < |x - x_0| < \delta \Rightarrow |f(x) - L| < \epsilon \Leftrightarrow L - \epsilon < f(x) < L + \epsilon \Leftrightarrow L - \frac{L-N}{2} < f(x) < L + \frac{L-N}{2} \Leftrightarrow \frac{L+N}{2} < f(x) < \frac{3L-N}{2}$. But $L > N \Rightarrow \frac{L+N}{2} > N \Rightarrow N < f(x)$ contrary to the boundedness assumption $f(x) \leq N$. This contradiction proves $L \leq N$.

(c) Assume $M \leq f(x)$ for all x and that $L < M$. Let $\epsilon = \frac{M-L}{2}$. As in part (b), $0 < |x - x_0| < \delta \Rightarrow L - \frac{M-L}{2} < f(x) < L + \frac{M-L}{2} \Leftrightarrow \frac{3L-M}{2} < f(x) < \frac{M+L}{2} < M$, a contradiction.

24. (a) If $a \geq b$, then $a - b \geq 0 \Rightarrow |a - b| = a - b \Rightarrow \max(a, b) = \frac{a+b}{2} + \frac{|a-b|}{2} = \frac{a+b}{2} + \frac{a-b}{2} = \frac{2a}{2} = a$.
If $a \leq b$, then $a - b \leq 0 \Rightarrow |a - b| = -(a - b) = b - a \Rightarrow \max(a, b) = \frac{a+b}{2} + \frac{|a-b|}{2} = \frac{a+b}{2} + \frac{b-a}{2} = \frac{2b}{2} = b$.

(b) Let $\min(a, b) = \frac{a+b}{2} - \frac{|a-b|}{2}$.

120 Chapter 2 Limits and Continuity

$$\begin{aligned}
 25. \lim_{x \rightarrow 0} \frac{\sin(1 - \cos x)}{x} &= \lim_{x \rightarrow 0} \frac{\sin(1 - \cos x)}{1 - \cos x} \cdot \frac{1 - \cos x}{x} \cdot \frac{1 + \cos x}{1 + \cos x} = \lim_{x \rightarrow 0} \frac{\sin(1 - \cos x)}{1 - \cos x} \cdot \lim_{x \rightarrow 0} \frac{1 - \cos^2 x}{x(1 + \cos x)} = 1 \cdot \lim_{x \rightarrow 0} \frac{\sin^2 x}{x(1 + \cos x)} \\
 &= \lim_{x \rightarrow 0} \frac{\sin x}{x} \cdot \frac{\sin x}{1 + \cos x} = 1 \cdot \left(\frac{0}{2}\right) = 0.
 \end{aligned}$$

$$26. \lim_{x \rightarrow 0^+} \frac{\sin x}{\sin \sqrt{x}} = \lim_{x \rightarrow 0^+} \frac{\sin x}{x} \cdot \frac{\sqrt{x}}{\sin \sqrt{x}} \cdot \frac{x}{\sqrt{x}} = 1 \cdot \lim_{x \rightarrow 0^+} \frac{1}{\left(\frac{\sin \sqrt{x}}{\sqrt{x}}\right)} \cdot \lim_{x \rightarrow 0^+} \sqrt{x} = 1 \cdot 0 \cdot 0 = 0.$$

$$27. \lim_{x \rightarrow 0} \frac{\sin(\sin x)}{x} = \lim_{x \rightarrow 0} \frac{\sin(\sin x)}{\sin x} \cdot \frac{\sin x}{x} = \lim_{x \rightarrow 0} \frac{\sin(\sin x)}{\sin x} \cdot \lim_{x \rightarrow 0} \frac{\sin x}{x} = 1 \cdot 1 = 1.$$

$$28. \lim_{x \rightarrow 0} \frac{\sin(x^2 + x)}{x} = \lim_{x \rightarrow 0} \frac{\sin(x^2 + x)}{x^2 + x} \cdot (x + 1) = \lim_{x \rightarrow 0} \frac{\sin(x^2 + x)}{x^2 + x} \cdot \lim_{x \rightarrow 0} (x + 1) = 1 \cdot 1 = 1$$

$$29. \lim_{x \rightarrow 2} \frac{\sin(x^2 - 4)}{x - 2} = \lim_{x \rightarrow 2} \frac{\sin(x^2 - 4)}{x^2 - 4} \cdot (x + 2) = \lim_{x \rightarrow 2} \frac{\sin(x^2 - 4)}{x^2 - 4} \cdot \lim_{x \rightarrow 2} (x + 2) = 1 \cdot 4 = 4$$

$$30. \lim_{x \rightarrow 9} \frac{\sin(\sqrt{x} - 3)}{x - 9} = \lim_{x \rightarrow 9} \frac{\sin(\sqrt{x} - 3)}{\sqrt{x} - 3} \cdot \frac{1}{\sqrt{x} + 3} = \lim_{x \rightarrow 9} \frac{\sin(\sqrt{x} - 3)}{\sqrt{x} - 3} \cdot \lim_{x \rightarrow 9} \frac{1}{\sqrt{x} + 3} = 1 \cdot \frac{1}{6} = \frac{1}{6}$$

CHAPTER 3 DIFFERENTIATION

3.1 THE DERIVATIVE OF A FUNCTION

1. Step 1: $f(x) = 4 - x^2$ and $f(x + h) = 4 - (x + h)^2$

Step 2:
$$\frac{f(x+h)-f(x)}{h} = \frac{[4-(x+h)^2]-(4-x^2)}{h} = \frac{(4-x^2-2xh-h^2)-4+x^2}{h} = \frac{-2xh-h^2}{h} = \frac{h(-2x-h)}{h}$$

 $= -2x - h$

Step 3: $f'(x) = \lim_{h \rightarrow 0} (-2x - h) = -2x$; $f'(-3) = 6$, $f'(0) = 0$, $f'(1) = -2$

2. $F(x) = (x - 1)^2 + 1$ and $F(x + h) = (x + h - 1)^2 + 1 \Rightarrow F'(x) = \lim_{h \rightarrow 0} \frac{[(x+h-1)^2+1]-[(x-1)^2+1]}{h}$
 $= \lim_{h \rightarrow 0} \frac{(x^2+2xh+h^2-2x-2h+1+1)-(x^2-2x+1+1)}{h} = \lim_{h \rightarrow 0} \frac{2xh+h^2-2h}{h} = \lim_{h \rightarrow 0} (2x+h-2)$
 $= 2(x-1)$; $F'(-1) = -4$, $F'(0) = -2$, $F'(2) = 2$

3. Step 1: $g(t) = \frac{1}{t^2}$ and $g(t + h) = \frac{1}{(t+h)^2}$

Step 2:
$$\frac{g(t+h)-g(t)}{h} = \frac{\frac{1}{(t+h)^2} - \frac{1}{t^2}}{h} = \frac{\frac{t^2-(t+h)^2}{(t+h)^2 \cdot t^2}}{h} = \frac{t^2-(t^2+2th+h^2)}{(t+h)^2 \cdot t^2 \cdot h} = \frac{-2th-h^2}{(t+h)^2 t^2 h}$$

 $= \frac{h(-2t-h)}{(t+h)^2 t^2 h} = \frac{-2t-h}{(t+h)^2 t^2}$

Step 3: $g'(t) = \lim_{h \rightarrow 0} \frac{-2t-h}{(t+h)^2 t^2} = \frac{-2t}{t^2 \cdot t^2} = \frac{-2}{t^3}$; $g'(-1) = 2$, $g'(2) = -\frac{1}{4}$, $g'(\sqrt{3}) = -\frac{2}{3\sqrt{3}}$

4. $k(z) = \frac{1-z}{2z}$ and $k(z + h) = \frac{1-(z+h)}{2(z+h)} \Rightarrow k'(z) = \lim_{h \rightarrow 0} \frac{\left(\frac{1-(z+h)}{2(z+h)} - \frac{1-z}{2z}\right)}{h}$
 $= \lim_{h \rightarrow 0} \frac{(1-z-h)z - (1-z)(z+h)}{2(z+h)zh} = \lim_{h \rightarrow 0} \frac{z-z^2-zh-z-zh+z^2+zh}{2(z+h)zh} = \lim_{h \rightarrow 0} \frac{-h}{2(z+h)zh} = \lim_{h \rightarrow 0} \frac{-1}{2(z+h)z}$
 $= \frac{-1}{2z^2}$; $k'(-1) = -\frac{1}{2}$, $k'(1) = -\frac{1}{2}$, $k'(\sqrt{2}) = -\frac{1}{4}$

5. Step 1: $p(\theta) = \sqrt{3\theta}$ and $p(\theta + h) = \sqrt{3(\theta + h)}$

Step 2:
$$\frac{p(\theta+h)-p(\theta)}{h} = \frac{\sqrt{3(\theta+h)}-\sqrt{3\theta}}{h} = \frac{(\sqrt{3\theta+3h}-\sqrt{3\theta})}{h} \cdot \frac{(\sqrt{3\theta+3h}+\sqrt{3\theta})}{(\sqrt{3\theta+3h}+\sqrt{3\theta})} = \frac{(3\theta+3h)-3\theta}{h(\sqrt{3\theta+3h}+\sqrt{3\theta})}$$

 $= \frac{3h}{h(\sqrt{3\theta+3h}+\sqrt{3\theta})} = \frac{3}{\sqrt{3\theta+3h}+\sqrt{3\theta}}$

Step 3: $p'(\theta) = \lim_{h \rightarrow 0} \frac{3}{\sqrt{3\theta+3h}+\sqrt{3\theta}} = \frac{3}{\sqrt{3\theta}+\sqrt{3\theta}} = \frac{3}{2\sqrt{3\theta}}$; $p'(1) = \frac{3}{2\sqrt{3}}$, $p'(3) = \frac{1}{2}$, $p'\left(\frac{2}{3}\right) = \frac{3}{2\sqrt{2}}$

6. $r(s) = \sqrt{2s+1}$ and $r(s + h) = \sqrt{2(s+h)+1} \Rightarrow r'(s) = \lim_{h \rightarrow 0} \frac{\sqrt{2s+2h+1}-\sqrt{2s+1}}{h}$

$$= \lim_{h \rightarrow 0} \frac{(\sqrt{2s+2h+1}-\sqrt{2s+1})}{h} \cdot \frac{(\sqrt{2s+2h+1}+\sqrt{2s+1})}{(\sqrt{2s+2h+1}+\sqrt{2s+1})} = \lim_{h \rightarrow 0} \frac{(2s+2h+1)-(2s+1)}{h(\sqrt{2s+2h+1}+\sqrt{2s+1})}$$

 $= \lim_{h \rightarrow 0} \frac{2h}{h(\sqrt{2s+2h+1}+\sqrt{2s+1})} = \lim_{h \rightarrow 0} \frac{2}{\sqrt{2s+2h+1}+\sqrt{2s+1}} = \frac{2}{\sqrt{2s+1}+\sqrt{2s+1}} = \frac{2}{2\sqrt{2s+1}}$
 $= \frac{1}{\sqrt{2s+1}}$; $r'(0) = 1$, $r'(1) = \frac{1}{\sqrt{3}}$, $r'\left(\frac{1}{2}\right) = \frac{1}{\sqrt{2}}$

7. $y = f(x) = 2x^3$ and $f(x + h) = 2(x + h)^3 \Rightarrow \frac{dy}{dx} = \lim_{h \rightarrow 0} \frac{2(x+h)^3-2x^3}{h} = \lim_{h \rightarrow 0} \frac{2(x^3+3x^2h+3xh^2+h^3)-2x^3}{h}$

$= \lim_{h \rightarrow 0} \frac{6x^2h+6xh^2+2h^3}{h} = \lim_{h \rightarrow 0} \frac{h(6x^2+6xh+2h^2)}{h} = \lim_{h \rightarrow 0} (6x^2+6xh+2h^2) = 6x^2$

$$\begin{aligned}
 8. \quad r &= \frac{s^3}{2} + 1 \Rightarrow \frac{dr}{ds} = \lim_{h \rightarrow 0} \frac{\left[\frac{(s+h)^3}{2} + 1\right] - \left[\frac{s^3}{2} + 1\right]}{h} = \frac{1}{2} \lim_{h \rightarrow 0} \frac{[(s+h)^3 + 2] - [s^3 + 2]}{h} \\
 &= \frac{1}{2} \lim_{h \rightarrow 0} \frac{s^3 + 3s^2h + 3sh^2 + h^3 + 2 - s^3 - 2}{h} = \frac{1}{2} \lim_{h \rightarrow 0} \frac{h[3s^2 + 3sh + h^2]}{h} = \frac{1}{2} \lim_{h \rightarrow 0} (3s^2 + 3sh + h^2) = \frac{3}{2} s^2
 \end{aligned}$$

$$\begin{aligned}
 9. \quad s &= r(t) = \frac{t}{2t+1} \text{ and } r(t+h) = \frac{t+h}{2(t+h)+1} \Rightarrow \frac{ds}{dt} = \lim_{h \rightarrow 0} \frac{\left(\frac{t+h}{2(t+h)+1}\right) - \left(\frac{t}{2t+1}\right)}{h} \\
 &= \lim_{h \rightarrow 0} \frac{\frac{(t+h)(2t+1) - t(2t+2h+1)}{h(2t+2h+1)(2t+1)}}{h} = \lim_{h \rightarrow 0} \frac{(t+h)(2t+1) - t(2t+2h+1)}{(2t+2h+1)(2t+1)h} \\
 &= \lim_{h \rightarrow 0} \frac{2t^2 + t + 2ht + h - 2t^2 - 2ht - t}{(2t+2h+1)(2t+1)h} = \lim_{h \rightarrow 0} \frac{h}{(2t+2h+1)(2t+1)h} = \lim_{h \rightarrow 0} \frac{1}{(2t+2h+1)(2t+1)} \\
 &= \frac{1}{(2t+1)(2t+1)} = \frac{1}{(2t+1)^2}
 \end{aligned}$$

$$\begin{aligned}
 10. \quad \frac{dv}{dt} &= \lim_{h \rightarrow 0} \frac{\left(\frac{t+h}{t+h} + \frac{1}{t+h}\right) - \left(\frac{t}{t} + \frac{1}{t}\right)}{h} = \lim_{h \rightarrow 0} \frac{h - \frac{1}{t+h} + \frac{1}{t}}{h} = \lim_{h \rightarrow 0} \frac{\left(\frac{h(t+h)t - t + (t+h)}{(t+h)t}\right)}{h} \\
 &= \lim_{h \rightarrow 0} \frac{ht^2 + h^2t + h}{h(t+h)t} = \lim_{h \rightarrow 0} \frac{t^2 + ht + 1}{(t+h)t} = \frac{t^2 + 1}{t^2} = 1 + \frac{1}{t^2}
 \end{aligned}$$

$$\begin{aligned}
 11. \quad p &= f(q) = \frac{1}{\sqrt{q+1}} \text{ and } f(q+h) = \frac{1}{\sqrt{(q+h)+1}} \Rightarrow \frac{dp}{dq} = \lim_{h \rightarrow 0} \frac{\left(\frac{1}{\sqrt{(q+h)+1}}\right) - \left(\frac{1}{\sqrt{q+1}}\right)}{h} \\
 &= \lim_{h \rightarrow 0} \frac{\left(\frac{\sqrt{q+1} - \sqrt{q+h+1}}{\sqrt{q+h+1}\sqrt{q+1}}\right)}{h} = \lim_{h \rightarrow 0} \frac{\sqrt{q+1} - \sqrt{q+h+1}}{h\sqrt{q+h+1}\sqrt{q+1}} \\
 &= \lim_{h \rightarrow 0} \frac{(\sqrt{q+1} - \sqrt{q+h+1}) \cdot (\sqrt{q+1} + \sqrt{q+h+1})}{h\sqrt{q+h+1}\sqrt{q+1}(\sqrt{q+1} + \sqrt{q+h+1})} = \lim_{h \rightarrow 0} \frac{(q+1) - (q+h+1)}{h\sqrt{q+h+1}\sqrt{q+1}(\sqrt{q+1} + \sqrt{q+h+1})} \\
 &= \lim_{h \rightarrow 0} \frac{-h}{h\sqrt{q+h+1}\sqrt{q+1}(\sqrt{q+1} + \sqrt{q+h+1})} = \lim_{h \rightarrow 0} \frac{-1}{\sqrt{q+h+1}\sqrt{q+1}(\sqrt{q+1} + \sqrt{q+h+1})} \\
 &= \frac{-1}{\sqrt{q+1}\sqrt{q+1}(\sqrt{q+1} + \sqrt{q+1})} = \frac{-1}{2(q+1)\sqrt{q+1}}
 \end{aligned}$$

$$\begin{aligned}
 12. \quad \frac{dz}{dw} &= \lim_{h \rightarrow 0} \frac{\left(\frac{1}{\sqrt{3(w+h)-2}} - \frac{1}{\sqrt{3w-2}}\right)}{h} = \lim_{h \rightarrow 0} \frac{\sqrt{3w-2} - \sqrt{3w+3h-2}}{h\sqrt{3w+3h-2}\sqrt{3w-2}} \\
 &= \lim_{h \rightarrow 0} \frac{(\sqrt{3w-2} - \sqrt{3w+3h-2}) \cdot (\sqrt{3w-2} + \sqrt{3w+3h-2})}{h\sqrt{3w+3h-2}\sqrt{3w-2}(\sqrt{3w-2} + \sqrt{3w+3h-2})} \\
 &= \lim_{h \rightarrow 0} \frac{(3w-2) - (3w+3h-2)}{h\sqrt{3w+3h-2}\sqrt{3w-2}(\sqrt{3w-2} + \sqrt{3w+3h-2})} \\
 &= \lim_{h \rightarrow 0} \frac{-3}{\sqrt{3w+3h-2}\sqrt{3w-2}(\sqrt{3w-2} + \sqrt{3w+3h-2})} = \frac{-3}{\sqrt{3w-2}\sqrt{3w-2}(\sqrt{3w-2} + \sqrt{3w-2})} \\
 &= \frac{-3}{2(3w-2)\sqrt{3w-2}}
 \end{aligned}$$

$$\begin{aligned}
 13. \quad f(x) &= x + \frac{9}{x} \text{ and } f(x+h) = (x+h) + \frac{9}{(x+h)} \Rightarrow \frac{f(x+h) - f(x)}{h} = \frac{\left[(x+h) + \frac{9}{(x+h)}\right] - \left[x + \frac{9}{x}\right]}{h} \\
 &= \frac{x(x+h)^2 + 9x - x^2(x+h) - 9(x+h)}{x(x+h)h} = \frac{x^3 + 2x^2h + xh^2 + 9x - x^3 - x^2h - 9x - 9h}{x(x+h)h} = \frac{x^2h + xh^2 - 9h}{x(x+h)h} \\
 &= \frac{h(x^2 + xh - 9)}{x(x+h)h} = \frac{x^2 + xh - 9}{x(x+h)}; f'(x) = \lim_{h \rightarrow 0} \frac{x^2 + xh - 9}{x(x+h)} = \frac{x^2 - 9}{x^2} = 1 - \frac{9}{x^2}; m = f'(-3) = 0
 \end{aligned}$$

$$\begin{aligned}
 14. \quad k(x) &= \frac{1}{2+x} \text{ and } k(x+h) = \frac{1}{2+(x+h)} \Rightarrow k'(x) = \lim_{h \rightarrow 0} \frac{k(x+h) - k(x)}{h} = \lim_{h \rightarrow 0} \frac{\left(\frac{1}{2+x+h} - \frac{1}{2+x}\right)}{h} \\
 &= \lim_{h \rightarrow 0} \frac{(2+x) - (2+x+h)}{h(2+x)(2+x+h)} = \lim_{h \rightarrow 0} \frac{-h}{h(2+x)(2+x+h)} = \lim_{h \rightarrow 0} \frac{-1}{(2+x)(2+x+h)} = \frac{-1}{(2+x)^2}; \\
 k'(2) &= -\frac{1}{16}
 \end{aligned}$$

$$\begin{aligned}
 15. \quad \frac{ds}{dt} &= \lim_{h \rightarrow 0} \frac{[(t+h)^3 - (t+h)^2] - (t^3 - t^2)}{h} = \lim_{h \rightarrow 0} \frac{(t^3 + 3t^2h + 3th^2 + h^3) - (t^2 + 2th + h^2) - t^3 + t^2}{h} \\
 &= \lim_{h \rightarrow 0} \frac{3t^2h + 3th^2 + h^3 - 2th - h^2}{h} = \lim_{h \rightarrow 0} \frac{h(3t^2 + 3th + h^2 - 2t - h)}{h} = \lim_{h \rightarrow 0} (3t^2 + 3th + h^2 - 2t - h)
 \end{aligned}$$

$$= 3t^2 - 2t; m = \left. \frac{ds}{dt} \right|_{t=-1} = 5$$

$$16. \frac{dy}{dx} = \lim_{h \rightarrow 0} \frac{(x+h+1)^3 - (x+1)^3}{h} = \lim_{h \rightarrow 0} \frac{(x+1)^3 + 3(x+1)^2h + 3(x+1)h^2 + h^3 - (x+1)^3}{h}$$

$$= \lim_{h \rightarrow 0} [3(x+1)^2 + 3(x+1)h + h^2] = 3(x+1)^2; m = \left. \frac{dy}{dx} \right|_{x=-2} = 3$$

$$17. f(x) = \frac{8}{\sqrt{x-2}} \text{ and } f(x+h) = \frac{8}{\sqrt{(x+h)-2}} \Rightarrow \frac{f(x+h)-f(x)}{h} = \frac{\frac{8}{\sqrt{(x+h)-2}} - \frac{8}{\sqrt{x-2}}}{h}$$

$$= \frac{8(\sqrt{x-2} - \sqrt{x+h-2})}{h\sqrt{x+h-2}\sqrt{x-2}} \cdot \frac{(\sqrt{x-2} + \sqrt{x+h-2})}{(\sqrt{x-2} + \sqrt{x+h-2})} = \frac{8[(x-2) - (x+h-2)]}{h\sqrt{x+h-2}\sqrt{x-2}(\sqrt{x-2} + \sqrt{x+h-2})}$$

$$= \frac{-8h}{h\sqrt{x+h-2}\sqrt{x-2}(\sqrt{x-2} + \sqrt{x+h-2})} \Rightarrow f'(x) = \lim_{h \rightarrow 0} \frac{-8}{\sqrt{x+h-2}\sqrt{x-2}(\sqrt{x-2} + \sqrt{x+h-2})}$$

$$= \frac{-8}{\sqrt{x-2}\sqrt{x-2}(\sqrt{x-2} + \sqrt{x-2})} = \frac{-4}{(x-2)\sqrt{x-2}}; m = f'(6) = \frac{-4}{4\sqrt{4}} = -\frac{1}{2} \Rightarrow \text{the equation of the tangent}$$

line at (6, 4) is $y - 4 = -\frac{1}{2}(x - 6) \Rightarrow y = -\frac{1}{2}x + 3 + 4 \Rightarrow y = -\frac{1}{2}x + 7$.

$$18. g'(z) = \lim_{h \rightarrow 0} \frac{(1 + \sqrt{4-(z+h)}) - (1 + \sqrt{4-z})}{h} = \lim_{h \rightarrow 0} \frac{(\sqrt{4-z-h} - \sqrt{4-z})}{h} \cdot \frac{(\sqrt{4-z-h} + \sqrt{4-z})}{(\sqrt{4-z-h} + \sqrt{4-z})}$$

$$= \lim_{h \rightarrow 0} \frac{(4-z-h) - (4-z)}{h(\sqrt{4-z-h} + \sqrt{4-z})} = \lim_{h \rightarrow 0} \frac{-h}{h(\sqrt{4-z-h} + \sqrt{4-z})} = \lim_{h \rightarrow 0} \frac{-1}{(\sqrt{4-z-h} + \sqrt{4-z})} = \frac{-1}{2\sqrt{4-z}};$$

$$m = g'(3) = \frac{-1}{2\sqrt{4-3}} = -\frac{1}{2} \Rightarrow \text{the equation of the tangent line at (3, 2) is } w - 2 = -\frac{1}{2}(z - 3)$$

$$\Rightarrow w = -\frac{1}{2}z + \frac{3}{2} + 2 \Rightarrow w = -\frac{1}{2}z + \frac{7}{2}.$$

$$19. s = f(t) = 1 - 3t^2 \text{ and } f(t+h) = 1 - 3(t+h)^2 = 1 - 3t^2 - 6th - 3h^2 \Rightarrow \frac{ds}{dt} = \lim_{h \rightarrow 0} \frac{f(t+h) - f(t)}{h}$$

$$= \lim_{h \rightarrow 0} \frac{(1 - 3t^2 - 6th - 3h^2) - (1 - 3t^2)}{h} = \lim_{h \rightarrow 0} (-6t - 3h) = -6t \Rightarrow \left. \frac{ds}{dt} \right|_{t=-1} = 6$$

$$20. y = f(x) = 1 - \frac{1}{x} \text{ and } f(x+h) = 1 - \frac{1}{x+h} \Rightarrow \frac{dy}{dx} = \lim_{h \rightarrow 0} \frac{f(x+h) - f(x)}{h} = \lim_{h \rightarrow 0} \frac{(1 - \frac{1}{x+h}) - (1 - \frac{1}{x})}{h}$$

$$= \lim_{h \rightarrow 0} \frac{\frac{1}{x} - \frac{1}{x+h}}{h} = \lim_{h \rightarrow 0} \frac{h}{x(x+h)h} = \lim_{h \rightarrow 0} \frac{1}{x(x+h)} = \frac{1}{x^2} \Rightarrow \left. \frac{dy}{dx} \right|_{x=\sqrt{3}} = \frac{1}{3}$$

$$21. r = f(\theta) = \frac{2}{\sqrt{4-\theta}} \text{ and } f(\theta+h) = \frac{2}{\sqrt{4-(\theta+h)}} \Rightarrow \frac{dr}{d\theta} = \lim_{h \rightarrow 0} \frac{f(\theta+h) - f(\theta)}{h} = \lim_{h \rightarrow 0} \frac{\frac{2}{\sqrt{4-\theta-h}} - \frac{2}{\sqrt{4-\theta}}}{h}$$

$$= \lim_{h \rightarrow 0} \frac{2\sqrt{4-\theta} - 2\sqrt{4-\theta-h}}{h\sqrt{4-\theta}\sqrt{4-\theta-h}} = \lim_{h \rightarrow 0} \frac{2\sqrt{4-\theta} - 2\sqrt{4-\theta-h}}{h\sqrt{4-\theta}\sqrt{4-\theta-h}} \cdot \frac{(2\sqrt{4-\theta} + 2\sqrt{4-\theta-h})}{(2\sqrt{4-\theta} + 2\sqrt{4-\theta-h})}$$

$$= \lim_{h \rightarrow 0} \frac{4(4-\theta) - 4(4-\theta-h)}{2h\sqrt{4-\theta}\sqrt{4-\theta-h}(\sqrt{4-\theta} + \sqrt{4-\theta-h})} = \lim_{h \rightarrow 0} \frac{2}{\sqrt{4-\theta}\sqrt{4-\theta-h}(\sqrt{4-\theta} + \sqrt{4-\theta-h})}$$

$$= \frac{2}{(4-\theta)(2\sqrt{4-\theta})} = \frac{1}{(4-\theta)\sqrt{4-\theta}} \Rightarrow \left. \frac{dr}{d\theta} \right|_{\theta=0} = \frac{1}{8}$$

$$22. w = f(z) = z + \sqrt{z} \text{ and } f(z+h) = (z+h) + \sqrt{z+h} \Rightarrow \frac{dw}{dz} = \lim_{h \rightarrow 0} \frac{f(z+h) - f(z)}{h}$$

$$= \lim_{h \rightarrow 0} \frac{(z+h + \sqrt{z+h}) - (z + \sqrt{z})}{h} = \lim_{h \rightarrow 0} \frac{h + \sqrt{z+h} - \sqrt{z}}{h} = \lim_{h \rightarrow 0} \left[1 + \frac{\sqrt{z+h} - \sqrt{z}}{h} \cdot \frac{(\sqrt{z+h} + \sqrt{z})}{(\sqrt{z+h} + \sqrt{z})} \right]$$

$$= 1 + \lim_{h \rightarrow 0} \frac{(z+h) - z}{h(\sqrt{z+h} + \sqrt{z})} = 1 + \lim_{h \rightarrow 0} \frac{1}{\sqrt{z+h} + \sqrt{z}} = 1 + \frac{1}{2\sqrt{z}} \Rightarrow \left. \frac{dw}{dz} \right|_{z=4} = \frac{5}{4}$$

$$23. f'(x) = \lim_{z \rightarrow x} \frac{f(z) - f(x)}{z - x} = \lim_{z \rightarrow x} \frac{\frac{1}{z+2} - \frac{1}{x+2}}{z - x} = \lim_{z \rightarrow x} \frac{(x+2) - (z+2)}{(z-x)(z+2)(x+2)} = \lim_{z \rightarrow x} \frac{x-z}{(z-x)(z+2)(x+2)} = \lim_{z \rightarrow x} \frac{-1}{(z+2)(x+2)}$$

$$= \frac{-1}{(x+2)^2}$$

$$24. f'(x) = \lim_{z \rightarrow x} \frac{f(z) - f(x)}{z - x} = \lim_{z \rightarrow x} \frac{\frac{1}{(z-1)^2} - \frac{1}{(x-1)^2}}{z - x} = \lim_{z \rightarrow x} \frac{(x-1)^2 - (z-1)^2}{(z-x)(z-1)^2(x-1)^2} = \lim_{z \rightarrow x} \frac{[(x-1) - (z-1)][(x-1) + (z-1)]}{(z-x)(z-1)^2(x-1)^2}$$

$$= \lim_{z \rightarrow x} \frac{(x-z)(x+z-2)}{(z-x)(z-1)^2(x-1)^2} = \lim_{z \rightarrow x} \frac{-1(x+z-2)}{(z-1)^2(x-1)^2} = \frac{-1(2x-2)}{(x-1)^4} = \frac{-2(x-1)}{(x-1)^4} = \frac{-2}{(x-1)^3}$$

$$25. g'(x) = \lim_{z \rightarrow x} \frac{g(z) - g(x)}{z - x} = \lim_{z \rightarrow x} \frac{\frac{z}{z-1} - \frac{x}{x-1}}{z - x} = \lim_{z \rightarrow x} \frac{z(x-1) - x(z-1)}{(z-x)(z-1)(x-1)} = \lim_{z \rightarrow x} \frac{-z+x}{(z-x)(z-1)(x-1)} = \lim_{z \rightarrow x} \frac{-1}{(x-1)^2}$$

$$26. g'(x) = \lim_{z \rightarrow x} \frac{g(z) - g(x)}{z - x} = \lim_{z \rightarrow x} \frac{(1 + \sqrt{z}) - (1 + \sqrt{x})}{z - x} = \lim_{z \rightarrow x} \frac{\sqrt{z} - \sqrt{x}}{z - x} \cdot \frac{\sqrt{z} + \sqrt{x}}{\sqrt{z} + \sqrt{x}} = \lim_{z \rightarrow x} \frac{z - x}{(z - x)(\sqrt{z} + \sqrt{x})}$$

$$= \lim_{z \rightarrow x} \frac{1}{\sqrt{z} + \sqrt{x}} = \frac{1}{2\sqrt{x}}$$

27. Note that as x increases, the slope of the tangent line to the curve is first negative, then zero (when $x = 0$), then positive \Rightarrow the slope is always increasing which matches (b).

28. Note that the slope of the tangent line is never negative. For x negative, $f_2'(x)$ is positive but decreasing as x increases. When $x = 0$, the slope of the tangent line to x is 0. For $x > 0$, $f_2'(x)$ is positive and increasing. This graph matches (a).

29. $f_3(x)$ is an oscillating function like the cosine. Everywhere that the graph of f_3 has a horizontal tangent we expect f_3' to be zero, and (d) matches this condition.

30. The graph matches with (c).

31. (a) f' is not defined at $x = 0, 1, 4$. At these points, the left-hand and right-hand derivatives do not agree. For example, $\lim_{x \rightarrow 0^-} \frac{f(x) - f(0)}{x - 0} = \text{slope of line joining } (-4, 0) \text{ and } (0, 2) = \frac{1}{2}$ but $\lim_{x \rightarrow 0^+} \frac{f(x) - f(0)}{x - 0} = \text{slope of line joining } (0, 2) \text{ and } (1, -2) = -4$. Since these values are not equal, $f'(0) = \lim_{x \rightarrow 0} \frac{f(x) - f(0)}{x - 0}$ does not exist.

(b)

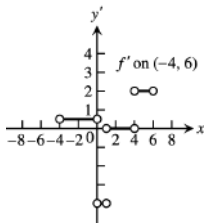

32. (a)

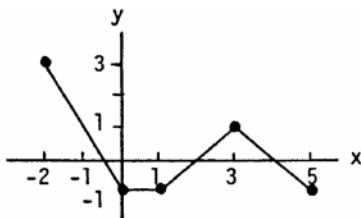

(b) Shift the graph in (a) down 3 units

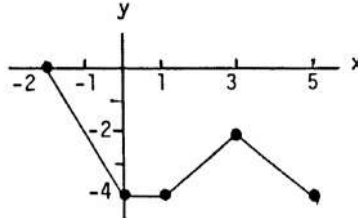

33.

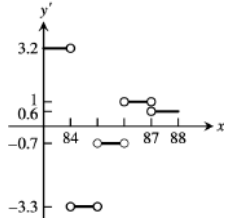

34. (a)

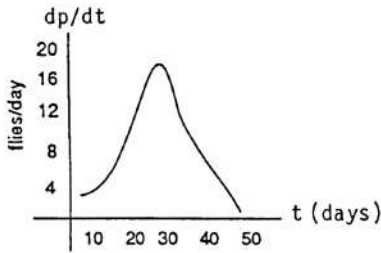

(b) The fastest is between the 20th and 30th days;
slowest is between the 40th and 50th days.

35. Left-hand derivative: For $h < 0$, $f(0+h) = f(h) = h^2$ (using $y = x^2$ curve) $\Rightarrow \lim_{h \rightarrow 0^-} \frac{f(0+h)-f(0)}{h}$
 $= \lim_{h \rightarrow 0^-} \frac{h^2-0}{h} = \lim_{h \rightarrow 0^-} h = 0$;

Right-hand derivative: For $h > 0$, $f(0+h) = f(h) = h$ (using $y = x$ curve) $\Rightarrow \lim_{h \rightarrow 0^+} \frac{f(0+h)-f(0)}{h}$
 $= \lim_{h \rightarrow 0^+} \frac{h-0}{h} = \lim_{h \rightarrow 0^+} 1 = 1$;

Then $\lim_{h \rightarrow 0^-} \frac{f(0+h)-f(0)}{h} \neq \lim_{h \rightarrow 0^+} \frac{f(0+h)-f(0)}{h} \Rightarrow$ the derivative $f'(0)$ does not exist.

36. Left-hand derivative: When $h < 0$, $1+h < 1 \Rightarrow f(1+h) = 2 \Rightarrow \lim_{h \rightarrow 0^-} \frac{f(1+h)-f(1)}{h} = \lim_{h \rightarrow 0^-} \frac{2-2}{h}$
 $= \lim_{h \rightarrow 0^-} 0 = 0$;

Right-hand derivative: When $h > 0$, $1+h > 1 \Rightarrow f(1+h) = 2(1+h) = 2+2h \Rightarrow \lim_{h \rightarrow 0^+} \frac{f(1+h)-f(1)}{h}$
 $= \lim_{h \rightarrow 0^+} \frac{(2+2h)-2}{h} = \lim_{h \rightarrow 0^+} \frac{2h}{h} = \lim_{h \rightarrow 0^+} 2 = 2$;

Then $\lim_{h \rightarrow 0^-} \frac{f(1+h)-f(1)}{h} \neq \lim_{h \rightarrow 0^+} \frac{f(1+h)-f(1)}{h} \Rightarrow$ the derivative $f'(1)$ does not exist.

37. Left-hand derivative: When $h < 0$, $1+h < 1 \Rightarrow f(1+h) = \sqrt{1+h} \Rightarrow \lim_{h \rightarrow 0^-} \frac{f(1+h)-f(1)}{h}$
 $= \lim_{h \rightarrow 0^-} \frac{\sqrt{1+h}-1}{h} = \lim_{h \rightarrow 0^-} \frac{(\sqrt{1+h}-1)}{h} \cdot \frac{(\sqrt{1+h}+1)}{(\sqrt{1+h}+1)} = \lim_{h \rightarrow 0^-} \frac{(1+h)-1}{h(\sqrt{1+h}+1)} = \lim_{h \rightarrow 0^-} \frac{1}{\sqrt{1+h}+1} = \frac{1}{2}$;

Right-hand derivative: When $h > 0$, $1+h > 1 \Rightarrow f(1+h) = 2(1+h) - 1 = 2h+1 \Rightarrow \lim_{h \rightarrow 0^+} \frac{f(1+h)-f(1)}{h}$
 $= \lim_{h \rightarrow 0^+} \frac{(2h+1)-1}{h} = \lim_{h \rightarrow 0^+} 2 = 2$;

Then $\lim_{h \rightarrow 0^-} \frac{f(1+h)-f(1)}{h} \neq \lim_{h \rightarrow 0^+} \frac{f(1+h)-f(1)}{h} \Rightarrow$ the derivative $f'(1)$ does not exist.

38. Left-hand derivative: $\lim_{h \rightarrow 0^-} \frac{f(1+h)-f(1)}{h} = \lim_{h \rightarrow 0^-} \frac{(1+h)-1}{h} = \lim_{h \rightarrow 0^-} 1 = 1$;

Right-hand derivative: $\lim_{h \rightarrow 0^+} \frac{f(1+h)-f(1)}{h} = \lim_{h \rightarrow 0^+} \frac{(\frac{1}{1+h}-1)}{h} = \lim_{h \rightarrow 0^+} \frac{(1-(1+h))}{h(1+h)}$
 $= \lim_{h \rightarrow 0^+} \frac{-h}{h(1+h)} = \lim_{h \rightarrow 0^+} \frac{-1}{1+h} = -1$;

Then $\lim_{h \rightarrow 0^-} \frac{f(1+h)-f(1)}{h} \neq \lim_{h \rightarrow 0^+} \frac{f(1+h)-f(1)}{h} \Rightarrow$ the derivative $f'(1)$ does not exist.

39. (a) The function is differentiable on its domain $-3 \leq x \leq 2$ (it is smooth)
 (b) none
 (c) none

40. (a) The function is differentiable on its domain $-2 \leq x \leq 3$ (it is smooth)
 (b) none
 (c) none

41. (a) The function is differentiable on $-3 \leq x < 0$ and $0 < x \leq 3$
 (b) none
 (c) The function is neither continuous nor differentiable at $x = 0$ since $\lim_{x \rightarrow 0^-} f(x) \neq \lim_{x \rightarrow 0^+} f(x)$

42. (a) f is differentiable on $-2 \leq x < -1$, $-1 < x < 0$, $0 < x < 2$, and $2 < x \leq 3$
 (b) f is continuous but not differentiable at $x = -1$: $\lim_{x \rightarrow -1} f(x) = 0$ exists but there is a corner at $x = -1$ since

$$\lim_{h \rightarrow 0^-} \frac{f(-1+h) - f(-1)}{h} = -3 \text{ and } \lim_{h \rightarrow 0^+} \frac{f(-1+h) - f(-1)}{h} = 3 \Rightarrow f'(-1) \text{ does not exist}$$

 (c) f is neither continuous nor differentiable at $x = 0$ and $x = 2$:
 at $x = 0$, $\lim_{x \rightarrow 0^-} f(x) = 3$ but $\lim_{x \rightarrow 0^+} f(x) = 0 \Rightarrow \lim_{x \rightarrow 0} f(x)$ does not exist;
 at $x = 2$, $\lim_{x \rightarrow 2} f(x)$ exists but $\lim_{x \rightarrow 2} f(x) \neq f(2)$

43. (a) f is differentiable on $-1 \leq x < 0$ and $0 < x \leq 2$
 (b) f is continuous but not differentiable at $x = 0$: $\lim_{x \rightarrow 0} f(x) = 0$ exists but there is a cusp at $x = 0$, so

$$f'(0) = \lim_{h \rightarrow 0} \frac{f(0+h) - f(0)}{h}$$
 does not exist
 (c) none

44. (a) f is differentiable on $-3 \leq x < -2$, $-2 < x < 2$, and $2 < x \leq 3$
 (b) f is continuous but not differentiable at $x = -2$ and $x = 2$: there are corners at those points
 (c) none

45. (a) $f'(x) = \lim_{h \rightarrow 0} \frac{f(x+h) - f(x)}{h} = \lim_{h \rightarrow 0} \frac{-(x+h)^2 - (-x^2)}{h} = \lim_{h \rightarrow 0} \frac{-x^2 - 2xh - h^2 + x^2}{h} = \lim_{h \rightarrow 0} (-2x - h) = -2x$

(b)

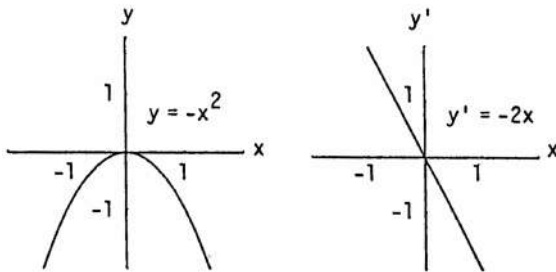

- (c) $y' = -2x$ is positive for $x < 0$, y' is zero when $x = 0$, y' is negative when $x > 0$
 (d) $y = -x^2$ is increasing for $-\infty < x < 0$ and decreasing for $0 < x < \infty$; the function is increasing on intervals where $y' > 0$ and decreasing on intervals where $y' < 0$

46. (a) $f'(x) = \lim_{h \rightarrow 0} \frac{f(x+h) - f(x)}{h} = \lim_{h \rightarrow 0} \frac{\left(\frac{-1}{x+h} - \frac{-1}{x}\right)}{h} = \lim_{h \rightarrow 0} \frac{-x + (x+h)}{x(x+h)h} = \lim_{h \rightarrow 0} \frac{1}{x(x+h)} = \frac{1}{x^2}$

(b)

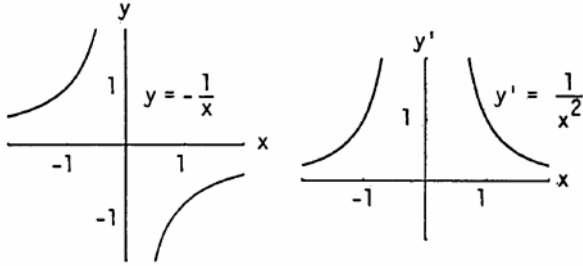

(c) y' is positive for all $x \neq 0$, y' is never 0, y' is never negative

(d) $y = -\frac{1}{x}$ is increasing for $-\infty < x < 0$ and $0 < x < \infty$

47. (a) Using the alternate formula for calculating derivatives: $f'(x) = \lim_{z \rightarrow x} \frac{f(z) - f(x)}{z - x} = \lim_{z \rightarrow x} \frac{\left(\frac{z^3}{3} - \frac{x^3}{3}\right)}{z - x}$
 $= \lim_{z \rightarrow x} \frac{z^3 - x^3}{3(z - x)} = \lim_{z \rightarrow x} \frac{(z - x)(z^2 + zx + x^2)}{3(z - x)} = \lim_{z \rightarrow x} \frac{z^2 + zx + x^2}{3} = x^2 \Rightarrow f'(x) = x^2$

(b)

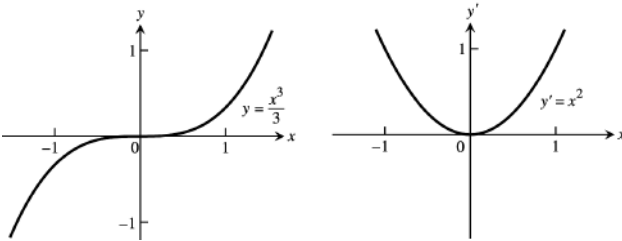

(c) y' is positive for all $x \neq 0$, and $y' = 0$ when $x = 0$; y' is never negative

(d) $y = \frac{x^3}{3}$ is increasing for all $x \neq 0$ (the graph is horizontal at $x = 0$) because y is increasing where $y' > 0$; y is never decreasing

48. (a) Using the alternate form for calculating derivatives: $f'(x) = \lim_{z \rightarrow x} \frac{f(z) - f(x)}{z - x} = \lim_{z \rightarrow x} \frac{\left(\frac{z^4}{4} - \frac{x^4}{4}\right)}{z - x}$
 $= \lim_{z \rightarrow x} \frac{z^4 - x^4}{4(z - x)} = \lim_{z \rightarrow x} \frac{(z - x)(z^3 + xz^2 + x^2z + x^3)}{4(z - x)} = \lim_{z \rightarrow x} \frac{z^3 + xz^2 + x^2z + x^3}{4} = x^3 \Rightarrow f'(x) = x^3$

(b)

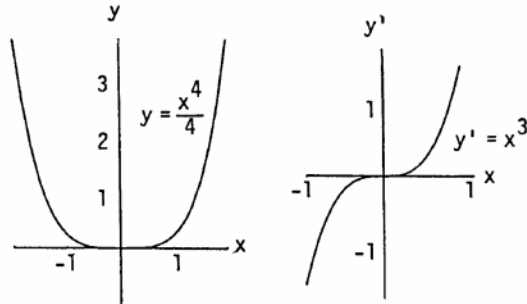

(c) y' is positive for $x > 0$, y' is zero for $x = 0$, y' is negative for $x < 0$

(d) $y = \frac{x^4}{4}$ is increasing on $0 < x < \infty$ and decreasing on $-\infty < x < 0$

49. $y' = \lim_{x \rightarrow c} \frac{f(x) - f(c)}{x - c} = \lim_{x \rightarrow c} \frac{x^3 - c^3}{x - c} = \lim_{x \rightarrow c} \frac{(x - c)(x^2 + xc + c^2)}{x - c} = \lim_{x \rightarrow c} (x^2 + xc + c^2) = 3c^2$.

The slope of the curve $y = x^3$ at $x = c$ is $y' = 3c^2$. Notice that $3c^2 \geq 0$ for all $c \Rightarrow y = x^3$ never has a negative slope.

50. Horizontal tangents occur where $y' = 0$. Thus, $y' = \lim_{h \rightarrow 0} \frac{2\sqrt{x+h} - 2\sqrt{x}}{h}$

$$= \lim_{h \rightarrow 0} \frac{2(\sqrt{x+h} - \sqrt{x})}{h} \cdot \frac{(\sqrt{x+h} + \sqrt{x})}{(\sqrt{x+h} + \sqrt{x})} = \lim_{h \rightarrow 0} \frac{2((x+h) - x)}{h(\sqrt{x+h} + \sqrt{x})} = \lim_{h \rightarrow 0} \frac{2}{\sqrt{x+h} + \sqrt{x}} = \frac{1}{\sqrt{x}}.$$

Then $y' = 0$ when $\frac{1}{\sqrt{x}} = 0$ which is never true \Rightarrow the curve has no horizontal tangents.

$$51. y' = \lim_{h \rightarrow 0} \frac{(2(x+h)^2 - 13(x+h) + 5) - (2x^2 - 13x + 5)}{h} = \lim_{h \rightarrow 0} \frac{2x^2 + 4xh + 2h^2 - 13x - 13h + 5 - 2x^2 + 13x - 5}{h}$$

$$= \lim_{h \rightarrow 0} \frac{4xh + 2h^2 - 13h}{h} = \lim_{h \rightarrow 0} (4x + 2h - 13) = 4x - 13, \text{ slope at } x. \text{ The slope is } -1 \text{ when } 4x - 13 = -1$$

$$\Rightarrow 4x = 12 \Rightarrow x = 3 \Rightarrow y = 2 \cdot 3^2 - 13 \cdot 3 + 5 = -16. \text{ Thus the tangent line is } y + 16 = (-1)(x - 3)$$

$$\Rightarrow y = -x - 13 \text{ and the point of tangency is } (3, -16).$$

$$52. \text{ For the curve } y = \sqrt{x}, \text{ we have } y' = \lim_{h \rightarrow 0} \frac{(\sqrt{x+h} - \sqrt{x})}{h} \cdot \frac{(\sqrt{x+h} + \sqrt{x})}{(\sqrt{x+h} + \sqrt{x})} = \lim_{h \rightarrow 0} \frac{(x+h) - x}{(\sqrt{x+h} + \sqrt{x})h}$$

$$= \lim_{h \rightarrow 0} \frac{1}{\sqrt{x+h} + \sqrt{x}} = \frac{1}{2\sqrt{x}}. \text{ Suppose } (a, \sqrt{a}) \text{ is the point of tangency of such a line and } (-1, 0) \text{ is the point}$$

on the line where it crosses the x -axis. Then the slope of the line is $\frac{\sqrt{a} - 0}{a - (-1)} = \frac{\sqrt{a}}{a+1}$ which must also equal $\frac{1}{2\sqrt{a}}$; using the derivative formula at $x = a \Rightarrow \frac{\sqrt{a}}{a+1} = \frac{1}{2\sqrt{a}} \Rightarrow 2a = a + 1 \Rightarrow a = 1$. Thus such a line does exist: its point of tangency is $(1, 1)$, its slope is $\frac{1}{2\sqrt{a}} = \frac{1}{2}$; and an equation of the line is $y - 1 = \frac{1}{2}(x - 1)$

$$\Rightarrow y = \frac{1}{2}x + \frac{1}{2}.$$

53. No. Derivatives of functions have the intermediate value property. The function $f(x) = \lfloor x \rfloor$ satisfies $f(0) = 0$ and $f(1) = 1$ but does not take on the value $\frac{1}{2}$ anywhere in $[0, 1] \Rightarrow f$ does not have the intermediate value property. Thus f cannot be the derivative of any function on $[0, 1] \Rightarrow f$ cannot be the derivative of any function on $(-\infty, \infty)$.

54. The graphs are the same. So we know that for $f(x) = |x|$, we have $f'(x) = \frac{|x|}{x}$.

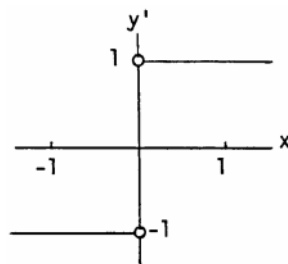

55. Yes; the derivative of $-f$ is $-f'$ so that $f'(x_0)$ exists $\Rightarrow -f'(x_0)$ exists as well.

56. Yes; the derivative of $3g$ is $3g'$ so that $g'(7)$ exists $\Rightarrow 3g'(7)$ exists as well.

57. Yes, $\lim_{t \rightarrow 0} \frac{g(t)}{h(t)}$ can exist but it need not equal zero. For example, let $g(t) = mt$ and $h(t) = t$. Then $g(0) = h(0) = 0$, but $\lim_{t \rightarrow 0} \frac{g(t)}{h(t)} = \lim_{t \rightarrow 0} \frac{mt}{t} = \lim_{t \rightarrow 0} m = m$, which need not be zero.

58. (a) Suppose $|f(x)| \leq x^2$ for $-1 \leq x \leq 1$. Then $|f(0)| \leq 0^2 \Rightarrow f(0) = 0$. Then $f'(0) = \lim_{h \rightarrow 0} \frac{f(0+h) - f(0)}{h}$

$$= \lim_{h \rightarrow 0} \frac{f(h) - 0}{h} = \lim_{h \rightarrow 0} \frac{f(h)}{h}. \text{ For } |h| \leq 1, -h^2 \leq f(h) \leq h^2 \Rightarrow -h \leq \frac{f(h)}{h} \leq h \Rightarrow f'(0) = \lim_{h \rightarrow 0} \frac{f(h)}{h} = 0$$

by the Sandwich Theorem for limits.

(b) Note that for $x \neq 0$, $|f(x)| = |x^2 \sin \frac{1}{x}| = |x^2| |\sin x| \leq |x^2| \cdot 1 = x^2$ (since $-1 \leq \sin x \leq 1$). By part (a), f is differentiable at $x = 0$ and $f'(0) = 0$.

59. The graphs are shown below for $h = 1, 0.5, 0.1$. The function $y = \frac{1}{2\sqrt{x}}$ is the derivative of the function

$$y = \sqrt{x} \text{ so that } \frac{1}{2\sqrt{x}} = \lim_{h \rightarrow 0} \frac{\sqrt{x+h} - \sqrt{x}}{h}. \text{ The graphs reveal that } y = \frac{\sqrt{x+h} - \sqrt{x}}{h} \text{ gets closer to } y = \frac{1}{2\sqrt{x}}$$

as h gets smaller and smaller.

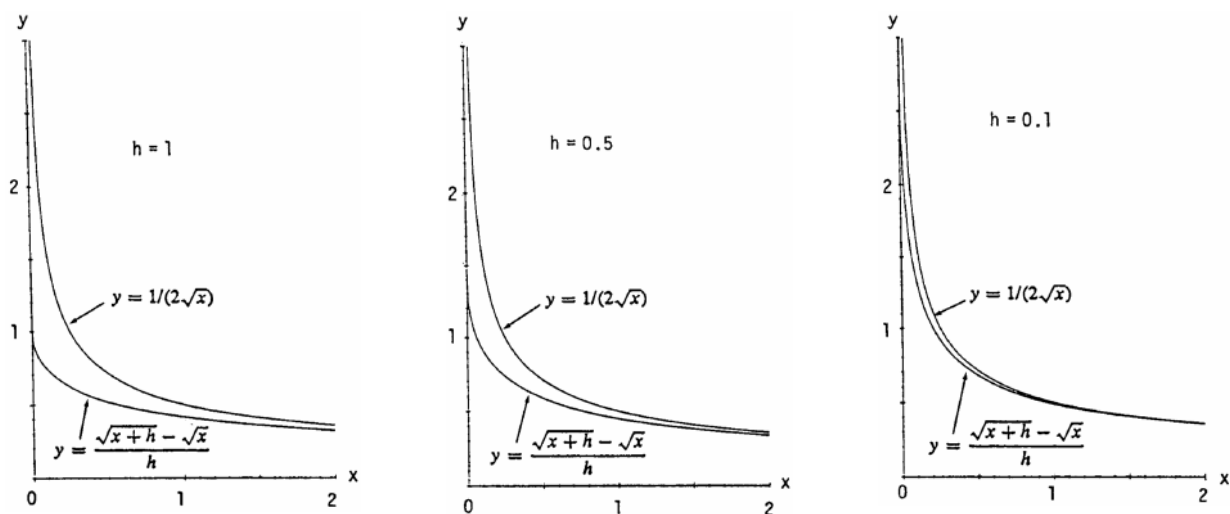

60. The graphs are shown below for $h = 2, 1, 0.5$. The function $y = 3x^2$ is the derivative of the function $y = x^3$ so that $3x^2 = \lim_{h \rightarrow 0} \frac{(x+h)^3 - x^3}{h}$. The graphs reveal that $y = \frac{(x+h)^3 - x^3}{h}$ gets closer to $y = 3x^2$ as h gets smaller and smaller.

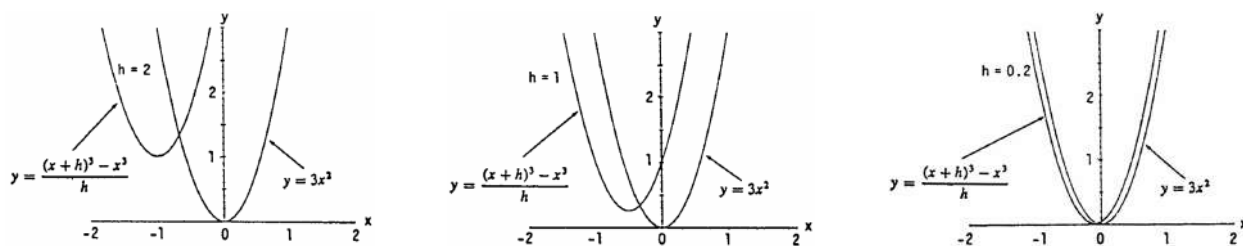

61. Weierstrass's nowhere differentiable continuous function.

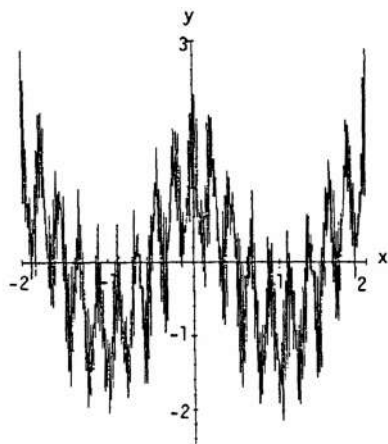

$$g(x) = \cos(\pi x) + \left(\frac{2}{3}\right)^1 \cos(9\pi x) + \left(\frac{2}{3}\right)^2 \cos(9^2\pi x) + \left(\frac{2}{3}\right)^3 \cos(9^3\pi x) + \dots + \left(\frac{2}{3}\right)^7 \cos(9^7\pi x)$$

- 62-67. Example CAS commands:

Maple:

```
f := x -> x^3 + x^2 - x;
```

```

x0 := 1;
plot( f(x), x=x0-5..x0+2, color=black,
      title="Section 3_1, #62(a)" );
q := unapply( (f(x+h)-f(x))/h, (x,h) );          # (b)
L := limit( q(x,h), h=0 );                       # (c)
m := eval( L, x=x0 );
tan_line := f(x0) + m*(x-x0);
plot( [f(x),tan_line], x=x0-2..x0+3, color=black,
      linestyle=[1,7], title="Section 3.1 #62(d)",
      legend=["y=f(x)", "Tangent line at x=1" ] );
Xvals := sort( [ x0+2^(-k) $ k=0..5, x0-2^(-k) $ k=0..5 ] );    # (e)
Yvals := map( f, Xvals );
evalf[4]( < convert(Xvals,Matrix) , convert(Yvals,Matrix) > );
plot( L, x=x0-5..x0+3, color=black, title="Section 3.1 #62(f)" );

```

Mathematica: (functions and x0 may vary) (see section 2.5 re. RealOnly):

```

<<Miscellaneous`RealOnly`
Clear[f, m, x, y, h]
x0 = π / 4;
f[x_] := x^2 Cos[x]
Plot[f[x], {x, x0 - 3, x0 + 3}]
q[x_, h_] := (f[x + h] - f[x]) / h
m[x_] := Limit[q[x, h], h -> 0]
ytan := f[x0] + m[x0] (x - x0)
Plot[{f[x], ytan}, {x, x0 - 3, x0 + 3}]
m[x0 - 1] / N
m[x0 + 1] / N
Plot[{f[x], m[x]}, {x, x0 - 3, x0 + 3}]

```

3.2 DIFFERENTIATION RULES

- $y = -x^2 + 3 \Rightarrow \frac{dy}{dx} = \frac{d}{dx}(-x^2) + \frac{d}{dx}(3) = -2x + 0 = -2x \Rightarrow \frac{d^2y}{dx^2} = -2$
- $y = x^2 + x + 8 \Rightarrow \frac{dy}{dx} = 2x + 1 + 0 = 2x + 1 \Rightarrow \frac{d^2y}{dx^2} = 2$
- $s = 5t^3 - 3t^5 \Rightarrow \frac{ds}{dt} = \frac{d}{dt}(5t^3) - \frac{d}{dt}(3t^5) = 15t^2 - 15t^4 \Rightarrow \frac{d^2s}{dt^2} = \frac{d}{dt}(15t^2) - \frac{d}{dt}(15t^4) = 30t - 60t^3$
- $w = 3z^7 - 7z^3 + 21z^2 \Rightarrow \frac{dw}{dz} = 21z^6 - 21z^2 + 42z \Rightarrow \frac{d^2w}{dz^2} = 126z^5 - 42z + 42$
- $y = \frac{4}{3}x^3 - x \Rightarrow \frac{dy}{dx} = 4x^2 - 1 \Rightarrow \frac{d^2y}{dx^2} = 8x$
- $y = \frac{x^3}{3} + \frac{x^2}{2} + \frac{x}{4} \Rightarrow \frac{dy}{dx} = x^2 + x + \frac{1}{4} \Rightarrow \frac{d^2y}{dx^2} = 2x + 1 + 0 = 2x + 1$
- $w = 3z^{-2} - z^{-1} \Rightarrow \frac{dw}{dz} = -6z^{-3} + z^{-2} = \frac{-6}{z^3} + \frac{1}{z^2} \Rightarrow \frac{d^2w}{dz^2} = 18z^{-4} - 2z^{-3} = \frac{18}{z^4} - \frac{2}{z^3}$
- $s = -2t^{-1} + 4t^{-2} \Rightarrow \frac{ds}{dt} = 2t^{-2} - 8t^{-3} = \frac{2}{t^2} - \frac{8}{t^3} \Rightarrow \frac{d^2s}{dt^2} = -4t^{-3} + 24t^{-4} = \frac{-4}{t^3} + \frac{24}{t^4}$
- $y = 6x^2 - 10x - 5x^{-2} \Rightarrow \frac{dy}{dx} = 12x - 10 + 10x^{-3} = 12x - 10 + \frac{10}{x^3} \Rightarrow \frac{d^2y}{dx^2} = 12 - 0 - 30x^{-4} = 12 - \frac{30}{x^4}$

$$10. y = 4 - 2x - x^{-3} \Rightarrow \frac{dy}{dx} = -2 + 3x^{-4} = -2 + \frac{3}{x^4} \Rightarrow \frac{d^2y}{dx^2} = 0 - 12x^{-5} = \frac{-12}{x^5}$$

$$11. r = \frac{1}{3}s^{-2} - \frac{5}{2}s^{-1} \Rightarrow \frac{dr}{ds} = -\frac{2}{3}s^{-3} + \frac{5}{2}s^{-2} = \frac{-2}{3s^3} + \frac{5}{2s^2} \Rightarrow \frac{d^2r}{ds^2} = 2s^{-4} - 5s^{-3} = \frac{2}{s^4} - \frac{5}{s^3}$$

$$12. r = 12\theta^{-1} - 4\theta^{-3} + \theta^{-4} \Rightarrow \frac{dr}{d\theta} = -12\theta^{-2} + 12\theta^{-4} - 4\theta^{-5} = \frac{-12}{\theta^2} + \frac{12}{\theta^4} - \frac{4}{\theta^5} \Rightarrow \frac{d^2r}{d\theta^2} = 24\theta^{-3} - 48\theta^{-5} + 20\theta^{-6} \\ = \frac{24}{\theta^3} - \frac{48}{\theta^5} + \frac{20}{\theta^6}$$

$$13. (a) y = (3 - x^2)(x^3 - x + 1) \Rightarrow y' = (3 - x^2) \cdot \frac{d}{dx}(x^3 - x + 1) + (x^3 - x + 1) \cdot \frac{d}{dx}(3 - x^2) \\ = (3 - x^2)(3x^2 - 1) + (x^3 - x + 1)(-2x) = -5x^4 + 12x^2 - 2x - 3$$

$$(b) y = -x^5 + 4x^3 - x^2 - 3x + 3 \Rightarrow y' = -5x^4 + 12x^2 - 2x - 3$$

$$14. (a) y = (x - 1)(x^2 + x + 1) \Rightarrow y' = (x - 1)(2x + 1) + (x^2 + x + 1)(1) = 3x^2$$

$$(b) y = (x - 1)(x^2 + x + 1) = x^3 - 1 \Rightarrow y' = 3x^2$$

$$15. (a) y = (x^2 + 1)\left(x + 5 + \frac{1}{x}\right) \Rightarrow y' = (x^2 + 1) \cdot \frac{d}{dx}\left(x + 5 + \frac{1}{x}\right) + \left(x + 5 + \frac{1}{x}\right) \cdot \frac{d}{dx}(x^2 + 1)$$

$$= (x^2 + 1)(1 - x^{-2}) + \left(x + 5 + x^{-1}\right)(2x) = (x^2 - 1 + 1 - x^{-2}) + (2x^2 + 10x + 2) = 3x^2 + 10x + 2 - \frac{1}{x^2}$$

$$(b) y = x^3 + 5x^2 + 2x + 5 + \frac{1}{x} \Rightarrow y' = 3x^2 + 10x + 2 - \frac{1}{x^2}$$

$$16. y = \left(x + \frac{1}{x}\right)\left(x - \frac{1}{x} + 1\right)$$

$$(a) y' = \left(x + x^{-1}\right) \cdot \left(1 + x^{-2}\right) + \left(x - x^{-1} + 1\right)\left(1 - x^{-2}\right) = 2x + 1 - \frac{1}{x^3} + \frac{2}{x^3}$$

$$(b) y = x^2 + x + \frac{1}{x} - \frac{1}{x^2} \Rightarrow y' = 2x + 1 - \frac{1}{x^2} + \frac{2}{x^3}$$

$$17. y = \frac{2x+5}{3x-2}; \text{ use the quotient rule: } u = 2x + 5 \text{ and } v = 3x - 2 \Rightarrow u' = 2 \text{ and } v' = 3 \Rightarrow y' = \frac{vu' - uv'}{v^2} \\ = \frac{(3x-2)(2) - (2x+5)(3)}{(3x-2)^2} = \frac{6x-4-6x-15}{(3x-2)^2} = \frac{-19}{(3x-2)^2}$$

$$18. z = \frac{2x+1}{x^2-1} \Rightarrow \frac{dz}{dx} = \frac{(x^2-1)(2) - (2x+1)(2x)}{(x^2-1)^2} = \frac{2x^2-2-4x^2-2x}{(x^2-1)^2} = \frac{-2x^2-2x-2}{(x^2-1)^2} = \frac{-2(x^2+x+1)}{(x^2-1)^2}$$

$$19. g(x) = \frac{x^2-4}{x+0.5}; \text{ use the quotient rule: } u = x^2 - 4 \text{ and } v = x + 0.5 \Rightarrow u' = 2x \text{ and } v' = 1 \Rightarrow g'(x) = \frac{vu' - uv'}{v^2} \\ = \frac{(x+0.5)(2x) - (x^2-4)(1)}{(x+0.5)^2} = \frac{2x^2+x-x^2+4}{(x+0.5)^2} = \frac{x^2+x+4}{(x+0.5)^2}$$

$$20. f(t) = \frac{t^2-1}{t^2+t-2} = \frac{(t-1)(t+1)}{(t+2)(t-1)} = \frac{t+1}{t+2}, t \neq 1 \Rightarrow f'(t) = \frac{(t+2)(1) - (t+1)(1)}{(t+2)^2} = \frac{t+2-t-1}{(t+2)^2} = \frac{1}{(t+2)^2}$$

$$21. v = (1-t)(1+t^2)^{-1} = \frac{1-t}{1+t^2} \Rightarrow \frac{dv}{dt} = \frac{(1+t^2)(-1) - (1-t)(2t)}{(1+t^2)^2} = \frac{-1-t^2-2t+2t^2}{(1+t^2)^2} = \frac{t^2-2t-1}{(1+t^2)^2}$$

$$22. w = \frac{x+5}{2x-7} \Rightarrow w' = \frac{(2x-7)(1) - (x+5)(2)}{(2x-7)^2} = \frac{2x-7-2x-10}{(2x-7)^2} = \frac{-17}{(2x-7)^2}$$

$$23. f(s) = \frac{\sqrt{s}-1}{\sqrt{s}+1} \Rightarrow f'(s) = \frac{(\sqrt{s}+1)\left(\frac{1}{2\sqrt{s}}\right) - (\sqrt{s}-1)\left(\frac{1}{2\sqrt{s}}\right)}{(\sqrt{s}+1)^2} = \frac{(\sqrt{s}+1) - (\sqrt{s}-1)}{2\sqrt{s}(\sqrt{s}+1)^2} = \frac{1}{\sqrt{s}(\sqrt{s}+1)^2}$$

NOTE: $\frac{d}{ds}(\sqrt{s}) = \frac{1}{2\sqrt{s}}$ from Example 2 in Section 2.1

$$24. u = \frac{5x+1}{2\sqrt{x}} \Rightarrow \frac{du}{dx} = \frac{(2\sqrt{x})(5) - (5x+1)\left(\frac{1}{\sqrt{x}}\right)}{4x} = \frac{5x-1}{4x^{3/2}}$$

$$25. v = \frac{1+x-4\sqrt{x}}{x} \Rightarrow v' = \frac{x(1-\frac{2}{\sqrt{x}}) - (1+x-4\sqrt{x})}{x^2} = \frac{2\sqrt{x}-1}{x^2}$$

$$26. r = 2\left(\frac{1}{\sqrt{\theta}} + \sqrt{\theta}\right) \Rightarrow r' = 2\left(\frac{\sqrt{\theta}(0)-1\left(\frac{1}{2\sqrt{\theta}}\right)}{\theta} + \frac{1}{2\sqrt{\theta}}\right) = -\frac{1}{\theta^{3/2}} + \frac{1}{\theta^{1/2}}$$

$$27. y = \frac{1}{(x^2-1)(x^2+x+1)}; \text{ use the quotient rule: } u = 1 \text{ and } v = (x^2-1)(x^2+x+1) \Rightarrow u' = 0 \text{ and}$$

$$v' = (x^2-1)(2x+1) + (x^2+x+1)(2x) = 2x^3+x^2-2x-1+2x^3+2x^2+2x = 4x^3+3x^2-1$$

$$\Rightarrow \frac{dy}{dx} = \frac{vu' - uv'}{v^2} = \frac{0-1(4x^3+3x^2-1)}{(x^2-1)^2(x^2+x+1)^2} = \frac{-4x^3-3x^2+1}{(x^2-1)^2(x^2+x+1)^2}$$

$$28. y = \frac{(x+1)(x+2)}{(x-1)(x-2)} = \frac{x^2+3x+2}{x^2-3x+2} \Rightarrow y' = \frac{(x^2-3x+2)(2x+3) - (x^2+3x+2)(2x-3)}{(x-1)^2(x-2)^2} = \frac{-6x^2+12}{(x-1)^2(x-2)^2}$$

$$= \frac{-6(x^2-2)}{(x-1)^2(x-2)^2}$$

$$29. y = \frac{1}{2}x^4 - \frac{3}{2}x^2 - x \Rightarrow y' = 2x^3 - 3x - 1 \Rightarrow y'' = 6x^2 - 3 \Rightarrow y''' = 12x \Rightarrow y^{(4)} = 12 \Rightarrow y^{(n)} = 0 \text{ for all } n \geq 5$$

$$30. y = \frac{1}{120}x^5 \Rightarrow y' = \frac{1}{24}x^4 \Rightarrow y'' = \frac{1}{6}x^3 \Rightarrow y''' = \frac{1}{2}x^2 \Rightarrow y^{(4)} = x \Rightarrow y^{(5)} = 1 \Rightarrow y^{(n)} = 0 \text{ for all } n \geq 6$$

$$31. y = \frac{x^3+7}{x} = x^2 + 7x^{-1} \Rightarrow \frac{dy}{dx} = 2x - 7x^{-2} = 2x - \frac{7}{x^2} \Rightarrow \frac{d^2y}{dx^2} = 2 + 14x^{-3} = 2 + \frac{14}{x^3}$$

$$32. s = \frac{t^2+5t-1}{t^2} = 1 + \frac{5}{t} - \frac{1}{t^2} = 1 + 5t^{-1} - t^{-2} \Rightarrow \frac{ds}{dt} = 0 - 5t^{-2} + 2t^{-3} = -5t^{-2} + 2t^{-3} = \frac{-5}{t^2} + \frac{2}{t^3}$$

$$\Rightarrow \frac{d^2s}{dt^2} = 10t^{-3} - 6t^{-4} = \frac{10}{t^3} - \frac{6}{t^4}$$

$$33. r = \frac{(\theta-1)(\theta^2+\theta+1)}{\theta^3} = \frac{\theta^3-1}{\theta^3} = 1 - \frac{1}{\theta^3} = 1 - \theta^{-3} \Rightarrow \frac{dr}{d\theta} = 0 + 3\theta^{-4} = 3\theta^{-4} = \frac{3}{\theta^4} \Rightarrow \frac{d^2r}{d\theta^2} = -12\theta^{-5} = \frac{-12}{\theta^5}$$

$$34. u = \frac{(x^2+x)(x^2-x+1)}{x^4} = \frac{x(x+1)(x^2-x+1)}{x^4} = \frac{x(x^3+1)}{x^4} = \frac{x^4+x}{x^4} = 1 + \frac{x}{x^4} = 1 + x^{-3}$$

$$\Rightarrow \frac{du}{dx} = 0 - 3x^{-4} = -3x^{-4} = \frac{-3}{x^4} \Rightarrow \frac{d^2u}{dx^2} = 12x^{-5} = \frac{12}{x^5}$$

$$35. w = \left(\frac{1+3z}{3z}\right)(3-z) = \left(\frac{1}{3}z^{-1} + 1\right)(3-z) = z^{-1} - \frac{1}{3} + 3 - z = z^{-1} + \frac{8}{3} - z \Rightarrow \frac{dw}{dz} = -z^{-2} + 0 - 1 = -z^{-2} - 1$$

$$= \frac{-1}{z^2} - 1 \Rightarrow \frac{d^2w}{dz^2} = 2z^{-3} - 0 = 2z^{-3} = \frac{2}{z^3}$$

$$36. w = (z+1)(z-1)(z^2+1) = (z^2-1)(z^2+1) = z^4-1 \Rightarrow \frac{dw}{dz} = 4z^3 - 0 = 4z^3 \Rightarrow \frac{d^2w}{dz^2} = 12z^2$$

$$37. p = \left(\frac{q^2+3}{12q}\right)\left(\frac{q^4-1}{q^3}\right) = \frac{q^6-q^2+3q^4-3}{12q^4} = \frac{1}{12}q^2 - \frac{1}{12}q^{-2} + \frac{1}{4} - \frac{1}{4}q^{-4} \Rightarrow \frac{dp}{dq} = \frac{1}{6}q + \frac{1}{6}q^{-3} + q^{-5} = \frac{1}{6}q + \frac{1}{6q^3} + \frac{1}{q^5}$$

$$\Rightarrow \frac{d^2p}{dq^2} = \frac{1}{6} - \frac{1}{2}q^{-4} - 5q^{-6} = \frac{1}{6} - \frac{1}{2q^4} - \frac{5}{q^6}$$

$$38. p = \frac{q^2+3}{(q-1)^3+(q+1)^3} = \frac{q^2+3}{(q^3-3q^2+3q-1)+(q^3+3q^2+3q+1)} = \frac{q^2+3}{2q^3+6q} = \frac{q^2+3}{2q(q^2+3)} = \frac{1}{2q} = \frac{1}{2}q^{-1}$$

$$\Rightarrow \frac{dp}{dq} = -\frac{1}{2}q^{-2} = -\frac{1}{2q^2} \Rightarrow \frac{d^2p}{dq^2} = q^{-3} = \frac{1}{q^3}$$

$$39. u(0) = 5, u'(0) = -3, v(0) = -1, v'(0) = 2$$

$$(a) \frac{d}{dx}(uv) = uv' + vu' \Rightarrow \left.\frac{d}{dx}(uv)\right|_{x=0} = u(0)v'(0) + v(0)u'(0) = 5 \cdot 2 + (-1)(-3) = 13$$

$$(b) \frac{d}{dx}\left(\frac{u}{v}\right) = \frac{vu' - uv'}{v^2} \Rightarrow \left.\frac{d}{dx}\left(\frac{u}{v}\right)\right|_{x=0} = \frac{v(0)u'(0) - u(0)v'(0)}{(v(0))^2} = \frac{(-1)(-3) - (5)(2)}{(-1)^2} = -7$$

$$(c) \frac{d}{dx}\left(\frac{v}{u}\right) = \frac{uv' - vu'}{u^2} \Rightarrow \left.\frac{d}{dx}\left(\frac{v}{u}\right)\right|_{x=0} = \frac{u(0)v'(0) - v(0)u'(0)}{(u(0))^2} = \frac{(5)(2) - (-1)(-3)}{(5)^2} = \frac{7}{25}$$

$$(d) \frac{d}{dx}(7v - 2u) = 7v' - 2u' \Rightarrow \left. \frac{d}{dx}(7v - 2u) \right|_{x=0} = 7v'(0) - 2u'(0) = 7 \cdot 2 - 2(-3) = 20$$

$$40. u(1) = 2, u'(1) = 0, v(1) = 5, v'(1) = -1$$

$$(a) \left. \frac{d}{dx}(uv) \right|_{x=1} = u(1)v'(1) + v(1)u'(1) = 2 \cdot (-1) + 5 \cdot 0 = -2$$

$$(b) \left. \frac{d}{dx} \left(\frac{u}{v} \right) \right|_{x=1} = \frac{v(1)u'(1) - u(1)v'(1)}{(v(1))^2} = \frac{5 \cdot 0 - 2 \cdot (-1)}{(5)^2} = \frac{2}{25}$$

$$(c) \left. \frac{d}{dx} \left(\frac{v}{u} \right) \right|_{x=1} = \frac{u(1)v'(1) - v(1)u'(1)}{(u(1))^2} = \frac{2 \cdot (-1) - 5 \cdot 0}{(2)^2} = -\frac{1}{2}$$

$$(d) \left. \frac{d}{dx}(7v - 2u) \right|_{x=1} = 7v'(1) - 2u'(1) = 7 \cdot (-1) - 2 \cdot 0 = -7$$

$$41. y = x^3 - 4x + 1. \text{ Note that } (2, 1) \text{ is on the curve: } 1 = 2^3 - 4(2) + 1$$

(a) Slope of the tangent at (x, y) is $y' = 3x^2 - 4 \Rightarrow$ slope of the tangent at $(2, 1)$ is $y'(2) = 3(2)^2 - 4 = 8$. Thus the slope of the line perpendicular to the tangent at $(2, 1)$ is $-\frac{1}{8} \Rightarrow$ the equation of the line perpendicular to the tangent line at $(2, 1)$ is $y - 1 = -\frac{1}{8}(x - 2)$ or $y = -\frac{x}{8} + \frac{5}{4}$.

(b) The slope of the curve at x is $m = 3x^2 - 4$ and the smallest value for m is -4 when $x = 0$ and $y = 1$.

(c) We want the slope of the curve to be $8 \Rightarrow y' = 8 \Rightarrow 3x^2 - 4 = 8 \Rightarrow 3x^2 = 12 \Rightarrow x^2 = 4 \Rightarrow x = \pm 2$. When $x = 2, y = 1$ and the tangent line has equation $y - 1 = 8(x - 2)$ or $y = 8x - 15$; when $x = -2, y = (-2)^3 - 4(-2) + 1 = 1$, and the tangent line has equation $y - 1 = 8(x + 2)$ or $y = 8x + 17$.

42. (a) $y = x^3 - 3x - 2 \Rightarrow y' = 3x^2 - 3$. For the tangent to be horizontal, we need $m = y' = 0 \Rightarrow 0 = 3x^2 - 3 \Rightarrow 3x^2 = 3 \Rightarrow x = \pm 1$. When $x = -1, y = 0 \Rightarrow$ the tangent line has equation $y = 0$. The line perpendicular to this line at $(-1, 0)$ is $x = -1$. When $x = 1, y = -4 \Rightarrow$ the tangent line has equation $y = -4$. The line perpendicular to this line at $(1, -4)$ is $x = 1$.

(b) The smallest value of y' is -3 , and this occurs when $x = 0$ and $y = -2$. The tangent to the curve at $(0, -2)$ has slope $-3 \Rightarrow$ the line perpendicular to the tangent at $(0, -2)$ has slope $\frac{1}{3} \Rightarrow y + 2 = \frac{1}{3}(x - 0)$ or $y = \frac{1}{3}x - 2$ is an equation of the perpendicular line.

43. $y = \frac{4x}{x^2 + 1} \Rightarrow \frac{dy}{dx} = \frac{(x^2 + 1)(4) - (4x)(2x)}{(x^2 + 1)^2} = \frac{4x^2 + 4 - 8x^2}{(x^2 + 1)^2} = \frac{4(-x^2 + 1)}{(x^2 + 1)^2}$. When $x = 0, y = 0$ and $y' = \frac{4(0+1)}{1} = 4$, so the tangent to the curve at $(0, 0)$ is the line $y = 4x$. When $x = 1, y = 2 \Rightarrow y' = 0$, so the tangent to the curve at $(1, 2)$ is the line $y = 2$.

44. $y = \frac{8}{x^2 + 4} \Rightarrow y' = \frac{(x^2 + 4)(0) - 8(2x)}{(x^2 + 4)^2} = \frac{-16x}{(x^2 + 4)^2}$. When $x = 2, y = 1$ and $y' = \frac{-16(2)}{(2^2 + 4)^2} = -\frac{1}{2}$, so the tangent line to the curve at $(2, 1)$ has the equation $y - 1 = -\frac{1}{2}(x - 2)$, or $y = -\frac{x}{2} + 2$.

45. $y = ax^2 + bx + c$ passes through $(0, 0) \Rightarrow 0 = a(0) + b(0) + c \Rightarrow c = 0$; $y = ax^2 + bx$ passes through $(1, 2) \Rightarrow 2 = a + b$; $y' = 2ax + b$ and since the curve is tangent to $y = x$ at the origin, its slope is 1 at $x = 0 \Rightarrow y' = 1$ when $x = 0 \Rightarrow 1 = 2a(0) + b \Rightarrow b = 1$. Then $a + b = 2 \Rightarrow a = 1$. In summary $a = b = 1$ and $c = 0$ so the curve is $y = x^2 + x$.

46. $y = cx - x^2$ passes through $(1, 0) \Rightarrow 0 = c(1) - 1 \Rightarrow c = 1 \Rightarrow$ the curve is $y = x - x^2$. For this curve, $y' = 1 - 2x$ and $x = 1 \Rightarrow y' = -1$. Since $y = x - x^2$ and $y = x^2 + ax + b$ have common tangents at $x = 0$, $y = x^2 + ax + b$ must also have slope -1 at $x = 1$. Thus $y' = 2x + a \Rightarrow -1 = 2 \cdot 1 + a \Rightarrow a = -3 \Rightarrow y = x^2 - 3x + b$. Since this last curve passes through $(1, 0)$, we have $0 = 1 - 3 + b \Rightarrow b = 2$. In summary, $a = -3, b = 2$ and $c = 1$ so the curves are $y = x^2 - 3x + 2$ and $y = x - x^2$.

47. (a) $y = x^3 - x \Rightarrow y' = 3x^2 - 1$. When $x = -1, y = 0$ and $y' = 2 \Rightarrow$ the tangent line to the curve at $(-1, 0)$ is $y = 2(x + 1)$ or $y = 2x + 2$.

(b)

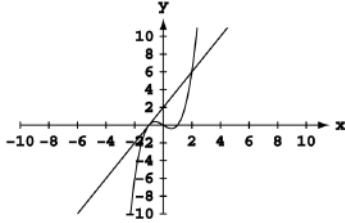

(c)
$$\left. \begin{aligned} y &= x^3 - x \\ y &= 2x + 2 \end{aligned} \right\} \Rightarrow x^3 - x = 2x + 2 \Rightarrow x^3 - 3x - 2 = (x - 2)(x + 1)^2 = 0 \Rightarrow x = 2 \text{ or } x = -1. \text{ Since}$$

$$y = 2(2) + 2 = 6; \text{ the other intersection point is } (2, 6)$$

48. (a) $y = x^3 - 6x^2 + 5x \Rightarrow y' = 3x^2 - 12x + 5$. When $x = 0, y = 0$ and $y' = 5 \Rightarrow$ the tangent line to the curve at $(0, 0)$ is $y = 5x$.

(b)

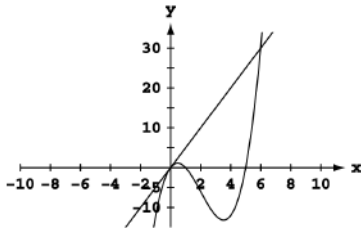

(c)
$$\left. \begin{aligned} y &= x^3 - 6x^2 + 5x \\ y &= 5x \end{aligned} \right\} \Rightarrow x^3 - 6x^2 + 5x = 5x \Rightarrow x^3 - 6x^2 = 0 \Rightarrow x^2(x - 6) = 0 \Rightarrow x = 0 \text{ or } x = 6.$$
 Since $y = 5(6) = 30$, the other intersection point is $(6, 30)$.

49. $P(x) = a_n x^n + a_{n-1} x^{n-1} + \dots + a_2 x^2 + a_1 x + a_0 \Rightarrow P'(x) = n a_n x^{n-1} + (n - 1) a_{n-1} x^{n-2} + \dots + 2 a_2 x + a_1$

50. $R = M^2 \left(\frac{C}{2} - \frac{M}{3} \right) = \frac{C}{2} M^2 - \frac{1}{3} M^3$, where C is a constant $\Rightarrow \frac{dR}{dM} = CM - M^2$

51. Let c be a constant $\Rightarrow \frac{dc}{dx} = 0 \Rightarrow \frac{d}{dx}(u \cdot c) = u \cdot \frac{dc}{dx} + c \cdot \frac{du}{dx} = u \cdot 0 + c \frac{du}{dx} = c \frac{du}{dx}$. Thus when one of the functions is a constant, the Product Rule is just the Constant Multiple Rule \Rightarrow the Constant Multiple Rule is a special case of the Product Rule.

52. (a) We use the Quotient rule to derive the Reciprocal Rule (with $u = 1$): $\frac{d}{dx} \left(\frac{1}{v} \right) = \frac{v \cdot 0 - 1 \cdot \frac{dv}{dx}}{v^2} = \frac{-1 \cdot \frac{dv}{dx}}{v^2}$
 $= -\frac{1}{v^2} \cdot \frac{dv}{dx}$.

(b) Now, using the Reciprocal Rule and the Product Rule, we'll derive the Quotient Rule: $\frac{d}{dx} \left(\frac{u}{v} \right) = \frac{d}{dx} \left(u \cdot \frac{1}{v} \right)$
 $= u \cdot \frac{d}{dx} \left(\frac{1}{v} \right) + \frac{1}{v} \cdot \frac{du}{dx}$ (Product Rule) $= u \cdot \left(\frac{-1}{v^2} \right) \frac{dv}{dx} + \frac{1}{v} \frac{du}{dx}$ (Reciprocal Rule) $\Rightarrow \frac{d}{dx} \left(\frac{u}{v} \right) = \frac{-u \frac{dv}{dx} + v \frac{du}{dx}}{v^2}$
 $= \frac{v \frac{du}{dx} - u \frac{dv}{dx}}{v^2}$, the Quotient Rule.

53. (a) $\frac{d}{dx}(uvw) = \frac{d}{dx}((uv) \cdot w) = (uv) \frac{dw}{dx} + w \cdot \frac{d}{dx}(uv) = uv \frac{dw}{dx} + w \left(u \frac{dv}{dx} + v \frac{du}{dx} \right) = uv \frac{dw}{dx} + wu \frac{dv}{dx} + wv \frac{du}{dx}$
 $= uvw' + uv'w + u'vw$

(b) $\frac{d}{dx}(u_1 u_2 u_3 u_4) = \frac{d}{dx}((u_1 u_2 u_3) u_4) = (u_1 u_2 u_3) \frac{du_4}{dx} + u_4 \frac{d}{dx}(u_1 u_2 u_3) \Rightarrow \frac{d}{dx}(u_1 u_2 u_3 u_4)$
 $= u_1 u_2 u_3 \frac{du_4}{dx} + u_4 \left(u_1 u_2 \frac{du_3}{dx} + u_3 u_1 \frac{du_2}{dx} + u_3 u_2 \frac{du_1}{dx} \right)$ (using (a) above)
 $\Rightarrow \frac{d}{dx}(u_1 u_2 u_3 u_4) = u_1 u_2 u_3 \frac{du_4}{dx} + u_1 u_2 u_4 \frac{du_3}{dx} + u_1 u_3 u_4 \frac{du_2}{dx} + u_2 u_3 u_4 \frac{du_1}{dx}$
 $= u_1 u_2 u_3 u_4' + u_1 u_2 u_3' u_4 + u_1 u_2' u_3 u_4 + u_1' u_2 u_3 u_4$

(c) Generalizing (a) and (b) above, $\frac{d}{dx}(u_1 \dots u_n) = u_1 u_2 \dots u_{n-1} u_n' + u_1 u_2 \dots u_{n-2} u_{n-1}' u_n + \dots + u_1' u_2 \dots u_n$

54. In this problem we don't know the Power Rule works with fractional powers so we can't use it. Remember

$$\frac{d}{dx}(\sqrt{x}) = \frac{1}{2\sqrt{x}} \text{ (from Example 2 in Section 2.1)}$$

$$(a) \frac{d}{dx}(x^{3/2}) = \frac{d}{dx}(x \cdot x^{1/2}) = x \cdot \frac{d}{dx}(\sqrt{x}) + \sqrt{x} \cdot \frac{d}{dx}(x) = x \cdot \frac{1}{2\sqrt{x}} + \sqrt{x} \cdot 1 = \frac{\sqrt{x}}{2} + \sqrt{x} = \frac{3\sqrt{x}}{2} = \frac{3}{2}x^{1/2}$$

$$(b) \frac{d}{dx}(x^{5/2}) = \frac{d}{dx}(x^2 \cdot x^{1/2}) = x^2 \cdot \frac{d}{dx}(\sqrt{x}) + \sqrt{x} \cdot \frac{d}{dx}(x^2) = x^2 \cdot \left(\frac{1}{2\sqrt{x}}\right) + \sqrt{x} \cdot 2x = \frac{1}{2}x^{3/2} + 2x^{3/2} = \frac{5}{2}x^{3/2}$$

$$(c) \frac{d}{dx}(x^{7/2}) = \frac{d}{dx}(x^3 \cdot x^{1/2}) = x^3 \cdot \frac{d}{dx}(\sqrt{x}) + \sqrt{x} \cdot \frac{d}{dx}(x^3) = x^3 \cdot \left(\frac{1}{2\sqrt{x}}\right) + \sqrt{x} \cdot 3x^2 = \frac{1}{2}x^{5/2} + 3x^{5/2} = \frac{7}{2}x^{5/2}$$

$$(d) \text{ We have } \frac{d}{dx}(x^{3/2}) = \frac{3}{2}x^{1/2}, \frac{d}{dx}(x^{5/2}) = \frac{5}{2}x^{3/2}, \frac{d}{dx}(x^{7/2}) = \frac{7}{2}x^{5/2} \text{ so it appears that } \frac{d}{dx}(x^{n/2}) = \frac{n}{2}x^{(n/2)-1} \text{ whenever } n \text{ is an odd positive integer } \geq 3.$$

55. $p = \frac{nRT}{V-nb} - \frac{an^2}{V^2}$. We are holding T constant, and a, b, n, R are also constant so their derivatives are zero

$$\Rightarrow \frac{dp}{dV} = \frac{(V-nb) \cdot 0 - (nRT)(1)}{(V-nb)^2} - \frac{V^2(0) - (an^2)(2V)}{(V^2)^2} = \frac{-nRT}{(V-nb)^2} + \frac{2an^2}{V^3}$$

$$56. A(q) = \frac{km}{q} + cm + \frac{hq}{2} = (km)q^{-1} + cm + \left(\frac{h}{2}\right)q \Rightarrow \frac{dA}{dq} = -(km)q^{-2} + \left(\frac{h}{2}\right) = -\frac{km}{q^2} + \frac{h}{2} \Rightarrow \frac{d^2A}{dq^2} = 2(km)q^{-3} = \frac{2km}{q^3}$$

3.3 THE DERIVATIVE AS A RATE OF CHANGE

1. $s = t^2 - 3t + 2, 0 \leq t \leq 2$

(a) displacement = $\Delta s = s(2) - s(0) = 0\text{m} - 2\text{m} = -2\text{m}$, $v_{av} = \frac{\Delta s}{\Delta t} = \frac{-2}{2} = -1\text{ m/sec}$

(b) $v = \frac{ds}{dt} = 2t - 3 \Rightarrow |v(0)| = |-3| = 3\text{ m/sec}$ and $|v(2)| = 1\text{ m/sec}$;

$a = \frac{d^2s}{dt^2} = 2 \Rightarrow a(0) = 2\text{ m/sec}^2$ and $a(2) = 2\text{ m/sec}^2$

(c) $v = 0 \Rightarrow 2t - 3 = 0 \Rightarrow t = \frac{3}{2}$. v is negative in the interval $0 < t < \frac{3}{2}$ and v is positive when $\frac{3}{2} < t < 2 \Rightarrow$ the body changes direction at $t = \frac{3}{2}$.

2. $s = 6t - t^2, 0 \leq t \leq 6$

(a) displacement = $\Delta s = s(6) - s(0) = 0\text{ m}$, $v_{av} = \frac{\Delta s}{\Delta t} = \frac{0}{6} = 0\text{ m/sec}$

(b) $v = \frac{ds}{dt} = 6 - 2t \Rightarrow |v(0)| = |6| = 6\text{ m/sec}$ and $|v(6)| = |-6| = 6\text{ m/sec}$;

$a = \frac{d^2s}{dt^2} = -2 \Rightarrow a(0) = -2\text{ m/sec}^2$ and $a(6) = -2\text{ m/sec}^2$

(c) $v = 0 \Rightarrow 6 - 2t = 0 \Rightarrow t = 3$. v is positive in the interval $0 < t < 3$ and v is negative when $3 < t < 6 \Rightarrow$ the body changes direction at $t = 3$.

3. $s = -t^3 + 3t^2 - 3t, 0 \leq t \leq 3$

(a) displacement = $\Delta s = s(3) - s(0) = -9\text{ m}$, $v_{av} = \frac{\Delta s}{\Delta t} = \frac{-9}{3} = -3\text{ m/sec}$

(b) $v = \frac{ds}{dt} = -3t^2 + 6t - 3 \Rightarrow |v(0)| = |-3| = 3\text{ m/sec}$ and $|v(3)| = |-12| = 12\text{ m/sec}$; $a = \frac{d^2s}{dt^2} = -6t + 6$

$\Rightarrow a(0) = 6\text{ m/sec}^2$ and $a(3) = -12\text{ m/sec}^2$

(c) $v = 0 \Rightarrow -3t^2 + 6t - 3 = 0 \Rightarrow t^2 - 2t + 1 = 0 \Rightarrow (t-1)^2 = 0 \Rightarrow t = 1$. For all other values of t in the interval the velocity v is negative (the graph of $v = -3t^2 + 6t - 3$ is a parabola with vertex at $t = 1$ which opens downward \Rightarrow the body never changes direction).

4. $s = \frac{t^4}{4} - t^3 + t^2, 0 \leq t \leq 3$

(a) $\Delta s = s(3) - s(0) = \frac{9}{4}\text{ m}$, $v_{av} = \frac{\Delta s}{\Delta t} = \frac{\frac{9}{4}}{3} = \frac{3}{4}\text{ m/sec}$

(b) $v = t^3 - 3t^2 + 2t \Rightarrow |v(0)| = 0\text{ m/sec}$ and $|v(3)| = 6\text{ m/sec}$; $a = 3t^2 - 6t + 2 \Rightarrow a(0) = 2\text{ m/sec}^2$ and

$a(3) = 11\text{ m/sec}^2$

(c) $v = 0 \Rightarrow t^3 - 3t^2 + 2t = 0 \Rightarrow t(t-2)(t-1) = 0 \Rightarrow t = 0, 1, 2 \Rightarrow v = t(t-2)(t-1)$ is positive in the interval for $0 < t < 1$ and v is negative for $1 < t < 2$ and v is positive for $2 < t < 3 \Rightarrow$ the body changes direction at

$t = 1$ and at $t = 2$.

5. $s = \frac{25}{t^2} - \frac{5}{t}$, $1 \leq t \leq 5$
- (a) $\Delta s = s(5) - s(1) = -20$ m, $v_{av} = \frac{-20}{4} = -5$ m/sec
- (b) $v = \frac{-50}{t^3} + \frac{5}{t^2} \Rightarrow |v(1)| = 45$ m/sec and $|v(5)| = \frac{1}{5}$ m/sec; $a = \frac{150}{t^4} - \frac{10}{t^3} \Rightarrow a(1) = 140$ m/sec² and $a(5) = \frac{4}{25}$ m/sec²
- (c) $v = 0 \Rightarrow \frac{-50+5t}{t^3} = 0 \Rightarrow -50 + 5t = 0 \Rightarrow t = 10 \Rightarrow$ the body does not change direction in the interval
6. $s = \frac{25}{t+5}$, $-4 \leq t \leq 0$
- (a) $\Delta s = s(0) - s(-4) = -20$ m, $v_{av} = -\frac{20}{4} = -5$ m/sec
- (b) $v = \frac{-25}{(t+5)^2} \Rightarrow |v(-4)| = 25$ m/sec and $|v(0)| = 1$ m/sec; $a = \frac{50}{(t+5)^3} \Rightarrow a(-4) = 50$ m/sec² and $a(0) = \frac{2}{5}$ m/sec²
- (c) $v = 0 \Rightarrow \frac{-25}{(t+5)^2} = 0 \Rightarrow v$ is never 0 \Rightarrow the body never changes direction
7. $s = t^3 - 6t^2 + 9t$ and let the positive direction be to the right on the s-axis.
- (a) $v = 3t^2 - 12t + 9$ so that $v = 0 \Rightarrow t^2 - 4t + 3 = (t-3)(t-1) = 0 \Rightarrow t = 1$ or 3 ; $a = 6t - 12 \Rightarrow a(1) = -6$ m/sec² and $a(3) = 6$ m/sec². Thus the body is motionless but being accelerated left when $t = 1$, and motionless but being accelerated right when $t = 3$.
- (b) $a = 0 \Rightarrow 6t - 12 = 0 \Rightarrow t = 2$ with speed $|v(2)| = |12 - 24 + 9| = 3$ m/sec
- (c) The body moves to the right or forward on $0 \leq t < 1$, and to the left or backward on $1 < t < 2$. The positions are $s(0) = 0$, $s(1) = 4$ and $s(2) = 2 \Rightarrow$ total distance $= |s(1) - s(0)| + |s(2) - s(1)| = |4| + |-2| = 6$ m.
8. $v = t^2 - 4t + 3 \Rightarrow a = 2t - 4$
- (a) $v = 0 \Rightarrow t^2 - 4t + 3 = 0 \Rightarrow t = 1$ or $3 \Rightarrow a(1) = -2$ m/sec² and $a(3) = 2$ m/sec²
- (b) $v > 0 \Rightarrow (t-3)(t-1) > 0 \Rightarrow 0 \leq t < 1$ or $t > 3$ and the body is moving forward; $v < 0 \Rightarrow (t-3)(t-1) < 0 \Rightarrow 1 < t < 3$ and the body is moving backward
- (c) velocity increasing $\Rightarrow a > 0 \Rightarrow 2t - 4 > 0 \Rightarrow t > 2$; velocity decreasing $\Rightarrow a < 0 \Rightarrow 2t - 4 < 0 \Rightarrow 0 \leq t < 2$
9. $s_m = 1.86t^2 \Rightarrow v_m = 3.72t$ and solving $3.72t = 27.8 \Rightarrow t \approx 7.5$ sec on Mars; $s_j = 11.44t^2 \Rightarrow v_j = 22.88t$ and solving $22.88t = 27.8 \Rightarrow t \approx 1.2$ sec on Jupiter.
10. (a) $v(t) = s'(t) = 24 - 1.6t$ m/sec, and $a(t) = v'(t) = s''(t) = -1.6$ m/sec²
- (b) Solve $v(t) = 0 \Rightarrow 24 - 1.6t = 0 \Rightarrow t = 15$ sec
- (c) $s(15) = 24(15) - .8(15)^2 = 180$ m
- (d) Solve $s(t) = 90 \Rightarrow 24t - .8t^2 = 90 \Rightarrow t = \frac{30 \pm 15\sqrt{2}}{2} \approx 4.39$ sec going up and 25.6 sec going down
- (e) Twice the time it took to reach its highest point or 30 sec
11. $s = 15t - \frac{1}{2}g_s t^2 \Rightarrow v = 15 - g_s t$ so that $v = 0 \Rightarrow 15 - g_s t = 0 \Rightarrow g_s = \frac{15}{t}$. Therefore $g_s = \frac{15}{20} = \frac{3}{4} = 0.75$ m/sec²
12. Solving $s_m = 832t - 2.6t^2 = 0 \Rightarrow t(832 - 2.6t) = 0 \Rightarrow t = 0$ or $320 \Rightarrow 320$ sec on the moon; solving $s_e = 832t - 16t^2 = 0 \Rightarrow t(832 - 16t) = 0 \Rightarrow t = 0$ or $52 \Rightarrow 52$ sec on the earth. Also, $v_m = 832 - 5.2t = 0 \Rightarrow t = 160$ and $s_m(160) = 66,560$ ft, the height it reaches above the moon's surface; $v_e = 832 - 32t = 0 \Rightarrow t = 26$ and $s_e(26) = 10,816$ ft, the height it reaches above the earth's surface.
13. (a) $s = 179 - 16t^2 \Rightarrow v = -32t \Rightarrow$ speed $= |v| = 32t$ ft/sec and $a = -32$ ft/sec²

- (b) $s = 0 \Rightarrow 179 - 16t^2 = 0 \Rightarrow t = \sqrt{\frac{179}{16}} \approx 3.3$ sec
 (c) When $t = \sqrt{\frac{179}{16}}$, $v = -32\sqrt{\frac{179}{16}} = -8\sqrt{179} \approx -107.0$ ft/sec

14. (a) $\lim_{\theta \rightarrow \frac{\pi}{2}} v = \lim_{\theta \rightarrow \frac{\pi}{2}} 9.8(\sin \theta)t = 9.8t$ so we expect $v = 9.8t$ m/sec in free fall
 (b) $a = \frac{dv}{dt} = 9.8$ m/sec²

15. (a) at 2 and 7 seconds

(c)

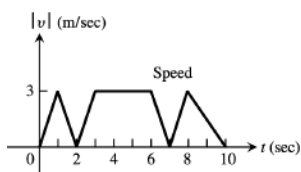

- (b) between 3 and 6 seconds: $3 \leq t \leq 6$

(d)

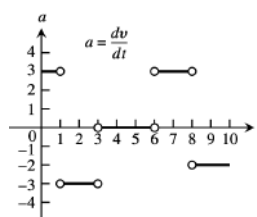

16. (a) P is moving to the left when $2 < t < 3$ or $5 < t < 6$; P is moving to the right when $0 < t < 1$; P is standing still when $1 < t < 2$ or $3 < t < 5$

(b)

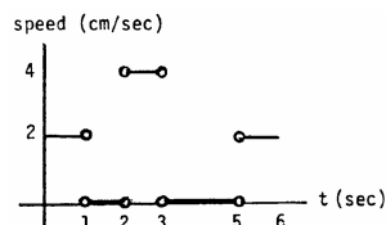
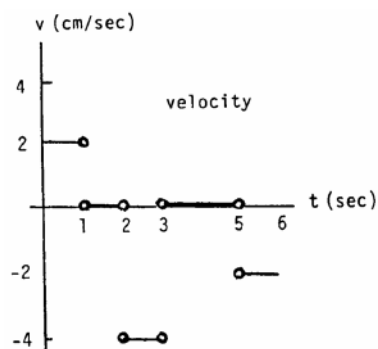

17. (a) 190 ft/sec
 (b) 2 sec
 (c) at 8 sec, 0 ft/sec
 (d) 10.8 sec, 90 ft/sec
 (e) From $t = 8$ until $t = 10.8$ sec, a total of 2.8 sec
 (f) Greatest acceleration happens 2 sec after launch
 (g) From $t = 2$ to $t = 10.8$ sec; during this period, $a = \frac{v(10.8) - v(2)}{10.8 - 2} \approx -32$ ft/sec²

18. (a) Forward: $0 \leq t < 1$ and $5 < t < 7$; Backward: $1 < t < 5$; Speeds up: $1 < t < 2$ and $5 < t < 6$;
 Slows down: $0 \leq t < 1$, $3 < t < 5$, and $6 < t < 7$

(b) Positive: $3 < t < 6$; negative: $0 \leq t < 2$ and $6 < t < 7$; zero: $2 < t < 3$ and $7 < t < 9$

(c) $t = 0$ and $2 \leq t \leq 3$

(d) $7 \leq t \leq 9$

19. $s = 490t^2 \Rightarrow v = 980t \Rightarrow a = 980$

(a) Solving $160 = 490t^2 \Rightarrow t = \frac{4}{7}$ sec. The average velocity was $\frac{s(4/7) - s(0)}{4/7} = 280$ cm/sec.

(b) At the 160 cm mark the balls are falling at $v(4/7) = 560$ cm/sec. The acceleration at the 160 cm mark was 980 cm/sec².

(c) The light was flashing at a rate of $\frac{17}{4/7} = 29.75$ flashes per second.

20. (a)

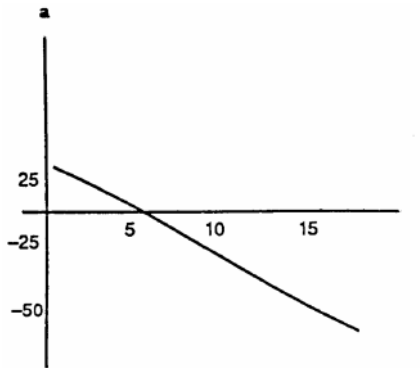
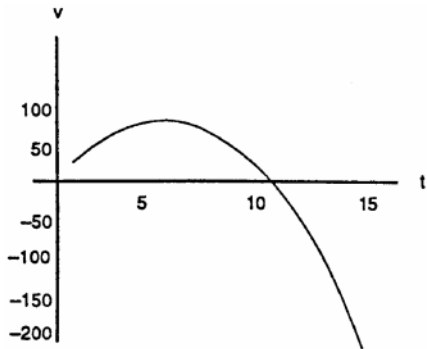

(b)

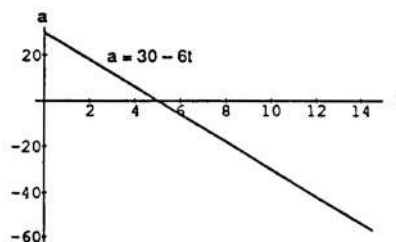
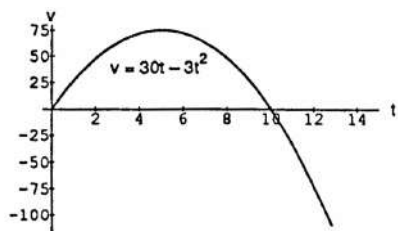

21. $C =$ position, $A =$ velocity, and $B =$ acceleration. Neither A nor C can be the derivative of B because B 's derivative is constant. Graph C cannot be the derivative of A either, because A has some negative slopes while C has only positive values. So, C (being the derivative of neither A nor B) must be the graph of position. Curve C has both positive and negative slopes, so its derivative, the velocity, must be A and not B . That leaves B for acceleration.

22. $C =$ position, $B =$ velocity, and $A =$ acceleration. Curve C cannot be the derivative of either A or B because C has only negative values while both A and B have some positive slopes. So, C represents position. Curve C has no positive slopes, so its derivative, the velocity, must be B . That leaves A for acceleration. Indeed, A is negative where B has negative slopes and positive where B has positive slopes.

23. (a) $c(100) = 11,000 \Rightarrow c_{av} = \frac{11,000}{100} = \110

(b) $c(x) = 2000 + 100x - .1x^2 \Rightarrow c'(x) = 100 - .2x$. Marginal cost $= c'(x) \Rightarrow$ the marginal cost of producing 100 machines is $c'(100) = \$80$

(c) The cost of producing the 101st machine is $c(101) - c(100) = 100 - \frac{201}{10} = \79.90

24. (a) $r(x) = 20000 \left(1 - \frac{1}{x}\right) \Rightarrow r'(x) = \frac{20000}{x^2}$, which is marginal revenue.

(b) $r'(100) = \frac{20000}{100^2} = \2 .

(c) $\lim_{x \rightarrow \infty} r'(x) = \lim_{x \rightarrow \infty} \frac{20000}{x^2} = 0$. The increase in revenue as the number of items increases without bound will approach zero.

25. $b(t) = 10^6 + 10^4t - 10^3t^2 \Rightarrow b'(t) = 10^4 - (2)(10^3t) = 10^3(10 - 2t)$

(a) $b'(0) = 10^4$ bacteria/hr

(b) $b'(5) = 0$ bacteria/hr

(c) $b'(10) = -10^4$ bacteria/hr

26. $Q(t) = 200(30 - t)^2 = 200(900 - 60t + t^2) \Rightarrow Q'(t) = 200(-60 + 2t) \Rightarrow Q'(10) = -8,000$ gallons/min is the rate the water is running at the end of 10 min. Then $\frac{Q(10) - Q(0)}{10} = -10,000$ gallons/min is the average rate the water flows during the first 10 min. The negative signs indicate water is leaving the tank.

27. (a) $y = 6\left(1 - \frac{t}{12}\right)^2 = 6\left(1 - \frac{t}{6} + \frac{t^2}{144}\right) \Rightarrow \frac{dy}{dt} = \frac{t}{12} - 1$

(b) The largest value of $\frac{dy}{dt}$ is 0 m/h when $t = 12$ and the fluid level is falling the slowest at that time. The smallest value of $\frac{dy}{dt}$ is -1 m/h, when $t = 0$, and the fluid level is falling the fastest at that time.

(c) In this situation, $\frac{dy}{dt} \leq 0 \Rightarrow$ the graph of y is always decreasing. As $\frac{dy}{dt}$ increases in value, the slope of the graph of y increases from -1 to 0 over the interval $0 \leq t \leq 12$.

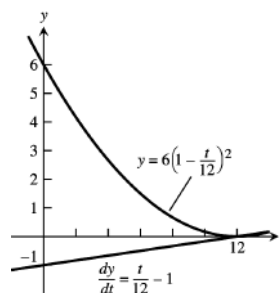

28. (a) $V = \frac{4}{3}\pi r^3 \Rightarrow \frac{dV}{dr} = 4\pi r^2 \Rightarrow \frac{dV}{dr} \Big|_{r=2} = 4\pi(2)^2 = 16\pi \text{ ft}^3/\text{ft}$

(b) When $r = 2$, $\frac{dV}{dr} = 16\pi$ so that when r changes by 1 unit, we expect V to change by approximately 16π . Therefore when r changes by 0.2 units V changes by approximately $(16\pi)(0.2) = 3.2\pi \approx 10.05 \text{ ft}^3$. Note that $V(2.2) - V(2) \approx 11.09 \text{ ft}^3$.

29. $200 \text{ km/hr} = 55 \frac{5}{9} \text{ m/sec} = \frac{500}{9} \text{ m/sec}$, and $D = \frac{10}{9} t^2 \Rightarrow V = \frac{20}{9} t$. Thus $V = \frac{500}{9} \Rightarrow \frac{20}{9} t = \frac{500}{9} \Rightarrow t = 25 \text{ sec}$. When $t = 25$, $D = \frac{10}{9} (25)^2 = \frac{6250}{9} \text{ m}$

30. $s = v_0 t - 16t^2 \Rightarrow v = v_0 - 32t$; $v = 0 \Rightarrow t = \frac{v_0}{32}$; $1900 = v_0 t - 16t^2$ so that $t = \frac{v_0}{32} \Rightarrow 1900 = \frac{v_0^2}{32} - \frac{v_0^2}{64} \Rightarrow v_0 = \sqrt{(64)(1900)} = 80\sqrt{19} \text{ ft/sec}$ and, finally, $\frac{80\sqrt{19} \text{ ft}}{\text{sec}} \cdot \frac{60 \text{ sec}}{1 \text{ min}} \cdot \frac{60 \text{ min}}{1 \text{ hr}} \cdot \frac{1 \text{ mi}}{5280 \text{ ft}} \approx 238 \text{ mph}$.

31.

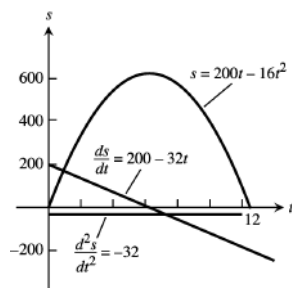

(a) $v = 0$ when $t = 6.25 \text{ sec}$

(b) $v > 0$ when $0 \leq t < 6.25 \Rightarrow$ body moves up; $v < 0$ when $6.25 < t \leq 12.5 \Rightarrow$ body moves down

(c) body changes direction at $t = 6.25 \text{ sec}$

(d) body speeds up on $(6.25, 12.5]$ and slows down on $[0, 6.25)$

(e) The body is moving fastest at the endpoints $t = 0$ and $t = 12.5$ when it is traveling 200 ft/sec . It's moving slowest at $t = 6.25$ when the speed is 0.

(f) When $t = 6.25$ the body is $s = 625 \text{ m}$ from the origin and farthest away.

32.

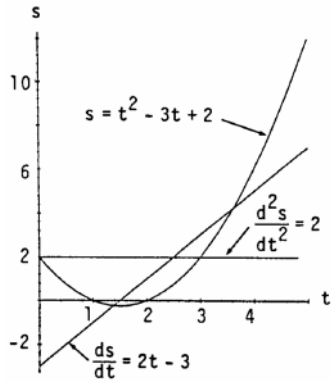

- (a) $v = 0$ when $t = \frac{3}{2}$ sec
- (b) $v < 0$ when $0 \leq t < 1.5 \Rightarrow$ body moves down; $v > 0$ when $1.5 < t \leq 5 \Rightarrow$ body moves up
- (c) body changes direction at $t = \frac{3}{2}$ sec
- (d) body speeds up on $(\frac{3}{2}, 5]$ and slows down on $[0, \frac{3}{2})$
- (e) body is moving fastest at $t = 5$ when the speed $= |v(5)| = 7$ units/sec; it is moving slowest at $t = \frac{3}{2}$ when the speed is 0
- (f) When $t = 5$ the body is $s = 12$ units from the origin and farthest away.

33.

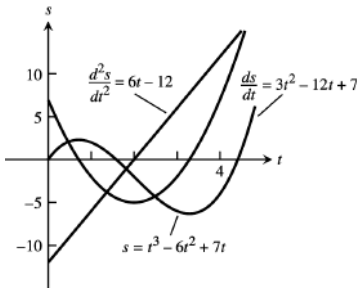

- (a) $v = 0$ when $t = \frac{6 \pm \sqrt{15}}{3}$ sec
- (b) $v < 0$ when $\frac{6 - \sqrt{15}}{3} < t < \frac{6 + \sqrt{15}}{3} \Rightarrow$ body moves left; $v > 0$ when $0 \leq t < \frac{6 - \sqrt{15}}{3}$ or $\frac{6 + \sqrt{15}}{3} < t \leq 4 \Rightarrow$ body moves right
- (c) body changes direction at $t = \frac{6 \pm \sqrt{15}}{3}$ sec
- (d) body speeds up on $(\frac{6 - \sqrt{15}}{3}, 2) \cup (\frac{6 + \sqrt{15}}{3}, 4]$ and slows down on $[0, \frac{6 - \sqrt{15}}{3}) \cup (2, \frac{6 + \sqrt{15}}{3})$.
- (e) The body is moving fastest at $t = 0$ and $t = 4$ when it is moving 7 units/sec and slowest at $t = \frac{6 \pm \sqrt{15}}{3}$ sec
- (f) When $t = \frac{6 + \sqrt{15}}{3}$ the body is at position $s \approx -6.303$ units and farthest from the origin.

34.

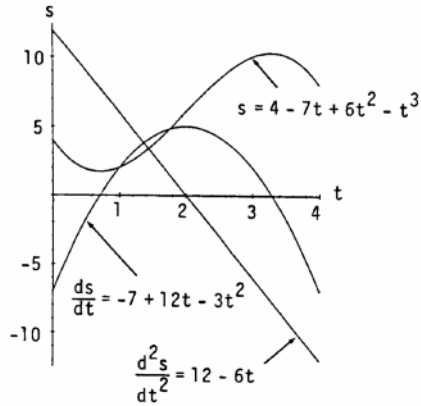

- (a) $v = 0$ when $t = \frac{6 \pm \sqrt{15}}{3}$
- (b) $v < 0$ when $0 \leq t < \frac{6 - \sqrt{15}}{3}$ or $\frac{6 + \sqrt{15}}{3} < t \leq 4 \Rightarrow$ body is moving left; $v > 0$ when $\frac{6 - \sqrt{15}}{3} < t < \frac{6 + \sqrt{15}}{3} \Rightarrow$ body is moving right
- (c) body changes direction at $t = \frac{6 \pm \sqrt{15}}{3}$ sec
- (d) body speeds up on $\left(\frac{6 - \sqrt{15}}{3}, 2\right) \cup \left(\frac{6 + \sqrt{15}}{3}, 4\right]$ and slows down on $\left[0, \frac{6 - \sqrt{15}}{3}\right) \cup \left(2, \frac{6 + \sqrt{15}}{3}\right)$
- (e) The body is moving fastest at 7 units/sec when $t = 0$ and $t = 4$; it is moving slowest and stationary at $t = \frac{6 \pm \sqrt{15}}{3}$
- (f) When $t = \frac{6 + \sqrt{15}}{3}$ the position is $s \approx 10.303$ units and the body is farthest from the origin.

35. (a) It takes 135 seconds.

 (b) Average speed $= \frac{\Delta F}{\Delta t} = \frac{5-0}{73-0} = \frac{5}{73} \approx 0.068$ furlongs/sec.

 (c) Using a symmetric difference quotient, the horse's speed is approximately $\frac{\Delta F}{\Delta t} = \frac{4-2}{59-33} = \frac{2}{26} \approx 0.077$ furlongs/sec.

(d) The horse is running the fastest during the last furlong (between the 9th and 10th furlong markers). This furlong takes only 11 seconds to run, which is the least amount of time for a furlong.

(e) The horse accelerates the fastest during the first furlong (between markers 0 and 1).

3.4 DERIVATIVES OF TRIGONOMETRIC FUNCTIONS

1. $y = -10x + 3 \cos x \Rightarrow \frac{dy}{dx} = -10 + 3 \frac{d}{dx}(\cos x) = -10 - 3 \sin x$

2. $y = \frac{3}{x} + 5 \sin x \Rightarrow \frac{dy}{dx} = \frac{-3}{x^2} + 5 \frac{d}{dx}(\sin x) = \frac{-3}{x^2} + 5 \cos x$

3. $y = \csc x - 4\sqrt{x} + 7 \Rightarrow \frac{dy}{dx} = -\csc x \cot x - \frac{4}{2\sqrt{x}} + 0 = -\csc x \cot x - \frac{2}{\sqrt{x}}$

4. $y = x^2 \cot x - \frac{1}{x^2} \Rightarrow \frac{dy}{dx} = x^2 \frac{d}{dx}(\cot x) + \cot x \cdot \frac{d}{dx}(x^2) + \frac{2}{x^3} = -x^2 \csc^2 x + (\cot x)(2x) + \frac{2}{x^3}$
 $= -x^2 \csc^2 x + 2x \cot x + \frac{2}{x^3}$

5. $y = (\sec x + \tan x)(\sec x - \tan x) \Rightarrow \frac{dy}{dx} = (\sec x + \tan x) \frac{d}{dx}(\sec x - \tan x) + (\sec x - \tan x) \frac{d}{dx}(\sec x + \tan x)$
 $= (\sec x + \tan x)(\sec x \tan x - \sec^2 x) + (\sec x - \tan x)(\sec x \tan x + \sec^2 x)$
 $= (\sec^2 x \tan x + \sec x \tan^2 x - \sec^3 x - \sec^2 x \tan x) + (\sec^2 x \tan x - \sec x \tan^2 x + \sec^3 x - \tan x \sec^2 x) = 0.$

 (Note also that $y = \sec^2 x - \tan^2 x = (\tan^2 x + 1) - \tan^2 x = 1 \Rightarrow \frac{dy}{dx} = 0.$)

142 Chapter 3 Differentiation

$$\begin{aligned}
 6. \quad y &= (\sin x + \cos x) \sec x \Rightarrow \frac{dy}{dx} = (\sin x + \cos x) \frac{d}{dx} (\sec x) + \sec x \frac{d}{dx} (\sin x + \cos x) \\
 &= (\sin x + \cos x)(\sec x \tan x) + (\sec x)(\cos x - \sin x) = \frac{(\sin x + \cos x) \sin x}{\cos^2 x} + \frac{\cos x - \sin x}{\cos x} \\
 &= \frac{\sin^2 x + \cos x \sin x + \cos^2 x - \cos x \sin x}{\cos^2 x} = \frac{1}{\cos^2 x} = \sec^2 x
 \end{aligned}$$

(Note also that $y = \sin x \sec x + \cos x \sec x = \tan x + 1 \Rightarrow \frac{dy}{dx} = \sec^2 x$.)

$$\begin{aligned}
 7. \quad y &= \frac{\cot x}{1 + \cot x} \Rightarrow \frac{dy}{dx} = \frac{(1 + \cot x) \frac{d}{dx} (\cot x) - (\cot x) \frac{d}{dx} (1 + \cot x)}{(1 + \cot x)^2} = \frac{(1 + \cot x)(-\csc^2 x) - (\cot x)(-\csc^2 x)}{(1 + \cot x)^2} \\
 &= \frac{-\csc^2 x - \csc^2 x \cot x + \csc^2 x \cot x}{(1 + \cot x)^2} = \frac{-\csc^2 x}{(1 + \cot x)^2}
 \end{aligned}$$

$$\begin{aligned}
 8. \quad y &= \frac{\cos x}{1 + \sin x} \Rightarrow \frac{dy}{dx} = \frac{(1 + \sin x) \frac{d}{dx} (\cos x) - (\cos x) \frac{d}{dx} (1 + \sin x)}{(1 + \sin x)^2} = \frac{(1 + \sin x)(-\sin x) - (\cos x)(\cos x)}{(1 + \sin x)^2} \\
 &= \frac{-\sin x - \sin^2 x - \cos^2 x}{(1 + \sin x)^2} = \frac{-\sin x - 1}{(1 + \sin x)^2} = \frac{-(1 + \sin x)}{(1 + \sin x)^2} = \frac{-1}{1 + \sin x}
 \end{aligned}$$

$$9. \quad y = \frac{4}{\cos x} + \frac{1}{\tan x} = 4 \sec x + \cot x \Rightarrow \frac{dy}{dx} = 4 \sec x \tan x - \csc^2 x$$

$$10. \quad y = \frac{\cos x}{x} + \frac{x}{\cos x} \Rightarrow \frac{dy}{dx} = \frac{x(-\sin x) - (\cos x)(1)}{x^2} + \frac{(\cos x)(1) - x(-\sin x)}{\cos^2 x} = \frac{-x \sin x - \cos x}{x^2} + \frac{\cos x + x \sin x}{\cos^2 x}$$

$$\begin{aligned}
 11. \quad y &= x^2 \sin x + 2x \cos x - 2 \sin x \Rightarrow \frac{dy}{dx} = (x^2 \cos x + (\sin x)(2x)) + ((2x)(-\sin x) + (\cos x)(2)) - 2 \cos x \\
 &= x^2 \cos x + 2x \sin x - 2x \sin x + 2 \cos x - 2 \cos x = x^2 \cos x
 \end{aligned}$$

$$\begin{aligned}
 12. \quad y &= x^2 \cos x - 2x \sin x - 2 \cos x \Rightarrow \frac{dy}{dx} = (x^2(-\sin x) + (\cos x)(2x)) - (2x \cos x + (\sin x)(2)) - 2(-\sin x) \\
 &= -x^2 \sin x + 2x \cos x - 2x \cos x - 2 \sin x + 2 \sin x = -x^2 \sin x
 \end{aligned}$$

$$13. \quad s = \tan t - t \Rightarrow \frac{ds}{dt} = \frac{d}{dt} (\tan t) - 1 = \sec^2 t - 1 = \tan^2 t$$

$$14. \quad s = t^2 - \sec t + 1 \Rightarrow \frac{ds}{dt} = 2t - \frac{d}{dt} (\sec t) = 2t - \sec t \tan t$$

$$\begin{aligned}
 15. \quad s &= \frac{1 + \csc t}{1 - \csc t} \Rightarrow \frac{ds}{dt} = \frac{(1 - \csc t)(-\csc t \cot t) - (1 + \csc t)(\csc t \cot t)}{(1 - \csc t)^2} \\
 &= \frac{-\csc t \cot t + \csc^2 t \cot t - \csc t \cot t - \csc^2 t \cot t}{(1 - \csc t)^2} = \frac{-2 \csc t \cot t}{(1 - \csc t)^2}
 \end{aligned}$$

$$\begin{aligned}
 16. \quad s &= \frac{\sin t}{1 - \cos t} \Rightarrow \frac{ds}{dt} = \frac{(1 - \cos t)(\cos t) - (\sin t)(\sin t)}{(1 - \cos t)^2} = \frac{\cos t - \cos^2 t - \sin^2 t}{(1 - \cos t)^2} = \frac{\cos t - 1}{(1 - \cos t)^2} = -\frac{1}{1 - \cos t} \\
 &= \frac{1}{\cos t - 1}
 \end{aligned}$$

$$17. \quad r = 4 - \theta^2 \sin \theta \Rightarrow \frac{dr}{d\theta} = -(\theta^2 \frac{d}{d\theta} (\sin \theta) + (\sin \theta)(2\theta)) = -(\theta^2 \cos \theta + 2\theta \sin \theta) = -\theta(\theta \cos \theta + 2 \sin \theta)$$

$$18. \quad r = \theta \sin \theta + \cos \theta \Rightarrow \frac{dr}{d\theta} = (\theta \cos \theta + (\sin \theta)(1)) - \sin \theta = \theta \cos \theta$$

$$\begin{aligned}
 19. \quad r &= \sec \theta \csc \theta \Rightarrow \frac{dr}{d\theta} = (\sec \theta)(-\csc \theta \cot \theta) + (\csc \theta)(\sec \theta \tan \theta) \\
 &= \left(\frac{-1}{\cos \theta}\right) \left(\frac{1}{\sin \theta}\right) \left(\frac{\cos \theta}{\sin \theta}\right) + \left(\frac{1}{\sin \theta}\right) \left(\frac{1}{\cos \theta}\right) \left(\frac{\sin \theta}{\cos \theta}\right) = \frac{-1}{\sin^2 \theta} + \frac{1}{\cos^2 \theta} = \sec^2 \theta - \csc^2 \theta
 \end{aligned}$$

$$20. \quad r = (1 + \sec \theta) \sin \theta \Rightarrow \frac{dr}{d\theta} = (1 + \sec \theta) \cos \theta + (\sin \theta)(\sec \theta \tan \theta) = (\cos \theta + 1) + \tan^2 \theta = \cos \theta + \sec^2 \theta$$

$$21. \quad p = 5 + \frac{1}{\cot q} = 5 + \tan q \Rightarrow \frac{dp}{dq} = \sec^2 q$$

$$22. \quad p = (1 + \csc q) \cos q \Rightarrow \frac{dp}{dq} = (1 + \csc q)(-\sin q) + (\cos q)(-\csc q \cot q) = (-\sin q - 1) - \cot^2 q = -\sin q - \csc^2 q$$

23. $p = \frac{\sin q + \cos q}{\cos q} \Rightarrow \frac{dp}{dq} = \frac{(\cos q)(\cos q - \sin q) - (\sin q + \cos q)(-\sin q)}{\cos^2 q}$
 $= \frac{\cos^2 q - \cos q \sin q + \sin^2 q + \cos q \sin q}{\cos^2 q} = \frac{1}{\cos^2 q} = \sec^2 q$

24. $p = \frac{\tan q}{1 + \tan q} \Rightarrow \frac{dp}{dq} = \frac{(1 + \tan q)(\sec^2 q) - (\tan q)(\sec^2 q)}{(1 + \tan q)^2} = \frac{\sec^2 q + \tan q \sec^2 q - \tan q \sec^2 q}{(1 + \tan q)^2} = \frac{\sec^2 q}{(1 + \tan q)^2}$

25. (a) $y = \csc x \Rightarrow y' = -\csc x \cot x \Rightarrow y'' = -((\csc x)(-\csc^2 x) + (\cot x)(-\csc x \cot x)) = \csc^3 x + \csc x \cot^2 x$
 $= (\csc x)(\csc^2 x + \cot^2 x) = (\csc x)(\csc^2 x + \csc^2 x - 1) = 2 \csc^3 x - \csc x$

(b) $y = \sec x \Rightarrow y' = \sec x \tan x \Rightarrow y'' = (\sec x)(\sec^2 x) + (\tan x)(\sec x \tan x) = \sec^3 x + \sec x \tan^2 x$
 $= (\sec x)(\sec^2 x + \tan^2 x) = (\sec x)(\sec^2 x + \sec^2 x - 1) = 2 \sec^3 x - \sec x$

26. (a) $y = -2 \sin x \Rightarrow y' = -2 \cos x \Rightarrow y'' = -2(-\sin x) = 2 \sin x \Rightarrow y''' = 2 \cos x \Rightarrow y^{(4)} = -2 \sin x$

(b) $y = 9 \cos x \Rightarrow y' = -9 \sin x \Rightarrow y'' = -9 \cos x \Rightarrow y''' = -9(-\sin x) = 9 \sin x \Rightarrow y^{(4)} = 9 \cos x$

27. $y = \sin x \Rightarrow y' = \cos x \Rightarrow$ slope of tangent at $x = -\pi$ is $y'(-\pi) = \cos(-\pi) = -1$; slope of tangent at $x = 0$ is $y'(0) = \cos(0) = 1$; and slope of tangent at $x = \frac{3\pi}{2}$ is $y'(\frac{3\pi}{2}) = \cos \frac{3\pi}{2} = 0$. The tangent at $(-\pi, 0)$ is $y - 0 = -1(x + \pi)$, or $y = -x - \pi$; the tangent at $(0, 0)$ is $y - 0 = 1(x - 0)$, or $y = x$; and the tangent at $(\frac{3\pi}{2}, -1)$ is $y = -1$.

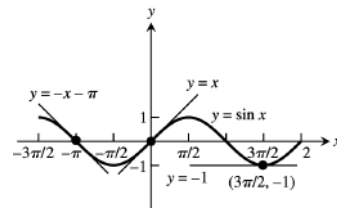

28. $y = \tan x \Rightarrow y' = \sec^2 x \Rightarrow$ slope of tangent at $x = -\frac{\pi}{3}$ is $\sec^2(-\frac{\pi}{3}) = 4$; slope of tangent at $x = 0$ is $\sec^2(0) = 1$; and slope of tangent at $x = \frac{\pi}{3}$ is $\sec^2(\frac{\pi}{3}) = 4$. The tangent at $(-\frac{\pi}{3}, \tan(-\frac{\pi}{3})) = (-\frac{\pi}{3}, -\sqrt{3})$ is $y + \sqrt{3} = 4(x + \frac{\pi}{3})$; the tangent at $(0, 0)$ is $y = x$; and the tangent at $(\frac{\pi}{3}, \tan(\frac{\pi}{3})) = (\frac{\pi}{3}, \sqrt{3})$ is $y - \sqrt{3} = 4(x - \frac{\pi}{3})$.

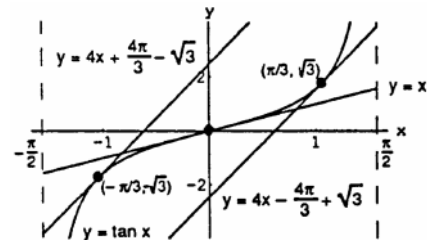

29. $y = \sec x \Rightarrow y' = \sec x \tan x \Rightarrow$ slope of tangent at $x = -\frac{\pi}{3}$ is $\sec(-\frac{\pi}{3}) \tan(-\frac{\pi}{3}) = -2\sqrt{3}$; slope of tangent at $x = \frac{\pi}{4}$ is $\sec(\frac{\pi}{4}) \tan(\frac{\pi}{4}) = \sqrt{2}$. The tangent at the point $(-\frac{\pi}{3}, \sec(-\frac{\pi}{3})) = (-\frac{\pi}{3}, 2)$ is $y - 2 = -2\sqrt{3}(x + \frac{\pi}{3})$; the tangent at the point $(\frac{\pi}{4}, \sec(\frac{\pi}{4})) = (\frac{\pi}{4}, \sqrt{2})$ is $y - \sqrt{2} = \sqrt{2}(x - \frac{\pi}{4})$.

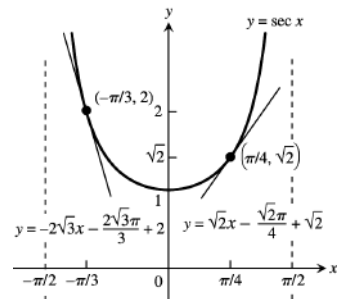

30. $y = 1 + \cos x \Rightarrow y' = -\sin x \Rightarrow$ slope of tangent at $x = -\frac{\pi}{3}$ is $-\sin(-\frac{\pi}{3}) = \frac{\sqrt{3}}{2}$; slope of tangent at $x = \frac{3\pi}{2}$ is $-\sin(\frac{3\pi}{2}) = 1$. The tangent at the point $(-\frac{\pi}{3}, 1 + \cos(-\frac{\pi}{3})) = (-\frac{\pi}{3}, \frac{3}{2})$ is $y - \frac{3}{2} = \frac{\sqrt{3}}{2}(x + \frac{\pi}{3})$; the tangent at the point $(\frac{3\pi}{2}, 1 + \cos(\frac{3\pi}{2})) = (\frac{3\pi}{2}, 1)$ is $y - 1 = x - \frac{3\pi}{2}$.

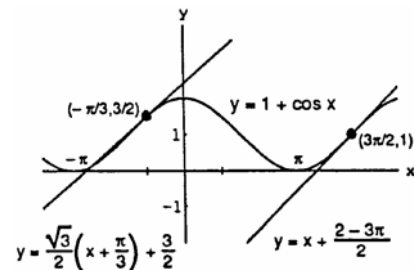

31. Yes, $y = x + \sin x \Rightarrow y' = 1 + \cos x$; horizontal tangent occurs where $1 + \cos x = 0 \Rightarrow \cos x = -1 \Rightarrow x = \pi$
32. No, $y = 2x + \sin x \Rightarrow y' = 2 + \cos x$; horizontal tangent occurs where $2 + \cos x = 0 \Rightarrow \cos x = -2$. But there are no x -values for which $\cos x = -2$.
33. No, $y = x - \cot x \Rightarrow y' = 1 + \csc^2 x$; horizontal tangent occurs where $1 + \csc^2 x = 0 \Rightarrow \csc^2 x = -1$. But there are no x -values for which $\csc^2 x = -1$.
34. Yes, $y = x + 2 \cos x \Rightarrow y' = 1 - 2 \sin x$; horizontal tangent occurs where $1 - 2 \sin x = 0 \Rightarrow 1 = 2 \sin x \Rightarrow \frac{1}{2} = \sin x \Rightarrow x = \frac{\pi}{6}$ or $x = \frac{5\pi}{6}$

35. We want all points on the curve where the tangent line has slope 2. Thus, $y = \tan x \Rightarrow y' = \sec^2 x$ so that $y' = 2 \Rightarrow \sec^2 x = 2 \Rightarrow \sec x = \pm \sqrt{2} \Rightarrow x = \pm \frac{\pi}{4}$. Then the tangent line at $(\frac{\pi}{4}, 1)$ has equation $y - 1 = 2(x - \frac{\pi}{4})$; the tangent line at $(-\frac{\pi}{4}, -1)$ has equation $y + 1 = 2(x + \frac{\pi}{4})$.

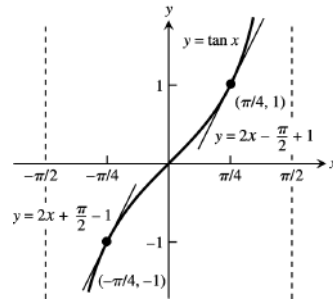

36. We want all points on the curve $y = \cot x$ where the tangent line has slope -1 . Thus $y = \cot x \Rightarrow y' = -\csc^2 x$ so that $y' = -1 \Rightarrow -\csc^2 x = -1 \Rightarrow \csc^2 x = 1 \Rightarrow \csc x = \pm 1 \Rightarrow x = \frac{\pi}{2}$. The tangent line at $(\frac{\pi}{2}, 0)$ is $y = -x + \frac{\pi}{2}$.

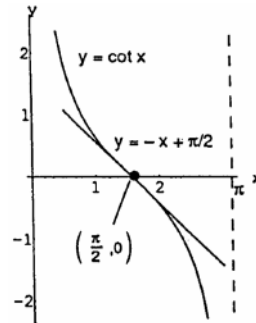

37. $y = 4 + \cot x - 2 \csc x \Rightarrow y' = -\csc^2 x + 2 \csc x \cot x = -\left(\frac{1}{\sin x}\right) \left(\frac{1-2\cos x}{\sin x}\right)$
 (a) When $x = \frac{\pi}{2}$, then $y' = -1$; the tangent line is $y = -x + \frac{\pi}{2} + 2$.
 (b) To find the location of the horizontal tangent set $y' = 0 \Rightarrow 1 - 2 \cos x = 0 \Rightarrow x = \frac{\pi}{3}$ radians. When $x = \frac{\pi}{3}$, then $y = 4 - \sqrt{3}$ is the horizontal tangent.

38. $y = 1 + \sqrt{2} \csc x + \cot x \Rightarrow y' = -\sqrt{2} \csc x \cot x - \csc^2 x = -\left(\frac{1}{\sin x}\right) \left(\frac{\sqrt{2} \cos x + 1}{\sin x}\right)$
 (a) If $x = \frac{\pi}{4}$, then $y' = -4$; the tangent line is $y = -4x + \pi + 4$.
 (b) To find the location of the horizontal tangent set $y' = 0 \Rightarrow \sqrt{2} \cos x + 1 = 0 \Rightarrow x = \frac{3\pi}{4}$ radians. When $x = \frac{3\pi}{4}$, then $y = 2$ is the horizontal tangent.

39. $\lim_{x \rightarrow 2} \sin\left(\frac{1}{x} - \frac{1}{2}\right) = \sin\left(\frac{1}{2} - \frac{1}{2}\right) = \sin 0 = 0$

40. $\lim_{x \rightarrow -\frac{\pi}{6}} \sqrt{1 + \cos(\pi \csc x)} = \sqrt{1 + \cos\left(\pi \csc\left(-\frac{\pi}{6}\right)\right)} = \sqrt{1 + \cos(\pi \cdot (-2))} = \sqrt{2}$

41. $\lim_{x \rightarrow 0} \sec\left[\cos x + \pi \tan\left(\frac{\pi}{4 \sec x}\right) - 1\right] = \sec\left[\cos 0 + \pi \tan\left(\frac{\pi}{4 \sec 0}\right) - 1\right] = \sec\left[1 + \pi \tan\left(\frac{\pi}{4}\right) - 1\right] = \sec \pi = -1$

$$42. \lim_{x \rightarrow 0} \sin\left(\frac{\pi + \tan x}{\tan x - 2 \sec x}\right) = \sin\left(\frac{\pi + \tan 0}{\tan 0 - 2 \sec 0}\right) = \sin\left(-\frac{\pi}{2}\right) = -1$$

$$43. \lim_{t \rightarrow 0} \tan\left(1 - \frac{\sin t}{t}\right) = \tan\left(1 - \lim_{t \rightarrow 0} \frac{\sin t}{t}\right) = \tan(1 - 1) = 0$$

$$44. \lim_{\theta \rightarrow 0} \cos\left(\frac{\pi\theta}{\sin \theta}\right) = \cos\left(\pi \lim_{\theta \rightarrow 0} \frac{\theta}{\sin \theta}\right) = \cos\left(\pi \cdot \frac{1}{\lim_{\theta \rightarrow 0} \frac{\sin \theta}{\theta}}\right) = \cos\left(\pi \cdot \frac{1}{1}\right) = -1$$

$$45. s = 2 - 2 \sin t \Rightarrow v = \frac{ds}{dt} = -2 \cos t \Rightarrow a = \frac{dv}{dt} = 2 \sin t \Rightarrow j = \frac{da}{dt} = 2 \cos t. \text{ Therefore, velocity} = v\left(\frac{\pi}{4}\right) = -\sqrt{2} \text{ m/sec; speed} = |v\left(\frac{\pi}{4}\right)| = \sqrt{2} \text{ m/sec; acceleration} = a\left(\frac{\pi}{4}\right) = \sqrt{2} \text{ m/sec}^2; \text{jerk} = j\left(\frac{\pi}{4}\right) = \sqrt{2} \text{ m/sec}^3.$$

$$46. s = \sin t + \cos t \Rightarrow v = \frac{ds}{dt} = \cos t - \sin t \Rightarrow a = \frac{dv}{dt} = -\sin t - \cos t \Rightarrow j = \frac{da}{dt} = -\cos t + \sin t. \text{ Therefore velocity} = v\left(\frac{\pi}{4}\right) = 0 \text{ m/sec; speed} = |v\left(\frac{\pi}{4}\right)| = 0 \text{ m/sec; acceleration} = a\left(\frac{\pi}{4}\right) = -\sqrt{2} \text{ m/sec}^2; \text{jerk} = j\left(\frac{\pi}{4}\right) = 0 \text{ m/sec}^3.$$

$$47. \lim_{x \rightarrow 0} f(x) = \lim_{x \rightarrow 0} \frac{\sin^2 3x}{x^2} = \lim_{x \rightarrow 0} 9 \left(\frac{\sin 3x}{3x}\right) \left(\frac{\sin 3x}{3x}\right) = 9 \text{ so that } f \text{ is continuous at } x = 0 \Rightarrow \lim_{x \rightarrow 0} f(x) = f(0) \Rightarrow 9 = c.$$

$$48. \lim_{x \rightarrow 0^-} g(x) = \lim_{x \rightarrow 0^-} (x + b) = b \text{ and } \lim_{x \rightarrow 0^+} g(x) = \lim_{x \rightarrow 0^+} \cos x = 1 \text{ so that } g \text{ is continuous at } x = 0 \Rightarrow \lim_{x \rightarrow 0^-} g(x) = \lim_{x \rightarrow 0^+} g(x) \Rightarrow b = 1. \text{ Now } g \text{ is not differentiable at } x = 0: \text{ At } x = 0, \text{ the left-hand derivative is } \frac{d}{dx}(x + b)\Big|_{x=0} = 1, \text{ but the right-hand derivative is } \frac{d}{dx}(\cos x)\Big|_{x=0} = -\sin 0 = 0. \text{ The left- and right-hand derivatives can never agree at } x = 0, \text{ so } g \text{ is not differentiable at } x = 0 \text{ for any value of } b \text{ (including } b = 1).$$

$$49. \frac{d^{999}}{dx^{999}}(\cos x) = \sin x \text{ because } \frac{d^4}{dx^4}(\cos x) = \cos x \Rightarrow \text{the derivative of } \cos x \text{ any number of times that is a multiple of 4 is } \cos x. \text{ Thus, dividing 999 by 4 gives } 999 = 249 \cdot 4 + 3 \Rightarrow \frac{d^{999}}{dx^{999}}(\cos x) = \frac{d^3}{dx^3} \left[\frac{d^{249 \cdot 4}}{dx^{249 \cdot 4}}(\cos x) \right] = \frac{d^3}{dx^3}(\cos x) = \sin x.$$

$$50. (a) y = \sec x = \frac{1}{\cos x} \Rightarrow \frac{dy}{dx} = \frac{(\cos x)(0) - (1)(-\sin x)}{(\cos x)^2} = \frac{\sin x}{\cos^2 x} = \left(\frac{1}{\cos x}\right) \left(\frac{\sin x}{\cos x}\right) = \sec x \tan x \Rightarrow \frac{d}{dx}(\sec x) = \sec x \tan x$$

$$(b) y = \csc x = \frac{1}{\sin x} \Rightarrow \frac{dy}{dx} = \frac{(\sin x)(0) - (1)(\cos x)}{(\sin x)^2} = \frac{-\cos x}{\sin^2 x} = \left(\frac{-1}{\sin x}\right) \left(\frac{\cos x}{\sin x}\right) = -\csc x \cot x \Rightarrow \frac{d}{dx}(\csc x) = -\csc x \cot x$$

$$(c) y = \cot x = \frac{\cos x}{\sin x} \Rightarrow \frac{dy}{dx} = \frac{(\sin x)(-\sin x) - (\cos x)(\cos x)}{(\sin x)^2} = \frac{-\sin^2 x - \cos^2 x}{\sin^2 x} = \frac{-1}{\sin^2 x} = -\csc^2 x \Rightarrow \frac{d}{dx}(\cot x) = -\csc^2 x$$

51.

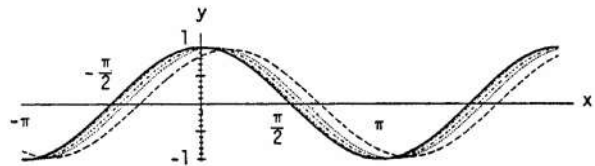
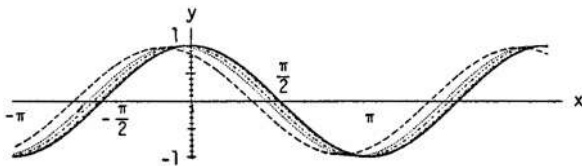

As h takes on the values of 1, 0.5, 0.3 and 0.1 the corresponding dashed curves of $y = \frac{\sin(x+h) - \sin x}{h}$ get closer and closer to the black curve $y = \cos x$ because $\frac{d}{dx}(\sin x) = \lim_{h \rightarrow 0} \frac{\sin(x+h) - \sin x}{h} = \cos x$. The same is true as h takes on the values of $-1, -0.5, -0.3$ and -0.1 .

52.

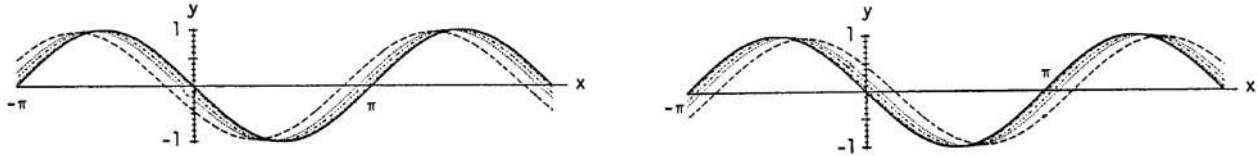

As h takes on the values of 1, 0.5, 0.3, and 0.1 the corresponding dashed curves of $y = \frac{\cos(x+h) - \cos x}{h}$ get closer and closer to the black curve $y = -\sin x$ because $\frac{d}{dx}(\cos x) = \lim_{h \rightarrow 0} \frac{\cos(x+h) - \cos x}{h} = -\sin x$. The same is true as h takes on the values of $-1, -0.5, -0.3,$ and -0.1 .

53. (a)

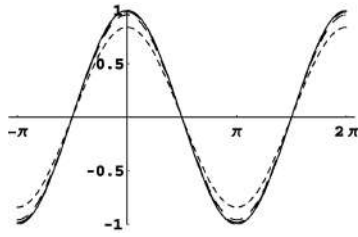

The dashed curves of $y = \frac{\sin(x+h) - \sin(x-h)}{2h}$ are closer to the black curve $y = \cos x$ than the corresponding dashed curves in Exercise 51 illustrating that the centered difference quotient is a better approximation of the derivative of this function.

(b)

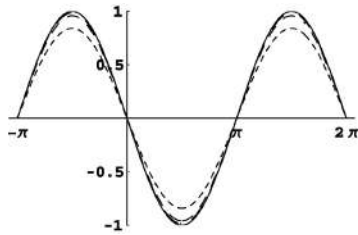

The dashed curves of $y = \frac{\cos(x+h) - \cos(x-h)}{2h}$ are closer to the black curve $y = -\sin x$ than the corresponding dashed curves in Exercise 52 illustrating that the centered difference quotient is a better approximation of the derivative of this function.

54. $\lim_{h \rightarrow 0} \frac{|0+h| - |0-h|}{2h} = \lim_{x \rightarrow 0} \frac{|h| - |-h|}{2h} = \lim_{h \rightarrow 0} 0 = 0 \Rightarrow$ the limits of the centered difference quotient exists even though the derivative of $f(x) = |x|$ does not exist at $x = 0$.

55. $y = \tan x \Rightarrow y' = \sec^2 x$, so the smallest value $y' = \sec^2 x$ takes on is $y' = 1$ when $x = 0$;
 y' has no maximum value since $\sec^2 x$ has no largest value on $(-\frac{\pi}{2}, \frac{\pi}{2})$; y' is never negative since $\sec^2 x \geq 1$.

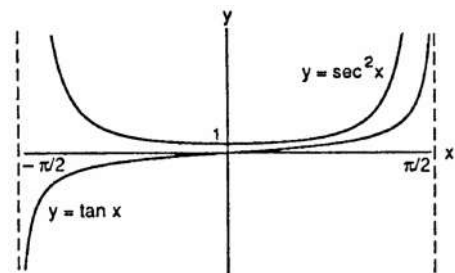

56. $y = \cot x \Rightarrow y' = -\csc^2 x$ so y' has no smallest value since $-\csc^2 x$ has no minimum value on $(0, \pi)$; the largest value of y' is -1 , when $x = \frac{\pi}{2}$; the slope is never positive since the largest value $y' = -\csc^2 x$ takes on is -1 .

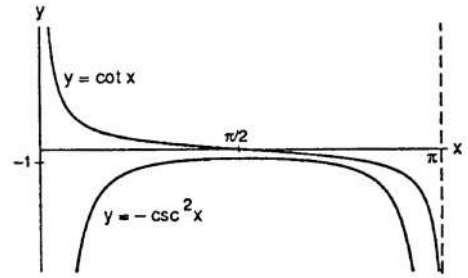

57. $y = \frac{\sin x}{x}$ appears to cross the y-axis at $y = 1$, since $\lim_{x \rightarrow 0} \frac{\sin x}{x} = 1$; $y = \frac{\sin 2x}{x}$ appears to cross the y-axis at $y = 2$, since $\lim_{x \rightarrow 0} \frac{\sin 2x}{x} = 2$; $y = \frac{\sin 4x}{x}$ appears to cross the y-axis at $y = 4$, since $\lim_{x \rightarrow 0} \frac{\sin 4x}{x} = 4$.

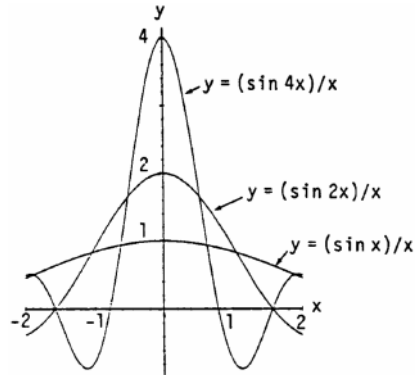

However, none of these graphs actually cross the y-axis since $x = 0$ is not in the domain of the functions. Also,

- $\lim_{x \rightarrow 0} \frac{\sin 5x}{x} = 5$, $\lim_{x \rightarrow 0} \frac{\sin(-3x)}{x} = -3$, and $\lim_{x \rightarrow 0} \frac{\sin kx}{x} = k \Rightarrow$ the graphs of $y = \frac{\sin 5x}{x}$, $y = \frac{\sin(-3x)}{x}$, and $y = \frac{\sin kx}{x}$ approach 5, -3 , and k , respectively, as $x \rightarrow 0$. However, the graphs do not actually cross the y-axis.

58. (a)

h	$\frac{\sin h}{h}$	$\left(\frac{\sin h}{h}\right) \left(\frac{180}{\pi}\right)$
1	.017452406	.99994923
0.01	.017453292	1
0.001	.017453292	1
0.0001	.017453292	1

$$\lim_{h \rightarrow 0} \frac{\sin h^\circ}{h} = \lim_{x \rightarrow 0} \frac{\sin(h \cdot \frac{\pi}{180})}{h} = \lim_{h \rightarrow 0} \frac{\frac{\pi}{180} \sin(h \cdot \frac{\pi}{180})}{\frac{\pi}{180} h} = \lim_{\theta \rightarrow 0} \frac{\frac{\pi}{180} \sin \theta}{\theta} = \frac{\pi}{180} \quad (\theta = h \cdot \frac{\pi}{180})$$

(converting to radians)

(b)

h	$\frac{\cos h - 1}{h}$
1	-0.0001523
0.01	-0.0000015
0.001	-0.0000001
0.0001	0

$\lim_{h \rightarrow 0} \frac{\cos h - 1}{h} = 0$, whether h is measured in degrees or radians.

(c) In degrees, $\frac{d}{dx} (\sin x) = \lim_{h \rightarrow 0} \frac{\sin(x+h) - \sin x}{h} = \lim_{h \rightarrow 0} \frac{(\sin x \cos h + \cos x \sin h) - \sin x}{h}$
 $= \lim_{h \rightarrow 0} \left(\sin x \cdot \frac{\cos h - 1}{h} \right) + \lim_{h \rightarrow 0} \left(\cos x \cdot \frac{\sin h}{h} \right) = (\sin x) \cdot \lim_{h \rightarrow 0} \left(\frac{\cos h - 1}{h} \right) + (\cos x) \cdot \lim_{h \rightarrow 0} \left(\frac{\sin h}{h} \right)$
 $= (\sin x)(0) + (\cos x) \left(\frac{\pi}{180} \right) = \frac{\pi}{180} \cos x$

(d) In degrees, $\frac{d}{dx} (\cos x) = \lim_{h \rightarrow 0} \frac{\cos(x+h) - \cos x}{h} = \lim_{h \rightarrow 0} \frac{(\cos x \cos h - \sin x \sin h) - \cos x}{h}$
 $= \lim_{h \rightarrow 0} \frac{(\cos x)(\cos h - 1) - \sin x \sin h}{h} = \lim_{h \rightarrow 0} \left(\cos x \cdot \frac{\cos h - 1}{h} \right) - \lim_{h \rightarrow 0} \left(\sin x \cdot \frac{\sin h}{h} \right)$
 $= (\cos x) \lim_{h \rightarrow 0} \left(\frac{\cos h - 1}{h} \right) - (\sin x) \lim_{h \rightarrow 0} \left(\frac{\sin h}{h} \right) = (\cos x)(0) - (\sin x) \left(\frac{\pi}{180} \right) = -\frac{\pi}{180} \sin x$

(e) $\frac{d^2}{dx^2} (\sin x) = \frac{d}{dx} \left(\frac{\pi}{180} \cos x \right) = -\left(\frac{\pi}{180} \right)^2 \sin x$; $\frac{d^3}{dx^3} (\sin x) = \frac{d}{dx} \left(-\left(\frac{\pi}{180} \right)^2 \sin x \right) = -\left(\frac{\pi}{180} \right)^3 \cos x$;
 $\frac{d^2}{dx^2} (\cos x) = \frac{d}{dx} \left(-\frac{\pi}{180} \sin x \right) = -\left(\frac{\pi}{180} \right)^2 \cos x$; $\frac{d^3}{dx^3} (\cos x) = \frac{d}{dx} \left(-\left(\frac{\pi}{180} \right)^2 \cos x \right) = \left(\frac{\pi}{180} \right)^3 \sin x$

3.5 THE CHAIN RULE AND PARAMETRIC EQUATIONS

1. $f(u) = 6u - 9 \Rightarrow f'(u) = 6 \Rightarrow f'(g(x)) = 6$; $g(x) = \frac{1}{2}x^4 \Rightarrow g'(x) = 2x^3$; therefore $\frac{dy}{dx} = f'(g(x))g'(x) = 6 \cdot 2x^3 = 12x^3$
2. $f(u) = 2u^3 \Rightarrow f'(u) = 6u^2 \Rightarrow f'(g(x)) = 6(8x - 1)^2$; $g(x) = 8x - 1 \Rightarrow g'(x) = 8$; therefore $\frac{dy}{dx} = f'(g(x))g'(x) = 6(8x - 1)^2 \cdot 8 = 48(8x - 1)^2$
3. $f(u) = \sin u \Rightarrow f'(u) = \cos u \Rightarrow f'(g(x)) = \cos(3x + 1)$; $g(x) = 3x + 1 \Rightarrow g'(x) = 3$; therefore $\frac{dy}{dx} = f'(g(x))g'(x) = (\cos(3x + 1))(3) = 3 \cos(3x + 1)$
4. $f(u) = \cos u \Rightarrow f'(u) = -\sin u \Rightarrow f'(g(x)) = -\sin\left(\frac{-x}{3}\right)$; $g(x) = \frac{-x}{3} \Rightarrow g'(x) = -\frac{1}{3}$; therefore $\frac{dy}{dx} = f'(g(x))g'(x) = -\sin\left(\frac{-x}{3}\right) \cdot \left(-\frac{1}{3}\right) = \frac{1}{3} \sin\left(\frac{-x}{3}\right)$
5. $f(u) = \cos u \Rightarrow f'(u) = -\sin u \Rightarrow f'(g(x)) = -\sin(\sin x)$; $g(x) = \sin x \Rightarrow g'(x) = \cos x$; therefore $\frac{dy}{dx} = f'(g(x))g'(x) = -(\sin(\sin x)) \cos x$
6. $f(u) = \sin u \Rightarrow f'(u) = \cos u \Rightarrow f'(g(x)) = \cos(x - \cos x)$; $g(x) = x - \cos x \Rightarrow g'(x) = 1 + \sin x$; therefore $\frac{dy}{dx} = f'(g(x))g'(x) = (\cos(x - \cos x))(1 + \sin x)$
7. $f(u) = \tan u \Rightarrow f'(u) = \sec^2 u \Rightarrow f'(g(x)) = \sec^2(10x - 5)$; $g(x) = 10x - 5 \Rightarrow g'(x) = 10$; therefore $\frac{dy}{dx} = f'(g(x))g'(x) = (\sec^2(10x - 5))(10) = 10 \sec^2(10x - 5)$
8. $f(u) = -\sec u \Rightarrow f'(u) = -\sec u \tan u \Rightarrow f'(g(x)) = -\sec(x^2 + 7x) \tan(x^2 + 7x)$; $g(x) = x^2 + 7x \Rightarrow g'(x) = 2x + 7$; therefore $\frac{dy}{dx} = f'(g(x))g'(x) = -(2x + 7) \sec(x^2 + 7x) \tan(x^2 + 7x)$
9. With $u = (2x + 1)$, $y = u^5$: $\frac{dy}{dx} = \frac{dy}{du} \frac{du}{dx} = 5u^4 \cdot 2 = 10(2x + 1)^4$
10. With $u = (4 - 3x)$, $y = u^9$: $\frac{dy}{dx} = \frac{dy}{du} \frac{du}{dx} = 9u^8 \cdot (-3) = -27(4 - 3x)^8$
11. With $u = \left(1 - \frac{x}{7}\right)$, $y = u^{-7}$: $\frac{dy}{dx} = \frac{dy}{du} \frac{du}{dx} = -7u^{-8} \cdot \left(-\frac{1}{7}\right) = \left(1 - \frac{x}{7}\right)^{-8}$
12. With $u = \left(\frac{x}{2} - 1\right)$, $y = u^{-10}$: $\frac{dy}{dx} = \frac{dy}{du} \frac{du}{dx} = -10u^{-11} \cdot \left(\frac{1}{2}\right) = -5 \left(\frac{x}{2} - 1\right)^{-11}$
13. With $u = \left(\frac{x^2}{8} + x - \frac{1}{x}\right)$, $y = u^4$: $\frac{dy}{dx} = \frac{dy}{du} \frac{du}{dx} = 4u^3 \cdot \left(\frac{x}{4} + 1 + \frac{1}{x^2}\right) = 4 \left(\frac{x^2}{8} + x - \frac{1}{x}\right)^3 \left(\frac{x}{4} + 1 + \frac{1}{x^2}\right)$
14. With $u = \left(\frac{x}{5} + \frac{1}{5x}\right)$, $y = u^5$: $\frac{dy}{dx} = \frac{dy}{du} \frac{du}{dx} = 5u^4 \cdot \left(\frac{1}{5} - \frac{1}{5x^2}\right) = \left(\frac{x}{5} + \frac{1}{5x}\right)^4 \left(1 - \frac{1}{x^2}\right)$
15. With $u = \tan x$, $y = \sec u$: $\frac{dy}{dx} = \frac{dy}{du} \frac{du}{dx} = (\sec u \tan u)(\sec^2 x) = (\sec(\tan x) \tan(\tan x)) \sec^2 x$
16. With $u = \pi - \frac{1}{x}$, $y = \cot u$: $\frac{dy}{dx} = \frac{dy}{du} \frac{du}{dx} = (-\csc^2 u) \left(\frac{1}{x^2}\right) = -\frac{1}{x^2} \csc^2\left(\pi - \frac{1}{x}\right)$
17. With $u = \sin x$, $y = u^3$: $\frac{dy}{dx} = \frac{dy}{du} \frac{du}{dx} = 3u^2 \cos x = 3(\sin^2 x)(\cos x)$
18. With $u = \cos x$, $y = 5u^{-4}$: $\frac{dy}{dx} = \frac{dy}{du} \frac{du}{dx} = (-20u^{-5})(-\sin x) = 20(\cos^{-5} x)(\sin x)$

$$19. p = \sqrt{3-t} = (3-t)^{1/2} \Rightarrow \frac{dp}{dt} = \frac{1}{2}(3-t)^{-1/2} \cdot \frac{d}{dt}(3-t) = -\frac{1}{2}(3-t)^{-1/2} = \frac{-1}{2\sqrt{3-t}}$$

$$20. q = \sqrt{2r-r^2} = (2r-r^2)^{1/2} \Rightarrow \frac{dq}{dr} = \frac{1}{2}(2r-r^2)^{-1/2} \cdot \frac{d}{dr}(2r-r^2) = \frac{1}{2}(2r-r^2)^{-1/2}(2-2r) = \frac{1-r}{\sqrt{2r-r^2}}$$

$$21. s = \frac{4}{3\pi} \sin 3t + \frac{4}{5\pi} \cos 5t \Rightarrow \frac{ds}{dt} = \frac{4}{3\pi} \cos 3t \cdot \frac{d}{dt}(3t) + \frac{4}{5\pi} (-\sin 5t) \cdot \frac{d}{dt}(5t) = \frac{4}{\pi} \cos 3t - \frac{4}{\pi} \sin 5t \\ = \frac{4}{\pi} (\cos 3t - \sin 5t)$$

$$22. s = \sin\left(\frac{3\pi t}{2}\right) + \cos\left(\frac{3\pi t}{2}\right) \Rightarrow \frac{ds}{dt} = \cos\left(\frac{3\pi t}{2}\right) \cdot \frac{d}{dt}\left(\frac{3\pi t}{2}\right) - \sin\left(\frac{3\pi t}{2}\right) \cdot \frac{d}{dt}\left(\frac{3\pi t}{2}\right) = \frac{3\pi}{2} \cos\left(\frac{3\pi t}{2}\right) - \frac{3\pi}{2} \sin\left(\frac{3\pi t}{2}\right) \\ = \frac{3\pi}{2} \left(\cos \frac{3\pi t}{2} - \sin \frac{3\pi t}{2}\right)$$

$$23. r = (\csc \theta + \cot \theta)^{-1} \Rightarrow \frac{dr}{d\theta} = -(\csc \theta + \cot \theta)^{-2} \frac{d}{d\theta}(\csc \theta + \cot \theta) = \frac{\csc \theta \cot \theta + \csc^2 \theta}{(\csc \theta + \cot \theta)^2} = \frac{\csc \theta (\cot \theta + \csc \theta)}{(\csc \theta + \cot \theta)^2} \\ = \frac{\csc \theta}{\csc \theta + \cot \theta}$$

$$24. r = -(\sec \theta + \tan \theta)^{-1} \Rightarrow \frac{dr}{d\theta} = (\sec \theta + \tan \theta)^{-2} \frac{d}{d\theta}(\sec \theta + \tan \theta) = \frac{\sec \theta \tan \theta + \sec^2 \theta}{(\sec \theta + \tan \theta)^2} = \frac{\sec \theta (\tan \theta + \sec \theta)}{(\sec \theta + \tan \theta)^2} \\ = \frac{\sec \theta}{\sec \theta + \tan \theta}$$

$$25. y = x^2 \sin^4 x + x \cos^{-2} x \Rightarrow \frac{dy}{dx} = x^2 \frac{d}{dx}(\sin^4 x) + \sin^4 x \cdot \frac{d}{dx}(x^2) + x \frac{d}{dx}(\cos^{-2} x) + \cos^{-2} x \cdot \frac{d}{dx}(x) \\ = x^2 \left(4 \sin^3 x \frac{d}{dx}(\sin x)\right) + 2x \sin^4 x + x(-2 \cos^{-3} x \cdot \frac{d}{dx}(\cos x)) + \cos^{-2} x \\ = x^2(4 \sin^3 x \cos x) + 2x \sin^4 x + x(-2 \cos^{-3} x)(-\sin x) + \cos^{-2} x \\ = 4x^2 \sin^3 x \cos x + 2x \sin^4 x + 2x \sin x \cos^{-3} x + \cos^{-2} x$$

$$26. y = \frac{1}{x} \sin^{-5} x - \frac{x}{3} \cos^3 x \Rightarrow y' = \frac{1}{x} \frac{d}{dx}(\sin^{-5} x) + \sin^{-5} x \cdot \frac{d}{dx}\left(\frac{1}{x}\right) - \frac{x}{3} \frac{d}{dx}(\cos^3 x) - \cos^3 x \cdot \frac{d}{dx}\left(\frac{x}{3}\right) \\ = \frac{1}{x}(-5 \sin^{-6} x \cos x) + (\sin^{-5} x)\left(-\frac{1}{x^2}\right) - \frac{x}{3}((3 \cos^2 x)(-\sin x)) - (\cos^3 x)\left(\frac{1}{3}\right) \\ = -\frac{5}{x} \sin^{-6} x \cos x - \frac{1}{x^2} \sin^{-5} x + x \cos^2 x \sin x - \frac{1}{3} \cos^3 x$$

$$27. y = \frac{1}{21}(3x-2)^7 + \left(4 - \frac{1}{2x^2}\right)^{-1} \Rightarrow \frac{dy}{dx} = \frac{7}{21}(3x-2)^6 \cdot \frac{d}{dx}(3x-2) + (-1)\left(4 - \frac{1}{2x^2}\right)^{-2} \cdot \frac{d}{dx}\left(4 - \frac{1}{2x^2}\right) \\ = \frac{7}{21}(3x-2)^6 \cdot 3 + (-1)\left(4 - \frac{1}{2x^2}\right)^{-2} \left(\frac{1}{x^3}\right) = (3x-2)^6 - \frac{1}{x^3\left(4 - \frac{1}{2x^2}\right)^2}$$

$$28. y = (5-2x)^{-3} + \frac{1}{8}\left(\frac{2}{x} + 1\right)^4 \Rightarrow \frac{dy}{dx} = -3(5-2x)^{-4}(-2) + \frac{4}{8}\left(\frac{2}{x} + 1\right)^3 \left(-\frac{2}{x^2}\right) = 6(5-2x)^{-4} - \left(\frac{1}{x^2}\right)\left(\frac{2}{x} + 1\right)^3 \\ = \frac{6}{(5-2x)^4} - \frac{\left(\frac{2}{x} + 1\right)^3}{x^2}$$

$$29. y = (4x+3)^4(x+1)^{-3} \Rightarrow \frac{dy}{dx} = (4x+3)^4(-3)(x+1)^{-4} \cdot \frac{d}{dx}(x+1) + (x+1)^{-3}(4)(4x+3)^3 \cdot \frac{d}{dx}(4x+3) \\ = (4x+3)^4(-3)(x+1)^{-4}(1) + (x+1)^{-3}(4)(4x+3)^3(4) = -3(4x+3)^4(x+1)^{-4} + 16(4x+3)^3(x+1)^{-3} \\ = \frac{(4x+3)^3}{(x+1)^4}[-3(4x+3) + 16(x+1)] = \frac{(4x+3)^3(4x+7)}{(x+1)^4}$$

$$30. y = (2x-5)^{-1}(x^2-5x)^6 \Rightarrow \frac{dy}{dx} = (2x-5)^{-1}(6)(x^2-5x)^5(2x-5) + (x^2-5x)^6(-1)(2x-5)^{-2}(2) \\ = 6(x^2-5x)^5 - \frac{2(x^2-5x)^6}{(2x-5)^2}$$

$$31. h(x) = x \tan(2\sqrt{x}) + 7 \Rightarrow h'(x) = x \frac{d}{dx}(\tan(2x^{1/2})) + \tan(2x^{1/2}) \cdot \frac{d}{dx}(x) + 0 \\ = x \sec^2(2x^{1/2}) \cdot \frac{d}{dx}(2x^{1/2}) + \tan(2x^{1/2}) = x \sec^2(2\sqrt{x}) \cdot \frac{1}{\sqrt{x}} + \tan(2\sqrt{x}) = \sqrt{x} \sec^2(2\sqrt{x}) + \tan(2\sqrt{x})$$

150 Chapter 3 Differentiation

$$32. k(x) = x^2 \sec\left(\frac{1}{x}\right) \Rightarrow k'(x) = x^2 \frac{d}{dx}\left(\sec\left(\frac{1}{x}\right)\right) + \sec\left(\frac{1}{x}\right) \cdot \frac{d}{dx}(x^2) = x^2 \sec\left(\frac{1}{x}\right) \tan\left(\frac{1}{x}\right) \cdot \frac{d}{dx}\left(\frac{1}{x}\right) + 2x \sec\left(\frac{1}{x}\right) \\ = x^2 \sec\left(\frac{1}{x}\right) \tan\left(\frac{1}{x}\right) \cdot \left(-\frac{1}{x^2}\right) + 2x \sec\left(\frac{1}{x}\right) = 2x \sec\left(\frac{1}{x}\right) - \sec\left(\frac{1}{x}\right) \tan\left(\frac{1}{x}\right)$$

$$33. f(\theta) = \left(\frac{\sin \theta}{1 + \cos \theta}\right)^2 \Rightarrow f'(\theta) = 2\left(\frac{\sin \theta}{1 + \cos \theta}\right) \cdot \frac{d}{d\theta}\left(\frac{\sin \theta}{1 + \cos \theta}\right) = \frac{2 \sin \theta}{1 + \cos \theta} \cdot \frac{(1 + \cos \theta)(\cos \theta) - (\sin \theta)(-\sin \theta)}{(1 + \cos \theta)^2} \\ = \frac{(2 \sin \theta)(\cos \theta + \cos^2 \theta + \sin^2 \theta)}{(1 + \cos \theta)^3} = \frac{(2 \sin \theta)(\cos \theta + 1)}{(1 + \cos \theta)^3} = \frac{2 \sin \theta}{(1 + \cos \theta)^2}$$

$$34. g(t) = \left(\frac{1 + \cos t}{\sin t}\right)^{-1} \Rightarrow g'(t) = -\left(\frac{1 + \cos t}{\sin t}\right)^{-2} \cdot \frac{d}{dt}\left(\frac{1 + \cos t}{\sin t}\right) = -\frac{\sin^2 t}{(1 + \cos t)^2} \cdot \frac{(\sin t)(-\sin t) - (1 + \cos t)(\cos t)}{(\sin t)^2} \\ = \frac{-(-\sin^2 t - \cos t - \cos^2 t)}{(1 + \cos t)^2} = \frac{1}{1 + \cos t}$$

$$35. r = \sin(\theta^2) \cos(2\theta) \Rightarrow \frac{dr}{d\theta} = \sin(\theta^2)(-\sin 2\theta) \frac{d}{d\theta}(2\theta) + \cos(2\theta)(\cos(\theta^2)) \cdot \frac{d}{d\theta}(\theta^2) \\ = \sin(\theta^2)(-\sin 2\theta)(2) + (\cos 2\theta)(\cos(\theta^2))(2\theta) = -2 \sin(\theta^2) \sin(2\theta) + 2\theta \cos(2\theta) \cos(\theta^2)$$

$$36. r = \left(\sec \sqrt{\theta}\right) \tan\left(\frac{1}{\theta}\right) \Rightarrow \frac{dr}{d\theta} = \left(\sec \sqrt{\theta}\right) \left(\sec^2 \frac{1}{\theta}\right) \left(-\frac{1}{\theta^2}\right) + \tan\left(\frac{1}{\theta}\right) \left(\sec \sqrt{\theta} \tan \sqrt{\theta}\right) \left(\frac{1}{2\sqrt{\theta}}\right) \\ = -\frac{1}{\theta^2} \sec \sqrt{\theta} \sec^2\left(\frac{1}{\theta}\right) + \frac{1}{2\sqrt{\theta}} \tan\left(\frac{1}{\theta}\right) \sec \sqrt{\theta} \tan \sqrt{\theta} = \left(\sec \sqrt{\theta}\right) \left[\frac{\tan \sqrt{\theta} \tan\left(\frac{1}{\theta}\right)}{2\sqrt{\theta}} - \frac{\sec^2\left(\frac{1}{\theta}\right)}{\theta^2}\right]$$

$$37. q = \sin\left(\frac{t}{\sqrt{t+1}}\right) \Rightarrow \frac{dq}{dt} = \cos\left(\frac{t}{\sqrt{t+1}}\right) \cdot \frac{d}{dt}\left(\frac{t}{\sqrt{t+1}}\right) = \cos\left(\frac{t}{\sqrt{t+1}}\right) \cdot \frac{\sqrt{t+1}(1) - t \cdot \frac{d}{dt}(\sqrt{t+1})}{(\sqrt{t+1})^2} \\ = \cos\left(\frac{t}{\sqrt{t+1}}\right) \cdot \frac{\sqrt{t+1} - \frac{t}{2\sqrt{t+1}}}{t+1} = \cos\left(\frac{t}{\sqrt{t+1}}\right) \left(\frac{2(t+1) - t}{2(t+1)^{3/2}}\right) = \left(\frac{t+2}{2(t+1)^{3/2}}\right) \cos\left(\frac{t}{\sqrt{t+1}}\right)$$

$$38. q = \cot\left(\frac{\sin t}{t}\right) \Rightarrow \frac{dq}{dt} = -\csc^2\left(\frac{\sin t}{t}\right) \cdot \frac{d}{dt}\left(\frac{\sin t}{t}\right) = \left(-\csc^2\left(\frac{\sin t}{t}\right)\right) \left(\frac{t \cos t - \sin t}{t^2}\right)$$

$$39. y = \sin^2(\pi t - 2) \Rightarrow \frac{dy}{dt} = 2 \sin(\pi t - 2) \cdot \frac{d}{dt} \sin(\pi t - 2) = 2 \sin(\pi t - 2) \cdot \cos(\pi t - 2) \cdot \frac{d}{dt}(\pi t - 2) \\ = 2\pi \sin(\pi t - 2) \cos(\pi t - 2)$$

$$40. y = \sec^2 \pi t \Rightarrow \frac{dy}{dt} = (2 \sec \pi t) \cdot \frac{d}{dt}(\sec \pi t) = (2 \sec \pi t)(\sec \pi t \tan \pi t) \cdot \frac{d}{dt}(\pi t) = 2\pi \sec^2 \pi t \tan \pi t$$

$$41. y = (1 + \cos 2t)^{-4} \Rightarrow \frac{dy}{dt} = -4(1 + \cos 2t)^{-5} \cdot \frac{d}{dt}(1 + \cos 2t) = -4(1 + \cos 2t)^{-5}(-\sin 2t) \cdot \frac{d}{dt}(2t) = \frac{8 \sin 2t}{(1 + \cos 2t)^5}$$

$$42. y = \left(1 + \cot\left(\frac{1}{2}\right)\right)^{-2} \Rightarrow \frac{dy}{dt} = -2\left(1 + \cot\left(\frac{1}{2}\right)\right)^{-3} \cdot \frac{d}{dt}\left(1 + \cot\left(\frac{1}{2}\right)\right) = -2\left(1 + \cot\left(\frac{1}{2}\right)\right)^{-3} \cdot \left(-\csc^2\left(\frac{1}{2}\right)\right) \cdot \frac{d}{dt}\left(\frac{1}{2}\right) \\ = \frac{\csc^2\left(\frac{1}{2}\right)}{\left(1 + \cot\left(\frac{1}{2}\right)\right)^3}$$

$$43. y = \sin(\cos(2t - 5)) \Rightarrow \frac{dy}{dt} = \cos(\cos(2t - 5)) \cdot \frac{d}{dt} \cos(2t - 5) = \cos(\cos(2t - 5)) \cdot (-\sin(2t - 5)) \cdot \frac{d}{dt}(2t - 5) \\ = -2 \cos(\cos(2t - 5))(\sin(2t - 5))$$

$$44. y = \cos\left(5 \sin\left(\frac{1}{3}\right)\right) \Rightarrow \frac{dy}{dt} = -\sin\left(5 \sin\left(\frac{1}{3}\right)\right) \cdot \frac{d}{dt}\left(5 \sin\left(\frac{1}{3}\right)\right) = -\sin\left(5 \sin\left(\frac{1}{3}\right)\right) \left(5 \cos\left(\frac{1}{3}\right)\right) \cdot \frac{d}{dt}\left(\frac{1}{3}\right) \\ = -\frac{5}{3} \sin\left(5 \sin\left(\frac{1}{3}\right)\right) \left(\cos\left(\frac{1}{3}\right)\right)$$

$$45. y = \left[1 + \tan^4\left(\frac{1}{12}\right)\right]^3 \Rightarrow \frac{dy}{dt} = 3\left[1 + \tan^4\left(\frac{1}{12}\right)\right]^2 \cdot \frac{d}{dt}\left[1 + \tan^4\left(\frac{1}{12}\right)\right] = 3\left[1 + \tan^4\left(\frac{1}{12}\right)\right]^2 \left[4 \tan^3\left(\frac{1}{12}\right) \cdot \frac{d}{dt} \tan\left(\frac{1}{12}\right)\right] \\ = 12\left[1 + \tan^4\left(\frac{1}{12}\right)\right]^2 \left[\tan^3\left(\frac{1}{12}\right) \sec^2\left(\frac{1}{12}\right) \cdot \frac{1}{12}\right] = \left[1 + \tan^4\left(\frac{1}{12}\right)\right]^2 \left[\tan^3\left(\frac{1}{12}\right) \sec^2\left(\frac{1}{12}\right)\right]$$

$$46. y = \frac{1}{6} [1 + \cos^2(7t)]^3 \Rightarrow \frac{dy}{dt} = \frac{3}{6} [1 + \cos^2(7t)]^2 \cdot 2 \cos(7t)(-\sin(7t))(7) = -7 [1 + \cos^2(7t)]^2 (\cos(7t) \sin(7t))$$

$$47. y = (1 + \cos(t^2))^{1/2} \Rightarrow \frac{dy}{dt} = \frac{1}{2} (1 + \cos(t^2))^{-1/2} \cdot \frac{d}{dt} (1 + \cos(t^2)) = \frac{1}{2} (1 + \cos(t^2))^{-1/2} (-\sin(t^2) \cdot \frac{d}{dt} (t^2)) \\ = -\frac{1}{2} (1 + \cos(t^2))^{-1/2} (\sin(t^2)) \cdot 2t = -\frac{t \sin(t^2)}{\sqrt{1 + \cos(t^2)}}$$

$$48. y = 4 \sin(\sqrt{1 + \sqrt{t}}) \Rightarrow \frac{dy}{dt} = 4 \cos(\sqrt{1 + \sqrt{t}}) \cdot \frac{d}{dt} (\sqrt{1 + \sqrt{t}}) = 4 \cos(\sqrt{1 + \sqrt{t}}) \cdot \frac{1}{2\sqrt{1 + \sqrt{t}}} \cdot \frac{d}{dt} (1 + \sqrt{t}) \\ = \frac{2 \cos(\sqrt{1 + \sqrt{t}})}{\sqrt{1 + \sqrt{t}} \cdot 2\sqrt{t}} = \frac{\cos(\sqrt{1 + \sqrt{t}})}{\sqrt{t + \sqrt{t}}}$$

$$49. y = (1 + \frac{1}{x})^3 \Rightarrow y' = 3(1 + \frac{1}{x})^2 (-\frac{1}{x^2}) = -\frac{3}{x^2} (1 + \frac{1}{x})^2 \Rightarrow y'' = (-\frac{3}{x^2}) \cdot \frac{d}{dx} (1 + \frac{1}{x})^2 - (1 + \frac{1}{x})^2 \cdot \frac{d}{dx} (\frac{3}{x^2}) \\ = (-\frac{3}{x^2}) (2(1 + \frac{1}{x})(-\frac{1}{x^2})) + (\frac{6}{x^3}) (1 + \frac{1}{x})^2 = \frac{6}{x^4} (1 + \frac{1}{x}) + \frac{6}{x^3} (1 + \frac{1}{x})^2 = \frac{6}{x^3} (1 + \frac{1}{x}) (\frac{1}{x} + 1 + \frac{1}{x}) \\ = \frac{6}{x^3} (1 + \frac{1}{x}) (1 + \frac{2}{x})$$

$$50. y = (1 - \sqrt{x})^{-1} \Rightarrow y' = -(1 - \sqrt{x})^{-2} (-\frac{1}{2} x^{-1/2}) = \frac{1}{2} (1 - \sqrt{x})^{-2} x^{-1/2} \\ \Rightarrow y'' = \frac{1}{2} \left[(1 - \sqrt{x})^{-2} (-\frac{1}{2} x^{-3/2}) + x^{-1/2} (-2) (1 - \sqrt{x})^{-3} (-\frac{1}{2} x^{-1/2}) \right] \\ = \frac{1}{2} \left[\frac{-1}{2} x^{-3/2} (1 - \sqrt{x})^{-2} + x^{-1} (1 - \sqrt{x})^{-3} \right] = \frac{1}{2} x^{-1} (1 - \sqrt{x})^{-3} \left[-\frac{1}{2} x^{-1/2} (1 - \sqrt{x}) + 1 \right] \\ = \frac{1}{2x} (1 - \sqrt{x})^{-3} \left(-\frac{1}{2\sqrt{x}} + \frac{1}{2} + 1 \right) = \frac{1}{2x} (1 - \sqrt{x})^{-3} \left(\frac{3}{2} - \frac{1}{2\sqrt{x}} \right)$$

$$51. y = \frac{1}{9} \cot(3x - 1) \Rightarrow y' = -\frac{1}{9} \csc^2(3x - 1)(3) = -\frac{1}{3} \csc^2(3x - 1) \Rightarrow y'' = (-\frac{2}{3}) (\csc(3x - 1) \cdot \frac{d}{dx} \csc(3x - 1)) \\ = -\frac{2}{3} \csc(3x - 1) (-\csc(3x - 1) \cot(3x - 1) \cdot \frac{d}{dx} (3x - 1)) = 2 \csc^2(3x - 1) \cot(3x - 1)$$

$$52. y = 9 \tan(\frac{x}{3}) \Rightarrow y' = 9 (\sec^2(\frac{x}{3})) (\frac{1}{3}) = 3 \sec^2(\frac{x}{3}) \Rightarrow y'' = 3 \cdot 2 \sec(\frac{x}{3}) (\sec(\frac{x}{3}) \tan(\frac{x}{3})) (\frac{1}{3}) = 2 \sec^2(\frac{x}{3}) \tan(\frac{x}{3})$$

$$53. g(x) = \sqrt{x} \Rightarrow g'(x) = \frac{1}{2\sqrt{x}} \Rightarrow g(1) = 1 \text{ and } g'(1) = \frac{1}{2}; f(u) = u^5 + 1 \Rightarrow f'(u) = 5u^4 \Rightarrow f'(g(1)) = f'(1) = 5; \\ \text{therefore, } (f \circ g)'(1) = f'(g(1)) \cdot g'(1) = 5 \cdot \frac{1}{2} = \frac{5}{2}$$

$$54. g(x) = (1 - x)^{-1} \Rightarrow g'(x) = -(1 - x)^{-2} (-1) = \frac{1}{(1 - x)^2} \Rightarrow g(-1) = \frac{1}{2} \text{ and } g'(-1) = \frac{1}{4}; f(u) = 1 - \frac{1}{u} \\ \Rightarrow f'(u) = \frac{1}{u^2} \Rightarrow f'(g(-1)) = f'(\frac{1}{2}) = 4; \text{ therefore, } (f \circ g)'(-1) = f'(g(-1))g'(-1) = 4 \cdot \frac{1}{4} = 1$$

$$55. g(x) = 5\sqrt{x} \Rightarrow g'(x) = \frac{5}{2\sqrt{x}} \Rightarrow g(1) = 5 \text{ and } g'(1) = \frac{5}{2}; f(u) = \cot(\frac{\pi u}{10}) \Rightarrow f'(u) = -\csc^2(\frac{\pi u}{10}) (\frac{\pi}{10}) \\ = -\frac{\pi}{10} \csc^2(\frac{\pi u}{10}) \Rightarrow f'(g(1)) = f'(5) = -\frac{\pi}{10} \csc^2(\frac{\pi}{2}) = -\frac{\pi}{10}; \text{ therefore, } (f \circ g)'(1) = f'(g(1))g'(1) = -\frac{\pi}{10} \cdot \frac{5}{2} \\ = -\frac{\pi}{4}$$

$$56. g(x) = \pi x \Rightarrow g'(x) = \pi \Rightarrow g(\frac{1}{4}) = \frac{\pi}{4} \text{ and } g'(\frac{1}{4}) = \pi; f(u) = u + \sec^2 u \Rightarrow f'(u) = 1 + 2 \sec u \cdot \sec u \tan u \\ = 1 + 2 \sec^2 u \tan u \Rightarrow f'(g(\frac{1}{4})) = f'(\frac{\pi}{4}) = 1 + 2 \sec^2 \frac{\pi}{4} \tan \frac{\pi}{4} = 5; \text{ therefore, } (f \circ g)'(\frac{1}{4}) = f'(g(\frac{1}{4}))g'(\frac{1}{4}) = 5\pi$$

$$57. g(x) = 10x^2 + x + 1 \Rightarrow g'(x) = 20x + 1 \Rightarrow g(0) = 1 \text{ and } g'(0) = 1; f(u) = \frac{2u}{u^2 + 1} \Rightarrow f'(u) = \frac{(u^2 + 1)(2) - (2u)(2u)}{(u^2 + 1)^2} \\ = \frac{-2u^2 + 2}{(u^2 + 1)^2} \Rightarrow f'(g(0)) = f'(1) = 0; \text{ therefore, } (f \circ g)'(0) = f'(g(0))g'(0) = 0 \cdot 1 = 0$$

$$58. g(x) = \frac{1}{x^2} - 1 \Rightarrow g'(x) = -\frac{2}{x^3} \Rightarrow g(-1) = 0 \text{ and } g'(-1) = 2; f(u) = (\frac{u-1}{u+1})^2 \Rightarrow f'(u) = 2(\frac{u-1}{u+1}) \frac{d}{du} (\frac{u-1}{u+1}) \\ = 2(\frac{u-1}{u+1}) \cdot \frac{(u+1)(1) - (u-1)(1)}{(u+1)^2} = \frac{2(u-1)(2)}{(u+1)^3} = \frac{4(u-1)}{(u+1)^3} \Rightarrow f'(g(-1)) = f'(0) = -4; \text{ therefore, } \\ (f \circ g)'(-1) = f'(g(-1))g'(-1) = (-4)(2) = -8$$

59. (a) $y = 2f(x) \Rightarrow \frac{dy}{dx} = 2f'(x) \Rightarrow \left. \frac{dy}{dx} \right|_{x=2} = 2f'(2) = 2\left(\frac{1}{3}\right) = \frac{2}{3}$
- (b) $y = f(x) + g(x) \Rightarrow \frac{dy}{dx} = f'(x) + g'(x) \Rightarrow \left. \frac{dy}{dx} \right|_{x=3} = f'(3) + g'(3) = 2\pi + 5$
- (c) $y = f(x) \cdot g(x) \Rightarrow \frac{dy}{dx} = f(x)g'(x) + g(x)f'(x) \Rightarrow \left. \frac{dy}{dx} \right|_{x=3} = f(3)g'(3) + g(3)f'(3) = 3 \cdot 5 + (-4)(2\pi) = 15 - 8\pi$
- (d) $y = \frac{f(x)}{g(x)} \Rightarrow \frac{dy}{dx} = \frac{g(x)f'(x) - f(x)g'(x)}{[g(x)]^2} \Rightarrow \left. \frac{dy}{dx} \right|_{x=2} = \frac{g(2)f'(2) - f(2)g'(2)}{[g(2)]^2} = \frac{(2)\left(\frac{1}{3}\right) - (8)(-3)}{2^2} = \frac{37}{6}$
- (e) $y = f(g(x)) \Rightarrow \frac{dy}{dx} = f'(g(x))g'(x) \Rightarrow \left. \frac{dy}{dx} \right|_{x=2} = f'(g(2))g'(2) = f'(2)(-3) = \frac{1}{3}(-3) = -1$
- (f) $y = (f(x))^{1/2} \Rightarrow \frac{dy}{dx} = \frac{1}{2}(f(x))^{-1/2} \cdot f'(x) = \frac{f'(x)}{2\sqrt{f(x)}} \Rightarrow \left. \frac{dy}{dx} \right|_{x=2} = \frac{f'(2)}{2\sqrt{f(2)}} = \frac{\left(\frac{1}{3}\right)}{2\sqrt{8}} = \frac{1}{6\sqrt{8}} = \frac{1}{12\sqrt{2}} = \frac{\sqrt{2}}{24}$
- (g) $y = (g(x))^{-2} \Rightarrow \frac{dy}{dx} = -2(g(x))^{-3} \cdot g'(x) \Rightarrow \left. \frac{dy}{dx} \right|_{x=3} = -2(g(3))^{-3}g'(3) = -2(-4)^{-3} \cdot 5 = \frac{5}{32}$
- (h) $y = ((f(x))^2 + (g(x))^2)^{1/2} \Rightarrow \frac{dy}{dx} = \frac{1}{2}((f(x))^2 + (g(x))^2)^{-1/2} (2f(x) \cdot f'(x) + 2g(x) \cdot g'(x))$
 $\Rightarrow \left. \frac{dy}{dx} \right|_{x=2} = \frac{1}{2}((f(2))^2 + (g(2))^2)^{-1/2} (2f(2)f'(2) + 2g(2)g'(2)) = \frac{1}{2}(8^2 + 2^2)^{-1/2} (2 \cdot 8 \cdot \frac{1}{3} + 2 \cdot 2 \cdot (-3))$
 $= -\frac{5}{3\sqrt{17}}$

60. (a) $y = 5f(x) - g(x) \Rightarrow \frac{dy}{dx} = 5f'(x) - g'(x) \Rightarrow \left. \frac{dy}{dx} \right|_{x=1} = 5f'(1) - g'(1) = 5\left(-\frac{1}{3}\right) - \left(-\frac{8}{3}\right) = 1$
- (b) $y = f(x)(g(x))^3 \Rightarrow \frac{dy}{dx} = f(x)(3(g(x))^2g'(x)) + (g(x))^3f'(x) \Rightarrow \left. \frac{dy}{dx} \right|_{x=0} = 3f(0)(g(0))^2g'(0) + (g(0))^3f'(0)$
 $= 3(1)(1)^2\left(\frac{1}{3}\right) + (1)^3(5) = 6$
- (c) $y = \frac{f(x)}{g(x)+1} \Rightarrow \frac{dy}{dx} = \frac{(g(x)+1)f'(x) - f(x)g'(x)}{(g(x)+1)^2} \Rightarrow \left. \frac{dy}{dx} \right|_{x=1} = \frac{(g(1)+1)f'(1) - f(1)g'(1)}{(g(1)+1)^2}$
 $= \frac{(-4+1)\left(-\frac{1}{3}\right) - (3)\left(-\frac{8}{3}\right)}{(-4+1)^2} = 1$
- (d) $y = f(g(x)) \Rightarrow \frac{dy}{dx} = f'(g(x))g'(x) \Rightarrow \left. \frac{dy}{dx} \right|_{x=0} = f'(g(0))g'(0) = f'(1)\left(\frac{1}{3}\right) = \left(-\frac{1}{3}\right)\left(\frac{1}{3}\right) = -\frac{1}{9}$
- (e) $y = g(f(x)) \Rightarrow \frac{dy}{dx} = g'(f(x))f'(x) \Rightarrow \left. \frac{dy}{dx} \right|_{x=0} = g'(f(0))f'(0) = g'(1)(5) = \left(-\frac{8}{3}\right)(5) = -\frac{40}{3}$
- (f) $y = (x^{11} + f(x))^{-2} \Rightarrow \frac{dy}{dx} = -2(x^{11} + f(x))^{-3}(11x^{10} + f'(x)) \Rightarrow \left. \frac{dy}{dx} \right|_{x=1} = -2(1 + f(1))^{-3}(11 + f'(1))$
 $= -2\left(1 + 3\right)^{-3}\left(11 - \frac{1}{3}\right) = \left(-\frac{2}{4^3}\right)\left(\frac{32}{3}\right) = -\frac{1}{3}$
- (g) $y = f(x + g(x)) \Rightarrow \frac{dy}{dx} = f'(x + g(x))(1 + g'(x)) \Rightarrow \left. \frac{dy}{dx} \right|_{x=0} = f'(0 + g(0))(1 + g'(0)) = f'(1)\left(1 + \frac{1}{3}\right)$
 $= \left(-\frac{1}{3}\right)\left(\frac{4}{3}\right) = -\frac{4}{9}$

61. $\frac{ds}{dt} = \frac{ds}{d\theta} \cdot \frac{d\theta}{dt}$: $s = \cos \theta \Rightarrow \frac{ds}{d\theta} = -\sin \theta \Rightarrow \left. \frac{ds}{d\theta} \right|_{\theta=\frac{3\pi}{2}} = -\sin\left(\frac{3\pi}{2}\right) = 1$ so that $\frac{ds}{dt} = \frac{ds}{d\theta} \cdot \frac{d\theta}{dt} = 1 \cdot 5 = 5$

62. $\frac{dy}{dt} = \frac{dy}{dx} \cdot \frac{dx}{dt}$: $y = x^2 + 7x - 5 \Rightarrow \frac{dy}{dx} = 2x + 7 \Rightarrow \left. \frac{dy}{dx} \right|_{x=1} = 9$ so that $\frac{dy}{dt} = \frac{dy}{dx} \cdot \frac{dx}{dt} = 9 \cdot \frac{1}{3} = 3$

63. With $y = x$, we should get $\frac{dy}{dx} = 1$ for both (a) and (b):

(a) $y = \frac{u}{5} + 7 \Rightarrow \frac{dy}{du} = \frac{1}{5}$; $u = 5x - 35 \Rightarrow \frac{du}{dx} = 5$; therefore, $\frac{dy}{dx} = \frac{dy}{du} \cdot \frac{du}{dx} = \frac{1}{5} \cdot 5 = 1$, as expected

(b) $y = 1 + \frac{1}{u} \Rightarrow \frac{dy}{du} = -\frac{1}{u^2}$; $u = (x-1)^{-1} \Rightarrow \frac{du}{dx} = -(x-1)^{-2}(1) = \frac{-1}{(x-1)^2}$; therefore $\frac{dy}{dx} = \frac{dy}{du} \cdot \frac{du}{dx}$
 $= \frac{-1}{u^2} \cdot \frac{-1}{(x-1)^2} = \frac{-1}{((x-1)^{-1})^2} \cdot \frac{-1}{(x-1)^2} = (x-1)^2 \cdot \frac{-1}{(x-1)^2} = 1$, again as expected

64. With $y = x^{3/2}$, we should get $\frac{dy}{dx} = \frac{3}{2}x^{1/2}$ for both (a) and (b):

(a) $y = u^3 \Rightarrow \frac{dy}{du} = 3u^2$; $u = \sqrt{x} \Rightarrow \frac{du}{dx} = \frac{1}{2\sqrt{x}}$; therefore, $\frac{dy}{dx} = \frac{dy}{du} \cdot \frac{du}{dx} = 3u^2 \cdot \frac{1}{2\sqrt{x}} = 3(\sqrt{x})^2 \cdot \frac{1}{2\sqrt{x}} = \frac{3}{2}\sqrt{x}$, as expected.

(b) $y = \sqrt{u} \Rightarrow \frac{dy}{du} = \frac{1}{2\sqrt{u}}$; $u = x^3 \Rightarrow \frac{du}{dx} = 3x^2$; therefore, $\frac{dy}{dx} = \frac{dy}{du} \cdot \frac{du}{dx} = \frac{1}{2\sqrt{u}} \cdot 3x^2 = \frac{1}{2\sqrt{x^3}} \cdot 3x^2 = \frac{3}{2}x^{1/2}$, again as expected.

65. $y = 2 \tan\left(\frac{\pi x}{4}\right) \Rightarrow \frac{dy}{dx} = \left(2 \sec^2\left(\frac{\pi x}{4}\right)\right)\left(\frac{\pi}{4}\right) = \frac{\pi}{2} \sec^2\left(\frac{\pi x}{4}\right)$

(a) $\left.\frac{dy}{dx}\right|_{x=1} = \frac{\pi}{2} \sec^2\left(\frac{\pi}{4}\right) = \pi \Rightarrow$ slope of tangent is π ; thus, $y(1) = 2 \tan\left(\frac{\pi}{4}\right) = 2$ and $y'(1) = \pi \Rightarrow$ tangent line is given by $y - 2 = \pi(x - 1) \Rightarrow y = \pi x + 2 - \pi$

(b) $y' = \frac{\pi}{2} \sec^2\left(\frac{\pi x}{4}\right)$ and the smallest value the secant function can have in $-2 < x < 2$ is 1 \Rightarrow the minimum value of y' is $\frac{\pi}{2}$ and that occurs when $\frac{\pi}{2} = \frac{\pi}{2} \sec^2\left(\frac{\pi x}{4}\right) \Rightarrow 1 = \sec^2\left(\frac{\pi x}{4}\right) \Rightarrow \pm 1 = \sec\left(\frac{\pi x}{4}\right) \Rightarrow x = 0$.

66. (a) $y = \sin 2x \Rightarrow y' = 2 \cos 2x \Rightarrow y'(0) = 2 \cos(0) = 2 \Rightarrow$ tangent to $y = \sin 2x$ at the origin is $y = 2x$;
 $y = -\sin\left(\frac{x}{2}\right) \Rightarrow y' = -\frac{1}{2} \cos\left(\frac{x}{2}\right) \Rightarrow y'(0) = -\frac{1}{2} \cos 0 = -\frac{1}{2} \Rightarrow$ tangent to $y = -\sin\left(\frac{x}{2}\right)$ at the origin is $y = -\frac{1}{2}x$. The tangents are perpendicular to each other at the origin since the product of their slopes is -1 .

(b) $y = \sin(mx) \Rightarrow y' = m \cos(mx) \Rightarrow y'(0) = m \cos 0 = m$; $y = -\sin\left(\frac{x}{m}\right) \Rightarrow y' = -\frac{1}{m} \cos\left(\frac{x}{m}\right) \Rightarrow y'(0) = -\frac{1}{m} \cos(0) = -\frac{1}{m}$. Since $m \cdot \left(-\frac{1}{m}\right) = -1$, the tangent lines are perpendicular at the origin.

(c) $y = \sin(mx) \Rightarrow y' = m \cos(mx)$. The largest value $\cos(mx)$ can attain is 1 at $x = 0 \Rightarrow$ the largest value y' can attain is $|m|$ because $|y'| = |m \cos(mx)| = |m| |\cos mx| \leq |m| \cdot 1 = |m|$. Also, $y = -\sin\left(\frac{x}{m}\right) \Rightarrow y' = -\frac{1}{m} \cos\left(\frac{x}{m}\right) \Rightarrow |y'| = \left|\frac{-1}{m} \cos\left(\frac{x}{m}\right)\right| \leq \left|\frac{1}{m}\right| |\cos\left(\frac{x}{m}\right)| \leq \frac{1}{|m|} \Rightarrow$ the largest value y' can attain is $\left|\frac{1}{m}\right|$.

(d) $y = \sin(mx) \Rightarrow y' = m \cos(mx) \Rightarrow y'(0) = m \Rightarrow$ slope of curve at the origin is m . Also, $\sin(mx)$ completes m periods on $[0, 2\pi]$. Therefore the slope of the curve $y = \sin(mx)$ at the origin is the same as the number of periods it completes on $[0, 2\pi]$. In particular, for large m , we can think of “compressing” the graph of $y = \sin x$ horizontally which gives more periods completed on $[0, 2\pi]$, but also increases the slope of the graph at the origin.

67. $x = \cos 2t, y = \sin 2t, 0 \leq t \leq \pi$
 $\Rightarrow \cos^2 2t + \sin^2 2t = 1 \Rightarrow x^2 + y^2 = 1$

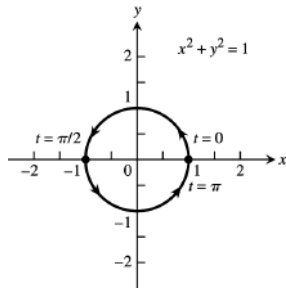

68. $x = \cos(\pi - t), y = \sin(\pi - t), 0 \leq t \leq \pi$
 $\Rightarrow \cos^2(\pi - t) + \sin^2(\pi - t) = 1$
 $\Rightarrow x^2 + y^2 = 1, y \geq 0$

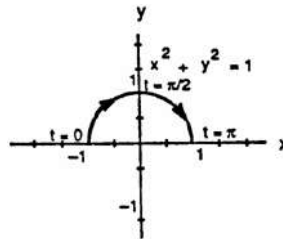

69. $x = 4 \cos t, y = 2 \sin t, 0 \leq t \leq 2\pi$
 $\Rightarrow \frac{16 \cos^2 t}{16} + \frac{4 \sin^2 t}{4} = 1 \Rightarrow \frac{x^2}{16} + \frac{y^2}{4} = 1$

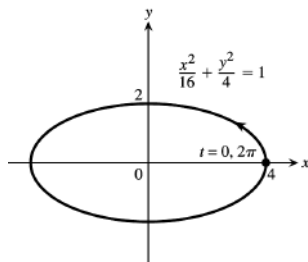

70. $x = 4 \sin t, y = 5 \cos t, 0 \leq t \leq 2\pi$
 $\Rightarrow \frac{16 \sin^2 t}{16} + \frac{25 \cos^2 t}{25} = 1 \Rightarrow \frac{x^2}{16} + \frac{y^2}{25} = 1$

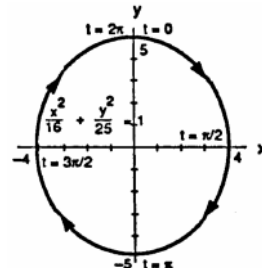

71. $x = 3t, y = 9t^2, -\infty < t < \infty \Rightarrow y = x^2$

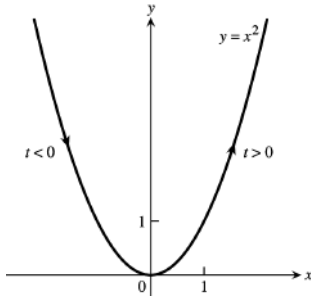

72. $x = -\sqrt{t}, y = t, t \geq 0 \Rightarrow x = -\sqrt{y}$
or $y = x^2, x \leq 0$

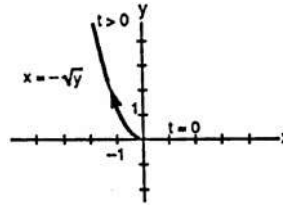

73. $x = 2t - 5, y = 4t - 7, -\infty < t < \infty$
 $\Rightarrow x + 5 = 2t \Rightarrow 2(x + 5) = 4t$
 $\Rightarrow y = 2(x + 5) - 7 \Rightarrow y = 2x + 3$

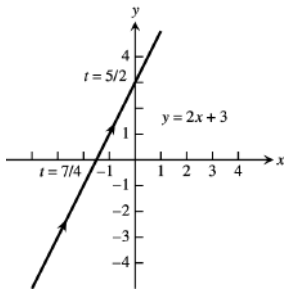

74. $x = 3 - 3t, y = 2t, 0 \leq t \leq 1 \Rightarrow \frac{y}{2} = t$
 $\Rightarrow x = 3 - 3\left(\frac{y}{2}\right) \Rightarrow 2x = 6 - 3y$
 $\Rightarrow y = 2 - \frac{2}{3}x, 0 \leq x \leq 3$

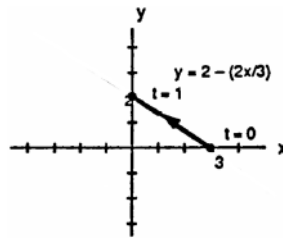

75. $x = t, y = \sqrt{1 - t^2}, -1 \leq t \leq 0$
 $\Rightarrow y = \sqrt{1 - x^2}$

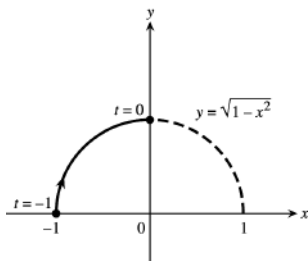

76. $x = \sqrt{t + 1}, y = \sqrt{t}, t \geq 0$
 $\Rightarrow y^2 = t \Rightarrow x = \sqrt{y^2 + 1}, y \geq 0$

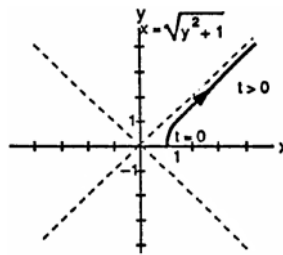

77. $x = \sec^2 t - 1, y = \tan t, -\frac{\pi}{2} < t < \frac{\pi}{2}$
 $\Rightarrow \sec^2 t - 1 = \tan^2 t \Rightarrow x = y^2$

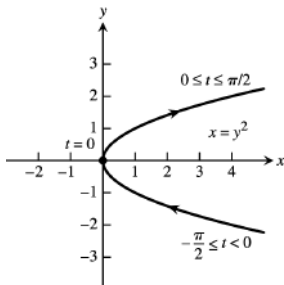

78. $x = -\sec t, y = \tan t, -\frac{\pi}{2} < t < \frac{\pi}{2}$
 $\Rightarrow \sec^2 t - \tan^2 t = 1 \Rightarrow x^2 - y^2 = 1$

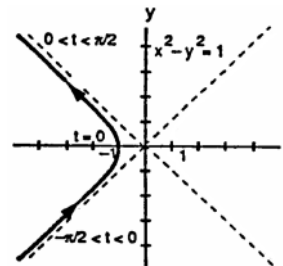

79. (a) $x = a \cos t, y = -a \sin t, 0 \leq t \leq 2\pi$
 (b) $x = a \cos t, y = a \sin t, 0 \leq t \leq 2\pi$
 (c) $x = a \cos t, y = -a \sin t, 0 \leq t \leq 4\pi$
 (d) $x = a \cos t, y = a \sin t, 0 \leq t \leq 4\pi$
80. (a) $x = a \sin t, y = b \cos t, \frac{\pi}{2} \leq t \leq \frac{5\pi}{2}$
 (b) $x = a \cos t, y = b \sin t, 0 \leq t \leq 2\pi$
 (c) $x = a \sin t, y = b \cos t, \frac{\pi}{2} \leq t \leq \frac{9\pi}{2}$
 (d) $x = a \cos t, y = b \sin t, 0 \leq t \leq 4\pi$
81. Using $(-1, -3)$ we create the parametric equations $x = -1 + at$ and $y = -3 + bt$, representing a line which goes through $(-1, -3)$ at $t = 0$. We determine a and b so that the line goes through $(4, 1)$ when $t = 1$.
 Since $4 = -1 + a \Rightarrow a = 5$. Since $1 = -3 + b \Rightarrow b = 4$. Therefore, one possible parameterization is $x = -1 + 5t$, $y = -3 + 4t, 0 \leq t \leq 1$.
82. Using $(-1, 3)$ we create the parametric equations $x = -1 + at$ and $y = 3 + bt$, representing a line which goes through $(-1, 3)$ at $t = 0$. We determine a and b so that the line goes through $(3, -2)$ when $t = 1$. Since $3 = -1 + a \Rightarrow a = 4$.
 Since $-2 = 3 + b \Rightarrow b = -5$. Therefore, one possible parameterization is $x = -1 + 4t, y = 3 - 5t, 0 \leq t \leq 1$.
83. The lower half of the parabola is given by $x = y^2 + 1$ for $y \leq 0$. Substituting t for y , we obtain one possible parameterization $x = t^2 + 1, y = t, t \leq 0$.
84. The vertex of the parabola is at $(-1, -1)$, so the left half of the parabola is given by $y = x^2 + 2x$ for $x \leq -1$. Substituting t for x , we obtain one possible parametrization: $x = t, y = t^2 + 2t, t \leq -1$.
85. For simplicity, we assume that x and y are linear functions of t and that the point (x, y) starts at $(2, 3)$ for $t = 0$ and passes through $(-1, -1)$ at $t = 1$. Then $x = f(t)$, where $f(0) = 2$ and $f(1) = -1$.
 Since slope $= \frac{\Delta x}{\Delta t} = \frac{-1-2}{1-0} = -3$, $x = f(t) = -3t + 2 = 2 - 3t$. Also, $y = g(t)$, where $g(0) = 3$ and $g(1) = -1$.
 Since slope $= \frac{\Delta y}{\Delta t} = \frac{-1-3}{1-0} = -4$, $y = g(t) = -4t + 3 = 3 - 4t$.
 One possible parameterization is: $x = 2 - 3t, y = 3 - 4t, t \geq 0$.
86. For simplicity, we assume that x and y are linear functions of t and that the point (x, y) starts at $(-1, 2)$ for $t = 0$ and passes through $(0, 0)$ at $t = 1$. Then $x = f(t)$, where $f(0) = -1$ and $f(1) = 0$.
 Since slope $= \frac{\Delta x}{\Delta t} = \frac{0-(-1)}{1-0} = 1$, $x = f(t) = 1t + (-1) = -1 + t$. Also, $y = g(t)$, where $g(0) = 2$ and $g(1) = 0$.
 Since slope $= \frac{\Delta y}{\Delta t} = \frac{0-2}{1-0} = -2$, $y = g(t) = -2t + 2 = 2 - 2t$.
 One possible parameterization is: $x = -1 + t, y = 2 - 2t, t \geq 0$.
87. $t = \frac{\pi}{4} \Rightarrow x = 2 \cos \frac{\pi}{4} = \sqrt{2}, y = 2 \sin \frac{\pi}{4} = \sqrt{2}; \frac{dx}{dt} = -2 \sin t, \frac{dy}{dt} = 2 \cos t \Rightarrow \frac{dy}{dx} = \frac{dy/dt}{dx/dt} = \frac{2 \cos t}{-2 \sin t} = -\cot t$
 $\Rightarrow \frac{dy}{dx} \Big|_{t=\frac{\pi}{4}} = -\cot \frac{\pi}{4} = -1$; tangent line is $y - \sqrt{2} = -1(x - \sqrt{2})$ or $y = -x + 2\sqrt{2}; \frac{dy'}{dt} = \csc^2 t$
 $\Rightarrow \frac{d^2y}{dx^2} = \frac{dy'/dt}{dx/dt} = \frac{\csc^2 t}{-2 \sin t} = -\frac{1}{2 \sin^3 t} \Rightarrow \frac{d^2y}{dx^2} \Big|_{t=\frac{\pi}{4}} = -\sqrt{2}$
88. $t = \frac{2\pi}{3} \Rightarrow x = \cos \frac{2\pi}{3} = -\frac{1}{2}, y = \sqrt{3} \cos \frac{2\pi}{3} = -\frac{\sqrt{3}}{2}; \frac{dx}{dt} = -\sin t, \frac{dy}{dt} = -\sqrt{3} \sin t \Rightarrow \frac{dy}{dx} = \frac{-\sqrt{3} \sin t}{-\sin t} = \sqrt{3}$
 $\Rightarrow \frac{dy}{dx} \Big|_{t=\frac{2\pi}{3}} = \sqrt{3}$; tangent line is $y - \left(-\frac{\sqrt{3}}{2}\right) = \sqrt{3} \left[x - \left(-\frac{1}{2}\right)\right]$ or $y = \sqrt{3}x; \frac{dy'}{dt} = 0 \Rightarrow \frac{d^2y}{dx^2} = \frac{0}{-\sin t} = 0$
 $\Rightarrow \frac{d^2y}{dx^2} \Big|_{t=\frac{2\pi}{3}} = 0$
89. $t = \frac{1}{4} \Rightarrow x = \frac{1}{4}, y = \frac{1}{2}; \frac{dx}{dt} = 1, \frac{dy}{dt} = \frac{1}{2\sqrt{t}} \Rightarrow \frac{dy}{dx} = \frac{dy/dt}{dx/dt} = \frac{1}{2\sqrt{t}} \Rightarrow \frac{dy}{dx} \Big|_{t=\frac{1}{4}} = \frac{1}{2\sqrt{\frac{1}{4}}} = 1$; tangent line is
 $y - \frac{1}{2} = 1 \cdot \left(x - \frac{1}{4}\right)$ or $y = x + \frac{1}{4}; \frac{dy'}{dt} = -\frac{1}{4}t^{-3/2} \Rightarrow \frac{d^2y}{dx^2} = \frac{dy'/dt}{dx/dt} = -\frac{1}{4}t^{-3/2} \Rightarrow \frac{d^2y}{dx^2} \Big|_{t=\frac{1}{4}} = -2$

$$90. t = 3 \Rightarrow x = -\sqrt{3+1} = -2, y = \sqrt{3(3)} = 3; \frac{dx}{dt} = -\frac{1}{2}(t+1)^{-1/2}, \frac{dy}{dt} = \frac{3}{2}(3t)^{-1/2} \Rightarrow \frac{dy}{dx} = \frac{(\frac{3}{2})(3t)^{-1/2}}{(-\frac{1}{2})(t+1)^{-1/2}}$$

$$= -\frac{3\sqrt{t+1}}{\sqrt{3t}} = \left. \frac{dy}{dx} \right|_{t=3} = \frac{-3\sqrt{3+1}}{\sqrt{3(3)}} = -2; \text{ tangent line is } y - 3 = -2[x - (-2)] \text{ or } y = -2x - 1;$$

$$\frac{dy'}{dt} = \frac{\sqrt{3t}[-\frac{3}{2}(t+1)^{-1/2}] + 3\sqrt{t+1}[\frac{3}{2}(3t)^{-1/2}]}{3t} = \frac{3}{2t\sqrt{3t}\sqrt{t+1}} \Rightarrow \frac{d^2y}{dx^2} = \frac{(\frac{3}{2t\sqrt{3t}\sqrt{t+1}})}{(-\frac{1}{2\sqrt{t+1}})} = -\frac{3}{t\sqrt{3t}}$$

$$\Rightarrow \left. \frac{d^2y}{dx^2} \right|_{t=3} = -\frac{1}{3}$$

$$91. t = -1 \Rightarrow x = 5, y = 1; \frac{dx}{dt} = 4t, \frac{dy}{dt} = 4t^3 \Rightarrow \frac{dy}{dx} = \frac{dy/dt}{dx/dt} = \frac{4t^3}{4t} = t^2 \Rightarrow \left. \frac{dy}{dx} \right|_{t=-1} = (-1)^2 = 1; \text{ tangent line is}$$

$$y - 1 = 1 \cdot (x - 5) \text{ or } y = x - 4; \frac{dy'}{dt} = 2t \Rightarrow \frac{d^2y}{dx^2} = \frac{dy'/dt}{dx/dt} = \frac{2t}{4t} = \frac{1}{2} \Rightarrow \left. \frac{d^2y}{dx^2} \right|_{t=-1} = \frac{1}{2}$$

$$92. t = \frac{\pi}{3} \Rightarrow x = \frac{\pi}{3} - \sin \frac{\pi}{3} = \frac{\pi}{3} - \frac{\sqrt{3}}{2}, y = 1 - \cos \frac{\pi}{3} = 1 - \frac{1}{2} = \frac{1}{2}; \frac{dx}{dt} = 1 - \cos t, \frac{dy}{dt} = \sin t \Rightarrow \frac{dy}{dx} = \frac{dy/dt}{dx/dt}$$

$$= \frac{\sin t}{1 - \cos t} \Rightarrow \left. \frac{dy}{dx} \right|_{t=\frac{\pi}{3}} = \frac{\sin(\frac{\pi}{3})}{1 - \cos(\frac{\pi}{3})} = \frac{(\frac{\sqrt{3}}{2})}{(\frac{1}{2})} = \sqrt{3}; \text{ tangent line is } y - \frac{1}{2} = \sqrt{3}\left(x - \frac{\pi}{3} + \frac{\sqrt{3}}{2}\right)$$

$$\Rightarrow y = \sqrt{3}x - \frac{\pi\sqrt{3}}{3} + 2; \frac{dy'}{dt} = \frac{(1 - \cos t)(\cos t) - (\sin t)(\sin t)}{(1 - \cos t)^2} = \frac{-1}{1 - \cos t} \Rightarrow \frac{d^2y}{dx^2} = \frac{dy'/dt}{dx/dt} = \frac{(-\frac{1}{1 - \cos t})}{1 - \cos t}$$

$$= \frac{-1}{(1 - \cos t)^2} \Rightarrow \left. \frac{d^2y}{dx^2} \right|_{t=\frac{\pi}{3}} = -4$$

$$93. t = \frac{\pi}{2} \Rightarrow x = \cos \frac{\pi}{2} = 0, y = 1 + \sin \frac{\pi}{2} = 2; \frac{dx}{dt} = -\sin t, \frac{dy}{dt} = \cos t \Rightarrow \frac{dy}{dx} = \frac{\cos t}{-\sin t} = -\cot t$$

$$\Rightarrow \left. \frac{dy}{dx} \right|_{t=\frac{\pi}{2}} = -\cot \frac{\pi}{2} = 0; \text{ tangent line is } y = 2; \frac{dy'}{dt} = \csc^2 t \Rightarrow \frac{d^2y}{dx^2} = \frac{\csc^2 t}{-\sin t} = -\csc^3 t \Rightarrow \left. \frac{d^2y}{dx^2} \right|_{t=\frac{\pi}{2}} = -1$$

$$94. t = -\frac{\pi}{4} \Rightarrow x = \sec^2\left(-\frac{\pi}{4}\right) - 1 = 1, y = \tan\left(-\frac{\pi}{4}\right) = -1; \frac{dx}{dt} = 2 \sec^2 t \tan t, \frac{dy}{dt} = \sec^2 t$$

$$\Rightarrow \frac{dy}{dx} = \frac{\sec^2 t}{2 \sec^2 t \tan t} = \frac{1}{2 \tan t} = \frac{1}{2} \cot t \Rightarrow \left. \frac{dy}{dx} \right|_{t=-\frac{\pi}{4}} = \frac{1}{2} \cot\left(-\frac{\pi}{4}\right) = -\frac{1}{2}; \text{ tangent line is}$$

$$y - (-1) = -\frac{1}{2}(x - 1) \text{ or } y = -\frac{1}{2}x - \frac{1}{2}; \frac{dy'}{dt} = -\frac{1}{2} \csc^2 t \Rightarrow \frac{d^2y}{dx^2} = \frac{-\frac{1}{2} \csc^2 t}{2 \sec^2 t \tan t} = -\frac{1}{4} \cot^3 t$$

$$\Rightarrow \left. \frac{d^2y}{dx^2} \right|_{t=-\frac{\pi}{4}} = \frac{1}{4}$$

95. $s = A \cos(2\pi bt) \Rightarrow v = \frac{ds}{dt} = -A \sin(2\pi bt)(2\pi b) = -2\pi bA \sin(2\pi bt)$. If we replace b with $2b$ to double the frequency, the velocity formula gives $v = -4\pi bA \sin(4\pi bt) \Rightarrow$ doubling the frequency causes the velocity to double. Also $v = -2\pi bA \sin(2\pi bt) \Rightarrow a = \frac{dv}{dt} = -4\pi^2 b^2 A \cos(2\pi bt)$. If we replace b with $2b$ in the acceleration formula, we get $a = -16\pi^2 b^2 A \cos(4\pi bt) \Rightarrow$ doubling the frequency causes the acceleration to quadruple. Finally, $a = -4\pi^2 b^2 A \cos(2\pi bt) \Rightarrow j = \frac{da}{dt} = 8\pi^3 b^3 A \sin(2\pi bt)$. If we replace b with $2b$ in the jerk formula, we get $j = 64\pi^3 b^3 A \sin(4\pi bt) \Rightarrow$ doubling the frequency multiplies the jerk by a factor of 8.

$$96. (a) y = 37 \sin \left[\frac{2\pi}{365} (x - 101) \right] + 25 \Rightarrow y' = 37 \cos \left[\frac{2\pi}{365} (x - 101) \right] \left(\frac{2\pi}{365} \right) = \frac{74\pi}{365} \cos \left[\frac{2\pi}{365} (x - 101) \right].$$

The temperature is increasing the fastest when y' is as large as possible. The largest value of $\cos \left[\frac{2\pi}{365} (x - 101) \right]$ is 1 and occurs when $\frac{2\pi}{365} (x - 101) = 0 \Rightarrow x = 101 \Rightarrow$ on day 101 of the year (\sim April 11), the temperature is increasing the fastest.

$$(b) y'(101) = \frac{74\pi}{365} \cos \left[\frac{2\pi}{365} (101 - 101) \right] = \frac{74\pi}{365} \cos(0) = \frac{74\pi}{365} \approx 0.64 \text{ }^\circ\text{F/day}$$

$$97. s = (1 + 4t)^{1/2} \Rightarrow v = \frac{ds}{dt} = \frac{1}{2}(1 + 4t)^{-1/2}(4) = 2(1 + 4t)^{-1/2} \Rightarrow v(6) = 2(1 + 4 \cdot 6)^{-1/2} = \frac{2}{5} \text{ m/sec};$$

$$v = 2(1 + 4t)^{-1/2} \Rightarrow a = \frac{dv}{dt} = -\frac{1}{2} \cdot 2(1 + 4t)^{-3/2}(4) = -4(1 + 4t)^{-3/2} \Rightarrow a(6) = -4(1 + 4 \cdot 6)^{-3/2} = -\frac{4}{125} \text{ m/sec}^2$$

98. We need to show $a = \frac{dv}{dt}$ is constant: $a = \frac{dv}{dt} = \frac{dv}{ds} \cdot \frac{ds}{dt}$ and $\frac{dv}{ds} = \frac{d}{ds}(k\sqrt{s}) = \frac{k}{2\sqrt{s}} \Rightarrow a = \frac{dv}{ds} \cdot \frac{ds}{dt} = \frac{dv}{ds} \cdot v$
 $= \frac{k}{2\sqrt{s}} \cdot k\sqrt{s} = \frac{k^2}{2}$ which is a constant.

99. v proportional to $\frac{1}{\sqrt{s}} \Rightarrow v = \frac{k}{\sqrt{s}}$ for some constant $k \Rightarrow \frac{dv}{ds} = -\frac{k}{2s^{3/2}}$. Thus, $a = \frac{dv}{dt} = \frac{dv}{ds} \cdot \frac{ds}{dt} = \frac{dv}{ds} \cdot v$
 $= -\frac{k}{2s^{3/2}} \cdot \frac{k}{\sqrt{s}} = -\frac{k^2}{2} \left(\frac{1}{s^2}\right) \Rightarrow$ acceleration is a constant times $\frac{1}{s^2}$ so a is inversely proportional to s^2 .

100. Let $\frac{dx}{dt} = f(x)$. Then, $a = \frac{dv}{dt} = \frac{dv}{dx} \cdot \frac{dx}{dt} = \frac{dv}{dx} \cdot f(x) = \frac{d}{dx} \left(\frac{dx}{dt}\right) \cdot f(x) = \frac{d}{dx}(f(x)) \cdot f(x) = f'(x)f(x)$, as required.

101. $T = 2\pi\sqrt{\frac{L}{g}} \Rightarrow \frac{dT}{dL} = 2\pi \cdot \frac{1}{2\sqrt{\frac{L}{g}}} \cdot \frac{1}{g} = \frac{\pi}{g\sqrt{\frac{L}{g}}} = \frac{\pi}{\sqrt{gL}}$. Therefore, $\frac{dT}{du} = \frac{dT}{dL} \cdot \frac{dL}{du} = \frac{\pi}{\sqrt{gL}} \cdot kL = \frac{\pi k\sqrt{L}}{\sqrt{g}} = \frac{1}{2} \cdot 2\pi k\sqrt{\frac{L}{g}}$
 $= \frac{kT}{2}$, as required.

102. No. The chain rule says that when g is differentiable at 0 and f is differentiable at $g(0)$, then $f \circ g$ is differentiable at 0. But the chain rule says nothing about what happens when g is not differentiable at 0 so there is no contradiction.

103. The graph of $y = (f \circ g)(x)$ has a horizontal tangent at $x = 1$ provided that $(f \circ g)'(1) = 0 \Rightarrow f'(g(1))g'(1) = 0$
 \Rightarrow either $f'(g(1)) = 0$ or $g'(1) = 0$ (or both) \Rightarrow either the graph of f has a horizontal tangent at $u = g(1)$, or the graph of g has a horizontal tangent at $x = 1$ (or both).

104. $(f \circ g)'(-5) < 0 \Rightarrow f'(g(-5)) \cdot g'(-5) < 0 \Rightarrow f'(g(-5))$ and $g'(-5)$ are both nonzero and have opposite signs. That is, either $[f'(g(-5)) > 0$ and $g'(-5) < 0]$ or $[f'(g(-5)) < 0$ and $g'(-5) > 0]$.

105. As $h \rightarrow 0$, the graph of $y = \frac{\sin 2(x+h) - \sin 2x}{h}$ approaches the graph of $y = 2 \cos 2x$ because
 $\lim_{h \rightarrow 0} \frac{\sin 2(x+h) - \sin 2x}{h} = \frac{d}{dx}(\sin 2x) = 2 \cos 2x$.

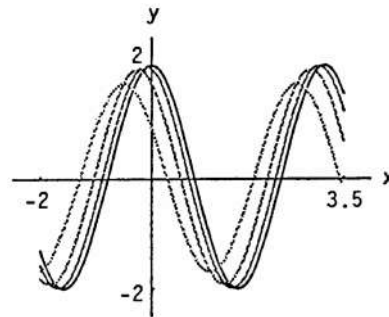

106. As $h \rightarrow 0$, the graph of $y = \frac{\cos[(x+h)^2] - \cos(x^2)}{h}$ approaches the graph of $y = -2x \sin(x^2)$ because
 $\lim_{h \rightarrow 0} \frac{\cos[(x+h)^2] - \cos(x^2)}{h} = \frac{d}{dx}[\cos(x^2)] = -2x \sin(x^2)$.

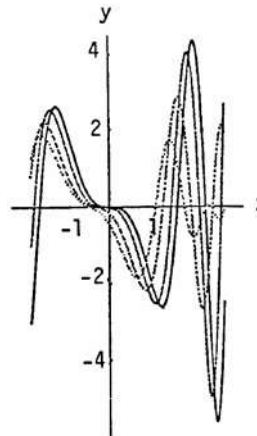

107. $\frac{dx}{dt} = \cos t$ and $\frac{dy}{dt} = 2 \cos 2t \Rightarrow \frac{dy}{dx} = \frac{dy/dt}{dx/dt} = \frac{2 \cos 2t}{\cos t} = \frac{2(2 \cos^2 t - 1)}{\cos t}$; then $\frac{dy}{dx} = 0 \Rightarrow \frac{2(2 \cos^2 t - 1)}{\cos t} = 0$
 $\Rightarrow 2 \cos^2 t - 1 = 0 \Rightarrow \cos t = \pm \frac{1}{\sqrt{2}} \Rightarrow t = \frac{\pi}{4}, \frac{3\pi}{4}, \frac{5\pi}{4}, \frac{7\pi}{4}$. In the 1st quadrant: $t = \frac{\pi}{4} \Rightarrow x = \sin \frac{\pi}{4} = \frac{\sqrt{2}}{2}$ and
 $y = \sin 2\left(\frac{\pi}{4}\right) = 1 \Rightarrow \left(\frac{\sqrt{2}}{2}, 1\right)$ is the point where the tangent line is horizontal. At the origin: $x = 0$ and $y = 0$
 $\Rightarrow \sin t = 0 \Rightarrow t = 0$ or $t = \pi$ and $\sin 2t = 0 \Rightarrow t = 0, \frac{\pi}{2}, \pi, \frac{3\pi}{2}$; thus $t = 0$ and $t = \pi$ give the tangent lines at
the origin. Tangents at origin: $\left. \frac{dy}{dx} \right|_{t=0} = 2 \Rightarrow y = 2x$ and $\left. \frac{dy}{dx} \right|_{t=\pi} = -2 \Rightarrow y = -2x$

108. $\frac{dx}{dt} = 2 \cos 2t$ and $\frac{dy}{dt} = 3 \cos 3t \Rightarrow \frac{dy}{dx} = \frac{dy/dt}{dx/dt} = \frac{3 \cos 3t}{2 \cos 2t} = \frac{3(\cos 2t \cos t - \sin 2t \sin t)}{2(2 \cos^2 t - 1)}$
 $= \frac{3[(2 \cos^2 t - 1)(\cos t) - 2 \sin t \cos t \sin t]}{2(2 \cos^2 t - 1)} = \frac{(3 \cos t)(2 \cos^2 t - 1 - 2 \sin^2 t)}{2(2 \cos^2 t - 1)} = \frac{(3 \cos t)(4 \cos^2 t - 3)}{2(2 \cos^2 t - 1)}$; then
 $\frac{dy}{dx} = 0 \Rightarrow \frac{(3 \cos t)(4 \cos^2 t - 3)}{2(2 \cos^2 t - 1)} = 0 \Rightarrow 3 \cos t = 0$ or $4 \cos^2 t - 3 = 0$: $3 \cos t = 0 \Rightarrow t = \frac{\pi}{2}, \frac{3\pi}{2}$ and
 $4 \cos^2 t - 3 = 0 \Rightarrow \cos t = \pm \frac{\sqrt{3}}{2} \Rightarrow t = \frac{\pi}{6}, \frac{5\pi}{6}, \frac{7\pi}{6}, \frac{11\pi}{6}$. In the 1st quadrant: $t = \frac{\pi}{6} \Rightarrow x = \sin 2\left(\frac{\pi}{6}\right) = \frac{\sqrt{3}}{2}$
and $y = \sin 3\left(\frac{\pi}{6}\right) = 1 \Rightarrow \left(\frac{\sqrt{3}}{2}, 1\right)$ is the point where the graph has a horizontal tangent. At the origin: $x = 0$
and $y = 0 \Rightarrow \sin 2t = 0$ and $\sin 3t = 0 \Rightarrow t = 0, \frac{\pi}{2}, \pi, \frac{3\pi}{2}$ and $t = 0, \frac{\pi}{3}, \frac{2\pi}{3}, \pi, \frac{4\pi}{3}, \frac{5\pi}{3} \Rightarrow t = 0$ and $t = \pi$ give
the tangent lines at the origin. Tangents at the origin: $\left. \frac{dy}{dx} \right|_{t=0} = \frac{3 \cos 0}{2 \cos 0} = \frac{3}{2} \Rightarrow y = \frac{3}{2}x$, and $\left. \frac{dy}{dx} \right|_{t=\pi} = \frac{3 \cos(\pi)}{2 \cos(\pi)} = -\frac{3}{2} \Rightarrow y = -\frac{3}{2}x$

109. From the power rule, with $y = x^{1/4}$, we get $\frac{dy}{dx} = \frac{1}{4}x^{-3/4}$. From the chain rule, $y = \sqrt{\sqrt{x}}$
 $\Rightarrow \frac{dy}{dx} = \frac{1}{2\sqrt{\sqrt{x}}} \cdot \frac{d}{dx}(\sqrt{x}) = \frac{1}{2\sqrt{\sqrt{x}}} \cdot \frac{1}{2\sqrt{x}} = \frac{1}{4}x^{-3/4}$, in agreement.

110. From the power rule, with $y = x^{3/4}$, we get $\frac{dy}{dx} = \frac{3}{4}x^{-1/4}$. From the chain rule, $y = \sqrt{x\sqrt{x}}$
 $\Rightarrow \frac{dy}{dx} = \frac{1}{2\sqrt{x\sqrt{x}}} \cdot \frac{d}{dx}(x\sqrt{x}) \Rightarrow \frac{dy}{dx} = \frac{1}{2\sqrt{x\sqrt{x}}} \cdot \left(x \cdot \frac{1}{2\sqrt{x}} + \sqrt{x}\right) = \frac{1}{2\sqrt{x\sqrt{x}}} \cdot \left(\frac{3}{2}\sqrt{x}\right) = \frac{3\sqrt{x}}{4\sqrt{x\sqrt{x}}}$
 $= \frac{3\sqrt{x}}{4\sqrt{x}\sqrt{\sqrt{x}}} = \frac{3}{4}x^{-1/4}$, in agreement.

111. (a)

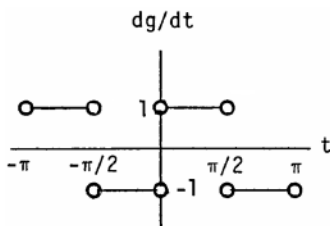

(b) $\frac{df}{dt} = 1.27324 \sin 2t + 0.42444 \sin 6t + 0.2546 \sin 10t + 0.18186 \sin 14t$

(c) The curve of $y = \frac{df}{dt}$ approximates $y = \frac{dg}{dt}$
the best when t is not $-\pi, -\frac{\pi}{2}, 0, \frac{\pi}{2},$ nor π .

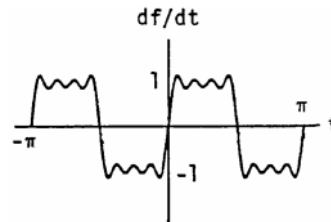

112. (a)

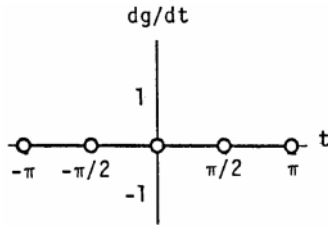

(b) $\frac{dh}{dt} = 2.5464 \cos(2t) + 2.5464 \cos(6t) + 2.5465 \cos(10t) + 2.54646 \cos(14t) + 2.54646 \cos(18t)$

(c)

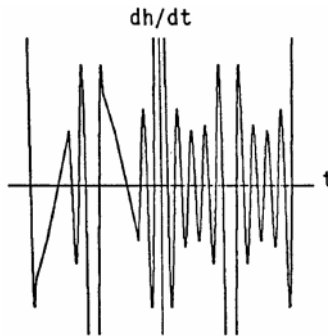

111-116. Example CAS commands:

Maple:

```
f := t -> 0.78540 - 0.63662*cos(2*t) - 0.07074*cos(6*t)
      - 0.02546*cos(10*t) - 0.01299*cos(14*t);
g := t -> piecewise( t<-Pi/2, t+Pi, t<0, -t, t<Pi/2, t, Pi-t );
plot( [f(t),g(t)], t=-Pi..Pi );
Df := D(f);
Dg := D(g);
plot( [Df(t),Dg(t)], t=-Pi..Pi );
```

Mathematica: (functions, domains, and value for t0 may change):

To see the relationship between f[t] and f'[t] in 111 and h[t] in 112

```
Clear[t, f]
f[t_] = 0.78540 - 0.63662 Cos[2t] - 0.07074 Cos[6t] - 0.02546 Cos[10t] - 0.01299 Cos[14t]
f'[t]
Plot[{f[t], f'[t]}, {t, -pi, pi}]
```

For the parametric equations in 113 - 116, do the following. Do NOT use the colon when defining tanline.

```
Clear[x, y, t]
t0 = p/4;
x[t_] := 1 - Cos[t]
y[t_] := 1 + Sin[t]
p1 = ParametricPlot[{x[t], y[t]}, {t, -pi, pi}]
yp[t_] := y'[t]/x'[t]
ypp[t_] := ypp'[t]/xpp'[t]
yp[t0]/N
ypp[t0]/N
tanline[x_] = y[t0] + yp[t0] (x - x[t0])
p2 = Plot[tanline[x], {x, 0, 1}]
Show[p1, p2]
```

3.6 IMPLICIT DIFFERENTIATION

1. $y = x^{9/4} \Rightarrow \frac{dy}{dx} = \frac{9}{4} x^{5/4}$
2. $y = x^{-3/5} \Rightarrow \frac{dy}{dx} = -\frac{3}{5} x^{-8/5}$
3. $y = \sqrt[3]{2x} = (2x)^{1/3} \Rightarrow \frac{dy}{dx} = \frac{1}{3} (2x)^{-2/3} \cdot 2 = \frac{2^{1/3}}{3x^{2/3}}$
4. $y = \sqrt[4]{5x} = (5x)^{1/4} \Rightarrow \frac{dy}{dx} = \frac{1}{4} (5x)^{-3/4} \cdot 5 = \frac{5^{1/4}}{4x^{3/4}}$
5. $y = 7\sqrt{x+6} = 7(x+6)^{1/2} \Rightarrow \frac{dy}{dx} = \frac{7}{2} (x+6)^{-1/2} = \frac{7}{2\sqrt{x+6}}$
6. $y = -2\sqrt{x-1} = -2(x-1)^{1/2} \Rightarrow \frac{dy}{dx} = -1(x-1)^{-1/2} = -\frac{1}{\sqrt{x-1}}$
7. $y = (2x+5)^{-1/2} \Rightarrow \frac{dy}{dx} = -\frac{1}{2} (2x+5)^{-3/2} \cdot 2 = -(2x+5)^{-3/2}$
8. $y = (1-6x)^{2/3} \Rightarrow \frac{dy}{dx} = \frac{2}{3} (1-6x)^{-1/3} (-6) = -4(1-6x)^{-1/3}$
9. $y = x(x^2+1)^{1/2} \Rightarrow y' = x \cdot \frac{1}{2}(x^2+1)^{-1/2}(2x) + (x^2+1)^{1/2} \cdot 1 = (x^2+1)^{-1/2}(x^2+x^2+1) = \frac{2x^2+1}{\sqrt{x^2+1}}$
10. $y = x(x^2+1)^{-1/2} \Rightarrow y' = x \cdot (-\frac{1}{2})(x^2+1)^{-3/2}(2x) + (x^2+1)^{-1/2} \cdot 1 = (x^2+1)^{-3/2}(-x^2+x^2+1) = \frac{1}{(x^2+1)^{3/2}}$
11. $s = \sqrt[7]{t^2} = t^{2/7} \Rightarrow \frac{ds}{dt} = \frac{2}{7} t^{-5/7}$
12. $r = \sqrt[4]{\theta-3} = \theta^{-3/4} \Rightarrow \frac{dr}{d\theta} = -\frac{3}{4} \theta^{-7/4}$
13. $y = \sin((2t+5)^{-2/3}) \Rightarrow \frac{dy}{dt} = \cos((2t+5)^{-2/3}) \cdot (-\frac{2}{3})(2t+5)^{-5/3} \cdot 2 = -\frac{4}{3} (2t+5)^{-5/3} \cos((2t+5)^{-2/3})$
14. $z = \cos((1-6t)^{2/3}) \Rightarrow \frac{dz}{dt} = -\sin((1-6t)^{2/3}) \cdot \frac{2}{3} (1-6t)^{-1/3} (-6) = 4(1-6t)^{-1/3} \sin((1-6t)^{2/3})$
15. $f(x) = \sqrt{1-\sqrt{x}} = (1-x^{1/2})^{1/2} \Rightarrow f'(x) = \frac{1}{2} (1-x^{1/2})^{-1/2} (-\frac{1}{2} x^{-1/2}) = \frac{-1}{4(\sqrt{1-\sqrt{x}})\sqrt{x}} = \frac{-1}{4\sqrt{x(1-\sqrt{x})}}$
16. $g(x) = 2(2x^{-1/2}+1)^{-1/3} \Rightarrow g'(x) = -\frac{2}{3} (2x^{-1/2}+1)^{-4/3} \cdot (-1)x^{-3/2} = \frac{2}{3} (2x^{-1/2}+1)^{-4/3} x^{-3/2}$
17. $h(\theta) = \sqrt[3]{1+\cos(2\theta)} = (1+\cos 2\theta)^{1/3} \Rightarrow h'(\theta) = \frac{1}{3} (1+\cos 2\theta)^{-2/3} \cdot (-\sin 2\theta) \cdot 2 = -\frac{2}{3} (\sin 2\theta)(1+\cos 2\theta)^{-2/3}$
18. $k(\theta) = (\sin(\theta+5))^{5/4} \Rightarrow k'(\theta) = \frac{5}{4} (\sin(\theta+5))^{1/4} \cdot \cos(\theta+5) = \frac{5}{4} \cos(\theta+5)(\sin(\theta+5))^{1/4}$
19. $x^2y + xy^2 = 6$:
 - Step 1: $(x^2 \frac{dy}{dx} + y \cdot 2x) + (x \cdot 2y \frac{dy}{dx} + y^2 \cdot 1) = 0$
 - Step 2: $x^2 \frac{dy}{dx} + 2xy \frac{dy}{dx} = -2xy - y^2$
 - Step 3: $\frac{dy}{dx} (x^2 + 2xy) = -2xy - y^2$
 - Step 4: $\frac{dy}{dx} = \frac{-2xy - y^2}{x^2 + 2xy}$
20. $x^3 + y^3 = 18xy \Rightarrow 3x^2 + 3y^2 \frac{dy}{dx} = 18y + 18x \frac{dy}{dx} \Rightarrow (3y^2 - 18x) \frac{dy}{dx} = 18y - 3x^2 \Rightarrow \frac{dy}{dx} = \frac{6y - x^2}{y^2 - 6x}$
21. $2xy + y^2 = x + y$:
 - Step 1: $(2x \frac{dy}{dx} + 2y) + 2y \frac{dy}{dx} = 1 + \frac{dy}{dx}$

Step 2: $2x \frac{dy}{dx} + 2y \frac{dy}{dx} - \frac{dy}{dx} = 1 - 2y$

Step 3: $\frac{dy}{dx} (2x + 2y - 1) = 1 - 2y$

Step 4: $\frac{dy}{dx} = \frac{1-2y}{2x+2y-1}$

22. $x^3 - xy + y^3 = 1 \Rightarrow 3x^2 - y - x \frac{dy}{dx} + 3y^2 \frac{dy}{dx} = 0 \Rightarrow (3y^2 - x) \frac{dy}{dx} = y - 3x^2 \Rightarrow \frac{dy}{dx} = \frac{y-3x^2}{3y^2-x}$

23. $x^2(x-y)^2 = x^2 - y^2$:

Step 1: $x^2 \left[2(x-y) \left(1 - \frac{dy}{dx} \right) \right] + (x-y)^2 (2x) = 2x - 2y \frac{dy}{dx}$

Step 2: $-2x^2(x-y) \frac{dy}{dx} + 2y \frac{dy}{dx} = 2x - 2x^2(x-y) - 2x(x-y)^2$

Step 3: $\frac{dy}{dx} [-2x^2(x-y) + 2y] = 2x [1 - x(x-y) - (x-y)^2]$

Step 4: $\frac{dy}{dx} = \frac{2x [1 - x(x-y) - (x-y)^2]}{-2x^2(x-y) + 2y} = \frac{x [1 - x(x-y) - (x-y)^2]}{y - x^2(x-y)} = \frac{x(1 - x^2 + xy - x^2 + 2xy - y^2)}{x^2y - x^3 + y}$
 $= \frac{x - 2x^3 + 3x^2y - xy^2}{x^2y - x^3 + y}$

24. $(3xy + 7)^2 = 6y \Rightarrow 2(3xy + 7) \cdot (3x \frac{dy}{dx} + 3y) = 6 \frac{dy}{dx} \Rightarrow 2(3xy + 7)(3x) \frac{dy}{dx} - 6 \frac{dy}{dx} = -6y(3xy + 7)$

$\Rightarrow \frac{dy}{dx} [6x(3xy + 7) - 6] = -6y(3xy + 7) \Rightarrow \frac{dy}{dx} = -\frac{y(3xy + 7)}{x(3xy + 7) - 1} = \frac{3xy^2 + 7y}{1 - 3x^2y - 7x}$

25. $y^2 = \frac{x-1}{x+1} \Rightarrow 2y \frac{dy}{dx} = \frac{(x+1) - (x-1)}{(x+1)^2} = \frac{2}{(x+1)^2} \Rightarrow \frac{dy}{dx} = \frac{1}{y(x+1)^2}$

26. $x^2 = \frac{x-y}{x+y} \Rightarrow x^3 + x^2y = x - y \Rightarrow 3x^2 + 2xy + x^2y' = 1 - y' \Rightarrow (x^2 + 1)y' = 1 - 3x^2 - 2xy \Rightarrow y' = \frac{1 - 3x^2 - 2xy}{x^2 + 1}$

27. $x = \tan y \Rightarrow 1 = (\sec^2 y) \frac{dy}{dx} \Rightarrow \frac{dy}{dx} = \frac{1}{\sec^2 y} = \cos^2 y$

28. $xy = \cot(xy) \Rightarrow x \frac{dy}{dx} + y = -\csc^2(xy) \left(x \frac{dy}{dx} + y \right) \Rightarrow x \frac{dy}{dx} + x \csc^2(xy) \frac{dy}{dx} = -y \csc^2(xy) - y$

$\Rightarrow \frac{dy}{dx} [x + x \csc^2(xy)] = -y [\csc^2(xy) + 1] \Rightarrow \frac{dy}{dx} = \frac{-y [\csc^2(xy) + 1]}{x [1 + \csc^2(xy)]} = -\frac{y}{x}$

29. $x + \tan(xy) = 0 \Rightarrow 1 + [\sec^2(xy)] \left(y + x \frac{dy}{dx} \right) = 0 \Rightarrow x \sec^2(xy) \frac{dy}{dx} = -1 - y \sec^2(xy) \Rightarrow \frac{dy}{dx} = \frac{-1 - y \sec^2(xy)}{x \sec^2(xy)}$

$= \frac{-1}{x \sec^2(xy)} - \frac{y}{x} = \frac{-\cos^2(xy)}{x} - \frac{y}{x} = \frac{-\cos^2(xy) - y}{x}$

30. $x + \sin y = xy \Rightarrow 1 + (\cos y) \frac{dy}{dx} = y + x \frac{dy}{dx} \Rightarrow (\cos y - x) \frac{dy}{dx} = y - 1 \Rightarrow \frac{dy}{dx} = \frac{y-1}{\cos y - x}$

31. $y \sin\left(\frac{1}{y}\right) = 1 - xy \Rightarrow y \left[\cos\left(\frac{1}{y}\right) \cdot (-1) \frac{1}{y^2} \cdot \frac{dy}{dx} \right] + \sin\left(\frac{1}{y}\right) \cdot \frac{dy}{dx} = -x \frac{dy}{dx} - y \Rightarrow$

$\frac{dy}{dx} \left[-\frac{1}{y} \cos\left(\frac{1}{y}\right) + \sin\left(\frac{1}{y}\right) + x \right] = -y \Rightarrow \frac{dy}{dx} = \frac{-y}{-\frac{1}{y} \cos\left(\frac{1}{y}\right) + \sin\left(\frac{1}{y}\right) + x} = \frac{-y^2}{y \sin\left(\frac{1}{y}\right) - \cos\left(\frac{1}{y}\right) + xy}$

32. $y^2 \cos\left(\frac{1}{y}\right) = 2x + 2y \Rightarrow y^2 \left[-\sin\left(\frac{1}{y}\right) \cdot (-1) \frac{1}{y^2} \cdot \frac{dy}{dx} \right] + \cos\left(\frac{1}{y}\right) \cdot 2y \frac{dy}{dx} = 2 + 2 \frac{dy}{dx} \Rightarrow$

$\frac{dy}{dx} \left[\sin\left(\frac{1}{y}\right) + 2y \cos\left(\frac{1}{y}\right) - 2 \right] = 2 \Rightarrow \frac{dy}{dx} = \frac{2}{\sin\left(\frac{1}{y}\right) + 2y \cos\left(\frac{1}{y}\right) - 2}$

33. $\theta^{1/2} + r^{1/2} = 1 \Rightarrow \frac{1}{2} \theta^{-1/2} + \frac{1}{2} r^{-1/2} \cdot \frac{dr}{d\theta} = 0 \Rightarrow \frac{dr}{d\theta} \left[\frac{1}{2\sqrt{r}} \right] = \frac{-1}{2\sqrt{\theta}} \Rightarrow \frac{dr}{d\theta} = -\frac{2\sqrt{r}}{2\sqrt{\theta}} = -\frac{\sqrt{r}}{\sqrt{\theta}}$

162 Chapter 3 Differentiation

$$34. r - 2\sqrt{\theta} = \frac{3}{2}\theta^{2/3} + \frac{4}{3}\theta^{3/4} \Rightarrow \frac{dr}{d\theta} - \theta^{-1/2} = \theta^{-1/3} + \theta^{-1/4} \Rightarrow \frac{dr}{d\theta} = \theta^{-1/2} + \theta^{-1/3} + \theta^{-1/4}$$

$$35. \sin(r\theta) = \frac{1}{2} \Rightarrow [\cos(r\theta)] \left(r + \theta \frac{dr}{d\theta} \right) = 0 \Rightarrow \frac{dr}{d\theta} [\theta \cos(r\theta)] = -r \cos(r\theta) \Rightarrow \frac{dr}{d\theta} = \frac{-r \cos(r\theta)}{\theta \cos(r\theta)} = -\frac{r}{\theta},$$

$\cos(r\theta) \neq 0$

$$36. \cos r + \cot \theta = r\theta \Rightarrow (-\sin r) \frac{dr}{d\theta} - \csc^2 \theta = r + \theta \frac{dr}{d\theta} \Rightarrow \frac{dr}{d\theta} [-\sin r - \theta] = r + \csc^2 \theta \Rightarrow \frac{dr}{d\theta} = -\frac{r + \csc^2 \theta}{\sin r + \theta}$$

$$37. x^2 + y^2 = 1 \Rightarrow 2x + 2yy' = 0 \Rightarrow 2yy' = -2x \Rightarrow \frac{dy}{dx} = y' = -\frac{x}{y}; \text{ now to find } \frac{d^2y}{dx^2}, \frac{d}{dx} \left(-\frac{x}{y} \right)$$

$$\Rightarrow y'' = \frac{y(-1) + xy'}{y^2} = \frac{-y + x \left(-\frac{x}{y} \right)}{y^2} \text{ since } y' = -\frac{x}{y} \Rightarrow \frac{d^2y}{dx^2} = y'' = \frac{-y^2 - x^2}{y^3} = \frac{-y^2 - (1 - y^2)}{y^3} = \frac{-1}{y^3}$$

$$38. x^{2/3} + y^{2/3} = 1 \Rightarrow \frac{2}{3}x^{-1/3} + \frac{2}{3}y^{-1/3} \frac{dy}{dx} = 0 \Rightarrow \frac{dy}{dx} \left[\frac{2}{3}y^{-1/3} \right] = -\frac{2}{3}x^{-1/3} \Rightarrow y' = \frac{dy}{dx} = -\frac{x^{-1/3}}{y^{-1/3}} = -\left(\frac{y}{x}\right)^{1/3};$$

Differentiating again, $y'' = \frac{x^{1/3} \cdot (-\frac{1}{3}y^{-2/3})y' + y^{1/3} (\frac{1}{3}x^{-2/3})}{x^{2/3}} = \frac{x^{1/3} \cdot (-\frac{1}{3}y^{-2/3}) \left(-\frac{y^{1/3}}{x^{1/3}} \right) + y^{1/3} (\frac{1}{3}x^{-2/3})}{x^{2/3}}$

$$\Rightarrow \frac{d^2y}{dx^2} = \frac{1}{3}x^{-2/3}y^{-1/3} + \frac{1}{3}y^{1/3}x^{-4/3} = \frac{y^{1/3}}{3x^{4/3}} + \frac{1}{3y^{1/3}x^{2/3}}$$

$$39. y^2 = x^2 + 2x \Rightarrow 2yy' = 2x + 2 \Rightarrow y' = \frac{2x+2}{2y} = \frac{x+1}{y}; \text{ then } y'' = \frac{y - (x+1)y'}{y^2} = \frac{y - (x+1)\left(\frac{x+1}{y}\right)}{y^2}$$

$$\Rightarrow \frac{d^2y}{dx^2} = y'' = \frac{y^2 - (x+1)^2}{y^3}$$

$$40. y^2 - 2x = 1 - 2y \Rightarrow 2y \cdot y' - 2 = -2y' \Rightarrow y'(2y + 2) = 2 \Rightarrow y' = \frac{1}{y+1} = (y+1)^{-1}; \text{ then } y'' = -(y+1)^{-2} \cdot y'$$

$$= -(y+1)^{-2} (y+1)^{-1} \Rightarrow \frac{d^2y}{dx^2} = y'' = \frac{-1}{(y+1)^3}$$

$$41. 2\sqrt{y} = x - y \Rightarrow y^{-1/2}y' = 1 - y' \Rightarrow y'(y^{-1/2} + 1) = 1 \Rightarrow \frac{dy}{dx} = y' = \frac{1}{y^{-1/2} + 1} = \frac{\sqrt{y}}{\sqrt{y} + 1}; \text{ we can}$$

differentiate the equation $y'(y^{-1/2} + 1) = 1$ again to find y'' : $y'(-\frac{1}{2}y^{-3/2}y') + (y^{-1/2} + 1)y'' = 0$

$$\Rightarrow (y^{-1/2} + 1)y'' = \frac{1}{2}[y']^2y^{-3/2} \Rightarrow \frac{d^2y}{dx^2} = y'' = \frac{\frac{1}{2}\left(\frac{1}{y^{-1/2} + 1}\right)^2 y^{-3/2}}{(y^{-1/2} + 1)} = \frac{1}{2y^{3/2}(y^{-1/2} + 1)^3} = \frac{1}{2(1 + \sqrt{y})^3}$$

$$42. xy + y^2 = 1 \Rightarrow xy' + y + 2yy' = 0 \Rightarrow xy' + 2yy' = -y \Rightarrow y'(x + 2y) = -y \Rightarrow y' = \frac{-y}{(x+2y)}; \frac{d^2y}{dx^2} = y''$$

$$= \frac{-(x+2y)y' + y(1+2y')}{(x+2y)^2} = \frac{-(x+2y)\left[\frac{-y}{(x+2y)}\right] + y\left[1 + 2\left(\frac{-y}{(x+2y)}\right)\right]}{(x+2y)^2} = \frac{\frac{1}{(x+2y)}[y(x+2y) + y(x+2y) - 2y^2]}{(x+2y)^2}$$

$$= \frac{2y(x+2y) - 2y^2}{(x+2y)^3} = \frac{2y^2 + 2xy}{(x+2y)^3} = \frac{2y(x+y)}{(x+2y)^3}$$

$$43. x^3 + y^3 = 16 \Rightarrow 3x^2 + 3y^2y' = 0 \Rightarrow 3y^2y' = -3x^2 \Rightarrow y' = -\frac{x^2}{y^2}; \text{ we differentiate } y^2y' = -x^2 \text{ to find } y'':$$

$$y^2y'' + y'[2y \cdot y'] = -2x \Rightarrow y^2y'' = -2x - 2y[y']^2 \Rightarrow y'' = \frac{-2x - 2y\left(-\frac{x^2}{y^2}\right)^2}{y^2} = \frac{-2x - \frac{2x^4}{y^3}}{y^2}$$

$$= \frac{-2xy^3 - 2x^4}{y^5} \Rightarrow \left. \frac{d^2y}{dx^2} \right|_{(2,2)} = \frac{-32 - 32}{32} = -2$$

$$44. xy + y^2 = 1 \Rightarrow xy' + y + 2yy' = 0 \Rightarrow y'(x + 2y) = -y \Rightarrow y' = \frac{-y}{(x+2y)} \Rightarrow y'' = \frac{(x+2y)(-y') - (-y)(1+2y')}{(x+2y)^2};$$

since $y'|_{(0,-1)} = -\frac{1}{2}$ we obtain $y''|_{(0,-1)} = \frac{(-2)\left(\frac{1}{2}\right) - (-1)(0)}{4} = -\frac{1}{4}$

$$45. y^2 + x^2 = y^4 - 2x \text{ at } (-2, 1) \text{ and } (-2, -1) \Rightarrow 2y \frac{dy}{dx} + 2x = 4y^3 \frac{dy}{dx} - 2 \Rightarrow 2y \frac{dy}{dx} - 4y^3 \frac{dy}{dx} = -2 - 2x$$

$$\Rightarrow \frac{dy}{dx} (2y - 4y^3) = -2 - 2x \Rightarrow \frac{dy}{dx} = \frac{x+1}{2y^2-y} \Rightarrow \frac{dy}{dx} \Big|_{(-2,1)} = -1 \text{ and } \frac{dy}{dx} \Big|_{(-2,-1)} = 1$$

$$46. (x^2 + y^2)^2 = (x - y)^2 \text{ at } (1, 0) \text{ and } (1, -1) \Rightarrow 2(x^2 + y^2) \left(2x + 2y \frac{dy}{dx} \right) = 2(x - y) \left(1 - \frac{dy}{dx} \right)$$

$$\Rightarrow \frac{dy}{dx} [2y(x^2 + y^2) + (x - y)] = -2x(x^2 + y^2) + (x - y) \Rightarrow \frac{dy}{dx} = \frac{-2x(x^2 + y^2) + (x - y)}{2y(x^2 + y^2) + (x - y)} \Rightarrow \frac{dy}{dx} \Big|_{(1,0)} = -1$$

$$\text{and } \frac{dy}{dx} \Big|_{(1,-1)} = 1$$

$$47. x^2 + xy - y^2 = 1 \Rightarrow 2x + y + xy' - 2yy' = 0 \Rightarrow (x - 2y)y' = -2x - y \Rightarrow y' = \frac{2x + y}{2y - x};$$

$$(a) \text{ the slope of the tangent line } m = y' \Big|_{(2,3)} = \frac{7}{4} \Rightarrow \text{the tangent line is } y - 3 = \frac{7}{4}(x - 2) \Rightarrow y = \frac{7}{4}x - \frac{1}{2}$$

$$(b) \text{ the normal line is } y - 3 = -\frac{4}{7}(x - 2) \Rightarrow y = -\frac{4}{7}x + \frac{29}{7}$$

$$48. x^2 + y^2 = 25 \Rightarrow 2x + 2yy' = 0 \Rightarrow y' = -\frac{x}{y};$$

$$(a) \text{ the slope of the tangent line } m = y' \Big|_{(3,-4)} = -\frac{x}{y} \Big|_{(3,-4)} = \frac{3}{4} \Rightarrow \text{the tangent line is } y + 4 = \frac{3}{4}(x - 3)$$

$$\Rightarrow y = \frac{3}{4}x - \frac{25}{4}$$

$$(b) \text{ the normal line is } y + 4 = -\frac{4}{3}(x - 3) \Rightarrow y = -\frac{4}{3}x$$

$$49. x^2y^2 = 9 \Rightarrow 2xy^2 + 2x^2yy' = 0 \Rightarrow x^2yy' = -xy^2 \Rightarrow y' = -\frac{y}{x};$$

$$(a) \text{ the slope of the tangent line } m = y' \Big|_{(-1,3)} = -\frac{y}{x} \Big|_{(-1,3)} = 3 \Rightarrow \text{the tangent line is } y - 3 = 3(x + 1)$$

$$\Rightarrow y = 3x + 6$$

$$(b) \text{ the normal line is } y - 3 = -\frac{1}{3}(x + 1) \Rightarrow y = -\frac{1}{3}x + \frac{8}{3}$$

$$50. y^2 - 2x - 4y - 1 = 0 \Rightarrow 2yy' - 2 - 4y' = 0 \Rightarrow 2(y - 2)y' = 2 \Rightarrow y' = \frac{1}{y-2};$$

$$(a) \text{ the slope of the tangent line } m = y' \Big|_{(-2,1)} = -1 \Rightarrow \text{the tangent line is } y - 1 = -1(x + 2) \Rightarrow y = -x - 1$$

$$(b) \text{ the normal line is } y - 1 = 1(x + 2) \Rightarrow y = x + 3$$

$$51. 6x^2 + 3xy + 2y^2 + 17y - 6 = 0 \Rightarrow 12x + 3y + 3xy' + 4yy' + 17y' = 0 \Rightarrow y'(3x + 4y + 17) = -12x - 3y$$

$$\Rightarrow y' = \frac{-12x - 3y}{3x + 4y + 17};$$

$$(a) \text{ the slope of the tangent line } m = y' \Big|_{(-1,0)} = \frac{-12x - 3y}{3x + 4y + 17} \Big|_{(-1,0)} = \frac{6}{7} \Rightarrow \text{the tangent line is } y - 0 = \frac{6}{7}(x + 1)$$

$$\Rightarrow y = \frac{6}{7}x + \frac{6}{7}$$

$$(b) \text{ the normal line is } y - 0 = -\frac{7}{6}(x + 1) \Rightarrow y = -\frac{7}{6}x - \frac{7}{6}$$

$$52. x^2 - \sqrt{3}xy + 2y^2 = 5 \Rightarrow 2x - \sqrt{3}xy' - \sqrt{3}y + 4yy' = 0 \Rightarrow y'(4y - \sqrt{3}x) = \sqrt{3}y - 2x \Rightarrow y' = \frac{\sqrt{3}y - 2x}{4y - \sqrt{3}x};$$

$$(a) \text{ the slope of the tangent line } m = y' \Big|_{(\sqrt{3},2)} = \frac{\sqrt{3}y - 2x}{4y - \sqrt{3}x} \Big|_{(\sqrt{3},2)} = 0 \Rightarrow \text{the tangent line is } y = 2$$

$$(b) \text{ the normal line is } x = \sqrt{3}$$

$$53. 2xy + \pi \sin y = 2\pi \Rightarrow 2xy' + 2y + \pi(\cos y)y' = 0 \Rightarrow y'(2x + \pi \cos y) = -2y \Rightarrow y' = \frac{-2y}{2x + \pi \cos y};$$

$$(a) \text{ the slope of the tangent line } m = y' \Big|_{(1, \frac{\pi}{2})} = \frac{-2y}{2x + \pi \cos y} \Big|_{(1, \frac{\pi}{2})} = -\frac{\pi}{2} \Rightarrow \text{the tangent line is}$$

$$y - \frac{\pi}{2} = -\frac{\pi}{2}(x - 1) \Rightarrow y = -\frac{\pi}{2}x + \pi$$

$$(b) \text{ the normal line is } y - \frac{\pi}{2} = \frac{2}{\pi}(x - 1) \Rightarrow y = \frac{2}{\pi}x - \frac{2}{\pi} + \frac{\pi}{2}$$

$$54. x \sin 2y = y \cos 2x \Rightarrow x(\cos 2y)2y' + \sin 2y = -2y \sin 2x + y' \cos 2x \Rightarrow y'(2x \cos 2y - \cos 2x) \\ = -\sin 2y - 2y \sin 2x \Rightarrow y' = \frac{\sin 2y + 2y \sin 2x}{\cos 2x - 2x \cos 2y};$$

$$(a) \text{ the slope of the tangent line } m = y' \Big|_{\left(\frac{\pi}{4}, \frac{\pi}{2}\right)} = \frac{\sin 2y + 2y \sin 2x}{\cos 2x - 2x \cos 2y} \Big|_{\left(\frac{\pi}{4}, \frac{\pi}{2}\right)} = \frac{\pi}{2} = 2 \Rightarrow \text{the tangent line is}$$

$$y - \frac{\pi}{2} = 2 \left(x - \frac{\pi}{4}\right) \Rightarrow y = 2x$$

$$(b) \text{ the normal line is } y - \frac{\pi}{2} = -\frac{1}{2} \left(x - \frac{\pi}{4}\right) \Rightarrow y = -\frac{1}{2}x + \frac{5\pi}{8}$$

$$55. y = 2 \sin(\pi x - y) \Rightarrow y' = 2[\cos(\pi x - y)] \cdot (\pi - y') \Rightarrow y'[1 + 2 \cos(\pi x - y)] = 2\pi \cos(\pi x - y) \\ \Rightarrow y' = \frac{2\pi \cos(\pi x - y)}{1 + 2 \cos(\pi x - y)};$$

$$(a) \text{ the slope of the tangent line } m = y' \Big|_{(1,0)} = \frac{2\pi \cos(\pi x - y)}{1 + 2 \cos(\pi x - y)} \Big|_{(1,0)} = 2\pi \Rightarrow \text{the tangent line is}$$

$$y - 0 = 2\pi(x - 1) \Rightarrow y = 2\pi x - 2\pi$$

$$(b) \text{ the normal line is } y - 0 = -\frac{1}{2\pi}(x - 1) \Rightarrow y = -\frac{x}{2\pi} + \frac{1}{2\pi}$$

$$56. x^2 \cos^2 y - \sin y = 0 \Rightarrow x^2(2 \cos y)(-\sin y)y' + 2x \cos^2 y - y' \cos y = 0 \Rightarrow y'[-2x^2 \cos y \sin y - \cos y] \\ = -2x \cos^2 y \Rightarrow y' = \frac{2x \cos^2 y}{2x^2 \cos y \sin y + \cos y};$$

$$(a) \text{ the slope of the tangent line } m = y' \Big|_{(0,\pi)} = \frac{2x \cos^2 y}{2x^2 \cos y \sin y + \cos y} \Big|_{(0,\pi)} = 0 \Rightarrow \text{the tangent line is } y = \pi$$

$$(b) \text{ the normal line is } x = 0$$

57. Solving $x^2 + xy + y^2 = 7$ and $y = 0 \Rightarrow x^2 = 7 \Rightarrow x = \pm \sqrt{7} \Rightarrow (-\sqrt{7}, 0)$ and $(\sqrt{7}, 0)$ are the points where the curve crosses the x-axis. Now $x^2 + xy + y^2 = 7 \Rightarrow 2x + y + xy' + 2yy' = 0 \Rightarrow (x + 2y)y' = -2x - y$
 $\Rightarrow y' = -\frac{2x+y}{x+2y} \Rightarrow m = -\frac{2x+y}{x+2y} \Rightarrow$ the slope at $(-\sqrt{7}, 0)$ is $m = -\frac{-2\sqrt{7}}{-\sqrt{7}} = -2$ and the slope at $(\sqrt{7}, 0)$ is $m = -\frac{2\sqrt{7}}{\sqrt{7}} = -2$. Since the slope is -2 in each case, the corresponding tangents must be parallel.

$$58. x^2 + xy + y^2 = 7 \Rightarrow 2x + y + x \frac{dy}{dx} + 2y \frac{dy}{dx} = 0 \Rightarrow (x + 2y) \frac{dy}{dx} = -2x - y \Rightarrow \frac{dy}{dx} = \frac{-2x-y}{x+2y} \text{ and } \frac{dx}{dy} = \frac{x+2y}{-2x-y};$$

$$(a) \text{ Solving } \frac{dy}{dx} = 0 \Rightarrow -2x - y = 0 \Rightarrow y = -2x \text{ and substitution into the original equation gives}$$

$$x^2 + x(-2x) + (-2x)^2 = 7 \Rightarrow 3x^2 = 7 \Rightarrow x = \pm \sqrt{\frac{7}{3}} \text{ and } y = \mp 2\sqrt{\frac{7}{3}} \text{ when the tangents are parallel to the } x\text{-axis.}$$

$$(b) \text{ Solving } \frac{dx}{dy} = 0 \Rightarrow x + 2y = 0 \Rightarrow y = -\frac{x}{2} \text{ and substitution gives } x^2 + x\left(-\frac{x}{2}\right) + \left(-\frac{x}{2}\right)^2 = 7 \Rightarrow \frac{3x^2}{4} = 7$$

$$\Rightarrow x = \pm 2\sqrt{\frac{7}{3}} \text{ and } y = \mp \sqrt{\frac{7}{3}} \text{ when the tangents are parallel to the } y\text{-axis.}$$

$$59. y^4 = y^2 - x^2 \Rightarrow 4y^3y' = 2yy' - 2x \Rightarrow 2(2y^3 - y)y' = -2x \Rightarrow y' = \frac{-x}{y-2y^3}; \text{ the slope of the tangent line at}$$

$$\left(\frac{\sqrt{3}}{4}, \frac{\sqrt{3}}{2}\right) \text{ is } \frac{x}{y-2y^3} \Big|_{\left(\frac{\sqrt{3}}{4}, \frac{\sqrt{3}}{2}\right)} = \frac{\frac{\sqrt{3}}{4}}{\frac{\sqrt{3}}{2} - 6\frac{\sqrt{3}}{8}} = \frac{\frac{1}{4}}{\frac{1}{2} - \frac{3}{4}} = \frac{1}{2-3} = -1; \text{ the slope of the tangent line at } \left(\frac{\sqrt{3}}{4}, \frac{1}{2}\right)$$

$$\text{is } \frac{x}{y-2y^3} \Big|_{\left(\frac{\sqrt{3}}{4}, \frac{1}{2}\right)} = \frac{\frac{\sqrt{3}}{4}}{\frac{1}{2} - \frac{1}{8}} = \frac{2\sqrt{3}}{4-2} = \sqrt{3}$$

$$60. y^2(2-x) = x^3 \Rightarrow 2yy'(2-x) + y^2(-1) = 3x^2 \Rightarrow y' = \frac{y^2+3x^2}{2y(2-x)}; \text{ the slope of the tangent line is}$$

$$m = \frac{y^2+3x^2}{2y(2-x)} \Big|_{(1,1)} = \frac{4}{2} = 2 \Rightarrow \text{the tangent line is } y - 1 = 2(x - 1) \Rightarrow y = 2x - 1; \text{ the normal line is}$$

$$y - 1 = -\frac{1}{2}(x - 1) \Rightarrow y = -\frac{1}{2}x + \frac{3}{2}$$

$$61. y^4 - 4y^2 = x^4 - 9x^2 \Rightarrow 4y^3y' - 8yy' = 4x^3 - 18x \Rightarrow y'(4y^3 - 8y) = 4x^3 - 18x \Rightarrow y' = \frac{4x^3 - 18x}{4y^3 - 8y} = \frac{2x^3 - 9x}{2y^3 - 4y}$$

$$= \frac{x(2x^2-9)}{y(2y^2-4)} = m; (-3, 2): m = \frac{(-3)(18-9)}{2(8-4)} = -\frac{27}{8}; (-3, -2): m = \frac{27}{8}; (3, 2): m = \frac{27}{8}; (3, -2): m = -\frac{27}{8}$$

$$62. x^3 + y^3 - 9xy = 0 \Rightarrow 3x^2 + 3y^2y' - 9xy' - 9y = 0 \Rightarrow y'(3y^2 - 9x) = 9y - 3x^2 \Rightarrow y' = \frac{9y - 3x^2}{3y^2 - 9x} = \frac{3y - x^2}{y^2 - 3x}$$

$$(a) y'|_{(4,2)} = \frac{5}{4} \text{ and } y'|_{(2,4)} = \frac{4}{5};$$

$$(b) y' = 0 \Rightarrow \frac{3y - x^2}{y^2 - 3x} = 0 \Rightarrow 3y - x^2 = 0 \Rightarrow y = \frac{x^2}{3} \Rightarrow x^3 + \left(\frac{x^2}{3}\right)^3 - 9x\left(\frac{x^2}{3}\right) = 0 \Rightarrow x^6 - 54x^3 = 0 \\ \Rightarrow x^3(x^3 - 54) = 0 \Rightarrow x = 0 \text{ or } x = \sqrt[3]{54} = 3\sqrt[3]{2} \Rightarrow \text{there is a horizontal tangent at } x = 3\sqrt[3]{2}. \text{ To find the}$$

corresponding y-value, we will use part (c).

$$(c) \frac{dx}{dy} = 0 \Rightarrow \frac{y^2 - 3x}{3y - x^2} = 0 \Rightarrow y^2 - 3x = 0 \Rightarrow y = \pm\sqrt{3x}; y = \sqrt{3x} \Rightarrow x^3 + (\sqrt{3x})^3 - 9x\sqrt{3x} = 0 \\ \Rightarrow x^3 - 6\sqrt{3}x^{3/2} = 0 \Rightarrow x^{3/2}(x^{3/2} - 6\sqrt{3}) = 0 \Rightarrow x^{3/2} = 0 \text{ or } x^{3/2} = 6\sqrt{3} \Rightarrow x = 0 \text{ or } x = \sqrt[3]{108} = 3\sqrt[3]{4}.$$

Since the equation $x^3 + y^3 - 9xy = 0$ is symmetric in x and y , the graph is symmetric about the line $y = x$.

That is, if (a, b) is a point on the folium, then so is (b, a) . Moreover, if $y'|_{(a,b)} = m$, then $y'|_{(b,a)} = \frac{1}{m}$.

Thus, if the folium has a horizontal tangent at (a, b) , it has a vertical tangent at (b, a) so one might expect that with a horizontal tangent at $x = \sqrt[3]{54}$ and a vertical tangent at $x = 3\sqrt[3]{4}$, the points of tangency are $(\sqrt[3]{54}, 3\sqrt[3]{4})$ and $(3\sqrt[3]{4}, \sqrt[3]{54})$, respectively. One can check that these points do satisfy the equation $x^3 + y^3 - 9xy = 0$.

$$63. x^2 - 2tx + 2t^2 = 4 \Rightarrow 2x \frac{dx}{dt} - 2x - 2t \frac{dx}{dt} + 4t = 0 \Rightarrow (2x - 2t) \frac{dx}{dt} = 2x - 4t \Rightarrow \frac{dx}{dt} = \frac{2x-4t}{2x-2t} = \frac{x-2t}{x-t};$$

$$2y^3 - 3t^2 = 4 \Rightarrow 6y^2 \frac{dy}{dt} - 6t = 0 \Rightarrow \frac{dy}{dt} = \frac{6t}{6y^2} = \frac{t}{y^2}; \text{ thus } \frac{dy}{dx} = \frac{dy/dt}{dx/dt} = \frac{\left(\frac{t}{y^2}\right)}{\left(\frac{x-2t}{x-t}\right)} = \frac{t(x-t)}{y^2(x-2t)}; t = 2$$

$$\Rightarrow x^2 - 2(2)x + 2(2)^2 = 4 \Rightarrow x^2 - 4x + 4 = 0 \Rightarrow (x-2)^2 = 0 \Rightarrow x = 2; t = 2 \Rightarrow 2y^3 - 3(2)^2 = 4$$

$$\Rightarrow 2y^3 = 16 \Rightarrow y^3 = 8 \Rightarrow y = 2; \text{ therefore } \left. \frac{dy}{dx} \right|_{t=2} = \frac{2(2-2)}{(2)^2(2-2(2))} = 0$$

$$64. x = \sqrt{5 - \sqrt{t}} \Rightarrow \frac{dx}{dt} = \frac{1}{2} (5 - \sqrt{t})^{-1/2} \left(-\frac{1}{2} t^{-1/2}\right) = -\frac{1}{4\sqrt{t}\sqrt{5 - \sqrt{t}}}; y(t-1) = \sqrt{t} \Rightarrow y + (t-1) \frac{dy}{dt} = \frac{1}{2} t^{-1/2}$$

$$\Rightarrow (t-1) \frac{dy}{dt} = \frac{1}{2\sqrt{t}} - y \Rightarrow \frac{dy}{dt} = \frac{\frac{1}{2\sqrt{t}} - y}{(t-1)} = \frac{1 - 2y\sqrt{t}}{2t\sqrt{t} - 2\sqrt{t}}; \text{ thus } \frac{dy}{dx} = \frac{\frac{dy}{dt}}{\frac{dx}{dt}} = \frac{\frac{1 - 2y\sqrt{t}}{2t\sqrt{t} - 2\sqrt{t}}}{-\frac{1}{4\sqrt{t}\sqrt{5 - \sqrt{t}}}} = \frac{1 - 2y\sqrt{t}}{2\sqrt{t}(t-1)} \cdot \frac{4\sqrt{t}\sqrt{5 - \sqrt{t}}}{-1}$$

$$= \frac{2(1 - 2y\sqrt{t})\sqrt{5 - \sqrt{t}}}{1 - t}; t = 4 \Rightarrow x = \sqrt{5 - \sqrt{4}} = \sqrt{3}; t = 4 \Rightarrow y(3) = \sqrt{4} = 2$$

$$\text{therefore, } \left. \frac{dy}{dx} \right|_{t=4} = \frac{2(1 - 2(2)\sqrt{4})\sqrt{5 - \sqrt{4}}}{1 - 4} = \frac{14}{3}$$

$$65. x + 2x^{3/2} = t^2 + t \Rightarrow \frac{dx}{dt} + 3x^{1/2} \frac{dx}{dt} = 2t + 1 \Rightarrow (1 + 3x^{1/2}) \frac{dx}{dt} = 2t + 1 \Rightarrow \frac{dx}{dt} = \frac{2t+1}{1+3x^{1/2}}; y\sqrt{t+1} + 2t\sqrt{y} = 4$$

$$\Rightarrow \frac{dy}{dt} \sqrt{t+1} + y \left(\frac{1}{2}\right) (t+1)^{-1/2} + 2\sqrt{y} + 2t \left(\frac{1}{2} y^{-1/2}\right) \frac{dy}{dt} = 0 \Rightarrow \frac{dy}{dt} \sqrt{t+1} + \frac{y}{2\sqrt{t+1}} + 2\sqrt{y} + \left(\frac{t}{\sqrt{y}}\right) \frac{dy}{dt} = 0$$

$$\Rightarrow \left(\sqrt{t+1} + \frac{t}{\sqrt{y}}\right) \frac{dy}{dt} = \frac{-y}{2\sqrt{t+1}} - 2\sqrt{y} \Rightarrow \frac{dy}{dt} = \frac{\left(\frac{-y}{2\sqrt{t+1}} - 2\sqrt{y}\right)}{\left(\sqrt{t+1} + \frac{t}{\sqrt{y}}\right)} = \frac{-y\sqrt{y} - 4y\sqrt{t+1}}{2\sqrt{y}(t+1) + 2t\sqrt{t+1}}; \text{ thus}$$

$$\frac{dy}{dx} = \frac{dy/dt}{dx/dt} = \frac{\left(\frac{-y\sqrt{y} - 4y\sqrt{t+1}}{2\sqrt{y}(t+1) + 2t\sqrt{t+1}}\right)}{\left(\frac{2t+1}{1+3x^{1/2}}\right)}; t = 0 \Rightarrow x + 2x^{3/2} = 0 \Rightarrow x(1 + 2x^{1/2}) = 0 \Rightarrow x = 0; t = 0$$

$$\Rightarrow y\sqrt{0+1} + 2(0)\sqrt{y} = 4 \Rightarrow y = 4; \text{ therefore } \left. \frac{dy}{dx} \right|_{t=0} = \frac{\left(\frac{-4\sqrt{4} - 4(4)\sqrt{0+1}}{2\sqrt{4(0+1)} + 2(0)\sqrt{0+1}}\right)}{\left(\frac{2(0)+1}{1+3(0)^{1/2}}\right)} = -6$$

$$66. \quad x \sin t + 2x = t \Rightarrow \frac{dx}{dt} \sin t + x \cos t + 2 \frac{dx}{dt} = 1 \Rightarrow (\sin t + 2) \frac{dx}{dt} = 1 - x \cos t \Rightarrow \frac{dx}{dt} = \frac{1 - x \cos t}{\sin t + 2};$$

$$t \sin t - 2t = y \Rightarrow \sin t + t \cos t - 2 = \frac{dy}{dt}; \text{ thus } \frac{dy}{dx} = \frac{\sin t + t \cos t - 2}{\frac{1 - x \cos t}{\sin t + 2}}; t = \pi \Rightarrow x \sin \pi + 2x = \pi$$

$$\Rightarrow x = \frac{\pi}{2}; \text{ therefore } \left. \frac{dy}{dx} \right|_{t=\pi} = \frac{\sin \pi + \pi \cos \pi - 2}{\left[\frac{1 - \left(\frac{\pi}{2}\right) \cos \pi}{\sin \pi + 2} \right]} = \frac{-4\pi - 8}{2 + \pi} = -4$$

67. (a) if $f(x) = \frac{3}{2}x^{2/3} - 3$, then $f'(x) = x^{-1/3}$ and $f''(x) = -\frac{1}{3}x^{-4/3}$ so the claim $f''(x) = x^{-1/3}$ is false
 (b) if $f(x) = \frac{9}{10}x^{5/3} - 7$, then $f'(x) = \frac{3}{2}x^{2/3}$ and $f''(x) = x^{-1/3}$ is true
 (c) $f''(x) = x^{-1/3} \Rightarrow f'''(x) = -\frac{1}{3}x^{-4/3}$ is true
 (d) if $f'(x) = \frac{3}{2}x^{2/3} + 6$, then $f''(x) = x^{-1/3}$ is true

$$68. \quad 2x^2 + 3y^2 = 5 \Rightarrow 4x + 6yy' = 0 \Rightarrow y' = -\frac{2x}{3y} \Rightarrow y'|_{(1,1)} = -\frac{2x}{3y}|_{(1,1)} = -\frac{2}{3} \text{ and } y'|_{(1,-1)} = -\frac{2x}{3y}|_{(1,-1)} = \frac{2}{3};$$

also, $y^2 = x^3 \Rightarrow 2yy' = 3x^2 \Rightarrow y' = \frac{3x^2}{2y} \Rightarrow y'|_{(1,1)} = \frac{3x^2}{2y}|_{(1,1)} = \frac{3}{2}$ and $y'|_{(1,-1)} = \frac{3x^2}{2y}|_{(1,-1)} = -\frac{3}{2}$. Therefore the tangents to the curves are perpendicular at $(1, 1)$ and $(1, -1)$ (i.e., the curves are orthogonal at these two points of intersection).

$$69. \quad x^2 + 2xy - 3y^2 = 0 \Rightarrow 2x + 2xy' + 2y - 6yy' = 0 \Rightarrow y'(2x - 6y) = -2x - 2y \Rightarrow y' = \frac{x+y}{3y-x} \Rightarrow \text{the slope of the}$$

tangent line $m = y'|_{(1,1)} = \frac{x+y}{3y-x}|_{(1,1)} = 1 \Rightarrow$ the equation of the normal line at $(1, 1)$ is $y - 1 = -1(x - 1)$
 $\Rightarrow y = -x + 2$. To find where the normal line intersects the curve we substitute into its equation:
 $x^2 + 2x(2 - x) - 3(2 - x)^2 = 0 \Rightarrow x^2 + 4x - 2x^2 - 3(4 - 4x + x^2) = 0 \Rightarrow -4x^2 + 16x - 12 = 0$
 $\Rightarrow x^2 - 4x + 3 = 0 \Rightarrow (x - 3)(x - 1) = 0 \Rightarrow x = 3$ and $y = -x + 2 = -1$. Therefore, the normal to the curve at $(1, 1)$ intersects the curve at the point $(3, -1)$. Note that it also intersects the curve at $(1, 1)$.

$$70. \quad xy + 2x - y = 0 \Rightarrow x \frac{dy}{dx} + y + 2 - \frac{dy}{dx} = 0 \Rightarrow \frac{dy}{dx} = \frac{y+2}{1-x};$$

the slope of the line $2x + y = 0$ is -2 . In order to be parallel, the normal lines must also have slope of -2 . Since a normal is perpendicular to a tangent, the slope of the tangent is $\frac{1}{2}$. Therefore, $\frac{y+2}{1-x} = \frac{1}{2} \Rightarrow 2y + 4 = 1 - x \Rightarrow x = -3 - 2y$. Substituting in the original equation, $y(-3 - 2y) + 2(-3 - 2y) - y = 0 \Rightarrow y^2 + 4y + 3 = 0 \Rightarrow y = -3$ or $y = -1$. If $y = -3$, then $x = 3$ and $y + 3 = -2(x - 3) \Rightarrow y = -2x + 3$. If $y = -1$, then $x = -1$ and $y + 1 = -2(x + 1) \Rightarrow y = -2x - 3$.

$$71. \quad y^2 = x \Rightarrow \frac{dy}{dx} = \frac{1}{2y}.$$

If a normal is drawn from $(a, 0)$ to (x_1, y_1) on the curve its slope satisfies $\frac{y_1 - 0}{x_1 - a} = -2y_1$
 $\Rightarrow y_1 = -2y_1(x_1 - a)$ or $a = x_1 + \frac{1}{2}$. Since $x_1 \geq 0$ on the curve, we must have that $a \geq \frac{1}{2}$. By symmetry, the two points on the parabola are $(x_1, \sqrt{x_1})$ and $(x_1, -\sqrt{x_1})$. For the normal to be perpendicular,
 $\left(\frac{\sqrt{x_1}}{x_1 - a}\right) \left(\frac{-\sqrt{x_1}}{a - x_1}\right) = -1 \Rightarrow \frac{x_1}{(a - x_1)^2} = 1 \Rightarrow x_1 = (a - x_1)^2 \Rightarrow x_1 = \left(x_1 + \frac{1}{2} - x_1\right)^2 \Rightarrow x_1 = \frac{1}{4}$ and $y_1 = \pm \frac{1}{2}$.
 Therefore, $\left(\frac{1}{4}, \pm \frac{1}{2}\right)$ and $a = \frac{3}{4}$.

72. Ex. 6b.) $y = x^{1/2}$ has no derivative at $x = 0$ because the slope of the graph becomes vertical at $x = 0$.

Ex. 7a.) $y = (1 - x^2)^{1/4}$ has a derivative only on $(-1, 1)$ because the function is defined only on $[-1, 1]$ and the slope of the tangent becomes vertical at both $x = -1$ and $x = 1$.

$$73. \quad xy^3 + x^2y = 6 \Rightarrow x \left(3y^2 \frac{dy}{dx}\right) + y^3 + x^2 \frac{dy}{dx} + 2xy = 0 \Rightarrow \frac{dy}{dx} (3xy^2 + x^2) = -y^3 - 2xy \Rightarrow \frac{dy}{dx} = \frac{-y^3 - 2xy}{3xy^2 + x^2}$$

$$= -\frac{y^3 + 2xy}{3xy^2 + x^2}; \text{ also, } xy^3 + x^2y = 6 \Rightarrow x(3y^2) + y^3 \frac{dx}{dy} + x^2 + y \left(2x \frac{dx}{dy}\right) = 0 \Rightarrow \frac{dx}{dy} (y^3 + 2xy) = -3xy^2 - x^2$$

$$\Rightarrow \frac{dx}{dy} = -\frac{3xy^2 + x^2}{y^3 + 2xy}; \text{ thus } \frac{dx}{dy} \text{ appears to equal } \frac{1}{\frac{dy}{dx}}. \text{ The two different treatments view the graphs as functions}$$

symmetric across the line $y = x$, so their slopes are reciprocals of one another at the corresponding points (a, b) and (b, a).

74. $x^3 + y^2 = \sin^2 y \Rightarrow 3x^2 + 2y \frac{dy}{dx} = (2 \sin y)(\cos y) \frac{dy}{dx} \Rightarrow \frac{dy}{dx} (2y - 2 \sin y \cos y) = -3x^2 \Rightarrow \frac{dy}{dx} = \frac{-3x^2}{2y - 2 \sin y \cos y}$
 $= \frac{3x^2}{2 \sin y \cos y - 2y}$; also, $x^3 + y^2 = \sin^2 y \Rightarrow 3x^2 \frac{dx}{dy} + 2y = 2 \sin y \cos y \Rightarrow \frac{dx}{dy} = \frac{2 \sin y \cos y - 2y}{3x^2}$; thus $\frac{dx}{dy}$ appears to equal $\frac{1}{\frac{dy}{dx}}$. The two different treatments view the graphs as functions symmetric across the line $y = x$ so their slopes are reciprocals of one another at the corresponding points (a, b) and (b, a).

75. $x^4 + 4y^2 = 1$:

(a) $y^2 = \frac{1-x^4}{4} \Rightarrow y = \pm \frac{1}{2} \sqrt{1-x^4}$
 $\Rightarrow \frac{dy}{dx} = \pm \frac{1}{4} (1-x^4)^{-1/2} (-4x^3) = \frac{\pm x^3}{(1-x^4)^{1/2}}$;
 differentiating implicitly, we find, $4x^3 + 8y \frac{dy}{dx} = 0$
 $\Rightarrow \frac{dy}{dx} = \frac{-4x^3}{8y} = \frac{-4x^3}{8(\pm \frac{1}{2} \sqrt{1-x^4})} = \frac{\pm x^3}{(1-x^4)^{1/2}}$.

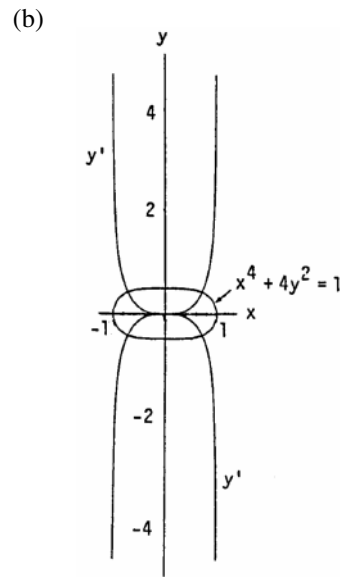

76. $(x - 2)^2 + y^2 = 4$:

(a) $y = \pm \sqrt{4 - (x - 2)^2}$
 $\Rightarrow \frac{dy}{dx} = \pm \frac{1}{2} (4 - (x - 2)^2)^{-1/2} (-2(x - 2))$
 $= \frac{\pm(x-2)}{[4 - (x-2)^2]^{1/2}}$; differentiating implicitly,
 $2(x - 2) + 2y \frac{dy}{dx} = 0 \Rightarrow \frac{dy}{dx} = \frac{-2(x-2)}{2y}$
 $= \frac{-(x-2)}{y} = \frac{-(x-2)}{\pm[4 - (x-2)^2]^{1/2}} = \frac{\pm(x-2)}{[4 - (x-2)^2]^{1/2}}$.

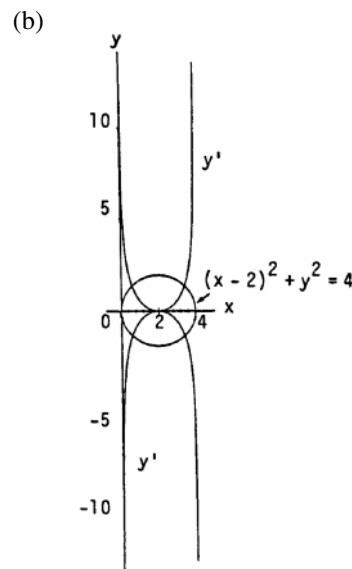

77-84. Example CAS commands:

Maple:

```
q1 := x^3-x*y+y^3 = 7;
pt := [x=2,y=1];
p1 := implicitplot( q1, x=-3..3, y=-3..3 );
p1;
```

```
eval( q1, pt );
q2 := implicitdiff( q1, y, x );
m := eval( q2, pt );
tan_line := y = 1 + m*(x-2);
p2 := implicitplot( tan_line, x=-5..5, y=-5..5, color=green );
p3 := pointplot( eval([x,y],pt), color=blue );
display( [p1,p2,p3], ="Section 3.6 #77(c)" );
```

Mathematica: (functions and x0 may vary):

Note use of double equal sign (logic statement) in definition of eqn and tanline.

```
<<Graphics`ImplicitPlot`
Clear[x, y]
{x0, y0}={1, π/4};
eqn=x + Tan[y/x]==2;
ImplicitPlot[eqn,{ x, x0 - 3, x0 + 3},{y, y0 - 3, y0 + 3}]
eqn/.{x → x0, y → y0}
eqn/.{ y → y[x]}
D[%, x]
Solve[%, y'[x]]
slope=y'[x]/.First[%]
m=slope/.{x → x0, y[x] → y0}
tanline=y==y0 + m (x - x0)
ImplicitPlot[{eqn, tanline}, {x, x0 - 3, x0 + 3},{y, y0 - 3, y0 + 3}]
```

3.7 RELATED RATES

- $A = \pi r^2 \Rightarrow \frac{dA}{dt} = 2\pi r \frac{dr}{dt}$
- $S = 4\pi r^2 \Rightarrow \frac{dS}{dt} = 8\pi r \frac{dr}{dt}$
- | | |
|--|--|
| (a) $V = \pi r^2 h \Rightarrow \frac{dV}{dt} = \pi r^2 \frac{dh}{dt}$ | (b) $V = \pi r^2 h \Rightarrow \frac{dV}{dt} = 2\pi r h \frac{dr}{dt}$ |
| (c) $V = \pi r^2 h \Rightarrow \frac{dV}{dt} = \pi r^2 \frac{dh}{dt} + 2\pi r h \frac{dr}{dt}$ | |
- | | |
|---|---|
| (a) $V = \frac{1}{3}\pi r^2 h \Rightarrow \frac{dV}{dt} = \frac{1}{3}\pi r^2 \frac{dh}{dt}$ | (b) $V = \frac{1}{3}\pi r^2 h \Rightarrow \frac{dV}{dt} = \frac{2}{3}\pi r h \frac{dr}{dt}$ |
| (c) $\frac{dV}{dt} = \frac{1}{3}\pi r^2 \frac{dh}{dt} + \frac{2}{3}\pi r h \frac{dr}{dt}$ | |
- | | |
|---|--|
| (a) $\frac{dV}{dt} = 1$ volt/sec | (b) $\frac{dI}{dt} = -\frac{1}{3}$ amp/sec |
| (c) $\frac{dV}{dt} = R \left(\frac{dI}{dt}\right) + I \left(\frac{dR}{dt}\right) \Rightarrow \frac{dR}{dt} = \frac{1}{I} \left(\frac{dV}{dt} - R \frac{dI}{dt}\right) \Rightarrow \frac{dR}{dt} = \frac{1}{I} \left(\frac{dV}{dt} - \frac{V}{I} \frac{dI}{dt}\right)$ | |
| (d) $\frac{dR}{dt} = \frac{1}{2} \left[1 - \frac{12}{2} \left(-\frac{1}{3}\right)\right] = \left(\frac{1}{2}\right) (3) = \frac{3}{2}$ ohms/sec, R is increasing | |
- | | |
|--|--|
| (a) $P = RI^2 \Rightarrow \frac{dP}{dt} = I^2 \frac{dR}{dt} + 2RI \frac{dI}{dt}$ | (b) $P = RI^2 \Rightarrow 0 = \frac{dP}{dt} = I^2 \frac{dR}{dt} + 2RI \frac{dI}{dt} \Rightarrow \frac{dR}{dt} = -\frac{2RI}{I^2} \frac{dI}{dt} = -\frac{2\left(\frac{P}{I}\right)}{I^2} \frac{dI}{dt} = -\frac{2P}{I^3} \frac{dI}{dt}$ |
|--|--|
- | | |
|---|--|
| (a) $s = \sqrt{x^2 + y^2} = (x^2 + y^2)^{1/2} \Rightarrow \frac{ds}{dt} = \frac{x}{\sqrt{x^2 + y^2}} \frac{dx}{dt}$ | (b) $s = \sqrt{x^2 + y^2} = (x^2 + y^2)^{1/2} \Rightarrow \frac{ds}{dt} = \frac{x}{\sqrt{x^2 + y^2}} \frac{dx}{dt} + \frac{y}{\sqrt{x^2 + y^2}} \frac{dy}{dt}$ |
| (c) $s = \sqrt{x^2 + y^2} \Rightarrow s^2 = x^2 + y^2 \Rightarrow 2s \frac{ds}{dt} = 2x \frac{dx}{dt} + 2y \frac{dy}{dt} \Rightarrow 2s \cdot 0 = 2x \frac{dx}{dt} + 2y \frac{dy}{dt} \Rightarrow \frac{dx}{dt} = -\frac{y}{x} \frac{dy}{dt}$ | |
- | | |
|--|--|
| (a) $s = \sqrt{x^2 + y^2 + z^2} \Rightarrow s^2 = x^2 + y^2 + z^2 \Rightarrow 2s \frac{ds}{dt} = 2x \frac{dx}{dt} + 2y \frac{dy}{dt} + 2z \frac{dz}{dt}$ | |
|--|--|

$$\Rightarrow \frac{ds}{dt} = \frac{x}{\sqrt{x^2+y^2+z^2}} \frac{dx}{dt} + \frac{y}{\sqrt{x^2+y^2+z^2}} \frac{dy}{dt} + \frac{z}{\sqrt{x^2+y^2+z^2}} \frac{dz}{dt}$$

(b) From part (a) with $\frac{dx}{dt} = 0 \Rightarrow \frac{ds}{dt} = \frac{y}{\sqrt{x^2+y^2+z^2}} \frac{dy}{dt} + \frac{z}{\sqrt{x^2+y^2+z^2}} \frac{dz}{dt}$

(c) From part (a) with $\frac{ds}{dt} = 0 \Rightarrow 0 = 2x \frac{dx}{dt} + 2y \frac{dy}{dt} + 2z \frac{dz}{dt} \Rightarrow \frac{dx}{dt} + \frac{y}{x} \frac{dy}{dt} + \frac{z}{x} \frac{dz}{dt} = 0$

9. (a) $A = \frac{1}{2} ab \sin \theta \Rightarrow \frac{dA}{dt} = \frac{1}{2} ab \cos \theta \frac{d\theta}{dt}$ (b) $A = \frac{1}{2} ab \sin \theta \Rightarrow \frac{dA}{dt} = \frac{1}{2} ab \cos \theta \frac{d\theta}{dt} + \frac{1}{2} b \sin \theta \frac{da}{dt}$

(c) $A = \frac{1}{2} ab \sin \theta \Rightarrow \frac{dA}{dt} = \frac{1}{2} ab \cos \theta \frac{d\theta}{dt} + \frac{1}{2} b \sin \theta \frac{da}{dt} + \frac{1}{2} a \sin \theta \frac{db}{dt}$

10. Given $A = \pi r^2$, $\frac{dA}{dt} = 0.01$ cm/sec, and $r = 50$ cm. Since $\frac{dA}{dt} = 2\pi r \frac{dr}{dt}$, then $\left. \frac{dA}{dt} \right|_{r=50} = 2\pi(50) \left(\frac{1}{100} \right) = \pi$ cm²/min.

11. Given $\frac{d\ell}{dt} = -2$ cm/sec, $\frac{dw}{dt} = 2$ cm/sec, $\ell = 12$ cm and $w = 5$ cm.

(a) $A = \ell w \Rightarrow \frac{dA}{dt} = \ell \frac{dw}{dt} + w \frac{d\ell}{dt} \Rightarrow \frac{dA}{dt} = 12(2) + 5(-2) = 14$ cm²/sec, increasing

(b) $P = 2\ell + 2w \Rightarrow \frac{dP}{dt} = 2 \frac{d\ell}{dt} + 2 \frac{dw}{dt} = 2(-2) + 2(2) = 0$ cm/sec, constant

(c) $D = \sqrt{w^2 + \ell^2} = (w^2 + \ell^2)^{1/2} \Rightarrow \frac{dD}{dt} = \frac{1}{2} (w^2 + \ell^2)^{-1/2} (2w \frac{dw}{dt} + 2\ell \frac{d\ell}{dt}) \Rightarrow \frac{dD}{dt} = \frac{w \frac{dw}{dt} + \ell \frac{d\ell}{dt}}{\sqrt{w^2 + \ell^2}}$
 $= \frac{(5)(2) + (12)(-2)}{\sqrt{25 + 144}} = -\frac{14}{13}$ cm/sec, decreasing

12. (a) $V = xyz \Rightarrow \frac{dV}{dt} = yz \frac{dx}{dt} + xz \frac{dy}{dt} + xy \frac{dz}{dt} \Rightarrow \left. \frac{dV}{dt} \right|_{(4,3,2)} = (3)(2)(1) + (4)(2)(-2) + (4)(3)(1) = 2$ m³/sec

(b) $S = 2xy + 2xz + 2yz \Rightarrow \frac{dS}{dt} = (2y + 2z) \frac{dx}{dt} + (2x + 2z) \frac{dy}{dt} + (2x + 2y) \frac{dz}{dt}$
 $\Rightarrow \left. \frac{dS}{dt} \right|_{(4,3,2)} = (10)(1) + (12)(-2) + (14)(1) = 0$ m²/sec

(c) $\ell = \sqrt{x^2 + y^2 + z^2} = (x^2 + y^2 + z^2)^{1/2} \Rightarrow \frac{d\ell}{dt} = \frac{x}{\sqrt{x^2+y^2+z^2}} \frac{dx}{dt} + \frac{y}{\sqrt{x^2+y^2+z^2}} \frac{dy}{dt} + \frac{z}{\sqrt{x^2+y^2+z^2}} \frac{dz}{dt}$
 $\Rightarrow \left. \frac{d\ell}{dt} \right|_{(4,3,2)} = \left(\frac{4}{\sqrt{29}} \right) (1) + \left(\frac{3}{\sqrt{29}} \right) (-2) + \left(\frac{2}{\sqrt{29}} \right) (1) = 0$ m/sec

13. Given: $\frac{dx}{dt} = 5$ ft/sec, the ladder is 13 ft long, and $x = 12$, $y = 5$ at the instant of time

(a) Since $x^2 + y^2 = 169 \Rightarrow \frac{dy}{dt} = -\frac{x}{y} \frac{dx}{dt} = -\left(\frac{12}{5} \right) (5) = -12$ ft/sec, the ladder is sliding down the wall

(b) The area of the triangle formed by the ladder and walls is $A = \frac{1}{2} xy \Rightarrow \frac{dA}{dt} = \left(\frac{1}{2} \right) \left(x \frac{dy}{dt} + y \frac{dx}{dt} \right)$. The area is changing at $\frac{1}{2} [12(-12) + 5(5)] = -\frac{119}{2} = -59.5$ ft²/sec.

(c) $\cos \theta = \frac{x}{13} \Rightarrow -\sin \theta \frac{d\theta}{dt} = \frac{1}{13} \cdot \frac{dx}{dt} \Rightarrow \frac{d\theta}{dt} = -\frac{1}{13 \sin \theta} \cdot \frac{dx}{dt} = -\left(\frac{1}{5} \right) (5) = -1$ rad/sec

14. $s^2 = y^2 + x^2 \Rightarrow 2s \frac{ds}{dt} = 2x \frac{dx}{dt} + 2y \frac{dy}{dt} \Rightarrow \frac{ds}{dt} = \frac{1}{s} \left(x \frac{dx}{dt} + y \frac{dy}{dt} \right) \Rightarrow \frac{ds}{dt} = \frac{1}{\sqrt{169}} [5(-442) + 12(-481)] = -614$ knots

15. Let s represent the distance between the girl and the kite and x represents the horizontal distance between the girl and kite $\Rightarrow s^2 = (300)^2 + x^2 \Rightarrow \frac{ds}{dt} = \frac{x}{s} \frac{dx}{dt} = \frac{400(25)}{500} = 20$ ft/sec.

16. When the diameter is 3.8 in., the radius is 1.9 in. and $\frac{dr}{dt} = \frac{1}{3000}$ in/min. Also $V = 6\pi r^2 \Rightarrow \frac{dV}{dt} = 12\pi r \frac{dr}{dt} \Rightarrow \frac{dV}{dt} = 12\pi(1.9) \left(\frac{1}{3000} \right) = 0.0076\pi$. The volume is changing at about 0.0239 in³/min.

17. $V = \frac{1}{3} \pi r^2 h$, $h = \frac{3}{8} (2r) = \frac{3r}{4} \Rightarrow r = \frac{4h}{3} \Rightarrow V = \frac{1}{3} \pi \left(\frac{4h}{3} \right)^2 h = \frac{16\pi h^3}{27} \Rightarrow \frac{dV}{dt} = \frac{16\pi h^2}{9} \frac{dh}{dt}$

(a) $\left. \frac{dh}{dt} \right|_{h=4} = \left(\frac{9}{16\pi h^2} \right) (10) = \frac{90}{256\pi} \approx 0.1119$ m/sec = 11.19 cm/sec

(b) $r = \frac{4h}{3} \Rightarrow \frac{dr}{dt} = \frac{4}{3} \frac{dh}{dt} = \frac{4}{3} \left(\frac{90}{256\pi} \right) = \frac{15}{32\pi} \approx 0.1492$ m/sec = 14.92 cm/sec

18. (a) $V = \frac{1}{3} \pi r^2 h$ and $r = \frac{15h}{2} \Rightarrow V = \frac{1}{3} \pi \left(\frac{15h}{2}\right)^2 h = \frac{75\pi h^3}{4} \Rightarrow \frac{dV}{dt} = \frac{225\pi h^2}{4} \frac{dh}{dt} \Rightarrow \left. \frac{dh}{dt} \right|_{h=5} = \frac{4(-50)}{225\pi(5)^2} = \frac{-8}{225\pi}$
 $\approx -0.0113 \text{ m/min} = -1.13 \text{ cm/min}$
- (b) $r = \frac{15h}{2} \Rightarrow \frac{dr}{dt} = \frac{15}{2} \frac{dh}{dt} \Rightarrow \left. \frac{dr}{dt} \right|_{h=5} = \left(\frac{15}{2}\right) \left(\frac{-8}{225\pi}\right) = \frac{-4}{15\pi} \approx -0.0849 \text{ m/sec} = -8.49 \text{ cm/sec}$
19. (a) $V = \frac{\pi}{3} y^2(3R - y) \Rightarrow \frac{dV}{dt} = \frac{\pi}{3} [2y(3R - y) + y^2(-1)] \frac{dy}{dt} \Rightarrow \frac{dy}{dt} = \left[\frac{\pi}{3} (6Ry - 3y^2)\right]^{-1} \frac{dV}{dt} \Rightarrow$ at $R = 13$ and $y = 8$ we have $\frac{dy}{dt} = \frac{1}{144\pi}(-6) = \frac{-1}{24\pi} \text{ m/min}$
- (b) The hemisphere is on the circle $r^2 + (13 - y)^2 = 169 \Rightarrow r = \sqrt{26y - y^2} \text{ m}$
- (c) $r = (26y - y^2)^{1/2} \Rightarrow \frac{dr}{dt} = \frac{1}{2} (26y - y^2)^{-1/2} (26 - 2y) \frac{dy}{dt} \Rightarrow \left. \frac{dr}{dt} \right|_{y=8} = \frac{13 - y}{\sqrt{26y - y^2}} \frac{dy}{dt} \Rightarrow \left. \frac{dr}{dt} \right|_{y=8} = \frac{13 - 8}{\sqrt{26 \cdot 8 - 64}} \left(\frac{-1}{24\pi}\right) = \frac{-5}{288\pi} \text{ m/min}$
20. If $V = \frac{4}{3} \pi r^3$, $S = 4\pi r^2$, and $\frac{dV}{dt} = kS = 4k\pi r^2$, then $\frac{dV}{dt} = 4\pi r^2 \frac{dr}{dt} \Rightarrow 4k\pi r^2 = 4\pi r^2 \frac{dr}{dt} \Rightarrow \frac{dr}{dt} = k$, a constant. Therefore, the radius is increasing at a constant rate.
21. If $V = \frac{4}{3} \pi r^3$, $r = 5$, and $\frac{dV}{dt} = 100\pi \text{ ft}^3/\text{min}$, then $\frac{dV}{dt} = 4\pi r^2 \frac{dr}{dt} \Rightarrow \frac{dr}{dt} = 1 \text{ ft/min}$. Then $S = 4\pi r^2 \Rightarrow \frac{dS}{dt} = 8\pi r \frac{dr}{dt} = 8\pi(5)(1) = 40\pi \text{ ft}^2/\text{min}$, the rate at which the surface area is increasing.
22. Let s represent the length of the rope and x the horizontal distance of the boat from the dock.
- (a) We have $s^2 = x^2 + 36 \Rightarrow \frac{dx}{dt} = \frac{s}{x} \frac{ds}{dt} = \frac{s}{\sqrt{s^2 - 36}} \frac{ds}{dt}$. Therefore, the boat is approaching the dock at $\left. \frac{dx}{dt} \right|_{s=10} = \frac{10}{\sqrt{10^2 - 36}} (-2) = -2.5 \text{ ft/sec}$.
- (b) $\cos \theta = \frac{x}{r} \Rightarrow -\sin \theta \frac{d\theta}{dt} = -\frac{x}{r^2} \frac{dr}{dt} \Rightarrow \frac{d\theta}{dt} = \frac{x}{r^2 \sin \theta} \frac{dr}{dt}$. Thus, $r = 10$, $x = 8$, and $\sin \theta = \frac{6}{10} \Rightarrow \frac{d\theta}{dt} = \frac{6}{10^2 \left(\frac{6}{10}\right)} \cdot (-2) = -\frac{3}{20} \text{ rad/sec}$
23. Let s represent the distance between the bicycle and balloon, h the height of the balloon and x the horizontal distance between the balloon and the bicycle. The relationship between the variables is $s^2 = h^2 + x^2$
 $\Rightarrow \frac{ds}{dt} = \frac{1}{s} \left(h \frac{dh}{dt} + x \frac{dx}{dt}\right) \Rightarrow \frac{ds}{dt} = \frac{1}{85} [68(1) + 51(17)] = 11 \text{ ft/sec}$.
24. (a) Let h be the height of the coffee in the pot. Since the radius of the pot is 3, the volume of the coffee is $V = 9\pi h \Rightarrow \frac{dV}{dt} = 9\pi \frac{dh}{dt} \Rightarrow$ the rate the coffee is rising is $\frac{dh}{dt} = \frac{1}{9\pi} \frac{dV}{dt} = \frac{10}{9\pi} \text{ in/min}$.
- (b) Let h be the height of the coffee in the pot. From the figure, the radius of the filter $r = \frac{h}{2} \Rightarrow V = \frac{1}{3} \pi r^2 h = \frac{\pi h^3}{12}$, the volume of the filter. The rate the coffee is falling is $\frac{dh}{dt} = \frac{4}{\pi h^2} \frac{dV}{dt} = \frac{4}{25\pi} (-10) = -\frac{8}{5\pi} \text{ in/min}$.
25. $y = QD^{-1} \Rightarrow \frac{dy}{dt} = D^{-1} \frac{dQ}{dt} - QD^{-2} \frac{dD}{dt} = \frac{1}{41} (0) - \frac{233}{(41)^2} (-2) = \frac{466}{1681} \text{ L/min} \Rightarrow$ increasing about 0.2772 L/min
26. (a) $\frac{dc}{dt} = (3x^2 - 12x + 15) \frac{dx}{dt} = (3(2)^2 - 12(2) + 15) (0.1) = 0.3$, $\frac{dr}{dt} = 9 \frac{dx}{dt} = 9(0.1) = 0.9$, $\frac{dp}{dt} = 0.9 - 0.3 = 0.6$
- (b) $\frac{dc}{dt} = (3x^2 - 12x - 45x^{-2}) \frac{dx}{dt} = (3(1.5)^2 - 12(1.5) - 45(1.5)^{-2}) (0.05) = -1.5625$, $\frac{dr}{dt} = 70 \frac{dx}{dt} = 70(0.05) = 3.5$,
 $\frac{dp}{dt} = 3.5 - (-1.5625) = 5.0625$
27. Let $P(x, y)$ represent a point on the curve $y = x^2$ and θ the angle of inclination of a line containing P and the origin. Consequently, $\tan \theta = \frac{y}{x} \Rightarrow \tan \theta = \frac{x^2}{x} = x \Rightarrow \sec^2 \theta \frac{d\theta}{dt} = \frac{dx}{dt} \Rightarrow \frac{d\theta}{dt} = \cos^2 \theta \frac{dx}{dt}$. Since $\left. \frac{dx}{dt} \right|_{x=3} = 10 \text{ m/sec}$ and $\cos^2 \theta \Big|_{x=3} = \frac{x^2}{y^2 + x^2} = \frac{3^2}{9^2 + 3^2} = \frac{1}{10}$, we have $\left. \frac{d\theta}{dt} \right|_{x=3} = 1 \text{ rad/sec}$.
28. $y = (-x)^{1/2}$ and $\tan \theta = \frac{y}{x} \Rightarrow \tan \theta = \frac{(-x)^{1/2}}{x} \Rightarrow \sec^2 \theta \frac{d\theta}{dt} = \frac{\left(\frac{1}{2}\right)(-x)^{-1/2}(-1)x - (-x)^{1/2}(1)}{x^2} \frac{dx}{dt}$

$$\Rightarrow \frac{d\theta}{dt} = \left(\frac{-\frac{x}{2\sqrt{-x}} - \sqrt{-x}}{x^2} \right) (\cos^2 \theta) \left(\frac{dx}{dt} \right). \text{ Now, } \tan \theta = \frac{2}{-4} = -\frac{1}{2} \Rightarrow \cos \theta = -\frac{2}{\sqrt{5}} \Rightarrow \cos^2 \theta = \frac{4}{5}. \text{ Then}$$

$$\frac{d\theta}{dt} = \left(\frac{\frac{4}{16}}{16} \right) \left(\frac{4}{5} \right) (-8) = \frac{2}{5} \text{ rad/sec.}$$

29. The distance from the origin is $s = \sqrt{x^2 + y^2}$ and we wish to find $\left. \frac{ds}{dt} \right|_{(5,12)}$

$$= \frac{1}{2} (x^2 + y^2)^{-1/2} \left(2x \frac{dx}{dt} + 2y \frac{dy}{dt} \right) \Big|_{(5,12)} = \frac{(5)(-1) + (12)(-5)}{\sqrt{25 + 144}} = -5 \text{ m/sec}$$

30. When s represents the length of the shadow and x the distance of the man from the streetlight, then $s = \frac{3}{5}x$.

(a) If I represents the distance of the tip of the shadow from the streetlight, then $I = s + x \Rightarrow \frac{dI}{dt} = \frac{ds}{dt} + \frac{dx}{dt}$
 (which is velocity not speed) $\Rightarrow \left| \frac{dI}{dt} \right| = \left| \frac{3}{5} \frac{dx}{dt} + \frac{dx}{dt} \right| = \left| \frac{8}{5} \right| \left| \frac{dx}{dt} \right| = \frac{8}{5} |-5| = 8 \text{ ft/sec}$, the speed the tip of the shadow is moving along the ground.

(b) $\frac{ds}{dt} = \frac{3}{5} \frac{dx}{dt} = \frac{3}{5} (-5) = -3 \text{ ft/sec}$, so the length of the shadow is decreasing at a rate of 3 ft/sec.

31. Let $s = 16t^2$ represent the distance the ball has fallen, h the distance between the ball and the ground, and I the distance between the shadow and the point directly beneath the ball. Accordingly, $s + h = 50$ and since the triangle LOQ and triangle PRQ are similar we have

$$I = \frac{30h}{50-h} \Rightarrow h = 50 - 16t^2 \text{ and } I = \frac{30(50 - 16t^2)}{50 - (50 - 16t^2)}$$

$$= \frac{1500}{16t^2} - 30 \Rightarrow \frac{dI}{dt} = -\frac{1500}{8t^3} \Rightarrow \left. \frac{dI}{dt} \right|_{t=\frac{1}{2}} = -1500 \text{ ft/sec.}$$

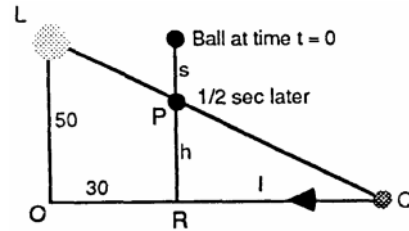

32. Let $s =$ distance of car from foot of perpendicular in the textbook diagram $\Rightarrow \tan \theta = \frac{s}{132} \Rightarrow \sec^2 \theta \frac{d\theta}{dt} = \frac{1}{132} \frac{ds}{dt}$
 $\Rightarrow \frac{d\theta}{dt} = \frac{\cos^2 \theta}{132} \frac{ds}{dt}$; $\frac{ds}{dt} = -264$ and $\theta = 0 \Rightarrow \frac{d\theta}{dt} = -2 \text{ rad/sec}$. A half second later the car has traveled 132 ft right of the perpendicular $\Rightarrow |\theta| = \frac{\pi}{4}$, $\cos^2 \theta = \frac{1}{2}$, and $\frac{ds}{dt} = 264$ (since s increases) $\Rightarrow \frac{d\theta}{dt} = \left(\frac{1}{2} \right) \left(\frac{1}{132} \right) (264) = 1 \text{ rad/sec}$.

33. The volume of the ice is $V = \frac{4}{3} \pi r^3 - \frac{4}{3} \pi 4^3 \Rightarrow \frac{dV}{dt} = 4\pi r^2 \frac{dr}{dt} \Rightarrow \left. \frac{dr}{dt} \right|_{r=6} = \frac{-5}{72\pi} \text{ in./min}$ when $\frac{dV}{dt} = -10 \text{ in}^3/\text{min}$, the thickness of the ice is decreasing at $\frac{5}{72\pi} \text{ in./min}$. The surface area is $S = 4\pi r^2 \Rightarrow \frac{dS}{dt} = 8\pi r \frac{dr}{dt} \Rightarrow \left. \frac{dS}{dt} \right|_{r=6} = 48\pi \left(\frac{-5}{72\pi} \right) = -\frac{10}{3} \text{ in}^2/\text{min}$, the outer surface area of the ice is decreasing at $\frac{10}{3} \text{ in}^2/\text{min}$.

34. Let s represent the horizontal distance between the car and plane while r is the line-of-sight distance between the car and plane $\Rightarrow 9 + s^2 = r^2 \Rightarrow \frac{ds}{dt} = \frac{r}{\sqrt{r^2 - 9}} \frac{dr}{dt} \Rightarrow \left. \frac{ds}{dt} \right|_{r=5} = \frac{5}{\sqrt{16}} (-160) = -200 \text{ mph}$
 \Rightarrow speed of plane + speed of car = 200 mph \Rightarrow the speed of the car is 80 mph.

35. When x represents the length of the shadow, then $\tan \theta = \frac{80}{x} \Rightarrow \sec^2 \theta \frac{d\theta}{dt} = -\frac{80}{x^2} \frac{dx}{dt} \Rightarrow \frac{dx}{dt} = \frac{-x^2 \sec^2 \theta}{80} \frac{d\theta}{dt}$.

We are given that $\frac{d\theta}{dt} = 0.27^\circ = \frac{3\pi}{2000} \text{ rad/min}$. At $x = 60$, $\cos \theta = \frac{3}{5} \Rightarrow$

$$\left| \frac{dx}{dt} \right| = \left| \frac{-x^2 \sec^2 \theta}{80} \frac{d\theta}{dt} \right| \Big|_{\left(\frac{d\theta}{dt} = \frac{3\pi}{2000} \text{ and } \sec \theta = \frac{5}{3} \right)} = \frac{3\pi}{16} \text{ ft/min} \approx 0.589 \text{ ft/min} \approx 7.1 \text{ in./min.}$$

36. Let A represent the side opposite θ and B represent the side adjacent θ . $\tan \theta = \frac{A}{B} \Rightarrow \sec^2 \theta \frac{d\theta}{dt} = \frac{1}{B} \frac{dA}{dt} - \frac{A}{B^2} \frac{dB}{dt}$
 $t \Rightarrow$ at $A = 10 \text{ m}$ and $B = 20 \text{ m}$ we have $\cos \theta = \frac{20}{10\sqrt{5}} = \frac{2}{\sqrt{5}}$ and $\frac{d\theta}{dt} = \left[\left(\frac{1}{20} \right) (-2) - \left(\frac{10}{400} (1) \right) \right] \left(\frac{4}{5} \right)$
 $= \left(-\frac{1}{10} - \frac{1}{40} \right) \left(\frac{4}{5} \right) = -\frac{1}{10} \text{ rad/sec} = -\frac{18^\circ}{\pi} / \text{sec} \approx -6^\circ / \text{sec}$

37. Let x represent distance of the player from second base and s the distance to third base. Then $\frac{dx}{dt} = -16 \text{ ft/sec}$

(a) $s^2 = x^2 + 8100 \Rightarrow 2s \frac{ds}{dt} = 2x \frac{dx}{dt} \Rightarrow \frac{ds}{dt} = \frac{x}{s} \frac{dx}{dt}$. When the player is 30 ft from first base, $x = 60$

$$\Rightarrow s = 30\sqrt{13} \text{ and } \frac{ds}{dt} = \frac{60}{30\sqrt{13}}(-16) = \frac{-32}{\sqrt{13}} \approx -8.875 \text{ ft/sec}$$

$$(b) \cos \theta_1 = \frac{90}{s} \Rightarrow -\sin \theta_1 \frac{d\theta_1}{dt} = -\frac{90}{s^2} \cdot \frac{ds}{dt} \Rightarrow \frac{d\theta_1}{dt} = \frac{90}{s^2 \sin \theta_1} \cdot \frac{ds}{dt} = \frac{90}{sx} \cdot \frac{ds}{dt}. \text{ Therefore, } x = 60 \text{ and } s = 30\sqrt{13}$$

$$\Rightarrow \frac{d\theta_1}{dt} = \frac{90}{(30\sqrt{13})(60)} \cdot \left(\frac{-32}{\sqrt{13}}\right) = \frac{-8}{65} \text{ rad/sec}; \sin \theta_2 = \frac{90}{s} \Rightarrow \cos \theta_2 \frac{d\theta_2}{dt} = -\frac{90}{s^2} \cdot \frac{ds}{dt} \Rightarrow \frac{d\theta_2}{dt} = \frac{-90}{s^2 \cos \theta_2} \cdot \frac{ds}{dt}$$

$$= \frac{-90}{sx} \cdot \frac{ds}{dt}. \text{ Therefore, } x = 60 \text{ and } s = 30\sqrt{13} \Rightarrow \frac{d\theta_2}{dt} = \frac{8}{65} \text{ rad/sec.}$$

$$(c) \frac{d\theta_1}{dt} = \frac{90}{s^2 \sin \theta_1} \cdot \frac{ds}{dt} = \frac{90}{(s^2 \cdot \frac{x}{s})} \cdot \left(\frac{x}{s}\right) \cdot \left(\frac{dx}{dt}\right) = \left(\frac{90}{s^2}\right) \left(\frac{dx}{dt}\right) = \left(\frac{90}{x^2 + 8100}\right) \frac{dx}{dt} \Rightarrow \lim_{x \rightarrow 0} \frac{d\theta_1}{dt}$$

$$= \lim_{x \rightarrow 0} \left(\frac{90}{x^2 + 8100}\right)(-15) = -\frac{1}{6} \text{ rad/sec}; \frac{d\theta_2}{dt} = \frac{-90}{s^2 \cos \theta_2} \cdot \frac{ds}{dt} = \left(\frac{-90}{s^2 \cdot \frac{x}{s}}\right) \left(\frac{x}{s}\right) \left(\frac{dx}{dt}\right)$$

$$= \left(\frac{-90}{x^2 + 8100}\right) \frac{dx}{dt} \Rightarrow \lim_{x \rightarrow 0} \frac{d\theta_2}{dt} = \frac{1}{6} \text{ rad/sec}$$

38. Let a represent the distance between point O and ship A , b the distance between point O and ship B , and D the distance between the ships. By the Law of Cosines, $D^2 = a^2 + b^2 - 2ab \cos 120^\circ$

$$\Rightarrow \frac{dD}{dt} = \frac{1}{2D} \left[2a \frac{da}{dt} + 2b \frac{db}{dt} + a \frac{db}{dt} + b \frac{da}{dt} \right]. \text{ When } a = 5, \frac{da}{dt} = 14, b = 3, \text{ and } \frac{db}{dt} = 21, \text{ then } \frac{dD}{dt} = \frac{413}{2D}$$

where $D = 7$. The ships are moving $\frac{dD}{dt} = 29.5$ knots apart.

3.8 LINEARIZATION AND DIFFERENTIALS

- $f(x) = x^3 - 2x + 3 \Rightarrow f'(x) = 3x^2 - 2 \Rightarrow L(x) = f'(2)(x - 2) + f(2) = 10(x - 2) + 7 \Rightarrow L(x) = 10x - 13$ at $x = 2$
- $f(x) = \sqrt{x^2 + 9} = (x^2 + 9)^{1/2} \Rightarrow f'(x) = \left(\frac{1}{2}\right)(x^2 + 9)^{-1/2}(2x) = \frac{x}{\sqrt{x^2 + 9}} \Rightarrow L(x) = f'(-4)(x + 4) + f(-4)$
 $= -\frac{4}{5}(x + 4) + 5 \Rightarrow L(x) = -\frac{4}{5}x + \frac{9}{5}$ at $x = -4$
- $f(x) = x + \frac{1}{x} \Rightarrow f'(x) = 1 - x^{-2} \Rightarrow L(x) = f'(1)(x - 1) + f(1) = 2 + 0(x - 1) = 2$
- $f(x) = x^{1/3} \Rightarrow f'(x) = \frac{1}{3x^{2/3}} \Rightarrow L(x) = f'(-8)(x - (-8)) + f(-8) = \frac{1}{12}(x + 8) - 2 \Rightarrow L(x) = \frac{1}{12}x - \frac{4}{3}$
- $f(x) = x^2 + 2x \Rightarrow f'(x) = 2x + 2 \Rightarrow L(x) = f'(0)(x - 0) + f(0) = 2(x - 0) + 0 \Rightarrow L(x) = 2x$ at $x = 0$
- $f(x) = x^{-1} \Rightarrow f'(x) = -x^{-2} \Rightarrow L(x) = f'(1)(x - 1) + f(1) = (-1)(x - 1) + 1 \Rightarrow L(x) = -x + 2$ at $x = 1$
- $f(x) = 2x^2 + 4x - 3 \Rightarrow f'(x) = 4x + 4 \Rightarrow L(x) = f'(-1)(x + 1) + f(-1) = 0(x + 1) + (-5) \Rightarrow L(x) = -5$ at $x = -1$
- $f(x) = 1 + x \Rightarrow f'(x) = 1 \Rightarrow L(x) = f'(8)(x - 8) + f(8) = 1(x - 8) + 9 \Rightarrow L(x) = x + 1$ at $x = 8$
- $f(x) = \sqrt[3]{x} = x^{1/3} \Rightarrow f'(x) = \left(\frac{1}{3}\right)x^{-2/3} \Rightarrow L(x) = f'(8)(x - 8) + f(8) = \frac{1}{12}(x - 8) + 2 \Rightarrow L(x) = \frac{1}{12}x + \frac{4}{3}$ at $x = 8$
- $f(x) = \frac{x}{x+1} \Rightarrow f'(x) = \frac{(1)(x+1) - (1)(x)}{(x+1)^2} = \frac{1}{(x+1)^2} \Rightarrow L(x) = f'(1)(x - 1) + f(1) = \frac{1}{4}(x - 1) + \frac{1}{2}$
 $\Rightarrow L(x) = \frac{1}{4}x + \frac{1}{4}$ at $x = 1$

11. $f(x) = \sin x \Rightarrow f'(x) = \cos x$

(a) $L(x) = f'(0)(x - 0) + f(0) = 1(x - 0) + 0$
 $\Rightarrow L(x) = x$ at $x = 0$

(b) $L(x) = f'(\pi)(x - \pi) + f(\pi) = (-1)(x - \pi) + 0$
 $\Rightarrow L(x) = \pi - x$ at $x = \pi$

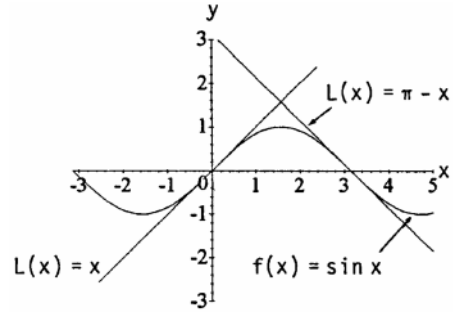

12. $f(x) = \cos x \Rightarrow f'(x) = -\sin x$

(a) $L(x) = f'(0)(x - 0) + f(0) = 0(x - 0) + 1$
 $\Rightarrow L(x) = 1$ at $x = 0$

(b) $L(x) = f'(-\frac{\pi}{2})(x + \frac{\pi}{2}) + f(-\frac{\pi}{2})$
 $= -(-1)(x + \frac{\pi}{2}) + 0 \Rightarrow L(x) = x + \frac{\pi}{2}$
 at $x = -\frac{\pi}{2}$

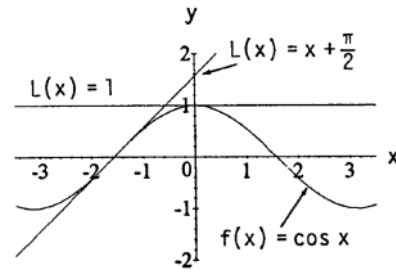

13. $f(x) = \sec x \Rightarrow f'(x) = \sec x \tan x$

(a) $L(x) = f'(0)(x - 0) + f(0) = 0(x - 0) + 1$
 $\Rightarrow L(x) = 1$ at $x = 0$

(b) $L(x) = f'(-\frac{\pi}{3})(x + \frac{\pi}{3}) + f(-\frac{\pi}{3})$
 $= -2\sqrt{3}(x + \frac{\pi}{3}) + 2 \Rightarrow L(x) = 2 - 2\sqrt{3}(x + \frac{\pi}{3})$
 at $x = -\frac{\pi}{3}$

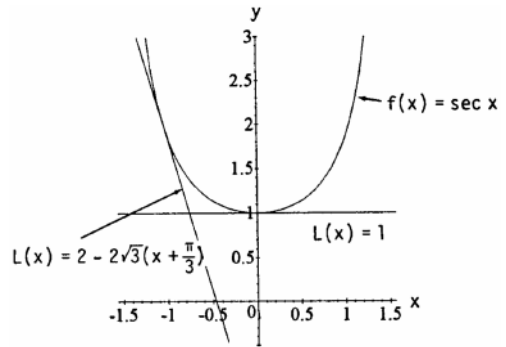

14. $f(x) = \tan x \Rightarrow f'(x) = \sec^2 x$

(a) $L(x) = f'(0)(x - 0) + f(0) = 1(x - 0) + 0 = x$
 $\Rightarrow L(x) = x$ at $x = 0$

(b) $L(x) = f'(\frac{\pi}{4})(x - \frac{\pi}{4}) + f(\frac{\pi}{4}) = 2(x - \frac{\pi}{4}) + 1$
 $\Rightarrow L(x) = 1 + 2(x - \frac{\pi}{4})$ at $x = \frac{\pi}{4}$

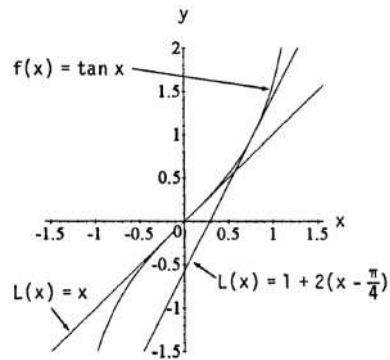

15. $f'(x) = k(1+x)^{k-1}$. We have $f(0) = 1$ and $f'(0) = k$. $L(x) = f(0) + f'(0)(x - 0) = 1 + k(x - 0) = 1 + kx$

16. (a) $f(x) = (1-x)^6 = [1 + (-x)]^6 \approx 1 + 6(-x) = 1 - 6x$

(b) $f(x) = \frac{2}{1-x} = 2[1 + (-x)]^{-1} \approx 2[1 + (-1)(-x)] = 2 + 2x$

(c) $f(x) = (1+x)^{-1/2} \approx 1 + (-\frac{1}{2})x = 1 - \frac{x}{2}$

(d) $f(x) = \sqrt{1+x^2} = \sqrt{2}\left(1 + \frac{x^2}{2}\right)^{1/2} \approx \sqrt{2}\left(1 + \frac{1}{2}\frac{x^2}{2}\right) = \sqrt{2}\left(1 + \frac{x^2}{4}\right)$

(e) $f(x) = (4+3x)^{1/3} = 4^{1/3}\left(1 + \frac{3x}{4}\right)^{1/3} \approx 4^{1/3}\left(1 + \frac{1}{3}\frac{3x}{4}\right) = 4^{1/3}\left(1 + \frac{x}{4}\right)$

$$(f) f(x) = \left(1 - \frac{1}{2+x}\right)^{2/3} = \left[1 + \left(-\frac{1}{2+x}\right)\right]^{2/3} \approx 1 + \frac{2}{3}\left(-\frac{1}{2+x}\right) = 1 - \frac{2}{6+3x}$$

$$17. (a) (1.0002)^{50} = (1 + 0.0002)^{50} \approx 1 + 50(0.0002) = 1 + .01 = 1.01$$

$$(b) \sqrt[3]{1.009} = (1 + 0.009)^{1/3} \approx 1 + \left(\frac{1}{3}\right)(0.009) = 1 + 0.003 = 1.003$$

$$18. f(x) = \sqrt{x+1} + \sin x = (x+1)^{1/2} + \sin x \Rightarrow f'(x) = \left(\frac{1}{2}\right)(x+1)^{-1/2} + \cos x \Rightarrow L_f(x) = f'(0)(x-0) + f(0) \\ = \frac{3}{2}(x-0) + 1 \Rightarrow L_f(x) = \frac{3}{2}x + 1, \text{ the linearization of } f(x); g(x) = \sqrt{x+1} = (x+1)^{1/2} \Rightarrow g'(x) \\ = \left(\frac{1}{2}\right)(x+1)^{-1/2} \Rightarrow L_g(x) = g'(0)(x-0) + g(0) = \frac{1}{2}(x-0) + 1 \Rightarrow L_g(x) = \frac{1}{2}x + 1, \text{ the linearization of } g(x); \\ h(x) = \sin x \Rightarrow h'(x) = \cos x \Rightarrow L_h(x) = h'(0)(x-0) + h(0) = (1)(x-0) + 0 \Rightarrow L_h(x) = x, \text{ the linearization of } \\ h(x). L_f(x) = L_g(x) + L_h(x) \text{ implies that the linearization of a sum is equal to the sum of the linearizations.}$$

$$19. y = x^3 - 3\sqrt{x} = x^3 - 3x^{1/2} \Rightarrow dy = (3x^2 - \frac{3}{2}x^{-1/2}) dx \Rightarrow dy = \left(3x^2 - \frac{3}{2\sqrt{x}}\right) dx$$

$$20. y = x\sqrt{1-x^2} = x(1-x^2)^{1/2} \Rightarrow dy = \left[(1)(1-x^2)^{1/2} + (x)\left(\frac{1}{2}\right)(1-x^2)^{-1/2}(-2x)\right] dx \\ = (1-x^2)^{-1/2} [(1-x^2) - x^2] dx = \frac{(1-2x^2)}{\sqrt{1-x^2}} dx$$

$$21. y = \frac{2x}{1+x^2} \Rightarrow dy = \left(\frac{(2)(1+x^2) - (2x)(2x)}{(1+x^2)^2}\right) dx = \frac{2-2x^2}{(1+x^2)^2} dx$$

$$22. y = \frac{2\sqrt{x}}{3(1+\sqrt{x})} = \frac{2x^{1/2}}{3(1+x^{1/2})} \Rightarrow dy = \left(\frac{x^{-1/2}(3(1+x^{1/2})) - 2x^{1/2}\left(\frac{3}{2}x^{-1/2}\right)}{9(1+x^{1/2})^2}\right) dx = \frac{3x^{-1/2} + 3 - 3}{9(1+x^{1/2})^2} dx \\ \Rightarrow dy = \frac{1}{3\sqrt{x}(1+\sqrt{x})^2} dx$$

$$23. 2y^{3/2} + xy - x = 0 \Rightarrow 3y^{1/2} dy + y dx + x dy - dx = 0 \Rightarrow (3y^{1/2} + x) dy = (1-y) dx \Rightarrow dy = \frac{1-y}{3\sqrt{y}+x} dx$$

$$24. xy^2 - 4x^{3/2} - y = 0 \Rightarrow y^2 dx + 2xy dy - 6x^{1/2} dx - dy = 0 \Rightarrow (2xy - 1) dy = (6x^{1/2} - y^2) dx \\ \Rightarrow dy = \frac{6\sqrt{x} - y^2}{2xy - 1} dx$$

$$25. y = \sin(5\sqrt{x}) = \sin(5x^{1/2}) \Rightarrow dy = (\cos(5x^{1/2}))\left(\frac{5}{2}x^{-1/2}\right) dx \Rightarrow dy = \frac{5\cos(5\sqrt{x})}{2\sqrt{x}} dx$$

$$26. y = \cos(x^2) \Rightarrow dy = [-\sin(x^2)](2x) dx = -2x \sin(x^2) dx$$

$$27. y = 4 \tan\left(\frac{x^3}{3}\right) \Rightarrow dy = 4 \left(\sec^2\left(\frac{x^3}{3}\right)\right)(x^2) dx \Rightarrow dy = 4x^2 \sec^2\left(\frac{x^3}{3}\right) dx$$

$$28. y = \sec(x^2 - 1) \Rightarrow dy = [\sec(x^2 - 1) \tan(x^2 - 1)](2x) dx = 2x [\sec(x^2 - 1) \tan(x^2 - 1)] dx$$

$$29. y = 3 \csc(1 - 2\sqrt{x}) = 3 \csc(1 - 2x^{1/2}) \Rightarrow dy = 3(-\csc(1 - 2x^{1/2})) \cot(1 - 2x^{1/2})(-x^{-1/2}) dx \\ \Rightarrow dy = \frac{3}{\sqrt{x}} \csc(1 - 2\sqrt{x}) \cot(1 - 2\sqrt{x}) dx$$

$$30. y = 2 \cot\left(\frac{1}{\sqrt{x}}\right) = 2 \cot(x^{-1/2}) \Rightarrow dy = -2 \csc^2(x^{-1/2})\left(-\frac{1}{2}\right)(x^{-3/2}) dx \Rightarrow dy = \frac{1}{\sqrt{x^3}} \csc^2\left(\frac{1}{\sqrt{x}}\right) dx$$

$$31. f(x) = x^2 + 2x, x_0 = 1, dx = 0.1 \Rightarrow f'(x) = 2x + 2$$

$$(a) \Delta f = f(x_0 + dx) - f(x_0) = f(1.1) - f(1) = 3.41 - 3 = 0.41$$

$$(b) df = f'(x_0) dx = [2(1) + 2](0.1) = 0.4$$

$$(c) |\Delta f - df| = |0.41 - 0.4| = 0.01$$

$$32. f(x) = 2x^2 + 4x - 3, x_0 = -1, dx = 0.1 \Rightarrow f'(x) = 4x + 4$$

$$(a) \Delta f = f(x_0 + dx) - f(x_0) = f(-.9) - f(-1) = .02$$

$$(b) df = f'(x_0) dx = [4(-1) + 4](.1) = 0$$

$$(c) |\Delta f - df| = |.02 - 0| = .02$$

$$33. f(x) = x^3 - x, x_0 = 1, dx = 0.1 \Rightarrow f'(x) = 3x^2 - 1$$

$$(a) \Delta f = f(x_0 + dx) - f(x_0) = f(1.1) - f(1) = .231$$

$$(b) df = f'(x_0) dx = [3(1)^2 - 1](.1) = .2$$

$$(c) |\Delta f - df| = |.231 - .2| = .031$$

$$34. f(x) = x^4, x_0 = 1, dx = 0.1 \Rightarrow f'(x) = 4x^3$$

$$(a) \Delta f = f(x_0 + dx) - f(x_0) = f(1.1) - f(1) = .4641$$

$$(b) df = f'(x_0) dx = 4(1)^3(.1) = .4$$

$$(c) |\Delta f - df| = |.4641 - .4| = .0641$$

$$35. f(x) = x^{-1}, x_0 = 0.5, dx = 0.1 \Rightarrow f'(x) = -x^{-2}$$

$$(a) \Delta f = f(x_0 + dx) - f(x_0) = f(.6) - f(.5) = -\frac{1}{3}$$

$$(b) df = f'(x_0) dx = (-4) \left(\frac{1}{10}\right) = -\frac{2}{5}$$

$$(c) |\Delta f - df| = \left|-\frac{1}{3} + \frac{2}{5}\right| = \frac{1}{15}$$

$$36. f(x) = x^3 - 2x + 3, x_0 = 2, dx = 0.1 \Rightarrow f'(x) = 3x^2 - 2$$

$$(a) \Delta f = f(x_0 + dx) - f(x_0) = f(2.1) - f(2) = 1.061$$

$$(b) df = f'(x_0) dx = (10)(0.10) = 1$$

$$(c) |\Delta f - df| = |1.061 - 1| = .061$$

$$37. V = \frac{4}{3} \pi r^3 \Rightarrow dV = 4\pi r_0^2 dr$$

$$38. V = x^3 \Rightarrow dV = 3x_0^2 dx$$

$$39. S = 6x^2 \Rightarrow dS = 12x_0 dx$$

$$40. S = \pi r \sqrt{r^2 + h^2} = \pi r (r^2 + h^2)^{1/2}, h \text{ constant} \Rightarrow \frac{dS}{dr} = \pi (r^2 + h^2)^{1/2} + \pi r \cdot r (r^2 + h^2)^{-1/2}$$

$$\Rightarrow \frac{dS}{dr} = \frac{\pi (r^2 + h^2) + \pi r^2}{\sqrt{r^2 + h^2}} \Rightarrow dS = \frac{\pi (2r_0^2 + h^2)}{\sqrt{r_0^2 + h^2}} dr, h \text{ constant}$$

$$41. V = \pi r^2 h, \text{ height constant} \Rightarrow dV = 2\pi r_0 h dr$$

$$42. S = 2\pi r h \Rightarrow dS = 2\pi r dh$$

$$43. \text{ Given } r = 2 \text{ m, } dr = .02 \text{ m}$$

$$(a) A = \pi r^2 \Rightarrow dA = 2\pi r dr = 2\pi(2)(.02) = .08\pi \text{ m}^2$$

$$(b) \left(\frac{.08\pi}{4\pi}\right)(100\%) = 2\%$$

$$44. C = 2\pi r \text{ and } dC = 2 \text{ in.} \Rightarrow dC = 2\pi dr \Rightarrow dr = \frac{1}{\pi} \Rightarrow \text{the diameter grew about } \frac{2}{\pi} \text{ in.; } A = \pi r^2 \Rightarrow dA = 2\pi r dr$$

$$= 2\pi(5) \left(\frac{1}{\pi}\right) = 10 \text{ in.}^2$$

$$45. \text{ The volume of a cylinder is } V = \pi r^2 h. \text{ When } h \text{ is held fixed, we have } \frac{dV}{dr} = 2\pi r h, \text{ and so } dV = 2\pi r h dr. \text{ For } h = 30 \text{ in.,}$$

$$r = 6 \text{ in., and } dr = 0.5 \text{ in., the volume of the material in the shell is approximately } dV = 2\pi r h dr = 2\pi(6)(30)(0.5)$$

$$= 180\pi \approx 565.5 \text{ in.}^3.$$

46. Let θ = angle of elevation and h = height of building. Then $h = 30 \tan \theta$, so $dh = 30 \sec^2 \theta d\theta$. We want $|dh| < 0.04h$, which gives: $|30 \sec^2 \theta d\theta| < 0.04|30 \tan \theta| \Rightarrow \frac{1}{\cos^2 \theta} |d\theta| < \frac{0.04 \sin \theta}{\cos \theta} \Rightarrow |d\theta| < 0.04 \sin \theta \cos \theta \Rightarrow |d\theta| < 0.04 \sin \frac{5\pi}{12} \cos \frac{5\pi}{12} = 0.01$ radian. The angle should be measured with an error of less than 0.01 radian (or approximately 0.57 degrees), which is a percentage error of approximately 0.76%.

47. $V = \pi h^3 \Rightarrow dV = 3\pi h^2 dh$; recall that $\Delta V \approx dV$. Then $|\Delta V| \leq (1\%)(V) = \frac{(1)(\pi h^3)}{100} \Rightarrow |dV| \leq \frac{(1)(\pi h^3)}{100} \Rightarrow |3\pi h^2 dh| \leq \frac{(1)(\pi h^3)}{100} \Rightarrow |dh| \leq \frac{1}{300} h = \left(\frac{1}{3}\right)\%$. Therefore the greatest tolerated error in the measurement of h is $\frac{1}{3}\%$.

48. (a) Let D_i represent the inside diameter. Then $V = \pi r^2 h = \pi \left(\frac{D_i}{2}\right)^2 h = \frac{\pi D_i^2 h}{4}$ and $h = 10 \Rightarrow V = \frac{5\pi D_i^2}{2} \Rightarrow dV = 5\pi D_i dD_i$. Recall that $\Delta V \approx dV$. We want $|\Delta V| \leq (1\%)(V) \Rightarrow |dV| \leq \left(\frac{1}{100}\right) \left(\frac{5\pi D_i^2}{2}\right) = \frac{\pi D_i^2}{40} \Rightarrow 5\pi D_i dD_i \leq \frac{\pi D_i^2}{40} \Rightarrow \frac{dD_i}{D_i} \leq \frac{1}{200}$. The inside diameter must be measured to within 0.5%.

(b) Let D_e represent the exterior diameter, h the height and S the area of the painted surface. $S = \pi D_e h \Rightarrow dS = \pi h dD_e \Rightarrow \frac{dS}{S} = \frac{dD_e}{D_e}$. Thus for small changes in exterior diameter, the approximate percentage change in the exterior diameter is equal to the approximate percentage change in the area painted, and to estimate the amount of paint required to within 5%, the tank's exterior diameter must be measured to within 5%.

49. $V = \pi r^2 h$, h is constant $\Rightarrow dV = 2\pi r h dr$; recall that $\Delta V \approx dV$. We want $|\Delta V| \leq \frac{1}{1000} V \Rightarrow |dV| \leq \frac{\pi r^2 h}{1000} \Rightarrow |2\pi r h dr| \leq \frac{\pi r^2 h}{1000} \Rightarrow |dr| \leq \frac{r}{2000} = (0.05\%)r \Rightarrow$ a .05% variation in the radius can be tolerated.

50. Volume = $(x + \Delta x)^3 = x^3 + 3x^2(\Delta x) + 3x(\Delta x)^2 + (\Delta x)^3$

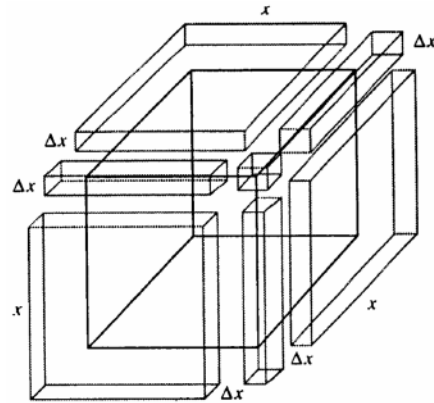

51. $W = a + \frac{b}{g} = a + bg^{-1} \Rightarrow dW = -bg^{-2} dg = -\frac{b dg}{g^2} \Rightarrow \frac{dW_{\text{moon}}}{dW_{\text{earth}}} = \frac{\left(-\frac{b dg}{(5.2)^2}\right)}{\left(-\frac{b dg}{(32)^2}\right)} = \left(\frac{32}{5.2}\right)^2 = 37.87$, so a change of gravity on the moon has about 38 times the effect that a change of the same magnitude has on Earth.

52. (a) $T = 2\pi \left(\frac{L}{g}\right)^{1/2} \Rightarrow dT = 2\pi \sqrt{L} \left(-\frac{1}{2} g^{-3/2}\right) dg = -\pi \sqrt{L} g^{-3/2} dg$

(b) If g increases, then $dg > 0 \Rightarrow dT < 0$. The period T decreases and the clock ticks more frequently. Both the pendulum speed and clock speed increase.

(c) $0.001 = -\pi \sqrt{100} (980^{-3/2}) dg \Rightarrow dg \approx -0.977 \text{ cm/sec}^2 \Rightarrow$ the new $g \approx 979 \text{ cm/sec}^2$

53. The error in measurement $dx = (1\%)(10) = 0.1 \text{ cm}$; $V = x^3 \Rightarrow dV = 3x^2 dx = 3(10)^2(0.1) = 30 \text{ cm}^3 \Rightarrow$ the percentage error in the volume calculation is $\left(\frac{30}{1000}\right)(100\%) = 3\%$

54. $A = s^2 \Rightarrow dA = 2s ds$; recall that $\Delta A \approx dA$. Then $|\Delta A| \leq (2\%)A = \frac{2s^2}{100} = \frac{s^2}{50} \Rightarrow |dA| \leq \frac{s^2}{50} \Rightarrow |2s ds| \leq \frac{s^2}{50}$
 $\Rightarrow |ds| \leq \frac{s^2}{(2s)(50)} = \frac{s}{100} = (1\%)s \Rightarrow$ the error must be no more than 1% of the true value.

55. Given $D = 100$ cm, $dD = 1$ cm, $V = \frac{4}{3}\pi\left(\frac{D}{2}\right)^3 = \frac{\pi D^3}{6} \Rightarrow dV = \frac{\pi}{2} D^2 dD = \frac{\pi}{2} (100)^2 (1) = \frac{10^4 \pi}{2}$. Then $\frac{dV}{V} (100\%)$
 $= \left[\frac{10^4 \pi}{2} \right] (10^2\%) = \left[\frac{10^6 \pi}{6} \right] \% = 3\%$

56. $V = \frac{4}{3}\pi r^3 = \frac{4}{3}\pi\left(\frac{D}{2}\right)^3 = \frac{\pi D^3}{6} \Rightarrow dV = \frac{\pi D^2}{2} dD$; recall that $\Delta V \approx dV$. Then $|\Delta V| \leq (3\%)V = \left(\frac{3}{100}\right)\left(\frac{\pi D^3}{6}\right)$
 $= \frac{\pi D^3}{200} \Rightarrow |dV| \leq \frac{\pi D^3}{200} \Rightarrow \left| \frac{\pi D^2}{2} dD \right| \leq \frac{\pi D^3}{200} \Rightarrow |dD| \leq \frac{D}{100} = (1\%)D \Rightarrow$ the allowable percentage error in measuring the diameter is 1%.

57. A 5% error in measuring $t \Rightarrow dt = (5\%)t = \frac{1}{20}t$. Then $s = 16t^2 \Rightarrow ds = 32t dt = 32t\left(\frac{1}{20}t\right) = \frac{32t^2}{20} = \frac{16t^2}{10} = \left(\frac{1}{10}\right)s$
 $= (10\%)s \Rightarrow$ a 10% error in the calculation of s .

58. From Example 8 we have $\frac{dV}{V} = 4 \frac{dr}{r}$. An increase of 12.5% in r will give a 50% increase in V .

59. $\lim_{x \rightarrow 0} \frac{\sqrt{1+x}}{1+\frac{x}{2}} = \frac{\sqrt{1+0}}{1+\frac{0}{2}} = 1$

60. $\lim_{x \rightarrow 0} \frac{\tan x}{x} = \lim_{x \rightarrow 0} \left(\frac{\sin x}{x}\right) \left(\frac{1}{\cos x}\right) = (1)(1) = 1$

61. $E(x) = f(x) - g(x) \Rightarrow E(x) = f(x) - m(x - a) - c$. Then $E(a) = 0 \Rightarrow f(a) - m(a - a) - c = 0 \Rightarrow c = f(a)$. Next we calculate m : $\lim_{x \rightarrow a} \frac{E(x)}{x-a} = 0 \Rightarrow \lim_{x \rightarrow a} \frac{f(x) - m(x-a) - c}{x-a} = 0 \Rightarrow \lim_{x \rightarrow a} \left[\frac{f(x) - f(a)}{x-a} - m \right] = 0$ (since $c = f(a)$)
 $\Rightarrow f'(a) - m = 0 \Rightarrow m = f'(a)$. Therefore, $g(x) = m(x - a) + c = f'(a)(x - a) + f(a)$ is the linear approximation, as claimed.

62. (a) i. $Q(a) = f(a)$ implies that $b_0 = f(a)$.
 ii. Since $Q'(x) = b_1 + 2b_2(x - a)$, $Q'(a) = f'(a)$ implies that $b_1 = f'(a)$.
 iii. Since $Q''(x) = 2b_2$, $Q''(a) = f''(a)$ implies that $b_2 = \frac{f''(a)}{2}$.
 In summary, $b_0 = f(a)$, $b_1 = f'(a)$, and $b_2 = \frac{f''(a)}{2}$.

(b) $f(x) = (1 - x)^{-1}$
 $f'(x) = -1(1 - x)^{-2}(-1) = (1 - x)^{-2}$
 $f''(x) = -2(1 - x)^{-3}(-1) = 2(1 - x)^{-3}$
 Since $f(0) = 1$, $f'(0) = 1$, and $f''(0) = 2$, the coefficients are $b_0 = 1$, $b_1 = 1$, $b_2 = \frac{2}{2} = 1$. The quadratic approximation is $Q(x) = 1 + x + x^2$.

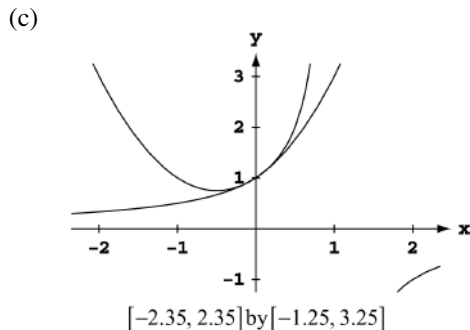

As one zooms in, the two graphs quickly become indistinguishable. They appear to be identical.

(d) $g(x) = x^{-1}$
 $g'(x) = -1x^{-2}$
 $g''(x) = 2x^{-3}$
 Since $g(1) = 1$, $g'(1) = -1$, and $g''(1) = 2$, the coefficients are $b_0 = 1$, $b_1 = -1$, $b_2 = \frac{2}{2} = 1$. The quadratic

approximation is $Q(x) = 1 - (x - 1) + (x - 1)^2$.

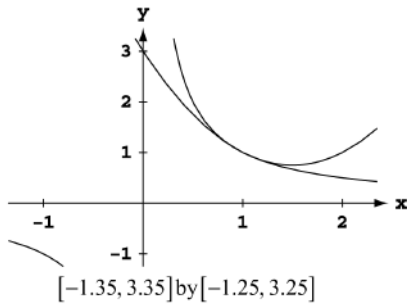

As one zooms in, the two graphs quickly become indistinguishable. They appear to be identical.

(e) $h(x) = (1 + x)^{1/2}$

$h'(x) = \frac{1}{2}(1 + x)^{-1/2}$

$h''(x) = -\frac{1}{4}(1 + x)^{-3/2}$

Since $h(0) = 1$, $h'(0) = \frac{1}{2}$, and $h''(0) = -\frac{1}{4}$, the coefficients are $b_0 = 1$, $b_1 = \frac{1}{2}$, $b_2 = \frac{-\frac{1}{4}}{2} = -\frac{1}{8}$. The quadratic approximation is $Q(x) = 1 + \frac{x}{2} - \frac{x^2}{8}$.

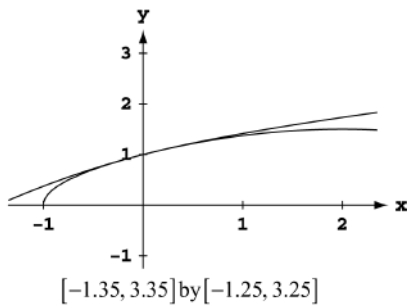

As one zooms in, the two graphs quickly become indistinguishable. They appear to be identical.

- (f) The linearization of any differentiable function $u(x)$ at $x = a$ is $L(x) = u(a) + u'(a)(x - a) = b_0 + b_1(x - a)$, where b_0 and b_1 are the coefficients of the constant and linear terms of the quadratic approximation. Thus, the linearization for $f(x)$ at $x = 0$ is $1 + x$; the linearization for $g(x)$ at $x = 1$ is $1 - (x - 1)$ or $2 - x$; and the linearization for $h(x)$ at $x = 0$ is $1 + \frac{x}{2}$.

63. (a) $x = 1$

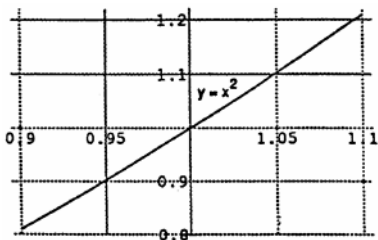

(b) $x = 1$; $m = 2.5$, $e^1 \approx 2.7$

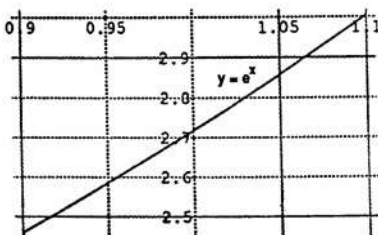

$x = 0$; $m = 1$, $e^0 = 1$

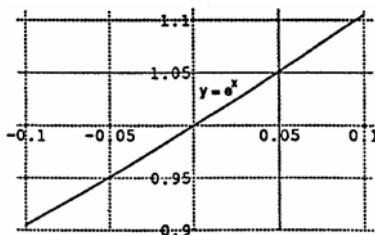

$x = -1$; $m = 0.3$, $e^{-1} \approx 0.4$

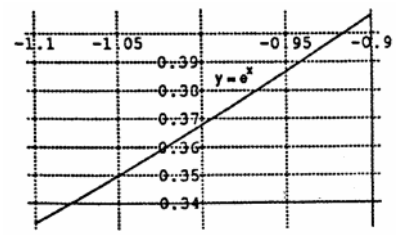

64. If f has a horizontal tangent at $x = a$, then $f'(a) = 0$ and the linearization of f at $x = a$ is

$$L(x) = f(a) + f'(a)(x - a) = f(a) + 0 \cdot (x - a) = f(a). \text{ The linearization is a constant.}$$

65. Find $|v|$ when $m = 1.01m_0$. $m = \frac{m_0}{\sqrt{1 - \frac{v^2}{c^2}}} \Rightarrow m\sqrt{1 - \frac{v^2}{c^2}} = m_0 \Rightarrow \sqrt{1 - \frac{v^2}{c^2}} = \frac{m_0}{m} \Rightarrow 1 - \frac{v^2}{c^2} = \frac{m_0^2}{m^2} \Rightarrow v^2 = c^2 \left(1 - \frac{m_0^2}{m^2}\right)$

$$\Rightarrow |v| = c\sqrt{1 - \frac{m_0^2}{m^2}} \Rightarrow dv = c \cdot \frac{1}{2} \left(1 - \frac{m_0^2}{m^2}\right)^{-1/2} \left(\frac{2m_0^2}{m^3}\right) dm, dm = 0.01m_0 \Rightarrow dv = \frac{c m_0^2}{m^3 \sqrt{1 - \frac{m_0^2}{m^2}}} \left(\frac{m_0}{100}\right) \cdot m = \frac{101}{100} m_0,$$

$$dv = \frac{c \cdot m_0^2}{\frac{101^3}{100^3} m_0^3 \sqrt{1 - \frac{m_0^2}{\frac{101^2}{100^2} m_0^2}}} \left(\frac{m_0}{100}\right) = \frac{1000}{101^3 \sqrt{1 - \frac{100^2}{101^2}}} \approx 0.69c. \text{ Body at rest } \Rightarrow v_0 = 0 \text{ and } v = v_0 + dv$$

$$\Rightarrow v = 0.69c.$$

66. (a) The successive square roots of 2 appear to converge to the number 1. For tenth roots the convergence is more rapid.

(b) Successive square roots of 0.5 also converge to 1. In fact, successive square roots of any positive number converge to 1.

A graph indicates what is going on:

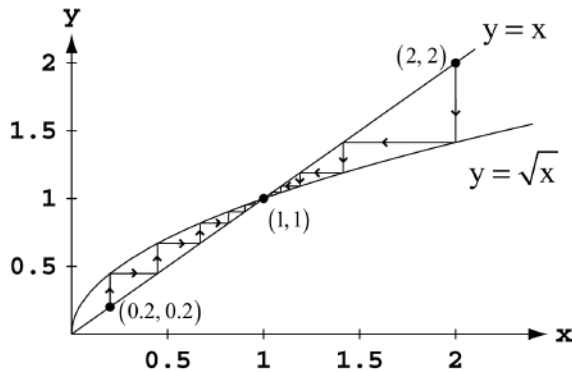

Starting on the line $y = x$, the successive square roots are found by moving to the graph of $y = \sqrt{x}$ and then across to the line $y = x$ again. From any positive starting value x , the iterates converge to 1.

67-70. Example CAS commands:

Maple:

```
with(plots):
a:= 1: f:=x -> x^3 + x^2 - 2*x;
plot(f(x), x=-1..2);
diff(f(x),x);
fp := unapply ('',x);
L:=x -> f(a) + fp(a)*(x - a);
plot({f(x), L(x)}, x=-1..2);
err:=x -> abs(f(x) - L(x));
plot(err(x), x=-1..2, title = #absolute error function#);
err(-1);
```

Mathematica: (function, x1, x2, and a may vary):

```
Clear[f, x]
{x1, x2} = {-1, 2}; a = 1;
f[x_]:=x^3 + x^2 - 2x
Plot[f[x], {x, x1, x2}]
lin[x_]:=f[a] + f'[a](x - a)
Plot[{f[x], lin[x]}, {x, x1, x2}]
err[x_]:=Abs[f[x] - lin[x]]
```

Plot[err[x], {x, x1, x2}]

err/N

After reviewing the error function, plot the error function and epsilon for differing values of epsilon (eps) and delta (del)

eps = 0.5; del = 0.4

Plot[{err[x], eps}, {x, a - del, a + del}]

CHAPTER 3 PRACTICE EXERCISES

- $y = x^5 - 0.125x^2 + 0.25x \Rightarrow \frac{dy}{dx} = 5x^4 - 0.25x + 0.25$
- $y = 3 - 0.7x^3 + 0.3x^7 \Rightarrow \frac{dy}{dx} = -2.1x^2 + 2.1x^6$
- $y = x^3 - 3(x^2 + \pi^2) \Rightarrow \frac{dy}{dx} = 3x^2 - 3(2x + 0) = 3x^2 - 6x = 3x(x - 2)$
- $y = x^7 + \sqrt{7}x - \frac{1}{\pi+1} \Rightarrow \frac{dy}{dx} = 7x^6 + \sqrt{7}$
- $y = (x + 1)^2(x^2 + 2x) \Rightarrow \frac{dy}{dx} = (x + 1)^2(2x + 2) + (x^2 + 2x)(2(x + 1)) = 2(x + 1)[(x + 1)^2 + x(x + 2)]$
 $= 2(x + 1)(2x^2 + 4x + 1)$
- $y = (2x - 5)(4 - x)^{-1} \Rightarrow \frac{dy}{dx} = (2x - 5)(-1)(4 - x)^{-2}(-1) + (4 - x)^{-1}(2) = (4 - x)^{-2}[(2x - 5) + 2(4 - x)]$
 $= 3(4 - x)^{-2}$
- $y = (\theta^2 + \sec \theta + 1)^3 \Rightarrow \frac{dy}{d\theta} = 3(\theta^2 + \sec \theta + 1)^2(2\theta + \sec \theta \tan \theta)$
- $y = \left(-1 - \frac{\csc \theta}{2} - \frac{\theta^2}{4}\right)^2 \Rightarrow \frac{dy}{d\theta} = 2\left(-1 - \frac{\csc \theta}{2} - \frac{\theta^2}{4}\right)\left(\frac{\csc \theta \cot \theta}{2} - \frac{\theta}{2}\right) = \left(-1 - \frac{\csc \theta}{2} - \frac{\theta^2}{4}\right)(\csc \theta \cot \theta - \theta)$
- $s = \frac{\sqrt{t}}{1 + \sqrt{t}} \Rightarrow \frac{ds}{dt} = \frac{(1 + \sqrt{t}) \cdot \frac{1}{2\sqrt{t}} - \sqrt{t} \left(\frac{1}{2\sqrt{t}}\right)}{(1 + \sqrt{t})^2} = \frac{(1 + \sqrt{t}) - \sqrt{t}}{2\sqrt{t}(1 + \sqrt{t})^2} = \frac{1}{2\sqrt{t}(1 + \sqrt{t})^2}$
- $s = \frac{1}{\sqrt{t-1}} \Rightarrow \frac{ds}{dt} = \frac{(\sqrt{t-1})(0) - 1\left(\frac{1}{2\sqrt{t}}\right)}{(\sqrt{t-1})^2} = \frac{-1}{2\sqrt{t}(\sqrt{t-1})^2}$
- $y = 2 \tan^2 x - \sec^2 x \Rightarrow \frac{dy}{dx} = (4 \tan x)(\sec^2 x) - (2 \sec x)(\sec x \tan x) = 2 \sec^2 x \tan x$
- $y = \frac{1}{\sin^2 x} - \frac{2}{\sin x} = \csc^2 x - 2 \csc x \Rightarrow \frac{dy}{dx} = (2 \csc x)(-\csc x \cot x) - 2(-\csc x \cot x) = (2 \csc x \cot x)(1 - \csc x)$
- $s = \cos^4(1 - 2t) \Rightarrow \frac{ds}{dt} = 4 \cos^3(1 - 2t)(-\sin(1 - 2t))(-2) = 8 \cos^3(1 - 2t) \sin(1 - 2t)$
- $s = \cot^3\left(\frac{2}{t}\right) \Rightarrow \frac{ds}{dt} = 3 \cot^2\left(\frac{2}{t}\right)(-\csc^2\left(\frac{2}{t}\right))\left(-\frac{2}{t^2}\right) = \frac{6}{t^2} \cot^2\left(\frac{2}{t}\right) \csc^2\left(\frac{2}{t}\right)$
- $s = (\sec t + \tan t)^5 \Rightarrow \frac{ds}{dt} = 5(\sec t + \tan t)^4(\sec t \tan t + \sec^2 t) = 5(\sec t)(\sec t + \tan t)^5$
- $s = \csc^5(1 - t + 3t^2) \Rightarrow \frac{ds}{dt} = 5 \csc^4(1 - t + 3t^2)(-\csc(1 - t + 3t^2) \cot(1 - t + 3t^2))(-1 + 6t)$
 $= -5(6t - 1) \csc^5(1 - t + 3t^2) \cot(1 - t + 3t^2)$
- $r = \sqrt{2\theta \sin \theta} = (2\theta \sin \theta)^{1/2} \Rightarrow \frac{dr}{d\theta} = \frac{1}{2}(2\theta \sin \theta)^{-1/2}(2\theta \cos \theta + 2 \sin \theta) = \frac{\theta \cos \theta + \sin \theta}{\sqrt{2\theta \sin \theta}}$

$$18. r = 2\theta\sqrt{\cos\theta} = 2\theta(\cos\theta)^{1/2} \Rightarrow \frac{dr}{d\theta} = 2\theta\left(\frac{1}{2}\right)(\cos\theta)^{-1/2}(-\sin\theta) + 2(\cos\theta)^{1/2} = \frac{-\theta\sin\theta}{\sqrt{\cos\theta}} + 2\sqrt{\cos\theta}$$

$$= \frac{2\cos\theta - \theta\sin\theta}{\sqrt{\cos\theta}}$$

$$19. r = \sin\sqrt{2\theta} = \sin(2\theta)^{1/2} \Rightarrow \frac{dr}{d\theta} = \cos(2\theta)^{1/2} \left(\frac{1}{2}(2\theta)^{-1/2}(2)\right) = \frac{\cos\sqrt{2\theta}}{\sqrt{2\theta}}$$

$$20. r = \sin\left(\theta + \sqrt{\theta+1}\right) \Rightarrow \frac{dr}{d\theta} = \cos\left(\theta + \sqrt{\theta+1}\right) \left(1 + \frac{1}{2\sqrt{\theta+1}}\right) = \frac{2\sqrt{\theta+1}+1}{2\sqrt{\theta+1}} \cos\left(\theta + \sqrt{\theta+1}\right)$$

$$21. y = \frac{1}{2}x^2 \csc \frac{2}{x} \Rightarrow \frac{dy}{dx} = \frac{1}{2}x^2(-\csc \frac{2}{x} \cot \frac{2}{x}) \left(\frac{-2}{x^2}\right) + \left(\csc \frac{2}{x}\right) \left(\frac{1}{2} \cdot 2x\right) = \csc \frac{2}{x} \cot \frac{2}{x} + x \csc \frac{2}{x}$$

$$22. y = 2\sqrt{x} \sin \sqrt{x} \Rightarrow \frac{dy}{dx} = 2\sqrt{x}(\cos \sqrt{x}) \left(\frac{1}{2\sqrt{x}}\right) + (\sin \sqrt{x}) \left(\frac{2}{2\sqrt{x}}\right) = \cos \sqrt{x} + \frac{\sin \sqrt{x}}{\sqrt{x}}$$

$$23. y = x^{-1/2} \sec(2x)^2 \Rightarrow \frac{dy}{dx} = x^{-1/2} \sec(2x)^2 \tan(2x)^2(2(2x) \cdot 2) + \sec(2x)^2 \left(-\frac{1}{2}x^{-3/2}\right)$$

$$= 8x^{1/2} \sec(2x)^2 \tan(2x)^2 - \frac{1}{2}x^{-3/2} \sec(2x)^2 = \frac{1}{2}x^{1/2} \sec(2x)^2 [16 \tan(2x)^2 - x^{-2}] \text{ or } \frac{1}{2x^{3/2}} \sec(2x)^2 [16x^2 \tan(2x)^2 - 1]$$

$$24. y = \sqrt{x} \csc(x+1)^3 = x^{1/2} \csc(x+1)^3$$

$$\Rightarrow \frac{dy}{dx} = x^{1/2}(-\csc(x+1)^3 \cot(x+1)^3)(3(x+1)^2) + \csc(x+1)^3 \left(\frac{1}{2}x^{-1/2}\right)$$

$$= -3\sqrt{x}(x+1)^2 \csc(x+1)^3 \cot(x+1)^3 + \frac{\csc(x+1)^3}{2\sqrt{x}} = \frac{1}{2}\sqrt{x} \csc(x+1)^3 \left[\frac{1}{x} - 6(x+1)^2 \cot(x+1)^3\right]$$

$$\text{or } \frac{1}{2\sqrt{x}} \csc(x+1)^3 [1 - 6x(x+1)^2 \cot(x+1)^3]$$

$$25. y = 5 \cot x^2 \Rightarrow \frac{dy}{dx} = 5(-\csc^2 x^2)(2x) = -10x \csc^2(x^2)$$

$$26. y = x^2 \cot 5x \Rightarrow \frac{dy}{dx} = x^2(-\csc^2 5x)(5) + (\cot 5x)(2x) = -5x^2 \csc^2 5x + 2x \cot 5x$$

$$27. y = x^2 \sin^2(2x^2) \Rightarrow \frac{dy}{dx} = x^2(2 \sin(2x^2))(\cos(2x^2))(4x) + \sin^2(2x^2)(2x) = 8x^3 \sin(2x^2) \cos(2x^2) + 2x \sin^2(2x^2)$$

$$28. y = x^{-2} \sin^2(x^3) \Rightarrow \frac{dy}{dx} = x^{-2}(2 \sin(x^3))(\cos(x^3))(3x^2) + \sin^2(x^3)(-2x^{-3}) = 6 \sin(x^3) \cos(x^3) - 2x^{-3} \sin^2(x^3)$$

$$29. s = \left(\frac{4t}{t+1}\right)^{-2} \Rightarrow \frac{ds}{dt} = -2\left(\frac{4t}{t+1}\right)^{-3} \left(\frac{(t+1)(4) - (4t)(1)}{(t+1)^2}\right) = -2\left(\frac{4t}{t+1}\right)^{-3} \frac{4}{(t+1)^2} = -\frac{(t+1)}{8t^3}$$

$$30. s = \frac{-1}{15(15t-1)^3} = -\frac{1}{15}(15t-1)^{-3} \Rightarrow \frac{ds}{dt} = -\frac{1}{15}(-3)(15t-1)^{-4}(15) = \frac{3}{(15t-1)^4}$$

$$31. y = \left(\frac{\sqrt{x}}{x+1}\right)^2 \Rightarrow \frac{dy}{dx} = 2\left(\frac{\sqrt{x}}{x+1}\right) \cdot \frac{(x+1)\left(\frac{1}{2\sqrt{x}}\right) - (\sqrt{x})(1)}{(x+1)^2} = \frac{(x+1)-2x}{(x+1)^3} = \frac{1-x}{(x+1)^3}$$

$$32. y = \left(\frac{2\sqrt{x}}{2\sqrt{x}+1}\right)^2 \Rightarrow \frac{dy}{dx} = 2\left(\frac{2\sqrt{x}}{2\sqrt{x}+1}\right) \left(\frac{(2\sqrt{x}+1)\left(\frac{1}{\sqrt{x}}\right) - (2\sqrt{x})\left(\frac{1}{\sqrt{x}}\right)}{(2\sqrt{x}+1)^2}\right) = \frac{4\sqrt{x}\left(\frac{1}{\sqrt{x}}\right)}{(2\sqrt{x}+1)^3} = \frac{4}{(2\sqrt{x}+1)^3}$$

$$33. y = \sqrt{\frac{x^2+x}{x^2}} = \left(1 + \frac{1}{x}\right)^{1/2} \Rightarrow \frac{dy}{dx} = \frac{1}{2}\left(1 + \frac{1}{x}\right)^{-1/2} \left(-\frac{1}{x^2}\right) = -\frac{1}{2x^2\sqrt{1+\frac{1}{x}}}$$

$$34. y = 4x\sqrt{x+\sqrt{x}} = 4x(x+x^{1/2})^{1/2} \Rightarrow \frac{dy}{dx} = 4x\left(\frac{1}{2}\right)(x+x^{1/2})^{-1/2}\left(1 + \frac{1}{2}x^{-1/2}\right) + (x+x^{1/2})^{1/2}(4)$$

$$= (x+\sqrt{x})^{-1/2} \left[2x\left(1 + \frac{1}{2\sqrt{x}}\right) + 4(x+\sqrt{x})\right] = (x+\sqrt{x})^{-1/2} (2x + \sqrt{x} + 4x + 4\sqrt{x}) = \frac{6x+5\sqrt{x}}{\sqrt{x+\sqrt{x}}}$$

182 Chapter 3 Differentiation

$$35. r = \left(\frac{\sin \theta}{\cos \theta - 1}\right)^2 \Rightarrow \frac{dr}{d\theta} = 2 \left(\frac{\sin \theta}{\cos \theta - 1}\right) \left[\frac{(\cos \theta - 1)(\cos \theta) - (\sin \theta)(-\sin \theta)}{(\cos \theta - 1)^2}\right]$$

$$= 2 \left(\frac{\sin \theta}{\cos \theta - 1}\right) \left(\frac{\cos^2 \theta - \cos \theta + \sin^2 \theta}{(\cos \theta - 1)^2}\right) = \frac{2 \sin \theta (1 - \cos \theta)}{(\cos \theta - 1)^3} = \frac{-2 \sin \theta}{(\cos \theta - 1)^2}$$

$$36. r = \left(\frac{\sin \theta + 1}{1 - \cos \theta}\right)^2 \Rightarrow \frac{dr}{d\theta} = 2 \left(\frac{\sin \theta + 1}{1 - \cos \theta}\right) \left[\frac{(1 - \cos \theta)(\cos \theta) - (\sin \theta + 1)(\sin \theta)}{(1 - \cos \theta)^2}\right]$$

$$= \frac{2(\sin \theta + 1)}{(1 - \cos \theta)^3} (\cos \theta - \cos^2 \theta - \sin^2 \theta - \sin \theta) = \frac{2(\sin \theta + 1)(\cos \theta - \sin \theta - 1)}{(1 - \cos \theta)^3}$$

$$37. y = (2x + 1)\sqrt{2x + 1} = (2x + 1)^{3/2} \Rightarrow \frac{dy}{dx} = \frac{3}{2}(2x + 1)^{1/2}(2) = 3\sqrt{2x + 1}$$

$$38. y = 20(3x - 4)^{1/4}(3x - 4)^{-1/5} = 20(3x - 4)^{1/20} \Rightarrow \frac{dy}{dx} = 20\left(\frac{1}{20}\right)(3x - 4)^{-19/20}(3) = \frac{3}{(3x - 4)^{19/20}}$$

$$39. y = 3(5x^2 + \sin 2x)^{-3/2} \Rightarrow \frac{dy}{dx} = 3\left(-\frac{3}{2}\right)(5x^2 + \sin 2x)^{-5/2}[10x + (\cos 2x)(2)] = \frac{-9(5x + \cos 2x)}{(5x^2 + \sin 2x)^{5/2}}$$

$$40. y = (3 + \cos^3 3x)^{-1/3} \Rightarrow \frac{dy}{dx} = -\frac{1}{3}(3 + \cos^3 3x)^{-4/3}(3 \cos^2 3x)(-\sin 3x)(3) = \frac{3 \cos^2 3x \sin 3x}{(3 + \cos^3 3x)^{4/3}}$$

$$41. xy + 2x + 3y = 1 \Rightarrow (xy' + y) + 2 + 3y' = 0 \Rightarrow xy' + 3y' = -2 - y \Rightarrow y'(x + 3) = -2 - y \Rightarrow y' = -\frac{y+2}{x+3}$$

$$42. x^2 + xy + y^2 - 5x = 2 \Rightarrow 2x + \left(x \frac{dy}{dx} + y\right) + 2y \frac{dy}{dx} - 5 = 0 \Rightarrow x \frac{dy}{dx} + 2y \frac{dy}{dx} = 5 - 2x - y \Rightarrow \frac{dy}{dx}(x + 2y)$$

$$= 5 - 2x - y \Rightarrow \frac{dy}{dx} = \frac{5 - 2x - y}{x + 2y}$$

$$43. x^3 + 4xy - 3y^{4/3} = 2x \Rightarrow 3x^2 + \left(4x \frac{dy}{dx} + 4y\right) - 4y^{1/3} \frac{dy}{dx} = 2 \Rightarrow 4x \frac{dy}{dx} - 4y^{1/3} \frac{dy}{dx} = 2 - 3x^2 - 4y$$

$$\Rightarrow \frac{dy}{dx}(4x - 4y^{1/3}) = 2 - 3x^2 - 4y \Rightarrow \frac{dy}{dx} = \frac{2 - 3x^2 - 4y}{4x - 4y^{1/3}}$$

$$44. 5x^{4/5} + 10y^{6/5} = 15 \Rightarrow 4x^{-1/5} + 12y^{1/5} \frac{dy}{dx} = 0 \Rightarrow 12y^{1/5} \frac{dy}{dx} = -4x^{-1/5} \Rightarrow \frac{dy}{dx} = -\frac{1}{3}x^{-1/5}y^{-1/5} = -\frac{1}{3(xy)^{1/5}}$$

$$45. (xy)^{1/2} = 1 \Rightarrow \frac{1}{2}(xy)^{-1/2}\left(x \frac{dy}{dx} + y\right) = 0 \Rightarrow x^{1/2}y^{-1/2} \frac{dy}{dx} = -x^{-1/2}y^{1/2} \Rightarrow \frac{dy}{dx} = -x^{-1}y \Rightarrow \frac{dy}{dx} = -\frac{y}{x}$$

$$46. x^2y^2 = 1 \Rightarrow x^2\left(2y \frac{dy}{dx}\right) + y^2(2x) = 0 \Rightarrow 2x^2y \frac{dy}{dx} = -2xy^2 \Rightarrow \frac{dy}{dx} = -\frac{y}{x}$$

$$47. y^2 = \frac{x}{x+1} \Rightarrow 2y \frac{dy}{dx} = \frac{(x+1)(1) - (x)(1)}{(x+1)^2} \Rightarrow \frac{dy}{dx} = \frac{1}{2y(x+1)^2}$$

$$48. y^2 = \left(\frac{1+x}{1-x}\right)^{1/2} \Rightarrow y^4 = \frac{1+x}{1-x} \Rightarrow 4y^3 \frac{dy}{dx} = \frac{(1-x)(1) - (1+x)(-1)}{(1-x)^2} \Rightarrow \frac{dy}{dx} = \frac{1}{2y^3(1-x)^2}$$

$$49. p^3 + 4pq - 3q^2 = 2 \Rightarrow 3p^2 \frac{dp}{dq} + 4\left(p + q \frac{dp}{dq}\right) - 6q = 0 \Rightarrow 3p^2 \frac{dp}{dq} + 4q \frac{dp}{dq} = 6q - 4p \Rightarrow \frac{dp}{dq}(3p^2 + 4q) = 6q - 4p$$

$$\Rightarrow \frac{dp}{dq} = \frac{6q - 4p}{3p^2 + 4q}$$

$$50. q = (5p^2 + 2p)^{-3/2} \Rightarrow 1 = -\frac{3}{2}(5p^2 + 2p)^{-5/2}\left(10p \frac{dp}{dq} + 2 \frac{dp}{dq}\right) \Rightarrow -\frac{2}{3}(5p^2 + 2p)^{5/2} = \frac{dp}{dq}(10p + 2)$$

$$\Rightarrow \frac{dp}{dq} = -\frac{(5p^2 + 2p)^{5/2}}{3(5p + 1)}$$

$$51. r \cos 2s + \sin^2 s = \pi \Rightarrow r(-\sin 2s)(2) + (\cos 2s) \left(\frac{dr}{ds}\right) + 2 \sin s \cos s = 0 \Rightarrow \frac{dr}{ds} (\cos 2s) = 2r \sin 2s - 2 \sin s \cos s \\ \Rightarrow \frac{dr}{ds} = \frac{2r \sin 2s - \sin 2s}{\cos 2s} = \frac{(2r-1)\sin 2s}{\cos 2s} = (2r-1)\tan 2s$$

$$52. 2rs - r - s + s^2 = -3 \Rightarrow 2\left(r + s \frac{dr}{ds}\right) - \frac{dr}{ds} - 1 + 2s = 0 \Rightarrow \frac{dr}{ds} (2s - 1) = 1 - 2s - 2r \Rightarrow \frac{dr}{ds} = \frac{1-2s-2r}{2s-1}$$

$$53. (a) x^3 + y^3 = 1 \Rightarrow 3x^2 + 3y^2 \frac{dy}{dx} = 0 \Rightarrow \frac{dy}{dx} = -\frac{x^2}{y^2} \Rightarrow \frac{d^2y}{dx^2} = \frac{y^2(-2x) - (-x^2)\left(2y \frac{dy}{dx}\right)}{y^4} \\ \Rightarrow \frac{d^2y}{dx^2} = \frac{-2xy^2 + (2yx^2)\left(-\frac{x^2}{y^2}\right)}{y^4} = \frac{-2xy^2 - 2x^4}{y^4} = \frac{-2xy^3 - 2x^4}{y^5}$$

$$(b) y^2 = 1 - \frac{2}{x} \Rightarrow 2y \frac{dy}{dx} = \frac{2}{x^2} \Rightarrow \frac{dy}{dx} = \frac{1}{yx^2} \Rightarrow \frac{dy}{dx} = (yx^2)^{-1} \Rightarrow \frac{d^2y}{dx^2} = -(yx^2)^{-2} \left[y(2x) + x^2 \frac{dy}{dx}\right] \\ \Rightarrow \frac{d^2y}{dx^2} = \frac{-2xy - x^2\left(\frac{1}{yx^2}\right)}{y^2x^4} = \frac{-2xy^2 - 1}{y^3x^4}$$

$$54. (a) x^2 - y^2 = 1 \Rightarrow 2x - 2y \frac{dy}{dx} = 0 \Rightarrow -2y \frac{dy}{dx} = -2x \Rightarrow \frac{dy}{dx} = \frac{x}{y}$$

$$(b) \frac{dy}{dx} = \frac{x}{y} \Rightarrow \frac{d^2y}{dx^2} = \frac{y(1-x) \frac{dy}{dx}}{y^2} = \frac{y-x\left(\frac{x}{y}\right)}{y^2} = \frac{y^2 - x^2}{y^3} = \frac{-1}{y^3} \text{ (since } y^2 - x^2 = -1)$$

$$55. (a) \text{ Let } h(x) = 6f(x) - g(x) \Rightarrow h'(x) = 6f'(x) - g'(x) \Rightarrow h'(1) = 6f'(1) - g'(1) = 6\left(\frac{1}{2}\right) - (-4) = 7$$

$$(b) \text{ Let } h(x) = f(x)g^2(x) \Rightarrow h'(x) = f(x)(2g(x))g'(x) + g^2(x)f'(x) \Rightarrow h'(0) = 2f(0)g(0)g'(0) + g^2(0)f'(0) \\ = 2(1)(1)\left(\frac{1}{2}\right) + (1)^2(-3) = -2$$

$$(c) \text{ Let } h(x) = \frac{f(x)}{g(x)+1} \Rightarrow h'(x) = \frac{(g(x)+1)f'(x) - f(x)g'(x)}{(g(x)+1)^2} \Rightarrow h'(1) = \frac{(g(1)+1)f'(1) - f(1)g'(1)}{(g(1)+1)^2} \\ = \frac{(5+1)\left(\frac{1}{2}\right) - 3(-4)}{(5+1)^2} = \frac{5}{12}$$

$$(d) \text{ Let } h(x) = f(g(x)) \Rightarrow h'(x) = f'(g(x))g'(x) \Rightarrow h'(0) = f'(g(0))g'(0) = f'(1)\left(\frac{1}{2}\right) = \left(\frac{1}{2}\right)\left(\frac{1}{2}\right) = \frac{1}{4}$$

$$(e) \text{ Let } h(x) = g(f(x)) \Rightarrow h'(x) = g'(f(x))f'(x) \Rightarrow h'(0) = g'(f(0))f'(0) = g'(1)f'(0) = (-4)(-3) = 12$$

$$(f) \text{ Let } h(x) = (x + f(x))^{3/2} \Rightarrow h'(x) = \frac{3}{2}(x + f(x))^{1/2}(1 + f'(x)) \Rightarrow h'(1) = \frac{3}{2}(1 + f(1))^{1/2}(1 + f'(1)) \\ = \frac{3}{2}(1 + 3)^{1/2}\left(1 + \frac{1}{2}\right) = \frac{9}{2}$$

$$(g) \text{ Let } h(x) = f(x + g(x)) \Rightarrow h'(x) = f'(x + g(x))(1 + g'(x)) \Rightarrow h'(0) = f'(g(0))(1 + g'(0)) \\ = f'(1)\left(1 + \frac{1}{2}\right) = \left(\frac{1}{2}\right)\left(\frac{3}{2}\right) = \frac{3}{4}$$

$$56. (a) \text{ Let } h(x) = \sqrt{x}f(x) \Rightarrow h'(x) = \sqrt{x}f'(x) + f(x) \cdot \frac{1}{2\sqrt{x}} \Rightarrow h'(1) = \sqrt{1}f'(1) + f(1) \cdot \frac{1}{2\sqrt{1}} = \frac{1}{2} + (-3)\left(\frac{1}{2}\right) = -\frac{13}{10}$$

$$(b) \text{ Let } h(x) = (f(x))^{1/2} \Rightarrow h'(x) = \frac{1}{2}(f(x))^{-1/2}(f'(x)) \Rightarrow h'(0) = \frac{1}{2}(f(0))^{-1/2}f'(0) = \frac{1}{2}(9)^{-1/2}(-2) = -\frac{1}{3}$$

$$(c) \text{ Let } h(x) = f(\sqrt{x}) \Rightarrow h'(x) = f'(\sqrt{x}) \cdot \frac{1}{2\sqrt{x}} \Rightarrow h'(1) = f'(\sqrt{1}) \cdot \frac{1}{2\sqrt{1}} = \frac{1}{2} \cdot \frac{1}{2} = \frac{1}{4}$$

$$(d) \text{ Let } h(x) = f(1 - 5 \tan x) \Rightarrow h'(x) = f'(1 - 5 \tan x)(-5 \sec^2 x) \Rightarrow h'(0) = f'(1 - 5 \tan 0)(-5 \sec^2 0) \\ = f'(1)(-5) = \frac{1}{2}(-5) = -\frac{5}{2}$$

$$(e) \text{ Let } h(x) = \frac{f(x)}{2 + \cos x} \Rightarrow h'(x) = \frac{(2 + \cos x)f'(x) - f(x)(-\sin x)}{(2 + \cos x)^2} \Rightarrow h'(0) = \frac{(2+1)f'(0) - f(0)(0)}{(2+1)^2} = \frac{3(-2)}{9} = -\frac{2}{3}$$

$$(f) \text{ Let } h(x) = 10 \sin\left(\frac{\pi x}{2}\right) f^2(x) \Rightarrow h'(x) = 10 \sin\left(\frac{\pi x}{2}\right)(2f(x)f'(x)) + f^2(x)\left(10 \cos\left(\frac{\pi x}{2}\right)\right)\left(\frac{\pi}{2}\right) \\ \Rightarrow h'(1) = 10 \sin\left(\frac{\pi}{2}\right)(2f(1)f'(1)) + f^2(1)\left(10 \cos\left(\frac{\pi}{2}\right)\right)\left(\frac{\pi}{2}\right) = 20(-3)\left(\frac{1}{2}\right) + 0 = -20$$

$$57. x = t^2 + \pi \Rightarrow \frac{dx}{dt} = 2t; y = 3 \sin 2x \Rightarrow \frac{dy}{dx} = 3(\cos 2x)(2) = 6 \cos 2x = 6 \cos(2t^2 + 2\pi) = 6 \cos(2t^2); \text{ thus,}$$

$$\frac{dy}{dt} = \frac{dy}{dx} \cdot \frac{dx}{dt} = 6 \cos(2t^2) \cdot 2t \Rightarrow \frac{dy}{dt} \Big|_{t=0} = 6 \cos(0) \cdot 0 = 0$$

$$58. t = (u^2 + 2u)^{1/3} \Rightarrow \frac{dt}{du} = \frac{1}{3}(u^2 + 2u)^{-2/3}(2u + 2) = \frac{2}{3}(u^2 + 2u)^{-2/3}(u + 1); s = t^2 + 5t \Rightarrow \frac{ds}{dt} = 2t + 5 \\ = 2(u^2 + 2u)^{1/3} + 5; \text{ thus } \frac{ds}{du} = \frac{ds}{dt} \cdot \frac{dt}{du} = \left[2(u^2 + 2u)^{1/3} + 5\right]\left(\frac{2}{3}\right)(u^2 + 2u)^{-2/3}(u + 1)$$

$$\Rightarrow \frac{ds}{du} \Big|_{u=2} = \left[2(2^2 + 2(2))^{1/3} + 5 \right] \left(\frac{2}{3} \right) (2^2 + 2(2))^{-2/3} (2+1) = 2(2 \cdot 8^{1/3} + 5) (8^{-2/3}) = 2(2 \cdot 2 + 5) \left(\frac{1}{4} \right) = \frac{9}{2}$$

$$\begin{aligned} 59. \quad r &= 8 \sin \left(s + \frac{\pi}{6} \right) \Rightarrow \frac{dr}{ds} = 8 \cos \left(s + \frac{\pi}{6} \right); \quad w = \sin(\sqrt{r} - 2) \Rightarrow \frac{dw}{dr} = \cos(\sqrt{r} - 2) \left(\frac{1}{2\sqrt{r}} \right) \\ &= \frac{\cos \sqrt{8 \sin \left(s + \frac{\pi}{6} \right)} - 2}{2\sqrt{8 \sin \left(s + \frac{\pi}{6} \right)}}; \quad \text{thus, } \frac{dw}{ds} = \frac{dw}{dr} \cdot \frac{dr}{ds} = \frac{\cos \left(\sqrt{8 \sin \left(s + \frac{\pi}{6} \right)} - 2 \right)}{2\sqrt{8 \sin \left(s + \frac{\pi}{6} \right)}} \cdot \left[8 \cos \left(s + \frac{\pi}{6} \right) \right] \\ &\Rightarrow \frac{dw}{ds} \Big|_{s=0} = \frac{\cos \left(\sqrt{8 \sin \left(\frac{\pi}{6} \right)} - 2 \right) \cdot 8 \cos \left(\frac{\pi}{6} \right)}{2\sqrt{8 \sin \left(\frac{\pi}{6} \right)}} = \frac{(\cos 0)(8) \left(\frac{\sqrt{3}}{2} \right)}{2\sqrt{4}} = \sqrt{3} \end{aligned}$$

$$\begin{aligned} 60. \quad \theta^2 t + \theta &= 1 \Rightarrow (\theta^2 + t(2\theta \frac{d\theta}{dt})) + \frac{d\theta}{dt} = 0 \Rightarrow \frac{d\theta}{dt} (2\theta t + 1) = -\theta^2 \Rightarrow \frac{d\theta}{dt} = \frac{-\theta^2}{2\theta t + 1}; \quad r = (\theta^2 + 7)^{1/3} \\ &\Rightarrow \frac{dr}{d\theta} = \frac{1}{3} (\theta^2 + 7)^{-2/3} (2\theta) = \frac{2}{3} \theta (\theta^2 + 7)^{-2/3}; \quad \text{now } t = 0 \text{ and } \theta^2 t + \theta = 1 \Rightarrow \theta = 1 \text{ so that } \frac{d\theta}{dt} \Big|_{t=0, \theta=1} = \frac{-1}{1} = -1 \\ \text{and } \frac{dr}{d\theta} \Big|_{\theta=1} &= \frac{2}{3} (1 + 7)^{-2/3} = \frac{1}{6} \Rightarrow \frac{dr}{dt} \Big|_{t=0} = \frac{dr}{d\theta} \Big|_{t=0} \cdot \frac{d\theta}{dt} \Big|_{t=0} = \left(\frac{1}{6} \right) (-1) = -\frac{1}{6} \end{aligned}$$

$$\begin{aligned} 61. \quad y^3 + y &= 2 \cos x \Rightarrow 3y^2 \frac{dy}{dx} + \frac{dy}{dx} = -2 \sin x \Rightarrow \frac{dy}{dx} (3y^2 + 1) = -2 \sin x \Rightarrow \frac{dy}{dx} = \frac{-2 \sin x}{3y^2 + 1} \Rightarrow \frac{dy}{dx} \Big|_{(0,1)} \\ &= \frac{-2 \sin(0)}{3+1} = 0; \quad \frac{d^2y}{dx^2} = \frac{(3y^2 + 1)(-2 \cos x) - (-2 \sin x)(6y \frac{dy}{dx})}{(3y^2 + 1)^2} \\ &\Rightarrow \frac{d^2y}{dx^2} \Big|_{(0,1)} = \frac{(3+1)(-2 \cos 0) - (-2 \sin 0)(6 \cdot 0)}{(3+1)^2} = -\frac{1}{2} \end{aligned}$$

$$\begin{aligned} 62. \quad x^{1/3} + y^{1/3} &= 4 \Rightarrow \frac{1}{3} x^{-2/3} + \frac{1}{3} y^{-2/3} \frac{dy}{dx} = 0 \Rightarrow \frac{dy}{dx} = -\frac{y^{2/3}}{x^{2/3}} \Rightarrow \frac{dy}{dx} \Big|_{(8,8)} = -1; \quad \frac{dy}{dx} = \frac{-y^{2/3}}{x^{2/3}} \\ &\Rightarrow \frac{d^2y}{dx^2} = \frac{(x^{2/3}) \left(-\frac{2}{3} y^{-1/3} \frac{dy}{dx} \right) - (-y^{2/3}) \left(\frac{2}{3} x^{-1/3} \right)}{(x^{2/3})^2} \Rightarrow \frac{d^2y}{dx^2} \Big|_{(8,8)} = \frac{(8^{2/3}) \left[-\frac{2}{3} \cdot 8^{-1/3} \cdot (-1) \right] + (8^{2/3}) \left(\frac{2}{3} \cdot 8^{-1/3} \right)}{8^{4/3}} \\ &= \frac{\frac{1}{3} + \frac{1}{3}}{8^{2/3}} = \frac{\frac{2}{3}}{4} = \frac{1}{6} \end{aligned}$$

$$\begin{aligned} 63. \quad f(t) &= \frac{1}{2t+1} \text{ and } f(t+h) = \frac{1}{2(t+h)+1} \Rightarrow \frac{f(t+h) - f(t)}{h} = \frac{\frac{1}{2(t+h)+1} - \frac{1}{2t+1}}{h} = \frac{2t+1 - (2t+2h+1)}{(2t+2h+1)(2t+1)h} \\ &= \frac{-2h}{(2t+2h+1)(2t+1)h} = \frac{-2}{(2t+2h+1)(2t+1)} \Rightarrow f'(t) = \lim_{h \rightarrow 0} \frac{f(t+h) - f(t)}{h} = \lim_{h \rightarrow 0} \frac{-2}{(2t+2h+1)(2t+1)} \\ &= \frac{-2}{(2t+1)^2} \end{aligned}$$

$$\begin{aligned} 64. \quad g(x) &= 2x^2 + 1 \text{ and } g(x+h) = 2(x+h)^2 + 1 = 2x^2 + 4xh + 2h^2 + 1 \Rightarrow \frac{g(x+h) - g(x)}{h} \\ &= \frac{(2x^2 + 4xh + 2h^2 + 1) - (2x^2 + 1)}{h} = \frac{4xh + 2h^2}{h} = 4x + 2h \Rightarrow g'(x) = \lim_{h \rightarrow 0} \frac{g(x+h) - g(x)}{h} = \lim_{h \rightarrow 0} (4x + 2h) \\ &= 4x \end{aligned}$$

65. (a)

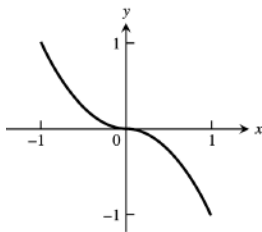

$$f(x) = \begin{cases} x^2, & -1 \leq x < 0 \\ -x^2, & 0 \leq x \leq 1 \end{cases}$$

(b) $\lim_{x \rightarrow 0^-} f(x) = \lim_{x \rightarrow 0^-} x^2 = 0$ and $\lim_{x \rightarrow 0^+} f(x) = \lim_{x \rightarrow 0^+} -x^2 = 0 \Rightarrow \lim_{x \rightarrow 0} f(x) = 0$. Since $\lim_{x \rightarrow 0} f(x) = 0 = f(0)$ it follows that f is continuous at $x = 0$.

(c) $\lim_{x \rightarrow 0^-} f'(x) = \lim_{x \rightarrow 0^-} (2x) = 0$ and $\lim_{x \rightarrow 0^+} f'(x) = \lim_{x \rightarrow 0^+} (-2x) = 0 \Rightarrow \lim_{x \rightarrow 0} f'(x) = 0$. Since this limit exists, it

follows that f is differentiable at $x = 0$.

66. (a)

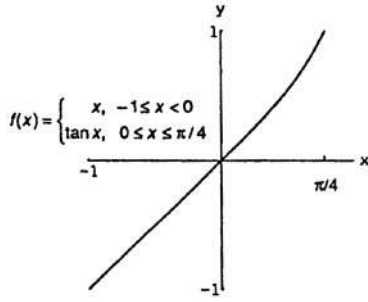

(b) $\lim_{x \rightarrow 0^-} f(x) = \lim_{x \rightarrow 0^-} x = 0$ and $\lim_{x \rightarrow 0^+} f(x) = \lim_{x \rightarrow 0^+} \tan x = 0 \Rightarrow \lim_{x \rightarrow 0} f(x) = 0$. Since $\lim_{x \rightarrow 0} f(x) = 0 = f(0)$, it follows that f is continuous at $x = 0$.

(c) $\lim_{x \rightarrow 0^-} f'(x) = \lim_{x \rightarrow 0^-} 1 = 1$ and $\lim_{x \rightarrow 0^+} f'(x) = \lim_{x \rightarrow 0^+} \sec^2 x = 1 \Rightarrow \lim_{x \rightarrow 0} f'(x) = 1$. Since this limit exists it follows that f is differentiable at $x = 0$.

67. (a)

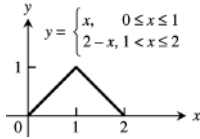

(b) $\lim_{x \rightarrow 1^-} f(x) = \lim_{x \rightarrow 1^-} x = 1$ and $\lim_{x \rightarrow 1^+} f(x) = \lim_{x \rightarrow 1^+} (2 - x) = 1 \Rightarrow \lim_{x \rightarrow 1} f(x) = 1$. Since $\lim_{x \rightarrow 1} f(x) = 1 = f(1)$, it follows that f is continuous at $x = 1$.

(c) $\lim_{x \rightarrow 1^-} f'(x) = \lim_{x \rightarrow 1^-} 1 = 1$ and $\lim_{x \rightarrow 1^+} f'(x) = \lim_{x \rightarrow 1^+} -1 = -1 \Rightarrow \lim_{x \rightarrow 1^-} f'(x) \neq \lim_{x \rightarrow 1^+} f'(x)$, so $\lim_{x \rightarrow 1} f'(x)$ does not exist $\Rightarrow f$ is not differentiable at $x = 1$.

68. (a) $\lim_{x \rightarrow 0^-} f(x) = \lim_{x \rightarrow 0^-} \sin 2x = 0$ and $\lim_{x \rightarrow 0^+} f(x) = \lim_{x \rightarrow 0^+} mx = 0 \Rightarrow \lim_{x \rightarrow 0} f(x) = 0$, independent of m ; since $f(0) = 0 = \lim_{x \rightarrow 0} f(x)$ it follows that f is continuous at $x = 0$ for all values of m .

(b) $\lim_{x \rightarrow 0^-} f'(x) = \lim_{x \rightarrow 0^-} (\sin 2x)' = \lim_{x \rightarrow 0^-} 2 \cos 2x = 2$ and $\lim_{x \rightarrow 0^+} f'(x) = \lim_{x \rightarrow 0^+} (mx)' = \lim_{x \rightarrow 0^+} m = m \Rightarrow f$ is differentiable at $x = 0$ provided that $\lim_{x \rightarrow 0^-} f'(x) = \lim_{x \rightarrow 0^+} f'(x) \Rightarrow m = 2$.

69. $y = \frac{x}{2} + \frac{1}{2x-4} = \frac{1}{2}x + (2x-4)^{-1} \Rightarrow \frac{dy}{dx} = \frac{1}{2} - 2(2x-4)^{-2}$; the slope of the tangent is $-\frac{3}{2} \Rightarrow -\frac{3}{2} = \frac{1}{2} - 2(2x-4)^{-2} \Rightarrow -2 = -2(2x-4)^{-2} \Rightarrow 1 = \frac{1}{(2x-4)^2} \Rightarrow (2x-4)^2 = 1 \Rightarrow 4x^2 - 16x + 16 = 1 \Rightarrow 4x^2 - 16x + 15 = 0 \Rightarrow (2x-5)(2x-3) = 0 \Rightarrow x = \frac{5}{2}$ or $x = \frac{3}{2} \Rightarrow (\frac{5}{2}, \frac{9}{4})$ and $(\frac{3}{2}, -\frac{1}{4})$ are points on the curve where the slope is $-\frac{3}{2}$.

70. $y = x - \frac{1}{2x} \Rightarrow \frac{dy}{dx} = 1 + \frac{2}{(2x)^2} = 1 + \frac{1}{2x^2}$; the slope of the tangent is $3 \Rightarrow 3 = 1 + \frac{1}{2x^2} \Rightarrow 2 = \frac{1}{2x^2} \Rightarrow x^2 = \frac{1}{4} \Rightarrow x = \pm \frac{1}{2} \Rightarrow (\frac{1}{2}, -\frac{1}{2})$ and $(-\frac{1}{2}, \frac{1}{2})$ are points on the curve where the slope is 3 .

71. $y = 2x^3 - 3x^2 - 12x + 20 \Rightarrow \frac{dy}{dx} = 6x^2 - 6x - 12$; the tangent is parallel to the x -axis when $\frac{dy}{dx} = 0 \Rightarrow 6x^2 - 6x - 12 = 0 \Rightarrow x^2 - x - 2 = 0 \Rightarrow (x-2)(x+1) = 0 \Rightarrow x = 2$ or $x = -1 \Rightarrow (2, 0)$ and $(-1, 27)$ are points on the curve where the tangent is parallel to the x -axis.

72. $y = x^3 \Rightarrow \frac{dy}{dx} = 3x^2 \Rightarrow \frac{dy}{dx} \Big|_{(-2, -8)} = 12$; an equation of the tangent line at $(-2, -8)$ is $y + 8 = 12(x + 2)$

$\Rightarrow y = 12x + 16$; x-intercept: $0 = 12x + 16 \Rightarrow x = -\frac{4}{3} \Rightarrow (-\frac{4}{3}, 0)$; y-intercept: $y = 12(0) + 16 = 16 \Rightarrow (0, 16)$

73. $y = 2x^3 - 3x^2 - 12x + 20 \Rightarrow \frac{dy}{dx} = 6x^2 - 6x - 12$

(a) The tangent is perpendicular to the line $y = 1 - \frac{x}{24}$ when $\frac{dy}{dx} = -\left(-\frac{1}{24}\right) = 24$; $6x^2 - 6x - 12 = 24$
 $\Rightarrow x^2 - x - 2 = 4 \Rightarrow x^2 - x - 6 = 0 \Rightarrow (x - 3)(x + 2) = 0 \Rightarrow x = -2$ or $x = 3 \Rightarrow (-2, 16)$ and $(3, 11)$ are points where the tangent is perpendicular to $y = 1 - \frac{x}{24}$.

(b) The tangent is parallel to the line $y = \sqrt{2} - 12x$ when $\frac{dy}{dx} = -12 \Rightarrow 6x^2 - 6x - 12 = -12 \Rightarrow x^2 - x = 0$
 $\Rightarrow x(x - 1) = 0 \Rightarrow x = 0$ or $x = 1 \Rightarrow (0, 20)$ and $(1, 7)$ are points where the tangent is parallel to $y = \sqrt{2} - 12x$.

74. $y = \frac{\pi \sin x}{x} \Rightarrow \frac{dy}{dx} = \frac{x(\pi \cos x) - (\pi \sin x)(1)}{x^2} \Rightarrow m_1 = \frac{dy}{dx} \Big|_{x=\pi} = \frac{-\pi^2}{\pi^2} = -1$ and $m_2 = \frac{dy}{dx} \Big|_{x=-\pi} = \frac{\pi^2}{\pi^2} = 1$.

Since $m_1 = -\frac{1}{m_2}$ the tangents intersect at right angles.

75. $y = \tan x, -\frac{\pi}{2} < x < \frac{\pi}{2} \Rightarrow \frac{dy}{dx} = \sec^2 x$; now the slope of $y = -\frac{x}{2}$ is $-\frac{1}{2} \Rightarrow$ the normal line is parallel to $y = -\frac{x}{2}$ when $\frac{dy}{dx} = 2$. Thus, $\sec^2 x = 2 \Rightarrow \frac{1}{\cos^2 x} = 2$
 $\Rightarrow \cos^2 x = \frac{1}{2} \Rightarrow \cos x = \pm \frac{1}{\sqrt{2}} \Rightarrow x = -\frac{\pi}{4}$ and $x = \frac{\pi}{4}$ for $-\frac{\pi}{2} < x < \frac{\pi}{2} \Rightarrow (-\frac{\pi}{4}, -1)$ and $(\frac{\pi}{4}, 1)$ are points where the normal is parallel to $y = -\frac{x}{2}$.

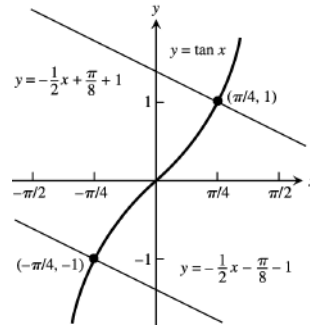

76. $y = 1 + \cos x \Rightarrow \frac{dy}{dx} = -\sin x \Rightarrow \frac{dy}{dx} \Big|_{(\pi/2, 1)} = -1$
 \Rightarrow the tangent at $(\frac{\pi}{2}, 1)$ is the line $y - 1 = -(x - \frac{\pi}{2})$
 $\Rightarrow y = -x + \frac{\pi}{2} + 1$; the normal at $(\frac{\pi}{2}, 1)$ is $y - 1 = (1)(x - \frac{\pi}{2}) \Rightarrow y = x - \frac{\pi}{2} + 1$

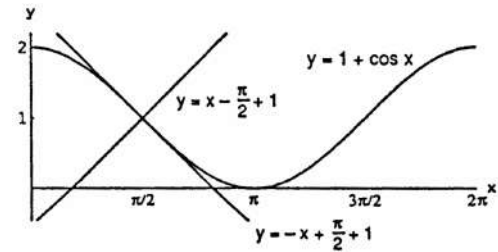

77. $y = x^2 + C \Rightarrow \frac{dy}{dx} = 2x$ and $y = x \Rightarrow \frac{dy}{dx} = 1$; the parabola is tangent to $y = x$ when $2x = 1 \Rightarrow x = \frac{1}{2} \Rightarrow y = \frac{1}{2}$; thus, $\frac{1}{2} = (\frac{1}{2})^2 + C \Rightarrow C = \frac{1}{4}$

78. $y = x^3 \Rightarrow \frac{dy}{dx} = 3x^2 \Rightarrow \frac{dy}{dx} \Big|_{x=a} = 3a^2 \Rightarrow$ the tangent line at (a, a^3) is $y - a^3 = 3a^2(x - a)$. The tangent line intersects $y = x^3$ when $x^3 - a^3 = 3a^2(x - a) \Rightarrow (x - a)(x^2 + xa + a^2) = 3a^2(x - a) \Rightarrow (x - a)(x^2 + xa - 2a^2) = 0$
 $\Rightarrow (x - a)^2(x + 2a) = 0 \Rightarrow x = a$ or $x = -2a$. Now $\frac{dy}{dx} \Big|_{x=-2a} = 3(-2a)^2 = 12a^2 = 4(3a^2)$, so the slope at $x = -2a$ is 4 times as large as the slope at (a, a^3) where $x = a$.

79. The line through $(0, 3)$ and $(5, -2)$ has slope $m = \frac{3 - (-2)}{0 - 5} = -1 \Rightarrow$ the line through $(0, 3)$ and $(5, -2)$ is $y = -x + 3$; $y = \frac{c}{x+1} \Rightarrow \frac{dy}{dx} = \frac{-c}{(x+1)^2}$, so the curve is tangent to $y = -x + 3 \Rightarrow \frac{dy}{dx} = -1 = \frac{-c}{(x+1)^2}$
 $\Rightarrow (x + 1)^2 = c, x \neq -1$. Moreover, $y = \frac{c}{x+1}$ intersects $y = -x + 3 \Rightarrow \frac{c}{x+1} = -x + 3, x \neq -1$
 $\Rightarrow c = (x + 1)(-x + 3), x \neq -1$. Thus $c = c \Rightarrow (x + 1)^2 = (x + 1)(-x + 3) \Rightarrow (x + 1)[x + 1 - (-x + 3)] = 0, x \neq -1 \Rightarrow (x + 1)(2x - 2) = 0 \Rightarrow x = 1$ (since $x \neq -1$) $\Rightarrow c = 4$.

80. Let $(b, \pm \sqrt{a^2 - b^2})$ be a point on the circle $x^2 + y^2 = a^2$. Then $x^2 + y^2 = a^2 \Rightarrow 2x + 2y \frac{dy}{dx} = 0 \Rightarrow \frac{dy}{dx} = -\frac{x}{y}$
 $\Rightarrow \left. \frac{dy}{dx} \right|_{x=b} = \frac{-b}{\pm \sqrt{a^2 - b^2}} \Rightarrow$ normal line through $(b, \pm \sqrt{a^2 - b^2})$ has slope $\frac{\pm \sqrt{a^2 - b^2}}{b} \Rightarrow$ normal line is
 $y - (\pm \sqrt{a^2 - b^2}) = \frac{\pm \sqrt{a^2 - b^2}}{b}(x - b) \Rightarrow y \mp \sqrt{a^2 - b^2} = \frac{\pm \sqrt{a^2 - b^2}}{b}x \mp \sqrt{a^2 - b^2} \Rightarrow y = \pm \frac{\sqrt{a^2 - b^2}}{b}x$
 which passes through the origin.

81. $x^2 + 2y^2 = 9 \Rightarrow 2x + 4y \frac{dy}{dx} = 0 \Rightarrow \frac{dy}{dx} = -\frac{x}{2y} \Rightarrow \left. \frac{dy}{dx} \right|_{(1,2)} = -\frac{1}{4} \Rightarrow$ the tangent line is $y = 2 - \frac{1}{4}(x - 1)$
 $= -\frac{1}{4}x + \frac{9}{4}$ and the normal line is $y = 2 + 4(x - 1) = 4x - 2$.

82. $x^3 + y^2 = 2 \Rightarrow 3x^2 + 2y \frac{dy}{dx} = 0 \Rightarrow \frac{dy}{dx} = \frac{-3x^2}{2y} \Rightarrow \left. \frac{dy}{dx} \right|_{(1,1)} = -\frac{3}{2} \Rightarrow$ the tangent line is $y = 1 + \frac{-3}{2}(x - 1)$
 $= -\frac{3}{2}x + \frac{5}{2}$ and the normal line is $y = 1 + \frac{2}{3}(x - 1) = \frac{2}{3}x + \frac{1}{3}$.

83. $xy + 2x - 5y = 2 \Rightarrow (x \frac{dy}{dx} + y) + 2 - 5 \frac{dy}{dx} = 0 \Rightarrow \frac{dy}{dx}(x - 5) = -y - 2 \Rightarrow \frac{dy}{dx} = \frac{-y-2}{x-5} \Rightarrow \left. \frac{dy}{dx} \right|_{(3,2)} = 2$
 \Rightarrow the tangent line is $y = 2 + 2(x - 3) = 2x - 4$ and the normal line is $y = 2 + \frac{-1}{2}(x - 3) = -\frac{1}{2}x + \frac{7}{2}$.

84. $(y - x)^2 = 2x + 4 \Rightarrow 2(y - x) \left(\frac{dy}{dx} - 1 \right) = 2 \Rightarrow (y - x) \frac{dy}{dx} = 1 + (y - x) \Rightarrow \frac{dy}{dx} = \frac{1+y-x}{y-x} \Rightarrow \left. \frac{dy}{dx} \right|_{(6,2)} = \frac{3}{4}$
 \Rightarrow the tangent line is $y = 2 + \frac{3}{4}(x - 6) = \frac{3}{4}x - \frac{5}{2}$ and the normal line is $y = 2 - \frac{4}{3}(x - 6) = -\frac{4}{3}x + 10$.

85. $x + \sqrt{xy} = 6 \Rightarrow 1 + \frac{1}{2\sqrt{xy}} \left(x \frac{dy}{dx} + y \right) = 0 \Rightarrow x \frac{dy}{dx} + y = -2\sqrt{xy} \Rightarrow \frac{dy}{dx} = \frac{-2\sqrt{xy}-y}{x} \Rightarrow \left. \frac{dy}{dx} \right|_{(4,1)} = \frac{-5}{4}$
 \Rightarrow the tangent line is $y = 1 - \frac{5}{4}(x - 4) = -\frac{5}{4}x + 6$ and the normal line is $y = 1 + \frac{4}{5}(x - 4) = \frac{4}{5}x - \frac{11}{5}$.

86. $x^{3/2} + 2y^{3/2} = 17 \Rightarrow \frac{3}{2}x^{1/2} + 3y^{1/2} \frac{dy}{dx} = 0 \Rightarrow \frac{dy}{dx} = \frac{-x^{1/2}}{2y^{1/2}} \Rightarrow \left. \frac{dy}{dx} \right|_{(1,4)} = -\frac{1}{4} \Rightarrow$ the tangent line is
 $y = 4 - \frac{1}{4}(x - 1) = -\frac{1}{4}x + \frac{17}{4}$ and the normal line is $y = 4 + 4(x - 1) = 4x$.

87. $x^3y^3 + y^2 = x + y \Rightarrow \left[x^3 \left(3y^2 \frac{dy}{dx} \right) + y^3 (3x^2) \right] + 2y \frac{dy}{dx} = 1 + \frac{dy}{dx} \Rightarrow 3x^3y^2 \frac{dy}{dx} + 2y \frac{dy}{dx} - \frac{dy}{dx} = 1 - 3x^2y^3$
 $\Rightarrow \frac{dy}{dx} (3x^3y^2 + 2y - 1) = 1 - 3x^2y^3 \Rightarrow \frac{dy}{dx} = \frac{1 - 3x^2y^3}{3x^3y^2 + 2y - 1} \Rightarrow \left. \frac{dy}{dx} \right|_{(1,1)} = -\frac{2}{4}$, but $\left. \frac{dy}{dx} \right|_{(1,-1)}$ is undefined.

Therefore, the curve has slope $-\frac{1}{2}$ at $(1, 1)$ but the slope is undefined at $(1, -1)$.

88. $y = \sin(x - \sin x) \Rightarrow \frac{dy}{dx} = [\cos(x - \sin x)](1 - \cos x)$; $y = 0 \Rightarrow \sin(x - \sin x) = 0 \Rightarrow x - \sin x = k\pi$,
 $k = -2, -1, 0, 1, 2$ (for our interval) $\Rightarrow \cos(x - \sin x) = \cos(k\pi) = \pm 1$. Therefore, $\frac{dy}{dx} = 0$ and $y = 0$ when
 $1 - \cos x = 0$ and $x = k\pi$. For $-2\pi \leq x \leq 2\pi$, these equations hold when $k = -2, 0$, and 2 (since
 $\cos(-\pi) = \cos \pi = -1$). Thus the curve has horizontal tangents at the x-axis for the x-values $-2\pi, 0$, and 2π
 (which are even integer multiples of π) \Rightarrow the curve has an infinite number of horizontal tangents.

89. $x = \frac{1}{2} \tan t, y = \frac{1}{2} \sec t \Rightarrow \frac{dy}{dx} = \frac{dy/dt}{dx/dt} = \frac{\frac{1}{2} \sec t \tan t}{\frac{1}{2} \sec^2 t} = \frac{\tan t}{\sec t} = \sin t \Rightarrow \left. \frac{dy}{dx} \right|_{t=\pi/3} = \sin \frac{\pi}{3} = \frac{\sqrt{3}}{2}$; $t = \frac{\pi}{3}$
 $\Rightarrow x = \frac{1}{2} \tan \frac{\pi}{3} = \frac{\sqrt{3}}{2}$ and $y = \frac{1}{2} \sec \frac{\pi}{3} = 1 \Rightarrow y = \frac{\sqrt{3}}{2}x + \frac{1}{4}$; $\frac{d^2y}{dx^2} = \frac{dy'/dt}{dx/dt} = \frac{\cos t}{\frac{1}{2} \sec^2 t} = 2 \cos^3 t \Rightarrow \left. \frac{d^2y}{dx^2} \right|_{t=\pi/3} = 2 \cos^3 \left(\frac{\pi}{3} \right) = \frac{1}{4}$

90. $x = 1 + \frac{1}{t^2}, y = 1 - \frac{3}{t} \Rightarrow \frac{dy}{dx} = \frac{dy/dt}{dx/dt} = \frac{\left(\frac{3}{t^2} \right)}{\left(-\frac{2}{t^3} \right)} = -\frac{3}{2}t \Rightarrow \left. \frac{dy}{dx} \right|_{t=2} = -\frac{3}{2}(2) = -3$; $t = 2 \Rightarrow x = 1 + \frac{1}{2^2} = \frac{5}{4}$ and

$$y = 1 - \frac{3}{2} = -\frac{1}{2} \Rightarrow y = -3x + \frac{13}{4}; \frac{d^2y}{dx^2} = \frac{dy'/dt}{dx/dt} = \frac{\left(-\frac{3}{2}\right)}{\left(-\frac{2}{t^3}\right)} = \frac{3}{4}t^3 \Rightarrow \left.\frac{d^2y}{dx^2}\right|_{t=2} = \frac{3}{4}(2)^3 = 6$$

91. B = graph of f, A = graph of f'. Curve B cannot be the derivative of A because A has only negative slopes while some of B's values are positive.

92. A = graph of f, B = graph of f'. Curve A cannot be the derivative of B because B has only negative slopes while A has positive values for x > 0.

93.

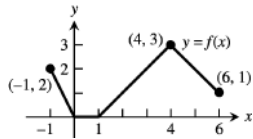

94.

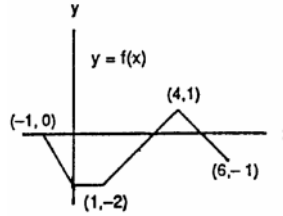

95. (a) 0, 0

(b) largest 1700, smallest about 1400

96. rabbits/day and foxes/day

$$97. \lim_{x \rightarrow 0} \frac{\sin x}{2x^2 - x} = \lim_{x \rightarrow 0} \left[\left(\frac{\sin x}{x}\right) \cdot \frac{1}{(2x-1)} \right] = (1) \left(\frac{1}{-1}\right) = -1$$

$$98. \lim_{x \rightarrow 0} \frac{3x - \tan 7x}{2x} = \lim_{x \rightarrow 0} \left(\frac{3x}{2x} - \frac{\sin 7x}{2x \cos 7x} \right) = \frac{3}{2} - \lim_{x \rightarrow 0} \left(\frac{1}{\cos 7x} \cdot \frac{\sin 7x}{7x} \cdot \frac{1}{\left(\frac{7}{x}\right)} \right) = \frac{3}{2} - (1 \cdot 1 \cdot \frac{7}{2}) = -2$$

$$99. \lim_{r \rightarrow 0} \frac{\sin r}{\tan 2r} = \lim_{r \rightarrow 0} \left(\frac{\sin r}{r} \cdot \frac{2r}{\tan 2r} \cdot \frac{1}{2} \right) = \left(\frac{1}{2}\right) (1) \lim_{r \rightarrow 0} \frac{\cos 2r}{\left(\frac{\sin 2r}{2r}\right)} = \left(\frac{1}{2}\right) (1) \left(\frac{1}{1}\right) = \frac{1}{2}$$

$$100. \lim_{\theta \rightarrow 0} \frac{\sin(\sin \theta)}{\theta} = \lim_{\theta \rightarrow 0} \left(\frac{\sin(\sin \theta)}{\sin \theta} \right) \left(\frac{\sin \theta}{\theta} \right) = \lim_{\theta \rightarrow 0} \frac{\sin(\sin \theta)}{\sin \theta}. \text{ Let } x = \sin \theta. \text{ Then } x \rightarrow 0 \text{ as } \theta \rightarrow 0 \\ \Rightarrow \lim_{\theta \rightarrow 0} \frac{\sin(\sin \theta)}{\sin \theta} = \lim_{x \rightarrow 0} \frac{\sin x}{x} = 1$$

$$101. \lim_{\theta \rightarrow \left(\frac{\pi}{2}\right)^-} \frac{4 \tan^2 \theta + \tan \theta + 1}{\tan^2 \theta + 5} = \lim_{\theta \rightarrow \left(\frac{\pi}{2}\right)^-} \frac{\left(4 + \frac{1}{\tan \theta} + \frac{1}{\tan^2 \theta}\right)}{\left(1 + \frac{5}{\tan^2 \theta}\right)} = \frac{(4+0+0)}{(1+0)} = 4$$

$$102. \lim_{\theta \rightarrow 0^+} \frac{1 - 2 \cot^2 \theta}{5 \cot^2 \theta - 7 \cot \theta - 8} = \lim_{\theta \rightarrow 0^+} \frac{\left(\frac{1}{\cot^2 \theta} - 2\right)}{\left(5 - \frac{7}{\cot \theta} - \frac{8}{\cot^2 \theta}\right)} = \frac{(0-2)}{(5-0-0)} = -\frac{2}{5}$$

$$103. \lim_{x \rightarrow 0} \frac{x \sin x}{2 - 2 \cos x} = \lim_{x \rightarrow 0} \frac{x \sin x}{2(1 - \cos x)} = \lim_{x \rightarrow 0} \frac{x \sin x}{2 \left(2 \sin^2 \left(\frac{x}{2}\right)\right)} = \lim_{x \rightarrow 0} \left[\frac{\frac{x}{2} \cdot \frac{x}{2}}{\sin^2 \left(\frac{x}{2}\right)} \cdot \frac{\sin x}{x} \right] \\ = \lim_{x \rightarrow 0} \left[\frac{\left(\frac{x}{2}\right)}{\sin \left(\frac{x}{2}\right)} \cdot \frac{\left(\frac{x}{2}\right)}{\sin \left(\frac{x}{2}\right)} \cdot \frac{\sin x}{x} \right] = (1)(1)(1) = 1$$

$$104. \lim_{\theta \rightarrow 0} \frac{1 - \cos \theta}{\theta^2} = \lim_{\theta \rightarrow 0} \frac{2 \sin^2 \left(\frac{\theta}{2}\right)}{\theta^2} = \lim_{\theta \rightarrow 0} \left[\frac{\sin \left(\frac{\theta}{2}\right)}{\left(\frac{\theta}{2}\right)} \cdot \frac{\sin \left(\frac{\theta}{2}\right)}{\left(\frac{\theta}{2}\right)} \cdot \frac{1}{2} \right] = (1)(1) \left(\frac{1}{2}\right) = \frac{1}{2}$$

$$105. \lim_{x \rightarrow 0} \frac{\tan x}{x} = \lim_{x \rightarrow 0} \left(\frac{1}{\cos x} \cdot \frac{\sin x}{x} \right) = 1; \text{ let } \theta = \tan x \Rightarrow \theta \rightarrow 0 \text{ as } x \rightarrow 0 \Rightarrow \lim_{x \rightarrow 0} g(x) = \lim_{x \rightarrow 0} \frac{\tan(\tan x)}{\tan x} \\ = \lim_{\theta \rightarrow 0} \frac{\tan \theta}{\theta} = 1. \text{ Therefore, to make } g \text{ continuous at the origin, define } g(0) = 1.$$

106. $\lim_{x \rightarrow 0} f(x) = \lim_{x \rightarrow 0} \frac{\tan(\tan x)}{\sin(\sin x)} = \lim_{x \rightarrow 0} \left[\frac{\tan(\tan x)}{\tan x} \cdot \frac{\sin x}{\sin(\sin x)} \cdot \frac{1}{\cos x} \right] = 1 \cdot \lim_{x \rightarrow 0} \frac{\sin x}{\sin(\sin x)}$ (using the result of #105); let $\theta = \sin x \Rightarrow \theta \rightarrow 0$ as $x \rightarrow 0 \Rightarrow \lim_{x \rightarrow 0} \frac{\sin x}{\sin(\sin x)} = \lim_{\theta \rightarrow 0} \frac{\theta}{\sin \theta} = 1$. Therefore, to make f continuous at the origin, define $f(0) = 1$.
107. (a) $S = 2\pi r^2 + 2\pi rh$ and h constant $\Rightarrow \frac{dS}{dt} = 4\pi r \frac{dr}{dt} + 2\pi h \frac{dr}{dt} = (4\pi r + 2\pi h) \frac{dr}{dt}$
 (b) $S = 2\pi r^2 + 2\pi rh$ and r constant $\Rightarrow \frac{dS}{dt} = 2\pi r \frac{dh}{dt}$
 (c) $S = 2\pi r^2 + 2\pi rh \Rightarrow \frac{dS}{dt} = 4\pi r \frac{dr}{dt} + 2\pi \left(r \frac{dh}{dt} + h \frac{dr}{dt} \right) = (4\pi r + 2\pi h) \frac{dr}{dt} + 2\pi r \frac{dh}{dt}$
 (d) S constant $\Rightarrow \frac{dS}{dt} = 0 \Rightarrow 0 = (4\pi r + 2\pi h) \frac{dr}{dt} + 2\pi r \frac{dh}{dt} \Rightarrow (2r + h) \frac{dr}{dt} = -r \frac{dh}{dt} \Rightarrow \frac{dr}{dt} = \frac{-r}{2r+h} \frac{dh}{dt}$
108. $S = \pi r \sqrt{r^2 + h^2} \Rightarrow \frac{dS}{dt} = \pi r \cdot \frac{\left(r \frac{dr}{dt} + h \frac{dh}{dt} \right)}{\sqrt{r^2 + h^2}} + \pi \sqrt{r^2 + h^2} \frac{dr}{dt}$;
 (a) h constant $\Rightarrow \frac{dh}{dt} = 0 \Rightarrow \frac{dS}{dt} = \frac{\pi r^2 \frac{dr}{dt}}{\sqrt{r^2 + h^2}} + \pi \sqrt{r^2 + h^2} \frac{dr}{dt} = \left[\pi \sqrt{r^2 + h^2} + \frac{\pi r^2}{\sqrt{r^2 + h^2}} \right] \frac{dr}{dt}$
 (b) r constant $\Rightarrow \frac{dr}{dt} = 0 \Rightarrow \frac{dS}{dt} = \frac{\pi r h}{\sqrt{r^2 + h^2}} \frac{dh}{dt}$
 (c) In general, $\frac{dS}{dt} = \left[\pi \sqrt{r^2 + h^2} + \frac{\pi r^2}{\sqrt{r^2 + h^2}} \right] \frac{dr}{dt} + \frac{\pi r h}{\sqrt{r^2 + h^2}} \frac{dh}{dt}$
109. $A = \pi r^2 \Rightarrow \frac{dA}{dt} = 2\pi r \frac{dr}{dt}$; so $r = 10$ and $\frac{dr}{dt} = -\frac{2}{\pi}$ m/sec $\Rightarrow \frac{dA}{dt} = (2\pi)(10) \left(-\frac{2}{\pi} \right) = -40$ m²/sec
110. $V = s^3 \Rightarrow \frac{dV}{dt} = 3s^2 \cdot \frac{ds}{dt} \Rightarrow \frac{ds}{dt} = \frac{1}{3s^2} \frac{dV}{dt}$; so $s = 20$ and $\frac{dV}{dt} = 1200$ cm³/min $\Rightarrow \frac{ds}{dt} = \frac{1}{3(20)^2} (1200) = 1$ cm/min
111. $\frac{dR_1}{dt} = -1$ ohm/sec, $\frac{dR_2}{dt} = 0.5$ ohm/sec; and $\frac{1}{R} = \frac{1}{R_1} + \frac{1}{R_2} \Rightarrow \frac{-1}{R^2} \frac{dR}{dt} = \frac{-1}{R_1^2} \frac{dR_1}{dt} - \frac{1}{R_2^2} \frac{dR_2}{dt}$. Also, $R_1 = 75$ ohms and $R_2 = 50$ ohms $\Rightarrow \frac{1}{R} = \frac{1}{75} + \frac{1}{50} \Rightarrow R = 30$ ohms. Therefore, from the derivative equation, $\frac{-1}{(30)^2} \frac{dR}{dt} = \frac{-1}{(75)^2} (-1) - \frac{1}{(50)^2} (0.5) = \left(\frac{1}{5625} - \frac{1}{5000} \right) \Rightarrow \frac{dR}{dt} = (-900) \left(\frac{5000-5625}{5625 \cdot 5000} \right) = \frac{9(625)}{50(5625)} = \frac{1}{50} = 0.02$ ohm/sec.
112. $\frac{dR}{dt} = 3$ ohms/sec and $\frac{dX}{dt} = -2$ ohms/sec; $Z = \sqrt{R^2 + X^2} \Rightarrow \frac{dZ}{dt} = \frac{R \frac{dR}{dt} + X \frac{dX}{dt}}{\sqrt{R^2 + X^2}}$ so that $R = 10$ ohms and $X = 20$ ohms $\Rightarrow \frac{dZ}{dt} = \frac{(10)(3) + (20)(-2)}{\sqrt{10^2 + 20^2}} = \frac{-1}{\sqrt{5}} \approx -0.45$ ohm/sec.
113. Given $\frac{dx}{dt} = 10$ m/sec and $\frac{dy}{dt} = 5$ m/sec, let D be the distance from the origin $\Rightarrow D^2 = x^2 + y^2 \Rightarrow 2D \frac{dD}{dt} = 2x \frac{dx}{dt} + 2y \frac{dy}{dt} \Rightarrow D \frac{dD}{dt} = x \frac{dx}{dt} + y \frac{dy}{dt}$. When $(x, y) = (3, -4)$, $D = \sqrt{3^2 + (-4)^2} = 5$ and $5 \frac{dD}{dt} = (5)(10) + (12)(5) \Rightarrow \frac{dD}{dt} = \frac{110}{5} = 22$. Therefore, the particle is moving away from the origin at 22 m/sec (because the distance D is increasing).
114. Let D be the distance from the origin. We are given that $\frac{dD}{dt} = 11$ units/sec. Then $D^2 = x^2 + y^2 = x^2 + (x^{3/2})^2 = x^2 + x^3 \Rightarrow 2D \frac{dD}{dt} = 2x \frac{dx}{dt} + 3x^2 \frac{dx}{dt} = x(2 + 3x) \frac{dx}{dt}$; $x = 3 \Rightarrow D = \sqrt{3^2 + 3^3} = 6$ and substitution in the derivative equation gives $(2)(6)(11) = (3)(2 + 9) \frac{dx}{dt} \Rightarrow \frac{dx}{dt} = 4$ units/sec.
115. (a) From the diagram we have $\frac{10}{h} = \frac{4}{r} \Rightarrow r = \frac{2}{5} h$.
 (b) $V = \frac{1}{3} \pi r^2 h = \frac{1}{3} \pi \left(\frac{2}{5} h \right)^2 h = \frac{4\pi h^3}{75} \Rightarrow \frac{dV}{dt} = \frac{4\pi h^2}{25} \frac{dh}{dt}$, so $\frac{dV}{dt} = -5$ and $h = 6 \Rightarrow \frac{dh}{dt} = -\frac{125}{144\pi}$ ft/min.
116. From the sketch in the text, $s = r\theta \Rightarrow \frac{ds}{dt} = r \frac{d\theta}{dt} + \theta \frac{dr}{dt}$. Also $r = 1.2$ is constant $\Rightarrow \frac{dr}{dt} = 0 \Rightarrow \frac{ds}{dt} = r \frac{d\theta}{dt} = (1.2) \frac{d\theta}{dt}$. Therefore, $\frac{ds}{dt} = 6$ ft/sec and $r = 1.2$ ft $\Rightarrow \frac{d\theta}{dt} = 5$ rad/sec

117. (a) From the sketch in the text, $\frac{d\theta}{dt} = -0.6 \text{ rad/sec}$ and $x = \tan \theta$. Also $x = \tan \theta \Rightarrow \frac{dx}{dt} = \sec^2 \theta \frac{d\theta}{dt}$; at point A, $x = 0 \Rightarrow \theta = 0 \Rightarrow \frac{dx}{dt} = (\sec^2 0)(-0.6) = -0.6$. Therefore the speed of the light is $0.6 = \frac{3}{5} \text{ km/sec}$ when it reaches point A.

(b) $\frac{(3/5) \text{ rad}}{\text{sec}} \cdot \frac{1 \text{ rev}}{2\pi \text{ rad}} \cdot \frac{60 \text{ sec}}{\text{min}} = \frac{18}{\pi} \text{ revs/min}$

118. From the figure, $\frac{a}{r} = \frac{b}{BC} \Rightarrow \frac{a}{r} = \frac{b}{\sqrt{b^2 - r^2}}$. We are given that r is constant. Differentiation gives,

$$\frac{1}{r} \cdot \frac{da}{dt} = \frac{(\sqrt{b^2 - r^2}) \left(\frac{db}{dt}\right) - (b) \left(\frac{b}{\sqrt{b^2 - r^2}}\right) \left(\frac{db}{dt}\right)}{b^2 - r^2}$$

$b = 2r$ and $\frac{db}{dt} = -0.3r$

$$\Rightarrow \frac{da}{dt} = r \left[\frac{\sqrt{(2r)^2 - r^2}(-0.3r) - (2r) \left(\frac{2r(-0.3r)}{\sqrt{(2r)^2 - r^2}}\right)}{(2r)^2 - r^2} \right]$$

$$= \frac{\sqrt{3r^2}(-0.3r) + \frac{4r^2(0.3r)}{\sqrt{3r^2}}}{3r} = \frac{(3r^2)(-0.3r) + (4r^2)(0.3r)}{3\sqrt{3}r^2} = \frac{0.3r}{3\sqrt{3}} = \frac{r}{10\sqrt{3}} \text{ m/sec.}$$

Since $\frac{da}{dt}$ is positive, the distance OA is increasing when OB = 2r, and B is moving toward O at the rate of 0.3r m/sec.

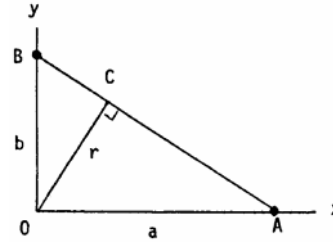

119.(a) If $f(x) = \tan x$ and $x = -\frac{\pi}{4}$, then $f'(x) = \sec^2 x$,
 $f(-\frac{\pi}{4}) = -1$ and $f'(-\frac{\pi}{4}) = 2$. The linearization of $f(x)$ is $L(x) = 2(x + \frac{\pi}{4}) + (-1) = 2x + \frac{\pi-2}{2}$.

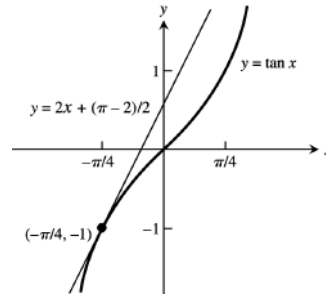

(b) If $f(x) = \sec x$ and $x = -\frac{\pi}{4}$, then $f'(x) = \sec x \tan x$,
 $f(-\frac{\pi}{4}) = \sqrt{2}$ and $f'(-\frac{\pi}{4}) = -\sqrt{2}$. The linearization of $f(x)$ is $L(x) = -\sqrt{2}(x + \frac{\pi}{4}) + \sqrt{2}$
 $= -\sqrt{2}x + \frac{\sqrt{2}(4-\pi)}{4}$.

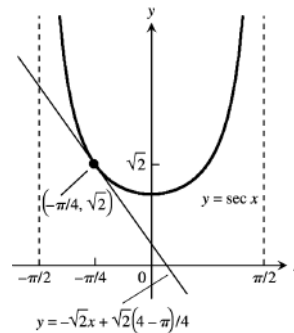

120. $f(x) = \frac{1}{1 + \tan x} \Rightarrow f'(x) = \frac{-\sec^2 x}{(1 + \tan x)^2}$. The linearization at $x = 0$ is $L(x) = f'(0)(x - 0) + f(0) = 1 - x$.

121. $f(x) = \sqrt{x + 1} + \sin x - 0.5 = (x + 1)^{1/2} + \sin x - 0.5 \Rightarrow f'(x) = (\frac{1}{2})(x + 1)^{-1/2} + \cos x$
 $\Rightarrow L(x) = f'(0)(x - 0) + f(0) = 1.5(x - 0) + 0.5 \Rightarrow L(x) = 1.5x + 0.5$, the linearization of $f(x)$.

122. $f(x) = \frac{2}{1-x} + \sqrt{1+x} - 3.1 = 2(1-x)^{-1} + (1+x)^{1/2} - 3.1 \Rightarrow f'(x) = -2(1-x)^{-2}(-1) + \frac{1}{2}(1+x)^{-1/2}$
 $= \frac{2}{(1-x)^2} + \frac{1}{2\sqrt{1+x}} \Rightarrow L(x) = f'(0)(x - 0) + f(0) = 2.5x - 0.1$, the linearization of $f(x)$.

123. $S = \pi r \sqrt{r^2 + h^2}$, r constant $\Rightarrow dS = \pi r \cdot \frac{1}{2}(r^2 + h^2)^{-1/2} 2h dh = \frac{\pi r h}{\sqrt{r^2 + h^2}} dh$. Height changes from h_0 to $h_0 + dh$
 $\Rightarrow dS = \frac{\pi r h_0 (dh)}{\sqrt{r^2 + h_0^2}}$

124. (a) $S = 6r^2 \Rightarrow dS = 12r dr$. We want $|dS| \leq (2\%)S \Rightarrow |12r dr| \leq \frac{12r^2}{100} \Rightarrow |dr| \leq \frac{r}{100}$. The measurement of the edge r must have an error less than 1%.

(b) When $V = r^3$, then $dV = 3r^2 dr$. The accuracy of the volume is $\left(\frac{dV}{V}\right)(100\%) = \left(\frac{3r^2 dr}{r^3}\right)(100\%) = \left(\frac{3}{r}\right)(dr)(100\%) = \left(\frac{3}{r}\right)\left(\frac{r}{100}\right)(100\%) = 3\%$

125. $C = 2\pi r \Rightarrow r = \frac{C}{2\pi}$, $S = 4\pi r^2 = \frac{C^2}{\pi}$, and $V = \frac{4}{3}\pi r^3 = \frac{C^3}{6\pi^2}$. It also follows that $dr = \frac{1}{2\pi} dC$, $dS = \frac{2C}{\pi} dC$ and $dV = \frac{C^2}{2\pi^2} dC$. Recall that $C = 10$ cm and $dC = 0.4$ cm.

(a) $dr = \frac{0.4}{2\pi} = \frac{0.2}{\pi}$ cm $\Rightarrow \left(\frac{dr}{r}\right)(100\%) = \left(\frac{0.2}{\pi}\right)\left(\frac{2\pi}{10}\right)(100\%) = (.04)(100\%) = 4\%$

(b) $dS = \frac{20}{\pi}(0.4) = \frac{8}{\pi}$ cm $\Rightarrow \left(\frac{dS}{S}\right)(100\%) = \left(\frac{8}{\pi}\right)\left(\frac{\pi}{100}\right)(100\%) = 8\%$

(c) $dV = \frac{10^2}{2\pi^2}(0.4) = \frac{20}{\pi^2}$ cm $\Rightarrow \left(\frac{dV}{V}\right)(100\%) = \left(\frac{20}{\pi^2}\right)\left(\frac{6\pi^2}{1000}\right)(100\%) = 12\%$

126. Similar triangles yield $\frac{35}{h} = \frac{15}{6} \Rightarrow h = 14$ ft. The same triangles imply that $\frac{20+a}{h} = \frac{a}{6} \Rightarrow h = 120a^{-1} + 6$
 $\Rightarrow dh = -120a^{-2} da = -\frac{120}{a^2} da = \left(-\frac{120}{a^2}\right)\left(\pm \frac{1}{12}\right) = \left(-\frac{120}{15^2}\right)\left(\pm \frac{1}{12}\right) = \pm \frac{2}{45} \approx \pm .0444$ ft = ± 0.53 inches.

CHAPTER 3 ADDITIONAL AND ADVANCED EXERCISES

- (a) $\sin 2\theta = 2 \sin \theta \cos \theta \Rightarrow \frac{d}{d\theta}(\sin 2\theta) = \frac{d}{d\theta}(2 \sin \theta \cos \theta) \Rightarrow 2 \cos 2\theta = 2[(\sin \theta)(-\sin \theta) + (\cos \theta)(\cos \theta)]$
 $\Rightarrow \cos 2\theta = \cos^2 \theta - \sin^2 \theta$

(b) $\cos 2\theta = \cos^2 \theta - \sin^2 \theta \Rightarrow \frac{d}{d\theta}(\cos 2\theta) = \frac{d}{d\theta}(\cos^2 \theta - \sin^2 \theta) \Rightarrow -2 \sin 2\theta = (2 \cos \theta)(-\sin \theta) - (2 \sin \theta)(\cos \theta)$
 $\Rightarrow \sin 2\theta = \cos \theta \sin \theta + \sin \theta \cos \theta \Rightarrow \sin 2\theta = 2 \sin \theta \cos \theta$
- The derivative of $\sin(x+a) = \sin x \cos a + \cos x \sin a$ with respect to x is $\cos(x+a) = \cos x \cos a - \sin x \sin a$, which is also an identity. This principle does not apply to the equation $x^2 - 2x - 8 = 0$, since $x^2 - 2x - 8 = 0$ is not an identity: it holds for 2 values of x (-2 and 4), but not for all x .
- (a) $f(x) = \cos x \Rightarrow f'(x) = -\sin x \Rightarrow f''(x) = -\cos x$, and $g(x) = a + bx + cx^2 \Rightarrow g'(x) = b + 2cx \Rightarrow g''(x) = 2c$;
also, $f(0) = g(0) \Rightarrow \cos(0) = a \Rightarrow a = 1$; $f'(0) = g'(0) \Rightarrow -\sin(0) = b \Rightarrow b = 0$; $f''(0) = g''(0)$
 $\Rightarrow -\cos(0) = 2c \Rightarrow c = -\frac{1}{2}$. Therefore, $g(x) = 1 - \frac{1}{2}x^2$.

(b) $f(x) = \sin(x+a) \Rightarrow f'(x) = \cos(x+a)$, and $g(x) = b \sin x + c \cos x \Rightarrow g'(x) = b \cos x - c \sin x$; also,
 $f(0) = g(0) \Rightarrow \sin(a) = b \sin(0) + c \cos(0) \Rightarrow c = \sin a$; $f'(0) = g'(0) \Rightarrow \cos(a) = b \cos(0) - c \sin(0)$
 $\Rightarrow b = \cos a$. Therefore, $g(x) = \sin x \cos a + \cos x \sin a$.

(c) When $f(x) = \cos x$, $f'''(x) = \sin x$ and $f^{(4)}(x) = \cos x$; when $g(x) = 1 - \frac{1}{2}x^2$, $g'''(x) = 0$ and $g^{(4)}(x) = 0$.
Thus $f'''(0) = 0 = g'''(0)$ so the third derivatives agree at $x = 0$. However, the fourth derivatives do not agree since $f^{(4)}(0) = 1$ but $g^{(4)}(0) = 0$. In case (b), when $f(x) = \sin(x+a)$ and $g(x) = \sin x \cos a + \cos x \sin a$, notice that $f(x) = g(x)$ for all x , not just $x = 0$. Since this is an identity, we have $f^{(n)}(x) = g^{(n)}(x)$ for any x and any positive integer n .
- (a) $y = \sin x \Rightarrow y' = \cos x \Rightarrow y'' = -\sin x \Rightarrow y'' + y = -\sin x + \sin x = 0$; $y = \cos x \Rightarrow y' = -\sin x$
 $\Rightarrow y'' = -\cos x \Rightarrow y'' + y = -\cos x + \cos x = 0$; $y = a \cos x + b \sin x \Rightarrow y' = -a \sin x + b \cos x$
 $\Rightarrow y'' = -a \cos x - b \sin x \Rightarrow y'' + y = (-a \cos x - b \sin x) + (a \cos x + b \sin x) = 0$

(b) $y = \sin(2x) \Rightarrow y' = 2 \cos(2x) \Rightarrow y'' = -4 \sin(2x) \Rightarrow y'' + 4y = -4 \sin(2x) + 4 \sin(2x) = 0$. Similarly,
 $y = \cos(2x)$ and $y = a \cos(2x) + b \sin(2x)$ satisfy the differential equation $y'' + 4y = 0$. In general,
 $y = \cos(mx)$, $y = \sin(mx)$ and $y = a \cos(mx) + b \sin(mx)$ satisfy the differential equation $y'' + m^2y = 0$.

5. If the circle $(x - h)^2 + (y - k)^2 = a^2$ and $y = x^2 + 1$ are tangent at $(1, 2)$, then the slope of this tangent is $m = 2x|_{(1,2)} = 2$ and the tangent line is $y = 2x$. The line containing (h, k) and $(1, 2)$ is perpendicular to $y = 2x \Rightarrow \frac{k-2}{h-1} = -\frac{1}{2} \Rightarrow h = 5 - 2k \Rightarrow$ the location of the center is $(5 - 2k, k)$. Also, $(x - h)^2 + (y - k)^2 = a^2 \Rightarrow x - h + (y - k)y' = 0 \Rightarrow 1 + (y')^2 + (y - k)y'' = 0 \Rightarrow y'' = \frac{1+(y')^2}{k-y}$. At the point $(1, 2)$ we know $y' = 2$ from the tangent line and that $y'' = 2$ from the parabola. Since the second derivatives are equal at $(1, 2)$ we obtain $2 = \frac{1+(2)^2}{k-2} \Rightarrow k = \frac{9}{2}$. Then $h = 5 - 2k = -4 \Rightarrow$ the circle is $(x + 4)^2 + (y - \frac{9}{2})^2 = a^2$. Since $(1, 2)$ lies on the circle we have that $a = \frac{5\sqrt{5}}{2}$.
6. The total revenue is the number of people times the price of the fare: $r(x) = xp = x(3 - \frac{x}{40})^2$, where $0 \leq x \leq 60$. The marginal revenue is $\frac{dr}{dx} = (3 - \frac{x}{40})^2 + 2x(3 - \frac{x}{40})(-\frac{1}{40}) \Rightarrow \frac{dr}{dx} = (3 - \frac{x}{40})[(3 - \frac{x}{40}) - \frac{2x}{40}] = 3(3 - \frac{x}{40})(1 - \frac{x}{40})$. Then $\frac{dr}{dx} = 0 \Rightarrow x = 40$ (since $x = 120$ does not belong to the domain). When 40 people are on the bus the marginal revenue is zero and the fare is $p(40) = (3 - \frac{x}{40})^2|_{x=40} = \4.00 .
7. (a) $y = uv \Rightarrow \frac{dy}{dt} = \frac{du}{dt}v + u\frac{dv}{dt} = (0.04u)v + u(0.05v) = 0.09uv = 0.09y \Rightarrow$ the rate of growth of the total production is 9% per year.
- (b) If $\frac{du}{dt} = -0.02u$ and $\frac{dv}{dt} = 0.03v$, then $\frac{dy}{dt} = (-0.02u)v + (0.03v)u = 0.01uv = 0.01y$, increasing at 1% per year.

8. When $x^2 + y^2 = 225$, then $y' = -\frac{x}{y}$. The tangent line to the balloon at $(12, -9)$ is $y + 9 = \frac{4}{3}(x - 12) \Rightarrow y = \frac{4}{3}x - 25$. The top of the gondola is $15 + 8 = 23$ ft below the center of the balloon. The intersection of $y = -23$ and $y = \frac{4}{3}x - 25$ is at the far right edge of the gondola $\Rightarrow -23 = \frac{4}{3}x - 25 \Rightarrow x = \frac{3}{2}$. Thus the gondola is $2x = 3$ ft wide.

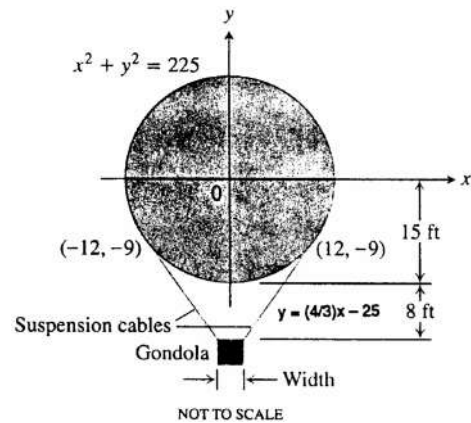

9. Answers will vary. Here is one possibility.

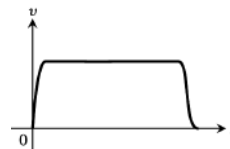

10. $s(t) = 10 \cos(t + \frac{\pi}{4}) \Rightarrow v(t) = \frac{ds}{dt} = -10 \sin(t + \frac{\pi}{4}) \Rightarrow a(t) = \frac{dv}{dt} = \frac{d^2s}{dt^2} = -10 \cos(t + \frac{\pi}{4})$
- (a) $s(0) = 10 \cos(\frac{\pi}{4}) = \frac{10}{\sqrt{2}}$
- (b) Left: -10 , Right: 10
- (c) Solving $10 \cos(t + \frac{\pi}{4}) = -10 \Rightarrow \cos(t + \frac{\pi}{4}) = -1 \Rightarrow t = \frac{3\pi}{4}$ when the particle is farthest to the left. Solving $10 \cos(t + \frac{\pi}{4}) = 10 \Rightarrow \cos(t + \frac{\pi}{4}) = 1 \Rightarrow t = -\frac{\pi}{4}$, but $t \geq 0 \Rightarrow t = 2\pi + \frac{-\pi}{4} = \frac{7\pi}{4}$ when the particle is farthest to the right. Thus, $v(\frac{3\pi}{4}) = 0$, $v(\frac{7\pi}{4}) = 0$, $a(\frac{3\pi}{4}) = 10$, and $a(\frac{7\pi}{4}) = -10$.
- (d) Solving $10 \cos(t + \frac{\pi}{4}) = 0 \Rightarrow t = \frac{\pi}{4} \Rightarrow v(\frac{\pi}{4}) = -10$, $|v(\frac{\pi}{4})| = 10$ and $a(\frac{\pi}{4}) = 0$.

11. (a) $s(t) = 64t - 16t^2 \Rightarrow v(t) = \frac{ds}{dt} = 64 - 32t = 32(2 - t)$. The maximum height is reached when $v(t) = 0$
 $\Rightarrow t = 2$ sec. The velocity when it leaves the hand is $v(0) = 64$ ft/sec.
- (b) $s(t) = 64t - 2.6t^2 \Rightarrow v(t) = \frac{ds}{dt} = 64 - 5.2t$. The maximum height is reached when $v(t) = 0 \Rightarrow t \approx 12.31$ sec.
 The maximum height is about $s(12.31) = 393.85$ ft.
12. $s_1 = 3t^3 - 12t^2 + 18t + 5$ and $s_2 = -t^3 + 9t^2 - 12t \Rightarrow v_1 = 9t^2 - 24t + 18$ and $v_2 = -3t^2 + 18t - 12$; $v_1 = v_2$
 $\Rightarrow 9t^2 - 24t + 18 = -3t^2 + 18t - 12 \Rightarrow 2t^2 - 7t + 5 = 0 \Rightarrow (t - 1)(2t - 5) = 0 \Rightarrow t = 1$ sec and $t = 2.5$ sec.
13. $m(v^2 - v_0^2) = k(x_0^2 - x^2) \Rightarrow m(2v \frac{dv}{dt}) = k(-2x \frac{dx}{dt}) \Rightarrow m \frac{dv}{dt} = k(-\frac{2x}{2v}) \frac{dx}{dt} \Rightarrow m \frac{dv}{dt} = -kx(\frac{1}{v}) \frac{dx}{dt}$. Then
 substituting $\frac{dx}{dt} = v \Rightarrow m \frac{dv}{dt} = -kx$, as claimed.
14. (a) $x = At^2 + Bt + C$ on $[t_1, t_2] \Rightarrow v = \frac{dx}{dt} = 2At + B \Rightarrow v(\frac{t_1+t_2}{2}) = 2A(\frac{t_1+t_2}{2}) + B = A(t_1 + t_2) + B$ is the
 instantaneous velocity at the midpoint. The average velocity over the time interval is $v_{av} = \frac{\Delta x}{\Delta t}$
 $= \frac{(At_2^2 + Bt_2 + C) - (At_1^2 + Bt_1 + C)}{t_2 - t_1} = \frac{(t_2 - t_1)[A(t_2 + t_1) + B]}{t_2 - t_1} = A(t_2 + t_1) + B$.
- (b) On the graph of the parabola $x = At^2 + Bt + C$, the slope of the curve at the midpoint of the interval
 $[t_1, t_2]$ is the same as the average slope of the curve over the interval.
15. (a) To be continuous at $x = \pi$ requires that $\lim_{x \rightarrow \pi^-} \sin x = \lim_{x \rightarrow \pi^+} (mx + b) \Rightarrow 0 = m\pi + b \Rightarrow m = -\frac{b}{\pi}$;
- (b) If $y' = \begin{cases} \cos x, & x < \pi \\ m, & x \geq \pi \end{cases}$ is differentiable at $x = \pi$, then $\lim_{x \rightarrow \pi^-} \cos x = m \Rightarrow m = -1$ and $b = \pi$.
16. $f(x)$ is continuous at 0 because $\lim_{x \rightarrow 0} \frac{1 - \cos x}{x} = 0 = f(0)$. $f'(0) = \lim_{x \rightarrow 0} \frac{f(x) - f(0)}{x - 0} = \lim_{x \rightarrow 0} \frac{1 - \cos x - 0}{x}$
 $= \lim_{x \rightarrow 0} \left(\frac{1 - \cos x}{x^2}\right) \left(\frac{1 + \cos x}{1 + \cos x}\right) = \lim_{x \rightarrow 0} \left(\frac{\sin x}{x}\right)^2 \left(\frac{1}{1 + \cos x}\right) = \frac{1}{2}$. Therefore $f'(0)$ exists with value $\frac{1}{2}$.
17. (a) For all a, b and for all $x \neq 2$, f is differentiable at x . Next, f differentiable at $x = 2 \Rightarrow f$ continuous at $x = 2$
 $\Rightarrow \lim_{x \rightarrow 2^-} f(x) = f(2) \Rightarrow 2a = 4a - 2b + 3 \Rightarrow 2a - 2b + 3 = 0$. Also, f differentiable at $x \neq 2$
 $\Rightarrow f'(x) = \begin{cases} a, & x < 2 \\ 2ax - b, & x > 2 \end{cases}$. In order that $f'(2)$ exist we must have $a = 2a(2) - b \Rightarrow a = 4a - b \Rightarrow 3a = b$.
 Then $2a - 2b + 3 = 0$ and $3a = b \Rightarrow a = \frac{3}{4}$ and $b = \frac{9}{4}$.
- (b) For $x < 2$, the graph of f is a straight line having a slope of $\frac{3}{4}$ and passing through the origin; for $x \geq 2$, the graph of f
 is a parabola. At $x = 2$, the value of the y -coordinate on the parabola is $\frac{3}{2}$ which matches the y -coordinate of the point
 on the straight line at $x = 2$. In addition, the slope of the parabola at the match up point is $\frac{3}{4}$ which is equal to the
 slope of the straight line. Therefore, since the graph is differentiable at the match up point, the graph is smooth there.
18. (a) For any a, b and for any $x \neq -1$, g is differentiable at x . Next, g differentiable at $x = -1 \Rightarrow g$ continuous at
 $x = -1 \Rightarrow \lim_{x \rightarrow -1^+} g(x) = g(-1) \Rightarrow -a - 1 + 2b = -a + b \Rightarrow b = 1$. Also, g differentiable at $x \neq -1$
 $\Rightarrow g'(x) = \begin{cases} a, & x < -1 \\ 3ax^2 + 1, & x > -1 \end{cases}$. In order that $g'(-1)$ exist we must have $a = 3a(-1)^2 + 1 \Rightarrow a = 3a + 1$
 $\Rightarrow a = -\frac{1}{2}$.
- (b) For $x \leq -1$, the graph of f is a straight line having a slope of $-\frac{1}{2}$ and a y -intercept of 1. For $x > -1$, the graph of f is
 a parabola. At $x = -1$, the value of the y -coordinate on the parabola is $\frac{3}{2}$ which matches the y -coordinate of the point
 on the straight line at $x = -1$. In addition, the slope of the parabola at the match up point is $-\frac{1}{2}$ which is equal to the
 slope of the straight line. Therefore, since the graph is differentiable at the match up point, the graph is smooth there.
19. f odd $\Rightarrow f(-x) = -f(x) \Rightarrow \frac{d}{dx}(f(-x)) = \frac{d}{dx}(-f(x)) \Rightarrow f'(-x)(-1) = -f'(x) \Rightarrow f'(-x) = f'(x) \Rightarrow f'$ is even.

20. f even $\Rightarrow f(-x) = f(x) \Rightarrow \frac{d}{dx}(f(-x)) = \frac{d}{dx}(f(x)) \Rightarrow f'(-x)(-1) = f'(x) \Rightarrow f'(-x) = -f'(x) \Rightarrow f'$ is odd.

21. Let $h(x) = (fg)(x) = f(x)g(x) \Rightarrow h'(x) = \lim_{x \rightarrow x_0} \frac{h(x) - h(x_0)}{x - x_0} = \lim_{x \rightarrow x_0} \frac{f(x)g(x) - f(x_0)g(x_0)}{x - x_0}$
 $= \lim_{x \rightarrow x_0} \frac{f(x)g(x) - f(x)g(x_0) + f(x)g(x_0) - f(x_0)g(x_0)}{x - x_0} = \lim_{x \rightarrow x_0} \left[f(x) \left[\frac{g(x) - g(x_0)}{x - x_0} \right] \right] + \lim_{x \rightarrow x_0} \left[g(x_0) \left[\frac{f(x) - f(x_0)}{x - x_0} \right] \right]$
 $= f(x_0) \lim_{x \rightarrow x_0} \left[\frac{g(x) - g(x_0)}{x - x_0} \right] + g(x_0) f'(x_0) = 0 \cdot \lim_{x \rightarrow x_0} \left[\frac{g(x) - g(x_0)}{x - x_0} \right] + g(x_0) f'(x_0) = g(x_0) f'(x_0)$, if g is continuous at x_0 . Therefore $(fg)(x)$ is differentiable at x_0 if $f(x_0) = 0$, and $(fg)'(x_0) = g(x_0) f'(x_0)$.

22. From Exercise 21 we have that fg is differentiable at 0 if f is differentiable at 0, $f(0) = 0$ and g is continuous at 0.

(a) If $f(x) = \sin x$ and $g(x) = |x|$, then $|x| \sin x$ is differentiable because $f'(0) = \cos(0) = 1$, $f(0) = \sin(0) = 0$ and $g(x) = |x|$ is continuous at $x = 0$.

(b) If $f(x) = \sin x$ and $g(x) = x^{2/3}$, then $x^{2/3} \sin x$ is differentiable because $f'(0) = \cos(0) = 1$, $f(0) = \sin(0) = 0$ and $g(x) = x^{2/3}$ is continuous at $x = 0$.

(c) If $f(x) = 1 - \cos x$ and $g(x) = \sqrt[3]{x}$, then $\sqrt[3]{x}(1 - \cos x)$ is differentiable because $f'(0) = \sin(0) = 0$, $f(0) = 1 - \cos(0) = 0$ and $g(x) = x^{1/3}$ is continuous at $x = 0$.

(d) If $f(x) = x$ and $g(x) = x \sin\left(\frac{1}{x}\right)$, then $x^2 \sin\left(\frac{1}{x}\right)$ is differentiable because $f'(0) = 1$, $f(0) = 0$ and

$$\lim_{x \rightarrow 0} x \sin\left(\frac{1}{x}\right) = \lim_{x \rightarrow 0} \frac{\sin\left(\frac{1}{x}\right)}{\frac{1}{x}} = \lim_{t \rightarrow \infty} \frac{\sin t}{t} = 0 \text{ (so } g \text{ is continuous at } x = 0\text{)}.$$

23. If $f(x) = x$ and $g(x) = x \sin\left(\frac{1}{x}\right)$, then $x^2 \sin\left(\frac{1}{x}\right)$ is differentiable at $x = 0$ because $f'(0) = 1$, $f(0) = 0$ and

$$\lim_{x \rightarrow 0} x \sin\left(\frac{1}{x}\right) = \lim_{x \rightarrow 0} \frac{\sin\left(\frac{1}{x}\right)}{\frac{1}{x}} = \lim_{t \rightarrow \infty} \frac{\sin t}{t} = 0 \text{ (so } g \text{ is continuous at } x = 0\text{)}. \text{ In fact, from Exercise 21,}$$

$h'(0) = g(0)f'(0) = 0$. However, for $x \neq 0$, $h'(x) = [x^2 \cos\left(\frac{1}{x}\right)] \left(-\frac{1}{x^2}\right) + 2x \sin\left(\frac{1}{x}\right)$. But

$\lim_{x \rightarrow 0} h'(x) = \lim_{x \rightarrow 0} \left[-\cos\left(\frac{1}{x}\right) + 2x \sin\left(\frac{1}{x}\right)\right]$ does not exist because $\cos\left(\frac{1}{x}\right)$ has no limit as $x \rightarrow 0$. Therefore, the derivative is not continuous at $x = 0$ because it has no limit there.

24. From the given conditions we have $f(x+h) = f(x)f(h)$, $f(h) - 1 = hg(h)$ and $\lim_{h \rightarrow 0} g(h) = 1$. Therefore,

$$f'(x) = \lim_{h \rightarrow 0} \frac{f(x+h) - f(x)}{h} = \lim_{h \rightarrow 0} \frac{f(x)f(h) - f(x)}{h} = \lim_{h \rightarrow 0} f(x) \left[\frac{f(h) - 1}{h} \right] = f(x) \left[\lim_{h \rightarrow 0} g(h) \right] = f(x) \cdot 1 = f(x)$$

$\Rightarrow f'(x) = f(x)$ and $f'(x)$ exists at every value of x .

25. Step 1: The formula holds for $n = 2$ (a single product) since $y = u_1 u_2 \Rightarrow \frac{dy}{dx} = \frac{du_1}{dx} u_2 + u_1 \frac{du_2}{dx}$.

Step 2: Assume the formula holds for $n = k$:

$$y = u_1 u_2 \cdots u_k \Rightarrow \frac{dy}{dx} = \frac{du_1}{dx} u_2 u_3 \cdots u_k + u_1 \frac{du_2}{dx} u_3 \cdots u_k + \cdots + u_1 u_2 \cdots u_{k-1} \frac{du_k}{dx}.$$

If $y = u_1 u_2 \cdots u_k u_{k+1} = (u_1 u_2 \cdots u_k) u_{k+1}$, then $\frac{dy}{dx} = \frac{d(u_1 u_2 \cdots u_k)}{dx} u_{k+1} + u_1 u_2 \cdots u_k \frac{du_{k+1}}{dx}$

$$= \left(\frac{du_1}{dx} u_2 u_3 \cdots u_k + u_1 \frac{du_2}{dx} u_3 \cdots u_k + \cdots + u_1 u_2 \cdots u_{k-1} \frac{du_k}{dx} \right) u_{k+1} + u_1 u_2 \cdots u_k \frac{du_{k+1}}{dx}$$

$$= \frac{du_1}{dx} u_2 u_3 \cdots u_{k+1} + u_1 \frac{du_2}{dx} u_3 \cdots u_{k+1} + \cdots + u_1 u_2 \cdots u_{k-1} \frac{du_k}{dx} u_{k+1} + u_1 u_2 \cdots u_k \frac{du_{k+1}}{dx}.$$

Thus the original formula holds for $n = (k+1)$ whenever it holds for $n = k$.

26. Recall $\binom{m}{k} = \frac{m!}{k!(m-k)!}$. Then $\binom{m}{1} = \frac{m!}{1!(m-1)!} = m$ and $\binom{m}{k} + \binom{m}{k+1} = \frac{m!}{k!(m-k)!} + \frac{m!}{(k+1)!(m-k-1)!}$
 $= \frac{m!(k+1) + m!(m-k)}{(k+1)!(m-k)!} = \frac{m!(m+1)}{(k+1)!(m-k)!} = \frac{(m+1)!}{(k+1)!(m-k)!} = \binom{m+1}{k+1}$. Now, we prove

Leibniz's rule by mathematical induction.

Step 1: If $n = 1$, then $\frac{d(uv)}{dx} = u \frac{dv}{dx} + v \frac{du}{dx}$. Assume that the statement is true for $n = k$, that is:

$$\frac{d^k(uv)}{dx^k} = \frac{d^k u}{dx^k} v + k \frac{d^{k-1} u}{dx^{k-1}} \frac{dv}{dx} + \binom{k}{2} \frac{d^{k-2} u}{dx^{k-2}} \frac{d^2 v}{dx^2} + \cdots + \binom{k}{k-1} \frac{du}{dx} \frac{d^{k-1} v}{dx^{k-1}} + u \frac{d^k v}{dx^k}.$$

Step 2: If $n = k + 1$, then $\frac{d^{k+1}(uv)}{dx^{k+1}} = \frac{d}{dx} \left(\frac{d^k(uv)}{dx^k} \right) = \left[\frac{d^{k+1} u}{dx^{k+1}} v + \frac{d^k u}{dx^k} \frac{dv}{dx} \right] + \left[k \frac{d^k u}{dx^k} \frac{dv}{dx} + k \frac{d^{k-1} u}{dx^{k-1}} \frac{d^2 v}{dx^2} \right]$

$$\begin{aligned}
& + \left[\binom{k}{2} \frac{d^{k-1}u}{dx^{k-1}} \frac{d^2v}{dx^2} + \binom{k}{2} \frac{d^{k-2}u}{dx^{k-2}} \frac{d^3v}{dx^3} \right] + \dots + \left[\binom{k}{k-1} \frac{d^2u}{dx^2} \frac{d^{k-1}v}{dx^{k-1}} + \binom{k}{k-1} \frac{du}{dx} \frac{d^k v}{dx^k} \right] \\
& + \left[\frac{du}{dx} \frac{d^k v}{dx^k} + u \frac{d^{k+1}u}{dx^{k+1}} \right] = \frac{d^{k+1}u}{dx^{k+1}} v + (k+1) \frac{d^k u}{dx^k} \frac{dv}{dx} + \left[\binom{k}{1} + \binom{k}{2} \right] \frac{d^{k-1}u}{dx^{k-1}} \frac{d^2v}{dx^2} + \dots \\
& + \left[\binom{k}{k-1} + \binom{k}{k} \right] \frac{du}{dx} \frac{d^k v}{dx^k} + u \frac{d^{k+1}u}{dx^{k+1}} = \frac{d^{k+1}u}{dx^{k+1}} v + (k+1) \frac{d^k u}{dx^k} \frac{dv}{dx} + \binom{k+1}{2} \frac{d^{k-1}u}{dx^{k-1}} \frac{d^2v}{dx^2} + \dots \\
& + \binom{k+1}{k} \frac{du}{dx} \frac{d^k v}{dx^k} + u \frac{d^{k+1}u}{dx^{k+1}}.
\end{aligned}$$

Therefore the formula (c) holds for $n = (k + 1)$ whenever it holds for $n = k$.

27. (a) $T^2 = \frac{4\pi^2 L}{g} \Rightarrow L = \frac{T^2 g}{4\pi^2} \Rightarrow L = \frac{(1 \text{ sec}^2)(32.2 \text{ ft/sec}^2)}{4\pi^2} \Rightarrow L \approx 0.8156 \text{ ft}$

(b) $T^2 = \frac{4\pi^2 L}{g} \Rightarrow T = \frac{2\pi}{\sqrt{g}} \sqrt{L}$; $dT = \frac{2\pi}{\sqrt{g}} \cdot \frac{1}{2\sqrt{L}} dL = \frac{\pi}{\sqrt{Lg}} dL$; $dT = \frac{\pi}{\sqrt{(0.8156 \text{ ft})(32.2 \text{ ft/sec}^2)}} (0.01 \text{ ft}) \approx 0.00613 \text{ sec}$.

(c) Since there are 86,400 sec in a day, we have $(0.00613 \text{ sec})(86,400 \text{ sec/day}) \approx 529.6 \text{ sec/day}$, or 8.83 min/day; the clock will lose about 8.83 min/day.

28. $v = s^3 \Rightarrow \frac{dv}{dt} = 3s^2 \frac{ds}{dt} = -k(6s^2) \Rightarrow \frac{ds}{dt} = -2k$. If s_0 = the initial length of the cube's side, then $s_1 = s_0 - 2k$

$\Rightarrow 2k = s_0 - s_1$. Let t = the time it will take the ice cube to melt. Now, $t = \frac{s_0}{2k} = \frac{s_0}{s_0 - s_1} = \frac{(v_0)^{1/3}}{(v_0)^{1/3} - (\frac{3}{4}v_0)^{1/3}}$

$= \frac{1}{1 - (\frac{3}{4})^{1/3}} \approx 11 \text{ hr}$.

NOTES:

CHAPTER 4 APPLICATIONS OF DERIVATIVES

4.1 EXTREME VALUES OF FUNCTIONS

1. An absolute minimum at $x = c_2$, an absolute maximum at $x = b$. Theorem 1 guarantees the existence of such extreme values because h is continuous on $[a, b]$.
2. An absolute minimum at $x = b$, an absolute maximum at $x = c$. Theorem 1 guarantees the existence of such extreme values because f is continuous on $[a, b]$.
3. No absolute minimum. An absolute maximum at $x = c$. Since the function's domain is an open interval, the function does not satisfy the hypotheses of Theorem 1 and need not have absolute extreme values.
4. No absolute extrema. The function is neither continuous nor defined on a closed interval, so it need not fulfill the conclusions of Theorem 1.
5. An absolute minimum at $x = a$ and an absolute maximum at $x = c$. Note that $y = g(x)$ is not continuous but still has extrema. When the hypothesis of Theorem 1 is satisfied then extrema are guaranteed, but when the hypothesis is not satisfied, absolute extrema may or may not occur.
6. Absolute minimum at $x = c$ and an absolute maximum at $x = a$. Note that $y = g(x)$ is not continuous but still has absolute extrema. When the hypothesis of Theorem 1 is satisfied then extrema are guaranteed, but when the hypothesis is not satisfied, absolute extrema may or may not occur.
7. Local minimum at $(-1, 0)$, local maximum at $(1, 0)$
8. Minima at $(-2, 0)$ and $(2, 0)$, maximum at $(0, 2)$
9. Maximum at $(0, 5)$. Note that there is no minimum since the endpoint $(2, 0)$ is excluded from the graph.
10. Local maximum at $(-3, 0)$, local minimum at $(2, 0)$, maximum at $(1, 2)$, minimum at $(0, -1)$
11. Graph (c), since this the only graph that has positive slope at c .
12. Graph (b), since this is the only graph that represents a differentiable function at a and b and has negative slope at c .
13. Graph (d), since this is the only graph representing a function that is differentiable at b but not at a .
14. Graph (a), since this is the only graph that represents a function that is not differentiable at a or b .

15. $f(x) = \frac{2}{3}x - 5 \Rightarrow f'(x) = \frac{2}{3} \Rightarrow$ no critical points;
 $f(-2) = -\frac{19}{3}, f(3) = -3 \Rightarrow$ the absolute maximum
 is -3 at $x = 3$ and the absolute minimum is $-\frac{19}{3}$ at
 $x = -2$

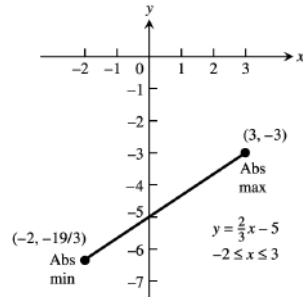

16. $f(x) = -x - 4 \Rightarrow f'(x) = -1 \Rightarrow$ no critical points;
 $f(-4) = 0, f(1) = -5 \Rightarrow$ the absolute maximum is 0
 at $x = -4$ and the absolute minimum is -5 at $x = 1$

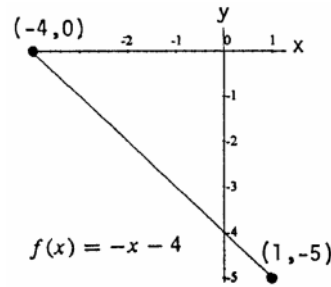

17. $f(x) = x^2 - 1 \Rightarrow f'(x) = 2x \Rightarrow$ a critical point at
 $x = 0; f(-1) = 0, f(0) = -1, f(2) = 3 \Rightarrow$ the absolute
 maximum is 3 at $x = 2$ and the absolute minimum is -1
 at $x = 0$

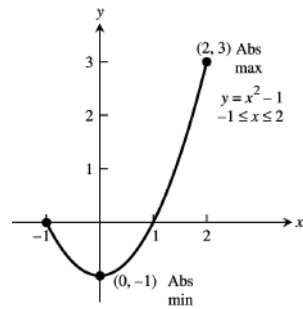

18. $f(x) = 4 - x^2 \Rightarrow f'(x) = -2x \Rightarrow$ a critical point at
 $x = 0; f(-3) = -5, f(0) = 4, f(1) = 3 \Rightarrow$ the absolute
 maximum is 4 at $x = 0$ and the absolute minimum is -5
 at $x = -3$

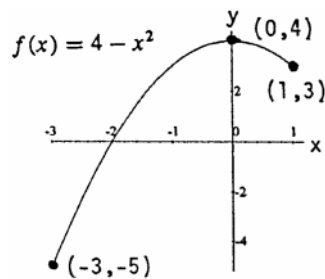

19. $F(x) = -\frac{1}{x^2} = -x^{-2} \Rightarrow F'(x) = 2x^{-3} = \frac{2}{x^3}$, however
 $x = 0$ is not a critical point since 0 is not in the domain;
 $F(0.5) = -4, F(2) = -0.25 \Rightarrow$ the absolute maximum is
 -0.25 at $x = 2$ and the absolute minimum is -4 at
 $x = 0.5$

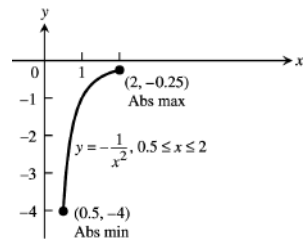

20. $F(x) = -\frac{1}{x} = -x^{-1} \Rightarrow F'(x) = x^{-2} = \frac{1}{x^2}$, however $x = 0$ is not a critical point since 0 is not in the domain; $F(-2) = \frac{1}{2}$, $F(-1) = 1 \Rightarrow$ the absolute maximum is 1 at $x = -1$ and the absolute minimum is $\frac{1}{2}$ at $x = -2$

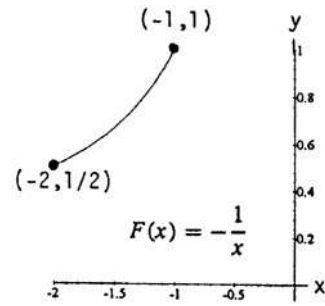

21. $h(x) = \sqrt[3]{x} = x^{1/3} \Rightarrow h'(x) = \frac{1}{3}x^{-2/3} \Rightarrow$ a critical point at $x = 0$; $h(-1) = -1$, $h(0) = 0$, $h(8) = 2 \Rightarrow$ the absolute maximum is 2 at $x = 8$ and the absolute minimum is -1 at $x = -1$

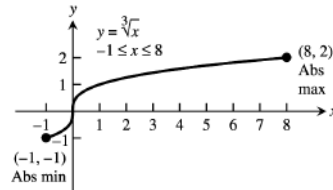

22. $h(x) = -3x^{2/3} \Rightarrow h'(x) = -2x^{-1/3} \Rightarrow$ a critical point at $x = 0$; $h(-1) = -3$, $h(0) = 0$, $h(1) = -3 \Rightarrow$ the absolute maximum is 0 at $x = 0$ and the absolute minimum is -3 at $x = 1$ and at $x = -1$

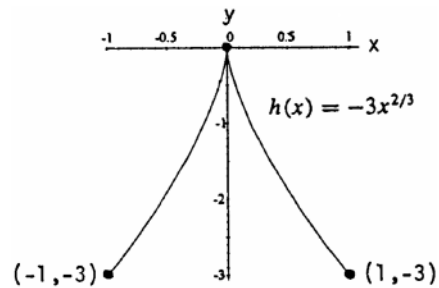

23. $g(x) = \sqrt{4-x^2} = (4-x^2)^{1/2} \Rightarrow g'(x) = \frac{1}{2}(4-x^2)^{-1/2}(-2x) = \frac{-x}{\sqrt{4-x^2}} \Rightarrow$ critical points at $x = -2$ and $x = 0$, but not at $x = 2$ because 2 is not in the domain; $g(-2) = 0$, $g(0) = 2$, $g(1) = \sqrt{3} \Rightarrow$ the absolute maximum is 2 at $x = 0$ and the absolute minimum is 0 at $x = -2$

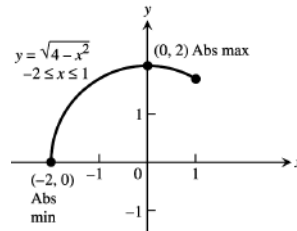

24. $g(x) = -\sqrt{5-x^2} = -(5-x^2)^{1/2} \Rightarrow g'(x) = -\left(\frac{x}{\sqrt{5-x^2}}\right) \Rightarrow$ critical points at $x = -\sqrt{5}$ and $x = 0$, but not at $x = \sqrt{5}$ because $\sqrt{5}$ is not in the domain; $f(-\sqrt{5}) = 0$, $f(0) = -\sqrt{5} \Rightarrow$ the absolute maximum is 0 at $x = -\sqrt{5}$ and the absolute minimum is $-\sqrt{5}$ at $x = 0$

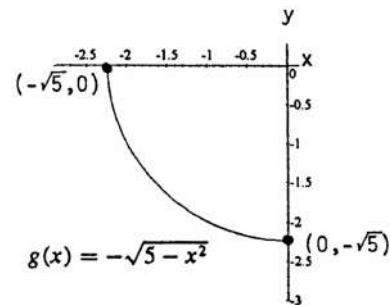

25. $f(\theta) = \sin \theta \Rightarrow f'(\theta) = \cos \theta \Rightarrow \theta = \frac{\pi}{2}$ is a critical point, but $\theta = \frac{-\pi}{2}$ is not a critical point because $\frac{-\pi}{2}$ is not interior to the domain; $f\left(\frac{-\pi}{2}\right) = -1$, $f\left(\frac{\pi}{2}\right) = 1$, $f\left(\frac{5\pi}{6}\right) = \frac{1}{2} \Rightarrow$ the absolute maximum is 1 at $\theta = \frac{\pi}{2}$ and the absolute minimum is -1 at $\theta = \frac{-\pi}{2}$

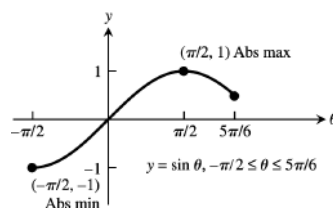

26. $f(\theta) = \tan \theta \Rightarrow f'(\theta) = \sec^2 \theta \Rightarrow f$ has no critical points in $(-\frac{\pi}{3}, \frac{\pi}{4})$. The extreme values therefore occur at the endpoints: $f(-\frac{\pi}{3}) = -\sqrt{3}$ and $f(\frac{\pi}{4}) = 1 \Rightarrow$ the absolute maximum is 1 at $\theta = \frac{\pi}{4}$ and the absolute minimum is $-\sqrt{3}$ at $\theta = -\frac{\pi}{3}$

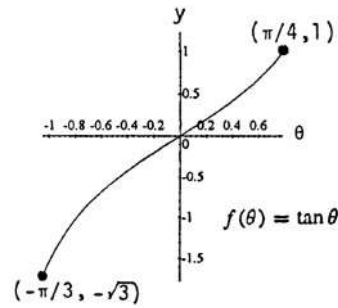

27. $g(x) = \csc x \Rightarrow g'(x) = -(\csc x)(\cot x) \Rightarrow$ a critical point at $x = \frac{\pi}{2}$; $g(\frac{\pi}{3}) = \frac{2}{\sqrt{3}}$, $g(\frac{\pi}{2}) = 1$, $g(\frac{2\pi}{3}) = \frac{2}{\sqrt{3}} \Rightarrow$ the absolute maximum is $\frac{2}{\sqrt{3}}$ at $x = \frac{\pi}{3}$ and $x = \frac{2\pi}{3}$, and the absolute minimum is 1 at $x = \frac{\pi}{2}$

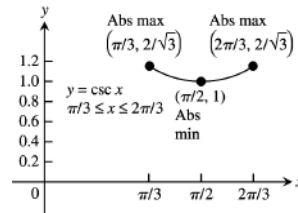

28. $g(x) = \sec x \Rightarrow g'(x) = (\sec x)(\tan x) \Rightarrow$ a critical point at $x = 0$; $g(-\frac{\pi}{3}) = 2$, $g(0) = 1$, $g(\frac{\pi}{6}) = \frac{2}{\sqrt{3}} \Rightarrow$ the absolute maximum is 2 at $x = -\frac{\pi}{3}$ and the absolute minimum is 1 at $x = 0$

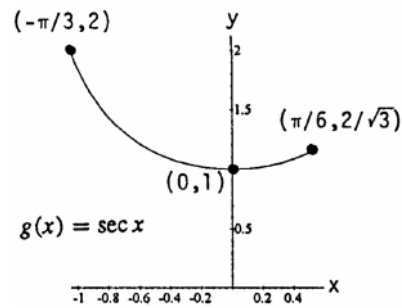

29. $f(t) = 2 - |t| = 2 - \sqrt{t^2} = 2 - (t^2)^{1/2}$
 $\Rightarrow f'(t) = -\frac{1}{2}(t^2)^{-1/2}(2t) = -\frac{t}{\sqrt{t^2}} = -\frac{t}{|t|}$
 \Rightarrow a critical point at $t = 0$; $f(-1) = 1$,
 $f(0) = 2$, $f(3) = -1 \Rightarrow$ the absolute maximum is 2 at $t = 0$
 and the absolute minimum is -1 at $t = 3$

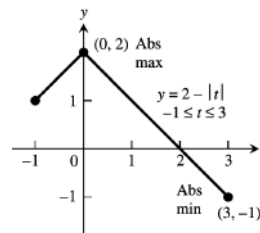

30. $f(t) = |t - 5| = \sqrt{(t - 5)^2} = ((t - 5)^2)^{1/2} \Rightarrow f'(t) = \frac{1}{2}((t - 5)^2)^{-1/2}(2(t - 5)) = \frac{t - 5}{\sqrt{(t - 5)^2}} = \frac{t - 5}{|t - 5|}$
 \Rightarrow a critical point at $t = 5$; $f(4) = 1$, $f(5) = 0$, $f(7) = 2$
 \Rightarrow the absolute maximum is 2 at $t = 7$ and the absolute minimum is 0 at $t = 5$

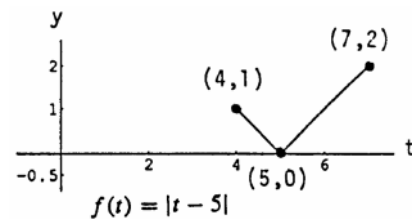

31. $f(x) = x^{4/3} \Rightarrow f'(x) = \frac{4}{3}x^{1/3} \Rightarrow$ a critical point at $x = 0$; $f(-1) = 1$, $f(0) = 0$, $f(8) = 16 \Rightarrow$ the absolute maximum is 16 at $x = 8$ and the absolute minimum is 0 at $x = 0$

32. $f(x) = x^{5/3} \Rightarrow f'(x) = \frac{5}{3}x^{2/3} \Rightarrow$ a critical point at $x = 0$; $f(-1) = -1$, $f(0) = 0$, $f(8) = 32 \Rightarrow$ the absolute maximum is 32 at $x = 8$ and the absolute minimum is -1 at $x = -1$

33. $g(\theta) = \theta^{3/5} \Rightarrow g'(\theta) = \frac{3}{5}\theta^{-2/5} \Rightarrow$ a critical point at $\theta = 0$; $g(-32) = -8$, $g(0) = 0$, $g(1) = 1 \Rightarrow$ the absolute maximum is 1 at $\theta = 1$ and the absolute minimum is -8 at $\theta = -32$

34. $h(\theta) = 3\theta^{2/3} \Rightarrow h'(\theta) = 2\theta^{-1/3} \Rightarrow$ a critical point at $\theta = 0$; $h(-27) = 27$, $h(0) = 0$, $h(8) = 12 \Rightarrow$ the absolute maximum is 27 at $\theta = -27$ and the absolute minimum is 0 at $\theta = 0$

35. Minimum value is 1 at $x = 2$.

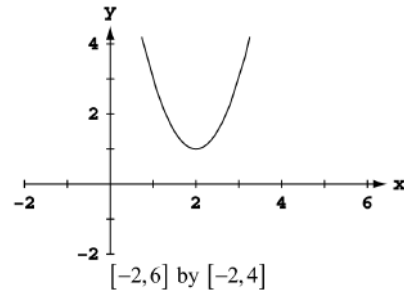

36. To find the exact values, note that $y' = 3x^2 - 2$, which is zero when $x = \pm\sqrt{\frac{2}{3}}$. Local maximum at $(-\sqrt{\frac{2}{3}}, 4 + \frac{4\sqrt{6}}{9}) \approx (-0.816, 5.089)$; local minimum at $(\sqrt{\frac{2}{3}}, 4 - \frac{4\sqrt{6}}{9}) \approx (0.816, 2.911)$

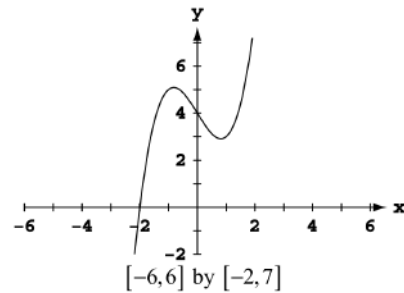

37. To find the exact values, note that $y' = 3x^2 + 2x - 8 = (3x - 4)(x + 2)$, which is zero when $x = -2$ or $x = \frac{4}{3}$. Local maximum at $(-2, 17)$; local minimum at $(\frac{4}{3}, -\frac{41}{27})$

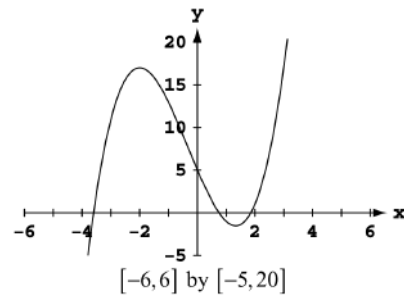

38. Note that $y' = 3x^2 - 6x + 3 = 3(x - 1)^2$, which is zero at $x = 1$. The graph shows that the function assumes lower values to the left and higher values to the right of this point, so the function has no local or global extreme values.

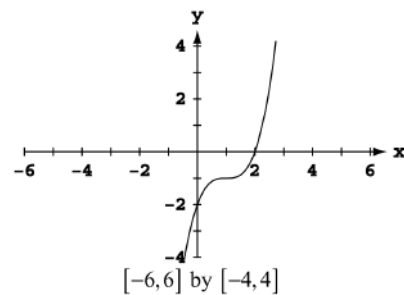

39. Minimum value is 0 when $x = -1$ or $x = 1$.

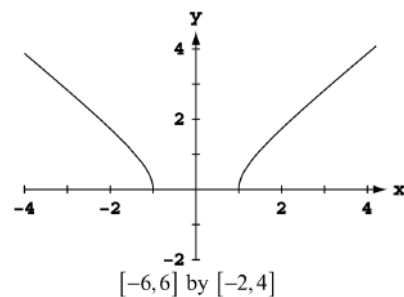

40. The minimum value is 1 at $x = 0$.

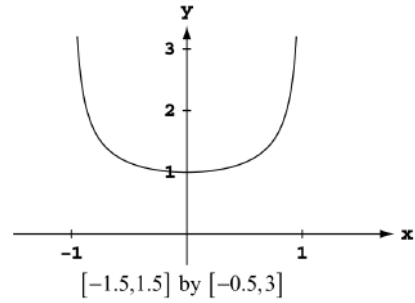

41. The actual graph of the function has asymptotes at $x = \pm 1$, so there are no extrema near these values. (This is an example of grapher failure.) There is a local minimum at $(0, 1)$.

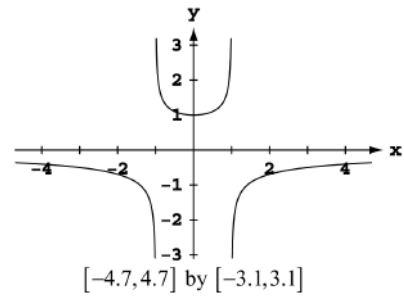

42. Maximum value is 2 at $x = 1$;
minimum value is 0 at $x = -1$ and $x = 3$.

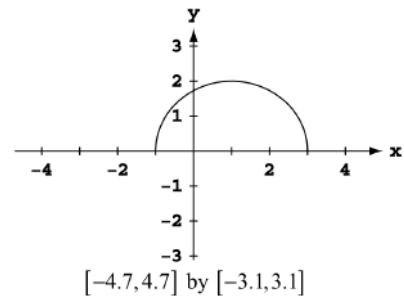

43. Maximum value is $\frac{1}{2}$ at $x = 1$;
minimum value is $-\frac{1}{2}$ at $x = -1$.

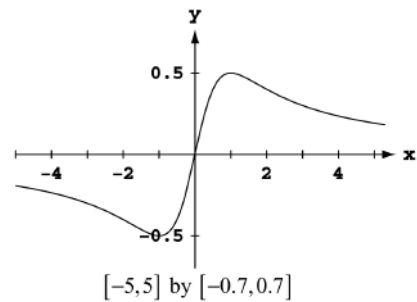

44. Maximum value is $\frac{1}{2}$ at $x = 0$;
minimum value is $-\frac{1}{2}$ at $x = -2$.

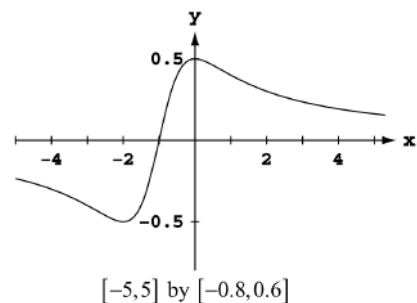

$$45. y' = x^{2/3}(1) + \frac{2}{3}x^{-1/3}(x+2) = \frac{5x+4}{3\sqrt[3]{x}}$$

crit. pt.	derivative	extremum	value
$x = -\frac{4}{5}$	0	local max	$\frac{12}{25}10^{1/3} \approx 1.034$
$x = 0$	undefined	local min	0

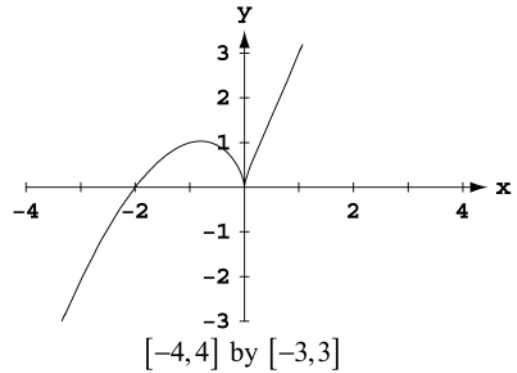

$$46. y' = x^{2/3}(2x) + \frac{2}{3}x^{-1/3}(x^2 - 4) = \frac{8x^2 - 8}{3\sqrt[3]{x}}$$

crit. pt.	derivative	extremum	value
$x = -1$	0	minimum	-3
$x = 0$	undefined	local max	0
$x = 1$	0	minimum	3

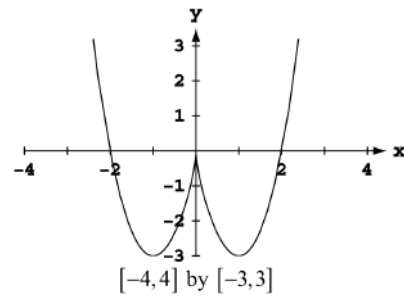

$$47. y' = x \frac{1}{2\sqrt{4-x^2}}(-2x) + (1)\sqrt{4-x^2}$$

$$= \frac{-x^2 + (4-x^2)}{\sqrt{4-x^2}} = \frac{4-2x^2}{\sqrt{4-x^2}}$$

crit. pt.	derivative	extremum	value
$x = -2$	undefined	local max	0
$x = -\sqrt{2}$	0	minimum	-2
$x = \sqrt{2}$	0	maximum	2
$x = 2$	undefined	local min	0

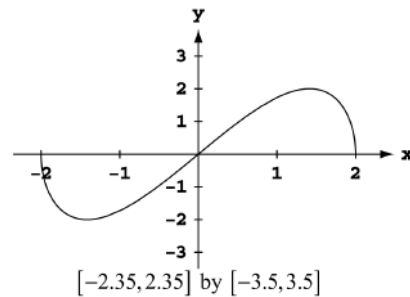

$$48. y' = x^2 \frac{1}{2\sqrt{3-x}}(-1) + 2x\sqrt{3-x}$$

$$= \frac{-x^2 + (4x)(3-x)}{2\sqrt{3-x}} = \frac{5x^2 + 12x}{2\sqrt{3-x}}$$

crit. pt.	derivative	extremum	value
$x = 0$	0	minimum	0
$x = \frac{12}{5}$	0	local max	$\frac{144}{125}15^{1/2} \approx 4.462$
$x = 3$	undefined	minimum	0

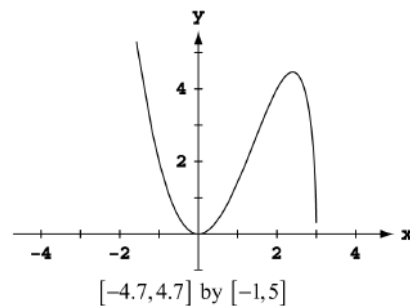

$$49. y' = \begin{cases} -2, & x < 1 \\ 1, & x > 1 \end{cases}$$

crit. pt.	derivative	extremum	value
$x = 1$	undefined	minimum	2

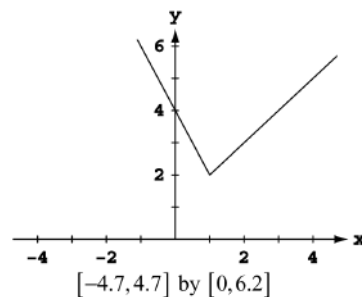

$$50. y' = \begin{cases} -1, & x < 0 \\ 2 - 2x, & x > 0 \end{cases}$$

crit. pt.	derivative	extremum	value
$x = 0$	undefined	local min	3
$x = 1$	0	local max	4

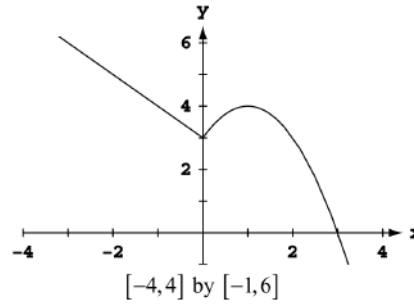

$$51. y' = \begin{cases} -2x - 2, & x < 1 \\ -2x + 6, & x > 1 \end{cases}$$

crit. pt.	derivative	extremum	value
$x = -1$	0	maximum	5
$x = 1$	undefined	local min	1
$x = 3$	0	maximum	5

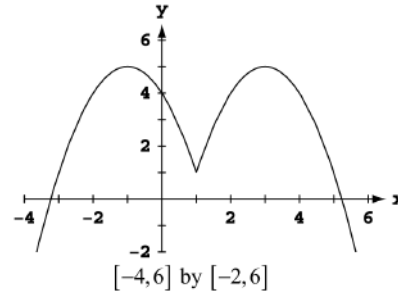

52. We begin by determining whether $f'(x)$ is defined at $x = 1$, where $f(x) = \begin{cases} -\frac{1}{4}x^2 - \frac{1}{2}x + \frac{15}{4}, & x \leq 1 \\ x^3 - 6x^2 + 8x, & x > 1 \end{cases}$

Clearly, $f'(x) = -\frac{1}{2}x - \frac{1}{2}$ if $x < 1$, and $\lim_{h \rightarrow 0^-} f'(1+h) = -1$. Also, $f'(x) = 3x^2 - 12x + 8$ if $x > 1$, and

$\lim_{h \rightarrow 0^+} f'(1+h) = -1$. Since f is continuous at $x = 1$, we have that $f'(1) = -1$. Thus,

$$f'(x) = \begin{cases} -\frac{1}{2}x - \frac{1}{2}, & x \leq 1 \\ 3x^2 - 12x + 8, & x > 1 \end{cases}$$

Note that $-\frac{1}{2}x - \frac{1}{2} = 0$ when $x = -1$, and $3x^2 - 12x + 8 = 0$ when $x = \frac{12 \pm \sqrt{12^2 - 4(3)(8)}}{2(3)} = \frac{12 \pm \sqrt{48}}{6} = 2 \pm \frac{2\sqrt{3}}{3}$.

But $2 - \frac{2\sqrt{3}}{3} \approx 0.845 < 1$, so the critical points occur at $x = -1$ and $x = 2 + \frac{2\sqrt{3}}{3} \approx 3.155$.

crit. pt.	derivative	extremum	value
$x = -1$	0	local max	4
$x \approx 3.155$	0	local min	≈ -3.079

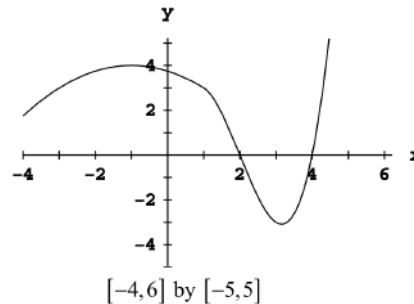

53. (a) No, since $f'(x) = \frac{2}{3}(x-2)^{-1/3}$, which is undefined at $x = 2$.

(b) The derivative is defined and nonzero for all $x \neq 2$. Also, $f(2) = 0$ and $f(x) > 0$ for all $x \neq 2$.

(c) No, $f(x)$ need not have a global maximum because its domain is all real numbers. Any restriction of f to a closed interval of the form $[a, b]$ would have both a maximum value and minimum value on the interval.

(d) The answers are the same as (a) and (b) with 2 replaced by a.

54. Note that $f(x) = \begin{cases} -x^3 + 9x, & x \leq -3 \text{ or } 0 \leq x < 3 \\ x^3 - 9x, & -3 < x < 0 \text{ or } x \geq 3 \end{cases}$. Therefore, $f'(x) = \begin{cases} -3x^2 + 9, & x < -3 \text{ or } 0 < x < 3 \\ 3x^2 - 9, & -3 < x < 0 \text{ or } x > 3 \end{cases}$

(a) No, since the left- and right-hand derivatives at $x = 0$, are -9 and 9 , respectively.

(b) No, since the left- and right-hand derivatives at $x = 3$, are -18 and 18 , respectively.

- (c) No, since the left- and right-hand derivatives at $x = -3$, are 18 and -18 , respectively.
- (d) The critical points occur when $f'(x) = 0$ (at $x = \pm\sqrt{3}$) and when $f'(x)$ is undefined (at $x = 0$ and $x = \pm 3$). The minimum value is 0 at $x = -3$, at $x = 0$, and at $x = 3$; local maxima occur at $(-\sqrt{3}, 6\sqrt{3})$ and $(\sqrt{3}, 6\sqrt{3})$.

55.

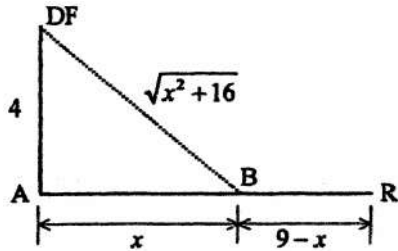

- (a) The construction cost is $C(x) = 0.3\sqrt{16 + x^2} + 0.2(9 - x)$ million dollars, where $0 \leq x \leq 9$ miles. The following is a graph of $C(x)$.

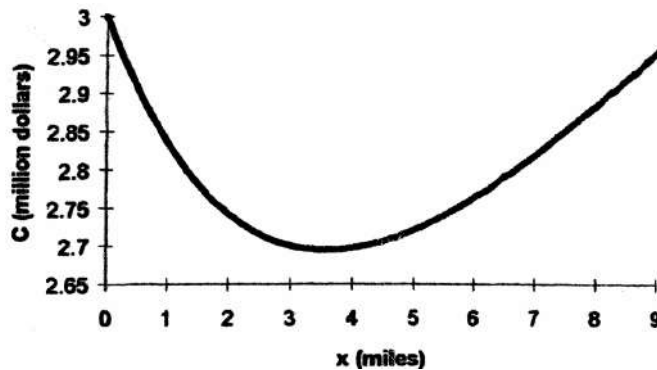

Solving $C'(x) = \frac{0.3x}{\sqrt{16+x^2}} - 0.2 = 0$ gives $x = \pm \frac{8\sqrt{5}}{5} \approx \pm 3.58$ miles, but only $x = 3.58$ miles is a critical point in the specified domain. Evaluating the costs at the critical and endpoints gives $C(0) = \$3$ million, $C\left(\frac{8\sqrt{5}}{5}\right) \approx \2.694 million, and $C(9) \approx \$2.955$ million. Therefore, to minimize the cost of construction, the pipeline should be placed from the docking facility to point B, 3.58 miles along the shore from point A, and then along the shore from B to the refinery.

- (b) If the per mile cost of underwater construction is p , then $C(x) = p\sqrt{16 + x^2} + 0.2(9 - x)$ and $C'(x) = \frac{0.3x}{\sqrt{16+x^2}} - 0.2 = 0$ gives $x_c = \frac{0.8}{\sqrt{p^2 - 0.04}}$, which minimizes the construction cost provided $x_c \leq 9$. The value of p that gives $x_c = 9$ miles is 0.218864. Consequently, if the underwater construction costs \$218,864 per mile or less, then running the pipeline along a straight line directly from the docking facility to the refinery will minimize the cost of construction.

In theory, p would have to be infinite to justify running the pipe directly from the docking facility to point A (i.e., for x_c to be zero). For all values of $p > 0.218864$ there is always an $x_c \in (0, 9)$ that will give a minimum value for C .

This is proved by looking at $C''(x_c) = \frac{16p}{(16+x_c^2)^{3/2}}$ which is always positive for $p > 0$.

56. There are two options to consider. The first is to build a new road straight from Village A to Village B. The second is to build a new highway segment from Village A to the Old Road, reconstruct a segment of Old Road, and build a new highway segment from Old Road to Village B, as shown in the figure. The cost of the first option is $C_1 = 0.5(150)$ million dollars = 75 million dollars.

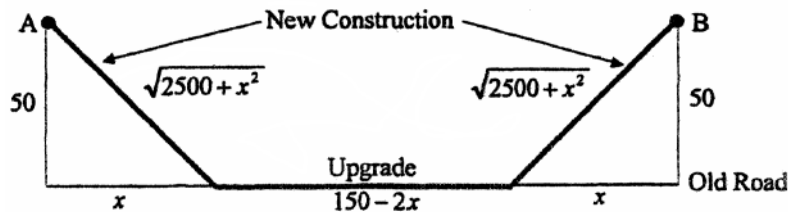

The construction cost for the second option is $C_2(x) = 0.5(2\sqrt{2500 + x^2}) + 0.3(150 - 2x)$ million dollars for $0 \leq x \leq 75$ miles. The following is a graph of $C_2(x)$.

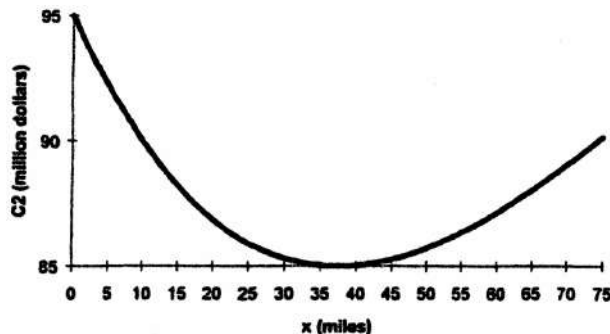

Solving $C'_2(x) = \frac{x}{\sqrt{2500 + x^2}} - 0.6 = 0$ give $x = \pm 37.5$ miles, but only $x = 37.5$ miles is in the specified domain. In summary, $C_1 = \$75$ million, $C_2(0) = \$95$ million, $C_2(37.5) = \$85$ million, and $C_2(75) = \$90.139$ million. Consequently, a new road straight from village A to village B is the least expensive option.

57.

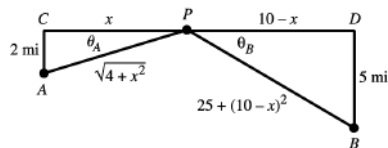

The length of pipeline is $L(x) = \sqrt{4 + x^2} + \sqrt{25 + (10 - x)^2}$ for $0 \leq x \leq 10$. The following is a graph of $L(x)$.

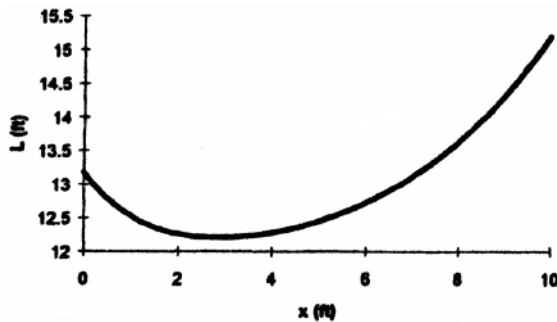

Setting the derivative of $L(x)$ equal to zero gives $L'(x) = \frac{x}{\sqrt{4 + x^2}} - \frac{(10 - x)}{\sqrt{25 + (10 - x)^2}} = 0$. Note that $\frac{x}{\sqrt{4 + x^2}} = \cos \theta_A$ and $\frac{10 - x}{\sqrt{25 + (10 - x)^2}} = \cos \theta_B$, therefore, $L'(x) = 0$ when $\cos \theta_A = \cos \theta_B$, or $\theta_A = \theta_B$ and $\triangle ACP$ is similar to $\triangle BDP$. Use simple proportions to determine x as follows: $\frac{x}{2} = \frac{10 - x}{5} \Rightarrow x = \frac{20}{7} \approx 2.857$ miles along the coast from town A to town B. If the two towns were on opposite sides of the river, the obvious solution would be to place the pump station on a straight line (the shortest distance) between two towns, again forcing $\theta_A = \theta_B$. The shortest length of pipe is the same regardless of whether the towns are on the same or opposite sides of the river.

58.

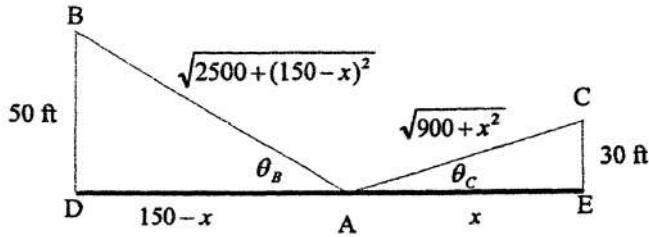

- (a) The length of guy wire is $L(x) = \sqrt{900 + x^2} + \sqrt{2500 + (150 - x)^2}$ for $0 \leq x \leq 150$. The following is a graph of $L(x)$.

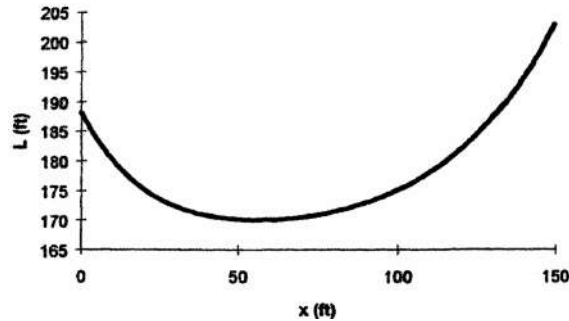

Setting $L'(x)$ equal to zero gives $L'(x) = \frac{x}{\sqrt{900 + x^2}} - \frac{(150 - x)}{\sqrt{2500 + (150 - x)^2}} = 0$. Note that $\frac{x}{\sqrt{900 + x^2}} = \cos \theta_A$ and $\frac{(150 - x)}{\sqrt{2500 + (150 - x)^2}} = \cos \theta_B$. Therefore, $L'(x) = 0$ when $\cos \theta_A = \cos \theta_B$, or $\theta_A = \theta_B$ and $\triangle ACE$ is similar to $\triangle ABD$.

Use simple proportions to determine x : $\frac{x}{30} = \frac{150 - x}{50} \Rightarrow x = \frac{225}{4} = 56.25$ feet.

- (b) If the heights of the towers are h_B and h_C , and the horizontal distance between them is s , then

$L(x) = \sqrt{h_C^2 + x^2} + \sqrt{h_B^2 + (s - x)^2}$ and $L'(x) = \frac{x}{\sqrt{h_C^2 + x^2}} - \frac{(s - x)}{\sqrt{h_B^2 + (s - x)^2}}$. However, $\frac{x}{\sqrt{h_C^2 + x^2}} = \cos \theta_C$ and

$\frac{(s - x)}{\sqrt{h_B^2 + (s - x)^2}} = \cos \theta_B$. Therefore, $L'(x) = 0$ when $\cos \theta_C = \cos \theta_B$, or $\theta_C = \theta_B$ and $\triangle ACE$ is similar to $\triangle ABD$.

Simple proportions can again be used to determine the optimum x : $\frac{x}{h_C} = \frac{s - x}{h_B} \Rightarrow x = \left(\frac{h_C}{h_B + h_C} \right) s$.

59. (a) $V(x) = 160x - 52x^2 + 4x^3$

$$V'(x) = 160 - 104x + 12x^2 = 4(x - 2)(3x - 20)$$

The only critical point in the interval $(0, 5)$ is at $x = 2$. The maximum value of $V(x)$ is 144 at $x = 2$.

- (b) The largest possible volume of the box is 144 cubic units, and it occurs when $x = 2$ units.

60. (a) $P'(x) = 2 - 200x^{-2}$

The only critical point in the interval $(0, \infty)$ is at $x = 10$. The minimum value of $P(x)$ is 40 at $x = 10$.

- (b) The smallest possible perimeter of the rectangle is 40 units and it occurs at $x = 10$ units which makes the rectangle a 10 by 10 square.

61. Let x represent the length of the base and $\sqrt{25 - x^2}$ the height of the triangle. The area of the triangle is represented by

$A(x) = \frac{x}{2} \sqrt{25 - x^2}$ where $0 \leq x \leq 5$. Consequently, solving $A'(x) = 0 \Rightarrow \frac{25 - 2x^2}{2\sqrt{25 - x^2}} = 0 \Rightarrow x = \frac{5}{\sqrt{2}}$. Since

$A(0) = A(5) = 0$, $A(x)$ is maximized at $x = \frac{5}{\sqrt{2}}$. The largest possible area is $A\left(\frac{5}{\sqrt{2}}\right) = \frac{25}{4} \text{ cm}^2$.

62. (a) From the diagram the perimeter $P = 2x + 2\pi r = 400$

$$\Rightarrow x = 200 - \pi r. \text{ The area } A \text{ is } 2rx$$

$$\Rightarrow A(r) = 400r - 2\pi r^2 \text{ where } 0 \leq r \leq \frac{200}{\pi}.$$

(b) $A'(r) = 400 - 4\pi r$ so the only critical point is $r = \frac{100}{\pi}$.

Since $A(r) = 0$ if $r = 0$ and $x = 200 - \pi r = 0$, the values $r = \frac{100}{\pi} \approx 31.83$ m and $x = 100$ m maximize the area over the interval $0 \leq r \leq \frac{200}{\pi}$.

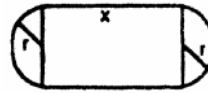

63. $s = -\frac{1}{2}gt^2 + v_0t + s_0 \Rightarrow \frac{ds}{dt} = -gt + v_0 = 0 \Rightarrow t = \frac{v_0}{g}$. Now $s(t) = s_0 \Leftrightarrow t(-\frac{gt}{2} + v_0) = 0 \Leftrightarrow t = 0$ or $t = \frac{2v_0}{g}$.

Thus $s\left(\frac{v_0}{g}\right) = -\frac{1}{2}g\left(\frac{v_0}{g}\right)^2 + v_0\left(\frac{v_0}{g}\right) + s_0 = \frac{v_0^2}{2g} + s_0 > s_0$ is the maximum height over the interval $0 \leq t \leq \frac{2v_0}{g}$.

64. $\frac{di}{dt} = -2\sin t + 2\cos t$, solving $\frac{di}{dt} = 0 \Rightarrow \tan t = 1 \Rightarrow t = \frac{\pi}{4} + n\pi$ where n is a nonnegative integer (in this exercise t is never negative) \Rightarrow the peak current is $2\sqrt{2}$ amps.

65. Yes, since $f(x) = |x| = \sqrt{x^2} = (x^2)^{1/2} \Rightarrow f'(x) = \frac{1}{2}(x^2)^{-1/2}(2x) = \frac{x}{(x^2)^{1/2}} = \frac{x}{|x|}$ is not defined at $x = 0$. Thus it is not required that f' be zero at a local extreme point since f' may be undefined there.

66. If $f(c)$ is a local maximum value of f , then $f(x) \leq f(c)$ for all x in some open interval (a, b) containing c . Since f is even, $f(-x) = f(x) \leq f(c) = f(-c)$ for all $-x$ in the open interval $(-b, -a)$ containing $-c$. That is, f assumes a local maximum at the point $-c$. This is also clear from the graph of f because the graph of an even function is symmetric about the y -axis.

67. If $g(c)$ is a local minimum value of g , then $g(x) \geq g(c)$ for all x in some open interval (a, b) containing c . Since g is odd, $g(-x) = -g(x) \leq -g(c) = g(-c)$ for all $-x$ in the open interval $(-b, -a)$ containing $-c$. That is, g assumes a local maximum at the point $-c$. This is also clear from the graph of g because the graph of an odd function is symmetric about the origin.

68. If there are no boundary points or critical points the function will have no extreme values in its domain. Such functions do indeed exist, for example $f(x) = x$ for $-\infty < x < \infty$. (Any other linear function $f(x) = mx + b$ with $m \neq 0$ will do as well.)

69. (a) $f'(x) = 3ax^2 + 2bx + c$ is a quadratic, so it can have 0, 1, or 2 zeros, which would be the critical points of f . The function $f(x) = x^3 - 3x$ has two critical points at $x = -1$ and $x = 1$. The function $f(x) = x^3 - 1$ has one critical point at $x = 0$. The function $f(x) = x^3 + x$ has no critical points.

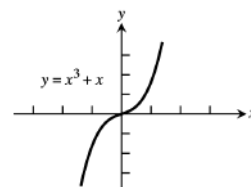
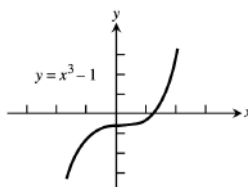
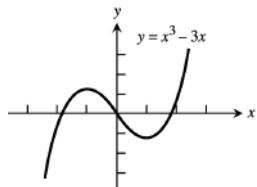

(b) The function can have either two local extreme values or no extreme values. (If there is only one critical point, the cubic function has no extreme values.)

70. (a)

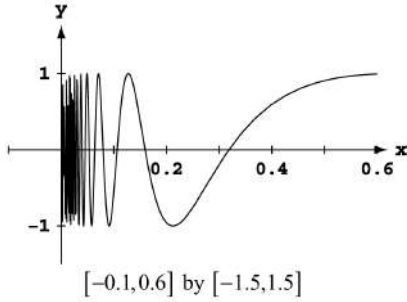

$f(0) = 0$ is not a local extreme value because in any open interval containing $x = 0$, there are infinitely many points where $f(x) = 1$ and where $f(x) = -1$.

(b) One possible answer, on the interval $[0, 1]$:

$$f(x) = \begin{cases} (1-x)\cos \frac{1}{1-x}, & 0 \leq x < 1 \\ 0, & x = 1 \end{cases}$$

This function has no local extreme value at $x = 1$. Note that it is continuous on $[0, 1]$.

71. Maximum value is 11 at $x = 5$;
 minimum value is 5 on the interval $[-3, 2]$;
 local maximum at $(-5, 9)$

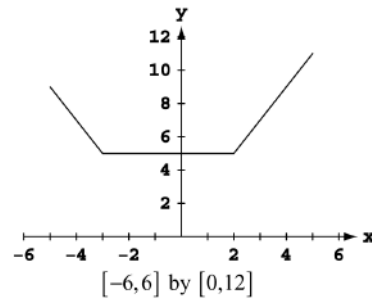

72. Maximum value is 4 on the interval $[5, 7]$;
 minimum value is -4 on the interval $[-2, 1]$.

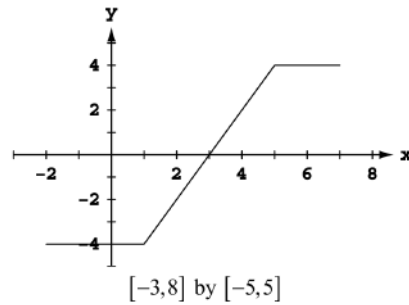

73. Maximum value is 5 on the interval $[3, \infty)$;
 minimum value is -5 on the interval $(-\infty, -2]$.

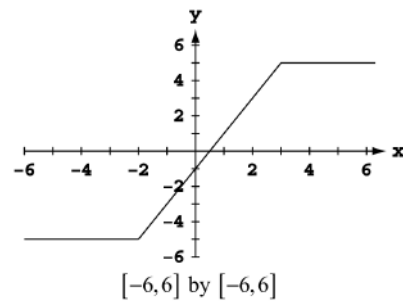

74. Minimum value is 4 on the interval $[-1, 3]$

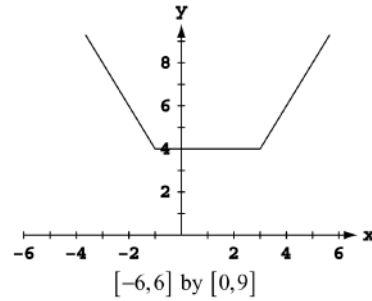

75-80. Example CAS commands:

Maple:

```
with(student):
f := x -> x^4 - 8*x^2 + 4*x + 2;
domain := x=-20/25..64/25;
plot( f(x), domain, color=black, title="Section 4.1 #75(a)" );
Df := D(f);
plot( Df(x), domain, color=black, title="Section 4.1 # 75(b)" )
StatPt := fsolve( Df(x)=0, domain )
SingPt := NULL;
EndPt := op(rhs(domain));
Pts :=evalf([EndPt,StatPt,SingPt]);
Values := [seq( f(x), x=Pts )];
```

Maximum value is 2.7608 and occurs at $x=2.56$ (right endpoint).

Minimum value 3^4 is -6.2680 and occurs at $x=1.86081$ (singular point).

Mathematica: (functions may vary) (see section 2.5 re. RealsOnly):

```
<<Miscellaneous`RealOnly`
Clear[f,x]
a = -1; b = 10/3;
f[x_] = 2 + 2x - 3 x^(2/3)
f[x]
Plot[{f[x], f'[x]}, {x, a, b}]
NSolve[f'[x]==0, x]
{f[a], f[0], f[x]/.%, f[b]}/N
```

In more complicated expressions, NSolve may not yield results. In this case, an approximate solution (say 1.1 here) is observed from the graph and the following command is used:

```
FindRoot[f'[x]==0, {x, 1.1}]
```

4.2 THE MEAN VALUE THEOREM

- When $f(x) = x^2 + 2x - 1$ for $0 \leq x \leq 1$, then $\frac{f(1)-f(0)}{1-0} = f'(c) \Rightarrow 3 = 2c + 2 \Rightarrow c = \frac{1}{2}$.
- When $f(x) = x^{2/3}$ for $0 \leq x \leq 1$, then $\frac{f(1)-f(0)}{1-0} = f'(c) \Rightarrow 1 = \left(\frac{2}{3}\right) c^{-1/3} \Rightarrow c = \frac{8}{27}$.
- When $f(x) = x + \frac{1}{x}$ for $\frac{1}{2} \leq x \leq 2$, then $\frac{f(2)-f(1/2)}{2-1/2} = f'(c) \Rightarrow 0 = 1 - \frac{1}{c^2} \Rightarrow c = 1$.
- When $f(x) = \sqrt{x-1}$ for $1 \leq x \leq 3$, then $\frac{f(3)-f(1)}{3-1} = f'(c) \Rightarrow \frac{\sqrt{2}}{2} = \frac{1}{2\sqrt{c-1}} \Rightarrow c = \frac{3}{2}$.
- Does not; $f(x)$ is not differentiable at $x = 0$ in $(-1, 8)$.

6. Does; $f(x)$ is continuous for every point of $[0, 1]$ and differentiable for every point in $(0, 1)$.
7. Does; $f(x)$ is continuous for every point of $[0, 1]$ and differentiable for every point in $(0, 1)$.
8. Does not; $f(x)$ is not continuous at $x = 0$ because $\lim_{x \rightarrow 0^-} f(x) = 1 \neq 0 = f(0)$.
9. Since $f(x)$ is not continuous on $0 \leq x \leq 1$, Rolle's Theorem does not apply: $\lim_{x \rightarrow 1^-} f(x) = \lim_{x \rightarrow 1^-} x = 1 \neq 0 = f(1)$.
10. Since $f(x)$ must be continuous at $x = 0$ and $x = 1$ we have $\lim_{x \rightarrow 0^+} f(x) = a = f(0) \Rightarrow a = 3$ and $\lim_{x \rightarrow 1^-} f(x) = \lim_{x \rightarrow 1^+} f(x) \Rightarrow -1 + 3 + a = m + b \Rightarrow 5 = m + b$. Since $f(x)$ must also be differentiable at $x = 1$ we have $\lim_{x \rightarrow 1^-} f'(x) = \lim_{x \rightarrow 1^+} f'(x) \Rightarrow -2x + 3|_{x=1} = m|_{x=1} \Rightarrow 1 = m$. Therefore, $a = 3$, $m = 1$ and $b = 4$.

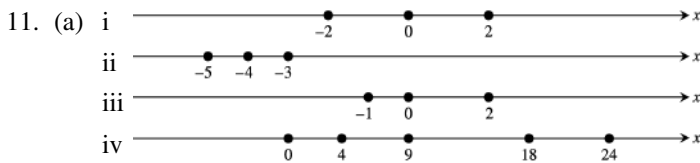

- (b) Let r_1 and r_2 be zeros of the polynomial $P(x) = x^n + a_{n-1}x^{n-1} + \dots + a_1x + a_0$, then $P(r_1) = P(r_2) = 0$. Since polynomials are everywhere continuous and differentiable, by Rolle's Theorem $P'(r) = 0$ for some r between r_1 and r_2 , where $P'(x) = nx^{n-1} + (n-1)a_{n-1}x^{n-2} + \dots + a_1$.
12. With f both differentiable and continuous on $[a, b]$ and $f(r_1) = f(r_2) = f(r_3) = 0$ where r_1, r_2 and r_3 are in $[a, b]$, then by Rolle's Theorem there exists a c_1 between r_1 and r_2 such that $f'(c_1) = 0$ and a c_2 between r_2 and r_3 such that $f'(c_2) = 0$. Since f' is both differentiable and continuous on $[a, b]$, Rolle's Theorem again applies and we have a c_3 between c_1 and c_2 such that $f''(c_3) = 0$. To generalize, if f has $n+1$ zeros in $[a, b]$ and $f^{(n)}$ is continuous on $[a, b]$, then $f^{(n)}$ has at least one zero between a and b .
13. Since f'' exists throughout $[a, b]$ the derivative function f' is continuous there. If f' has more than one zero in $[a, b]$, say $f'(r_1) = f'(r_2) = 0$ for $r_1 \neq r_2$, then by Rolle's Theorem there is a c between r_1 and r_2 such that $f''(c) = 0$, contrary to $f'' > 0$ throughout $[a, b]$. Therefore f' has at most one zero in $[a, b]$. The same argument holds if $f'' < 0$ throughout $[a, b]$.
14. If $f(x)$ is a cubic polynomial with four or more zeros, then by Rolle's Theorem $f'(x)$ has three or more zeros, $f''(x)$ has 2 or more zeros and $f'''(x)$ has at least one zero. This is a contradiction since $f'''(x)$ is a non-zero constant when $f(x)$ is a cubic polynomial.
15. With $f(-2) = 11 > 0$ and $f(-1) = -1 < 0$ we conclude from the Intermediate Value Theorem that $f(x) = x^4 + 3x + 1$ has at least one zero between -2 and -1 . Then $-2 < x < -1 \Rightarrow -8 < x^3 < -1 \Rightarrow -32 < 4x^3 < -4 \Rightarrow -29 < 4x^3 + 3 < -1 \Rightarrow f'(x) < 0$ for $-2 < x < -1 \Rightarrow f(x)$ is decreasing on $[-2, -1] \Rightarrow f(x) = 0$ has exactly one solution in the interval $(-2, -1)$.
16. $f(x) = x^3 + \frac{4}{x^2} + 7 \Rightarrow f'(x) = 3x^2 - \frac{8}{x^3} > 0$ on $(-\infty, 0) \Rightarrow f(x)$ is increasing on $(-\infty, 0)$. Also, $f(x) < 0$ if $x < -2$ and $f(x) > 0$ if $-2 < x < 0 \Rightarrow f(x)$ has exactly one zero in $(-\infty, 0)$.
17. $g(t) = \sqrt{t} + \sqrt{t+1} - 4 \Rightarrow g'(t) = \frac{1}{2\sqrt{t}} + \frac{1}{2\sqrt{t+1}} > 0 \Rightarrow g(t)$ is increasing for t in $(0, \infty)$; $g(3) = \sqrt{3} - 2 < 0$ and $g(15) = \sqrt{15} > 0 \Rightarrow g(t)$ has exactly one zero in $(0, \infty)$.

212 Chapter 4 Applications of Derivatives

18. $g(t) = \frac{1}{1-t} + \sqrt{1+t} - 3.1 \Rightarrow g'(t) = \frac{1}{(1-t)^2} + \frac{1}{2\sqrt{1+t}} > 0 \Rightarrow g(t)$ is increasing for t in $(-1, 1)$;
 $g(-0.99) = -2.5$ and $g(0.99) = 98.3 \Rightarrow g(t)$ has exactly one zero in $(-1, 1)$.

19. $r(\theta) = \theta + \sin^2\left(\frac{\theta}{3}\right) - 8 \Rightarrow r'(\theta) = 1 + \frac{2}{3} \sin\left(\frac{\theta}{3}\right) \cos\left(\frac{\theta}{3}\right) = 1 + \frac{1}{3} \sin\left(\frac{2\theta}{3}\right) > 0$ on $(-\infty, \infty) \Rightarrow r(\theta)$ is increasing on $(-\infty, \infty)$; $r(0) = -8$ and $r(8) = \sin^2\left(\frac{8}{3}\right) > 0 \Rightarrow r(\theta)$ has exactly one zero in $(-\infty, \infty)$.

20. $r(\theta) = 2\theta - \cos^2\theta + \sqrt{2} \Rightarrow r'(\theta) = 2 + 2\sin\theta\cos\theta = 2 + \sin 2\theta > 0$ on $(-\infty, \infty) \Rightarrow r(\theta)$ is increasing on $(-\infty, \infty)$; $r(-2\pi) = -4\pi - \cos(-2\pi) + \sqrt{2} = -4\pi - 1 + \sqrt{2} < 0$ and $r(2\pi) = 4\pi - 1 + \sqrt{2} > 0 \Rightarrow r(\theta)$ has exactly one zero in $(-\infty, \infty)$.

21. $r(\theta) = \sec\theta - \frac{1}{\theta^3} + 5 \Rightarrow r'(\theta) = (\sec\theta)(\tan\theta) + \frac{3}{\theta^4} > 0$ on $(0, \frac{\pi}{2}) \Rightarrow r(\theta)$ is increasing on $(0, \frac{\pi}{2})$;
 $r(0.1) \approx -994$ and $r(1.57) \approx 1260.5 \Rightarrow r(\theta)$ has exactly one zero in $(0, \frac{\pi}{2})$.

22. $r(\theta) = \tan\theta - \cot\theta - \theta \Rightarrow r'(\theta) = \sec^2\theta + \csc^2\theta - 1 = \sec^2\theta + \cot^2\theta > 0$ on $(0, \frac{\pi}{2}) \Rightarrow r(\theta)$ is increasing on $(0, \frac{\pi}{2})$; $r(\frac{\pi}{4}) = -\frac{\pi}{4} < 0$ and $r(1.57) \approx 1254.2 \Rightarrow r(\theta)$ has exactly one zero in $(0, \frac{\pi}{2})$.

23. By Corollary 1, $f'(x) = 0$ for all $x \Rightarrow f(x) = C$, where C is a constant. Since $f(-1) = 3$ we have $C = 3 \Rightarrow f(x) = 3$ for all x .

24. $g(x) = 2x + 5 \Rightarrow g'(x) = 2 = f'(x)$ for all x . By Corollary 2, $f(x) = g(x) + C$ for some constant C . Then $f(0) = g(0) + C \Rightarrow 5 = 5 + C \Rightarrow C = 0 \Rightarrow f(x) = g(x) = 2x + 5$ for all x .

25. $g(x) = x^2 \Rightarrow g'(x) = 2x = f'(x)$ for all x . By Corollary 2, $f(x) = g(x) + C$.

(a) $f(0) = 0 \Rightarrow 0 = g(0) + C = 0 + C \Rightarrow C = 0 \Rightarrow f(x) = x^2 \Rightarrow f(2) = 4$

(b) $f(1) = 0 \Rightarrow 0 = g(1) + C = 1 + C \Rightarrow C = -1 \Rightarrow f(x) = x^2 - 1 \Rightarrow f(2) = 3$

(c) $f(-2) = 3 \Rightarrow 3 = g(-2) + C \Rightarrow 3 = 4 + C \Rightarrow C = -1 \Rightarrow f(x) = x^2 - 1 \Rightarrow f(2) = 3$

26. $g(x) = mx \Rightarrow g'(x) = m$, a constant. If $f'(x) = m$, then by Corollary 2, $f(x) = g(x) + b = mx + b$ where b is a constant. Therefore all functions whose derivatives are constant can be graphed as straight lines $y = mx + b$.

27. (a) $y = \frac{x^2}{2} + C$ (b) $y = \frac{x^3}{3} + C$ (c) $y = \frac{x^4}{4} + C$

28. (a) $y = x^2 + C$ (b) $y = x^2 - x + C$ (c) $y = x^3 + x^2 - x + C$

29. (a) $y' = -x^{-2} \Rightarrow y = \frac{1}{x} + C$ (b) $y = x + \frac{1}{x} + C$ (c) $y = 5x - \frac{1}{x} + C$

30. (a) $y' = \frac{1}{2}x^{-1/2} \Rightarrow y = x^{1/2} + C \Rightarrow y = \sqrt{x} + C$ (b) $y = 2\sqrt{x} + C$
(c) $y = 2x^2 - 2\sqrt{x} + C$

31. (a) $y = -\frac{1}{2}\cos 2t + C$ (b) $y = 2\sin \frac{1}{2} + C$
(c) $y = -\frac{1}{2}\cos 2t + 2\sin \frac{1}{2} + C$

32. (a) $y = \tan\theta + C$ (b) $y' = \theta^{1/2} \Rightarrow y = \frac{2}{3}\theta^{3/2} + C$ (c) $y = \frac{2}{3}\theta^{3/2} - \tan\theta + C$

33. $f(x) = x^2 - x + C; 0 = f(0) = 0^2 - 0 + C \Rightarrow C = 0 \Rightarrow f(x) = x^2 - x$

34. $g(x) = -\frac{1}{x} + x^2 + C$; $1 = g(-1) = -\frac{1}{-1} + (-1)^2 + C \Rightarrow C = -1 \Rightarrow g(x) = -\frac{1}{x} + x^2 - 1$
35. $r(\theta) = 8\theta + \cot \theta + C$; $0 = r\left(\frac{\pi}{4}\right) = 8\left(\frac{\pi}{4}\right) + \cot\left(\frac{\pi}{4}\right) + C \Rightarrow 0 = 2\pi + 1 + C \Rightarrow C = -2\pi - 1$
 $\Rightarrow r(\theta) = 8\theta + \cot \theta - 2\pi - 1$
36. $r(t) = \sec t - t + C$; $0 = r(0) = \sec(0) - 0 + C \Rightarrow C = -1 \Rightarrow r(t) = \sec t - t - 1$
37. $v = \frac{ds}{dt} = 9.8t + 5 \Rightarrow s = 4.9t^2 + 5t + C$; at $s = 10$ and $t = 0$ we have $C = 10 \Rightarrow s = 4.9t^2 + 5t + 10$
38. $v = \frac{ds}{dt} = 32t - 2 \Rightarrow s = 16t^2 - 2t + C$; at $s = 4$ and $t = \frac{1}{2}$ we have $C = 1 \Rightarrow s = 6t^2 - 2t + 1$
39. $v = \frac{ds}{dt} = \sin(\pi t) \Rightarrow s = -\frac{1}{\pi}\cos(\pi t) + C$; at $s = 0$ and $t = 0$ we have $C = \frac{1}{\pi} \Rightarrow s = \frac{1 - \cos(\pi t)}{\pi}$
40. $v = \frac{ds}{dt} = \frac{2}{\pi}\cos\left(\frac{2t}{\pi}\right) \Rightarrow s = \sin\left(\frac{2t}{\pi}\right) + C$; at $s = 1$ and $t = \pi^2$ we have $C = 1 \Rightarrow s = \sin\left(\frac{2t}{\pi}\right) + 1$
41. $a = 32 \Rightarrow v = 32t + C_1$; at $v = 20$ and $t = 0$ we have $C_1 = 20 \Rightarrow v = 32t + 20 \Rightarrow s = 16t^2 + 20t + C_2$; at $s = 5$ and $t = 0$ we have $C_2 = 5 \Rightarrow s = 16t^2 + 20t + 5$
42. $a = 9.8 \Rightarrow v = 9.8t + C_1$; at $v = -3$ and $t = 0$ we have $C_1 = -3 \Rightarrow v = 9.8t - 3 \Rightarrow s = 4.9t^2 - 3t + C_2$; at $s = 0$ and $t = 0$ we have $C_2 = 0 \Rightarrow s = 4.9t^2 - 3t$
43. $a = -4\sin(2t) \Rightarrow v = 2\cos(2t) + C_1$; at $v = 2$ and $t = 0$ we have $C_1 = 0 \Rightarrow v = 2\cos(2t) \Rightarrow s = \sin(2t) + C_2$; at $s = -3$ and $t = 0$ we have $C_2 = -3 \Rightarrow s = \sin(2t) - 3$
44. $a = \frac{9}{\pi^2}\cos\left(\frac{3t}{\pi}\right) \Rightarrow v = \frac{3}{\pi}\sin\left(\frac{3t}{\pi}\right) + C_1$; at $v = 0$ and $t = 0$ we have $C_1 = 0 \Rightarrow v = \frac{3}{\pi}\sin\left(\frac{3t}{\pi}\right) \Rightarrow s = -\cos\left(\frac{3t}{\pi}\right) + C_2$; at $s = -1$ and $t = 0$ we have $C_2 = 0 \Rightarrow s = -\cos\left(\frac{3t}{\pi}\right)$
45. If $T(t)$ is the temperature of the thermometer at time t , then $T(0) = -19^\circ \text{C}$ and $T(14) = 100^\circ \text{C}$. From the Mean Value Theorem there exists a $0 < t_0 < 14$ such that $\frac{T(14) - T(0)}{14 - 0} = 8.5^\circ \text{C/sec} = T'(t_0)$, the rate at which the temperature was changing at $t = t_0$ as measured by the rising mercury on the thermometer.
46. Because the trucker's average speed was 79.5 mph, by the Mean Value Theorem, the trucker must have been going that speed at least once during the trip.
47. Because its average speed was approximately 7.667 knots, and by the Mean Value Theorem, it must have been going that speed at least once during the trip.
48. The runner's average speed for the marathon was approximately 11.909 mph. Therefore, by the Mean Value Theorem, the runner must have been going that speed at least once during the marathon. Since the initial speed and final speed are both 0 mph and the runner's speed is continuous, by the Intermediate Value Theorem, the runner's speed must have been 11 mph at least twice.
49. Let $d(t)$ represent the distance the automobile traveled in time t . The average speed over $0 \leq t \leq 2$ is $\frac{d(2) - d(0)}{2 - 0}$. The Mean Value Theorem says that for some $0 < t_0 < 2$, $d'(t_0) = \frac{d(2) - d(0)}{2 - 0}$. The value $d'(t_0)$ is the speed of the automobile at time t_0 (which is read on the speedometer).
50. $a(t) = v'(t) = 1.6 \Rightarrow v(t) = 1.6t + C$; at $(0, 0)$ we have $C = 0 \Rightarrow v(t) = 1.6t$. When $t = 30$, then $v(30) = 48 \text{ m/sec}$.

51. The conclusion of the Mean Value Theorem yields $\frac{\frac{1}{b} - \frac{1}{a}}{\frac{1}{b} - \frac{1}{a}} = -\frac{1}{c^2} \Rightarrow c^2 \left(\frac{a-b}{ab}\right) = a-b \Rightarrow c = \sqrt{ab}$.

52. The conclusion of the Mean Value Theorem yields $\frac{b^2 - a^2}{b - a} = 2c \Rightarrow c = \frac{a+b}{2}$.

53. $f'(x) = [\cos x \sin(x+2) + \sin x \cos(x+2)] - 2 \sin(x+1) \cos(x+1) = \sin(x+x+2) - \sin 2(x+1) = \sin(2x+2) - \sin(2x+2) = 0$. Therefore, the function has the constant value $f(0) = -\sin^2 1 \approx -0.7081$ which explains why the graph is a horizontal line.

54. (a) $f(x) = (x+2)(x+1)x(x-1)(x-2) = x^5 - 5x^3 + 4x$ is one possibility.

(b) Graphing $f(x) = x^5 - 5x^3 + 4x$ and $f'(x) = 5x^4 - 15x^2 + 4$ on $[-3, 3]$ by $[-7, 7]$ we see that each x-intercept of $f'(x)$ lies between a pair of x-intercepts of $f(x)$, as expected by Rolle's Theorem.

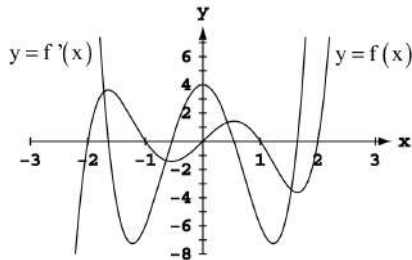

(c) Yes, since \sin is continuous and differentiable on $(-\infty, \infty)$.

55. $f(x)$ must be zero at least once between a and b by the Intermediate Value Theorem. Now suppose that $f(x)$ is zero twice between a and b . Then by the Mean Value Theorem, $f'(x)$ would have to be zero at least once between the two zeros of $f(x)$, but this can't be true since we are given that $f'(x) \neq 0$ on this interval. Therefore, $f(x)$ is zero once and only once between a and b .

56. Consider the function $k(x) = f(x) - g(x)$. $k(x)$ is continuous and differentiable on $[a, b]$, and since $k(a) = f(a) - g(a)$ and $k(b) = f(b) - g(b)$, by the Mean Value Theorem, there must be a point c in (a, b) where $k'(c) = 0$. But since $k'(c) = f'(c) - g'(c)$, this means that $f'(c) = g'(c)$, and c is a point where the graphs of f and g have tangent lines with the same slope, so these lines are either parallel or are the same line.

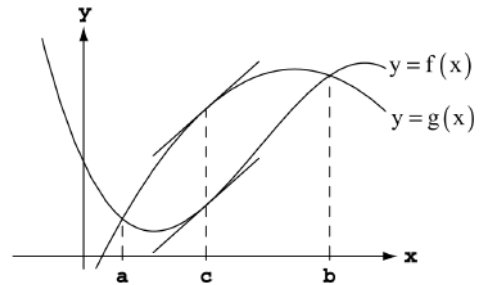

57. Yes. By Corollary 2 we have $f(x) = g(x) + c$ since $f'(x) = g'(x)$. If the graphs start at the same point $x = a$, then $f(a) = g(a) \Rightarrow c = 0 \Rightarrow f(x) = g(x)$.

58. Let $f(x) = \sin x$ for $a \leq x \leq b$. From the Mean Value Theorem there exists a c between a and b such that $\frac{\sin b - \sin a}{b - a} = \cos c \Rightarrow -1 \leq \frac{\sin b - \sin a}{b - a} \leq 1 \Rightarrow \left| \frac{\sin b - \sin a}{b - a} \right| \leq 1 \Rightarrow |\sin b - \sin a| \leq |b - a|$.

59. By the Mean Value Theorem we have $\frac{f(b) - f(a)}{b - a} = f'(c)$ for some point c between a and b . Since $b - a > 0$ and $f(b) < f(a)$, we have $f(b) - f(a) < 0 \Rightarrow f'(c) < 0$.

60. The condition is that f' should be continuous over $[a, b]$. The Mean Value Theorem then guarantees the existence of a point c in (a, b) such that $\frac{f(b) - f(a)}{b - a} = f'(c)$. If f' is continuous, then it has a minimum and maximum value on $[a, b]$, and $\min f' \leq f'(c) \leq \max f'$, as required.

61. $f'(x) = (1 + x^4 \cos x)^{-1} \Rightarrow f''(x) = -(1 + x^4 \cos x)^{-2} (4x^3 \cos x - x^4 \sin x)$
 $= -x^3 (1 + x^4 \cos x)^{-2} (4 \cos x - x \sin x) < 0$ for $0 \leq x \leq 0.1 \Rightarrow f'(x)$ is decreasing when $0 \leq x \leq 0.1$
 $\Rightarrow \min f' \approx 0.9999$ and $\max f' = 1$. Now we have $0.9999 \leq \frac{f(0.1)-1}{0.1} \leq 1 \Rightarrow 0.09999 \leq f(0.1) - 1 \leq 0.1$
 $\Rightarrow 1.09999 \leq f(0.1) \leq 1.1$.
62. $f'(x) = (1 - x^4)^{-1} \Rightarrow f''(x) = -(1 - x^4)^{-2} (-4x^3) = \frac{4x^3}{(1-x^4)^2} > 0$ for $0 < x \leq 0.1 \Rightarrow f'(x)$ is increasing when
 $0 \leq x \leq 0.1 \Rightarrow \min f' = 1$ and $\max f' = 1.0001$. Now we have $1 \leq \frac{f(0.1)-2}{0.1} \leq 1.0001$
 $\Rightarrow 0.1 \leq f(0.1) - 2 \leq 0.10001 \Rightarrow 2.1 \leq f(0.1) \leq 2.10001$.
63. (a) Suppose $x < 1$, then by the Mean Value Theorem $\frac{f(x)-f(1)}{x-1} < 0 \Rightarrow f(x) > f(1)$. Suppose $x > 1$, then by the
 Mean Value Theorem $\frac{f(x)-f(1)}{x-1} > 0 \Rightarrow f(x) > f(1)$. Therefore $f(x) \geq 1$ for all x since $f(1) = 1$.
 (b) Yes. From part (a), $\lim_{x \rightarrow 1^-} \frac{f(x)-f(1)}{x-1} \leq 0$ and $\lim_{x \rightarrow 1^+} \frac{f(x)-f(1)}{x-1} \geq 0$. Since $f'(1)$ exists, these two one-sided
 limits are equal and have the value $f'(1) \Rightarrow f'(1) \leq 0$ and $f'(1) \geq 0 \Rightarrow f'(1) = 0$.
64. From the Mean Value Theorem we have $\frac{f(b)-f(a)}{b-a} = f'(c)$ where c is between a and b . But $f'(c) = 2pc + q = 0$
 has only one solution $c = -\frac{q}{2p}$. (Note: $p \neq 0$ since f is a quadratic function.)

4.3 MONOTONIC FUNCTIONS AND THE FIRST DERIVATIVE TEST

- (a) $f'(x) = x(x - 1) \Rightarrow$ critical points at 0 and 1
 (b) $f' = +++ \mid \text{---} \mid +++ \Rightarrow$ increasing on $(-\infty, 0)$ and $(1, \infty)$, decreasing on $(0, 1)$
 (c) Local maximum at $x = 0$ and a local minimum at $x = 1$
- (a) $f'(x) = (x - 1)(x + 2) \Rightarrow$ critical points at -2 and 1
 (b) $f' = +++ \mid \text{---} \mid +++ \Rightarrow$ increasing on $(-\infty, -2)$ and $(1, \infty)$, decreasing on $(-2, 1)$
 (c) Local maximum at $x = -2$ and a local minimum at $x = 1$
- (a) $f'(x) = (x - 1)^2(x + 2) \Rightarrow$ critical points at -2 and 1
 (b) $f' = \text{---} \mid \text{+++} \mid \text{+++} \Rightarrow$ increasing on $(-2, 1)$ and $(1, \infty)$, decreasing on $(-\infty, -2)$
 (c) No local maximum and a local minimum at $x = -2$
- (a) $f'(x) = (x - 1)^2(x + 2)^2 \Rightarrow$ critical points at -2 and 1
 (b) $f' = +++ \mid \text{+++} \mid \text{+++} \Rightarrow$ increasing on $(-\infty, -2) \cup (-2, 1) \cup (1, \infty)$, never decreasing
 (c) No local extrema
- (a) $f'(x) = (x - 1)(x + 2)(x - 3) \Rightarrow$ critical points at $-2, 1$ and 3
 (b) $f' = \text{---} \mid \text{+++} \mid \text{---} \mid \text{+++} \Rightarrow$ increasing on $(-2, 1)$ and $(3, \infty)$, decreasing on $(-\infty, -2)$ and $(1, 3)$
 (c) Local maximum at $x = 1$, local minima at $x = -2$ and $x = 3$
- (a) $f'(x) = (x - 7)(x + 1)(x + 5) \Rightarrow$ critical points at $-5, -1$ and 7
 (b) $f' = \text{---} \mid \text{+++} \mid \text{---} \mid \text{+++} \Rightarrow$ increasing on $(-5, -1)$ and $(7, \infty)$, decreasing on $(-\infty, -5)$ and $(-1, 7)$
 (c) Local maximum at $x = -1$, local minima at $x = -5$ and $x = 7$

7. (a) $f'(x) = x^{-1/3}(x+2) \Rightarrow$ critical points at -2 and 0
 (b) $f' = \begin{matrix} +++ & | & --- \\ -2 & & 0 \end{matrix} \Rightarrow$ increasing on $(-\infty, -2)$ and $(0, \infty)$, decreasing on $(-2, 0)$
 (c) Local maximum at $x = -2$, local minimum at $x = 0$
8. (a) $f'(x) = x^{-1/2}(x-3) \Rightarrow$ critical points at 0 and 3
 (b) $f' = \begin{matrix} --- & | & +++ \\ 0 & & 3 \end{matrix} \Rightarrow$ increasing on $(3, \infty)$, decreasing on $(0, 3)$
 (c) No local maximum and a local minimum at $x = 3$
9. (a) $g(t) = -t^2 - 3t + 3 \Rightarrow g'(t) = -2t - 3 \Rightarrow$ a critical point at $t = -\frac{3}{2}$; $g' = \begin{matrix} +++ & | & --- \\ -3/2 \end{matrix}$, increasing on $(-\infty, -\frac{3}{2})$, decreasing on $(-\frac{3}{2}, \infty)$
 (b) local maximum value of $g(-\frac{3}{2}) = \frac{21}{4}$ at $t = -\frac{3}{2}$
 (c) absolute maximum is $\frac{21}{4}$ at $t = -\frac{3}{2}$
 (d)

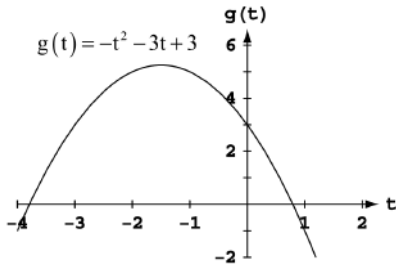

10. (a) $g(t) = -3t^2 + 9t + 5 \Rightarrow g'(t) = -6t + 9 \Rightarrow$ a critical point at $t = \frac{3}{2}$; $g' = \begin{matrix} +++ & | & --- \\ 3/2 \end{matrix}$, increasing on $(-\infty, \frac{3}{2})$, decreasing on $(\frac{3}{2}, \infty)$
 (b) local maximum value of $g(\frac{3}{2}) = \frac{47}{4}$ at $t = \frac{3}{2}$
 (c) absolute maximum is $\frac{47}{4}$ at $t = \frac{3}{2}$
 (d)

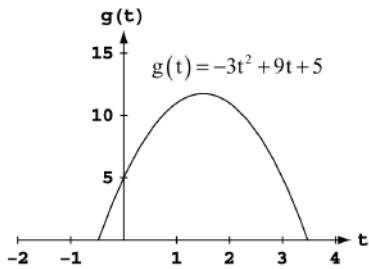

11. (a) $h(x) = -x^3 + 2x^2 \Rightarrow h'(x) = -3x^2 + 4x = x(4-3x) \Rightarrow$ critical points at $x = 0, \frac{4}{3}$
 $\Rightarrow h' = \begin{matrix} --- & | & +++ & | & --- \\ 0 & & 4/3 \end{matrix}$, increasing on $(0, \frac{4}{3})$, decreasing on $(-\infty, 0)$ and $(\frac{4}{3}, \infty)$
 (b) local maximum value of $h(\frac{4}{3}) = \frac{32}{27}$ at $x = \frac{4}{3}$; local minimum value of $h(0) = 0$ at $x = 0$
 (c) no absolute extrema

(d)

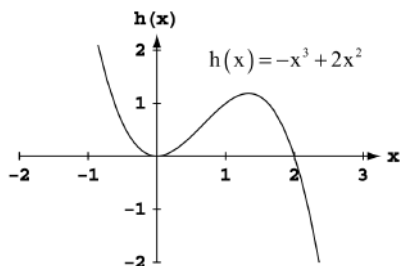

12. (a) $h(x) = 2x^3 - 18x \Rightarrow h'(x) = 6x^2 - 18 = 6(x + \sqrt{3})(x - \sqrt{3}) \Rightarrow$ critical points at $x = \pm \sqrt{3}$
 $\Rightarrow h' = \begin{matrix} + & + & + & | & - & - & - & | & + & + & + \end{matrix}$, increasing on $(-\infty, -\sqrt{3})$ and $(\sqrt{3}, \infty)$, decreasing on $(-\sqrt{3}, \sqrt{3})$
- (b) a local maximum is $h(-\sqrt{3}) = 12\sqrt{3}$ at $x = -\sqrt{3}$; local minimum is $h(\sqrt{3}) = -12\sqrt{3}$ at $x = \sqrt{3}$
- (c) no absolute extrema
- (d)

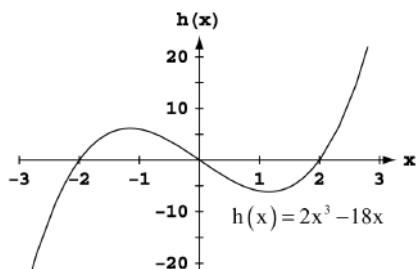

13. (a) $f(\theta) = 3\theta^2 - 4\theta^3 \Rightarrow f'(\theta) = 6\theta - 12\theta^2 = 6\theta(1 - 2\theta) \Rightarrow$ critical points at $\theta = 0, \frac{1}{2} \Rightarrow f' = \begin{matrix} - & - & - & | & + & + & + & | & - & - & - \end{matrix}$,
 increasing on $(0, \frac{1}{2})$, decreasing on $(-\infty, 0)$ and $(\frac{1}{2}, \infty)$
- (b) a local maximum is $f(\frac{1}{2}) = \frac{1}{4}$ at $\theta = \frac{1}{2}$, a local minimum is $f(0) = 0$ at $\theta = 0$
- (c) no absolute extrema
- (d)

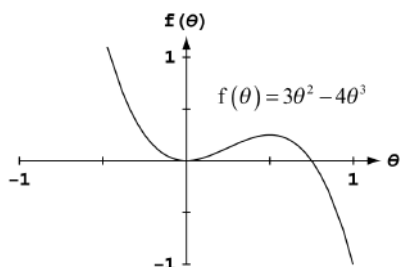

14. (a) $f(\theta) = 6\theta - \theta^3 \Rightarrow f'(\theta) = 6 - 3\theta^2 = 3(\sqrt{2} - \theta)(\sqrt{2} + \theta) \Rightarrow$ critical points at $\theta = \pm \sqrt{2} \Rightarrow$
 $f' = \begin{matrix} - & - & - & | & + & + & + & | & - & - & - \end{matrix}$, increasing on $(-\sqrt{2}, \sqrt{2})$, decreasing on $(-\infty, -\sqrt{2})$ and $(\sqrt{2}, \infty)$
- (b) a local maximum is $f(\sqrt{2}) = 4\sqrt{2}$ at $\theta = \sqrt{2}$, a local minimum is $f(-\sqrt{2}) = -4\sqrt{2}$ at $\theta = -\sqrt{2}$
- (c) no absolute extrema

(d)

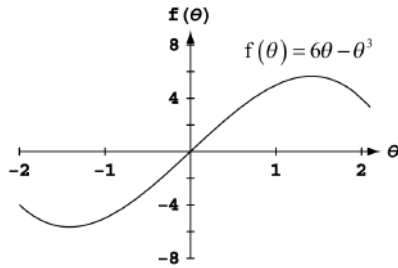

15. (a) $f(r) = 3r^3 + 16r \Rightarrow f'(r) = 9r^2 + 16 \Rightarrow$ no critical points $\Rightarrow f' = +++++$, increasing on $(-\infty, \infty)$, never decreasing
 (b) no local extrema
 (c) no absolute extrema
 (d)

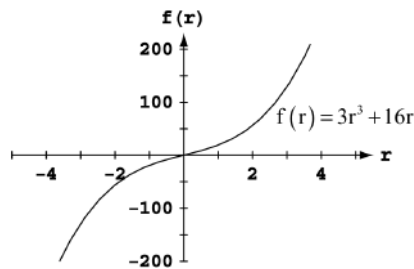

16. (a) $h(r) = (r + 7)^3 \Rightarrow h'(r) = 3(r + 7)^2 \Rightarrow$ a critical point at $r = -7 \Rightarrow h' = +++ \mid -7 \mid +++$, increasing on $(-\infty, -7) \cup (-7, \infty)$, never decreasing
 (b) no local extrema
 (c) no absolute extrema
 (d)

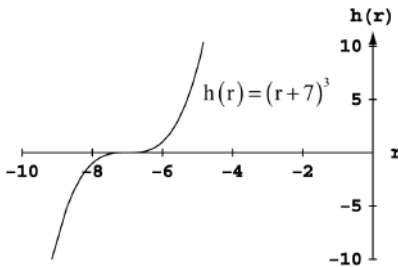

17. (a) $f(x) = x^4 - 8x^2 + 16 \Rightarrow f'(x) = 4x^3 - 16x = 4x(x + 2)(x - 2) \Rightarrow$ critical points at $x = 0$ and $x = \pm 2$
 $\Rightarrow f' = ---- \mid -2 \mid +++ \mid 0 \mid ---- \mid 2 \mid +++$, increasing on $(-2, 0)$ and $(2, \infty)$, decreasing on $(-\infty, -2)$ and $(0, 2)$
 (b) a local maximum is $f(0) = 16$ at $x = 0$, local minima are $f(\pm 2) = 0$ at $x = \pm 2$
 (c) no absolute maximum; absolute minimum is 0 at $x = \pm 2$
 (d)

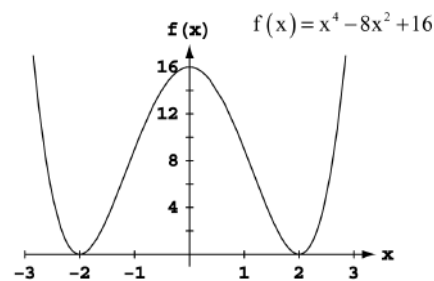

18. (a) $g(x) = x^4 - 4x^3 + 4x^2 \Rightarrow g'(x) = 4x^3 - 12x^2 + 8x = 4x(x-2)(x-1) \Rightarrow$ critical points at $x = 0, 1, 2$
 $\Rightarrow g' = \text{---} \mid \text{+++} \mid \text{---} \mid \text{+++}$, increasing on $(0, 1)$ and $(2, \infty)$, decreasing on $(-\infty, 0)$ and $(1, 2)$
- (b) a local maximum is $g(1) = 1$ at $x = 1$, local minima are $g(0) = 0$ at $x = 0$ and $g(2) = 0$ at $x = 2$
- (c) no absolute maximum; absolute minimum is 0 at $x = 0, 2$
- (d)

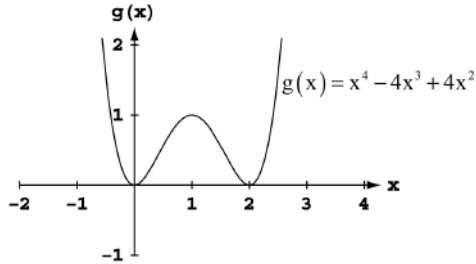

19. (a) $H(t) = \frac{3}{2}t^4 - t^6 \Rightarrow H'(t) = 6t^3 - 6t^5 = 6t^3(1+t)(1-t) \Rightarrow$ critical points at $t = 0, \pm 1$
 $\Rightarrow H' = \text{+++} \mid \text{---} \mid \text{+++} \mid \text{---}$, increasing on $(-\infty, -1)$ and $(0, 1)$, decreasing on $(-1, 0)$ and $(1, \infty)$
- (b) the local maxima are $H(-1) = \frac{1}{2}$ at $t = -1$ and $H(1) = \frac{1}{2}$ at $t = 1$, the local minimum is $H(0) = 0$ at $t = 0$
- (c) absolute maximum is $\frac{1}{2}$ at $t = \pm 1$; no absolute minimum
- (d)

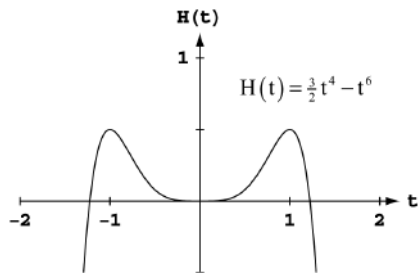

20. (a) $K(t) = 15t^3 - t^5 \Rightarrow K'(t) = 45t^2 - 5t^4 = 5t^2(3+t)(3-t) \Rightarrow$ critical points at $t = 0, \pm 3$
 $\Rightarrow K' = \text{---} \mid \text{+++} \mid \text{+++} \mid \text{---}$, increasing on $(-3, 0) \cup (0, 3)$, decreasing on $(-\infty, -3)$ and $(3, \infty)$
- (b) a local maximum is $K(3) = 162$ at $t = 3$, a local minimum is $K(-3) = -162$ at $t = -3$
- (c) no absolute extrema
- (d)

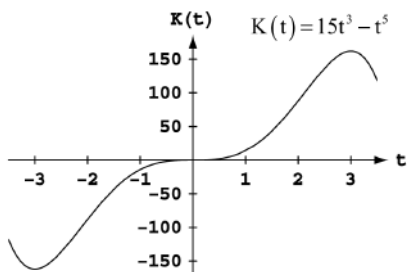

21. (a) $g(x) = x\sqrt{8-x^2} = x(8-x^2)^{1/2} \Rightarrow g'(x) = (8-x^2)^{1/2} + x(\frac{1}{2})(8-x^2)^{-1/2}(-2x) = \frac{2(2-x)(2+x)}{\sqrt{(2\sqrt{2}-x)(2\sqrt{2}+x)}}$
 \Rightarrow critical points at $x = \pm 2, \pm 2\sqrt{2} \Rightarrow g' = (\text{---} \mid \text{+++} \mid \text{---})$, increasing on $(-2, 2)$, decreasing on $(-2\sqrt{2}, -2)$ and $(2, 2\sqrt{2})$

- (b) local maxima are $g(2) = 4$ at $x = 2$ and $g(-2\sqrt{2}) = 0$ at $x = -2\sqrt{2}$, local minima are $g(-2) = -4$ at $x = -2$ and $g(2\sqrt{2}) = 0$ at $x = 2\sqrt{2}$

(c) absolute maximum is 4 at $x = 2$; absolute minimum is -4 at $x = -2$

(d)

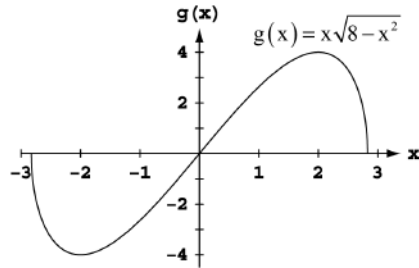

22. (a) $g(x) = x^2\sqrt{5-x} = x^2(5-x)^{1/2} \Rightarrow g'(x) = 2x(5-x)^{1/2} + x^2(\frac{1}{2})(5-x)^{-1/2}(-1) = \frac{5x(4-x)}{2\sqrt{5-x}}$
 \Rightarrow critical points at $x = 0, 4$ and $5 \Rightarrow g' = \text{---} \big| \text{+++} \big| \text{---}$ (at $x=0, 4, 5$), increasing on $(0, 4)$, decreasing on $(-\infty, 0)$ and $(4, 5)$

(b) a local maximum is $g(4) = 16$ at $x = 4$, a local minimum is 0 at $x = 0$ and $x = 5$

(c) no absolute maximum; absolute minimum is 0 at $x = 0, 5$

(d)

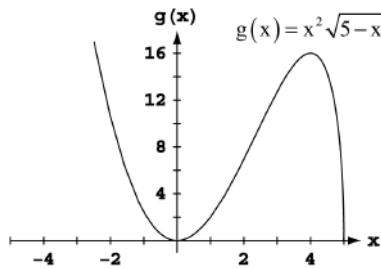

23. (a) $f(x) = \frac{x^2-3}{x-2} \Rightarrow f'(x) = \frac{2x(x-2)-(x^2-3)(1)}{(x-2)^2} = \frac{(x-3)(x-1)}{(x-2)^2} \Rightarrow$ critical points at $x = 1, 3$
 $\Rightarrow f' = \text{+++} \big| \text{---} \big| \text{---} \big| \text{+++}$ (at $x=1, 2, 3$), increasing on $(-\infty, 1)$ and $(3, \infty)$, decreasing on $(1, 2)$ and $(2, 3)$, discontinuous at $x = 2$

(b) a local maximum is $f(1) = 2$ at $x = 1$, a local minimum is $f(3) = 6$ at $x = 3$

(c) no absolute extrema

(d)

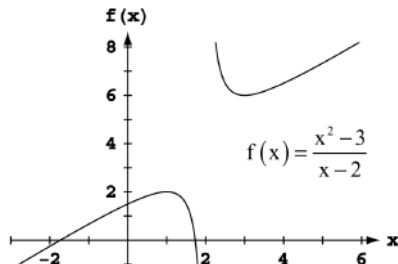

24. (a) $f(x) = \frac{x^3}{3x^2+1} \Rightarrow f'(x) = \frac{3x^2(3x^2+1)-x^3(6x)}{(3x^2+1)^2} = \frac{3x^2(x^2+1)}{(3x^2+1)^2} \Rightarrow$ a critical point at $x = 0$
 $\Rightarrow f' = \text{+++} \big| \text{+++}$, increasing on $(-\infty, 0) \cup (0, \infty)$, and never decreasing

(b) no local extrema

(c) no absolute extrema

(d)

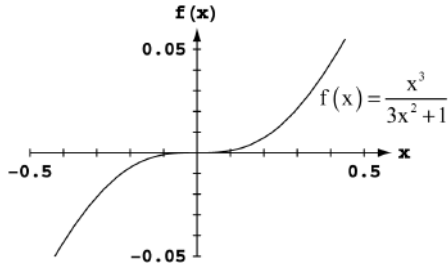

25. (a) $f(x) = x^{1/3}(x+8) = x^{4/3} + 8x^{1/3} \Rightarrow f'(x) = \frac{4}{3}x^{1/3} + \frac{8}{3}x^{-2/3} = \frac{4(x+2)}{3\sqrt[3]{x^2}}$ \Rightarrow critical points at $x = 0, -2$
 $\Rightarrow f' = --- | +++$ $\begin{matrix} -2 & 0 \end{matrix}$, increasing on $(-2, 0) \cup (0, \infty)$, decreasing on $(-\infty, -2)$

(b) no local maximum, a local minimum is $f(-2) = -6\sqrt[3]{2} \approx -7.56$ at $x = -2$

(c) no absolute maximum; absolute minimum is $-6\sqrt[3]{2}$ at $x = -2$

(d)

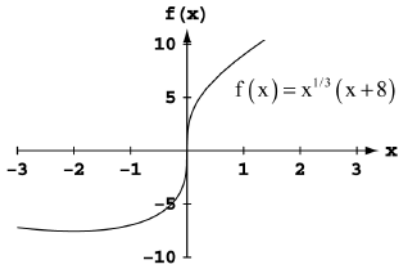

26. (a) $g(x) = x^{2/3}(x+5) = x^{5/3} + 5x^{2/3} \Rightarrow g'(x) = \frac{5}{3}x^{2/3} + \frac{10}{3}x^{-1/3} = \frac{5(x+2)}{3\sqrt[3]{x}}$ \Rightarrow critical points at $x = -2$ and $x = 0$
 $\Rightarrow g' = +++ | ---$ $\begin{matrix} -2 & 0 \end{matrix}$, increasing on $(-\infty, -2)$ and $(0, \infty)$, decreasing on $(-2, 0)$

(b) local maximum is $g(-2) = 3\sqrt[3]{4} \approx 4.762$ at $x = -2$, a local minimum is $g(0) = 0$ at $x = 0$

(c) no absolute extrema

(d)

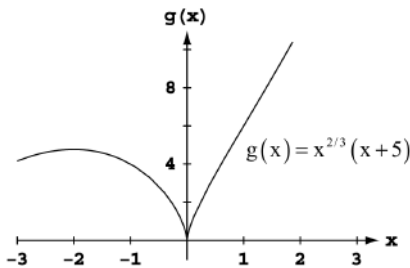

27. (a) $h(x) = x^{1/3}(x^2 - 4) = x^{7/3} - 4x^{1/3} \Rightarrow h'(x) = \frac{7}{3}x^{4/3} - \frac{4}{3}x^{-2/3} = \frac{(\sqrt{7}x+2)(\sqrt{7}x-2)}{3\sqrt[3]{x^2}}$ \Rightarrow critical points at $x = 0, \frac{\pm 2}{\sqrt{7}} \Rightarrow h' = +++ | ---$ $\begin{matrix} -2/\sqrt{7} & 0 & 2/\sqrt{7} \end{matrix}$, increasing on $(-\infty, \frac{-2}{\sqrt{7}})$ and $(\frac{2}{\sqrt{7}}, \infty)$, decreasing on

$(\frac{-2}{\sqrt{7}}, 0)$ and $(0, \frac{2}{\sqrt{7}})$

(b) local maximum is $h(\frac{-2}{\sqrt{7}}) = \frac{24\sqrt[3]{2}}{7^{7/6}} \approx 3.12$ at $x = \frac{-2}{\sqrt{7}}$, the local minimum is $h(\frac{2}{\sqrt{7}}) = -\frac{24\sqrt[3]{2}}{7^{7/6}} \approx -3.12$

(c) no absolute extrema

(d)

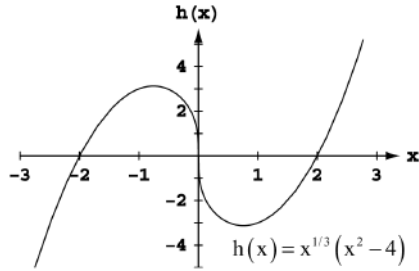

28. (a) $k(x) = x^{2/3}(x^2 - 4) = x^{8/3} - 4x^{2/3} \Rightarrow k'(x) = \frac{8}{3}x^{5/3} - \frac{8}{3}x^{-1/3} = \frac{8(x+1)(x-1)}{3\sqrt[3]{x}} \Rightarrow$ critical points at $x = 0, \pm 1 \Rightarrow k' = \begin{matrix} \text{---} & | & \text{+++} \\ -1 & 0 & 1 \end{matrix} \Rightarrow$ increasing on $(-1, 0)$ and $(1, \infty)$, decreasing on $(-\infty, -1)$ and $(0, 1)$

(b) local maximum is $k(0) = 0$ at $x = 0$, local minima are $k(\pm 1) = -3$ at $x = \pm 1$

(c) no absolute maximum; absolute minimum is -3 at $x = \pm 1$

(d)

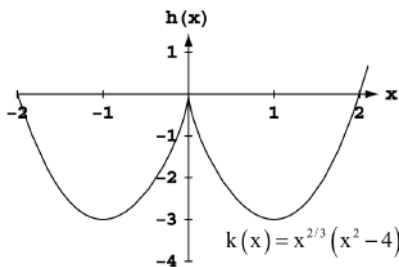

29. (a) $f(x) = 2x - x^2 \Rightarrow f'(x) = 2 - 2x = 2(1 - x) \Rightarrow$ a critical point at $x = 1 \Rightarrow f' = \begin{matrix} \text{+++} & | & \text{---} \\ 1 & 2 \end{matrix}$ and $f(1) = 1$, $f(2) = 0 \Rightarrow$ a local maximum is 1 at $x = 1$, a local minimum is 0 at $x = 2$

(b) absolute maximum is 1 at $x = 1$; no absolute minimum

(c)

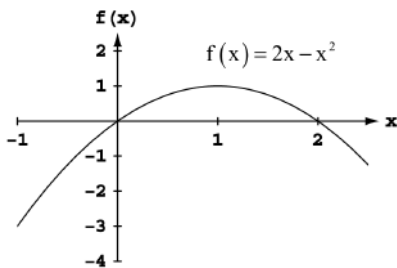

30. (a) $f(x) = (x + 1)^2 \Rightarrow f'(x) = 2(x + 1) \Rightarrow$ a critical point at $x = -1 \Rightarrow f' = \begin{matrix} \text{---} & | & \text{+++} \\ -1 & 0 \end{matrix}$ and $f(-1) = 0$, $f(0) = 1$

\Rightarrow a local maximum is 1 at $x = 0$, a local minimum is 0 at $x = -1$

(b) no absolute maximum; absolute minimum is 0 at $x = -1$

(c)

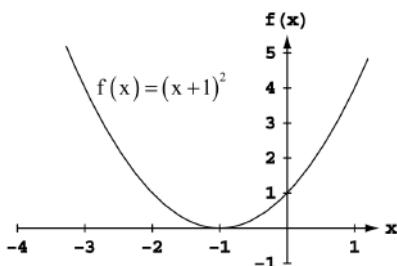

31. (a) $g(x) = x^2 - 4x + 4 \Rightarrow g'(x) = 2x - 4 = 2(x - 2) \Rightarrow$ a critical point at $x = 2 \Rightarrow g' = \left[\begin{array}{c} \text{---} \\ 1 \\ \text{---} \end{array} \middle| \begin{array}{c} \text{+++} \\ 2 \\ \text{---} \end{array} \right]$ and $g(1) = 1, g(2) = 0 \Rightarrow$ a local maximum is 1 at $x = 1$, a local minimum is $g(2) = 0$ at $x = 2$
- (b) no absolute maximum; absolute minimum is 0 at $x = 2$

(c)

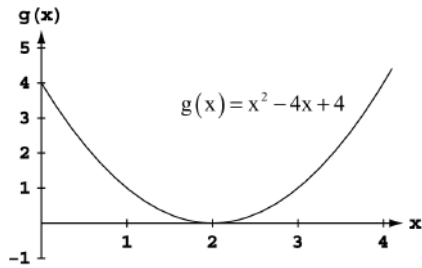

32. (a) $g(x) = -x^2 - 6x - 9 \Rightarrow g'(x) = -2x - 6 = -2(x + 3) \Rightarrow$ a critical point at $x = -3 \Rightarrow g' = \left[\begin{array}{c} \text{+++} \\ -4 \\ \text{---} \end{array} \middle| \begin{array}{c} \text{---} \\ -3 \\ \text{---} \end{array} \right]$ and $g(-4) = -1, g(-3) = 0 \Rightarrow$ a local maximum is 0 at $x = -3$, a local minimum is -1 at $x = -4$
- (b) absolute maximum is 0 at $x = -3$; no absolute minimum

(c)

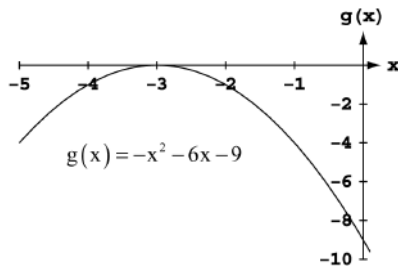

33. (a) $f(t) = 12t - t^3 \Rightarrow f'(t) = 12 - 3t^2 = 3(2 + t)(2 - t) \Rightarrow$ critical points at $t = \pm 2 \Rightarrow f' = \left[\begin{array}{c} \text{---} \\ -3 \\ \text{---} \end{array} \middle| \begin{array}{c} \text{+++} \\ -2 \\ \text{---} \end{array} \middle| \begin{array}{c} \text{---} \\ 2 \\ \text{---} \end{array} \right]$ and $f(-3) = -9, f(-2) = -16, f(2) = 16 \Rightarrow$ local maxima are -9 at $t = -3$ and 16 at $t = -2$, a local minimum is -16 at $t = -2$

(b) absolute maximum is 16 at $t = 2$; no absolute minimum

(c)

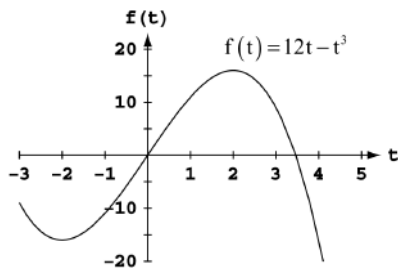

34. (a) $f(t) = t^3 - 3t^2 \Rightarrow f'(t) = 3t^2 - 6t = 3t(t - 2) \Rightarrow$ critical points at $t = 0$ and $t = 2 \Rightarrow f' = \left[\begin{array}{c} \text{+++} \\ 0 \\ \text{---} \end{array} \middle| \begin{array}{c} \text{---} \\ 2 \\ \text{+++} \end{array} \middle| \begin{array}{c} \text{+++} \\ 3 \\ \text{---} \end{array} \right]$ and $f(0) = 0, f(2) = -4, f(3) = 0 \Rightarrow$ a local maximum is 0 at $t = 0$ and $t = 3$, a local minimum is -4 at $t = 2$

(b) absolute maximum is 0 at $t = 0, 3$; no absolute minimum

(c)

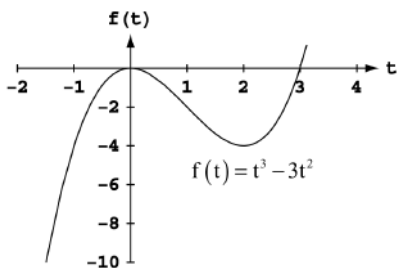

35. (a) $h(x) = \frac{x^3}{3} - 2x^2 + 4x \Rightarrow h'(x) = x^2 - 4x + 4 = (x - 2)^2 \Rightarrow$ a critical point at $x = 2 \Rightarrow h' = \left[\begin{array}{c} +++ \\ 0 \end{array} \middle| \begin{array}{c} +++ \\ 2 \end{array} \right]$ and

$h(0) = 0 \Rightarrow$ no local maximum, a local minimum is 0 at $x = 0$

(b) no absolute maximum; absolute minimum is 0 at $x = 0$

(c)

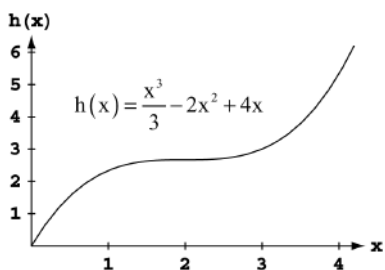

36. (a) $k(x) = x^3 + 3x^2 + 3x + 1 \Rightarrow k'(x) = 3x^2 + 6x + 3 = 3(x + 1)^2 \Rightarrow$ a critical point at $x = -1$
 $\Rightarrow k' = \left[\begin{array}{c} +++ \\ -1 \end{array} \middle| \begin{array}{c} +++ \\ 0 \end{array} \right]$ and $k(-1) = 0, k(0) = 1 \Rightarrow$ a local maximum is 1 at $x = 0$, no local minimum

(b) absolute maximum is 1 at $x = 0$; no absolute minimum

(c)

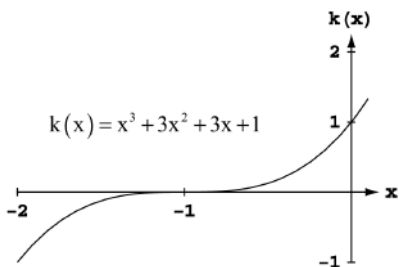

37. (a) $f(x) = \frac{x}{2} - 2 \sin\left(\frac{x}{2}\right) \Rightarrow f'(x) = \frac{1}{2} - \cos\left(\frac{x}{2}\right), f'(x) = 0 \Rightarrow \cos\left(\frac{x}{2}\right) = \frac{1}{2} \Rightarrow$ a critical point at $x = \frac{2\pi}{3}$
 $\Rightarrow f' = \left[\begin{array}{c} --- \\ 0 \end{array} \middle| \begin{array}{c} +++ \\ 2\pi/3 \end{array} \right]$ and $f(0) = 0, f\left(\frac{2\pi}{3}\right) = \frac{\pi}{3} - \sqrt{3}, f(2\pi) = \pi \Rightarrow$ local maxima are 0 at $x = 0$ and π

at $x = 2\pi$, a local minimum is $\frac{\pi}{3} - \sqrt{3}$ at $x = \frac{2\pi}{3}$

(b) The graph of f rises when $f' > 0$, falls when $f' < 0$, and has a local minimum value at the point where f' changes from negative to positive.

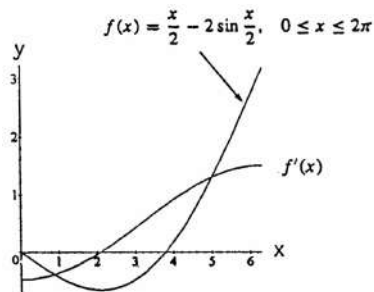

38. (a) $f(x) = -2 \cos x - \cos^2 x \Rightarrow f'(x) = 2 \sin x + 2 \cos x \sin x = 2(\sin x)(1 + \cos x) \Rightarrow$ critical points at $x = -\pi, 0, \pi \Rightarrow f' = \left[\begin{array}{c} - - - \\ -\pi \quad 0 \quad \pi \\ + + + \end{array} \right]$ and $f(-\pi) = 1, f(0) = -3, f(\pi) = 1 \Rightarrow$ a local maximum is 1 at $x = \pm \pi$, a local minimum is -3 at $x = 0$

- (b) The graph of f rises when $f' > 0$, falls when $f' < 0$, and has local extreme values where $f' = 0$. The function f has a local minimum value at $x = 0$, where the values of f' change from negative to positive.

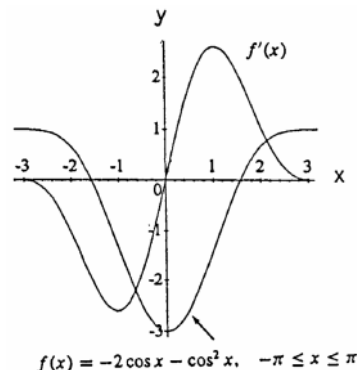

39. (a) $f(x) = \csc^2 x - 2 \cot x \Rightarrow f'(x) = 2(\csc x)(-\csc x)(\cot x) - 2(-\csc^2 x) = -2(\csc^2 x)(\cot x - 1) \Rightarrow$ a critical point at $x = \frac{\pi}{4} \Rightarrow f' = \left(\begin{array}{c} - - - \\ 0 \quad \pi/4 \quad \pi \\ + + + \end{array} \right)$ and $f(\frac{\pi}{4}) = 0 \Rightarrow$ no local maximum, a local minimum is 0 at $x = \frac{\pi}{4}$

- (b) The graph of f rises when $f' > 0$, falls when $f' < 0$, and has a local minimum value at the point where $f' = 0$ and the values of f' change from negative to positive. The graph of f steepens as $f'(x) \rightarrow \pm \infty$.

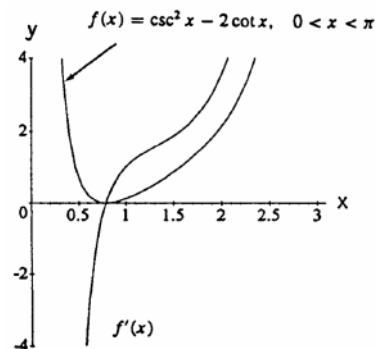

40. (a) $f(x) = \sec^2 x - 2 \tan x \Rightarrow f'(x) = 2(\sec x)(\sec x)(\tan x) - 2 \sec^2 x = (2 \sec^2 x)(\tan x - 1) \Rightarrow$ a critical point at $x = \frac{\pi}{4} \Rightarrow f' = \left(\begin{array}{c} - - - \\ -\pi/2 \quad \pi/4 \quad \pi/2 \\ + + + \end{array} \right)$ and $f(\frac{\pi}{4}) = 0 \Rightarrow$ no local maximum, a local minimum is 0 at $x = \frac{\pi}{4}$

- (b) The graph of f rises when $f' > 0$, falls when $f' < 0$, and has a local minimum value where $f' = 0$ and the values of f' change from negative to positive.

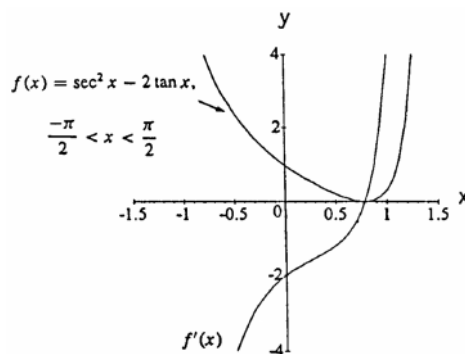

41. $h(\theta) = 3 \cos(\frac{\theta}{2}) \Rightarrow h'(\theta) = -\frac{3}{2} \sin(\frac{\theta}{2}) \Rightarrow h' = \left[\begin{array}{c} - - - \\ 0 \quad 2\pi \\ + + + \end{array} \right], (0, 3)$ and $(2\pi, -3) \Rightarrow$ a local maximum is 3 at $\theta = 0$, a local minimum is -3 at $\theta = 2\pi$

42. $h(\theta) = 5 \sin(\frac{\theta}{2}) \Rightarrow h'(\theta) = \frac{5}{2} \cos(\frac{\theta}{2}) \Rightarrow h' = \left[\begin{array}{c} + + + \\ 0 \quad \pi \\ - - - \end{array} \right], (0, 0)$ and $(\pi, 5) \Rightarrow$ a local maximum is 5 at $\theta = \pi$, a local minimum is 0 at $\theta = 0$

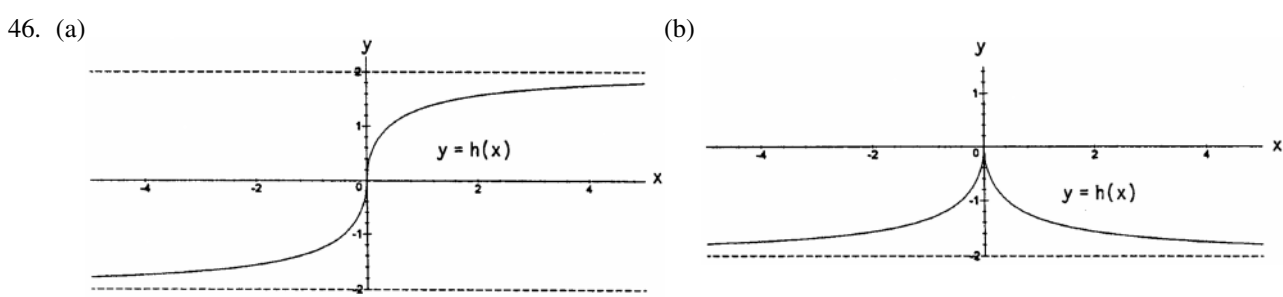
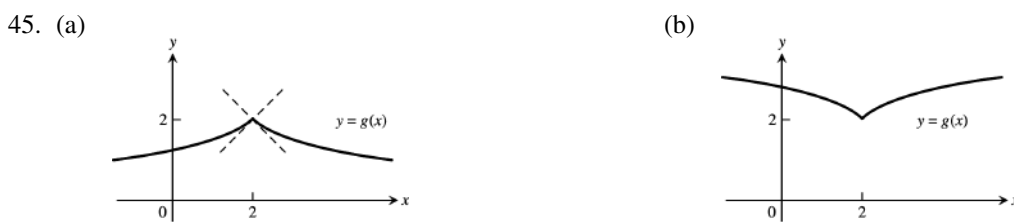
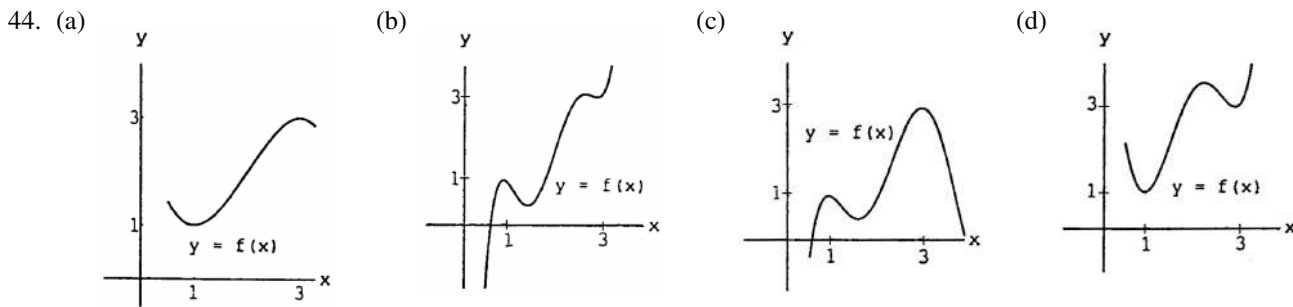
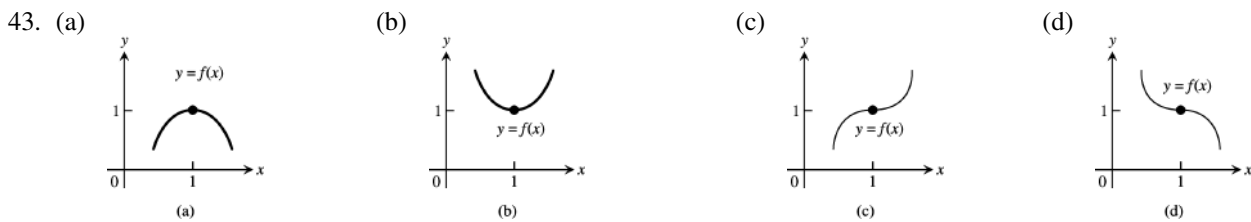

47. $f(x) = x^3 - 3x + 2 \Rightarrow f'(x) = 3x^2 - 3 = 3(x - 1)(x + 1) \Rightarrow f' = \begin{matrix} + & + & + \\ | & & | \\ - & - & - \\ | & & | \\ + & + & + \end{matrix} \Rightarrow$ rising for $x = c = 2$ since $f'(x) > 0$ for $x = c = 2$.

48. $f(x) = ax^2 + bx + c = a(x^2 + \frac{b}{a}x) + c = a(x^2 + \frac{b}{a}x + \frac{b^2}{4a^2}) - \frac{b^2}{4a} + c = a(x + \frac{b}{2a})^2 - \frac{b^2 - 4ac}{4a}$, a parabola whose vertex is at $x = -\frac{b}{2a}$. Thus when $a > 0$, f is increasing on $(-\frac{b}{2a}, \infty)$ and decreasing on $(-\infty, -\frac{b}{2a})$; when $a < 0$, f is increasing on $(-\infty, -\frac{b}{2a})$ and decreasing on $(-\frac{b}{2a}, \infty)$. Also note that $f'(x) = 2ax + b = 2a(x + \frac{b}{2a}) \Rightarrow$ for $a > 0$, $f' = \begin{matrix} - & - & - \\ | & & | \\ + & + & + \\ | & & | \\ - & - & - \end{matrix}$; for $a < 0$, $f' = \begin{matrix} + & + & + \\ | & & | \\ - & - & - \\ | & & | \\ + & + & + \end{matrix}$.

4.4 CONCAVITY AND CURVE SKETCHING

1. $y = \frac{x^3}{3} - \frac{x^2}{2} - 2x + \frac{1}{3} \Rightarrow y' = x^2 - x - 2 = (x - 2)(x + 1) \Rightarrow y'' = 2x - 1 = 2(x - \frac{1}{2})$. The graph is rising on $(-\infty, -1)$ and $(2, \infty)$, falling on $(-1, 2)$, concave up on $(\frac{1}{2}, \infty)$ and concave down on $(-\infty, \frac{1}{2})$. Consequently, a local maximum is $\frac{3}{2}$ at $x = -1$, a local minimum is -3 at $x = 2$, and $(\frac{1}{2}, -\frac{3}{4})$ is a point of inflection.

2. $y = \frac{x^4}{4} - 2x^2 + 4 \Rightarrow y' = x^3 - 4x = x(x^2 - 4) = x(x+2)(x-2) \Rightarrow y'' = 3x^2 - 4 = (\sqrt{3}x + 2)(\sqrt{3}x - 2)$. The graph is rising on $(-2, 0)$ and $(2, \infty)$, falling on $(-\infty, -2)$ and $(0, 2)$, concave up on $(-\infty, \frac{2}{\sqrt{3}})$ and $(\frac{2}{\sqrt{3}}, \infty)$ and concave down on $(-\frac{2}{\sqrt{3}}, \frac{2}{\sqrt{3}})$. Consequently, a local maximum is 4 at $x = 0$, local minima are 0 at $x = \pm 2$, and $(-\frac{2}{\sqrt{3}}, \frac{16}{9})$ and $(\frac{2}{\sqrt{3}}, \frac{16}{9})$ are points of inflection.
3. $y = \frac{3}{4}(x^2 - 1)^{2/3} \Rightarrow y' = (\frac{3}{4})(\frac{2}{3})(x^2 - 1)^{-1/3}(2x) = x(x^2 - 1)^{-1/3}$, $y' = \text{---} \mid \text{---} \mid \text{---}$ $\begin{matrix} -1 & 0 & 1 \end{matrix}$ \Rightarrow the graph is rising on $(-1, 0)$ and $(1, \infty)$, falling on $(-\infty, -1)$ and $(0, 1) \Rightarrow$ a local maximum is $\frac{3}{4}$ at $x = 0$, local minima are 0 at $x = \pm 1$; $y'' = (x^2 - 1)^{-1/3} + (x)(-\frac{1}{3})(x^2 - 1)^{-4/3}(2x) = \frac{x^2 - 3}{3\sqrt[3]{(x^2 - 1)^4}}$, $y'' = \text{---} \mid \text{---} \mid \text{---}$ $\begin{matrix} -\sqrt{3} & -1 & 1 & \sqrt{3} \end{matrix}$ \Rightarrow the graph is concave up on $(-\infty, -\sqrt{3})$ and $(\sqrt{3}, \infty)$, concave down on $(-\sqrt{3}, \sqrt{3}) \Rightarrow$ points of inflection at $(\pm\sqrt{3}, \frac{3\sqrt[3]{4}}{4})$
4. $y = \frac{9}{14}x^{1/3}(x^2 - 7) \Rightarrow y' = \frac{3}{14}x^{-2/3}(x^2 - 7) + \frac{9}{14}x^{1/3}(2x) = \frac{3}{2}x^{-2/3}(x^2 - 1)$, $y' = \text{---} \mid \text{---} \mid \text{---}$ $\begin{matrix} -1 & 0 & 1 \end{matrix}$ \Rightarrow the graph is rising on $(-\infty, -1)$ and $(1, \infty)$, falling on $(-1, 1) \Rightarrow$ a local maximum is $\frac{27}{7}$ at $x = -1$, a local minimum is $-\frac{27}{7}$ at $x = 1$; $y'' = -x^{-5/3}(x^2 - 1) + 3x^{1/3} = 2x^{1/3} + x^{-5/3} = x^{-5/3}(2x^2 + 1)$, $y'' = \text{---} \mid \text{---}$ $\begin{matrix} 0 \end{matrix}$ \Rightarrow the graph is concave up on $(0, \infty)$, concave down on $(-\infty, 0) \Rightarrow$ a point of inflection at $(0, 0)$
5. $y = x + \sin 2x \Rightarrow y' = 1 + 2 \cos 2x$, $y' = [\text{---} \mid \text{---} \mid \text{---}]$ $\begin{matrix} -2\pi/3 & -\pi/3 & \pi/3 & 2\pi/3 \end{matrix}$ \Rightarrow the graph is rising on $(-\frac{\pi}{3}, \frac{\pi}{3})$, falling on $(-\frac{2\pi}{3}, -\frac{\pi}{3})$ and $(\frac{\pi}{3}, \frac{2\pi}{3}) \Rightarrow$ local maxima are $-\frac{2\pi}{3} + \frac{\sqrt{3}}{2}$ at $x = -\frac{2\pi}{3}$ and $\frac{\pi}{3} + \frac{\sqrt{3}}{2}$ at $x = \frac{\pi}{3}$, local minima are $-\frac{\pi}{3} - \frac{\sqrt{3}}{2}$ at $x = -\frac{\pi}{3}$ and $\frac{2\pi}{3} - \frac{\sqrt{3}}{2}$ at $x = \frac{2\pi}{3}$; $y'' = -4 \sin 2x$, $y'' = [\text{---} \mid \text{---} \mid \text{---} \mid \text{---}]$ $\begin{matrix} -2\pi/3 & -\pi/2 & 0 & \pi/2 & 2\pi/3 \end{matrix}$ \Rightarrow the graph is concave up on $(-\frac{\pi}{2}, 0)$ and $(\frac{\pi}{2}, \frac{2\pi}{3})$, concave down on $(-\frac{2\pi}{3}, -\frac{\pi}{2})$ and $(0, \frac{\pi}{2}) \Rightarrow$ points of inflection at $(-\frac{\pi}{2}, -\frac{\pi}{2})$, $(0, 0)$, and $(\frac{\pi}{2}, \frac{\pi}{2})$
6. $y = \tan x - 4x \Rightarrow y' = \sec^2 x - 4$, $y' = (\text{---} \mid \text{---} \mid \text{---})$ $\begin{matrix} -\pi/2 & -\pi/3 & \pi/3 & \pi/2 \end{matrix}$ \Rightarrow the graph is rising on $(-\frac{\pi}{2}, -\frac{\pi}{3})$ and $(\frac{\pi}{3}, \frac{\pi}{2})$, falling on $(-\frac{\pi}{3}, \frac{\pi}{3}) \Rightarrow$ a local maximum is $-\sqrt{3} + \frac{4\pi}{3}$ at $x = -\frac{\pi}{3}$, a local minimum is $\sqrt{3} - \frac{4\pi}{3}$ at $x = \frac{\pi}{3}$; $y'' = 2(\sec x)(\sec x)(\tan x) = 2(\sec^2 x)(\tan x)$, $y'' = (\text{---} \mid \text{---})$ $\begin{matrix} -\pi/2 & 0 & \pi/2 \end{matrix}$ \Rightarrow the graph is concave up on $(0, \frac{\pi}{2})$, concave down on $(-\frac{\pi}{2}, 0) \Rightarrow$ a point of inflection at $(0, 0)$

7. If $x \geq 0$, $\sin |x| = \sin x$ and if $x < 0$, $\sin |x| = \sin(-x) = -\sin x$. From the sketch the graph is rising on $(-\frac{3\pi}{2}, -\frac{\pi}{2})$, $(0, \frac{\pi}{2})$ and $(\frac{3\pi}{2}, 2\pi)$, falling on $(-2\pi, -\frac{3\pi}{2})$, $(-\frac{\pi}{2}, 0)$ and $(\frac{\pi}{2}, \frac{3\pi}{2})$; local minima are -1 at $x = \pm\frac{\pi}{2}$ and 0 at $x = \pm 2\pi$; local maxima are 1 at $x = \pm\frac{3\pi}{2}$ and 0 at $x = \pm 2\pi$; concave up on $(-2\pi, -\pi)$ and $(\pi, 2\pi)$, and concave down on $(-\pi, 0)$ and $(0, \pi) \Rightarrow$ points of inflection are $(-\pi, 0)$ and $(\pi, 0)$

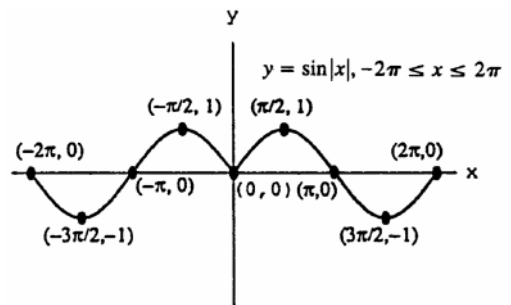

8. $y = 2 \cos x - \sqrt{2}x \Rightarrow y' = -2 \sin x - \sqrt{2}, y' = \left[\begin{array}{c|c|c|c} \text{---} & \text{---} & \text{---} & \text{---} \\ -\pi & -3\pi/4 & -\pi/4 & 5\pi/4 \\ \text{---} & \text{---} & \text{---} & \text{---} \\ & \text{---} & \text{---} & \text{---} \\ & -\pi/4 & 5\pi/4 & 3\pi/2 \end{array} \right] \Rightarrow$ rising on $(-\frac{3\pi}{4}, -\frac{\pi}{4})$ and $(\frac{5\pi}{4}, \frac{3\pi}{2})$, falling on $(-\pi, -\frac{3\pi}{4})$ and $(-\frac{\pi}{4}, \frac{5\pi}{4}) \Rightarrow$ local maxima are $-2 + \pi\sqrt{2}$ at $x = -\pi, \sqrt{2} + \frac{\pi\sqrt{2}}{4}$ at $x = -\frac{\pi}{4}$ and $-\frac{3\pi\sqrt{2}}{2}$ at $x = \frac{3\pi}{2}$, and local minima are $-\sqrt{2} + \frac{3\pi\sqrt{2}}{4}$ at $x = -\frac{3\pi}{4}$ and $-\sqrt{2} - \frac{5\pi\sqrt{2}}{4}$ at $x = \frac{5\pi}{4}$;
 $y'' = -2 \cos x, y'' = \left[\begin{array}{c|c|c|c} \text{---} & \text{---} & \text{---} & \text{---} \\ -\pi & -\pi/2 & \pi/2 & 3\pi/2 \\ \text{---} & \text{---} & \text{---} & \text{---} \\ & \text{---} & \text{---} & \text{---} \\ & -\pi/2 & \pi/2 & 3\pi/2 \end{array} \right] \Rightarrow$ concave up on $(-\pi, -\frac{\pi}{2})$ and $(\frac{\pi}{2}, \frac{3\pi}{2})$, concave down on $(-\frac{\pi}{2}, \frac{\pi}{2}) \Rightarrow$ points of inflection at $(-\frac{\pi}{2}, \frac{\sqrt{2}\pi}{2})$ and $(\frac{\pi}{2}, -\frac{\sqrt{2}\pi}{2})$

9. When $y = x^2 - 4x + 3$, then $y' = 2x - 4 = 2(x - 2)$ and $y'' = 2$. The curve rises on $(2, \infty)$ and falls on $(-\infty, 2)$. At $x = 2$ there is a minimum. Since $y'' > 0$, the curve is concave up for all x .

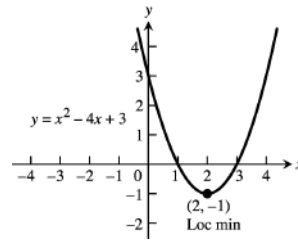

10. When $y = 6 - 2x - x^2$, then $y' = -2 - 2x = -2(1 + x)$ and $y'' = -2$. The curve rises on $(-\infty, -1)$ and falls on $(-1, \infty)$. At $x = -1$ there is a maximum. Since $y'' < 0$, the curve is concave down for all x .

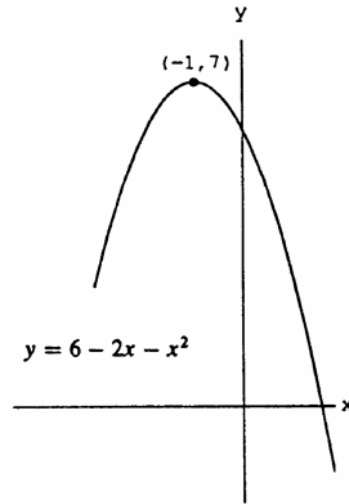

11. When $y = x^3 - 3x + 3$, then $y' = 3x^2 - 3 = 3(x - 1)(x + 1)$ and $y'' = 6x$. The curve rises on $(-\infty, -1) \cup (1, \infty)$ and falls on $(-1, 1)$. At $x = -1$ there is a local maximum and at $x = 1$ a local minimum. The curve is concave down on $(-\infty, 0)$ and concave up on $(0, \infty)$. There is a point of inflection at $x = 0$.

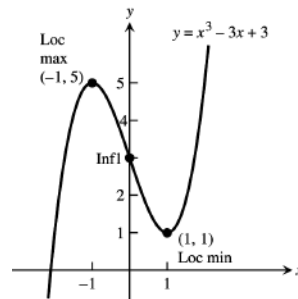

12. When $y = x(6 - 2x)^2$, then $y' = -4x(6 - 2x) + (6 - 2x)^2 = 12(3 - x)(1 - x)$ and $y'' = -12(3 - x) - 12(1 - x) = 24(x - 2)$. The curve rises on $(-\infty, 1) \cup (3, \infty)$ and falls on $(1, 3)$. The curve is concave down on $(-\infty, 2)$ and concave up on $(2, \infty)$. At $x = 2$ there is a point of inflection.

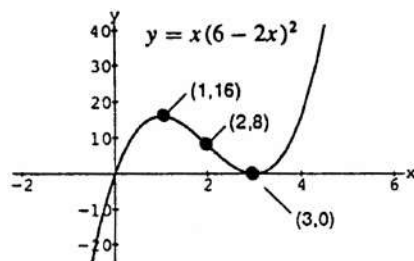

13. When $y = -2x^3 + 6x^2 - 3$, then $y' = -6x^2 + 12x = -6x(x - 2)$ and $y'' = -12x + 12 = -12(x - 1)$. The curve rises on $(0, 2)$ and falls on $(-\infty, 0)$ and $(2, \infty)$. At $x = 0$ there is a local minimum and at $x = 2$ a local maximum. The curve is concave up on $(-\infty, 1)$ and concave down on $(1, \infty)$. At $x = 1$ there is a point of inflection.

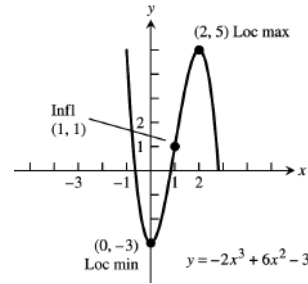

14. When $y = 1 - 9x - 6x^2 - x^3$, then $y' = -9 - 12x - 3x^2 = -3(x + 3)(x + 1)$ and $y'' = -12 - 6x = -6(x + 2)$. The curve rises on $(-3, -1)$ and falls on $(-\infty, -3)$ and $(-1, \infty)$. At $x = -1$ there is a local maximum and at $x = -3$ a local minimum. The curve is concave up on $(-\infty, -2)$ and concave down on $(-2, \infty)$. At $x = -2$ there is a point of inflection.

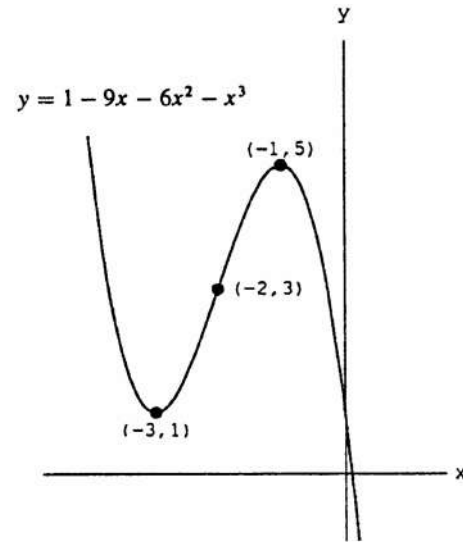

15. When $y = (x - 2)^3 + 1$, then $y' = 3(x - 2)^2$ and $y'' = 6(x - 2)$. The curve never falls and there are no local extrema. The curve is concave down on $(-\infty, 2)$ and concave up on $(2, \infty)$. At $x = 2$ there is a point of inflection.

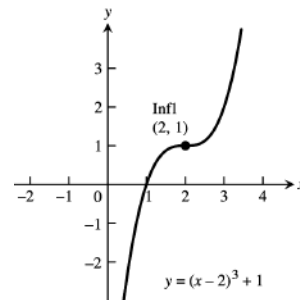

16. When $y = 1 - (x + 1)^3$, then $y' = -3(x + 1)^2$ and $y'' = -6(x + 1)$. The curve never rises and there are no local extrema. The curve is concave up on $(-\infty, -1)$ and concave down on $(-1, \infty)$. At $x = -1$ there is a point of inflection.

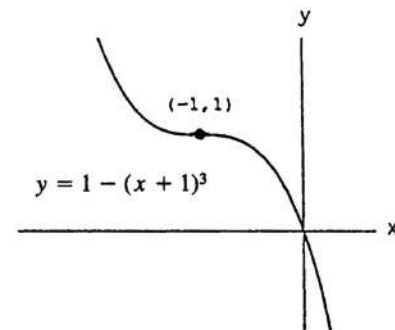

17. When $y = x^4 - 2x^2$, then $y' = 4x^3 - 4x = 4x(x+1)(x-1)$ and $y'' = 12x^2 - 4 = 12\left(x + \frac{1}{\sqrt{3}}\right)\left(x - \frac{1}{\sqrt{3}}\right)$. The curve rises on $(-1, 0)$ and $(1, \infty)$ and falls on $(-\infty, -1)$ and $(0, 1)$. At $x = \pm 1$ there are local minima and at $x = 0$ a local maximum. The curve is concave up on $(-\infty, -\frac{1}{\sqrt{3}})$ and $(\frac{1}{\sqrt{3}}, \infty)$ and concave down on $(-\frac{1}{\sqrt{3}}, \frac{1}{\sqrt{3}})$. At $x = \frac{\pm 1}{\sqrt{3}}$ there are points of inflection.

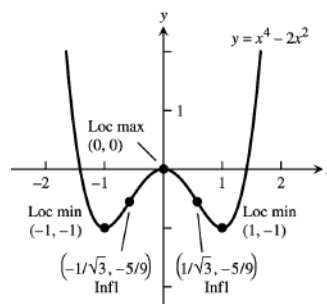

18. When $y = -x^4 + 6x^2 - 4$, then $y' = -4x^3 + 12x = -4x(x + \sqrt{3})(x - \sqrt{3})$ and $y'' = -12x^2 + 12 = -12(x+1)(x-1)$. The curve rises on $(-\infty, -\sqrt{3})$ and $(0, \sqrt{3})$, and falls on $(-\sqrt{3}, 0)$ and $(\sqrt{3}, \infty)$. At $x = \pm \sqrt{3}$ there are local maxima and at $x = 0$ a local minimum. The curve is concave up on $(-1, 1)$ and concave down on $(-\infty, -1)$ and $(1, \infty)$. At $x = \pm 1$ there are points of inflection.

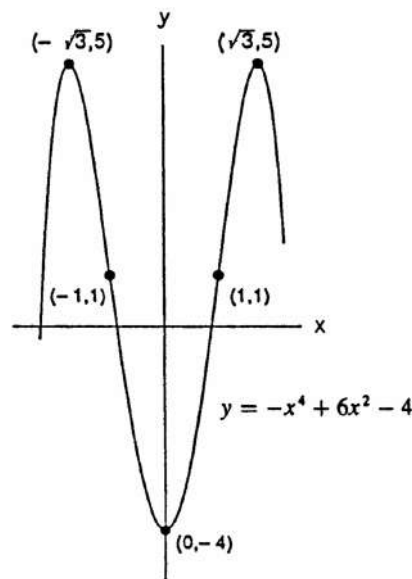

19. When $y = 4x^3 - x^4$, then $y' = 12x^2 - 4x^3 = 4x^2(3-x)$ and $y'' = 24x - 12x^2 = 12x(2-x)$. The curve rises on $(-\infty, 3)$ and falls on $(3, \infty)$. At $x = 3$ there is a local maximum, but there is no local minimum. The graph is concave up on $(0, 2)$ and concave down on $(-\infty, 0)$ and $(2, \infty)$. There are inflection points at $x = 0$ and $x = 2$.

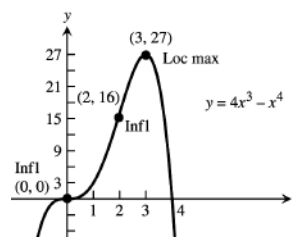

20. When $y = x^4 + 2x^3$, then $y' = 4x^3 + 6x^2 = 2x^2(2x+3)$ and $y'' = 12x^2 + 12x = 12x(x+1)$. The curve rises on $(-\frac{3}{2}, \infty)$ and falls on $(-\infty, -\frac{3}{2})$. There is a local minimum at $x = -\frac{3}{2}$, but no local maximum. The curve is concave up on $(-\infty, -1)$ and $(0, \infty)$, and concave down on $(-1, 0)$. At $x = -1$ and $x = 0$ there are points of inflection.

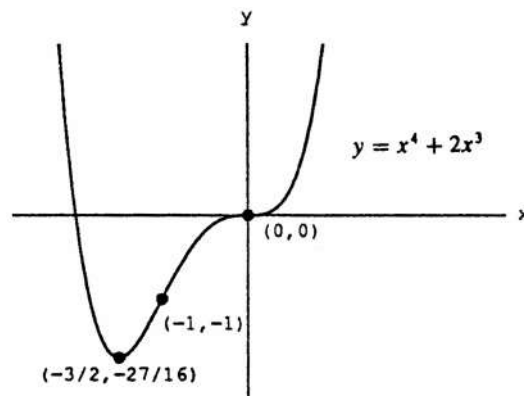

21. When $y = x^5 - 5x^4$, then $y' = 5x^4 - 20x^3 = 5x^3(x - 4)$ and $y'' = 20x^3 - 60x^2 = 20x^2(x - 3)$. The curve rises on $(-\infty, 0)$ and $(4, \infty)$, and falls on $(0, 4)$. There is a local maximum at $x = 0$, and a local minimum at $x = 4$. The curve is concave down on $(-\infty, 3)$ and concave up on $(3, \infty)$. At $x = 3$ there is a point of inflection.

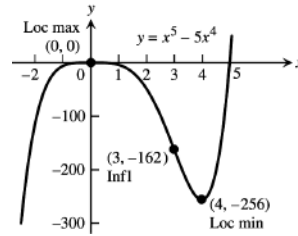

22. When $y = x \left(\frac{x}{2} - 5\right)^4$, then $y' = \left(\frac{x}{2} - 5\right)^4 + x(4)\left(\frac{x}{2} - 5\right)^3 \left(\frac{1}{2}\right) = \left(\frac{x}{2} - 5\right)^3 \left(\frac{5x}{2} - 5\right)$, and $y'' = 3 \left(\frac{x}{2} - 5\right)^2 \left(\frac{1}{2}\right) \left(\frac{5x}{2} - 5\right) + \left(\frac{x}{2} - 5\right)^3 \left(\frac{5}{2}\right) = 5 \left(\frac{x}{2} - 5\right)^2 (x - 4)$. The curve is rising on $(-\infty, 2)$ and $(10, \infty)$, and falling on $(2, 10)$. There is a local maximum at $x = 2$ and a local minimum at $x = 10$. The curve is concave down on $(-\infty, 4)$ and concave up on $(4, \infty)$. At $x = 4$ there is a point of inflection.

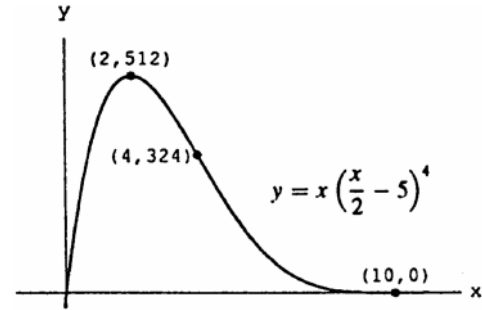

23. When $y = x + \sin x$, then $y' = 1 + \cos x$ and $y'' = -\sin x$. The curve rises on $(0, 2\pi)$. At $x = 0$ there is a local and absolute minimum and at $x = 2\pi$ there is a local and absolute maximum. The curve is concave down on $(0, \pi)$ and concave up on $(\pi, 2\pi)$. At $x = \pi$ there is a point of inflection.

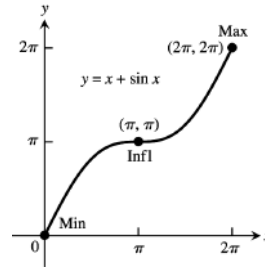

24. When $y = x - \sin x$, then $y' = 1 - \cos x$ and $y'' = \sin x$. The curve rises on $(0, 2\pi)$. At $x = 0$ there is a local and absolute minimum and at $x = 2\pi$ there is a local and absolute maximum. The curve is concave up on $(0, \pi)$ and concave down on $(\pi, 2\pi)$. At $x = \pi$ there is a point of inflection.

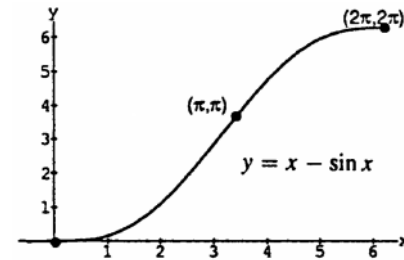

25. When $y = x^{1/5}$, then $y' = \frac{1}{5} x^{-4/5}$ and $y'' = -\frac{4}{25} x^{-9/5}$. The curve rises on $(-\infty, \infty)$ and there are no extrema. The curve is concave up on $(-\infty, 0)$ and concave down on $(0, \infty)$. At $x = 0$ there is a point of inflection.

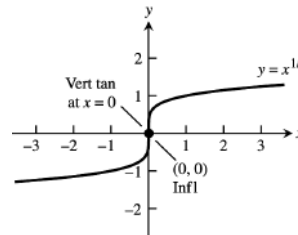

26. When $y = x^{3/5}$, then $y' = \frac{3}{5}x^{-2/5}$ and $y'' = -\frac{6}{25}x^{-7/5}$.
 The curve rises on $(-\infty, \infty)$ and there are no extrema.
 The curve is concave up on $(-\infty, 0)$ and concave down on $(0, \infty)$. At $x = 0$ there is a point of inflection.

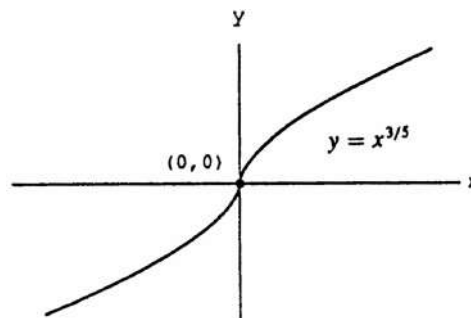

27. When $y = x^{2/5}$, then $y' = \frac{2}{5}x^{-3/5}$ and $y'' = -\frac{6}{25}x^{-8/5}$.
 The curve is rising on $(0, \infty)$ and falling on $(-\infty, 0)$. At $x = 0$ there is a local and absolute minimum. There is no local or absolute maximum. The curve is concave down on $(-\infty, 0)$ and $(0, \infty)$. There are no points of inflection, but a cusp exists at $x = 0$.

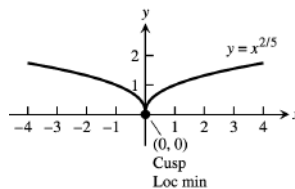

28. When $y = x^{4/5}$, then $y' = \frac{4}{5}x^{-1/5}$ and $y'' = -\frac{4}{25}x^{-6/5}$.
 The curve is rising on $(0, \infty)$ and falling on $(-\infty, 0)$. At $x = 0$ there is a local and absolute minimum. There is no local or absolute maximum. The curve is concave down on $(-\infty, 0)$ and $(0, \infty)$. There are no points of inflection, but a cusp exists at $x = 0$.

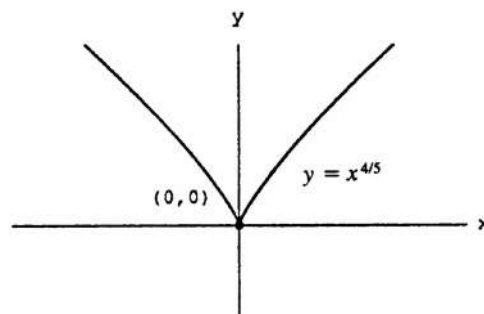

29. When $y = 2x - 3x^{2/3}$, then $y' = 2 - 2x^{-1/3}$ and $y'' = \frac{2}{3}x^{-4/3}$. The curve is rising on $(-\infty, 0)$ and $(1, \infty)$, and falling on $(0, 1)$. There is a local maximum at $x = 0$ and a local minimum at $x = 1$. The curve is concave up on $(-\infty, 0)$ and $(0, \infty)$. There are no points of inflection, but a cusp exists at $x = 0$.

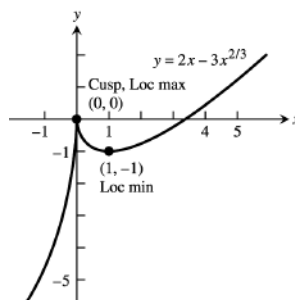

30. When $y = 5x^{2/5} - 2x$, then $y' = 2x^{-3/5} - 2 = 2(x^{-3/5} - 1)$ and $y'' = -\frac{6}{5}x^{-8/5}$. The curve is rising on $(0, 1)$ and falling on $(-\infty, 0)$ and $(1, \infty)$. There is a local minimum at $x = 0$ and a local maximum at $x = 1$. The curve is concave down on $(-\infty, 0)$ and $(0, \infty)$. There are no points of inflection, but a cusp exists at $x = 0$.

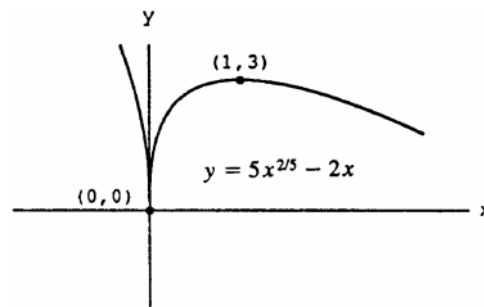

31. When $y = x^{2/3}(\frac{5}{2} - x) = \frac{5}{2}x^{2/3} - x^{5/3}$, then
 $y' = \frac{5}{3}x^{-1/3} - \frac{5}{3}x^{2/3} = \frac{5}{3}x^{-1/3}(1 - x)$ and
 $y'' = -\frac{5}{9}x^{-4/3} - \frac{10}{9}x^{-1/3} = -\frac{5}{9}x^{-4/3}(1 + 2x)$.

The curve is rising on $(0, 1)$ and falling on $(-\infty, 0)$ and $(1, \infty)$. There is a local minimum at $x = 0$ and a local maximum at $x = 1$. The curve is concave up on $(-\infty, -\frac{1}{2})$ and concave down on $(-\frac{1}{2}, 0)$ and $(0, \infty)$. There is a point of inflection at $x = -\frac{1}{2}$ and a cusp at $x = 0$.

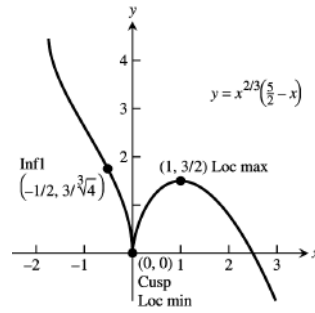

32. When $y = x^{2/3}(x - 5) = x^{5/3} - 5x^{2/3}$, then
 $y' = \frac{5}{3}x^{2/3} - \frac{10}{3}x^{-1/3} = \frac{5}{3}x^{-1/3}(x - 2)$ and
 $y'' = \frac{10}{9}x^{-1/3} + \frac{10}{9}x^{-4/3} = \frac{10}{9}x^{-4/3}(x + 1)$. The curve is rising on $(-\infty, 0)$ and $(2, \infty)$, and falling on $(0, 2)$. There is a local minimum at $x = 2$ and a local maximum at $x = 0$. The curve is concave up on $(-1, 0)$ and $(0, \infty)$, and concave down on $(-\infty, -1)$. There is a point of inflection at $x = -1$ and a cusp at $x = 0$.

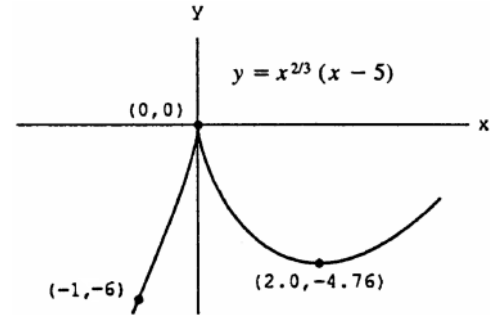

33. When $y = x\sqrt{8 - x^2} = x(8 - x^2)^{1/2}$, then
 $y' = (8 - x^2)^{1/2} + (x)(\frac{1}{2})(8 - x^2)^{-1/2}(-2x)$
 $= (8 - x^2)^{-1/2}(8 - 2x^2) = \frac{2(2-x)(2+x)}{\sqrt{(2\sqrt{2}+x)(2\sqrt{2}-x)}}$ and
 $y'' = (-\frac{1}{2})(8 - x^2)^{-3/2}(-2x)(8 - 2x^2) + (8 - x^2)^{-1/2}(-4x)$
 $= \frac{2x(x^2 - 12)}{\sqrt{(8 - x^2)^3}}$. The curve is rising on $(-2, 2)$, and falling on $(-2\sqrt{2}, -2)$ and $(2, 2\sqrt{2})$. There are local minima at $x = -2$ and $x = 2\sqrt{2}$, and local maxima at $x = -2\sqrt{2}$ and $x = 2$. The curve is concave up on $(-2\sqrt{2}, 0)$ and concave down on $(0, 2\sqrt{2})$. There is a point of inflection at $x = 0$.

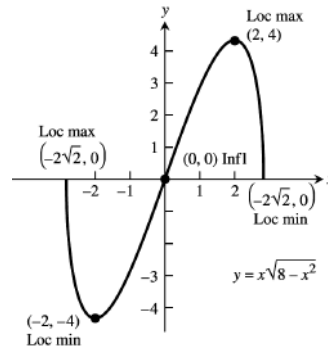

34. When $y = (2 - x^2)^{3/2}$, then $y' = (\frac{3}{2})(2 - x^2)^{1/2}(-2x)$
 $= -3x\sqrt{2 - x^2} = -3x\sqrt{(\sqrt{2} - x)(\sqrt{2} + x)}$ and
 $y'' = (-3)(2 - x^2)^{1/2} + (-3x)(\frac{1}{2})(2 - x^2)^{-1/2}(-2x)$
 $= \frac{-6(1-x)(1+x)}{\sqrt{(\sqrt{2}-x)(\sqrt{2}+x)}}$. The curve is rising on $(-\sqrt{2}, 0)$ and falling on $(0, \sqrt{2})$. There is a local maximum at $x = 0$, and local minima at $x = \pm\sqrt{2}$. The curve is concave down on $(-1, 1)$ and concave up on $(-\sqrt{2}, -1)$ and $(1, \sqrt{2})$. There are points of inflection at $x = \pm 1$.

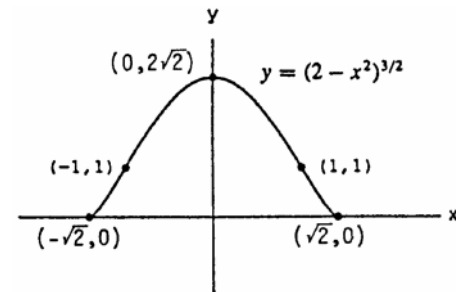

35. When $y = \frac{x^2-3}{x-2}$, then $y' = \frac{2x(x-2) - (x^2-3)(1)}{(x-2)^2}$
 $= \frac{(x-3)(x-1)}{(x-2)^2}$ and

$y'' = \frac{(2x-4)(x-2)^2 - (x^2-4x+3)2(x-2)}{(x-2)^3} = \frac{2}{(x-2)^3}$.

The curve is rising on $(-\infty, 1)$ and $(3, \infty)$, and falling on $(1, 2)$ and $(2, 3)$. There is a local maximum at $x = 1$ and a local minimum at $x = 3$. The curve is concave down on $(-\infty, 2)$ and concave up on $(2, \infty)$. There are no points of inflection because $x = 2$ is not in the domain.

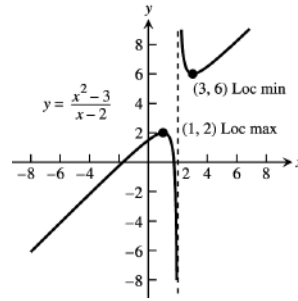

36. When $y = \frac{x^3}{3x^2+1}$, then $y' = \frac{3x^2(3x^2+1) - x^3(6x)}{(3x^2+1)^2}$
 $= \frac{3x^2(x^2+1)}{(3x^2+1)^2}$ and

$y'' = \frac{(12x^3+6x)(3x^2+1)^2 - 2(3x^2+1)(6x)(3x^4+3x^2)}{(3x^2+1)^4}$

$= \frac{6x(1-x)(1+x)}{(3x^2+1)^3}$. The curve is rising on $(-\infty, \infty)$ so

there are no local extrema. The curve is concave up on $(-\infty, -1)$ and $(0, 1)$, and concave down on $(-1, 0)$ and $(1, \infty)$. There are points of inflection at $x = -1$, $x = 0$, and $x = 1$.

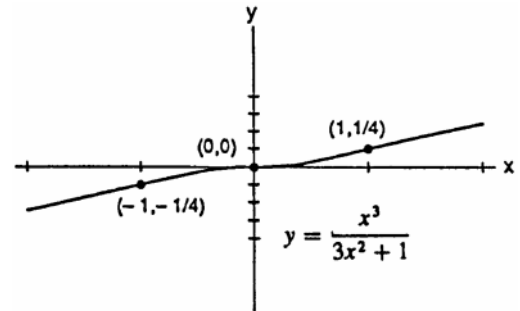

37. When $y = |x^2 - 1| = \begin{cases} x^2 - 1, & |x| \geq 1 \\ 1 - x^2, & |x| < 1 \end{cases}$, then

$y' = \begin{cases} 2x, & |x| > 1 \\ -2x, & |x| < 1 \end{cases}$ and $y'' = \begin{cases} 2, & |x| > 1 \\ -2, & |x| < 1 \end{cases}$. The

curve rises on $(-1, 0)$ and $(1, \infty)$ and falls on $(-\infty, -1)$ and $(0, 1)$. There is a local maximum at $x = 0$ and local minima at $x = \pm 1$. The curve is concave up on $(-\infty, -1)$ and $(1, \infty)$, and concave down on $(-1, 1)$. There are no points of inflection because y is not differentiable at $x = \pm 1$ (so there is no tangent line at those points).

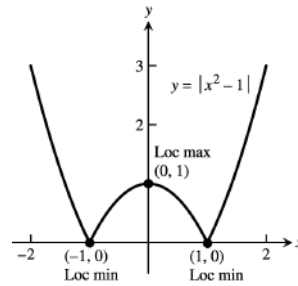

38. When $y = |x^2 - 2x| = \begin{cases} x^2 - 2x, & x < 0 \\ 2x - x^2, & 0 \leq x \leq 2 \\ x^2 - 2x, & x > 2 \end{cases}$, then

$y' = \begin{cases} 2x - 2, & x < 0 \\ 2 - 2x, & 0 < x < 2 \\ 2x - 2, & x > 2 \end{cases}$, and $y'' = \begin{cases} 2, & x < 0 \\ -2, & 0 < x < 2 \\ 2, & x > 2 \end{cases}$.

The curve is rising on $(0, 1)$ and $(2, \infty)$, and falling on $(-\infty, 0)$ and $(1, 2)$. There is a local maximum at $x = 1$ and local minima at $x = 0$ and $x = 2$. The curve is concave up on $(-\infty, 0)$ and $(2, \infty)$, and concave down on $(0, 2)$.

There are no points of inflection because y is not differentiable at $x = 0$ and $x = 2$ (so there is no tangent at those points).

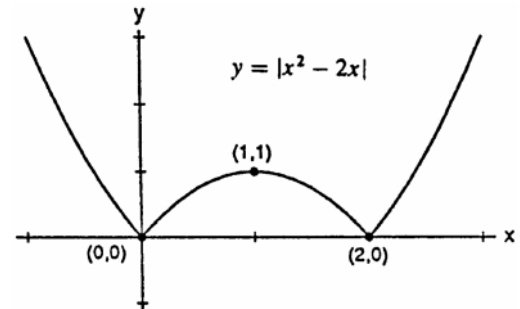

39. When $y = \sqrt{|x|} = \begin{cases} \sqrt{x}, & x \geq 0 \\ \sqrt{-x}, & x < 0 \end{cases}$, then

$$y' = \begin{cases} \frac{1}{2\sqrt{x}}, & x > 0 \\ \frac{-1}{2\sqrt{-x}}, & x < 0 \end{cases} \text{ and } y'' = \begin{cases} \frac{-x^{-3/2}}{4}, & x > 0 \\ \frac{-(-x)^{-3/2}}{4}, & x < 0 \end{cases}$$

Since $\lim_{x \rightarrow 0^-} y' = -\infty$ and $\lim_{x \rightarrow 0^+} y' = \infty$ there is a cusp at $x = 0$. There is a local minimum at $x = 0$, but no local maximum. The curve is concave down on $(-\infty, 0)$ and $(0, \infty)$. There are no points of inflection.

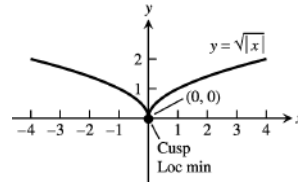

40. When $y = \sqrt{|x-4|} = \begin{cases} \sqrt{x-4}, & x \geq 4 \\ \sqrt{4-x}, & x < 4 \end{cases}$, then

$$y' = \begin{cases} \frac{1}{2\sqrt{x-4}}, & x > 4 \\ \frac{-1}{2\sqrt{4-x}}, & x < 4 \end{cases} \text{ and } y'' = \begin{cases} \frac{-(x-4)^{-3/2}}{4}, & x > 4 \\ \frac{-(-4-x)^{-3/2}}{4}, & x < 4 \end{cases}$$

Since $\lim_{x \rightarrow 4^-} y' = -\infty$ and $\lim_{x \rightarrow 4^+} y' = \infty$ there is a cusp at $x = 4$. There is a local minimum at $x = 4$, but no local maximum. The curve is concave down on $(-\infty, 4)$ and $(4, \infty)$. There are no points of inflection.

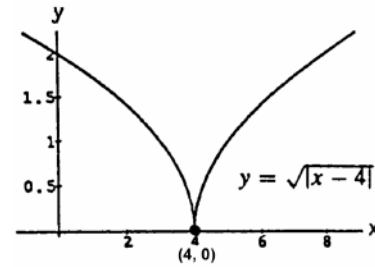

41. $y' = 2 + x - x^2 = (1+x)(2-x)$, $y' = \begin{matrix} - & - & - & | & + & + & + & | & - & - & - & - \\ & & & & -1 & & & & 2 & & & & \end{matrix}$

\Rightarrow rising on $(-1, 2)$, falling on $(-\infty, -1)$ and $(2, \infty)$
 \Rightarrow there is a local maximum at $x = 2$ and a local minimum at $x = -1$; $y'' = 1 - 2x$, $y'' = \begin{matrix} + & + & + & | & - & - & - & - \\ & & & & 1/2 & & & & \end{matrix}$

\Rightarrow concave up on $(-\infty, \frac{1}{2})$, concave down on $(\frac{1}{2}, \infty)$
 \Rightarrow a point of inflection at $x = \frac{1}{2}$

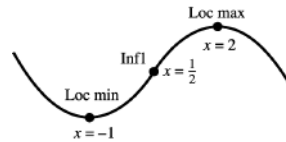

42. $y' = x^2 - x - 6 = (x-3)(x+2)$, $y' = \begin{matrix} + & + & + & | & - & - & - & | & + & + & + & + \\ & & & & -2 & & & & 3 & & & & \end{matrix}$

\Rightarrow rising on $(-\infty, -2)$ and $(3, \infty)$, falling on $(-2, 3)$
 \Rightarrow there is a local maximum at $x = -2$ and a local minimum at $x = 3$; $y'' = 2x - 1$, $y'' = \begin{matrix} - & - & - & | & + & + & + \\ & & & & 1/2 & & & & \end{matrix}$

\Rightarrow concave up on $(\frac{1}{2}, \infty)$, concave down on $(-\infty, \frac{1}{2})$
 \Rightarrow a point of inflection at $x = \frac{1}{2}$

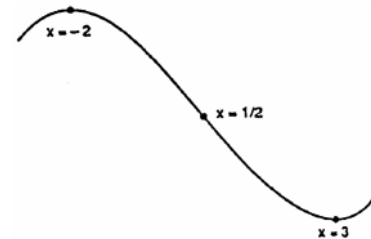

43. $y' = x(x-3)^2$, $y' = \begin{matrix} - & - & - & | & + & + & + & | & + & + & + & + \\ & & & & 0 & & & & 3 & & & & \end{matrix}$ \Rightarrow rising on

$(0, \infty)$, falling on $(-\infty, 0) \Rightarrow$ no local maximum, but there is a local minimum at $x = 0$; $y'' = (x-3)^2 + x(2)(x-3) = 3(x-3)(x-1)$, $y'' = \begin{matrix} + & + & + & | & - & - & - & | & + & + & + & + \\ & & & & 1 & & & & 3 & & & & \end{matrix}$ \Rightarrow concave

up on $(-\infty, 1)$ and $(3, \infty)$, concave down on $(1, 3) \Rightarrow$ points of inflection at $x = 1$ and $x = 3$

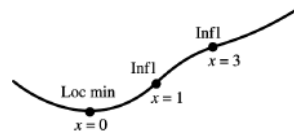

44. $y' = x^2(2 - x)$, $y' = \begin{matrix} + & + & + \\ 0 & & \end{matrix} \mid \begin{matrix} + & + & + \\ & & 2 \end{matrix} \mid \begin{matrix} - & - & - \\ & & \end{matrix} \Rightarrow$ rising on $(-\infty, 2)$, falling on $(2, \infty) \Rightarrow$ there is a local maximum at $x = 2$, but no local minimum; $y'' = 2x(2 - x) + x^2(-1) = x(4 - 3x)$, $y'' = \begin{matrix} - & - & - \\ 0 & & \end{matrix} \mid \begin{matrix} + & + & + \\ & & 4/3 \end{matrix} \mid \begin{matrix} - & - & - \\ & & \end{matrix} \Rightarrow$ concave up on $(0, \frac{4}{3})$, concave down on $(-\infty, 0)$ and $(\frac{4}{3}, \infty) \Rightarrow$ points of inflection at $x = 0$ and $x = \frac{4}{3}$

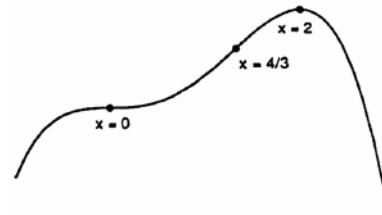

45. $y' = x(x^2 - 12) = x(x - 2\sqrt{3})(x + 2\sqrt{3})$, $y' = \begin{matrix} - & - & - \\ -2\sqrt{3} & & 0 \end{matrix} \mid \begin{matrix} + & + & + \\ & & 2\sqrt{3} \end{matrix} \mid \begin{matrix} - & - & - \\ & & \end{matrix} \mid \begin{matrix} + & + & + \\ & & \end{matrix} \Rightarrow$ rising on $(-2\sqrt{3}, 0)$ and $(2\sqrt{3}, \infty)$, falling on $(-\infty, -2\sqrt{3})$ and $(0, 2\sqrt{3}) \Rightarrow$ a local maximum at $x = 0$, local minima at $x = \pm 2\sqrt{3}$; $y'' = (1)(x^2 - 12) + (x)(2x) = 3(x - 2)(x + 2)$, $y'' = \begin{matrix} + & + & + \\ -2 & & 2 \end{matrix} \mid \begin{matrix} - & - & - \\ & & \end{matrix} \mid \begin{matrix} + & + & + \\ & & \end{matrix} \Rightarrow$ concave up on $(-\infty, -2)$ and $(2, \infty)$, concave down on $(-2, 2) \Rightarrow$ points of inflection at $x = \pm 2$

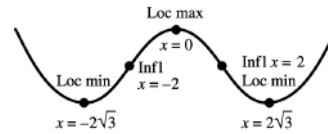

46. $y' = (x - 1)^2(2x + 3)$, $y' = \begin{matrix} - & - & - \\ -3/2 & & 1 \end{matrix} \mid \begin{matrix} + & + & + \\ & & 1 \end{matrix} \mid \begin{matrix} + & + & + \\ & & \end{matrix} \Rightarrow$ rising on $(-\frac{3}{2}, \infty)$, falling on $(-\infty, -\frac{3}{2}) \Rightarrow$ no local maximum, a local minimum at $x = -\frac{3}{2}$; $y'' = 2(x - 1)(2x + 3) + (x - 1)^2(2) = 2(x - 1)(3x + 2)$, $y'' = \begin{matrix} + & + & + \\ -2/3 & & 1 \end{matrix} \mid \begin{matrix} - & - & - \\ & & \end{matrix} \mid \begin{matrix} + & + & + \\ & & \end{matrix} \Rightarrow$ concave up on $(-\infty, -\frac{2}{3})$ and $(1, \infty)$, concave down on $(-\frac{2}{3}, 1) \Rightarrow$ points of inflection at $x = -\frac{2}{3}$ and $x = 1$

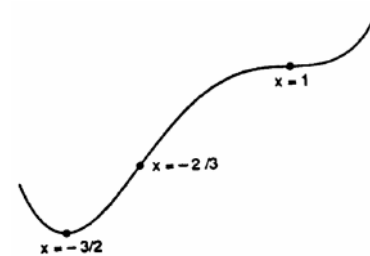

47. $y' = (8x - 5x^2)(4 - x)^2 = x(8 - 5x)(4 - x)^2$, $y' = \begin{matrix} - & - & - \\ 0 & & 8/5 \end{matrix} \mid \begin{matrix} + & + & + \\ & & 4 \end{matrix} \mid \begin{matrix} - & - & - \\ & & \end{matrix} \mid \begin{matrix} - & - & - \\ & & \end{matrix} \Rightarrow$ rising on $(0, \frac{8}{5})$, falling on $(-\infty, 0)$ and $(\frac{8}{5}, \infty) \Rightarrow$ a local maximum at $x = \frac{8}{5}$, a local minimum at $x = 0$; $y'' = (8 - 10x)(4 - x)^2 + (8x - 5x^2)(2)(4 - x)(-1) = 4(4 - x)(5x^2 - 16x + 8)$, $y'' = \begin{matrix} + & + & + \\ 8-2\sqrt{6} & & 8+2\sqrt{6} \end{matrix} \mid \begin{matrix} - & - & - \\ & & 4 \end{matrix} \mid \begin{matrix} + & + & + \\ & & \end{matrix} \mid \begin{matrix} - & - & - \\ & & \end{matrix} \Rightarrow$ concave up on $(-\infty, \frac{8-2\sqrt{6}}{5})$ and $(\frac{8+2\sqrt{6}}{5}, 4)$, concave down on $(\frac{8-2\sqrt{6}}{5}, \frac{8+2\sqrt{6}}{5})$ and $(4, \infty) \Rightarrow$ points of inflection at $x = \frac{8 \pm 2\sqrt{6}}{5}$ and $x = 4$

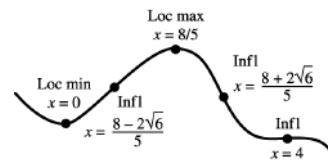

48. $y' = (x^2 - 2x)(x - 5)^2 = x(x - 2)(x - 5)^2$,
 $y' = \begin{matrix} +++ \\ 0 \end{matrix} \begin{matrix} | \\ 2 \end{matrix} \begin{matrix} --- \\ 5 \end{matrix} \begin{matrix} | \\ 5 \end{matrix} \begin{matrix} +++ \\ 5 \end{matrix} \Rightarrow$ rising on $(-\infty, 0)$
 and $(2, \infty)$, falling on $(0, 2) \Rightarrow$ a local maximum at $x = 0$,
 a local minimum at $x = 2$;
 $y'' = (2x - 2)(x - 5)^2 + (x^2 - 2x)(2)(x - 5)$
 $= 2(x - 5)(2x^2 - 8x + 5)$,
 $y'' = \begin{matrix} --- \\ \frac{4-\sqrt{6}}{2} \end{matrix} \begin{matrix} | \\ \frac{4+\sqrt{6}}{2} \end{matrix} \begin{matrix} +++ \\ 5 \end{matrix} \begin{matrix} | \\ 5 \end{matrix} \begin{matrix} --- \\ 5 \end{matrix} \begin{matrix} | \\ 5 \end{matrix} \begin{matrix} +++ \\ 5 \end{matrix} \Rightarrow$ concave up
 on $(\frac{4-\sqrt{6}}{2}, \frac{4+\sqrt{6}}{2})$ and $(5, \infty)$, concave down on
 $(-\infty, \frac{4-\sqrt{6}}{2})$ and $(\frac{4+\sqrt{6}}{2}, 5) \Rightarrow$ points of inflection at
 $x = \frac{4 \pm \sqrt{6}}{2}$ and $x = 5$

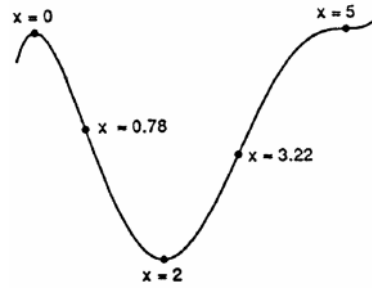

49. $y' = \sec^2 x$, $y' = \begin{matrix} (\\ -\pi/2 \end{matrix} \begin{matrix} +++ \\ \pi/2 \end{matrix} \Rightarrow$ rising on $(-\frac{\pi}{2}, \frac{\pi}{2})$,
 never falling \Rightarrow no local extrema;
 $y'' = 2(\sec x)(\sec x)(\tan x) = 2(\sec^2 x)(\tan x)$,
 $y'' = \begin{matrix} (\\ -\pi/2 \end{matrix} \begin{matrix} --- \\ 0 \end{matrix} \begin{matrix} | \\ \pi/2 \end{matrix} \begin{matrix} +++ \\ \pi/2 \end{matrix} \Rightarrow$ concave up on $(0, \frac{\pi}{2})$,
 concave down on $(-\frac{\pi}{2}, 0)$, 0 is a point of inflection.

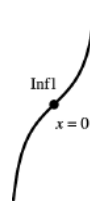

50. $y' = \tan x$, $y' = \begin{matrix} (\\ -\pi/2 \end{matrix} \begin{matrix} --- \\ 0 \end{matrix} \begin{matrix} | \\ \pi/2 \end{matrix} \begin{matrix} +++ \\ \pi/2 \end{matrix} \Rightarrow$ rising on $(0, \frac{\pi}{2})$,
 falling on $(-\frac{\pi}{2}, 0) \Rightarrow$ no local maximum, a local minimum
 at $x = 0$; $y'' = \sec^2 x$, $y'' = \begin{matrix} (\\ -\pi/2 \end{matrix} \begin{matrix} +++ \\ \pi/2 \end{matrix} \Rightarrow$ concave up
 on $(-\frac{\pi}{2}, \frac{\pi}{2}) \Rightarrow$ no points of inflection

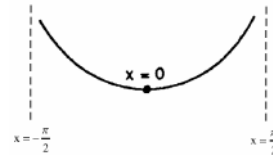

51. $y' = \cot \frac{\theta}{2}$, $y' = \begin{matrix} (\\ 0 \end{matrix} \begin{matrix} +++ \\ \pi \end{matrix} \begin{matrix} | \\ 2\pi \end{matrix} \begin{matrix} --- \\ 2\pi \end{matrix} \Rightarrow$ rising on $(0, \pi)$,
 falling on $(\pi, 2\pi) \Rightarrow$ a local maximum at $\theta = \pi$, no local
 minimum; $y'' = -\frac{1}{2} \csc^2 \frac{\theta}{2}$, $y'' = \begin{matrix} (\\ 0 \end{matrix} \begin{matrix} --- \\ 2\pi \end{matrix} \Rightarrow$ never
 concave up, concave down on $(0, 2\pi) \Rightarrow$ no points of
 inflection

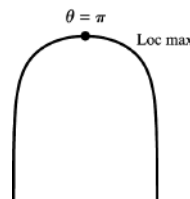

52. $y' = \csc^2 \frac{\theta}{2}$, $y' = \begin{matrix} (\\ 0 \end{matrix} \begin{matrix} +++ \\ 2\pi \end{matrix} \Rightarrow$ rising on $(0, 2\pi)$, never
 falling \Rightarrow no local extrema;
 $y'' = 2(\csc \frac{\theta}{2})(-\csc \frac{\theta}{2})(\cot \frac{\theta}{2})(\frac{1}{2})$
 $= -(\csc^2 \frac{\theta}{2})(\cot \frac{\theta}{2})$, $y'' = \begin{matrix} (\\ 0 \end{matrix} \begin{matrix} --- \\ \pi \end{matrix} \begin{matrix} | \\ 2\pi \end{matrix} \begin{matrix} +++ \\ 2\pi \end{matrix} \Rightarrow$
 \Rightarrow concave up on $(\pi, 2\pi)$, concave down on $(0, \pi)$
 \Rightarrow a point of inflection at $\theta = \pi$

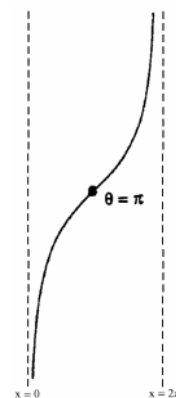

53. $y' = \tan^2 \theta - 1 = (\tan \theta - 1)(\tan \theta + 1)$,
 $y' = \left(\begin{array}{c|c|c} +++ & --- & +++ \\ -\pi/2 & -\pi/4 & \pi/4 & \pi/2 \end{array} \right) \Rightarrow$ rising on
 $\left(-\frac{\pi}{2}, -\frac{\pi}{4}\right)$ and $\left(\frac{\pi}{4}, \frac{\pi}{2}\right)$, falling on $\left(-\frac{\pi}{4}, \frac{\pi}{4}\right)$
 \Rightarrow a local maximum at $\theta = -\frac{\pi}{4}$, a local minimum at $\theta = \frac{\pi}{4}$;
 $y'' = 2 \tan \theta \sec^2 \theta$, $y'' = \left(\begin{array}{c|c|c} --- & 0 & +++ \\ -\pi/2 & 0 & \pi/2 \end{array} \right)$
 \Rightarrow concave up on $\left(0, \frac{\pi}{2}\right)$, concave down on $\left(-\frac{\pi}{2}, 0\right)$
 \Rightarrow a point of inflection at $\theta = 0$

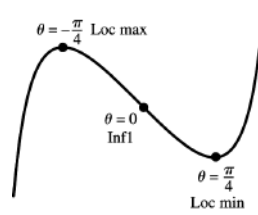

54. $y' = 1 - \cot^2 \theta = (1 - \cot \theta)(1 + \cot \theta)$,
 $y' = \left(\begin{array}{c|c|c} --- & +++ & --- \\ 0 & \pi/4 & 3\pi/4 & \pi \end{array} \right) \Rightarrow$ rising on $\left(\frac{\pi}{4}, \frac{3\pi}{4}\right)$,
falling on $\left(0, \frac{\pi}{4}\right)$ and $\left(\frac{3\pi}{4}, \pi\right) \Rightarrow$ a local maximum at
 $\theta = \frac{3\pi}{4}$, a local minimum at $\theta = \frac{\pi}{4}$;
 $y'' = -2(\cot \theta)(-\csc^2 \theta)$, $y'' = \left(\begin{array}{c|c|c} +++ & --- \\ 0 & \pi/2 & \pi \end{array} \right)$
 \Rightarrow concave up on $\left(0, \frac{\pi}{2}\right)$, concave down on $\left(\frac{\pi}{2}, \pi\right)$
 \Rightarrow a point of inflection at $\theta = \frac{\pi}{2}$

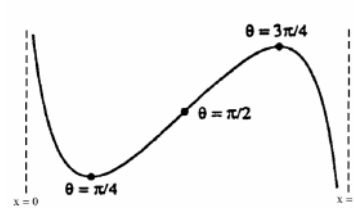

55. $y' = \cos t$, $y' = \left[\begin{array}{c|c|c|c} +++ & --- & +++ \\ 0 & \pi/2 & 3\pi/2 & 2\pi \end{array} \right] \Rightarrow$ rising on
 $\left(0, \frac{\pi}{2}\right)$ and $\left(\frac{3\pi}{2}, 2\pi\right)$, falling on $\left(\frac{\pi}{2}, \frac{3\pi}{2}\right) \Rightarrow$ local maxima at
 $t = \frac{\pi}{2}$ and $t = 2\pi$, local minima at $t = 0$ and $t = \frac{3\pi}{2}$;
 $y'' = -\sin t$, $y'' = \left[\begin{array}{c|c|c} --- & +++ \\ 0 & \pi & 2\pi \end{array} \right]$
 \Rightarrow concave up on $(\pi, 2\pi)$, concave down
on $(0, \pi) \Rightarrow$ a point of inflection at $t = \pi$

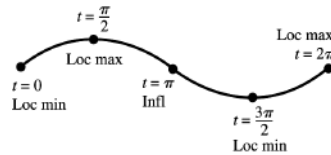

56. $y' = \sin t$, $y' = \left[\begin{array}{c|c|c} +++ & --- \\ 0 & \pi & 2\pi \end{array} \right] \Rightarrow$ rising on $(0, \pi)$,
falling on $(\pi, 2\pi) \Rightarrow$ a local maximum at $t = \pi$, local
minima at $t = 0$ and $t = 2\pi$; $y'' = \cos t$,
 $y'' = \left[\begin{array}{c|c|c} +++ & --- & +++ \\ 0 & \pi/2 & 3\pi/2 & 2\pi \end{array} \right] \Rightarrow$ concave up on $\left(0, \frac{\pi}{2}\right)$
and $\left(\frac{3\pi}{2}, 2\pi\right)$, concave down on $\left(\frac{\pi}{2}, \frac{3\pi}{2}\right) \Rightarrow$ points
of inflection at $t = \frac{\pi}{2}$ and $t = \frac{3\pi}{2}$

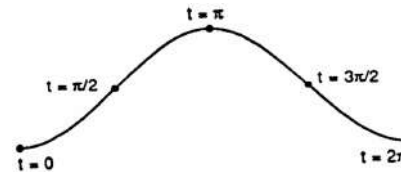

57. $y' = (x + 1)^{-2/3}$, $y' = \begin{array}{c} +++ \\ -1 \end{array} \Rightarrow$ rising on
 $(-\infty, \infty)$, never falling \Rightarrow no local extrema;
 $y'' = -\frac{2}{3}(x + 1)^{-5/3}$, $y'' = \begin{array}{c} +++ \\ -1 \end{array} \Rightarrow$
 \Rightarrow concave up on $(-\infty, -1)$, concave down on $(-1, \infty)$
 \Rightarrow a point of inflection and vertical tangent at $x = -1$

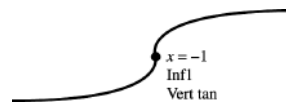

58. $y' = (x - 2)^{-1/3}, y' = \text{---} | \text{+++} \Rightarrow$ rising on $(2, \infty)$,
 falling on $(-\infty, 2) \Rightarrow$ no local maximum, but a local
 minimum at $x = 2; y'' = -\frac{1}{3}(x - 2)^{-4/3},$
 $y'' = \text{---} | \text{---} \Rightarrow$ concave down on $(-\infty, 2)$ and
 $(2, \infty) \Rightarrow$ no points of inflection, but there is a cusp at
 $x = 2$

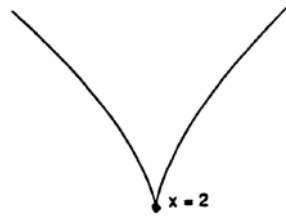

59. $y' = x^{-2/3}(x - 1), y' = \text{---} | \text{+++} \Rightarrow$ rising on
 $(1, \infty)$, falling on $(-\infty, 1) \Rightarrow$ no local maximum, but a
 local minimum at $x = 1; y'' = \frac{1}{3}x^{-2/3} + \frac{2}{3}x^{-5/3}$
 $= \frac{1}{3}x^{-5/3}(x + 2), y'' = \text{+++} | \text{---} | \text{+++}$
 \Rightarrow concave up on $(-\infty, -2)$ and $(0, \infty)$, concave down on
 $(-2, 0) \Rightarrow$ points of inflection at $x = -2$ and $x = 0$, and a
 vertical tangent at $x = 0$

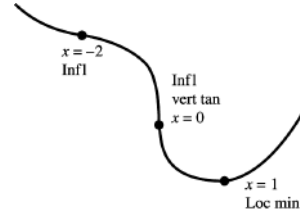

60. $y' = x^{-4/5}(x + 1), y' = \text{---} | \text{+++} \Rightarrow$ rising on
 $(-1, 0)$ and $(0, \infty)$, falling on $(-\infty, -1) \Rightarrow$ no local
 maximum, but a local minimum at $x = -1;$
 $y'' = \frac{1}{5}x^{-4/5} - \frac{4}{5}x^{-9/5} = \frac{1}{5}x^{-9/5}(x - 4),$
 $y'' = \text{+++} | \text{---} | \text{+++} \Rightarrow$ concave up on $(-\infty, 0)$ and
 $(4, \infty)$, concave down on $(0, 4) \Rightarrow$ points of inflection at
 $x = 0$ and $x = 4$, and a vertical tangent at $x = 0$

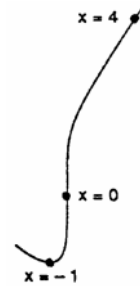

61. $y' = \begin{cases} -2x, & x \leq 0 \\ 2x, & x > 0 \end{cases}, y' = \text{+++} | \text{+++} \Rightarrow$ rising on
 $(-\infty, \infty) \Rightarrow$ no local extrema; $y'' = \begin{cases} -2, & x < 0 \\ 2, & x > 0 \end{cases},$
 $y'' = \text{---} | \text{+++} \Rightarrow$ concave up on $(0, \infty)$, concave
 down on $(-\infty, 0) \Rightarrow$ a point of inflection at $x = 0$

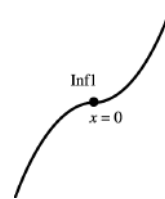

62. $y' = \begin{cases} -x^2, & x \leq 0 \\ x^2, & x > 0 \end{cases}, y' = \text{---} | \text{+++} \Rightarrow$ rising on
 $(0, \infty)$, falling on $(-\infty, 0) \Rightarrow$ no local maximum, but a
 local minimum at $x = 0; y'' = \begin{cases} -2x, & x \leq 0 \\ 2x, & x > 0 \end{cases},$
 $y'' = \text{+++} | \text{+++} \Rightarrow$ concave up on $(-\infty, \infty)$
 \Rightarrow no point of inflection

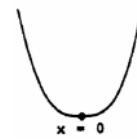

63. The graph of $y = f''(x) \Rightarrow$ the graph of $y = f(x)$ is concave up on $(0, \infty)$, concave down on $(-\infty, 0) \Rightarrow$ a point of inflection at $x = 0$; the graph of $y = f'(x) \Rightarrow y' = +++ | --- | +++ \Rightarrow$ the graph $y = f(x)$ has both a local maximum and a local minimum

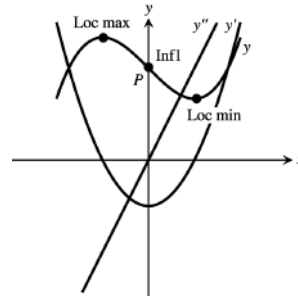

64. The graph of $y = f''(x) \Rightarrow y'' = +++ | --- \Rightarrow$ the graph of $y = f(x)$ has a point of inflection, the graph of $y = f'(x) \Rightarrow y' = --- | +++ | --- \Rightarrow$ the graph of $y = f(x)$ has both a local maximum and a local minimum

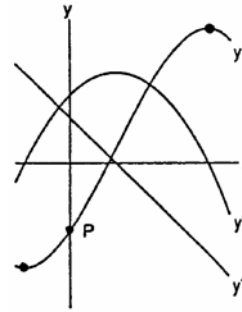

65. The graph of $y = f''(x) \Rightarrow y'' = --- | +++ | --- \Rightarrow$ the graph of $y = f(x)$ has two points of inflection, the graph of $y = f'(x) \Rightarrow y' = --- | +++ \Rightarrow$ the graph of $y = f(x)$ has a local minimum

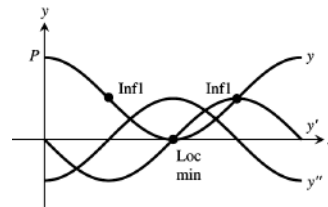

66. The graph of $y = f''(x) \Rightarrow y'' = +++ | --- \Rightarrow$ the graph of $y = f(x)$ has a point of inflection; the graph of $y = f'(x) \Rightarrow y' = --- | +++ | --- \Rightarrow$ the graph of $y = f(x)$ has both a local maximum and a local minimum

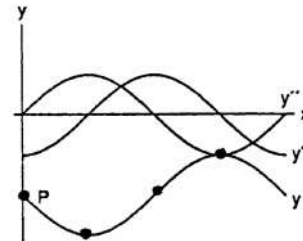

67.

Point	y'	y''
P	-	+
Q	+	0
R	+	-
S	0	-
T	-	-

68.

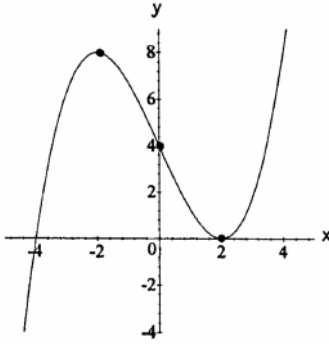

69.

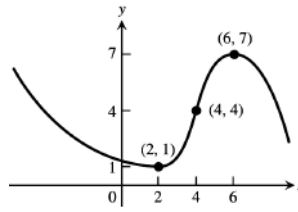

70.

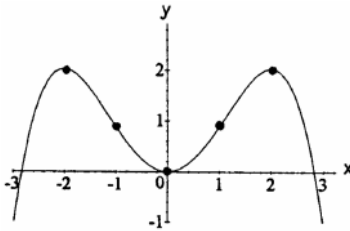

71. Graphs printed in color can shift during a press run, so your values may differ somewhat from those given here.

- (a) The body is moving away from the origin when $|\text{displacement}|$ is increasing as t increases, $0 < t < 2$ and $6 < t < 9.5$; the body is moving toward the origin when $|\text{displacement}|$ is decreasing as t increases, $2 < t < 6$ and $9.5 < t < 15$
- (b) The velocity will be zero when the slope of the tangent line for $y = s(t)$ is horizontal. The velocity is zero when t is approximately 2, 6, or 9.5 sec.
- (c) The acceleration will be zero at those values of t where the curve $y = s(t)$ has points of inflection. The acceleration is zero when t is approximately 4, 7.5, or 12.5 sec.
- (d) The acceleration is positive when the concavity is up, $4 < t < 7.5$ and $12.5 < t < 15$; the acceleration is negative when the concavity is down, $0 < t < 4$ and $7.5 < t < 12.5$

72. (a) The body is moving away from the origin when $|\text{displacement}|$ is increasing as t increases, $1.5 < t < 4$, $10 < t < 12$ and $13.5 < t < 16$; the body is moving toward the origin when $|\text{displacement}|$ is decreasing as t increases, $0 < t < 1.5$, $4 < t < 10$ and $12 < t < 13.5$

- (b) The velocity will be zero when the slope of the tangent line for $y = s(t)$ is horizontal. The velocity is zero when t is approximately 0, 4, 12 or 16 sec.
- (c) The acceleration will be zero at those values of t where the curve $y = s(t)$ has points of inflection. The acceleration is zero when t is approximately 1.5, 6, 8, 10.5, or 13.5 sec.
- (d) The acceleration is positive when the concavity is up, $0 < t < 1.5$, $6 < t < 8$ and $10 < t < 13.5$, the acceleration is negative when the concavity is down, $1.5 < t < 6$, $8 < t < 10$ and $13.5 < t < 16$.

73. The marginal cost is $\frac{dc}{dx}$ which changes from decreasing to increasing when its derivative $\frac{d^2c}{dx^2}$ is zero. This is a point of inflection of the cost curve and occurs when the production level x is approximately 60 thousand units.

74. The marginal revenue is $\frac{dy}{dx}$ and it is increasing when its derivative $\frac{d^2y}{dx^2}$ is positive \Rightarrow the curve is concave up $\Rightarrow 0 < t < 2$ and $5 < t < 9$; marginal revenue is decreasing when $\frac{d^2y}{dx^2} < 0 \Rightarrow$ the curve is concave down $\Rightarrow 2 < t < 5$ and $9 < t < 12$.

75. When $y' = (x - 1)^2(x - 2)$, then $y'' = 2(x - 1)(x - 2) + (x - 1)^2$. The curve falls on $(-\infty, 2)$ and rises on $(2, \infty)$. At $x = 2$ there is a local minimum. There is no local maximum. The curve is concave upward on $(-\infty, 1)$ and

$(\frac{5}{3}, \infty)$, and concave downward on $(1, \frac{5}{3})$. At $x = 1$ or $x = \frac{5}{3}$ there are inflection points.

76. When $y' = (x - 1)^2(x - 2)(x - 4)$, then $y'' = 2(x - 1)(x - 2)(x - 4) + (x - 1)^2(x - 4) + (x - 1)^2(x - 2)$
 $= (x - 1)[2(x^2 - 6x + 8) + (x^2 - 5x + 4) + (x^2 - 3x + 2)] = 2(x - 1)(2x^2 - 10x + 11)$. The curve rises on $(-\infty, 2)$ and $(4, \infty)$ and falls on $(2, 4)$. At $x = 2$ there is a local maximum and at $x = 4$ a local minimum. The curve is concave downward on $(-\infty, 1)$ and $(\frac{5-\sqrt{3}}{2}, \frac{5+\sqrt{3}}{2})$ and concave upward on $(1, \frac{5-\sqrt{3}}{2})$ and $(\frac{5+\sqrt{3}}{2}, \infty)$. At $x = 1, \frac{5-\sqrt{3}}{2}$ and $\frac{5+\sqrt{3}}{2}$ there are inflection points.

77. The graph must be concave down for $x > 0$ because

$$f''(x) = -\frac{1}{x^2} < 0.$$

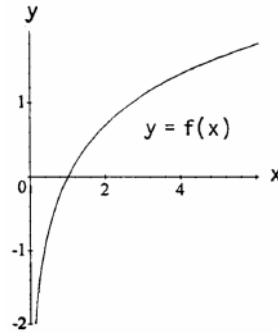

78. The second derivative, being continuous and never zero, cannot change sign. Therefore the graph will always be concave up or concave down so it will have no inflection points and no cusps or corners.

79. The curve will have a point of inflection at $x = 1$ if 1 is a solution of $y'' = 0$; $y = x^3 + bx^2 + cx + d$
 $\Rightarrow y' = 3x^2 + 2bx + c \Rightarrow y'' = 6x + 2b$ and $6(1) + 2b = 0 \Rightarrow b = -3$.

80. (a) True. If $f(x)$ is a polynomial of even degree then f' is of odd degree. Every polynomial of odd degree has at least one real root $\Rightarrow f'(x) = 0$ for some $x = r \Rightarrow f$ has a horizontal tangent at $x = r$.

(b) False. For example, $f(x) = x - 1$ is a polynomial of odd degree but $f'(x) = 1$ is never 0. As another example, $y = \frac{1}{3}x^3 + x^2 + x$ is a polynomial of odd degree, but $y' = x^2 + 2x + 1 = (x + 1)^2 > 0$ for all x .

81. (a) $f(x) = ax^2 + bx + c = a(x^2 + \frac{b}{a}x) + c = a(x^2 + \frac{b}{a}x + \frac{b^2}{4a^2}) - \frac{b^2}{4a} + c = a(x + \frac{b}{2a})^2 - \frac{b^2 - 4ac}{4a}$ a parabola whose vertex is at $x = -\frac{b}{2a} \Rightarrow$ the coordinates of the vertex are $(-\frac{b}{2a}, -\frac{b^2 - 4ac}{4a})$

(b) The second derivative, $f''(x) = 2a$, describes concavity \Rightarrow when $a > 0$ the parabola is concave up and when $a < 0$ the parabola is concave down.

82. No, $f''(x)$ could be decreasing to zero at $x = c$ and then increase again so it would be concave up on every interval even though $f''(x) = 0$. For example $f(x) = x^4$ is always concave up even though $f''(0) = 0$.

83. A quadratic curve never has an inflection point. If $y = ax^2 + bx + c$ where $a \neq 0$, then $y' = 2ax + b$ and $y'' = 2a$. Since $2a$ is a constant, it is not possible for y'' to change signs.

84. A cubic curve always has exactly one inflection point. If $y = ax^3 + bx^2 + cx + d$ where $a \neq 0$, then $y' = 3ax^2 + 2bx + c$ and $y'' = 6ax + 2b$. Since $-\frac{b}{3a}$ is a solution of $y'' = 0$, we have that y'' changes its sign at $x = -\frac{b}{3a}$ and y' exists everywhere (so there is a tangent at $x = -\frac{b}{3a}$). Thus the curve has an inflection point at $x = -\frac{b}{3a}$. There are no other inflection points because y'' changes sign only at this zero.

85. If $y = x^5 - 5x^4 - 240$, then $y' = 5x^3(x - 4)$ and $y'' = 20x^2(x - 3)$. The zeros of y' are extrema, and there is a point of inflection at $x = 3$.

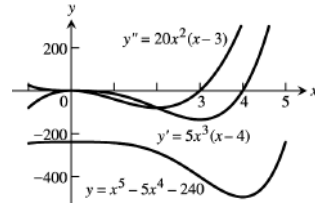

86. If $y = x^3 - 12x^2$, then $y' = 3x(x - 8)$ and $y'' = 6(x - 4)$. The zeros of y' and y'' are extrema and points of inflection, respectively.

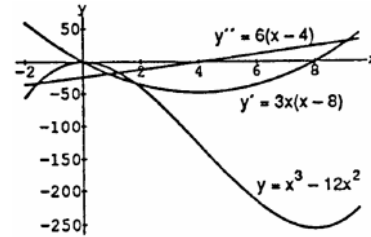

87. If $y = \frac{4}{3}x^5 + 16x^2 - 25$, then $y' = 4x(x^3 + 8)$ and $y'' = 16(x^3 + 2)$. The zeros of y' and y'' are extrema and points of inflection, respectively.

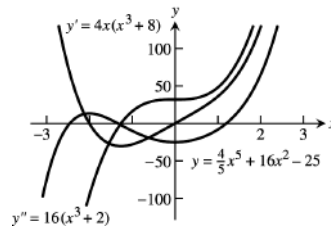

88. If $y = \frac{x^4}{4} - \frac{x^3}{3} - 4x^2 + 12x + 20$, then $y' = x^3 - x^2 - 8x + 12 = (x + 3)(x - 2)^2$. So y has a local minimum at $x = -3$ as its only extreme value. Also $y'' = 3x^2 - 2x - 8 = (3x + 4)(x - 2)$ and there are inflection points at both zeros, $-\frac{4}{3}$ and 2, of y'' .

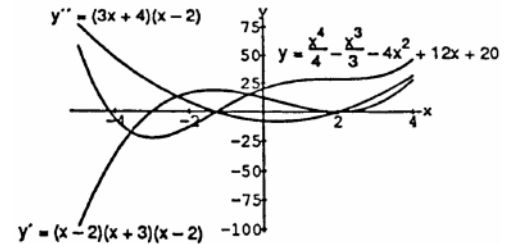

89. The graph of f falls where $f' < 0$, rises where $f' > 0$, and has horizontal tangents where $f' = 0$. It has local minima at points where f' changes from negative to positive and local maxima where f' changes from positive to negative. The graph of f is concave down where $f'' < 0$ and concave up where $f'' > 0$. It has an inflection point each time f'' changes sign, provided a tangent line exists there.

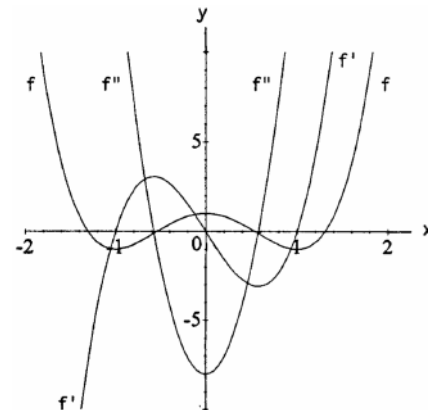

90. The graph f is concave down where $f'' < 0$, and concave up where $f'' > 0$. It has an inflection point each time f'' changes sign, provided a tangent line exists there.

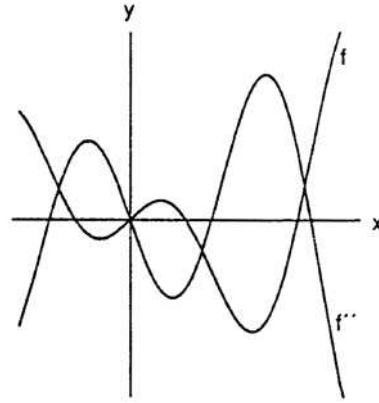

91. (a) It appears to control the number and magnitude of the local extrema. If $k < 0$, there is a local maximum to the left of the origin and a local minimum to the right. The larger the magnitude of k ($k < 0$), the greater the magnitude of the extrema. If $k > 0$, the graph has only positive slopes and lies entirely in the first and third quadrants with no local extrema. The graph becomes increasingly steep and straight as $k \rightarrow \infty$.

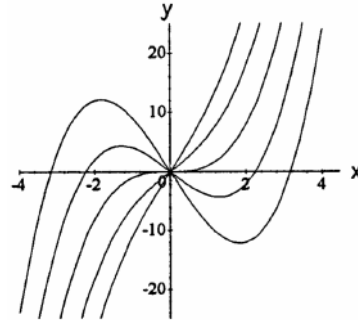

(b) $f'(x) = 3x^2 + k \Rightarrow$ the discriminant $0^2 - 4(3)(k) = -12k$ is positive for $k < 0$, zero for $k = 0$, and negative for $k > 0$; f' has two zeros $x = \pm \sqrt{-\frac{k}{3}}$ when $k < 0$, one zero $x = 0$ when $k = 0$ and no real zeros when $k > 0$; the sign of k controls the number of local extrema.

(c) As $k \rightarrow \infty$, $f'(x) \rightarrow \infty$ and the graph becomes increasingly steep and straight. As $k \rightarrow -\infty$, the crest of the graph (local maximum) in the second quadrant becomes increasingly high and the trough (local minimum) in the fourth quadrant becomes increasingly deep.

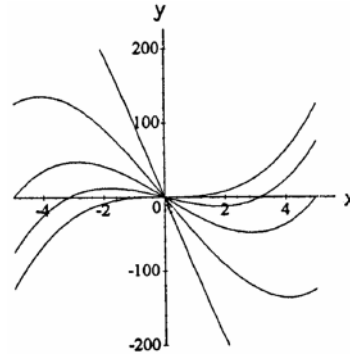

92. (a) It appears to control the concavity and the number of local extrema.

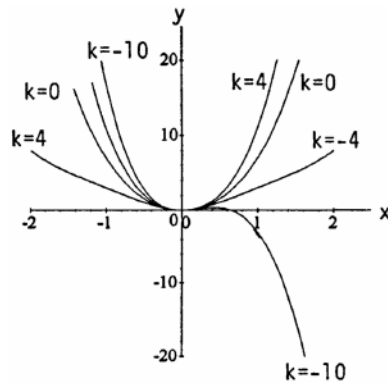

(b) $f(x) = x^4 + kx^3 + 6x^2 \Rightarrow f'(x) = 4x^3 + 3kx^2 + 12x$
 $\Rightarrow f''(x) = 12x^2 + 6kx + 12 \Rightarrow$ the discriminant is $36k^2 - 4(12)(12) = 36(k+4)(k-4)$, so the sign line of the discriminant is $\begin{matrix} +++ & | & --- & | & +++ \\ -4 & & & & 4 \end{matrix} \Rightarrow$ the discriminant is positive when $|k| > 4$, zero when $k = \pm 4$, and negative when $|k| < 4$; $f''(x) = 0$ has two zeros when $|k| > 4$, one zero when $k = \pm 4$, and no real zeros for $|k| < 4$; the value of k controls the number of possible points of inflection.

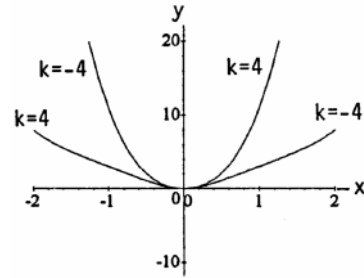

93. (a) If $y = x^{2/3}(x^2 - 2)$, then $y' = \frac{4}{3}x^{-1/3}(2x^2 - 1)$ and $y'' = \frac{4}{9}x^{-4/3}(10x^2 + 1)$. The curve rises on $(-\frac{1}{\sqrt{2}}, 0)$ and $(\frac{1}{\sqrt{2}}, \infty)$ and falls on $(-\infty, -\frac{1}{\sqrt{2}})$ and $(0, \frac{1}{\sqrt{2}})$. The curve is concave up on $(-\infty, 0)$ and $(0, \infty)$.

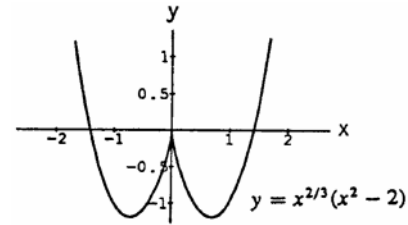

(b) A cusp since $\lim_{x \rightarrow 0^-} y' = \infty$ and $\lim_{x \rightarrow 0^+} y' = -\infty$.

94. (a) If $y = 9x^{2/3}(x - 1)$, then $y' = \frac{15(x - \frac{2}{3})}{x^{1/3}}$ and $y'' = \frac{10(x + \frac{1}{3})}{x^{4/3}}$. The curve rises on $(-\infty, 0)$ and $(\frac{2}{5}, \infty)$ and falls on $(0, \frac{2}{5})$. The curve is concave down on $(-\infty, -\frac{1}{5})$ and concave up on $(-\frac{1}{5}, 0)$ and $(0, \infty)$.

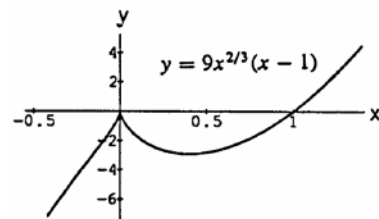

(b) A cusp since $\lim_{x \rightarrow 0^-} y' = \infty$ and $\lim_{x \rightarrow 0^+} y' = -\infty$.

95. Yes: $y = x^2 + 3 \sin 2x \Rightarrow y' = 2x + 6 \cos 2x$. The graph of y' is zero near -3 and this indicates a horizontal tangent near $x = -3$.

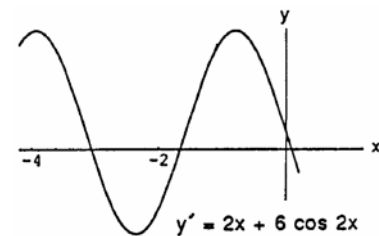

4.5 APPLIED OPTIMIZATION PROBLEMS

1. Let ℓ and w represent the length and width of the rectangle, respectively. With an area of 16 in.^2 , we have that $(\ell)(w) = 16 \Rightarrow w = 16\ell^{-1} \Rightarrow$ the perimeter is $P = 2\ell + 2w = 2\ell + 32\ell^{-1}$ and $P'(\ell) = 2 - \frac{32}{\ell^2} = \frac{2(\ell^2 - 16)}{\ell^2}$. Solving $P'(\ell) = 0 \Rightarrow \frac{2(\ell+4)(\ell-4)}{\ell^2} = 0 \Rightarrow \ell = -4, 4$. Since $\ell > 0$ for the length of a rectangle, ℓ must be 4 and $w = 4 \Rightarrow$ the perimeter is 16 in. , a minimum since $P''(\ell) = \frac{16}{\ell^3} > 0$.

2. Let x represent the length of the rectangle in meters ($0 < x < 4$) Then the width is $4 - x$ and the area is $A(x) = x(4 - x) = 4x - x^2$. Since $A'(x) = 4 - 2x$, the critical point occurs at $x = 2$. Since, $A'(x) > 0$ for $0 < x < 2$ and $A'(x) < 0$ for $2 < x < 4$, this critical point corresponds to the maximum area. The rectangle with the largest area measures 2 m by $4 - 2 = 2 \text{ m}$, so it is a square.

Graphical Support:

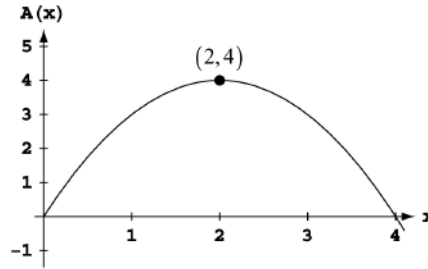

3. (a) The line containing point P also contains the points (0, 1) and (1, 0) \Rightarrow the line containing P is $y = 1 - x$
 \Rightarrow a general point on that line is $(x, 1 - x)$.
 (b) The area $A(x) = 2x(1 - x)$, where $0 \leq x \leq 1$.
 (c) When $A(x) = 2x - 2x^2$, then $A'(x) = 0 \Rightarrow 2 - 4x = 0 \Rightarrow x = \frac{1}{2}$. Since $A(0) = 0$ and $A(1) = 0$, we conclude that $A(\frac{1}{2}) = \frac{1}{2}$ sq units is the largest area. The dimensions are 1 unit by $\frac{1}{2}$ unit.

4. The area of the rectangle is $A = 2xy = 2x(12 - x^2)$, where $0 \leq x \leq \sqrt{12}$. Solving $A'(x) = 0 \Rightarrow 24 - 6x^2 = 0 \Rightarrow x = -2$ or 2 . Now -2 is not in the domain, and since $A(0) = 0$ and $A(\sqrt{12}) = 0$, we conclude that $A(2) = 32$ square units is the maximum area. The dimensions are 4 units by 8 units.

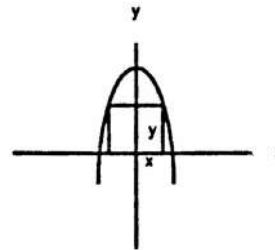

5. The volume of the box is $V(x) = x(15 - 2x)(8 - 2x) = 120x - 46x^2 + 4x^3$, where $0 \leq x \leq 4$. Solving $V'(x) = 0 \Rightarrow 120 - 92x + 12x^2 = 4(6 - x)(5 - 3x) = 0 \Rightarrow x = \frac{5}{3}$ or 6 , but 6 is not in the domain. Since $V(0) = V(4) = 0$, $V(\frac{5}{3}) = \frac{2450}{27} \approx 91$ in³ must be the maximum volume of the box with dimensions $\frac{14}{3} \times \frac{35}{3} \times \frac{5}{3}$ inches.

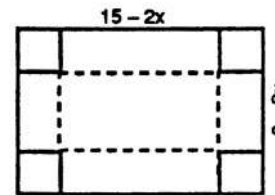

6. The area of the triangle is $A = \frac{1}{2}ba = \frac{b}{2}\sqrt{400 - b^2}$, where $0 \leq b \leq 20$. Then $\frac{dA}{db} = \frac{1}{2}\sqrt{400 - b^2} - \frac{b^2}{2\sqrt{400 - b^2}} = \frac{200 - b^2}{\sqrt{400 - b^2}} = 0 \Rightarrow$ the interior critical point is $b = 10\sqrt{2}$.
 When $b = 0$ or 20 , the area is zero $\Rightarrow A(10\sqrt{2})$ is the maximum area. When $a^2 + b^2 = 400$ and $b = 10\sqrt{2}$, the value of a is also $10\sqrt{2} \Rightarrow$ the maximum area occurs when $a = b$.

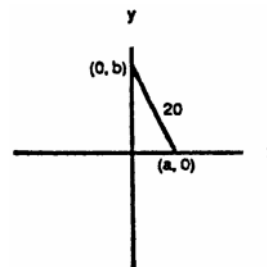

7. The area is $A(x) = x(800 - 2x)$, where $0 \leq x \leq 400$. Solving $A'(x) = 800 - 4x = 0 \Rightarrow x = 200$. With $A(0) = A(400) = 0$, the maximum area is $A(200) = 80,000$ m². The dimensions are 200 m by 400 m.

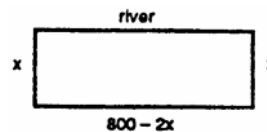

8. The area is $2xy = 216 \Rightarrow y = \frac{108}{x}$. The amount of fence needed is $P = 4x + 3y = 4x + 324x^{-1}$, where $0 < x$;
 $\frac{dP}{dx} = 4 - \frac{324}{x^2} = 0 \Rightarrow x^2 - 81 = 0 \Rightarrow$ the critical points are 0 and ± 9 , but 0 and -9 are not in the domain. Then $P''(9) > 0 \Rightarrow$ at $x = 9$ there is a minimum \Rightarrow the dimensions of the outer rectangle are 18 m by 12 m \Rightarrow 72 meters of fence will be needed.

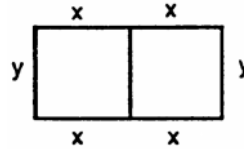

9. (a) We minimize the weight = tS where S is the surface area, and t is the thickness of the steel walls of the tank. The surface area is $S = x^2 + 4xy$ where x is the length of a side of the square base of the tank, and y is its depth. The volume of the tank must be $500\text{ft}^3 \Rightarrow y = \frac{500}{x^2}$. Therefore, the weight of the tank is $w(x) = t(x^2 + \frac{2000}{x})$. Treating the thickness as a constant gives $w'(x) = t(2x - \frac{2000}{x^2})$ for $x > 0$. The critical value is at $x = 10$. Since $w''(10) = t(2 + \frac{4000}{10^3}) > 0$, there is a minimum at $x = 10$. Therefore, the optimum dimensions of the tank are 10 ft on the base edges and 5 ft deep.

(b) Minimizing the surface area of the tank minimizes its weight for a given wall thickness. The thickness of the steel walls would likely be determined by other considerations such as structural requirements.

10. (a) The volume of the tank being 1125ft^3 , we have that $yx^2 = 1125 \Rightarrow y = \frac{1125}{x^2}$. The cost of building the tank is $c(x) = 5x^2 + 30x(\frac{1125}{x^2})$, where $0 < x$. Then $c'(x) = 10x - \frac{33750}{x^2} = 0 \Rightarrow$ the critical points are 0 and 15, but 0 is not in the domain. Thus, $c''(15) > 0 \Rightarrow$ at $x = 15$ we have a minimum. The values of $x = 15$ ft and $y = 5$ ft will minimize the cost.

(b) The cost function $c = 5(x^2 + 4xy) + 10xy$, can be separated into two items: (1) the cost of the materials and labor to fabricate the tank, and (2) the cost for the excavation. Since the area of the sides and bottom of the tanks is $(x^2 + 4xy)$, it can be deduced that the unit cost to fabricate the tanks is $\$5/\text{ft}^2$. Normally, excavation costs are per unit volume of excavated material. Consequently, the total excavation cost can be taken as $10xy = (\frac{10}{x})(x^2y)$. This suggests that the unit cost of excavation is $\frac{\$10/\text{ft}^2}{x}$ where x is the length of a side of the square base of the tank in feet. For the least expensive tank, the unit cost for the excavation is $\frac{\$10/\text{ft}^2}{15 \text{ft}} = \frac{\$0.67}{\text{ft}^3} = \frac{\$18}{\text{yd}^3}$. The total cost of the least expensive tank is $\$3375$, which is the sum of $\$2625$ for fabrication and $\$750$ for the excavation.

11. The area of the printing is $(y - 4)(x - 8) = 50$. Consequently, $y = (\frac{50}{x-8}) + 4$. The area of the paper is $A(x) = x(\frac{50}{x-8} + 4)$, where $8 < x$. Then

$$A'(x) = (\frac{50}{x-8} + 4) - x(\frac{50}{(x-8)^2}) = \frac{4(x-8)^2 - 400}{(x-8)^2} = 0$$

\Rightarrow the critical points are -2 and 18 , but -2 is not in the domain. Thus $A''(18) > 0 \Rightarrow$ at $x = 18$ we have a minimum. Therefore the dimensions 18 by 9 inches minimize the amount of paper.

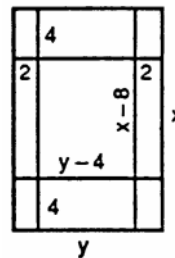

12. The volume of the cone is $V = \frac{1}{3} \pi r^2 h$, where $r = x = \sqrt{9 - y^2}$ and $h = y + 3$ (from the figure in the text). Thus, $V(y) = \frac{\pi}{3} (9 - y^2)(y + 3) = \frac{\pi}{3} (27 + 9y - 3y^2 - y^3) \Rightarrow V'(y) = \frac{\pi}{3} (9 - 6y - 3y^2) = \pi(1 - y)(3 + y)$. The critical points are -3 and 1 , but -3 is not in the domain. Thus $V''(1) = \frac{\pi}{3} (-6 - 6(1)) < 0 \Rightarrow$ at $y = 1$ we have a maximum volume of $V(1) = \frac{\pi}{3} (8)(4) = \frac{32\pi}{3}$ cubic units.

13. The area of the triangle is $A(\theta) = \frac{ab \sin \theta}{2}$, where $0 < \theta < \pi$.
 Solving $A'(\theta) = 0 \Rightarrow \frac{ab \cos \theta}{2} = 0 \Rightarrow \theta = \frac{\pi}{2}$. Since $A''(\theta) = -\frac{ab \sin \theta}{2} \Rightarrow A''\left(\frac{\pi}{2}\right) < 0$, there is a maximum at $\theta = \frac{\pi}{2}$.

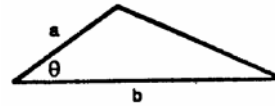

14. A volume $V = \pi r^2 h = 1000 \Rightarrow h = \frac{1000}{\pi r^2}$. The amount of material is the surface area given by the sides and bottom of the can $\Rightarrow S = 2\pi r h + \pi r^2 = \frac{2000}{r} + \pi r^2, 0 < r$. Then $\frac{dS}{dr} = -\frac{2000}{r^2} + 2\pi r = 0 \Rightarrow \frac{\pi r^3 - 1000}{r^2} = 0$. The critical points are 0 and $\frac{10}{\sqrt[3]{\pi}}$, but 0 is not in the domain. Since $\frac{d^2S}{dr^2} = \frac{4000}{r^3} + 2\pi > 0$, we have a minimum surface area when $r = \frac{10}{\sqrt[3]{\pi}}$ cm and $h = \frac{1000}{\pi r^2} = \frac{10}{\sqrt[3]{\pi}}$ cm. Comparing this result to the result found in Example 2, if we include both ends of the can, then we have a minimum surface area when the can is shorter-specifically, when the height of the can is the same as its diameter.

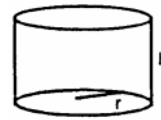

15. With a volume of 1000 cm and $V = \pi r^2 h$, then $h = \frac{1000}{\pi r^2}$. The amount of aluminum used per can is $A = 8r^2 + 2\pi r h = 8r^2 + \frac{2000}{r}$. Then $A'(r) = 16r - \frac{2000}{r^2} = 0 \Rightarrow \frac{8r^3 - 1000}{r^2} = 0 \Rightarrow$ the critical points are 0 and 5, but $r = 0$ results in no can. Since $A''(r) = 16 + \frac{4000}{r^3} > 0$ we have a minimum at $r = 5 \Rightarrow h = \frac{40}{\pi}$ and $h:r = 8:\pi$.

16. (a) The base measures $10 - 2x$ in. by $\frac{15-2x}{2}$ in., so the volume formula is $V(x) = \frac{x(10-2x)(15-2x)}{2} = 2x^3 - 25x^2 + 75x$.
 (b) We require $x > 0, 2x < 10$, and $2x < 15$. Combining these requirements, the domain is the interval $(0, 5)$.

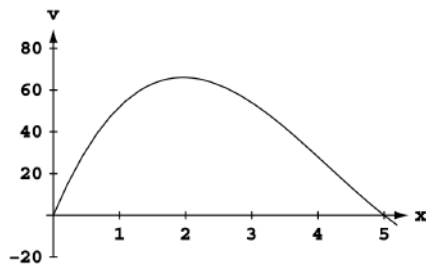

- (c) The maximum volume is approximately 66.02 in.³ when $x \approx 1.96$ in.

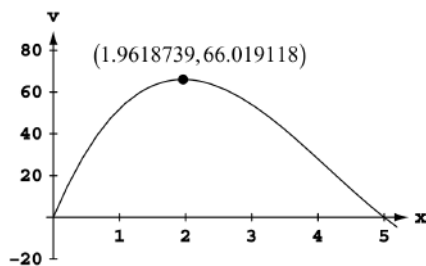

- (d) $V'(x) = 6x^2 - 50x + 75$. The critical point occurs when $V'(x) = 0$, at $x = \frac{50 \pm \sqrt{(-50)^2 - 4(6)(75)}}{2(6)} = \frac{50 \pm \sqrt{700}}{12} = \frac{25 \pm 5\sqrt{7}}{6}$, that is, $x \approx 1.96$ or $x \approx 6.37$. We discard the larger value because it is not in the domain. Since $V''(x) = 12x - 50$, which is negative when $x \approx 1.96$, the critical point corresponds to the maximum volume. The maximum volume occurs when $x = \frac{25 - 5\sqrt{7}}{6} \approx 1.96$, which confirms the result in (c).

17. (a) The "sides" of the suitcase will measure $24 - 2x$ in. by $18 - 2x$ in. and will be $2x$ in. apart, so the volume formula is $V(x) = 2x(24 - 2x)(18 - 2x) = 8x^3 - 168x^2 + 862x$.

(b) We require $x > 0$, $2x < 18$, and $2x < 24$. Combining these requirements, the domain is the interval $(0, 9)$.

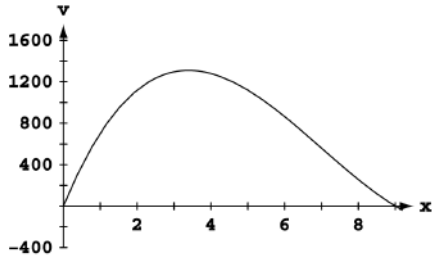

(c) The maximum volume is approximately 1309.95 in.^3 when $x \approx 3.39 \text{ in.}$

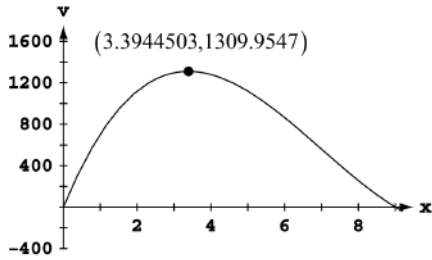

- (d) $V'(x) = 24x^2 - 336x + 864 = 24(x^2 - 14x + 36)$. The critical point is at $x = \frac{14 \pm \sqrt{(-14)^2 - 4(1)(36)}}{2(1)} = \frac{14 \pm \sqrt{52}}{2} = 7 \pm \sqrt{13}$, that is, $x \approx 3.39$ or $x \approx 10.61$. We discard the larger value because it is not in the domain. Since $V''(x) = 24(2x - 14)$ which is negative when $x \approx 3.39$, the critical point corresponds to the maximum volume. The maximum value occurs at $x = 7 - \sqrt{13} \approx 3.39$, which confirms the results in (c).
- (e) $8x^3 - 168x^2 + 862x = 1120 \Rightarrow 8(x^3 - 21x^2 + 108x - 140) = 0 \Rightarrow 8(x - 2)(x - 5)(x - 14) = 0$. Since 14 is not in the domain, the possible values of x are $x = 2 \text{ in.}$ or $x = 5 \text{ in.}$
- (f) The dimensions of the resulting box are $2x \text{ in.}$, $(24 - 2x) \text{ in.}$, and $(18 - 2x)$. Each of these measurements must be positive, so that gives the domain of $(0, 9)$.

18. If the upper right vertex of the rectangle is located at $(x, 4 \cos 0.5x)$ for $0 < x < \pi$, then the rectangle has width $2x$ and height $4 \cos 0.5x$, so the area is $A(x) = 8x \cos 0.5x$. Solving $A'(x) = 0$ graphically for $0 < x < \pi$, we find that $x \approx 2.214$. Evaluating $2x$ and $4 \cos 0.5x$ for $x \approx 2.214$, the dimensions of the rectangle are approximately 4.43 (width) by 1.79 (height), and the maximum area is approximately 7.923.

19. Let the radius of the cylinder be $r \text{ cm}$, $0 < r < 10$. Then the height is $2\sqrt{100 - r^2}$ and the volume is $V(r) = 2\pi r^2 \sqrt{100 - r^2} \text{ cm}^3$. Then, $V'(r) = 2\pi r^2 \left(\frac{1}{\sqrt{100 - r^2}} \right) (-2r) + \left(2\pi \sqrt{100 - r^2} \right) (2r) = \frac{-2\pi r^3 + 4\pi r(100 - r^2)}{\sqrt{100 - r^2}} = \frac{2\pi r(200 - 3r^2)}{\sqrt{100 - r^2}}$. The critical point for $0 < r < 10$ occurs at $r = \sqrt{\frac{200}{3}} = 10\sqrt{\frac{2}{3}}$. Since $V'(r) > 0$ for $0 < r < 10\sqrt{\frac{2}{3}}$ and $V'(r) < 0$ for $10\sqrt{\frac{2}{3}} < r < 10$, the critical point corresponds to the maximum volume. The dimensions are $r = 10\sqrt{\frac{2}{3}} \approx 8.16 \text{ cm}$ and $h = \frac{20}{\sqrt{3}} \approx 11.55 \text{ cm}$, and the volume is $\frac{4000\pi}{3\sqrt{3}} \approx 2418.40 \text{ cm}^3$.

20. (a) From the diagram we have $4x + \ell = 108$ and $V = x^2\ell$. The volume of the box is $V(x) = x^2(108 - 4x)$, where $0 \leq x < 27$. Then $V'(x) = 216x - 12x^2 = 12x(18 - x) = 0 \Rightarrow$ the critical points are 0 and 18, but $x = 0$ results in no box. Since $V''(x) = 216 - 24x < 0$ at $x = 18$ we have a maximum. The dimensions of the box are $18 \times 18 \times 36 \text{ in.}$

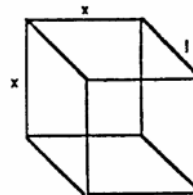

- (b) In terms of length, $V(\ell) = x^2\ell = \left(\frac{108-\ell}{4}\right)^2 \ell$. The graph indicates that the maximum volume occurs near $\ell = 36$, which is consistent with the result of part (a).

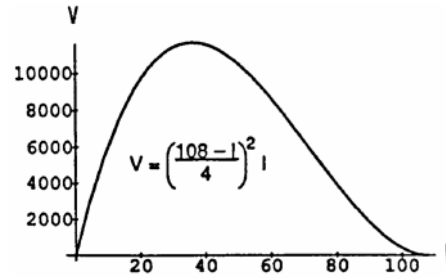

21. (a) From the diagram we have $3h + 2w = 108$ and $V = h^2w \Rightarrow V(h) = h^2(54 - \frac{3}{2}h) = 54h^2 - \frac{3}{2}h^3$. Then $V'(h) = 108h - \frac{9}{2}h^2 = \frac{9}{2}h(24 - h) = 0 \Rightarrow h = 0$ or $h = 24$, but $h = 0$ results in no box. Since $V''(h) = 108 - 9h < 0$ at $h = 24$, we have a maximum volume at $h = 24$ and $w = 54 - \frac{3}{2}h = 18$.

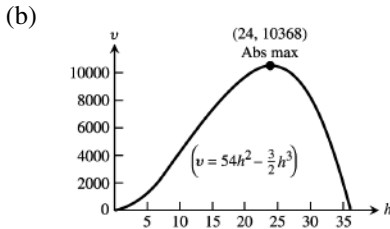
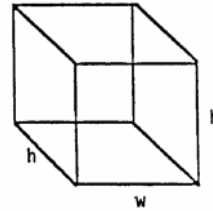

22. From the diagram the perimeter is $P = 2r + 2h + \pi r$, where r is the radius of the semicircle and h is the height of the rectangle. The amount of light transmitted proportional to

$$A = 2rh + \frac{1}{4}\pi r^2 = r(P - 2r - \pi r) + \frac{1}{4}\pi r^2$$

$$= rP - 2r^2 - \frac{3}{4}\pi r^2. \text{ Then } \frac{dA}{dr} = P - 4r - \frac{3}{2}\pi r = 0$$

$$\Rightarrow r = \frac{2P}{8+3\pi} \Rightarrow 2h = P - \frac{4P}{8+3\pi} - \frac{2\pi P}{8+3\pi} = \frac{(4+\pi)P}{8+3\pi}.$$

Therefore, $\frac{2r}{h} = \frac{8}{4+\pi}$ gives the proportions that admit the most light since $\frac{d^2A}{dr^2} = -4 - \frac{3}{2}\pi < 0$.

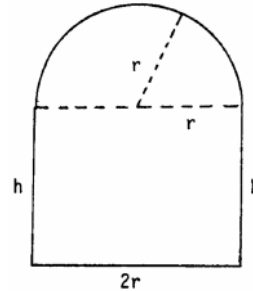

23. The fixed volume is $V = \pi r^2 h + \frac{2}{3}\pi r^3 \Rightarrow h = \frac{V}{\pi r^2} - \frac{2r}{3}$, where h is the height of the cylinder and r is the radius of the hemisphere. To minimize the cost we must minimize surface area of the cylinder added to twice the surface area of the hemisphere. Thus, we minimize $C = 2\pi r h + 4\pi r^2 = 2\pi r \left(\frac{V}{\pi r^2} - \frac{2r}{3}\right) + 4\pi r^2 = \frac{2V}{r} + \frac{8}{3}\pi r^2$. Then $\frac{dC}{dr} = -\frac{2V}{r^2} + \frac{16}{3}\pi r = 0 \Rightarrow V = \frac{8}{3}\pi r^3 \Rightarrow r = \left(\frac{3V}{8\pi}\right)^{1/3}$. From the volume equation, $h = \frac{V}{\pi r^2} - \frac{2r}{3} = \frac{4V^{1/3}}{\pi^{1/3} \cdot 3^{2/3}} - \frac{2 \cdot 3^{1/3} \cdot V^{1/3}}{3 \cdot 2 \cdot \pi^{1/3}} = \frac{3^{1/3} \cdot 2 \cdot 4 \cdot V^{1/3} - 2 \cdot 3^{1/3} \cdot V^{1/3}}{3 \cdot 2 \cdot \pi^{1/3}} = \left(\frac{3V}{\pi}\right)^{1/3}$. Since $\frac{d^2C}{dr^2} = \frac{4V}{r^3} + \frac{16}{3}\pi > 0$, these dimensions do minimize the cost.

24. The volume of the trough is maximized when the area of the cross section is maximized. From the diagram the area of the cross section is $A(\theta) = \cos \theta + \sin \theta \cos \theta, 0 < \theta < \frac{\pi}{2}$. Then $A'(\theta) = -\sin \theta + \cos^2 \theta - \sin^2 \theta = -(2 \sin^2 \theta + \sin \theta - 1) = -(2 \sin \theta - 1)(\sin \theta + 1)$ so $A'(\theta) = 0 \Rightarrow \sin \theta = \frac{1}{2}$ or $\sin \theta = -1 \Rightarrow \theta = \frac{\pi}{6}$ because $\sin \theta \neq -1$ when $0 < \theta < \frac{\pi}{2}$. Also, $A'(\theta) > 0$ for $0 < \theta < \frac{\pi}{6}$ and $A'(\theta) < 0$ for $\frac{\pi}{6} < \theta < \frac{\pi}{2}$. Therefore, at $\theta = \frac{\pi}{6}$ there is a maximum.

25. (a) From the diagram we have: $\overline{AP} = x$, $\overline{RA} = \sqrt{L^2 - x^2}$,
 $\overline{PB} = 8.5 - x$, $\overline{CH} = \overline{DR} = 11 - \overline{RA} = 11 - \sqrt{L^2 - x^2}$,
 $\overline{QB} = \sqrt{x^2 - (8.5 - x)^2}$, $\overline{HQ} = 11 - \overline{CH} - \overline{QB}$
 $= 11 - [11 - \sqrt{L^2 - x^2} + \sqrt{x^2 - (8.5 - x)^2}]$
 $= \sqrt{L^2 - x^2} - \sqrt{x^2 - (8.5 - x)^2}$, $\overline{RQ}^2 = \overline{RH}^2 + \overline{HQ}^2$
 $= (8.5)^2 + (\sqrt{L^2 - x^2} - \sqrt{x^2 - (8.5 - x)^2})^2$. It

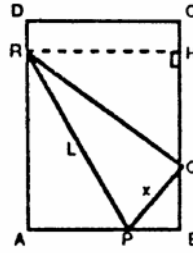

follows that $\overline{RP}^2 = \overline{PQ}^2 + \overline{RQ}^2 \Rightarrow L^2 = x^2 + (\sqrt{L^2 - x^2} - \sqrt{x^2 - (x - 8.5)^2})^2 + (8.5)^2$
 $\Rightarrow L^2 = x^2 + L^2 - x^2 - 2\sqrt{L^2 - x^2} \sqrt{17x - (8.5)^2} + 17x - (8.5)^2 + (8.5)^2$
 $\Rightarrow 17^2 x^2 = 4(L^2 - x^2)(17x - (8.5)^2) \Rightarrow L^2 = x^2 + \frac{17^2 x^2}{4[17x - (8.5)^2]} = \frac{17x^3}{17x - (8.5)^2}$
 $= \frac{17x^3}{17x - (\frac{17}{2})^2} = \frac{4x^3}{4x - 17} = \frac{2x^3}{2x - 8.5}$.

- (b) If $f(x) = \frac{4x^3}{4x-17}$ is minimized, then L^2 is minimized. Now $f'(x) = \frac{4x^2(8x-51)}{(4x-17)^2} \Rightarrow f'(x) < 0$ when $x < \frac{51}{8}$
 and $f'(x) > 0$ when $x > \frac{51}{8}$. Thus L^2 is minimized when $x = \frac{51}{8}$.
 (c) When $x = \frac{51}{8}$, then $L \approx 11.0$ in.

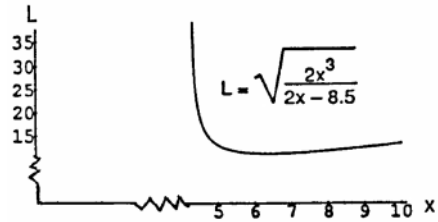

26. (a) From the figure in the text we have $P = 2x + 2y \Rightarrow y = \frac{P}{2} - x$. If $P = 36$, then $y = 18 - x$. When the cylinder is formed, $x = 2\pi r \Rightarrow r = \frac{x}{2\pi}$ and $h = y \Rightarrow h = 18 - x$. The volume of the cylinder is $V = \pi r^2 h$
 $\Rightarrow V(x) = \frac{18x^2 - x^3}{4\pi}$. Solving $V'(x) = \frac{3x(12-x)}{4\pi} = 0 \Rightarrow x = 0$ or 12 ; but when $x = 0$, there is no cylinder. Then $V''(x) = \frac{3}{\pi}(3 - \frac{x}{2}) \Rightarrow V''(12) < 0 \Rightarrow$ there is a maximum at $x = 12$. The values of $x = 12$ cm and $y = 6$ cm give the largest volume.
 (b) In this case $V(x) = \pi x^2(18 - x)$. Solving $V'(x) = 3\pi x(12 - x) = 0 \Rightarrow x = 0$ or 12 ; but $x = 0$ would result in no cylinder. Then $V''(x) = 6\pi(6 - x) \Rightarrow V''(12) < 0 \Rightarrow$ there is a maximum at $x = 12$. The values of $x = 12$ cm and $y = 6$ cm give the largest volume.
27. Note that $h^2 + r^2 = 3$ and so $r = \sqrt{3 - h^2}$. Then the volume is given by $V = \frac{\pi}{3} r^2 h = \frac{\pi}{3} (3 - h^2) h = \pi h - \frac{\pi}{3} h^3$ for $0 < h < \sqrt{3}$, and so $\frac{dV}{dh} = \pi - \pi r^2 = \pi(1 - r^2)$. The critical point (for $h > 0$) occurs at $h = 1$. Since $\frac{dV}{dh} > 0$ for $0 < h < 1$, and $\frac{dV}{dh} < 0$ for $1 < h < \sqrt{3}$, the critical point corresponds to the maximum volume. The cone of greatest volume has radius $\sqrt{2}$ m, height 1m, and volume $\frac{2\pi}{3}$ m³.
28. (a) $f(x) = x^2 + \frac{a}{x} \Rightarrow f'(x) = x^{-2}(2x^3 - a)$, so that $f'(x) = 0$ when $x = 2$ implies $a = 16$
 (b) $f(x) = x^2 + \frac{a}{x} \Rightarrow f''(x) = 2x^{-3}(x^3 + a)$, so that $f''(x) = 0$ when $x = 1$ implies $a = -1$
29. If $f(x) = x^2 + \frac{a}{x}$, then $f'(x) = 2x - ax^{-2}$ and $f''(x) = 2 + 2ax^{-3}$. The critical points are 0 and $\sqrt[3]{\frac{a}{2}}$, but $x \neq 0$. Now $f''(\sqrt[3]{\frac{a}{2}}) = 6 > 0 \Rightarrow$ at $x = \sqrt[3]{\frac{a}{2}}$ there is a local minimum. However, no local maximum exists for any a .
30. If $f(x) = x^3 + ax^2 + bx$, then $f'(x) = 3x^2 + 2ax + b$ and $f''(x) = 6x + 2a$.
 (a) A local maximum at $x = -1$ and local minimum at $x = 3 \Rightarrow f'(-1) = 0$ and $f'(3) = 0 \Rightarrow 3 - 2a + b = 0$ and $27 + 6a + b = 0 \Rightarrow a = -3$ and $b = -9$.
 (b) A local minimum at $x = 4$ and a point of inflection at $x = 1 \Rightarrow f'(4) = 0$ and $f''(1) = 0 \Rightarrow 48 + 8a + b = 0$

and $6 + 2a = 0 \Rightarrow a = -3$ and $b = -24$.

31. (a) $s(t) = -16t^2 + 96t + 112 \Rightarrow v(t) = s'(t) = -32t + 96$. At $t = 0$, the velocity is $v(0) = 96$ ft/sec.
 (b) The maximum height occurs when $v(t) = 0$, when $t = 3$. The maximum height is $s(3) = 256$ ft and it occurs at $t = 3$ sec.
 (c) Note that $s(t) = -16t^2 + 96t + 112 = -16(t + 1)(t - 7)$, so $s = 0$ at $t = -1$ or $t = 7$. Choosing the positive value of t , the velocity when $s = 0$ is $v(7) = -128$ ft/sec.

32.

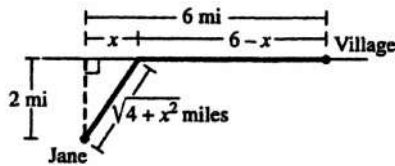

Let x be the distance from the point on the shoreline nearest Jane's boat to the point where she lands her boat. Then she needs to row $\sqrt{4 + x^2}$ mi at 2 mph and walk $6 - x$ mi at 5 mph. The total amount of time to reach the village is $f(x) = \frac{\sqrt{4+x^2}}{2} + \frac{6-x}{5}$ hours ($0 \leq x \leq 6$). Then $f'(x) = \frac{1}{2} \frac{1}{\sqrt{4+x^2}}(2x) - \frac{1}{5} = \frac{x}{\sqrt{4+x^2}} - \frac{1}{5}$. Solving $f'(x) = 0$, we have: $\frac{x}{\sqrt{4+x^2}} = \frac{1}{5} \Rightarrow 5x = \sqrt{4+x^2} \Rightarrow 25x^2 = 4(4+x^2) \Rightarrow 21x^2 = 16 \Rightarrow x = \pm \frac{4}{\sqrt{21}}$. We discard the negative value of x because it is not in the domain. Checking the endpoints and critical point, we have $f(0) = 2.2$, $f\left(\frac{4}{\sqrt{21}}\right) \approx 2.12$, and $f(6) \approx 3.16$. Jane should land her boat $\frac{4}{\sqrt{21}} \approx 0.87$ miles down the shoreline from the point nearest her boat.

33. $\frac{s}{x} = \frac{h}{x+27} \Rightarrow h = 8 + \frac{216}{x}$ and $L(x) = \sqrt{h^2 + (x+27)^2}$
 $= \sqrt{\left(8 + \frac{216}{x}\right)^2 + (x+27)^2}$ when $x \geq 0$. Note that $L(x)$ is minimized when $f(x) = \left(8 + \frac{216}{x}\right)^2 + (x+27)^2$ is minimized. If $f'(x) = 0$, then
 $2\left(8 + \frac{216}{x}\right)\left(-\frac{216}{x^2}\right) + 2(x+27) = 0$
 $\Rightarrow (x+27)\left(1 - \frac{1728}{x^3}\right) = 0 \Rightarrow x = -27$ (not acceptable)
 since distance is never negative or $x = 12$. Then $L(12) = \sqrt{2197} \approx 46.87$ ft.

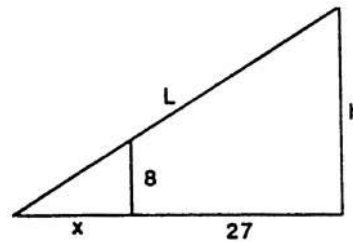

34. (a) From the diagram we have $d^2 = 4r^2 - w^2$. The strength of the beam is $S = kwd^2 = kw(4r^2 - w^2)$. When $r = 6$, then $S = 144kw - kw^3$. Also, $S'(w) = 144k - 3kw^2 = 3k(48 - w^2)$ so $S'(w) = 0 \Rightarrow w = \pm 4\sqrt{3}$; $S''(4\sqrt{3}) < 0$ and $-4\sqrt{3}$ is not acceptable. Therefore $S(4\sqrt{3})$ is the maximum strength. The dimensions of the strongest beam are $4\sqrt{3}$ by $4\sqrt{6}$ inches.

(b)

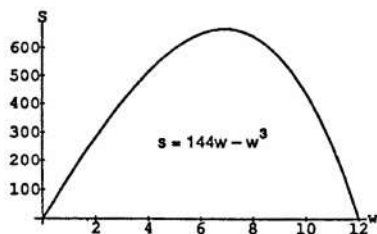

(c)

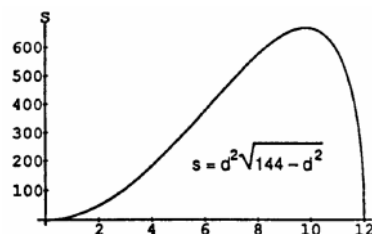

Both graphs indicate the same maximum value and are consistent with each other. Changing k does not change the dimensions that give the strongest beam (i.e., do not change the values of w and d that produce the strongest beam).

35. (a) From the situation we have $w^2 = 144 - d^2$. The stiffness of the beam is $S = kwd^3 = kd^3(144 - d^2)^{1/2}$, where $0 \leq d \leq 12$. Also, $S'(d) = \frac{4kd^2(108 - d^2)}{\sqrt{144 - d^2}} \Rightarrow$ critical points at 0, 12, and $6\sqrt{3}$. Both $d = 0$ and $d = 12$ cause $S = 0$. The maximum occurs at $d = 6\sqrt{3}$. The dimensions are 6 by $6\sqrt{3}$ inches.

(b)

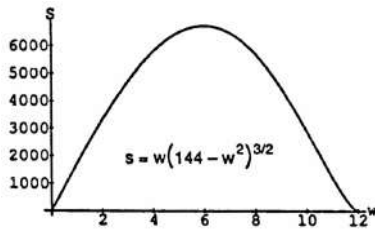

(c)

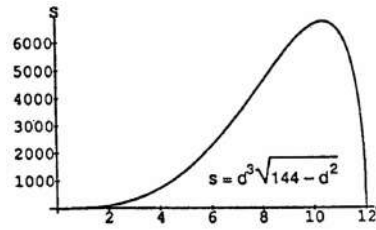

Both graphs indicate the same maximum value and are consistent with each other. The changing of k has no effect.

36. (a) $s_1 = s_2 \Rightarrow \sin t = \sin(t + \frac{\pi}{3}) \Rightarrow \sin t = \sin t \cos \frac{\pi}{3} + \sin \frac{\pi}{3} \cos t \Rightarrow \sin t = \frac{1}{2} \sin t + \frac{\sqrt{3}}{2} \cos t \Rightarrow \tan t = \sqrt{3} \Rightarrow t = \frac{\pi}{3}$ or $\frac{4\pi}{3}$

- (b) The distance between the particles is $s(t) = |s_1 - s_2| = |\sin t - \sin(t + \frac{\pi}{3})| = \frac{1}{2} |\sin t - \sqrt{3} \cos t|$
 $\Rightarrow s'(t) = \frac{(\sin t - \sqrt{3} \cos t)(\cos t + \sqrt{3} \sin t)}{2|\sin t - \sqrt{3} \cos t|}$ since $\frac{d}{dx} |x| = \frac{x}{|x|} \Rightarrow$ critical times and endpoints

are $0, \frac{\pi}{3}, \frac{5\pi}{6}, \frac{4\pi}{3}, \frac{11\pi}{6}, 2\pi$; then $s(0) = \frac{\sqrt{3}}{2}$, $s(\frac{\pi}{3}) = 0$, $s(\frac{5\pi}{6}) = 1$, $s(\frac{4\pi}{3}) = 0$, $s(\frac{11\pi}{6}) = 1$, $s(2\pi) = \frac{\sqrt{3}}{2} \Rightarrow$ the greatest distance between the particles is 1.

- (c) Since $s'(t) = \frac{(\sin t - \sqrt{3} \cos t)(\cos t + \sqrt{3} \sin t)}{2|\sin t - \sqrt{3} \cos t|}$ we can conclude that at $t = \frac{\pi}{3}$ and $\frac{4\pi}{3}$, $s'(t)$ has cusps and the distance between the particles is changing the fastest near these points.

37. (a) $s = 10 \cos(\pi t) \Rightarrow v = -10\pi \sin(\pi t) \Rightarrow \text{speed} = |10\pi \sin(\pi t)| = 10\pi |\sin(\pi t)| \Rightarrow$ the maximum speed is $10\pi \approx 31.42$ cm/sec since the maximum value of $|\sin(\pi t)|$ is 1; the cart is moving the fastest at $t = 0.5$ sec, 1.5 sec, 2.5 sec and 3.5 sec when $|\sin(\pi t)|$ is 1. At these times the distance is $s = 10 \cos(\frac{\pi}{2}) = 0$ cm and $a = -10\pi^2 \cos(\pi t) \Rightarrow |a| = 10\pi^2 |\cos(\pi t)| \Rightarrow |a| = 0$ cm/sec²

- (b) $|a| = 10\pi^2 |\cos(\pi t)|$ is greatest at $t = 0.0$ sec, 1.0 sec, 2.0 sec, 3.0 sec and 4.0 sec, and at these times the magnitude of the cart's position is $|s| = 10$ cm from the rest position and the speed is 0 cm/sec.

38. (a) $2 \sin t = \sin 2t \Rightarrow 2 \sin t - 2 \sin t \cos t = 0 \Rightarrow (2 \sin t)(1 - \cos t) = 0 \Rightarrow t = k\pi$ where k is a positive integer

- (b) The vertical distance between the masses is $s(t) = |s_1 - s_2| = ((s_1 - s_2)^2)^{1/2} = ((\sin 2t - 2 \sin t)^2)^{1/2}$
 $\Rightarrow s'(t) = (\frac{1}{2}) ((\sin 2t - 2 \sin t)^2)^{-1/2} (2)(\sin 2t - 2 \sin t)(2 \cos 2t - 2 \cos t)$

$$= \frac{2(\cos 2t - \cos t)(\sin 2t - 2 \sin t)}{|\sin 2t - 2 \sin t|} = \frac{4(2 \cos t + 1)(\cos t - 1)(\sin t)(\cos t - 1)}{|\sin 2t - 2 \sin t|} \Rightarrow \text{critical times at}$$

$$0, \frac{2\pi}{3}, \pi, \frac{4\pi}{3}, 2\pi; \text{ then } s(0) = 0, s(\frac{2\pi}{3}) = |\sin(\frac{4\pi}{3}) - 2 \sin(\frac{2\pi}{3})| = \frac{3\sqrt{3}}{2}, s(\pi) = 0, s(\frac{4\pi}{3})$$

$$= |\sin(\frac{8\pi}{3}) - 2 \sin(\frac{4\pi}{3})| = \frac{3\sqrt{3}}{2}, s(2\pi) = 0 \Rightarrow \text{the greatest distance is } \frac{3\sqrt{3}}{2} \text{ at } t = \frac{2\pi}{3} \text{ and } \frac{4\pi}{3}$$

39. (a) $s = \sqrt{(12 - 12t)^2 + (8t)^2} = ((12 - 12t)^2 + 64t^2)^{1/2}$

$$(b) \frac{ds}{dt} = \frac{1}{2} ((12 - 12t)^2 + 64t^2)^{-1/2} [2(12 - 12t)(-12) + 128t] = \frac{208t - 144}{\sqrt{(12 - 12t)^2 + 64t^2}}$$

$$\Rightarrow \left. \frac{ds}{dt} \right|_{t=0} = -12 \text{ knots and } \left. \frac{ds}{dt} \right|_{t=1} = 8 \text{ knots}$$

- (c) The graph indicates that the ships did not see each other because $s(t) > 5$ for all values of t .

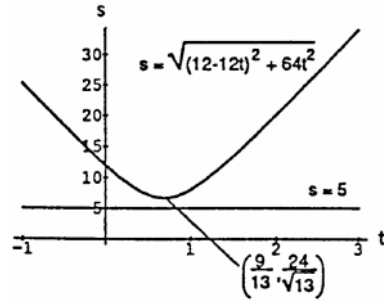

- (d) The graph supports the conclusions in parts (b) and (c).

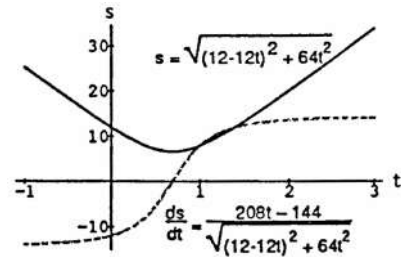

$$(e) \lim_{t \rightarrow \infty} \frac{ds}{dt} = \sqrt{\lim_{t \rightarrow \infty} \frac{(208t - 144)^2}{144(1-t)^2 + 64t^2}} = \sqrt{\lim_{t \rightarrow \infty} \frac{(208 - \frac{144}{t})^2}{144(\frac{1}{t} - 1)^2 + 64}} = \sqrt{\frac{208^2}{144 + 64}} = \sqrt{208} = 4\sqrt{13}$$

which equals the square root of the sums of the squares of the individual speeds.

40. The distance $\overline{OT} + \overline{TB}$ is minimized when \overline{OB} is a straight line. Hence $\angle\alpha = \angle\beta \Rightarrow \theta_1 = \theta_2$.

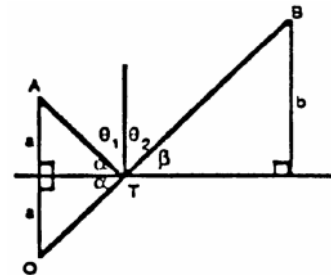

41. If $v = kax - kx^2$, then $v' = ka - 2kx$ and $v'' = -2k$, so $v' = 0 \Rightarrow x = \frac{a}{2}$. At $x = \frac{a}{2}$ there is a maximum since $v''(\frac{a}{2}) = -2k < 0$. The maximum value of v is $\frac{ka^2}{4}$.

42. (a) According to the graph, $y'(0) = 0$.
 (b) According to the graph, $y'(-L) = 0$.
 (c) $y(0) = 0$, so $d = 0$. Now $y'(x) = 3ax^2 + 2bx + c$, so $y'(0) = 0$ implies that $c = 0$. Therefore, $y(x) = ax^3 + bx^2$ and $y'(x) = 3ax^2 + 2bx$. Then $y(-L) = -aL^3 + bL^2 = H$ and $y'(-L) = 3aL^2 - 2bL = 0$, so we have two linear equations in two unknowns a and b . The second equation gives $b = \frac{3aL}{2}$. Substituting into the first equation, we have $-aL^3 + \frac{3aL^3}{2} = H$, or $\frac{aL^3}{2} = H$, so $a = \frac{2H}{L^3}$. Therefore, $b = \frac{3H}{L^2}$ and the equation for y is $y(x) = \frac{2H}{L^3}x^3 + \frac{3H}{L^2}x^2$, or $y(x) = H\left[2\left(\frac{x}{L}\right)^3 + 3\left(\frac{x}{L}\right)^2\right]$.

43. The profit is $p = nx - nc = n(x - c) = [a(x - c)^{-1} + b(100 - x)](x - c) = a + b(100 - x)(x - c)$
 $= a + (bc + 100b)x - 100bc - bx^2$. Then $p'(x) = bc + 100b - 2bx$ and $p''(x) = -2b$. Solving $p'(x) = 0 \Rightarrow x = \frac{c}{2} + 50$. At $x = \frac{c}{2} + 50$ there is a maximum profit since $p''(x) = -2b < 0$ for all x .

44. Let x represent the number of people over 50. The profit is $p(x) = (50 + x)(200 - 2x) - 32(50 + x) - 6000$
 $= -2x^2 + 68x + 2400$. Then $p'(x) = -4x + 68$ and $p'' = -4$. Solving $p'(x) = 0 \Rightarrow x = 17$. At $x = 17$ there is a maximum since $p''(17) < 0$. It would take 67 people to maximize the profit.

45. (a) $A(q) = kmq^{-1} + cm + \frac{h}{2}q$, where $q > 0 \Rightarrow A'(q) = -kmq^{-2} + \frac{h}{2} = \frac{hq^2 - 2km}{2q^2}$ and $A''(q) = 2kmq^{-3}$. The critical points are $-\sqrt{\frac{2km}{h}}$, 0, and $\sqrt{\frac{2km}{h}}$, but only $\sqrt{\frac{2km}{h}}$ is in the domain. Then $A''\left(\sqrt{\frac{2km}{h}}\right) > 0 \Rightarrow$ at $q = \sqrt{\frac{2km}{h}}$ there is a minimum average weekly cost.
- (b) $A(q) = \frac{(k+bq)m}{q} + cm + \frac{h}{2}q = kmq^{-1} + bm + cm + \frac{h}{2}q$, where $q > 0 \Rightarrow A'(q) = 0$ at $q = \sqrt{\frac{2km}{h}}$ as in (a). Also $A''(q) = 2kmq^{-3} > 0$ so the most economical quantity to order is still $q = \sqrt{\frac{2km}{h}}$ which minimizes the average weekly cost.
46. We start with $c(x) =$ the cost of producing x items, $x > 0$, and $\frac{c(x)}{x} =$ the average cost of producing x items, assumed to be differentiable. If the average cost can be minimized, it will be at a production level at which $\frac{d}{dx}\left(\frac{c(x)}{x}\right) = 0 \Rightarrow \frac{x c'(x) - c(x)}{x^2} = 0$ (by the quotient rule) $\Rightarrow x c'(x) - c(x) = 0$ (multiply both sides by x^2) $\Rightarrow c'(x) = \frac{c(x)}{x}$ where $c'(x)$ is the marginal cost. This concludes the proof. (Note: The theorem does not assure a production level that will give a minimum cost, but rather, it indicates where to look to see if there is one. Find the production levels where the average cost equals the marginal cost, then check to see if any of them give a minimum.)
47. The profit $p(x) = r(x) - c(x) = 6x - (x^3 - 6x^2 + 15x) = -x^3 + 6x^2 - 9x$, where $x \geq 0$. Then $p'(x) = -3x^2 + 12x - 9 = -3(x-3)(x-1)$ and $p''(x) = -6x + 12$. The critical points are 1 and 3. Thus $p''(1) = 6 > 0 \Rightarrow$ at $x = 1$ there is a local minimum, and $p''(3) = -6 < 0 \Rightarrow$ at $x = 3$ there is a local maximum. But $p(3) = 0 \Rightarrow$ the best you can do is break even.
48. The average cost of producing x items is $\bar{c}(x) = \frac{c(x)}{x} = x^2 - 20x + 20,000 \Rightarrow \bar{c}'(x) = 2x - 20 = 0 \Rightarrow x = 10$, the only critical value. The average cost is $\bar{c}(10) = \$19,900$ per item is a minimum cost because $\bar{c}''(10) = 2 > 0$.
49. (a) The artisan should order px units of material in order to have enough until the next delivery.
- (b) The average number of units in storage until the next delivery is $\frac{px}{2}$ and so the cost of storing then is $s\left(\frac{px}{2}\right)$ per day, and the total cost for x days is $\left(\frac{px}{2}\right)sx$. When added to the delivery cost, the total cost for delivery and storage for each cycle is: cost per cycle $= d + \frac{ps}{2}sx$.
- (c) The average cost per day for storage and delivery of materials is: average cost per day $= \frac{(d + \frac{ps}{2}x^2)}{x} + \frac{d}{x} + \frac{ps}{2}x$. To minimize the average cost per day, set the derivative equal to zero. $\frac{d}{dx}\left(d(x)^{-1} + \frac{ps}{2}x\right) = -d(x)^{-2} + \frac{ps}{2} = 0 \Rightarrow x = \pm \sqrt{\frac{2d}{ps}}$. Only the positive root makes sense in this context so that $x^* = \sqrt{\frac{2d}{ps}}$. To verify that x^* gives a minimum, check the second derivative $\left[\frac{d}{dx}\left(-d(x)^{-2} + \frac{ps}{2}\right)\right] \Big|_{\sqrt{\frac{2d}{ps}}} = \frac{2d}{x^3} \Big|_{\sqrt{\frac{2d}{ps}}} = \frac{2d}{\left(\sqrt{\frac{2d}{ps}}\right)^3} > 0 \Rightarrow$ a minimum.
- The amount to deliver is $px^* = \sqrt{\frac{2pd}{s}}$.
- (d) The line and the hyperbola intersect when $\frac{d}{x} = \frac{ps}{2}x$. Solving for x gives $x_{\text{intersection}} = \pm \sqrt{\frac{2d}{ps}}$. For $x > 0$, $x_{\text{intersection}} = \sqrt{\frac{2d}{ps}} = x^*$. From this result, the average cost per day is minimized when the average daily cost of delivery is equal to the average daily cost of storage.
50. Average Cost: $\frac{c(x)}{x} = \frac{2000}{x} + 96 + 4x^{1/2} \Rightarrow \frac{d}{dx}\left(\frac{c(x)}{x}\right) = -\frac{2000}{x^2} + 2x^{-1/2} = 0 \Rightarrow x = 100$. Check for a minimum:
- $\frac{d^2}{dx^2}\left(\frac{c(x)}{x}\right) \Big|_{x=100} = \frac{4000}{100^3} - 100^{-3/2} = 0.003 > 0 \Rightarrow$ a minimum at $x = 100$. At a production level of 100,000 units, the average cost will be minimized at \$156 per unit.

51. We have $\frac{dR}{dM} = CM - M^2$. Solving $\frac{d^2R}{dM^2} = C - 2M = 0 \Rightarrow M = \frac{C}{2}$. Also, $\frac{d^3R}{dM^3} = -2 < 0 \Rightarrow$ at $M = \frac{C}{2}$ there is a maximum.
52. (a) If $v = cr_0r^2 - cr^3$, then $v' = 2cr_0r - 3cr^2 = cr(2r_0 - 3r)$ and $v'' = 2cr_0 - 6cr = 2c(r_0 - 3r)$. The solution of $v' = 0$ is $r = 0$ or $\frac{2r_0}{3}$, but 0 is not in the domain. Also, $v' > 0$ for $r < \frac{2r_0}{3}$ and $v' < 0$ for $r > \frac{2r_0}{3} \Rightarrow$ at $r = \frac{2r_0}{3}$ there is a maximum.
- (b) The graph confirms the findings in (a).

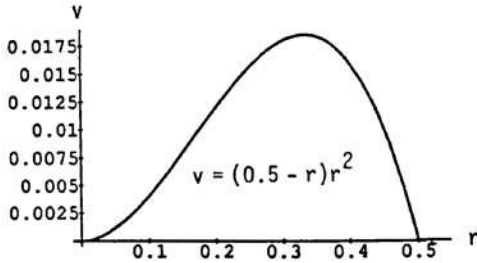

53. If $x > 0$, then $(x - 1)^2 \geq 0 \Rightarrow x^2 + 1 \geq 2x \Rightarrow \frac{x^2 + 1}{x} \geq 2$. In particular if a, b, c and d are positive integers, then $\left(\frac{a^2 + 1}{a}\right) \left(\frac{b^2 + 1}{b}\right) \left(\frac{c^2 + 1}{c}\right) \left(\frac{d^2 + 1}{d}\right) \geq 16$.

54. (a) $f(x) = \frac{x}{\sqrt{a^2 + x^2}} \Rightarrow f'(x) = \frac{(a^2 + x^2)^{1/2} - x^2(a^2 + x^2)^{-1/2}}{(a^2 + x^2)} = \frac{a^2 + x^2 - x^2}{(a^2 + x^2)^{3/2}} = \frac{a^2}{(a^2 + x^2)^{3/2}} > 0$
 $\Rightarrow f(x)$ is an increasing function of x

(b) $g(x) = \frac{d - x}{\sqrt{b^2 + (d - x)^2}} \Rightarrow g'(x) = \frac{-(b^2 + (d - x)^2)^{1/2} + (d - x)^2(b^2 + (d - x)^2)^{-1/2}}{b^2 + (d - x)^2}$
 $= \frac{-(b^2 + (d - x)^2) + (d - x)^2}{(b^2 + (d - x)^2)^{3/2}} = \frac{-b^2}{(b^2 + (d - x)^2)^{3/2}} < 0 \Rightarrow g(x)$ is a decreasing function of x

- (c) Since $c_1, c_2 > 0$, the derivative $\frac{dt}{dx}$ is an increasing function of x (from part (a)) minus a decreasing function of x (from part (b)): $\frac{dt}{dx} = \frac{1}{c_1} f(x) - \frac{1}{c_2} g(x) \Rightarrow \frac{d^2t}{dx^2} = \frac{1}{c_1} f'(x) - \frac{1}{c_2} g'(x) > 0$ since $f'(x) > 0$ and $g'(x) < 0 \Rightarrow \frac{dt}{dx}$ is an increasing function of x .

55. At $x = c$, the tangents to the curves are parallel. Justification: The vertical distance between the curves is $D(x) = f(x) - g(x)$, so $D'(x) = f'(x) - g'(x)$. The maximum value of D will occur at a point c where $D' = 0$. At such a point, $f'(c) - g'(c) = 0$, or $f'(c) = g'(c)$.

56. (a) $f(x) = 3 + 4 \cos x + \cos 2x$ is a periodic function with period 2π

(b) No, $f(x) = 3 + 4 \cos x + \cos 2x = 3 + 4 \cos x + (2 \cos^2 x - 1) = 2(1 + 2 \cos x + \cos^2 x) = 2(1 + \cos x)^2 \geq 0$
 $\Rightarrow f(x)$ is never negative

57. (a) If $y = \cot x - \sqrt{2} \csc x$ where $0 < x < \pi$, then $y' = (\csc x) (\sqrt{2} \cot x - \csc x)$. Solving $y' = 0$
 $\Rightarrow \cos x = \frac{1}{\sqrt{2}} \Rightarrow x = \frac{\pi}{4}$. For $0 < x < \frac{\pi}{4}$ we have $y' > 0$, and $y' < 0$ when $\frac{\pi}{4} < x < \pi$. Therefore, at $x = \frac{\pi}{4}$ there is a maximum value of $y = -1$.

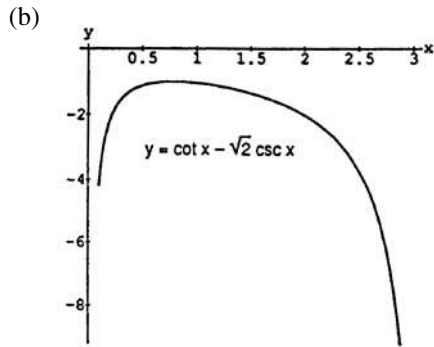

The graph confirms the findings in (a).

58. (a) If $y = \tan x + 3 \cot x$ where $0 < x < \frac{\pi}{2}$, then $y' = \sec^2 x - 3 \csc^2 x$. Solving $y' = 0 \Rightarrow \tan x = \pm \sqrt{3} \Rightarrow x = \pm \frac{\pi}{3}$, but $-\frac{\pi}{3}$ is not in the domain. Also, $y'' = 2 \sec^2 x \tan x + 3 \csc^2 x \cot x > 0$ for all $0 < x < \frac{\pi}{2}$. Therefore at $x = \frac{\pi}{3}$ there is a minimum value of $y = 2\sqrt{3}$.

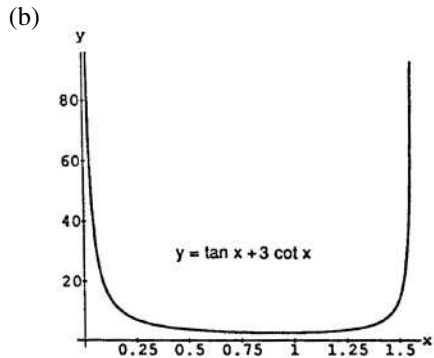

The graph confirms the findings in (a).

59. (a) The square of the distance is $D(x) = (x - \frac{3}{2})^2 + (\sqrt{x} + 0)^2 = x^2 - 2x + \frac{9}{4}$, so $D'(x) = 2x - 2$ and the critical point occurs at $x = 1$. Since $D'(x) < 0$ for $x < 1$ and $D'(x) > 0$ for $x > 1$, the critical point corresponds to the minimum distance. The minimum distance is $\sqrt{D(1)} = \frac{\sqrt{5}}{2}$.

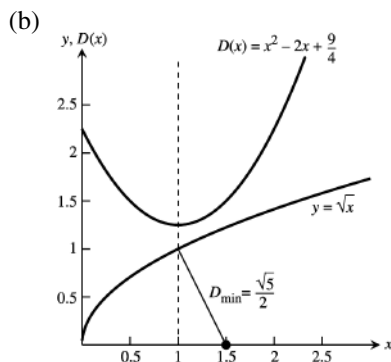

The minimum distance is from the point $(\frac{3}{2}, 0)$ to the point $(1, 1)$ on the graph of $y = \sqrt{x}$, and this occurs at the value $x = 1$ where $D(x)$, the distance squared, has its minimum value.

60. (a) Calculus Method:

The square of the distance from the point $(1, \sqrt{3})$ to $(x, \sqrt{16 - x^2})$ is given by

$$D(x) = (x - 1)^2 + (\sqrt{16 - x^2} - \sqrt{3})^2 = x^2 - 2x + 1 + 16 - x^2 - 2\sqrt{48 - 3x^2} + 3 = -2x + 20 - 2\sqrt{48 - 3x^2}.$$

Then $D'(x) = -2 - \frac{2}{\sqrt{48 - 3x^2}}(-6x) = -2 + \frac{6x}{\sqrt{48 - 3x^2}}$. Solving $D'(x) = 0$ we have: $6x = 2\sqrt{48 - 3x^2}$

$\Rightarrow 36x^2 = 4(48 - 3x^2) \Rightarrow 9x^2 = 48 - 3x^2 \Rightarrow 12x^2 = 48 \Rightarrow x = \pm 2$. We discard $x = -2$ as an extraneous solution, leaving $x = 2$. Since $D'(x) < 0$ for $-4 < x < 2$ and $D'(x) > 0$ for $2 < x < 4$, the critical point corresponds to the minimum distance. The minimum distance is $\sqrt{D(2)} = 2$.

Geometry Method:

The semicircle is centered at the origin and has radius 4. The distance from the origin to $(1, \sqrt{3})$ is

$\sqrt{1^2 + (\sqrt{3})^2} = 2$. The shortest distance from the point to the semicircle is the distance along the radius containing the point $(1, \sqrt{3})$. That distance is $4 - 2 = 2$.

(b)

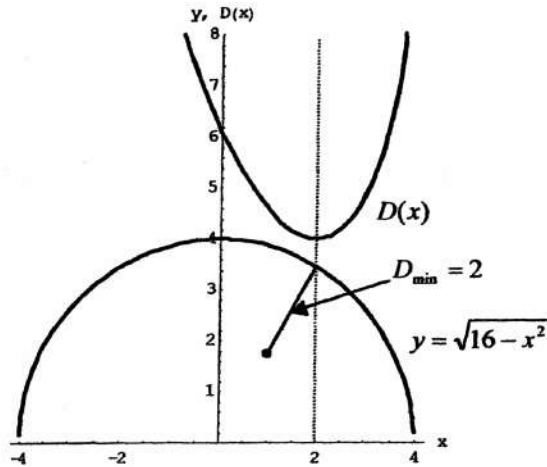

The minimum distance is from the point $(1, \sqrt{3})$ to the point $(2, 2\sqrt{3})$ on the graph of $y = \sqrt{16 - x^2}$, and this occurs at the value $x = 2$ where $D(x)$, the distance squared, has its minimum value.

61. (a) The base radius of the cone is $r = \frac{2\pi a - x}{2\pi}$ and so the height is $h = \sqrt{a^2 - r^2} = \sqrt{a^2 - \left(\frac{2\pi a - x}{2\pi}\right)^2}$. Therefore,

$$V(x) = \frac{\pi}{3} r^2 h = \frac{\pi}{3} \left(\frac{2\pi a - x}{2\pi}\right)^2 \sqrt{a^2 - \left(\frac{2\pi a - x}{2\pi}\right)^2}.$$

(b) To simplify the calculations, we shall consider the volume as a function of r : volume = $f(r) = \frac{\pi}{3} r^2 \sqrt{a^2 - r^2}$, where

$$0 < r < a. f'(r) = \frac{\pi}{3} \frac{d}{dr} (r^2 \sqrt{a^2 - r^2}) = \frac{\pi}{3} \left[r^2 \cdot \frac{1}{2\sqrt{a^2 - r^2}} (-2r) + (\sqrt{a^2 - r^2})(2r) \right] = \frac{\pi}{3} \left[\frac{-r^3 + 2r(a^2 - r^2)}{\sqrt{a^2 - r^2}} \right]$$

$$= \frac{\pi}{3} \left[\frac{2a^2 r - 3r^3}{\sqrt{a^2 - r^2}} \right] = \frac{\pi r(2a^2 - 3r^2)}{3\sqrt{a^2 - r^2}}. \text{ The critical point occurs when } r^2 = \frac{2a^2}{3}, \text{ which gives } r = a\sqrt{\frac{2}{3}} = \frac{a\sqrt{6}}{3}. \text{ Then}$$

$h = \sqrt{a^2 - r^2} = \sqrt{a^2 - \frac{2a^2}{3}} = \sqrt{\frac{a^2}{3}} = \frac{a\sqrt{3}}{3}$. Using $r = \frac{a\sqrt{6}}{3}$ and $h = \frac{a\sqrt{3}}{3}$, we may now find the values of r and h for the given values of a .

When $a = 4$: $r = \frac{4\sqrt{6}}{3}$, $h = \frac{4\sqrt{3}}{3}$;

When $a = 5$: $r = \frac{5\sqrt{6}}{3}$, $h = \frac{5\sqrt{3}}{3}$;

When $a = 6$: $r = 2\sqrt{6}$, $h = 2\sqrt{3}$;

When $a = 8$: $r = \frac{8\sqrt{6}}{3}$, $h = \frac{8\sqrt{3}}{3}$;

(c) Since $r = \frac{a\sqrt{6}}{3}$ and $h = \frac{a\sqrt{3}}{3}$, the relationship is $\frac{r}{h} = \sqrt{2}$.

62. (a) Let x_0 represent the fixed value of x at the point P , so that P has the coordinates (x_0, a) , and let $m = f'(x_0)$ be the slope of the line RT . Then the equation of the line RT is $y = m(x - x_0) + a$. The y -intercept of this line is $m(0 - x_0) + a = a - mx_0$, and the x -intercept is the solution of $m(x - x_0) + a = 0$, or $x = \frac{mx_0 - a}{m}$. Let O designate the origin. Then
(Area of triangle RST)

$$\begin{aligned}
 &= 2(\text{Area of triangle ORT}) \\
 &= 2 \cdot \frac{1}{2}(x\text{-intercept of line RT})(y\text{-intercept of line RT}) \\
 &= 2 \cdot \frac{1}{2} \left(\frac{mx_0 - a}{m} \right) (a - mx_0) \\
 &= -m \left(\frac{mx_0 - a}{m} \right) \left(\frac{mx_0 - a}{m} \right) \\
 &= -m \left(\frac{mx_0 - a}{m} \right)^2 \\
 &= -m \left(x_0 - \frac{a}{m} \right)^2
 \end{aligned}$$

Substituting x for x_0 , $f'(x)$ for m , and $f(x)$ for a , we have $A(x) = -f'(x) \left[x - \frac{f(x)}{f'(x)} \right]^2$.

- (b) The domain is the open interval $(0, 10)$. To graph, let $y_1 = f(x) = 5 + 5\sqrt{1 - \frac{x^2}{100}}$, $y_2 = f'(x) = \text{NDER}(y_1)$, and $y_3 = A(x) = -y_2 \left(x - \frac{y_1}{y_2} \right)^2$. The graph of the area function $y_3 = A(x)$ is shown below.

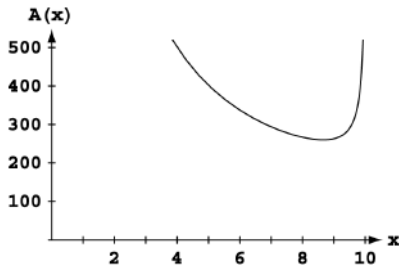

The vertical asymptotes at $x = 0$ and $x = 10$ correspond to horizontal or vertical tangent lines, which do not form triangles.

- (c) Using our expression for the y-intercept of the tangent line, the height of the triangle is

$$a - mx = f(x) - f'(x) \cdot x = 5 + \frac{1}{2}\sqrt{100 - x^2} - \frac{-x}{2\sqrt{100 - x^2}}x = 5 + \frac{1}{2}\sqrt{100 - x^2} + \frac{x^2}{2\sqrt{100 - x^2}}$$

We may use graphing methods or the analytic method in part (d) to find that the minimum value of $A(x)$ occurs at $x \approx 8.66$. Substituting this value into the expression above, the height of the triangle is 15. This is 3 times the y-coordinate of the center of the ellipse.

- (d) Part (a) remains unchanged. Assuming $C \geq B$, the domain is $(0, C)$. To graph, note that

$$f(x) = B + B\sqrt{1 - \frac{x^2}{C^2}} = B + \frac{B}{C}\sqrt{C^2 - x^2} \text{ and } f'(x) = \frac{B}{C} \frac{1}{2\sqrt{C^2 - x^2}}(-2x) = \frac{-Bx}{C\sqrt{C^2 - x^2}}. \text{ Therefore we have}$$

$$\begin{aligned}
 A(x) &= -f'(x) \left[x - \frac{f(x)}{f'(x)} \right]^2 = \frac{Bx}{C\sqrt{C^2 - x^2}} \left(x - \frac{B + \frac{B}{C}\sqrt{C^2 - x^2}}{\frac{-Bx}{C\sqrt{C^2 - x^2}}} \right)^2 = \frac{Bx}{C\sqrt{C^2 - x^2}} \left(x - \frac{(BC + B\sqrt{C^2 - x^2})(\sqrt{C^2 - x^2})}{-Bx} \right)^2 \\
 &= \frac{1}{BCx\sqrt{C^2 - x^2}} \left[Bx^2 + (BC + B\sqrt{C^2 - x^2})(\sqrt{C^2 - x^2}) \right]^2 = \frac{1}{BCx\sqrt{C^2 - x^2}} \left[Bx^2 + BC\sqrt{C^2 - x^2} + B(C^2 - x^2) \right]^2 \\
 &= \frac{1}{BCx\sqrt{C^2 - x^2}} \left[BC(C + \sqrt{C^2 - x^2}) \right]^2 = \frac{BC(C + \sqrt{C^2 - x^2})^2}{x\sqrt{C^2 - x^2}}
 \end{aligned}$$

$$A'(x) = BC \cdot \frac{(x\sqrt{C^2 - x^2})(2)(C + \sqrt{C^2 - x^2})\left(\frac{-x}{\sqrt{C^2 - x^2}}\right) - (C + \sqrt{C^2 - x^2})^2 \left(x\frac{-x}{\sqrt{C^2 - x^2}} + \sqrt{C^2 - x^2}(1)\right)}{x^2(C^2 - x^2)}$$

$$\begin{aligned}
 &= \frac{BC(C + \sqrt{C^2 - x^2})}{x^2(C^2 - x^2)} \left[-2x^2 - (C + \sqrt{C^2 - x^2}) \left(\frac{-x^2}{\sqrt{C^2 - x^2}} + \sqrt{C^2 - x^2} \right) \right] \\
 &= \frac{BC(C + \sqrt{C^2 - x^2})}{x^2(C^2 - x^2)} \left[-2x^2 + \frac{Cx^2}{\sqrt{C^2 - x^2}} - C\sqrt{C^2 - x^2} + x^2 - (C^2 - x^2) \right] \\
 &= \frac{BC(C + \sqrt{C^2 - x^2})}{x^2(C^2 - x^2)} \left(\frac{Cx^2}{\sqrt{C^2 - x^2}} - C\sqrt{C^2 - x^2} - C^2 \right) = \frac{BC(C + \sqrt{C^2 - x^2})}{x^2(C^2 - x^2)^{3/2}} \left[Cx^2 - C(C^2 - x^2) - C^2\sqrt{C^2 - x^2} \right] \\
 &= \frac{BC^2(C + \sqrt{C^2 - x^2})}{x^2(C^2 - x^2)^{3/2}} \left(2x^2 - C^2 - C\sqrt{C^2 - x^2} \right)
 \end{aligned}$$

To find the critical points for $0 < x < C$, we solve: $2x^2 - C^2 = C\sqrt{C^2 - x^2} \Rightarrow 4x^4 - 4C^2x^2 + C^4 = C^4 - C^2x^2 \Rightarrow 4x^4 - 3C^2x^2 = 0 \Rightarrow x^2(4x^2 - 3C^2) = 0$. The minimum value of $A(x)$ for $0 < x < C$ occurs at the critical point

$x = \frac{C\sqrt{3}}{2}$, or $x^2 = \frac{3C^2}{4}$. The corresponding triangle height is

$$\begin{aligned} a - mx &= f(x) - f'(x) \cdot x \\ &= B + \frac{B}{C} \sqrt{C^2 - x^2} + \frac{Bx^2}{C\sqrt{C^2 - \frac{3C^2}{4}}} \\ &= B + \frac{B}{C} \sqrt{C^2 - x^2} + \frac{B\left(\frac{3C^2}{4}\right)}{C\sqrt{C^2 - \frac{3C^2}{4}}} \\ &= B + \frac{B}{C} \left(\frac{C}{2}\right) + \frac{\frac{3BC^2}{4}}{\frac{C^2}{2}} \\ &= B + \frac{B}{2} + \frac{3B}{2} \\ &= 3B \end{aligned}$$

This shows that the triangle has minimum area when its height is $3B$.

4.6 INDETERMINATE FORMS AND L'HÔPITAL'S RULE

1. L'Hôpital: $\lim_{x \rightarrow 2} \frac{x-2}{x^2-4} = \frac{1}{2x} \Big|_{x=2} = \frac{1}{4}$ or $\lim_{x \rightarrow 2} \frac{x-2}{x^2-4} = \lim_{x \rightarrow 2} \frac{x-2}{(x-2)(x+2)} = \lim_{x \rightarrow 2} \frac{1}{x+2} = \frac{1}{4}$
2. L'Hôpital: $\lim_{x \rightarrow 0} \frac{\sin 5x}{x} = \frac{5 \cos 5x}{1} \Big|_{x=0} = 5$ or $\lim_{x \rightarrow 0} \frac{\sin 5x}{x} = 5 \lim_{5x \rightarrow 0} \frac{\sin 5x}{5x} = 5 \cdot 1 = 5$
3. L'Hôpital: $\lim_{x \rightarrow \infty} \frac{5x^2-3x}{7x^2+1} = \lim_{x \rightarrow \infty} \frac{10x-3}{14x} = \lim_{x \rightarrow \infty} \frac{10}{14} = \frac{5}{7}$ or $\lim_{x \rightarrow \infty} \frac{5x^2-3x}{7x^2+1} = \lim_{x \rightarrow \infty} \frac{5-\frac{3}{x}}{7+\frac{1}{x}} = \frac{5}{7}$
4. L'Hôpital: $\lim_{x \rightarrow 1} \frac{x^3-1}{4x^3-x-3} = \lim_{x \rightarrow 1} \frac{3x^2}{12x^2-1} = \frac{3}{11}$ or $\lim_{x \rightarrow 1} \frac{x^3-1}{4x^3-x-3} = \lim_{x \rightarrow 1} \frac{(x-1)(x^2+x+1)}{(x-1)(4x^2+4x+3)}$
 $= \lim_{x \rightarrow 1} \frac{(x^2+x+1)}{(4x^2+4x+3)} = \frac{3}{11}$
5. L'Hôpital: $\lim_{x \rightarrow 0} \frac{1-\cos x}{x^2} = \lim_{x \rightarrow 0} \frac{\sin x}{2x} = \lim_{x \rightarrow 0} \frac{\cos x}{2} = \frac{1}{2}$ or $\lim_{x \rightarrow 0} \frac{1-\cos x}{x^2} = \lim_{x \rightarrow 0} \left[\frac{(1-\cos x)}{x^2} \left(\frac{1+\cos x}{1+\cos x} \right) \right]$
 $= \lim_{x \rightarrow 0} \frac{\sin^2 x}{x^2(1+\cos x)} = \lim_{x \rightarrow 0} \left[\left(\frac{\sin x}{x} \right) \left(\frac{\sin x}{x} \right) \left(\frac{1}{1+\cos x} \right) \right] = \frac{1}{2}$
6. L'Hôpital: $\lim_{x \rightarrow \infty} \frac{2x^2+3x}{x^3+x+1} = \lim_{x \rightarrow \infty} \frac{4x+3}{3x^2+1} = \lim_{x \rightarrow \infty} \frac{4}{6x} = 0$ or $\lim_{x \rightarrow \infty} \frac{2x^2+3x}{x^3+x+1} = \lim_{x \rightarrow \infty} \frac{\frac{2}{x} + \frac{3}{x^2}}{1 + \frac{1}{x^2} + \frac{1}{x^3}} = \frac{0}{1} = 0$
7. $\lim_{t \rightarrow 0} \frac{\sin t^2}{t} = \lim_{t \rightarrow 0} \frac{2t \cos t^2}{1} = 0$
8. $\lim_{x \rightarrow \pi/2} \frac{2x-\pi}{\cos x} = \lim_{\theta \rightarrow \pi/2} \frac{2}{-\sin \theta} = \frac{2}{-1} = -2$
9. $\lim_{\theta \rightarrow \pi} \frac{\sin \theta}{\pi-\theta} = \lim_{\theta \rightarrow \pi} \frac{\cos \theta}{-1} = \frac{-1}{-1} = 1$
10. $\lim_{x \rightarrow \pi/2} \frac{1-\sin x}{1+\cos 2x} = \lim_{x \rightarrow \pi/2} \frac{-\cos x}{-2 \sin 2x} = \lim_{x \rightarrow \pi/2} \frac{\sin x}{-4 \cos 2x} = \frac{1}{-4(-1)} = \frac{1}{4}$
11. $\lim_{x \rightarrow \pi/4} \frac{\sin x - \cos x}{x - \frac{\pi}{4}} = \lim_{x \rightarrow \pi/4} \frac{\cos x + \sin x}{1} = \frac{\sqrt{2}}{2} + \frac{\sqrt{2}}{2} = \sqrt{2}$
12. $\lim_{x \rightarrow \pi/3} \frac{\cos x - \frac{1}{2}}{x - \frac{\pi}{3}} = \lim_{x \rightarrow \pi/3} \frac{-\sin x}{1} = -\frac{\sqrt{3}}{2}$

13. $\lim_{x \rightarrow \pi/2} -(x - \frac{\pi}{2}) \tan x = \lim_{x \rightarrow \pi/2} \frac{-(x - \frac{\pi}{2}) \sin x}{\cos x} = \lim_{x \rightarrow \pi/2} \frac{(\frac{\pi}{2} - x) \cos x + \sin x(-1)}{-\sin x} = \frac{-1}{-1} = 1$
14. $\lim_{x \rightarrow 0} \frac{2x}{x+7\sqrt{x}} = \lim_{x \rightarrow 0} \frac{2}{1+\frac{7}{2\sqrt{x}}} = \lim_{x \rightarrow 0} \frac{4\sqrt{x}}{2\sqrt{x}+7} = \frac{4 \cdot 0}{2 \cdot 0 + 7} = 0$
15. $\lim_{x \rightarrow 1} \frac{2x^2 - (3x+1)\sqrt{x} + 2}{x-1} = \lim_{x \rightarrow 1} \frac{2x^2 - 3x^{3/2} - x^{1/2} + 2}{x-1} = \lim_{x \rightarrow 1} \frac{4x - \frac{9}{2}x^{1/2} - \frac{1}{2\sqrt{x}}}{1} = -1$
16. $\lim_{x \rightarrow 2} \frac{\sqrt{x^2+5}-3}{x^2-4} = \lim_{x \rightarrow 2} \frac{\frac{1}{2}(x^2+5)^{-1/2}(2x)}{2x} = \lim_{x \rightarrow 2} \frac{1}{2\sqrt{x^2+5}} = \frac{1}{6}$
17. $\lim_{x \rightarrow 0} \frac{\sqrt{a(a+x)} - a}{x} = \lim_{x \rightarrow 0} \frac{a}{2\sqrt{a^2+ax}} = \frac{a}{2\sqrt{a^2}} = \frac{1}{2}$, where $a > 0$.
18. $\lim_{t \rightarrow 0} \frac{10(\sin t - t)}{t^3} = \lim_{t \rightarrow 0} \frac{10(\cos t - 1)}{3t^2} = \lim_{t \rightarrow 0} \frac{10(-\sin t)}{6t} = \lim_{t \rightarrow 0} \frac{-10 \cos t}{6} = \frac{-10 \cdot 1}{6} = -\frac{5}{3}$
19. $\lim_{x \rightarrow 0} \frac{x(\cos x - 1)}{\sin x - x} = \lim_{x \rightarrow 0} \frac{-x \sin x + \cos x - 1}{\cos x - 1} = \lim_{x \rightarrow 0} \frac{-x \cos x - 2 \sin x}{-\sin x} = \lim_{x \rightarrow 0} \frac{x \cos x + 2 \sin x}{\sin x} = \lim_{x \rightarrow 0} \frac{-x \sin x + 3 \cos x}{\cos x} = \frac{3}{1} = 3$
20. $\lim_{h \rightarrow 0} \frac{\sin(a+h) - \sin a}{h} = \lim_{h \rightarrow 0} \frac{\cos(a+h) - \cos a}{1} = 0$
21. $\lim_{r \rightarrow 1} \frac{a(r^n - 1)}{r - 1} = \lim_{r \rightarrow 1} \frac{a(n \cdot r^{n-1})}{1} = an \lim_{r \rightarrow 1} r^{n-1} = an$, where n is a positive integer.
22. $\lim_{x \rightarrow 0^+} \left(\frac{1}{x} - \frac{1}{\sqrt{x}} \right) = \lim_{x \rightarrow 0^+} \left(\frac{1 - \sqrt{x}}{x} \right) = \left(\begin{array}{l} \text{l'Hôpital's rule} \\ \text{does not apply} \end{array} \right) = \lim_{x \rightarrow 0^+} (1 - \sqrt{x}) \cdot \frac{1}{x} = \infty$
23. $\lim_{x \rightarrow \infty} (x - \sqrt{x^2 + x}) = \lim_{x \rightarrow \infty} (x - \sqrt{x^2 + x}) \left(\frac{x + \sqrt{x^2 + x}}{x + \sqrt{x^2 + x}} \right) = \lim_{x \rightarrow \infty} \frac{x^2 - (x^2 + x)}{x + \sqrt{x^2 + x}} = \lim_{x \rightarrow \infty} \frac{-x}{x + \frac{\sqrt{x^2 + x}}{\sqrt{x^2}}} = \lim_{x \rightarrow \infty} \frac{-1}{1 + \sqrt{1 + \frac{1}{x}}} = -\frac{1}{2}$ (l'Hôpital's rule is unnecessary)
24. $\lim_{x \rightarrow \infty} x \tan\left(\frac{1}{x}\right) = \lim_{x \rightarrow \infty} \frac{\tan\left(\frac{1}{x}\right)}{\frac{1}{x}} = \lim_{x \rightarrow \infty} \frac{-\frac{1}{x^2} \sec^2\left(\frac{1}{x}\right)}{-\frac{1}{x^2}} = \lim_{x \rightarrow \infty} \sec^2\left(\frac{1}{x}\right) = \sec^2 0 = 1$
25. $\lim_{x \rightarrow \pm \infty} \frac{3x-5}{2x^2-x+2} = \lim_{x \rightarrow \pm \infty} \frac{3}{4x-1} = 0$
26. $\lim_{x \rightarrow 0} \frac{\sin 7x}{\tan 11x} = \lim_{x \rightarrow 0} \frac{7 \cos(7x)}{11 \sec^2(11x)} = \frac{7 \cdot 1}{11 \cdot 1} = \frac{7}{11}$
27. $\lim_{x \rightarrow \infty} \frac{\sqrt{9x+1}}{\sqrt{x+1}} = \sqrt{x} \lim_{x \rightarrow \infty} \frac{9x+1}{x+1} = \sqrt{x} \lim_{x \rightarrow \infty} \frac{9}{1} = \sqrt{9} = 3$
28. $\lim_{x \rightarrow 0^+} \frac{\sqrt{x}}{\sqrt{\sin x}} = \sqrt{\lim_{x \rightarrow 0^+} \frac{1}{\frac{\sin x}{x}}} = \sqrt{\frac{1}{1}} = 1$
29. $\lim_{x \rightarrow \pi/2^-} \frac{\sec x}{\tan x} = \lim_{x \rightarrow \pi/2^-} \left(\frac{1}{\cos x} \right) \left(\frac{\cos x}{\sin x} \right) = \lim_{x \rightarrow \pi/2^-} \frac{1}{\sin x} = 1$
30. $\lim_{x \rightarrow 0^+} \frac{\cot x}{\csc x} = \lim_{x \rightarrow 0^+} \frac{\left(\frac{\cos x}{\sin x} \right)}{\left(\frac{1}{\sin x} \right)} = \lim_{x \rightarrow 0^+} \cos x = 1$

31. Part (b) is correct because part (a) is neither in the $\frac{0}{0}$ nor $\frac{\infty}{\infty}$ form and so l'Hôpital's rule may not be used.

32. Answers may vary.

(a) $f(x) = 3x + 1; g(x) = x$

$$\lim_{x \rightarrow \infty} \frac{f(x)}{g(x)} = \lim_{x \rightarrow \infty} \frac{3x+1}{x} = \lim_{x \rightarrow \infty} \frac{3}{1} = 3$$

(b) $f(x) = x + 1; g(x) = x^2$

$$\lim_{x \rightarrow \infty} \frac{f(x)}{g(x)} = \lim_{x \rightarrow \infty} \frac{x+1}{x^2} = \lim_{x \rightarrow \infty} \frac{1}{2x} = 0$$

(c) $f(x) = x^2; g(x) = x + 1$

$$\lim_{x \rightarrow \infty} \frac{f(x)}{g(x)} = \lim_{x \rightarrow \infty} \frac{x^2}{x+1} = \lim_{x \rightarrow \infty} \frac{2x}{1} = \infty$$

33. If $f(x)$ is to be continuous at $x = 0$, then $\lim_{x \rightarrow 0} f(x) = f(0) \Rightarrow c = f(0) = \lim_{x \rightarrow 0} \frac{9x - 3 \sin 3x}{5x^3} = \lim_{x \rightarrow 0} \frac{9 - 9 \cos 3x}{15x^2}$
 $= \lim_{x \rightarrow 0} \frac{27 \sin 3x}{30x} = \lim_{x \rightarrow 0} \frac{81 \cos 3x}{30} = \frac{27}{10}.$

34. (a) For $x \neq 0$, $f'(x) = \frac{d}{dx}(x+2) = 1$ and $g'(x) = \frac{d}{dx}(x+1) = 1$. Therefore, $\lim_{x \rightarrow 0} \frac{f'(x)}{g'(x)} = \frac{1}{1} = 1$, while $\lim_{x \rightarrow 0} \frac{f(x)}{g(x)} = \frac{x+2}{x+1} = \frac{0+2}{0+1} = 2$.

(b) This does not contradict l'Hôpital's rule because neither f nor g is differentiable at $x = 0$ (as evidenced by the fact that neither is continuous at $x = 0$), so l'Hôpital's rule does not apply.

35. The graph indicates a limit near -1 . The limit leads to the

$$\begin{aligned} \text{indeterminate form } \frac{0}{0}: \lim_{x \rightarrow 1} \frac{2x^2 - (3x+1)\sqrt{x+2}}{x-1} \\ = \lim_{x \rightarrow 1} \frac{2x^2 - 3x^{3/2} - x^{1/2} + 2}{x-1} &= \lim_{x \rightarrow 1} \frac{4x - \frac{9}{2}x^{1/2} - \frac{1}{2}x^{-1/2}}{1} \\ = \frac{4 - \frac{9}{2} - \frac{1}{2}}{1} &= \frac{4-5}{1} = -1 \end{aligned}$$

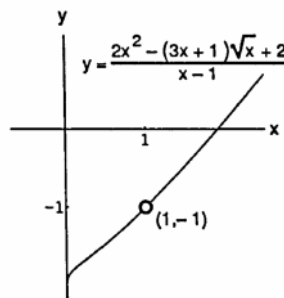

36. (a)

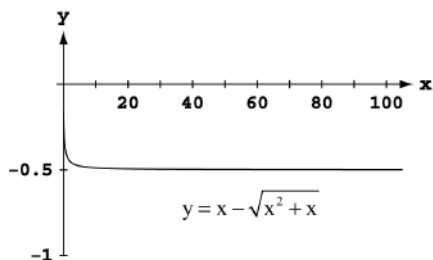

(b) The limit leads to the indeterminate form $\infty - \infty$:

$$\begin{aligned} \lim_{x \rightarrow \infty} (x - \sqrt{x^2 + x}) &= \lim_{x \rightarrow \infty} (x - \sqrt{x^2 + x}) \left(\frac{x + \sqrt{x^2 + x}}{x + \sqrt{x^2 + x}} \right) = \lim_{x \rightarrow \infty} \left(\frac{x^2 - (x^2 + x)}{x + \sqrt{x^2 + x}} \right) = \lim_{x \rightarrow \infty} \frac{-x}{x + \sqrt{x^2 + x}} \\ &= \lim_{x \rightarrow \infty} \frac{-1}{1 + \sqrt{1 + \frac{1}{x}}} = \frac{-1}{1 + \sqrt{1+0}} = -\frac{1}{2} \end{aligned}$$

37. Graphing $f(x) = \frac{1 - \cos x^6}{x^{12}}$ on th window $[-1, 1]$ by $[-0.5, 1]$ it appears that $\lim_{x \rightarrow 0} f(x) = 0$. However, we see that if we let

$$u = x^6, \text{ then } \lim_{x \rightarrow 0} f(x) = \lim_{u \rightarrow 0} \frac{1 - \cos u}{u^2} = \lim_{u \rightarrow 0} \frac{\sin u}{2u} = \lim_{u \rightarrow 0} \frac{\cos u}{2} = \frac{1}{2}.$$

38. (a) We seek c in $(-2, 0)$ so that $\frac{f'(c)}{g'(c)} = \frac{f(0) - f(-2)}{g(0) - g(-2)} = \frac{0+2}{0-4} = -\frac{1}{2}$. Since $f'(c) = 1$ and $g'(c) = 2c$ we have that $\frac{1}{2c} = -\frac{1}{2} \Rightarrow c = -1$.

- (b) We seek c in any open interval (a, b) so that $\frac{f'(c)}{g'(c)} = \frac{f(b)-f(a)}{g(b)-g(a)} = \frac{b-a}{b^2-a^2} = \frac{b-a}{(b-a)(b+a)} = \frac{1}{b+a} \Rightarrow \frac{1}{2c} = \frac{1}{b+a} \Rightarrow c = \frac{b+a}{2}$
- (c) We seek c in $(0, 3)$ so that $\frac{f'(c)}{g'(c)} = \frac{f(3)-f(0)}{g(3)-g(0)} = \frac{-3-0}{9-0} = -\frac{1}{3} \Rightarrow \frac{c^2-4}{2c} = -\frac{1}{3} \Rightarrow 3c^2 + 2c - 12 = 0 \Rightarrow c = \frac{-1 \pm \sqrt{37}}{3}$.
 (Note that $c = \frac{-1-\sqrt{37}}{3}$ is not in the given interval $(0, 3)$.)

39. (a) By similar triangles, $\frac{PA}{AB} = \frac{CE}{EB}$ where E is the point on \overleftrightarrow{AB} such that $\overleftrightarrow{CE} \perp \overleftrightarrow{AB}$:

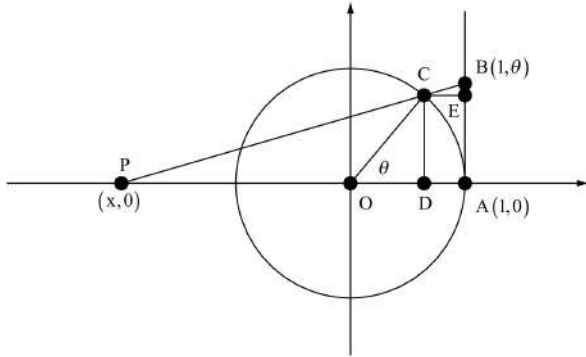

Thus $\frac{1-x}{\theta} = \frac{1-\cos \theta}{\theta - \sin \theta}$, since the coordinates of C are $(\cos \theta, \sin \theta)$. Hence, $1-x = \frac{\theta(1-\cos \theta)}{\theta - \sin \theta}$.

- (b) $\lim_{\theta \rightarrow 0} (1-x) = \lim_{\theta \rightarrow 0} \frac{\theta(1-\cos \theta)}{\theta - \sin \theta} = \lim_{\theta \rightarrow 0} \frac{\theta \sin \theta + 1 - \cos \theta}{1 - \cos \theta} = \lim_{\theta \rightarrow 0} \frac{\theta \cos \theta + \sin \theta + \sin \theta}{\sin \theta} = \lim_{\theta \rightarrow 0} \frac{\theta \cos \theta + 2\sin \theta}{\sin \theta}$
 $= \lim_{\theta \rightarrow 0} \frac{\theta(-\sin \theta) + \cos \theta + 2\cos \theta}{\cos \theta} = \lim_{\theta \rightarrow 0} \frac{-\theta \sin \theta + 3\cos \theta}{\cos \theta} = \frac{0+3}{1} = 3$
- (c) We have that $\lim_{\theta \rightarrow \infty} [(1-x) - (1-\cos \theta)] = \lim_{\theta \rightarrow \infty} \left[\frac{\theta(1-\cos \theta)}{\theta - \sin \theta} - (1-\cos \theta) \right] = \lim_{\theta \rightarrow \infty} (1-\cos \theta) \left[\frac{\theta}{\theta - \sin \theta} - 1 \right]$
 As $\theta \rightarrow \infty$, $(1-\cos \theta)$ oscillates between 0 and 2, and so it is bounded. Since $\lim_{\theta \rightarrow \infty} \left(\frac{\theta}{\theta - \sin \theta} - 1 \right) = 1 - 1 = 0$,
 $\lim_{\theta \rightarrow \infty} (1-\cos \theta) \left[\frac{\theta}{\theta - \sin \theta} - 1 \right] = 0$. Geometrically, this means that as $\theta \rightarrow \infty$, the distance between points P and D approaches 0.

40. Throughout this problem note that $r^2 = y^2 + 1$, $r > y$ and that both $r \rightarrow \infty$ and $y \rightarrow \infty$ as $\theta \rightarrow \frac{\pi}{2}$.

- (a) $\lim_{\theta \rightarrow \pi/2} r - y = \lim_{\theta \rightarrow \pi/2} \frac{1}{r+y} = 0$
- (b) $\lim_{\theta \rightarrow \pi/2} r^2 - y^2 = \lim_{\theta \rightarrow \pi/2} 1 = 1$
- (c) We have that $r^3 - y^3 = (r-y)(r^2 + ry + y^2) = \frac{r^2 + ry + y^2}{r+y} > \frac{y^2 + y \cdot y + y^2}{r} = \frac{3y^2}{r} = 3y \cdot \frac{y}{r}$.
 Since $\lim_{\theta \rightarrow \pi/2} 3y \cdot \frac{y}{r} = \lim_{\theta \rightarrow \pi/2} 3\sin \theta \cdot y = \infty$ we have that $\lim_{\theta \rightarrow \pi/2} r^3 - y^3 = \infty$.

4.7 NEWTON'S METHOD

- $y = x^2 + x - 1 \Rightarrow y' = 2x + 1 \Rightarrow x_{n+1} = x_n - \frac{x_n^2 + x_n - 1}{2x_n + 1}; x_0 = 1 \Rightarrow x_1 = 1 - \frac{1+1-1}{2+1} = \frac{2}{3}$
 $\Rightarrow x_2 = \frac{2}{3} - \frac{\frac{4}{9} + \frac{2}{3} - 1}{\frac{4}{3} + 1} \Rightarrow x_2 = \frac{2}{3} - \frac{4+6-9}{12+9} = \frac{2}{3} - \frac{1}{21} = \frac{13}{21} \approx .61905; x_0 = -1 \Rightarrow x_1 = 1 - \frac{1-1-1}{-2+1} = -2$
 $\Rightarrow x_2 = -2 - \frac{4-2-1}{-4+1} = -\frac{5}{3} \approx -1.66667$
- $y = x^3 + 3x + 1 \Rightarrow y' = 3x^2 + 3 \Rightarrow x_{n+1} = x_n - \frac{x_n^3 + 3x_n + 1}{3x_n^2 + 3}; x_0 = 0 \Rightarrow x_1 = 0 - \frac{1}{3} = -\frac{1}{3}$
 $\Rightarrow x_2 = -\frac{1}{3} - \frac{-\frac{1}{27} - 1 + 1}{\frac{1}{9} + 3} = -\frac{1}{3} + \frac{1}{90} = -\frac{29}{90} \approx -0.32222$

3. $y = x^4 + x - 3 \Rightarrow y' = 4x^3 + 1 \Rightarrow x_{n+1} = x_n - \frac{x_n^4 + x_n - 3}{4x_n^3 + 1}; x_0 = 1 \Rightarrow x_1 = 1 - \frac{1+1-3}{4+1} = \frac{6}{5}$
 $\Rightarrow x_2 = \frac{6}{5} - \frac{\frac{1296}{625} + \frac{6}{5} - 3}{\frac{864}{125} + 1} = \frac{6}{5} - \frac{1296+750-1875}{4320+625} = \frac{6}{5} - \frac{171}{4945} = \frac{5763}{4945} \approx 1.16542; x_0 = -1 \Rightarrow x_1 = -1 - \frac{1-1-3}{-4+1}$
 $= -2 \Rightarrow x_2 = -2 - \frac{16-2-3}{-32+1} = -2 + \frac{11}{31} = -\frac{51}{31} \approx -1.64516$

4. $y = 2x - x^2 + 1 \Rightarrow y' = 2 - 2x \Rightarrow x_{n+1} = x_n - \frac{2x_n - x_n^2 + 1}{2 - 2x_n}; x_0 = 0 \Rightarrow x_1 = 0 - \frac{0-0+1}{2-0} = -\frac{1}{2}$
 $\Rightarrow x_2 = -\frac{1}{2} - \frac{-1-\frac{1}{4}+1}{2+1} = -\frac{1}{2} + \frac{1}{12} = -\frac{5}{12} \approx -.41667; x_0 = 2 \Rightarrow x_1 = 2 - \frac{4-4+1}{2-4} = \frac{5}{2} \Rightarrow x_2 = \frac{5}{2} - \frac{5-\frac{25}{4}+1}{2-\frac{5}{2}}$
 $= \frac{5}{2} - \frac{20-25+4}{-12} = \frac{5}{2} - \frac{1}{12} = \frac{29}{12} \approx 2.41667$

5. $y = x^4 - 2 \Rightarrow y' = 4x^3 \Rightarrow x_{n+1} = x_n - \frac{x_n^4 - 2}{4x_n^3}; x_0 = 1 \Rightarrow x_1 = 1 - \frac{1-2}{4} = \frac{5}{4} \Rightarrow x_2 = \frac{5}{4} - \frac{\frac{625}{16} - 2}{\frac{125}{8}} = \frac{5}{4} - \frac{625-512}{2000}$
 $= \frac{5}{4} - \frac{113}{2000} = \frac{2500-113}{2000} = \frac{2387}{2000} \approx 1.1935$

6. From Exercise 5, $x_{n+1} = x_n - \frac{x_n^4 - 2}{4x_n^3}; x_0 = -1 \Rightarrow x_1 = -1 - \frac{1-2}{-4} = -1 - \frac{1}{4} = -\frac{5}{4} \Rightarrow x_2 = -\frac{5}{4} - \frac{\frac{625}{64} - 2}{-\frac{125}{8}}$
 $= -\frac{5}{4} - \frac{625-512}{-2000} = -\frac{5}{4} + \frac{113}{2000} \approx -1.1935$

7. $f(x_0) = 0$ and $f'(x_0) \neq 0 \Rightarrow x_{n+1} = x_n - \frac{f(x_n)}{f'(x_n)}$ gives $x_1 = x_0 \Rightarrow x_2 = x_0 \Rightarrow x_n = x_0$ for all $n \geq 0$. That is, all of the approximations in Newton's method will be the root of $f(x) = 0$.

8. It does matter. If you start too far away from $x = \frac{\pi}{2}$, the calculated values may approach some other root. Starting with $x_0 = -0.5$, for instance, leads to $x = -\frac{\pi}{2}$ as the root, not $x = \frac{\pi}{2}$.

9. If $x_0 = h > 0 \Rightarrow x_1 = x_0 - \frac{f(x_0)}{f'(x_0)} = h - \frac{f(h)}{f'(h)}$
 $= h - \frac{\sqrt{h}}{\left(\frac{1}{2\sqrt{h}}\right)} = h - \left(\sqrt{h}\right) \left(2\sqrt{h}\right) = -h;$

if $x_0 = -h < 0 \Rightarrow x_1 = x_0 - \frac{f(x_0)}{f'(x_0)} = -h - \frac{f(-h)}{f'(-h)}$
 $= -h - \frac{\sqrt{h}}{\left(\frac{-1}{2\sqrt{h}}\right)} = -h + \left(\sqrt{h}\right) \left(2\sqrt{h}\right) = h.$

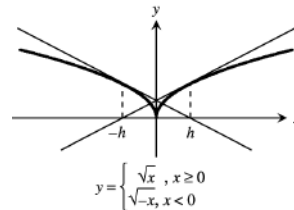

10. $f(x) = x^{1/3} \Rightarrow f'(x) = \left(\frac{1}{3}\right) x^{-2/3} \Rightarrow x_{n+1} = x_n - \frac{x_n^{1/3}}{\left(\frac{1}{3}\right) x_n^{-2/3}}$
 $= -2x_n; x_0 = 1 \Rightarrow x_1 = -2, x_2 = 4, x_3 = -8, \text{ and}$
 $x_4 = 16 \text{ and so forth. Since } |x_n| = 2|x_{n-1}| \text{ we may conclude}$
 that $n \rightarrow \infty \Rightarrow |x_n| \rightarrow \infty$.

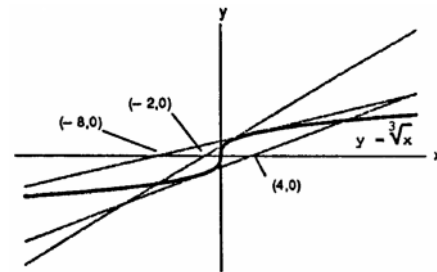

11. i) is equivalent to solving $x^3 - 3x - 1 = 0$.
 ii) is equivalent to solving $x^3 - 3x - 1 = 0$.
 iii) is equivalent to solving $x^3 - 3x - 1 = 0$.
 iv) is equivalent to solving $x^3 - 3x - 1 = 0$.
 All four equations are equivalent.

12. $f(x) = x - 1 - 0.5 \sin x \Rightarrow f'(x) = 1 - 0.5 \cos x \Rightarrow x_{n+1} = x_n - \frac{x_n - 1 - 0.5 \sin x_n}{1 - 0.5 \cos x_n}; \text{ if } x_0 = 1.5, \text{ then}$
 $x_1 = 1.49870$

13. For $x_0 = -0.3$, the procedure converges to the root $-0.32218535\dots$

```
(a)
Plot1 Plot2 Plot3
\y1=x^3+3x+1
\y2=3Der(y1,x,x)
-----
X=0= WIND ZOOM TRACE GRAPH
x y INSZ DELC SFLC/T
```

```
(b)
-.3→x
-----
-.3
```

```
(c)
x-y1/y2→x
-----
-.322324152194
-.322185360292
-.322185354626
-.322185354626
```

(d) Values for x will vary. One possible choice is $x_0 = 0.1$.

```
(e)
.1→x
-----
.1
x-y1/y2→x
-----
-.329372795587
-.322200595043
-.322185354698
-.322185354626
```

(e) Values for x will vary.

14. (a) $f(x) = x^3 - 3x - 1 \Rightarrow f'(x) = 3x^2 - 3 \Rightarrow x_{n+1} = x_n - \frac{x_n^3 - 3x_n - 1}{3x_n^2 - 3} \Rightarrow$ the two negative zeros are -1.53209 and -0.34730

(b) The estimated solutions of $x^3 - 3x - 1 = 0$ are $-1.53209, -0.34730, 1.87939$.

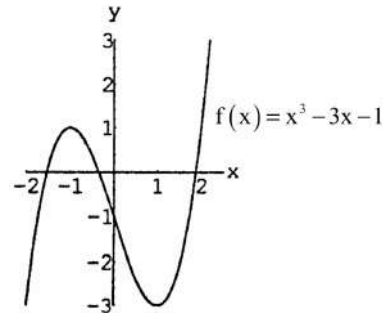

(c) The estimated x -values where $g(x) = 0.25x^4 - 1.5x^2 - x + 5$ has horizontal tangents are the roots of $g'(x) = x^3 - 3x - 1$, and these are $-1.53209, -0.34730, 1.87939$.

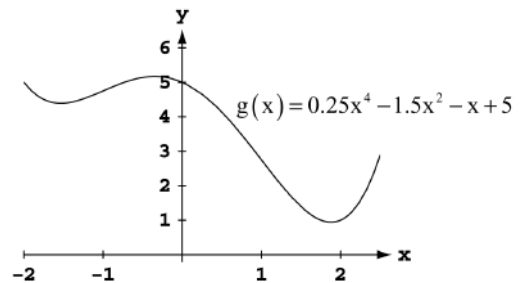

15. $f(x) = \tan x - 2x \Rightarrow f'(x) = \sec^2 x - 2 \Rightarrow x_{n+1} = x_n - \frac{\tan(x_n) - 2x_n}{\sec^2(x_n)}$; $x_0 = 1 \Rightarrow x_1 = 1.2920445$
 $\Rightarrow x_2 = 1.155327774 \Rightarrow x_{16} = x_{17} = 1.165561185$

16. $f(x) = x^4 - 2x^3 - x^2 - 2x + 2 \Rightarrow f'(x) = 4x^3 - 6x^2 - 2x - 2 \Rightarrow x_{n+1} = x_n - \frac{x_n^4 - 2x_n^3 - x_n^2 - 2x_n + 2}{4x_n^3 - 6x_n^2 - 2x_n - 2}$;
 if $x_0 = 0.5$, then $x_4 = 0.630115396$; if $x_0 = 2.5$, then $x_4 = 2.57327196$

17. (a) The graph of $f(x) = \sin 3x - 0.99 + x^2$ in the window $-2 \leq x \leq 2, -2 \leq y \leq 3$ suggests three roots. However, when you zoom in on the x -axis near $x = 1.2$, you can see that the graph lies above the axis there. There are only two roots, one near $x = -1$, the other near $x = 0.4$.

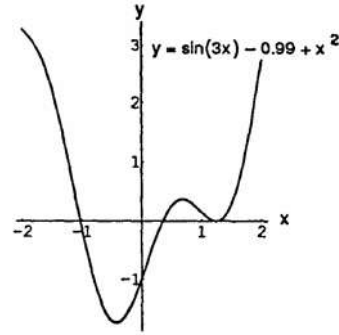

- (b) $f(x) = \sin 3x - 0.99 + x^2 \Rightarrow f'(x) = 3 \cos 3x + 2x$
 $\Rightarrow x_{n+1} = x_n - \frac{\sin(3x_n) - 0.99 + x_n^2}{3 \cos(3x_n) + 2x_n}$ and the solutions are approximately 0.35003501505249 and -1.0261731615301

18. (a) Yes, three times as indicated by the graphs

- (b) $f(x) = \cos 3x - x \Rightarrow f'(x) = -3 \sin 3x - 1 \Rightarrow x_{n+1} = x_n - \frac{\cos(3x_n) - x_n}{-3 \sin(3x_n) - 1}$; at approximately $-0.979367, -0.887726$, and 0.39004 we have $\cos 3x = x$

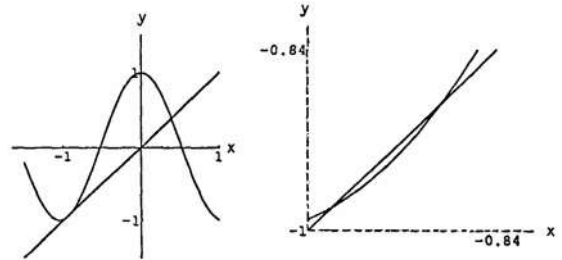

19. $f(x) = 2x^4 - 4x^2 + 1 \Rightarrow f'(x) = 8x^3 - 8x \Rightarrow x_{n+1} = x_n - \frac{2x_n^4 - 4x_n^2 + 1}{8x_n^3 - 8x_n}$; if $x_0 = -2$, then $x_6 = -1.30656296$; if $x_0 = -0.5$, then $x_3 = -0.5411961$; the roots are approximately ± 0.5411961 and ± 1.30656296 because $f(x)$ is an even function.

20. $f(x) = \tan x \Rightarrow f'(x) = \sec^2 x \Rightarrow x_{n+1} = x_n - \frac{\tan(x_n)}{\sec^2(x_n)}$; $x_0 = 3 \Rightarrow x_1 = 3.13971 \Rightarrow x_2 = 3.14159$ and we approximate π to be 3.14159.

21. From the graph we let $x_0 = 0.5$ and $f(x) = \cos x - 2x$
 $\Rightarrow x_{n+1} = x_n - \frac{\cos(x_n) - 2x_n}{-\sin(x_n) - 2} \Rightarrow x_1 = .45063$
 $\Rightarrow x_2 = .45018 \Rightarrow$ at $x \approx 0.45$ we have $\cos x = 2x$.

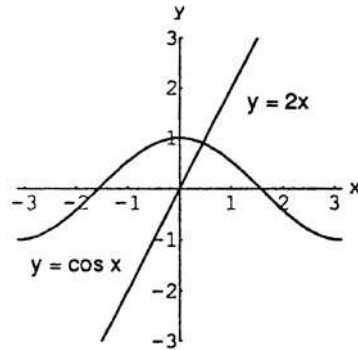

22. From the graph we let $x_0 = -0.7$ and $f(x) = \cos x + x$
 $\Rightarrow x_{n+1} = x_n - \frac{x_n + \cos(x_n)}{1 - \sin(x_n)} \Rightarrow x_1 = -.73944$
 $\Rightarrow x_2 = -.73908 \Rightarrow$ at $x \approx -0.74$ we have $\cos x = -x$.

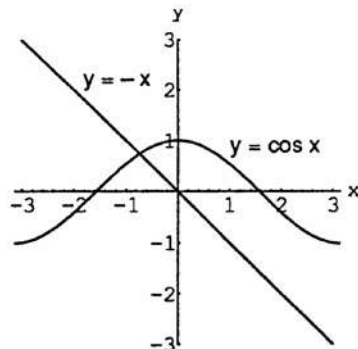

23. If $f(x) = x^3 + 2x - 4$, then $f(1) = -1 < 0$ and $f(2) = 8 > 0 \Rightarrow$ by the Intermediate Value Theorem the equation $x^3 + 2x - 4 = 0$ has a solution between 1 and 2. Consequently, $f'(x) = 3x^2 + 2$ and $x_{n+1} = x_n - \frac{x_n^3 + 2x_n - 4}{3x_n^2 + 2}$.
Then $x_0 = 1 \Rightarrow x_1 = 1.2 \Rightarrow x_2 = 1.17975 \Rightarrow x_3 = 1.179509 \Rightarrow x_4 = 1.1795090 \Rightarrow$ the root is approximately 1.17951.

24. We wish to solve $8x^4 - 14x^3 - 9x^2 + 11x - 1 = 0$. Let $f(x) = 8x^4 - 14x^3 - 9x^2 + 11x - 1$, then $f'(x) = 32x^3 - 42x^2 - 18x + 11 \Rightarrow x_{n+1} = x_n - \frac{8x_n^4 - 14x_n^3 - 9x_n^2 + 11x_n - 1}{32x_n^3 - 42x_n^2 - 18x_n + 11}$.

x_0	approximation of corresponding root
-1.0	-0.976823589
0.1	0.100363332
0.6	0.642746671
2.0	1.983713587

25. $f(x) = 4x^4 - 4x^2 \Rightarrow f'(x) = 16x^3 - 8x \Rightarrow x_{i+1} = x_i - \frac{f(x_i)}{f'(x_i)} = x_i - \frac{x_i^3 - x_i}{4x_i^2 - 2}$. Iterations are performed using the procedure in problem 13 in this section.

- (a) For $x_0 = 2$ or $x_0 = -0.8$, $x_i \rightarrow -1$ as i gets large.
- (b) For $x_0 = -0.5$ or $x_0 = 0.25$, $x_i \rightarrow 0$ as i gets large.
- (c) For $x_0 = 0.8$ or $x_0 = 2$, $x_i \rightarrow 1$ as i gets large.
- (d) (If your calculator has a CAS, put it in exact mode, otherwise approximate the radicals with a decimal value.)
For $x_0 = -\frac{\sqrt{21}}{7}$ or $x_0 = \frac{\sqrt{21}}{7}$, Newton's method does not converge. The values of x_i alternate between $x_0 = -\frac{\sqrt{21}}{7}$ or $x_0 = \frac{\sqrt{21}}{7}$ as i increases.

26. (a) The distance can be represented by $D(x) = \sqrt{(x-2)^2 + (x^2 + \frac{1}{2})^2}$, where $x \geq 0$. The distance $D(x)$ is minimized when $f(x) = (x-2)^2 + (x^2 + \frac{1}{2})^2$ is minimized. If $f(x) = (x-2)^2 + (x^2 + \frac{1}{2})^2$, then $f'(x) = 4(x^3 + x - 1)$ and $f''(x) = 4(3x^2 + 1) > 0$.
Now $f'(x) = 0 \Rightarrow x^3 + x - 1 = 0 \Rightarrow x(x^2 + 1) = 1 \Rightarrow x = \frac{1}{x^2 + 1}$.

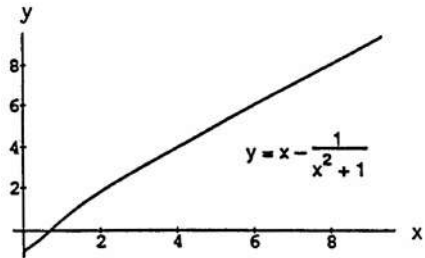

(b) Let $g(x) = \frac{1}{x^2+1} - x = (x^2 + 1)^{-1} - x \Rightarrow g'(x) = -(x^2 + 1)^{-2}(2x) - 1 = \frac{-2x}{(x^2 + 1)^2} - 1$
 $\Rightarrow x_{n+1} = x_n - \frac{\left(\frac{1}{x_n^2+1} - x_n\right)}{\left(\frac{-2x_n}{(x_n^2+1)^2} - 1\right)}$; $x_0 = 1 \Rightarrow x_4 = 0.68233$ to five decimal places.

27. $f(x) = (x-1)^{40} \Rightarrow f'(x) = 40(x-1)^{39} \Rightarrow x_{n+1} = x_n - \frac{(x_n-1)^{40}}{40(x_n-1)^{39}} = \frac{39x_n+1}{40}$. With $x_0 = 2$, our computer gave $x_{87} = x_{88} = x_{89} = \dots = x_{200} = 1.11051$, coming within 0.11051 of the root $x = 1$.

28. $f(x) = 4x^4 - 4x^2 \Rightarrow f'(x) = 16x^3 - 8x = 8x(2x^2 - 1) \Rightarrow x_{n+1} = x_n - \frac{x_n(x_n^2 - 1)}{2(2x_n^2 - 1)}$; if $x_0 = .65$, then $x_{12} \approx -.000004$, if $x_0 = .7$, then $x_{12} = -1.000004$; if $x_0 = .8$, then $x_6 = 1.000000$. NOTE: $\frac{\sqrt{21}}{7} \approx .654654$

29. $f(x) = x^3 + 3.6x^2 - 36.4 \Rightarrow f'(x) = 3x^2 + 7.2x \Rightarrow x_{n+1} = x_n - \frac{x_n^3 + 3.6x_n^2 - 36.4}{3x_n^2 + 7.2x_n}$; $x_0 = 2 \Rightarrow x_1 = 2.5303 \Rightarrow x_2 = 2.45418225 \Rightarrow x_3 = 2.45238021 \Rightarrow x_4 = 2.45237921$ which is 2.45 to two decimal places. Recall that

$$x = 10^4 [\text{H}_3\text{O}^+] \Rightarrow [\text{H}_3\text{O}^+] = (x)(10^{-4}) = (2.45)(10^{-4}) = 0.000245$$

30. Newton's method yields the following:

the initial value	2	i	$\sqrt{3} + i$
the approached value	1	-5.55931i	-29.5815 - 17.0789i

4.8 ANTIDERIVATIVES

1. (a) x^2 (b) $\frac{x^3}{3}$ (c) $\frac{x^3}{3} - x^2 + x$
 2. (a) $3x^2$ (b) $\frac{x^8}{8}$ (c) $\frac{x^8}{8} - 3x^2 + 8x$
 3. (a) x^{-3} (b) $-\frac{x^{-2}}{2}$ (c) $-\frac{x^{-3}}{3} + x^2 + 3x$
 4. (a) $-x^{-2}$ (b) $-\frac{x^{-1}}{1} + \frac{x^3}{3}$ (c) $\frac{x^{-2}}{2} + \frac{x^2}{2} - x$
 5. (a) $\frac{-1}{x}$ (b) $\frac{-5}{x}$ (c) $2x + \frac{5}{x}$
 6. (a) $\frac{1}{x^2}$ (b) $\frac{-1}{4x^2}$ (c) $\frac{x^4}{4} + \frac{1}{2x^2}$
 7. (a) $\sqrt{x^3}$ (b) \sqrt{x} (c) $\frac{2}{3}\sqrt{x^3} + 2\sqrt{x}$
 8. (a) $x^{4/3}$ (b) $\frac{1}{2}x^{2/3}$ (c) $\frac{3}{4}x^{4/3} + \frac{3}{2}x^{2/3}$
 9. (a) $x^{2/3}$ (b) $x^{1/3}$ (c) $x^{-1/3}$
 10. (a) $x^{-1/2}$ (b) $x^{-3/2}$ (c) $x^{-3/2}$
 11. (a) $\cos(\pi x)$ (b) $-3 \cos x$ (c) $\frac{-\cos(\pi x)}{\pi} + \cos(3x)$
 12. (a) $\sin(\pi x)$ (b) $\sin\left(\frac{\pi x}{2}\right)$ (c) $\left(\frac{2}{\pi}\right)\sin\left(\frac{\pi x}{2}\right) + \pi \sin x$
 13. (a) $\tan x$ (b) $2 \tan\left(\frac{x}{3}\right)$ (c) $-\frac{2}{3} \tan\left(\frac{3x}{2}\right)$
 14. (a) $-\cot x$ (b) $\cot\left(\frac{3x}{2}\right)$ (c) $x + 4 \cot(2x)$
 15. (a) $-\csc x$ (b) $\frac{1}{5} \csc(5x)$ (c) $2 \csc\left(\frac{\pi x}{2}\right)$
 16. (a) $\sec x$ (b) $\frac{4}{3} \sec(3x)$ (c) $\frac{2}{\pi} \sec\left(\frac{\pi x}{2}\right)$
17. $\int (x + 1) dx = \frac{x^2}{2} + x + C$ 18. $\int (5 - 6x) dx = 5x - 3x^2 + C$
19. $\int (3t^2 + \frac{1}{2}) dt = t^3 + \frac{t^2}{4} + C$ 20. $\int \left(\frac{t^2}{2} + 4t^3\right) dt = \frac{t^3}{6} + t^4 + C$

$$21. \int (2x^3 - 5x + 7) dx = \frac{1}{2}x^4 - \frac{5}{2}x^2 + 7x + C \qquad 22. \int (1 - x^2 - 3x^5) dx = x - \frac{1}{3}x^3 - \frac{1}{2}x^6 + C$$

$$23. \int \left(\frac{1}{x^2} - x^2 - \frac{1}{3}\right) dx = \int (x^{-2} - x^2 - \frac{1}{3}) dx = \frac{x^{-1}}{-1} - \frac{x^3}{3} - \frac{1}{3}x + C = -\frac{1}{x} - \frac{x^3}{3} - \frac{x}{3} + C$$

$$24. \int \left(\frac{1}{5} - \frac{2}{x^3} + 2x\right) dx = \int \left(\frac{1}{5} - 2x^{-3} + 2x\right) dx = \frac{1}{5}x - \left(\frac{2x^{-2}}{-2}\right) + \frac{2x^2}{2} + C = \frac{5}{x} + \frac{1}{x^2} + x^2 + C$$

$$25. \int x^{-1/3} dx = \frac{x^{2/3}}{\frac{2}{3}} + C = \frac{3}{2}x^{2/3} + C \qquad 26. \int x^{-5/4} dx = \frac{x^{-1/4}}{-\frac{1}{4}} + C = \frac{-4}{\sqrt[4]{x}} + C$$

$$27. \int (\sqrt{x} + {}^3\sqrt{x}) dx = \int (x^{1/2} + x^{1/3}) dx = \frac{x^{3/2}}{\frac{3}{2}} + \frac{x^{4/3}}{\frac{4}{3}} + C = \frac{2}{3}x^{3/2} + \frac{3}{4}x^{4/3} + C$$

$$28. \int \left(\frac{\sqrt{x}}{2} + \frac{2}{\sqrt{x}}\right) dx = \int \left(\frac{1}{2}x^{1/2} + 2x^{-1/2}\right) dx = \frac{1}{2}\left(\frac{x^{3/2}}{\frac{3}{2}}\right) + 2\left(\frac{x^{1/2}}{\frac{1}{2}}\right) + C = \frac{1}{3}x^{3/2} + 4x^{1/2} + C$$

$$29. \int \left(8y - \frac{2}{y^{1/4}}\right) dy = \int (8y - 2y^{-1/4}) dy = \frac{8y^2}{2} - 2\left(\frac{y^{3/4}}{\frac{3}{4}}\right) + C = 4y^2 - \frac{8}{3}y^{3/4} + C$$

$$30. \int \left(\frac{1}{7} - \frac{1}{y^{5/4}}\right) dy = \int \left(\frac{1}{7} - y^{-5/4}\right) dy = \frac{1}{7}y - \left(\frac{y^{-1/4}}{-\frac{1}{4}}\right) + C = \frac{y}{7} + \frac{4}{y^{1/4}} + C$$

$$31. \int 2x(1 - x^{-3}) dx = \int (2x - 2x^{-2}) dx = \frac{2x^2}{2} - 2\left(\frac{x^{-1}}{-1}\right) + C = x^2 + \frac{2}{x} + C$$

$$32. \int x^{-3}(x+1) dx = \int (x^{-2} + x^{-3}) dx = \frac{x^{-1}}{-1} + \left(\frac{x^{-2}}{-2}\right) + C = -\frac{1}{x} - \frac{1}{2x^2} + C$$

$$33. \int \frac{t\sqrt{t+\sqrt{t}}}{t^2} dt = \int \left(\frac{t^{3/2}}{t^2} + \frac{t^{1/2}}{t^2}\right) dt = \int (t^{-1/2} + t^{-3/2}) dt = \frac{t^{1/2}}{\frac{1}{2}} + \left(\frac{t^{-1/2}}{-\frac{1}{2}}\right) + C = 2\sqrt{t} - \frac{2}{\sqrt{t}} + C$$

$$34. \int \frac{4+\sqrt{t}}{t^3} dt = \int \left(\frac{4}{t^3} + \frac{t^{1/2}}{t^3}\right) dt = \int (4t^{-3} + t^{-5/2}) dt = 4\left(\frac{t^{-2}}{-2}\right) + \left(\frac{t^{-3/2}}{-\frac{3}{2}}\right) + C = -\frac{2}{t^2} - \frac{2}{3t^{3/2}} + C$$

$$35. \int -2 \cos t dt = -2 \sin t + C \qquad 36. \int -5 \sin t dt = 5 \cos t + C$$

$$37. \int 7 \sin \frac{\theta}{3} d\theta = -21 \cos \frac{\theta}{3} + C \qquad 38. \int 3 \cos 5\theta d\theta = \frac{3}{5} \sin 5\theta + C$$

$$39. \int -3 \csc^2 x dx = 3 \cot x + C \qquad 40. \int -\frac{\sec^2 x}{3} dx = -\frac{\tan x}{3} + C$$

$$41. \int \frac{\csc \theta \cot \theta}{2} d\theta = -\frac{1}{2} \csc \theta + C \qquad 42. \int \frac{2}{5} \sec \theta \tan \theta d\theta = \frac{2}{5} \sec \theta + C$$

$$43. \int (4 \sec x \tan x - 2 \sec^2 x) dx = 4 \sec x - 2 \tan x + C$$

$$44. \int \frac{1}{2} (\csc^2 x - \csc x \cot x) dx = -\frac{1}{2} \cot x + \frac{1}{2} \csc x + C$$

$$45. \int (\sin 2x - \csc^2 x) dx = -\frac{1}{2} \cos 2x + \cot x + C \qquad 46. \int (2 \cos 2x - 3 \sin 3x) dx = \sin 2x + \cos 3x + C$$

$$47. \int \frac{1+\cos 4t}{2} dt = \int \left(\frac{1}{2} + \frac{1}{2} \cos 4t\right) dt = \frac{1}{2}t + \frac{1}{2}\left(\frac{\sin 4t}{4}\right) + C = \frac{t}{2} + \frac{\sin 4t}{8} + C$$

$$48. \int \frac{1-\cos 6t}{2} dt = \int \left(\frac{1}{2} - \frac{1}{2} \cos 6t\right) dt = \frac{1}{2}t - \frac{1}{2}\left(\frac{\sin 6t}{6}\right) + C = \frac{t}{2} - \frac{\sin 6t}{12} + C$$

270 Chapter 4 Applications of Derivatives

49. $\int (1 + \tan^2 \theta) d\theta = \int \sec^2 \theta d\theta = \tan \theta + C$

50. $\int (2 + \tan^2 \theta) d\theta = \int (1 + 1 + \tan^2 \theta) d\theta = \int (1 + \sec^2 \theta) d\theta = \theta + \tan \theta + C$

51. $\int \cot^2 x dx = \int (\csc^2 x - 1) dx = -\cot x - x + C$

52. $\int (1 - \cot^2 x) dx = \int (1 - (\csc^2 x - 1)) dx = \int (2 - \csc^2 x) dx = 2x + \cot x + C$

53. $\int \cos \theta (\tan \theta + \sec \theta) d\theta = \int (\sin \theta + 1) d\theta = -\cos \theta + \theta + C$

54. $\int \frac{\csc \theta}{\csc \theta - \sin \theta} d\theta = \int \left(\frac{\csc \theta}{\csc \theta - \sin \theta} \right) \left(\frac{\sin \theta}{\sin \theta} \right) d\theta = \int \frac{1}{1 - \sin^2 \theta} d\theta = \int \frac{1}{\cos^2 \theta} d\theta = \int \sec^2 \theta d\theta = \tan \theta + C$

55. $\frac{d}{dx} \left(\frac{(7x-2)^4}{28} + C \right) = \frac{4(7x-2)^3(7)}{28} = (7x-2)^3$

56. $\frac{d}{dx} \left(-\frac{(3x+5)^{-1}}{3} + C \right) = -\left(-\frac{(3x+5)^{-2}(3)}{3} \right) = (3x+5)^{-2}$

57. $\frac{d}{dx} \left(\frac{1}{5} \tan(5x-1) + C \right) = \frac{1}{5} (\sec^2(5x-1))(5) = \sec^2(5x-1)$

58. $\frac{d}{dx} \left(-3 \cot \left(\frac{x-1}{3} \right) + C \right) = -3 \left(-\csc^2 \left(\frac{x-1}{3} \right) \right) \left(\frac{1}{3} \right) = \csc^2 \left(\frac{x-1}{3} \right)$

59. $\frac{d}{dx} \left(\frac{-1}{x+1} + C \right) = (-1)(-1)(x+1)^{-2} = \frac{1}{(x+1)^2}$ 60. $\frac{d}{dx} \left(\frac{-x}{x+1} + C \right) = \frac{(x+1)(1) - x(1)}{(x+1)^2} = \frac{1}{(x+1)^2}$

61. (a) Wrong: $\frac{d}{dx} \left(\frac{x^2}{2} \sin x + C \right) = \frac{2x}{2} \sin x + \frac{x^2}{2} \cos x = x \sin x + \frac{x^2}{2} \cos x \neq x \sin x$

(b) Wrong: $\frac{d}{dx} (-x \cos x + C) = -\cos x + x \sin x \neq x \sin x$

(c) Right: $\frac{d}{dx} (-x \cos x + \sin x + C) = -\cos x + x \sin x + \cos x = x \sin x$

62. (a) Wrong: $\frac{d}{d\theta} \left(\frac{\sec^3 \theta}{3} + C \right) = \frac{3 \sec^2 \theta}{3} (\sec \theta \tan \theta) = \sec^3 \theta \tan \theta \neq \tan \theta \sec^2 \theta$

(b) Right: $\frac{d}{d\theta} \left(\frac{1}{2} \tan^2 \theta + C \right) = \frac{1}{2} (2 \tan \theta) \sec^2 \theta = \tan \theta \sec^2 \theta$

(c) Right: $\frac{d}{d\theta} \left(\frac{1}{2} \sec^2 \theta + C \right) = \frac{1}{2} (2 \sec \theta) \sec \theta \tan \theta = \tan \theta \sec^2 \theta$

63. (a) Wrong: $\frac{d}{dx} \left(\frac{(2x+1)^3}{3} + C \right) = \frac{3(2x+1)^2(2)}{3} = 2(2x+1)^2 \neq (2x+1)^2$

(b) Wrong: $\frac{d}{dx} ((2x+1)^3 + C) = 3(2x+1)^2(2) = 6(2x+1)^2 \neq 3(2x+1)^2$

(c) Right: $\frac{d}{dx} ((2x+1)^3 + C) = 6(2x+1)^2$

64. (a) Wrong: $\frac{d}{dx} (x^2 + x + C)^{1/2} = \frac{1}{2} (x^2 + x + C)^{-1/2} (2x + 1) = \frac{2x+1}{2\sqrt{x^2+x+C}} \neq \sqrt{2x+1}$

(b) Wrong: $\frac{d}{dx} \left((x^2 + x)^{1/2} + C \right) = \frac{1}{2} (x^2 + x)^{-1/2} (2x + 1) = \frac{2x+1}{2\sqrt{x^2+x}} \neq \sqrt{2x+1}$

(c) Right: $\frac{d}{dx} \left(\frac{1}{3} \left(\sqrt{2x+1} \right)^3 + C \right) = \frac{d}{dx} \left(\frac{1}{3} (2x+1)^{3/2} + C \right) = \frac{3}{6} (2x+1)^{1/2} (2) = \sqrt{2x+1}$

65. Graph (b), because $\frac{dy}{dx} = 2x \Rightarrow y = x^2 + C$. Then $y(1) = 4 \Rightarrow C = 3$.

66. Graph (b), because $\frac{dy}{dx} = -x \Rightarrow y = -\frac{1}{2}x^2 + C$. Then $y(-1) = 1 \Rightarrow C = \frac{3}{2}$.

67. $\frac{dy}{dx} = 2x - 7 \Rightarrow y = x^2 - 7x + C$; at $x = 2$ and $y = 0$ we have $0 = 2^2 - 7(2) + C \Rightarrow C = 10 \Rightarrow y = x^2 - 7x + 10$
68. $\frac{dy}{dx} = 10 - x \Rightarrow y = 10x - \frac{x^2}{2} + C$; at $x = 0$ and $y = -1$ we have $-1 = 10(0) - \frac{0^2}{2} + C \Rightarrow C = -1$
 $\Rightarrow y = 10x - \frac{x^2}{2} - 1$
69. $\frac{dy}{dx} = \frac{1}{x^2} + x = x^{-2} + x \Rightarrow y = -x^{-1} + \frac{x^2}{2} + C$; at $x = 2$ and $y = 1$ we have $1 = -2^{-1} + \frac{2^2}{2} + C \Rightarrow C = -\frac{1}{2}$
 $\Rightarrow y = -x^{-1} + \frac{x^2}{2} - \frac{1}{2}$ or $y = -\frac{1}{x} + \frac{x^2}{2} - \frac{1}{2}$
70. $\frac{dy}{dx} = 9x^2 - 4x + 5 \Rightarrow y = 3x^3 - 2x^2 + 5x + C$; at $x = -1$ and $y = 0$ we have $0 = 3(-1)^3 - 2(-1)^2 + 5(-1) + C$
 $\Rightarrow C = 10 \Rightarrow y = 3x^3 - 2x^2 + 5x + 10$
71. $\frac{dy}{dx} = 3x^{-2/3} \Rightarrow y = \frac{3x^{1/3}}{\frac{1}{3}} + C = 9x^{1/3} + C$; at $x = -1$ and $y = -5$ we have $-5 = 9(-1)^{1/3} + C \Rightarrow C = -4$
 $\Rightarrow y = 9x^{1/3} - 4$
72. $\frac{dy}{dx} = \frac{1}{2\sqrt{x}} = \frac{1}{2}x^{-1/2} \Rightarrow y = x^{1/2} + C$; at $x = 4$ and $y = 0$ we have $0 = 4^{1/2} + C \Rightarrow C = -2 \Rightarrow y = x^{1/2} - 2$
73. $\frac{ds}{dt} = 1 + \cos t \Rightarrow s = t + \sin t + C$; at $t = 0$ and $s = 4$ we have $4 = 0 + \sin 0 + C \Rightarrow C = 4 \Rightarrow s = t + \sin t + 4$
74. $\frac{ds}{dt} = \cos t + \sin t \Rightarrow s = \sin t - \cos t + C$; at $t = \pi$ and $s = 1$ we have $1 = \sin \pi - \cos \pi + C \Rightarrow C = 0$
 $\Rightarrow s = \sin t - \cos t$
75. $\frac{dr}{d\theta} = -\pi \sin \pi\theta \Rightarrow r = \cos(\pi\theta) + C$; at $r = 0$ and $\theta = 0$ we have $0 = \cos(\pi \cdot 0) + C \Rightarrow C = -1 \Rightarrow r = \cos(\pi\theta) - 1$
76. $\frac{dr}{d\theta} = \cos \pi\theta \Rightarrow r = \frac{1}{\pi} \sin(\pi\theta) + C$; at $r = 1$ and $\theta = 0$ we have $1 = \frac{1}{\pi} \sin(\pi \cdot 0) + C \Rightarrow C = 1 \Rightarrow r = \frac{1}{\pi} \sin(\pi\theta) + 1$
77. $\frac{dv}{dt} = \frac{1}{2} \sec t \tan t \Rightarrow v = \frac{1}{2} \sec t + C$; at $v = 1$ and $t = 0$ we have $1 = \frac{1}{2} \sec(0) + C \Rightarrow C = \frac{1}{2} \Rightarrow v = \frac{1}{2} \sec t + \frac{1}{2}$
78. $\frac{dv}{dt} = 8t + \csc^2 t \Rightarrow v = 4t^2 - \cot t + C$; at $v = -7$ and $t = \frac{\pi}{2}$ we have $-7 = 4\left(\frac{\pi}{2}\right)^2 - \cot\left(\frac{\pi}{2}\right) + C \Rightarrow C = -7 - \pi^2$
 $\Rightarrow v = 4t^2 - \cot t - 7 - \pi^2$
79. $\frac{d^2y}{dx^2} = 2 - 6x \Rightarrow \frac{dy}{dx} = 2x - 3x^2 + C_1$; at $\frac{dy}{dx} = 4$ and $x = 0$ we have $4 = 2(0) - 3(0)^2 + C_1 \Rightarrow C_1 = 4$
 $\Rightarrow \frac{dy}{dx} = 2x - 3x^2 + 4 \Rightarrow y = x^2 - x^3 + 4x + C_2$; at $y = 1$ and $x = 0$ we have $1 = 0^2 - 0^3 + 4(0) + C_2 \Rightarrow C_2 = 1$
 $\Rightarrow y = x^2 - x^3 + 4x + 1$
80. $\frac{d^2y}{dx^2} = 0 \Rightarrow \frac{dy}{dx} = C_1$; at $\frac{dy}{dx} = 2$ and $x = 0$ we have $C_1 = 2 \Rightarrow \frac{dy}{dx} = 2 \Rightarrow y = 2x + C_2$; at $y = 0$ and $x = 0$ we have $0 = 2(0) + C_2 \Rightarrow C_2 = 0 \Rightarrow y = 2x$
81. $\frac{d^2r}{dt^2} = \frac{2}{t^3} = 2t^{-3} \Rightarrow \frac{dr}{dt} = -t^{-2} + C_1$; at $\frac{dr}{dt} = 1$ and $t = 1$ we have $1 = -(1)^{-2} + C_1 \Rightarrow C_1 = 2 \Rightarrow \frac{dr}{dt} = -t^{-2} + 2$
 $\Rightarrow r = t^{-1} + 2t + C_2$; at $r = 1$ and $t = 1$ we have $1 = 1^{-1} + 2(1) + C_2 \Rightarrow C_2 = -2 \Rightarrow r = t^{-1} + 2t - 2$ or
 $r = \frac{1}{t} + 2t - 2$
82. $\frac{d^2s}{dt^2} = \frac{3t}{8} \Rightarrow \frac{ds}{dt} = \frac{3t^2}{16} + C_1$; at $\frac{ds}{dt} = 3$ and $t = 4$ we have $3 = \frac{3(4)^2}{16} + C_1 \Rightarrow C_1 = 0 \Rightarrow \frac{ds}{dt} = \frac{3t^2}{16} \Rightarrow s = \frac{t^3}{16} + C_2$; at
 $s = 4$ and $t = 4$ we have $4 = \frac{4^3}{16} + C_2 \Rightarrow C_2 = 0 \Rightarrow s = \frac{t^3}{16}$

83. $\frac{d^3y}{dx^3} = 6 \Rightarrow \frac{d^2y}{dx^2} = 6x + C_1$; at $\frac{d^2y}{dx^2} = -8$ and $x = 0$ we have $-8 = 6(0) + C_1 \Rightarrow C_1 = -8 \Rightarrow \frac{d^2y}{dx^2} = 6x - 8$
 $\Rightarrow \frac{dy}{dx} = 3x^2 - 8x + C_2$; at $\frac{dy}{dx} = 0$ and $x = 0$ we have $0 = 3(0)^2 - 8(0) + C_2 \Rightarrow C_2 = 0 \Rightarrow \frac{dy}{dx} = 3x^2 - 8x$
 $\Rightarrow y = x^3 - 4x^2 + C_3$; at $y = 5$ and $x = 0$ we have $5 = 0^3 - 4(0)^2 + C_3 \Rightarrow C_3 = 5 \Rightarrow y = x^3 - 4x^2 + 5$
84. $\frac{d^3\theta}{dt^3} = 0 \Rightarrow \frac{d^2\theta}{dt^2} = C_1$; at $\frac{d^2\theta}{dt^2} = -2$ and $t = 0$ we have $\frac{d^2\theta}{dt^2} = -2 \Rightarrow \frac{d\theta}{dt} = -2t + C_2$; at $\frac{d\theta}{dt} = -\frac{1}{2}$ and $t = 0$ we have $-\frac{1}{2} = -2(0) + C_2 \Rightarrow C_2 = -\frac{1}{2} \Rightarrow \frac{d\theta}{dt} = -2t - \frac{1}{2} \Rightarrow \theta = -t^2 - \frac{1}{2}t + C_3$; at $\theta = \sqrt{2}$ and $t = 0$ we have $\sqrt{2} = -0^2 - \frac{1}{2}(0) + C_3 \Rightarrow C_3 = \sqrt{2} \Rightarrow \theta = -t^2 - \frac{1}{2}t + \sqrt{2}$
85. $y^{(4)} = -\sin t + \cos t \Rightarrow y''' = \cos t + \sin t + C_1$; at $y''' = 7$ and $t = 0$ we have $7 = \cos(0) + \sin(0) + C_1 \Rightarrow C_1 = 6 \Rightarrow y''' = \cos t + \sin t + 6 \Rightarrow y'' = \sin t - \cos t + 6t + C_2$; at $y'' = -1$ and $t = 0$ we have $-1 = \sin(0) - \cos(0) + 6(0) + C_2 \Rightarrow C_2 = 0 \Rightarrow y'' = \sin t - \cos t + 6t \Rightarrow y' = -\cos t - \sin t + 3t^2 + C_3$; at $y' = -1$ and $t = 0$ we have $-1 = -\cos(0) - \sin(0) + 3(0)^2 + C_3 \Rightarrow C_3 = 0 \Rightarrow y' = -\cos t - \sin t + 3t^2 \Rightarrow y = -\sin t + \cos t + t^3 + C_4$; at $y = 0$ and $t = 0$ we have $0 = -\sin(0) + \cos(0) + 0^3 + C_4 \Rightarrow C_4 = -1 \Rightarrow y = -\sin t + \cos t + t^3 - 1$
86. $y^{(4)} = -\cos x + 8 \sin(2x) \Rightarrow y''' = -\sin x - 4 \cos(2x) + C_1$; at $y''' = 0$ and $x = 0$ we have $0 = -\sin(0) - 4 \cos(2(0)) + C_1 \Rightarrow C_1 = 4 \Rightarrow y''' = -\sin x - 4 \cos(2x) + 4 \Rightarrow y'' = \cos x - 2 \sin(2x) + 4x + C_2$; at $y'' = 1$ and $x = 0$ we have $1 = \cos(0) - 2 \sin(2(0)) + 4(0) + C_2 \Rightarrow C_2 = 0 \Rightarrow y'' = \cos x - 2 \sin(2x) + 4x \Rightarrow y' = \sin x + \cos(2x) + 2x^2 + C_3$; at $y' = 1$ and $x = 0$ we have $1 = \sin(0) + \cos(2(0)) + 2(0)^2 + C_3 \Rightarrow C_3 = 0 \Rightarrow y' = \sin x + \cos(2x) + 2x^2 \Rightarrow y = -\cos x + \frac{1}{2} \sin(2x) + \frac{2}{3}x^3 + C_4$; at $y = 3$ and $x = 0$ we have $3 = -\cos(0) + \frac{1}{2} \sin(2(0)) + \frac{2}{3}(0)^3 + C_4 \Rightarrow C_4 = 4 \Rightarrow y = -\cos x + \frac{1}{2} \sin(2x) + \frac{2}{3}x^3 + 4$
87. $m = y' = 3\sqrt{x} = 3x^{1/2} \Rightarrow y = 2x^{3/2} + C$; at $(9, 4)$ we have $4 = 2(9)^{3/2} + C \Rightarrow C = -50 \Rightarrow y = 2x^{3/2} - 50$
88. (a) $\frac{d^2y}{dx^2} = 6x \Rightarrow \frac{dy}{dx} = 3x^2 + C_1$; at $y' = 0$ and $x = 0$ we have $0 = 3(0)^2 + C_1 \Rightarrow C_1 = 0 \Rightarrow \frac{dy}{dx} = 3x^2 \Rightarrow y = x^3 + C_2$; at $y = 1$ and $x = 0$ we have $C_2 = 1 \Rightarrow y = x^3 + 1$
 (b) One, because any other possible function would differ from $x^3 + 1$ by a constant that must be zero because of the initial conditions
89. $\frac{dy}{dx} = 1 - \frac{4}{3}x^{1/3} \Rightarrow y = \int \left(1 - \frac{4}{3}x^{1/3}\right) dx = x - x^{4/3} + C$; at $(1, 0.5)$ on the curve we have $0.5 = 1 - 1^{4/3} + C \Rightarrow C = 0.5 \Rightarrow y = x - x^{4/3} + \frac{1}{2}$
90. $\frac{dy}{dx} = x - 1 \Rightarrow y = \int (x - 1) dx = \frac{x^2}{2} - x + C$; at $(-1, 1)$ on the curve we have $1 = \frac{(-1)^2}{2} - (-1) + C \Rightarrow C = -\frac{1}{2} \Rightarrow y = \frac{x^2}{2} - x - \frac{1}{2}$
91. $\frac{dy}{dx} = \sin x - \cos x \Rightarrow y = \int (\sin x - \cos x) dx = -\cos x - \sin x + C$; at $(-\pi, -1)$ on the curve we have $-1 = -\cos(-\pi) - \sin(-\pi) + C \Rightarrow C = -2 \Rightarrow y = -\cos x - \sin x - 2$
92. $\frac{dy}{dx} = \frac{1}{2\sqrt{x}} + \pi \sin \pi x = \frac{1}{2}x^{-1/2} + \pi \sin \pi x \Rightarrow y = \int \left(\frac{1}{2}x^{-1/2} + \pi \sin \pi x\right) dx = x^{1/2} - \cos \pi x + C$; at $(1, 2)$ on the curve we have $2 = 1^{1/2} - \cos \pi(1) + C \Rightarrow C = 0 \Rightarrow y = \sqrt{x} - \cos \pi x$
93. (a) $\frac{ds}{dt} = 9.8t - 3 \Rightarrow s = 4.9t^2 - 3t + C$; (i) at $s = 5$ and $t = 0$ we have $C = 5 \Rightarrow s = 4.9t^2 - 3t + 5$; displacement = $s(3) - s(1) = ((4.9)(9) - 9 + 5) - (4.9 - 3 + 5) = 33.2$ units; (ii) at $s = -2$ and $t = 0$ we have $C = -2 \Rightarrow s = 4.9t^2 - 3t - 2$; displacement = $s(3) - s(1) = ((4.9)(9) - 9 - 2) - (4.9 - 3 - 2) = 33.2$ units; (iii) at $s = s_0$ and $t = 0$ we have $C = s_0 \Rightarrow s = 4.9t^2 - 3t + s_0$; displacement = $s(3) - s(1) = ((4.9)(9) - 9 + s_0) - (4.9 - 3 + s_0) = 33.2$ units

- (b) True. Given an antiderivative $f(t)$ of the velocity function, we know that the body's position function is $s = f(t) + C$ for some constant C . Therefore, the displacement from $t = a$ to $t = b$ is $(f(b) + C) - (f(a) + C) = f(b) - f(a)$. Thus we can find the displacement from any antiderivative f as the numerical difference $f(b) - f(a)$ without knowing the exact values of C and s .

94. $a(t) = v'(t) = 20 \Rightarrow v(t) = 20t + C$; at $(0, 0)$ we have $C = 0 \Rightarrow v(t) = 20t$. When $t = 60$, then $v(60) = 20(60) = 1200$ m/sec.

95. Step 1: $\frac{d^2s}{dt^2} = -k \Rightarrow \frac{ds}{dt} = -kt + C_1$; at $\frac{ds}{dt} = 88$ and $t = 0$ we have $C_1 = 88 \Rightarrow \frac{ds}{dt} = -kt + 88 \Rightarrow s = -k\left(\frac{t^2}{2}\right) + 88t + C_2$; at $s = 0$ and $t = 0$ we have $C_2 = 0 \Rightarrow s = -\frac{kt^2}{2} + 88t$

Step 2: $\frac{ds}{dt} = 0 \Rightarrow 0 = -kt + 88 \Rightarrow t = \frac{88}{k}$

Step 3: $242 = -\frac{k\left(\frac{88}{k}\right)^2}{2} + 88\left(\frac{88}{k}\right) \Rightarrow 242 = -\frac{(88)^2}{2k} + \frac{(88)^2}{k} \Rightarrow 242 = \frac{(88)^2}{2k} \Rightarrow k = 16$

96. $\frac{d^2s}{dt^2} = -k \Rightarrow \frac{ds}{dt} = \int -k dt = -kt + C$; at $\frac{ds}{dt} = 44$ when $t = 0$ we have $44 = -k(0) + C \Rightarrow C = 44 \Rightarrow \frac{ds}{dt} = -kt + 44 \Rightarrow s = -\frac{kt^2}{2} + 44t + C_1$; at $s = 0$ when $t = 0$ we have $0 = -\frac{k(0)^2}{2} + 44(0) + C_1 \Rightarrow C_1 = 0 \Rightarrow s = -\frac{kt^2}{2} + 44t$. Then $\frac{ds}{dt} = 0 \Rightarrow -kt + 44 = 0 \Rightarrow t = \frac{44}{k}$ and $s\left(\frac{44}{k}\right) = -\frac{k\left(\frac{44}{k}\right)^2}{2} + 44\left(\frac{44}{k}\right) = 45 \Rightarrow -\frac{968}{k} + \frac{1936}{k} = 45 \Rightarrow \frac{968}{k} = 45 \Rightarrow k = \frac{968}{45} \approx 21.5 \frac{\text{ft}}{\text{sec}^2}$.

97. (a) $v = \int a dt = \int (15t^{1/2} - 3t^{-1/2}) dt = 10t^{3/2} - 6t^{1/2} + C$; $\frac{ds}{dt}(1) = 4 \Rightarrow 4 = 10(1)^{3/2} - 6(1)^{1/2} + C \Rightarrow C = 0 \Rightarrow v = 10t^{3/2} - 6t^{1/2}$

(b) $s = \int v dt = \int (10t^{3/2} - 6t^{1/2}) dt = 4t^{5/2} - 4t^{3/2} + C$; $s(1) = 0 \Rightarrow 0 = 4(1)^{5/2} - 4(1)^{3/2} + C \Rightarrow C = 0 \Rightarrow s = 4t^{5/2} - 4t^{3/2}$

98. $\frac{d^2s}{dt^2} = -5.2 \Rightarrow \frac{ds}{dt} = -5.2t + C_1$; at $\frac{ds}{dt} = 0$ and $t = 0$ we have $C_1 = 0 \Rightarrow \frac{ds}{dt} = -5.2t \Rightarrow s = -2.6t^2 + C_2$; at $s = 4$ and $t = 0$ we have $C_2 = 4 \Rightarrow s = -2.6t^2 + 4$. Then $s = 0 \Rightarrow 0 = -2.6t^2 + 4 \Rightarrow t = \sqrt{\frac{4}{2.6}} \approx 1.24$ sec, since $t > 0$

99. $\frac{d^2s}{dt^2} = a \Rightarrow \frac{ds}{dt} = \int a dt = at + C$; $\frac{ds}{dt} = v_0$ when $t = 0 \Rightarrow C = v_0 \Rightarrow \frac{ds}{dt} = at + v_0 \Rightarrow s = \frac{at^2}{2} + v_0t + C_1$; $s = s_0$ when $t = 0 \Rightarrow s_0 = \frac{a(0)^2}{2} + v_0(0) + C_1 \Rightarrow C_1 = s_0 \Rightarrow s = \frac{at^2}{2} + v_0t + s_0$

100. The appropriate initial value problem is: Differential Equation: $\frac{d^2s}{dt^2} = -g$ with Initial Conditions: $\frac{ds}{dt} = v_0$ and $s = s_0$ when $t = 0$. Thus, $\frac{ds}{dt} = \int -g dt = -gt + C_1$; $\frac{ds}{dt}(0) = v_0 \Rightarrow v_0 = (-g)(0) + C_1 \Rightarrow C_1 = v_0 \Rightarrow \frac{ds}{dt} = -gt + v_0$. Thus $s = \int (-gt + v_0) dt = -\frac{1}{2}gt^2 + v_0t + C_2$; $s(0) = s_0 = -\frac{1}{2}(g)(0)^2 + v_0(0) + C_2 \Rightarrow C_2 = s_0$. Thus $s = -\frac{1}{2}gt^2 + v_0t + s_0$.

101. (a) $\int f(x) dx = 1 - \sqrt{x} + C_1 = -\sqrt{x} + C$ (b) $\int g(x) dx = x + 2 + C_1 = x + C$
 (c) $\int -f(x) dx = -(1 - \sqrt{x}) + C_1 = \sqrt{x} + C$ (d) $\int -g(x) dx = -(x + 2) + C_1 = -x + C$
 (e) $\int [f(x) + g(x)] dx = (1 - \sqrt{x}) + (x + 2) + C_1 = x - \sqrt{x} + C$
 (f) $\int [f(x) - g(x)] dx = (1 - \sqrt{x}) - (x + 2) + C_1 = -x - \sqrt{x} + C$

102. Yes. If $F(x)$ and $G(x)$ both solve the initial value problem on an interval I then they both have the same first derivative. Therefore, by Corollary 2 of the Mean Value Theorem there is a constant C such that $F(x) = G(x) + C$ for all x . In particular, $F(x_0) = G(x_0) + C$, so $C = F(x_0) - G(x_0) = 0$. Hence $F(x) = G(x)$ for all x .

103 – 106 Example CAS commands:

Maple:

```
with(student):
f := x -> cos(x)^2 + sin(x);
ic := [x=Pi,y=1];
F := unapply( int( f(x), x ) + C, x );
eq := eval( y=F(x), ic );
solnC := solve( eq, {C} );
Y := unapply( eval( F(x), solnC ), x );
DEplot( diff(y(x),x) = f(x), y(x), x=0..2*Pi, [[y(Pi)=1]],
        color=black, linecolor=black, stepsize=0.05, title="Section 4.8 #103" );
```

Mathematica: (functions and values may vary)

The following commands use the definite integral and the Fundamental Theorem of calculus to construct the solution of the initial value problems for exercises 103 - 105.

```
Clear[x, y, yprime]
yprime[x_] = Cos[x]^2 + Sin[x];
initxvalue = Pi; inityvalue = 1;
y[x_] = Integrate[yprime[t], {t, initxvalue, x}] + inityvalue
```

If the solution satisfies the differential equation and initial condition, the following yield True

```
yprime[x]==D[y[x], x] //Simplify
y[initxvalue]==inityvalue
```

Since exercise 106 is a second order differential equation, two integrations will be required.

```
Clear[x, y, yprime]
y2prime[x_] = 3 Exp[x/2] + 1;
initxval = 0; inityval = 4; inityprimeval = -1;
yprime[x_] = Integrate[y2prime[t], {t, initxval, x}] + inityprimeval
y[x_] = Integrate[yprime[t], {t, initxval, x}] + inityval
```

Verify that $y[x]$ solves the differential equation and initial condition and plot the solution (red) and its derivative (blue).

```
y2prime[x]==D[y[x], {x, 2}]//Simplify
y[initxval]==inityval
yprime[initxval]==inityprimeval
Plot[{y[x], yprime[x]}, {x, initxval - 3, initxval + 3}, PlotStyle -> {RGBColor[1,0,0], RGBColor[0,0,1]}]
```

CHAPTER 4 PRACTICE EXERCISES

- No, since $f(x) = x^3 + 2x + \tan x \Rightarrow f'(x) = 3x^2 + 2 + \sec^2 x > 0 \Rightarrow f(x)$ is always increasing on its domain
- No, since $g(x) = \csc x + 2 \cot x \Rightarrow g'(x) = -\csc x \cot x - 2 \csc^2 x = -\frac{\cos x}{\sin^2 x} - \frac{2}{\sin^2 x} = -\frac{1}{\sin^2 x} (\cos x + 2) < 0 \Rightarrow g(x)$ is always decreasing on its domain
- No absolute minimum because $\lim_{x \rightarrow \infty} (7+x)(11-3x)^{1/3} = -\infty$. Next $f'(x) = (11-3x)^{1/3} - (7+x)(11-3x)^{-2/3} = \frac{(11-3x)-(7+x)}{(11-3x)^{2/3}} = \frac{4(1-x)}{(11-3x)^{2/3}} \Rightarrow x = 1$ and $x = \frac{11}{3}$ are critical points. Since $f' > 0$ if $x < 1$ and $f' < 0$ if $x > 1$, $f(1) = 16$ is the absolute maximum.
- $f(x) = \frac{ax+b}{x^2-1} \Rightarrow f'(x) = \frac{a(x^2-1)-2x(ax+b)}{(x^2-1)^2} = \frac{-(ax^2+2bx+a)}{(x^2-1)^2}$; $f'(3) = 0 \Rightarrow -\frac{1}{64}(9a+6b+a) = 0 \Rightarrow 5a+3b = 0$. We require also that $f(3) = 1$. Thus $1 = \frac{3a+b}{8} \Rightarrow 3a+b = 8$. Solving both equations yields $a = 6$ and $b = -10$. Now, $f'(x) = \frac{-2(3x-1)(x-3)}{(x^2-1)^2}$ so that $f' = \begin{array}{cccc} - & - & + & + \\ -1 & 1/3 & 1 & 3 \end{array}$. Thus f' changes sign at $x = 3$ from positive to negative so there is a local maximum at $x = 3$ which has a value $f(3) = 1$.

5. Yes, because at each point of $[0, 1)$ except $x = 0$, the function's value is a local minimum value as well as a local maximum value. At $x = 0$ the function's value, 0, is not a local minimum value because each open interval around $x = 0$ on the x -axis contains points to the left of 0 where f equals -1 .
6. (a) The first derivative of the function $f(x) = x^3$ is zero at $x = 0$ even though f has no local extreme value at $x = 0$.
 (b) Theorem 2 says only that if f is differentiable and f has a local extreme at $x = c$ then $f'(c) = 0$. It does not assert the (false) reverse implication $f'(c) = 0 \Rightarrow f$ has a local extreme at $x = c$.
7. No, because the interval $0 < x < 1$ fails to be closed. The Extreme Value Theorem says that if the function is continuous throughout a finite closed interval $a \leq x \leq b$ then the existence of absolute extrema is guaranteed on that interval.
8. The absolute maximum is $|-1| = 1$ and the absolute minimum is $|0| = 0$. This is not inconsistent with the Extreme Value Theorem for continuous functions, which says a continuous function on a closed interval attains its extreme values on that interval. The theorem says nothing about the behavior of a continuous function on an interval which is half open and half closed, such as $[-1, 1)$, so there is nothing to contradict.

9. (a) There appear to be local minima at $x = -1.75$ and 1.8 . Points of inflection are indicated at approximately $x = 0$ and $x = \pm 1$.

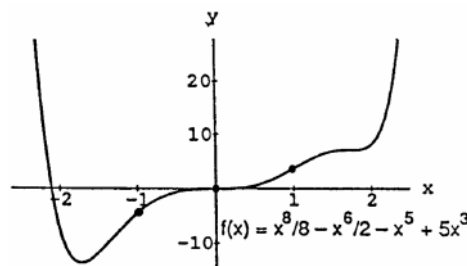

- (b) $f'(x) = x^7 - 3x^5 - 5x^4 + 15x^2 = x^2(x^2 - 3)(x^3 - 5)$. The pattern $y' = \text{---} | \text{+++} | \text{+++} | \text{---} | \text{+++}$ with critical points at $-\sqrt{3}, 0, \sqrt[3]{5}, \sqrt{3}$ indicates a local maximum at $x = \sqrt[3]{5}$ and local minima at $x = \pm\sqrt{3}$.

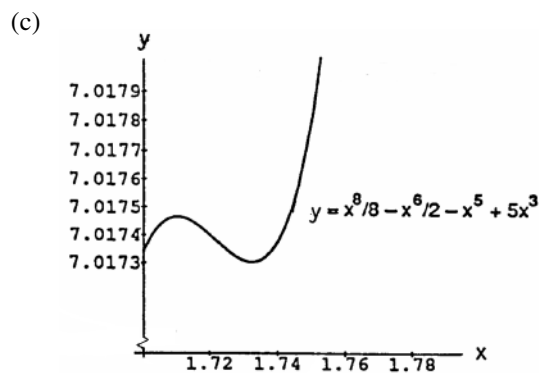

10. (a) The graph does not indicate any local extremum. Points of inflection are indicated at approximately $x = -\frac{3}{4}$ and $x = 1$.

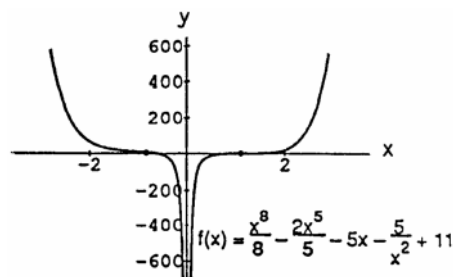

- (b) $f'(x) = x^7 - 2x^4 - 5 + \frac{10}{x^3} = x^{-3}(x^3 - 2)(x^7 - 5)$. The pattern $f' = \text{---} | \text{+++} | \text{---} | \text{+++}$ with critical points at $0, \sqrt[7]{5}, \sqrt[3]{2}$ indicates

a local maximum at $x = \sqrt[7]{5}$ and a local minimum at $x = \sqrt[3]{2}$.

(c)

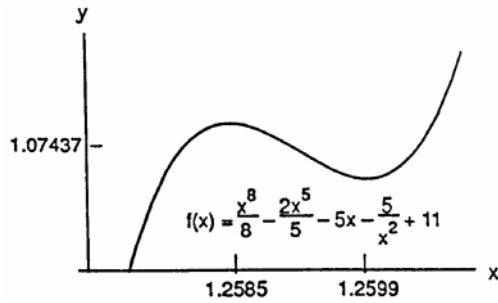

11. (a) $g(t) = \sin^2 t - 3t \Rightarrow g'(t) = 2 \sin t \cos t - 3 = \sin(2t) - 3 \Rightarrow g' < 0 \Rightarrow g(t)$ is always falling and hence must decrease on every interval in its domain.
- (b) One, since $\sin^2 t - 3t - 5 = 0$ and $\sin^2 t - 3t = 5$ have the same solutions: $f(t) = \sin^2 t - 3t - 5$ has the same derivative as $g(t)$ in part (a) and is always decreasing with $f(-3) > 0$ and $f(0) < 0$. The Intermediate Value Theorem guarantees the continuous function f has a root in $[-3, 0]$.
12. (a) $y = \tan \theta \Rightarrow \frac{dy}{d\theta} = \sec^2 \theta > 0 \Rightarrow y = \tan \theta$ is always rising on its domain $\Rightarrow y = \tan \theta$ increases on every interval in its domain
- (b) The interval $[\frac{\pi}{4}, \pi]$ is not in the tangent's domain because $\tan \theta$ is undefined at $\theta = \frac{\pi}{2}$. Thus the tangent need not increase on this interval.
13. (a) $f(x) = x^4 + 2x^2 - 2 \Rightarrow f'(x) = 4x^3 + 4x$. Since $f(0) = -2 < 0$, $f(1) = 1 > 0$ and $f'(x) \geq 0$ for $0 \leq x \leq 1$, we may conclude from the Intermediate Value Theorem that $f(x)$ has exactly one solution when $0 \leq x \leq 1$.
- (b) $x^2 = \frac{-2 \pm \sqrt{4+8}}{2} > 0 \Rightarrow x^2 = \sqrt{3} - 1$ and $x \geq 0 \Rightarrow x \approx \sqrt{.7320508076} \approx .8555996772$
14. (a) $y = \frac{x}{x+1} \Rightarrow y' = \frac{1}{(x+1)^2} > 0$, for all x in the domain of $\frac{x}{x+1} \Rightarrow y = \frac{x}{x+1}$ is increasing in every interval in its domain
- (b) $y = x^3 + 2x \Rightarrow y' = 3x^2 + 2 > 0$ for all $x \Rightarrow$ the graph of $y = x^3 + 2x$ is always increasing and can never have a local maximum or minimum
15. Let $V(t)$ represent the volume of the water in the reservoir at time t , in minutes, let $V(0) = a_0$ be the initial amount and $V(1440) = a_0 + (1400)(43,560)(7.48)$ gallons be the amount of water contained in the reservoir after the rain, where 24 hr = 1440 min. Assume that $V(t)$ is continuous on $[0, 1440]$ and differentiable on $(0, 1440)$. The Mean Value Theorem says that for some t_0 in $(0, 1440)$ we have $V'(t_0) = \frac{V(1440) - V(0)}{1440 - 0} = \frac{a_0 + (1400)(43,560)(7.48) - a_0}{1440} = \frac{456,160,320 \text{ gal}}{1440 \text{ min}} = 316,778 \text{ gal/min}$. Therefore at t_0 the reservoir's volume was increasing at a rate in excess of 225,000 gal/min.
16. Yes, all differentiable functions $g(x)$ having 3 as a derivative differ by only a constant. Consequently, the difference $3x - g(x)$ is a constant K because $g'(x) = 3 = \frac{d}{dx}(3x)$. Thus $g(x) = 3x + K$, the same form as $F(x)$.
17. No, $\frac{x}{x+1} = 1 + \frac{-1}{x+1} \Rightarrow \frac{x}{x+1}$ differs from $\frac{-1}{x+1}$ by the constant 1. Both functions have the same derivative $\frac{d}{dx} \left(\frac{x}{x+1} \right) = \frac{(x+1) - x(1)}{(x+1)^2} = \frac{1}{(x+1)^2} = \frac{d}{dx} \left(\frac{-1}{x+1} \right)$.
18. $f'(x) = g'(x) = \frac{2x}{(x^2+1)^2} \Rightarrow f(x) - g(x) = C$ for some constant $C \Rightarrow$ the graphs differ by a vertical shift.
19. The global minimum value of $\frac{1}{2}$ occurs at $x = 2$.

20. (a) The function is increasing on the intervals $[-3, -2]$ and $[1, 2]$.
 (b) The function is decreasing on the intervals $[-2, 0)$ and $(0, 1]$.
 (c) The local maximum values occur only at $x = -2$, and at $x = 2$; local minimum values occur at $x = -3$ and at $x = 1$ provided f is continuous at $x = 0$.

21. (a) $t = 0, 6, 12$ (b) $t = 3, 9$ (c) $6 < t < 12$ (d) $0 < t < 6, 12 < t < 14$

22. (a) $t = 4$ (b) at no time (c) $0 < t < 4$ (d) $4 < t < 8$

23.

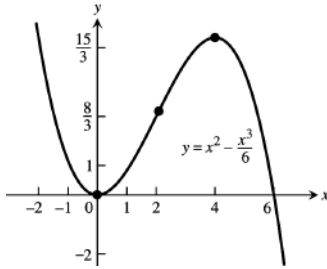

24.

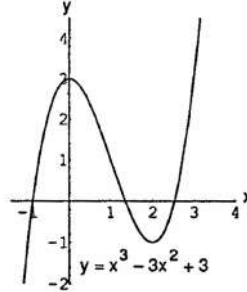

25.

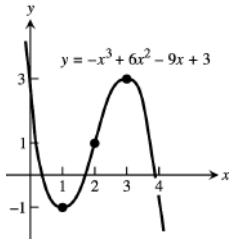

26.

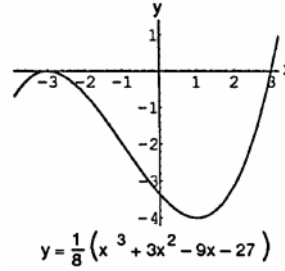

27.

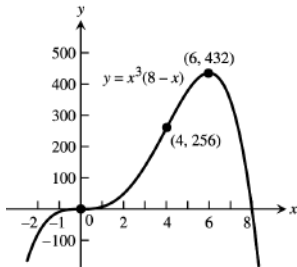

28.

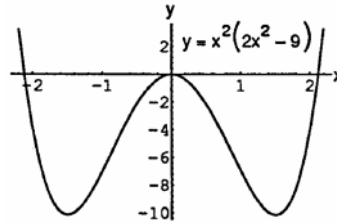

29.

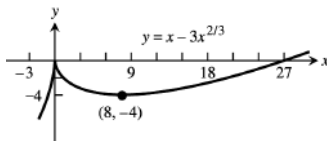

30.

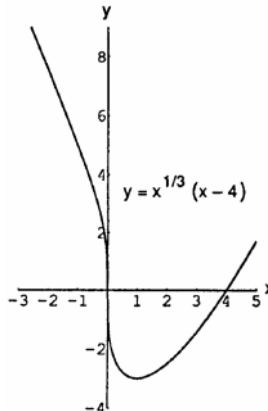

31.

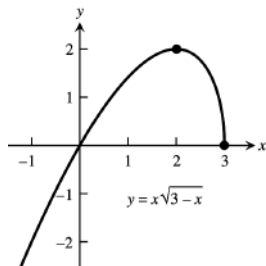

32.

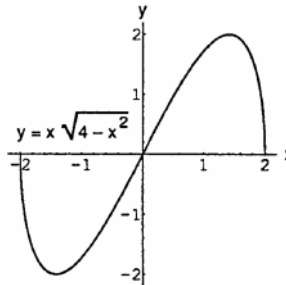

33. (a) $y' = 16 - x^2 \Rightarrow y' = \begin{matrix} - & - & - & | & + & + & + & | & - & - & - & - \\ -4 & & & & & & & & & & & & 4 \end{matrix} \Rightarrow$ the curve is rising on $(-4, 4)$, falling on $(-\infty, -4)$ and $(4, \infty)$
 \Rightarrow a local maximum at $x = 4$ and a local minimum at $x = -4$; $y'' = -2x \Rightarrow y'' = \begin{matrix} + & + & + & | & - & - & - & - \\ 0 \end{matrix} \Rightarrow$ the curve is concave up on $(-\infty, 0)$, concave down on $(0, \infty) \Rightarrow$ a point of inflection at $x = 0$

(b)

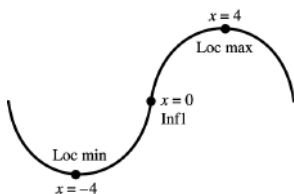

34. (a) $y' = x^2 - x - 6 = (x - 3)(x + 2) \Rightarrow y' = \begin{matrix} + & + & + & | & - & - & - & | & + & + & + \\ -2 & & & & & & & & & & & 3 \end{matrix} \Rightarrow$ the curve is rising on $(-\infty, -2)$ and $(3, \infty)$, falling on $(-2, 3) \Rightarrow$ local maximum at $x = -2$ and a local minimum at $x = 3$; $y'' = 2x - 1$
 $\Rightarrow y'' = \begin{matrix} - & - & - & | & + & + & + \\ 1/2 \end{matrix} \Rightarrow$ concave up on $(\frac{1}{2}, \infty)$, concave down on $(-\infty, \frac{1}{2}) \Rightarrow$ a point of inflection at $x = \frac{1}{2}$

(b)

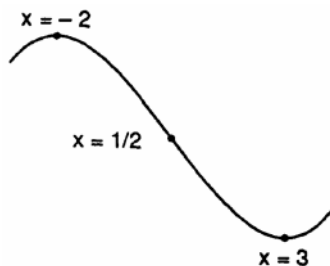

35. (a) $y' = 6x(x + 1)(x - 2) = 6x^3 - 6x^2 - 12x \Rightarrow y' = \begin{matrix} - & - & - & | & + & + & + & | & - & - & - & - \\ -1 & & & & & & & & & & & 2 \end{matrix} \Rightarrow$ the graph is rising on $(-1, 0)$ and $(2, \infty)$, falling on $(-\infty, -1)$ and $(0, 2) \Rightarrow$ a local maximum at $x = 0$, local minima at $x = -1$ and $x = 2$; $y'' = 18x^2 - 12x - 12 = 6(3x^2 - 2x - 2) = 6(x - \frac{1-\sqrt{7}}{3})(x - \frac{1+\sqrt{7}}{3}) \Rightarrow$
 $y'' = \begin{matrix} + & + & + & | & - & - & - & | & + & + & + \\ \frac{1-\sqrt{7}}{3} & & & & & & & & & & & \frac{1+\sqrt{7}}{3} \end{matrix} \Rightarrow$ the curve is concave up on $(-\infty, \frac{1-\sqrt{7}}{3})$ and $(\frac{1+\sqrt{7}}{3}, \infty)$, concave down on $(\frac{1-\sqrt{7}}{3}, \frac{1+\sqrt{7}}{3}) \Rightarrow$ points of inflection at $x = \frac{1\pm\sqrt{7}}{3}$

(b)

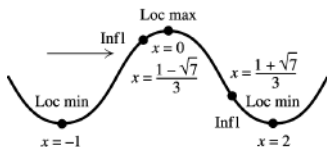

36. (a) $y' = x^2(6 - 4x) = 6x^2 - 4x^3 \Rightarrow y' = \begin{matrix} + & + & + & | & + & + & + & | & - & - & - & - \\ 0 & & & & & & & & & & & & \end{matrix} \Rightarrow$ the curve is rising on $(-\infty, \frac{3}{2})$, falling on $(\frac{3}{2}, \infty)$
 \Rightarrow a local maximum at $x = \frac{3}{2}$; $y'' = 12x - 12x^2 = 12x(1 - x) \Rightarrow y'' = \begin{matrix} - & - & - & | & + & + & + & | & - & - & - & - \\ 0 & & & & & & & & & & & & \end{matrix} \Rightarrow$ concave up on $(0, 1)$, concave down on $(-\infty, 0)$ and $(1, \infty) \Rightarrow$ points of inflection at $x = 0$ and $x = 1$

(b)

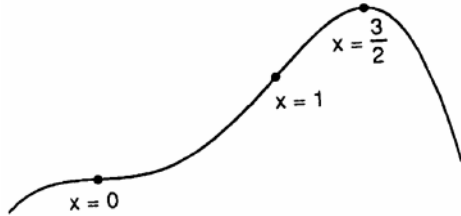

37. (a) $y' = x^4 - 2x^2 = x^2(x^2 - 2) \Rightarrow y' = \begin{matrix} + & + & + & | & - & - & - & | & - & - & - & | & - & - & - & | & + & + & + \\ -\sqrt{2} & \end{matrix} \Rightarrow$ the curve is rising on $(-\infty, -\sqrt{2})$ and $(\sqrt{2}, \infty)$, falling on $(-\sqrt{2}, \sqrt{2}) \Rightarrow$ a local maximum at $x = -\sqrt{2}$ and a local minimum at $x = \sqrt{2}$;
 $y'' = 4x^3 - 4x = 4x(x - 1)(x + 1) \Rightarrow y'' = \begin{matrix} - & - & - & | & + & + & + & | & - & - & - & | & + & + & + \\ -1 & \end{matrix} \Rightarrow$ concave up on $(-1, 0)$ and $(1, \infty)$, concave down on $(-\infty, -1)$ and $(0, 1) \Rightarrow$ points of inflection at $x = 0$ and $x = \pm 1$

(b)

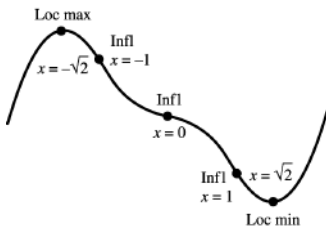

38. (a) $y' = 4x^2 - x^4 = x^2(4 - x^2) \Rightarrow y' = \begin{matrix} - & - & - & | & + & + & + & | & + & + & + & | & - & - & - & - \\ -2 & \end{matrix} \Rightarrow$ the curve is rising on $(-2, 0)$ and $(0, 2)$, falling on $(-\infty, -2)$ and $(2, \infty) \Rightarrow$ a local maximum at $x = 2$, a local minimum at $x = -2$; $y'' = 8x - 4x^3 = 4x(2 - x^2) \Rightarrow y'' = \begin{matrix} + & + & + & | & - & - & - & | & + & + & + & | & - & - & - & - \\ -\sqrt{2} & \end{matrix} \Rightarrow$ concave up on $(-\infty, -\sqrt{2})$ and $(0, \sqrt{2})$, concave down on $(-\sqrt{2}, 0)$ and $(\sqrt{2}, \infty) \Rightarrow$ points of inflection at $x = 0$ and $x = \pm \sqrt{2}$

(b)

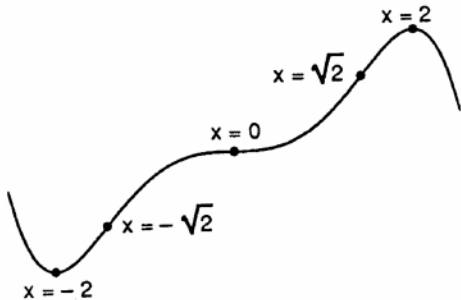

39. The values of the first derivative indicate that the curve is rising on $(0, \infty)$ and falling on $(-\infty, 0)$. The slope of the curve approaches $-\infty$ as $x \rightarrow 0^-$, and approaches ∞ as $x \rightarrow 0^+$ and $x \rightarrow 1$. The curve should therefore have a cusp and local minimum at $x = 0$, and a vertical tangent at $x = 1$.

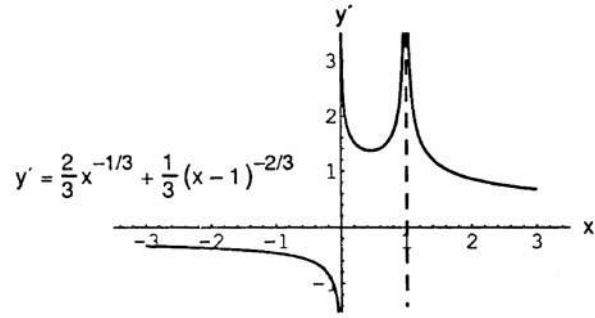
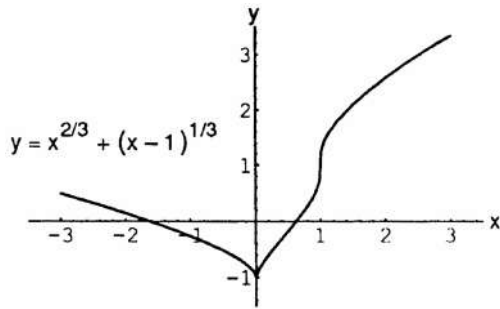

40. The values of the first derivative indicate that the curve is rising on $(0, \frac{1}{2})$ and $(1, \infty)$, and falling on $(-\infty, 0)$ and $(\frac{1}{2}, 1)$. The derivative changes from positive to negative at $x = \frac{1}{2}$, indicating a local maximum there. The slope of the curve approaches $-\infty$ as $x \rightarrow 0^-$ and $x \rightarrow 1^-$, and approaches ∞ as $x \rightarrow 0^+$ and as $x \rightarrow 1^+$, indicating cusps and local minima at both $x = 0$ and $x = 1$.

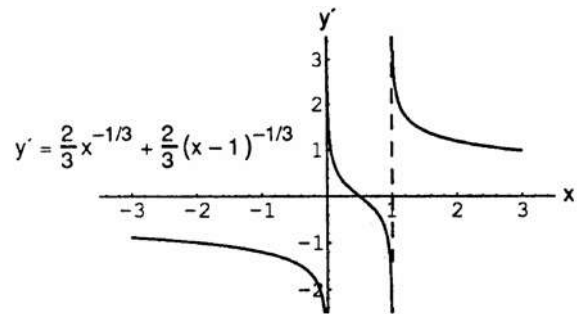
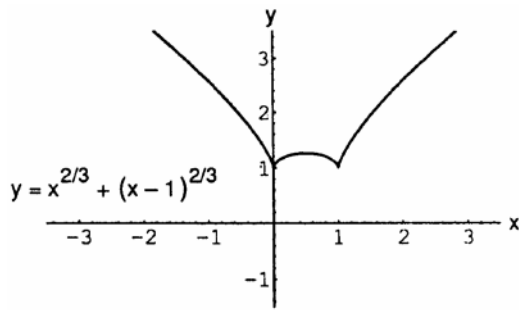

41. The values of the first derivative indicate that the curve is always rising. The slope of the curve approaches ∞ as $x \rightarrow 0$ and as $x \rightarrow 1$, indicating vertical tangents at both $x = 0$ and $x = 1$.

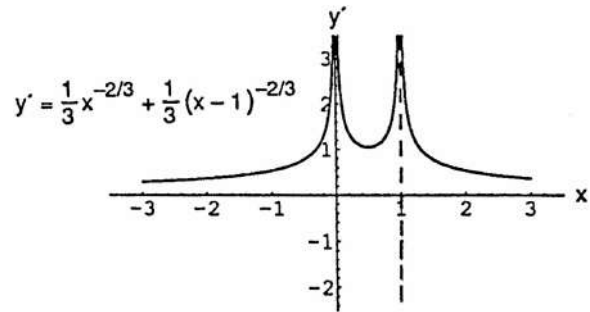
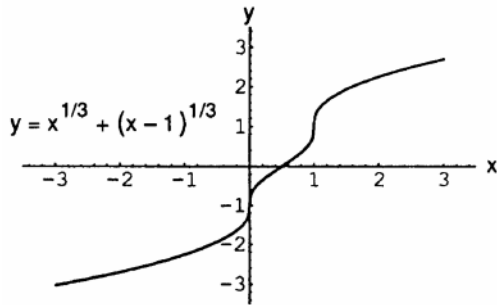

42. The graph of the first derivative indicates that the curve is rising on $(0, \frac{17-\sqrt{33}}{16})$ and $(\frac{17+\sqrt{33}}{16}, \infty)$, falling on $(-\infty, 0)$ and $(\frac{17-\sqrt{33}}{16}, \frac{17+\sqrt{33}}{16}) \Rightarrow$ a local maximum at $x = \frac{17-\sqrt{33}}{16}$, a local minimum at $x = \frac{17+\sqrt{33}}{16}$. The derivative approaches $-\infty$ as $x \rightarrow 0^-$ and $x \rightarrow 1$, and approaches ∞ as $x \rightarrow 0^+$, indicating a cusp and local minimum at $x = 0$ and a vertical tangent at $x = 1$.

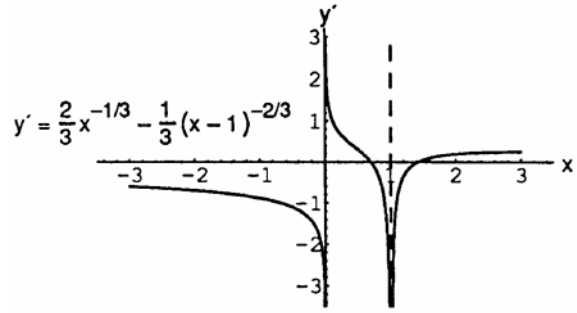
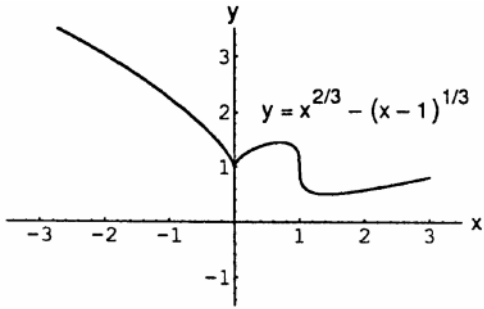

43. $y = \frac{x+1}{x-3} = 1 + \frac{4}{x-3}$

44. $y = \frac{2x}{x+5} = 2 - \frac{10}{x+5}$

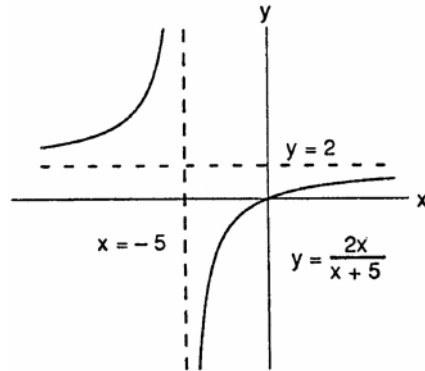
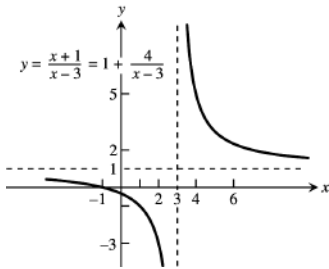

45. $y = \frac{x^2+1}{x} = x + \frac{1}{x}$

46. $y = \frac{x^2-x+1}{x} = x - 1 + \frac{1}{x}$

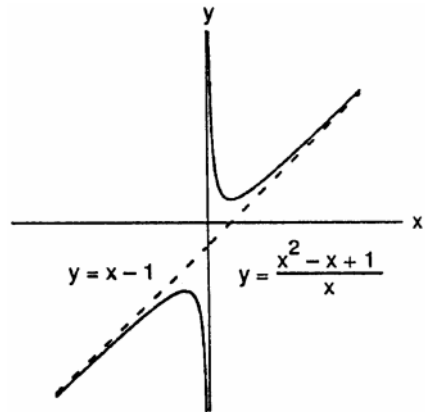
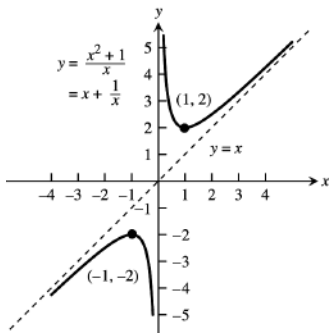

47. $y = \frac{x^3+2}{2x} = \frac{x^2}{2} + \frac{1}{x}$

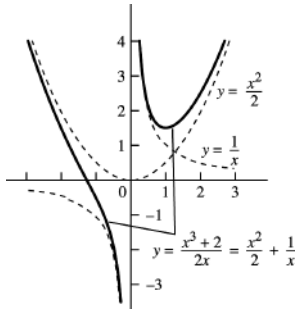

48. $y = \frac{x^4-1}{x^2} = x^2 - \frac{1}{x^2}$

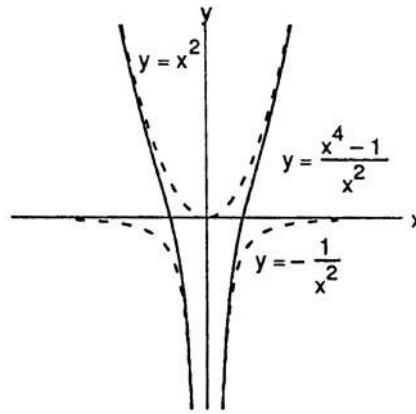

49. $y = \frac{x^2-4}{x^2-3} = 1 - \frac{1}{x^2-3}$

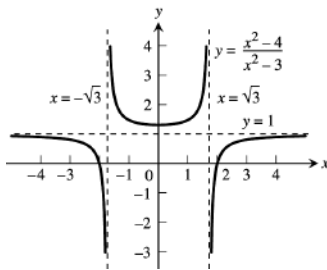

50. $y = \frac{x^2}{x^2-4} = 1 + \frac{4}{x^2-4}$

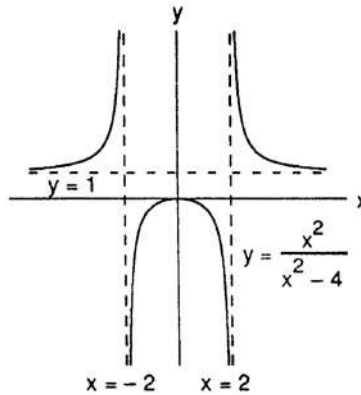

51. $\lim_{x \rightarrow 1} \frac{x^2+3x-4}{x-1} = \lim_{x \rightarrow 1} \frac{2x+3}{1} = 5$

52. $\lim_{x \rightarrow 1} \frac{x^a-1}{x^b-1} = \lim_{x \rightarrow 1} \frac{ax^{a-1}}{bx^{b-1}} = \frac{a}{b}$

53. $\lim_{x \rightarrow \pi} \frac{\tan x}{x} = \frac{\tan \pi}{\pi} = 0$

54. $\lim_{x \rightarrow 0} \frac{\tan x}{x + \sin x} = \lim_{x \rightarrow 0} \frac{\sec^2 x}{1 + \cos x} = \frac{1}{1+1} = \frac{1}{2}$

55. $\lim_{x \rightarrow 0} \frac{\sin^2 x}{\tan(x^2)} = \lim_{x \rightarrow 0} \frac{2 \sin x \cos x}{2x \sec^2(x^2)} = \lim_{x \rightarrow 0} \frac{\sin(2x)}{2x \sec^2(x^2)} = \lim_{x \rightarrow 0} \frac{2 \cos(2x)}{2x(2 \sec^2(x^2) \tan(x^2) \cdot 2x) + 2 \sec^2(x^2)} = \frac{2}{0+2 \cdot 1} = 1$

56. $\lim_{x \rightarrow 0} \frac{\sin(mx)}{\sin(nx)} = \lim_{x \rightarrow 0} \frac{m \cos(mx)}{n \cos(nx)} = \frac{m}{n}$

57. $\lim_{x \rightarrow \pi/2^-} \sec(7x) \cos(3x) = \lim_{x \rightarrow \pi/2^-} \frac{\cos(3x)}{\cos(7x)} = \lim_{x \rightarrow \pi/2^-} \frac{-3 \sin(3x)}{-7 \sin(7x)} = \frac{3}{7}$

58. $\lim_{x \rightarrow 0^+} \sqrt{x} \sec x = \lim_{x \rightarrow 0^+} \frac{\sqrt{x}}{\cos x} = \frac{0}{1} = 0$

59. $\lim_{x \rightarrow 0} (\csc x - \cot x) = \lim_{x \rightarrow 0} \frac{1 - \cos x}{\sin x} = \lim_{x \rightarrow 0} \frac{\sin x}{\cos x} = \frac{0}{1} = 0$

60. $\lim_{x \rightarrow 0} \left(\frac{1}{x^3} - \frac{1}{x^2} \right) = \lim_{x \rightarrow 0} \left(\frac{1-x^2}{x^4} \right) = \lim_{x \rightarrow 0} (1-x^2) \cdot \frac{1}{x^4} = \lim_{x \rightarrow 0} (1-x^2) = \lim_{x \rightarrow 0} \frac{1}{x^4} = 1 \cdot \infty = \infty$

61. $\lim_{x \rightarrow \infty} \left(\sqrt{x^2 + x + 1} - \sqrt{x^2 - x} \right) = \lim_{x \rightarrow \infty} \left(\sqrt{x^2 + x + 1} - \sqrt{x^2 - x} \right) \cdot \frac{\sqrt{x^2 + x + 1} + \sqrt{x^2 - x}}{\sqrt{x^2 + x + 1} + \sqrt{x^2 - x}}$
 $= \lim_{x \rightarrow \infty} \frac{2x+1}{\sqrt{x^2 + x + 1} + \sqrt{x^2 - x}}$

Notice that $x = \sqrt{x^2}$ for $x > 0$ so this is equivalent to

$= \lim_{x \rightarrow \infty} \frac{2x+1}{\sqrt{x^2 + x + 1} + \sqrt{x^2 - x}} = \lim_{x \rightarrow \infty} \frac{2 + \frac{1}{x}}{\sqrt{1 + \frac{1}{x} + \frac{1}{x^2}} + \sqrt{1 - \frac{1}{x}}} = \frac{2}{\sqrt{1+1}} = 1$

62. $\lim_{x \rightarrow \infty} \left(\frac{x^3}{x^2-1} - \frac{x^3}{x^2+1} \right) = \lim_{x \rightarrow \infty} \frac{x^3(x^2+1) - x^3(x^2-1)}{(x^2-1)(x^2+1)} = \lim_{x \rightarrow \infty} \frac{2x^3}{x^4-1} = \lim_{x \rightarrow \infty} \frac{6x^2}{4x^3} = \lim_{x \rightarrow \infty} \frac{12x}{12x^2} = 0$

63. (a) Maximize $f(x) = \sqrt{x} - \sqrt{36-x} = x^{1/2} - (36-x)^{1/2}$ where $0 \leq x \leq 36$
 $\Rightarrow f'(x) = \frac{1}{2}x^{-1/2} - \frac{1}{2}(36-x)^{-1/2}(-1) = \frac{\sqrt{36-x} + \sqrt{x}}{2\sqrt{x}\sqrt{36-x}} \Rightarrow$ derivative fails to exist at 0 and 36; $f(0) = -6$,
 and $f(36) = 6 \Rightarrow$ the numbers are 0 and 36

(b) Maximize $g(x) = \sqrt{x} + \sqrt{36-x} = x^{1/2} + (36-x)^{1/2}$ where $0 \leq x \leq 36$
 $\Rightarrow g'(x) = \frac{1}{2}x^{-1/2} + \frac{1}{2}(36-x)^{-1/2}(-1) = \frac{\sqrt{36-x} - \sqrt{x}}{2\sqrt{x}\sqrt{36-x}} \Rightarrow$ critical points at 0, 18 and 36; $g(0) = 6$,
 $g(18) = 2\sqrt{18} = 6\sqrt{2}$ and $g(36) = 6 \Rightarrow$ the numbers are 18 and 18

64. (a) Maximize $f(x) = \sqrt{x}(20-x) = 20x^{1/2} - x^{3/2}$ where $0 \leq x \leq 20 \Rightarrow f'(x) = 10x^{-1/2} - \frac{3}{2}x^{1/2}$
 $= \frac{20-3x}{2\sqrt{x}} = 0 \Rightarrow x = 0$ and $x = \frac{20}{3}$ are critical points; $f(0) = f(20) = 0$ and $f\left(\frac{20}{3}\right) = \sqrt{\frac{20}{3}}\left(20 - \frac{20}{3}\right)$
 $= \frac{40\sqrt{20}}{3\sqrt{3}} \Rightarrow$ the numbers are $\frac{20}{3}$ and $\frac{40}{3}$.

(b) Maximize $g(x) = x + \sqrt{20-x} = x + (20-x)^{1/2}$ where $0 \leq x \leq 20 \Rightarrow g'(x) = \frac{2\sqrt{20-x}-1}{2\sqrt{20-x}} = 0$
 $\Rightarrow \sqrt{20-x} = \frac{1}{2} \Rightarrow x = \frac{79}{4}$. The critical points are $x = \frac{79}{4}$ and $x = 20$. Since $g\left(\frac{79}{4}\right) = \frac{81}{4}$ and $g(20) = 20$,
 the numbers must be $\frac{79}{4}$ and $\frac{1}{4}$.

65. $A(x) = \frac{1}{2}(2x)(27-x^2)$ for $0 \leq x \leq \sqrt{27}$
 $\Rightarrow A'(x) = 3(3+x)(3-x)$ and $A''(x) = -6x$.
 The critical points are -3 and 3 , but -3 is not in the domain. Since $A''(3) = -18 < 0$ and $A(\sqrt{27}) = 0$,
 the maximum occurs at $x = 3 \Rightarrow$ the largest area is $A(3) = 54$ sq units.

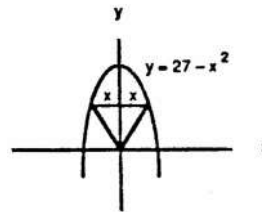

66. The volume is $V = x^2h = 32 \Rightarrow h = \frac{32}{x^2}$. The surface area is $S(x) = x^2 + 4x\left(\frac{32}{x^2}\right) = x^2 + \frac{128}{x}$,
 where $x > 0 \Rightarrow S'(x) = \frac{2(x-4)(x^2+4x+16)}{x^2}$
 \Rightarrow the critical points are 0 and 4, but 0 is not in the domain. Now $S''(4) = 2 + \frac{256}{4^3} > 0 \Rightarrow$ at $x = 4$ there
 is a minimum. The dimensions 4 ft by 4 ft by 2 ft minimize the surface area.

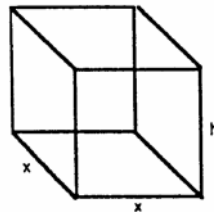

67. From the diagram we have $(\frac{h}{2})^2 + r^2 = (\sqrt{3})^2$
 $\Rightarrow r^2 = \frac{12-h^2}{4}$. The volume of the cylinder is
 $V = \pi r^2 h = \pi (\frac{12-h^2}{4}) h = \frac{\pi}{4} (12h - h^3)$, where
 $0 \leq h \leq 2\sqrt{3}$. Then $V'(h) = \frac{3\pi}{4} (2 + h)(2 - h)$
 \Rightarrow the critical points are -2 and 2 , but -2 is not in
the domain. At $h = 2$ there is a maximum since
 $V''(2) = -3\pi < 0$. The dimensions of the largest
cylinder are radius = $\sqrt{2}$ and height = 2 .

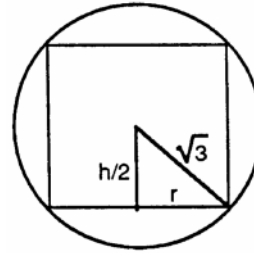

68. From the diagram we have $x =$ radius and
 $y =$ height = $12 - 2x$ and $V(x) = \frac{1}{3} \pi x^2 (12 - 2x)$, where
 $0 \leq x \leq 6 \Rightarrow V'(x) = 2\pi x(4 - x)$ and $V''(4) = -8\pi$. The
critical points are 0 and 4 ; $V(0) = V(6) = 0 \Rightarrow x = 4$
gives the maximum. Thus the values of $r = 4$ and
 $h = 4$ yield the largest volume for the smaller cone.

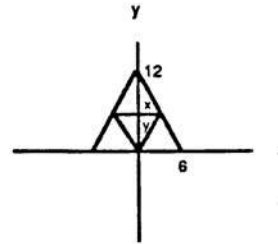

69. The profit $P = 2px + py = 2px + p(\frac{40-10x}{5-x})$, where p is the profit on grade B tires and $0 \leq x \leq 4$. Thus
 $P'(x) = \frac{2p}{(5-x)^2} (x^2 - 10x + 20) \Rightarrow$ the critical points are $(5 - \sqrt{5})$, 5 , and $(5 + \sqrt{5})$, but only $(5 - \sqrt{5})$ is in
the domain. Now $P'(x) > 0$ for $0 < x < (5 - \sqrt{5})$ and $P'(x) < 0$ for $(5 - \sqrt{5}) < x < 4 \Rightarrow$ at $x = (5 - \sqrt{5})$ there
is a local maximum. Also $P(0) = 8p$, $P(5 - \sqrt{5}) = 4p(5 - \sqrt{5}) \approx 11p$, and $P(4) = 8p \Rightarrow$ at $x = (5 - \sqrt{5})$ there
is an absolute maximum. The maximum occurs when $x = (5 - \sqrt{5})$ and $y = 2(5 - \sqrt{5})$, the units are
hundreds of tires, i.e., $x \approx 276$ tires and $y \approx 553$ tires.

70. (a) The distance between the particles is $|f(t)|$ where $f(t) = -\cos t + \cos(t + \frac{\pi}{4})$. Then, $f'(t) = \sin t - \sin(t + \frac{\pi}{4})$.
Solving $f'(t) = 0$ graphically, we obtain $t \approx 1.178$, $t \approx 4.320$, and so on.

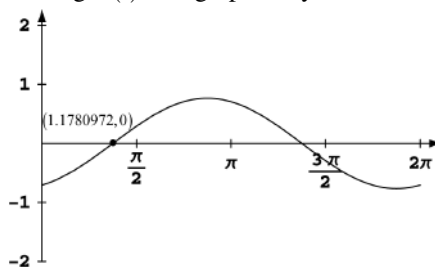

Alternatively, $f'(t) = 0$ may be solved analytically as follows. $f'(t) = \sin\left[\left(t + \frac{\pi}{8}\right) - \frac{\pi}{8}\right] - \sin\left[\left(t + \frac{\pi}{8}\right) + \frac{\pi}{8}\right]$
 $= \left[\sin\left(t + \frac{\pi}{8}\right)\cos\frac{\pi}{8} - \cos\left(t + \frac{\pi}{8}\right)\sin\frac{\pi}{8}\right] - \left[\sin\left(t + \frac{\pi}{8}\right)\cos\frac{\pi}{8} + \cos\left(t + \frac{\pi}{8}\right)\sin\frac{\pi}{8}\right] = -2\sin\frac{\pi}{8}\cos\left(t + \frac{\pi}{8}\right)$
so the critical points occur when $\cos\left(t + \frac{\pi}{8}\right) = 0$, or $t = \frac{3\pi}{8} + k\pi$. At each of these values, $f(t) = \pm \cos\frac{3\pi}{8}$
 $\approx \pm 0.765$ units, so the maximum distance between the particles is 0.765 units.

(b) Solving $\cos t = \cos\left(t + \frac{\pi}{4}\right)$ graphically, we obtain $t \approx 2.749$, $t \approx 5.890$, and so on.

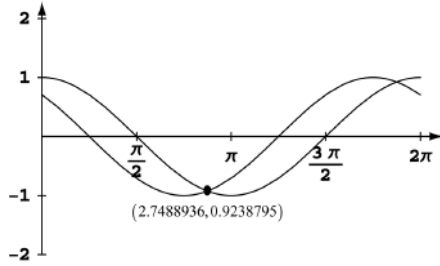

Alternatively, this problem can be solved analytically as follows.

$$\begin{aligned} \cos t &= \cos\left(t + \frac{\pi}{4}\right) \\ \cos\left[\left(t + \frac{\pi}{8}\right) - \frac{\pi}{8}\right] &= \cos\left[\left(t + \frac{\pi}{8}\right) + \frac{\pi}{8}\right] \\ \cos\left(t + \frac{\pi}{8}\right)\cos\frac{\pi}{8} + \sin\left(t + \frac{\pi}{8}\right)\sin\frac{\pi}{8} &= \cos\left(t + \frac{\pi}{8}\right)\cos\frac{\pi}{8} - \sin\left(t + \frac{\pi}{8}\right)\sin\frac{\pi}{8} \\ 2\sin\left(t + \frac{\pi}{8}\right)\sin\frac{\pi}{8} &= 0 \\ \sin\left(t + \frac{\pi}{8}\right) &= 0 \\ t &= \frac{7\pi}{8} + k\pi \end{aligned}$$

The particles collide when $t = \frac{7\pi}{8} \approx 2.749$. (plus multiples of π if they keep going.)

71. The dimensions will be x in. by $10 - 2x$ in. by $16 - 2x$ in., so $V(x) = x(10 - 2x)(16 - 2x) = 4x^3 - 52x^2 + 160x$ for $0 < x < 5$. Then $V'(x) = 12x^2 - 104x + 160 = 4(x - 2)(3x - 20)$, so the critical point in the correct domain is $x = 2$. This critical point corresponds to the maximum possible volume because $V'(x) > 0$ for $0 < x < 2$ and $V'(x) < 0$ for $2 < x < 5$. The box of largest volume has a height of 2 in. and a base measuring 6 in. by 12 in., and its volume is 144 in.³ Graphical support:

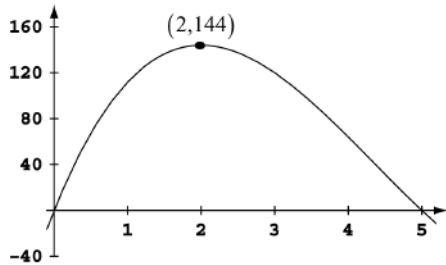

72. The length of the ladder is $d_1 + d_2 = 8 \sec \theta + 6 \csc \theta$. We wish to maximize $I(\theta) = 8 \sec \theta + 6 \csc \theta \Rightarrow I'(\theta) = 8 \sec \theta \tan \theta - 6 \csc \theta \cot \theta$. Then $I'(\theta) = 0 \Rightarrow 8 \sin^3 \theta - 6 \cos^3 \theta = 0 \Rightarrow \tan \theta = \frac{\sqrt[3]{6}}{2} \Rightarrow d_1 = 4 \sqrt{4 + \sqrt[3]{36}}$ and $d_2 = \sqrt[3]{36} \sqrt{4 + \sqrt[3]{36}}$ \Rightarrow the length of the ladder is about $(4 + \sqrt[3]{36}) \sqrt{4 + \sqrt[3]{36}} = (4 + \sqrt[3]{36})^{3/2} \approx 19.7$ ft.

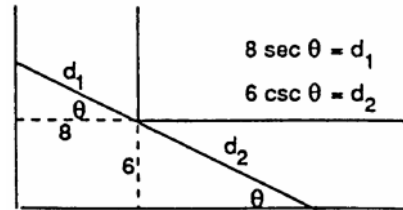

73. $g(x) = 3x - x^3 + 4 \Rightarrow g(2) = 2 > 0$ and $g(3) = -14 < 0 \Rightarrow g(x) = 0$ in the interval $[2, 3]$ by the Intermediate Value Theorem. Then $g'(x) = 3 - 3x^2 \Rightarrow x_{n+1} = x_n - \frac{3x_n - x_n^3 + 4}{3 - 3x_n^2}$; $x_0 = 2 \Rightarrow x_1 = 2.22 \Rightarrow x_2 = 2.196215$, and so forth to $x_5 = 2.195823345$.

74. $g(x) = x^4 - x^3 - 75 \Rightarrow g(3) = -21 < 0$ and $g(4) = 117 > 0 \Rightarrow g(x) = 0$ in the interval $[3, 4]$ by the Intermediate Value Theorem. Then $g'(x) = 4x^3 - 3x^2 \Rightarrow x_{n+1} = x_n - \frac{x_n^4 - x_n^3 - 75}{4x_n^3 - 3x_n^2}$; $x_0 = 3 \Rightarrow x_1 = 3.259259 \Rightarrow x_2 = 3.229050$, and so forth to $x_5 = 3.22857729$.

$$75. \int (x^3 + 5x - 7) dx = \frac{x^4}{4} + \frac{5x^2}{2} - 7x + C$$

$$76. \int \left(8t^3 - \frac{t^2}{2} + t \right) dt = \frac{8t^4}{4} - \frac{t^3}{6} + \frac{t^2}{2} + C = 2t^4 - \frac{t^3}{6} + \frac{t^2}{2} + C$$

$$77. \int \left(3\sqrt{t} + \frac{4}{t^2} \right) dt = \int (3t^{1/2} + 4t^{-2}) dt = \frac{3t^{3/2}}{\frac{3}{2}} + \frac{4t^{-1}}{-1} + C = 2t^{3/2} - \frac{4}{t} + C$$

$$78. \int \left(\frac{1}{2\sqrt{t}} - \frac{3}{t^4} \right) dt = \int \left(\frac{1}{2} t^{-1/2} - 3t^{-4} \right) dt = \frac{1}{2} \left(\frac{t^{1/2}}{\frac{1}{2}} \right) - \frac{3t^{-3}}{(-3)} + C = \sqrt{t} + \frac{1}{t^3} + C$$

79. Let $u = r + 5 \Rightarrow du = dr$

$$\int \frac{dr}{(r+5)^2} = \int \frac{du}{u^2} = \int u^{-2} du = \frac{u^{-1}}{-1} + C = -u^{-1} + C = -\frac{1}{(r+5)} + C$$

80. Let $u = r - \sqrt{2} \Rightarrow du = dr$

$$\int \frac{6 dr}{(r - \sqrt{2})^3} = 6 \int \frac{dr}{(r - \sqrt{2})^3} = 6 \int \frac{du}{u^3} = 6 \int u^{-3} du = 6 \left(\frac{u^{-2}}{-2} \right) + C = -3u^{-2} + C = -\frac{3}{(r - \sqrt{2})^2} + C$$

81. Let $u = \theta^2 + 1 \Rightarrow du = 2\theta d\theta \Rightarrow \frac{1}{2} du = \theta d\theta$

$$\int 3\theta\sqrt{\theta^2 + 1} d\theta = \int \sqrt{u} \left(\frac{3}{2} du \right) = \frac{3}{2} \int u^{1/2} du = \frac{3}{2} \left(\frac{u^{3/2}}{\frac{3}{2}} \right) + C = u^{3/2} + C = (\theta^2 + 1)^{3/2} + C$$

82. Let $u = 7 + \theta^2 \Rightarrow du = 2\theta d\theta \Rightarrow \frac{1}{2} du = \theta d\theta$

$$\int \frac{\theta}{\sqrt{7 + \theta^2}} d\theta = \int \frac{1}{\sqrt{u}} \left(\frac{1}{2} du \right) = \frac{1}{2} \int u^{-1/2} du = \frac{1}{2} \left(\frac{u^{1/2}}{\frac{1}{2}} \right) + C = u^{1/2} + C = \sqrt{7 + \theta^2} + C$$

83. Let $u = 1 + x^4 \Rightarrow du = 4x^3 dx \Rightarrow \frac{1}{4} du = x^3 dx$

$$\int x^3 (1 + x^4)^{-1/4} dx = \int u^{-1/4} \left(\frac{1}{4} du \right) = \frac{1}{4} \int u^{-1/4} du = \frac{1}{4} \left(\frac{u^{3/4}}{\frac{3}{4}} \right) + C = \frac{1}{3} u^{3/4} + C = \frac{1}{3} (1 + x^4)^{3/4} + C$$

84. Let $u = 2 - x \Rightarrow du = -dx \Rightarrow -du = dx$

$$\int (2 - x)^{3/5} dx = \int u^{3/5} (-du) = - \int u^{3/5} du = - \frac{u^{8/5}}{\frac{8}{5}} + C = -\frac{5}{8} u^{8/5} + C = -\frac{5}{8} (2 - x)^{8/5} + C$$

85. Let $u = \frac{s}{10} \Rightarrow du = \frac{1}{10} ds \Rightarrow 10 du = ds$

$$\int \sec^2 \frac{s}{10} ds = \int (\sec^2 u) (10 du) = 10 \int \sec^2 u du = 10 \tan u + C = 10 \tan \frac{s}{10} + C$$

86. Let $u = \pi s \Rightarrow du = \pi ds \Rightarrow \frac{1}{\pi} du = ds$

$$\int \csc^2 \pi s ds = \int (\csc^2 u) \left(\frac{1}{\pi} du \right) = \frac{1}{\pi} \int \csc^2 u du = -\frac{1}{\pi} \cot u + C = -\frac{1}{\pi} \cot \pi s + C$$

87. Let $u = \sqrt{2}\theta \Rightarrow du = \sqrt{2} d\theta \Rightarrow \frac{1}{\sqrt{2}} du = d\theta$

$$\int \csc \sqrt{2}\theta \cot \sqrt{2}\theta d\theta = \int (\csc u \cot u) \left(\frac{1}{\sqrt{2}} du \right) = \frac{1}{\sqrt{2}} (-\csc u) + C = -\frac{1}{\sqrt{2}} \csc \sqrt{2}\theta + C$$

88. Let $u = \frac{\theta}{3} \Rightarrow du = \frac{1}{3} d\theta \Rightarrow 3 du = d\theta$

$$\int \sec \frac{\theta}{3} \tan \frac{\theta}{3} d\theta = \int (\sec u \tan u)(3 du) = 3 \sec u + C = 3 \sec \frac{\theta}{3} + C$$

89. Let $u = \frac{x}{4} \Rightarrow du = \frac{1}{4} dx \Rightarrow 4 du = dx$

$$\begin{aligned} \int \sin^2 \frac{x}{4} dx &= \int (\sin^2 u)(4 du) = \int 4 \left(\frac{1 - \cos 2u}{2} \right) du = 2 \int (1 - \cos 2u) du = 2 \left(u - \frac{\sin 2u}{2} \right) + C \\ &= 2u - \sin 2u + C = 2 \left(\frac{x}{4} \right) - \sin 2 \left(\frac{x}{4} \right) + C = \frac{x}{2} - \sin \frac{x}{2} + C \end{aligned}$$

90. Let $u = \frac{x}{2} \Rightarrow du = \frac{1}{2} dx \Rightarrow 2 du = dx$

$$\begin{aligned} \int \cos^2 \frac{x}{2} dx &= \int (\cos^2 u)(2 du) = \int 2 \left(\frac{1 + \cos 2u}{2} \right) du = \int (1 + \cos 2u) du = u + \frac{\sin 2u}{2} + C \\ &= \frac{x}{2} + \frac{1}{2} \sin x + C \end{aligned}$$

91. $y = \int \frac{x^2+1}{x^2} dx = \int (1 + x^{-2}) dx = x - x^{-1} + C = x - \frac{1}{x} + C$; $y = -1$ when $x = 1 \Rightarrow 1 - \frac{1}{1} + C = -1$
 $\Rightarrow C = -1 \Rightarrow y = x - \frac{1}{x} - 1$

92. $y = \int \left(x + \frac{1}{x} \right)^2 dx = \int \left(x^2 + 2 + \frac{1}{x^2} \right) dx = \int (x^2 + 2 + x^{-2}) dx = \frac{x^3}{3} + 2x - x^{-1} + C = \frac{x^3}{3} + 2x - \frac{1}{x} + C$;
 $y = 1$ when $x = 1 \Rightarrow \frac{1}{3} + 2 - \frac{1}{1} + C = 1 \Rightarrow C = -\frac{1}{3} \Rightarrow y = \frac{x^3}{3} + 2x - \frac{1}{x} - \frac{1}{3}$

93. $\frac{dr}{dt} = \int \left(15\sqrt{t} + \frac{3}{\sqrt{t}} \right) dt = \int (15t^{1/2} + 3t^{-1/2}) dt = 10t^{3/2} + 6t^{1/2} + C$; $\frac{dr}{dt} = 8$ when $t = 1$
 $\Rightarrow 10(1)^{3/2} + 6(1)^{1/2} + C = 8 \Rightarrow C = -8$. Thus $\frac{dr}{dt} = 10t^{3/2} + 6t^{1/2} - 8 \Rightarrow r = \int (10t^{3/2} + 6t^{1/2} - 8) dt$
 $= 4t^{5/2} + 4t^{3/2} - 8t + C_1$; $r = 0$ when $t = 1 \Rightarrow 4(1)^{5/2} + 4(1)^{3/2} - 8(1) + C_1 = 0 \Rightarrow C_1 = 0$. Therefore,
 $r = 4t^{5/2} + 4t^{3/2} - 8t$

94. $\frac{d^2r}{dt^2} = \int -\cos t dt = -\sin t + C$; $r'' = 0$ when $t = 0 \Rightarrow -\sin 0 + C = 0 \Rightarrow C = 0$. Thus, $\frac{d^2r}{dt^2} = -\sin t$
 $\Rightarrow \frac{dr}{dt} = \int -\sin t dt = \cos t + C_1$; $r' = 0$ when $t = 0 \Rightarrow 1 + C_1 = 0 \Rightarrow C_1 = -1$. Then $\frac{dr}{dt} = \cos t - 1$
 $\Rightarrow r = \int (\cos t - 1) dt = \sin t - t + C_2$; $r = -1$ when $t = 0 \Rightarrow 0 - 0 + C_2 = -1 \Rightarrow C_2 = -1$. Therefore,
 $r = \sin t - t - 1$

CHAPTER 4 ADDITIONAL AND ADVANCED EXERCISES

- If M and m are the maximum and minimum values, respectively, then $m \leq f(x) \leq M$ for all $x \in I$. If $m = M$ then f is constant on I .
- No, the function $f(x) = \begin{cases} 3x + 6, & -2 \leq x < 0 \\ 9 - x^2, & 0 \leq x \leq 2 \end{cases}$ has an absolute minimum value of 0 at $x = -2$ and an absolute maximum value of 9 at $x = 0$, but it is discontinuous at $x = 0$.
- On an open interval the extreme values of a continuous function (if any) must occur at an interior critical point. On a half-open interval the extreme values of a continuous function may be at a critical point or at the closed endpoint. Extreme values occur only where $f' = 0$, f' does not exist, or at the endpoints of the interval. Thus the extreme points will not be at the ends of an open interval.
- The pattern $f' = +++ \left| \text{-----} \right| \text{-----} \left| \text{++++} \right| \text{++++}$ indicates a local maximum at $x = 1$ and a local minimum at $x = 3$.

5. (a) If $y' = 6(x+1)(x-2)^2$, then $y' < 0$ for $x < -1$ and $y' > 0$ for $x > -1$. The sign pattern is $f' = \text{---} \mid \text{+++} \mid \text{+++} \Rightarrow f$ has a local minimum at $x = -1$. Also $y'' = 6(x-2)^2 + 12(x+1)(x-2) = 6(x-2)(3x) \Rightarrow y'' > 0$ for $x < 0$ or $x > 2$, while $y'' < 0$ for $0 < x < 2$. Therefore f has points of inflection at $x = 0$ and $x = 2$. There is no local maximum.
- (b) If $y' = 6x(x+1)(x-2)$, then $y' < 0$ for $x < -1$ and $0 < x < 2$; $y' > 0$ for $-1 < x < 0$ and $x > 2$. The sign pattern is $y' = \text{---} \mid \text{+++} \mid \text{---} \mid \text{+++}$. Therefore f has a local maximum at $x = 0$ and local minima at $x = -1$ and $x = 2$. Also, $y'' = 18 \left[x - \left(\frac{1-\sqrt{7}}{3} \right) \right] \left[x - \left(\frac{1+\sqrt{7}}{3} \right) \right]$, so $y'' < 0$ for $\frac{1-\sqrt{7}}{3} < x < \frac{1+\sqrt{7}}{3}$ and $y'' > 0$ for all other $x \Rightarrow f$ has points of inflection at $x = \frac{1 \pm \sqrt{7}}{3}$.

6. The Mean Value Theorem indicates that $\frac{f(6)-f(0)}{6-0} = f'(c) \leq 2$ for some c in $(0, 6)$. Then $f(6) - f(0) \leq 12$ indicates the most that f can increase is 12.

7. If f is continuous on $[a, c]$ and $f'(x) \leq 0$ on $[a, c]$, then by the Mean Value Theorem for all $x \in [a, c]$ we have $\frac{f(c)-f(x)}{c-x} \leq 0 \Rightarrow f(c) - f(x) \leq 0 \Rightarrow f(x) \geq f(c)$. Also if f is continuous on $(c, b]$ and $f'(x) \geq 0$ on $(c, b]$, then for all $x \in (c, b]$ we have $\frac{f(x)-f(c)}{x-c} \geq 0 \Rightarrow f(x) - f(c) \geq 0 \Rightarrow f(x) \geq f(c)$. Therefore $f(x) \geq f(c)$ for all $x \in [a, b]$.

8. (a) For all x , $-(x+1)^2 \leq 0 \leq (x-1)^2 \Rightarrow -(1+x^2) \leq 2x \leq (1+x^2) \Rightarrow -\frac{1}{2} \leq \frac{x}{1+x^2} \leq \frac{1}{2}$.

(b) There exists $c \in (a, b)$ such that $\frac{c}{1+c^2} = \frac{f(b)-f(a)}{b-a} \Rightarrow \left| \frac{f(b)-f(a)}{b-a} \right| = \left| \frac{c}{1+c^2} \right| \leq \frac{1}{2}$, from part (a) $\Rightarrow |f(b) - f(a)| \leq \frac{1}{2} |b - a|$.

9. No. Corollary 1 requires that $f'(x) = 0$ for all x in some interval I , not $f'(x) = 0$ at a single point in I .

10. (a) $h(x) = f(x)g(x) \Rightarrow h'(x) = f'(x)g(x) + f(x)g'(x)$ which changes signs at $x = a$ since $f'(x), g'(x) > 0$ when $x < a$, $f'(x), g'(x) < 0$ when $x > a$ and $f(x), g(x) > 0$ for all x . Therefore $h(x)$ does have a local maximum at $x = a$.

(b) No, let $f(x) = g(x) = x^3$ which have points of inflection at $x = 0$, but $h(x) = x^6$ has no point of inflection (it has a local minimum at $x = 0$).

11. From (ii), $f(-1) = \frac{-1+a}{b-c+2} = 0 \Rightarrow a = 1$; from (iii), either $1 = \lim_{x \rightarrow \infty} f(x)$ or $1 = \lim_{x \rightarrow -\infty} f(x)$. In either case,

$$\lim_{x \rightarrow \pm \infty} f(x) = \lim_{x \rightarrow \pm \infty} \frac{x+1}{bx^2+cx+2} = \lim_{x \rightarrow \pm \infty} \frac{1+\frac{1}{x}}{bx+c+\frac{2}{x}} = 1 \Rightarrow b = 0 \text{ and } c = 1. \text{ For if } b = 1, \text{ then}$$

$$\lim_{x \rightarrow \pm \infty} \frac{1+\frac{1}{x}}{x+c+\frac{2}{x}} = 0 \text{ and if } c = 0, \text{ then } \lim_{x \rightarrow \pm \infty} \frac{1+\frac{1}{x}}{bx+\frac{2}{x}} = \lim_{x \rightarrow \pm \infty} \frac{1+\frac{1}{x}}{\frac{2}{x}} = \pm \infty. \text{ Thus } a = 1, b = 0, \text{ and } c = 1.$$

12. $\frac{dy}{dx} = 3x^2 + 2kx + 3 = 0 \Rightarrow x = \frac{-2k \pm \sqrt{4k^2 - 36}}{6} \Rightarrow x$ has only one value when $4k^2 - 36 = 0 \Rightarrow k^2 = 9$ or $k = \pm 3$.

13. The area of the $\triangle ABC$ is $A(x) = \frac{1}{2} (2) \sqrt{1-x^2} = (1-x^2)^{1/2}$, where $0 \leq x \leq 1$. Thus $A'(x) = \frac{-x}{\sqrt{1-x^2}} \Rightarrow 0$ and ± 1 are critical points. Also $A(\pm 1) = 0$ so $A(0) = 1$ is the maximum. When $x = 0$ the $\triangle ABC$ is isosceles since $AC = BC = \sqrt{2}$.

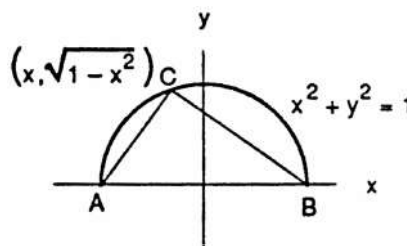

14. $\lim_{h \rightarrow 0} \frac{f'(c+h) - f'(c)}{h} = f''(c) \Rightarrow$ for $\epsilon = \frac{1}{2} |f''(c)| > 0$ there exists a $\delta > 0$ such that $0 < |h| < \delta$
 $\Rightarrow \left| \frac{f'(c+h) - f'(c)}{h} - f''(c) \right| < \frac{1}{2} |f''(c)|$. Then $f'(c) = 0 \Rightarrow -\frac{1}{2} |f''(c)| < \frac{f'(c+h)}{h} - f''(c) < \frac{1}{2} |f''(c)|$
 $\Rightarrow f''(c) - \frac{1}{2} |f''(c)| < \frac{f'(c+h)}{h} < f''(c) + \frac{1}{2} |f''(c)|$. If $f''(c) < 0$, then $|f''(c)| = -f''(c)$
 $\Rightarrow \frac{3}{2} f''(c) < \frac{f'(c+h)}{h} < \frac{1}{2} f''(c) < 0$; likewise if $f''(c) > 0$, then $0 < \frac{1}{2} f''(c) < \frac{f'(c+h)}{h} < \frac{3}{2} f''(c)$.
 (a) If $f''(c) < 0$, then $-\delta < h < 0 \Rightarrow f'(c+h) > 0$ and $0 < h < \delta \Rightarrow f'(c+h) < 0$. Therefore, $f(c)$ is a local maximum.
 (b) If $f''(c) > 0$, then $-\delta < h < 0 \Rightarrow f'(c+h) < 0$ and $0 < h < \delta \Rightarrow f'(c+h) > 0$. Therefore, $f(c)$ is a local minimum.

15. The time it would take the water to hit the ground from height y is $\sqrt{\frac{2y}{g}}$, where g is the acceleration of gravity. The product of time and exit velocity (rate) yields the distance the water travels:
 $D(y) = \sqrt{\frac{2y}{g}} \sqrt{64(h-y)} = 8 \sqrt{\frac{2}{g}} (hy - y^2)^{1/2}, 0 \leq y \leq h \Rightarrow D'(y) = -4 \sqrt{\frac{2}{g}} (hy - y^2)^{-1/2} (h - 2y) \Rightarrow 0, \frac{h}{2}$ and h are critical points. Now $D(0) = 0, D(\frac{h}{2}) = \frac{8h}{\sqrt{g}}$ and $D(h) = 0 \Rightarrow$ the best place to drill the hole is at $y = \frac{h}{2}$.

16. From the figure in the text, $\tan(\beta + \theta) = \frac{b+a}{h}; \tan(\beta + \theta) = \frac{\tan \beta + \tan \theta}{1 - \tan \beta \tan \theta}$; and $\tan \theta = \frac{a}{h}$. These equations give $\frac{b+a}{h} = \frac{\tan \beta + \frac{a}{h}}{1 - \frac{a}{h} \tan \beta} = \frac{h \tan \beta + a}{h - a \tan \beta}$. Solving for $\tan \beta$ gives $\tan \beta = \frac{bh}{h^2 + a(b+a)}$ or $(h^2 - a(b+a)) \tan \beta = bh$. Differentiating both sides with respect to h gives $2h \tan \beta + (h^2 + a(b+a)) \sec^2 \beta \frac{d\beta}{dh} = b$. Then $\frac{d\beta}{dh} = 0 \Rightarrow 2h \tan \beta = b \Rightarrow 2h \left(\frac{bh}{h^2 + a(b+a)} \right) = b \Rightarrow 2bh^2 = bh^2 + ab(b+a) \Rightarrow h^2 = a(b+a) \Rightarrow h = \sqrt{a(a+b)}$.

17. The surface area of the cylinder is $S = 2\pi r^2 + 2\pi rh$. From the diagram we have $\frac{r}{R} = \frac{H-h}{H} \Rightarrow h = \frac{RH-rH}{R}$ and $S(r) = 2\pi r(r+h) = 2\pi r \left(r + H - r \frac{H}{R} \right) = 2\pi \left(1 - \frac{H}{R} \right) r^2 + 2\pi Hr$, where $0 \leq r \leq R$.

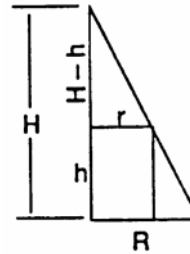

Case 1: $H < R \Rightarrow S(r)$ is a quadratic equation containing the origin and concave upward $\Rightarrow S(r)$ is maximum at $r = R$.

Case 2: $H = R \Rightarrow S(r)$ is a linear equation containing the origin with a positive slope $\Rightarrow S(r)$ is maximum at $r = R$.

Case 3: $H > R \Rightarrow S(r)$ is a quadratic equation containing the origin and concave downward. Then $\frac{dS}{dr} = 4\pi \left(1 - \frac{H}{R} \right) r + 2\pi H$ and $\frac{dS}{dr} = 0 \Rightarrow 4\pi \left(1 - \frac{H}{R} \right) r + 2\pi H = 0 \Rightarrow r = \frac{RH}{2(H-R)}$. For simplification we let $r^* = \frac{RH}{2(H-R)}$.

- (a) If $R < H < 2R$, then $0 > H - 2R \Rightarrow H > 2(H - R) \Rightarrow \frac{RH}{2(H-R)} > R$ which is impossible.
 (b) If $H = 2R$, then $r^* = \frac{2R^2}{2R} = R \Rightarrow S(r)$ is maximum at $r = R$.
 (c) If $H > 2R$, then $2R + H < 2H \Rightarrow H < 2(H - R) \Rightarrow \frac{H}{2(H-R)} < 1 \Rightarrow \frac{RH}{2(H-R)} < R \Rightarrow r^* < R$. Therefore, $S(r)$ is a maximum at $r = r^* = \frac{RH}{2(H-R)}$.

Conclusion: If $H \in (0, R]$ or $H = 2R$, then the maximum surface area is at $r = R$. If $H \in (R, 2R)$, then $r > R$ which is not possible. If $H \in (2R, \infty)$, then the maximum is at $r = r^* = \frac{RH}{2(H-R)}$.

18. $f(x) = mx - 1 + \frac{1}{x} \Rightarrow f'(x) = m - \frac{1}{x^2}$ and $f''(x) = \frac{2}{x^3} > 0$ when $x > 0$. Then $f'(x) = 0 \Rightarrow x = \frac{1}{\sqrt{m}}$ yields a minimum. If $f\left(\frac{1}{\sqrt{m}}\right) \geq 0$, then $\sqrt{m} - 1 + \sqrt{m} = 2\sqrt{m} - 1 \geq 0 \Rightarrow m \geq \frac{1}{4}$. Thus the smallest acceptable value

for m is $\frac{1}{4}$.

19. (a) $\lim_{x \rightarrow 0} \frac{2\sin(5x)}{3x} = \lim_{x \rightarrow 0} \frac{2\sin(5x)}{\frac{2}{5}(5x)} = \lim_{x \rightarrow 0} \frac{10 \sin(5x)}{3(5x)} = \frac{10}{3} \cdot 1 = \frac{10}{3}$
- (b) $\lim_{x \rightarrow 0} \sin(5x)\cot(3x) = \lim_{x \rightarrow 0} \frac{\sin(5x)\cos(3x)}{\sin(3x)} = \lim_{x \rightarrow 0} \frac{-3\sin(5x)\sin(3x) + 5\cos(5x)\cos(3x)}{3\cos(3x)} = \frac{5}{3}$
- (c) $\lim_{x \rightarrow 0} x \csc^2 \sqrt{2x} = \lim_{x \rightarrow 0} \frac{x}{\sin^2 \sqrt{2x}} = \lim_{x \rightarrow 0} \frac{1}{\frac{2\sin \sqrt{2x} \cos \sqrt{2x}}{\sqrt{2x}}} = \lim_{x \rightarrow 0} \frac{\sqrt{2x}}{\sin(2\sqrt{2x})} = \lim_{x \rightarrow 0} \frac{\frac{1}{\sqrt{2x}}}{\cos(2\sqrt{2x}) \frac{2}{\sqrt{2x}}}$
 $= \lim_{x \rightarrow 0} \frac{1}{\cos(2\sqrt{2x}) \cdot 2} = \frac{1}{2}$
- (d) $\lim_{x \rightarrow \pi/2} (\sec x - \tan x) = \lim_{x \rightarrow \pi/2} \frac{1 - \sin x}{\cos x} = \lim_{x \rightarrow \pi/2} \frac{-\cos x}{-\sin x} = 0$.
- (e) $\lim_{x \rightarrow 0} \frac{x - \sin x}{x - \tan x} = \lim_{x \rightarrow 0} \frac{1 - \cos x}{1 - \sec^2 x} = \lim_{x \rightarrow 0} \frac{1 - \cos x}{-\tan^2 x} = \lim_{x \rightarrow 0} \frac{\cos x - 1}{\tan^2 x} = \lim_{x \rightarrow 0} \frac{-\sin x}{2 \tan x \sec^2 x} = \lim_{x \rightarrow 0} \frac{-\sin x}{2 \frac{\sin x}{\cos^3 x}} = \lim_{x \rightarrow 0} \frac{-\sin x}{2 \frac{\sin x}{\cos^3 x}} = \lim_{x \rightarrow 0} \frac{-\cos^3 x}{2} = -\frac{1}{2}$
- (f) $\lim_{x \rightarrow 0} \frac{\sin(x^2)}{x \sin x} = \lim_{x \rightarrow 0} \frac{2x \cos(x^2)}{x \cos x + \sin x} = \lim_{x \rightarrow 0} \frac{-(2x^2)\sin(x^2) + 2\cos(x^2)}{-x \sin x + 2\cos x} = \frac{2}{2} = 1$
- (g) $\lim_{x \rightarrow 0} \frac{\sec x - 1}{x^2} = \lim_{x \rightarrow 0} \frac{\sec x \tan x}{2x} = \lim_{x \rightarrow 0} \frac{\sec^3 x + \tan^2 x \sec x}{2} = \frac{1+0}{2} = \frac{1}{2}$
- (h) $\lim_{x \rightarrow 2} \frac{x^3 - 8}{x^2 - 4} = \lim_{x \rightarrow 2} \frac{(x-2)(x^2 + 2x + 4)}{(x-2)(x+2)} = \lim_{x \rightarrow 2} \frac{x^2 + 2x + 4}{x+2} = \frac{4+4+4}{4} = 3$

20. (a) $x \lim_{x \rightarrow \infty} \frac{\sqrt{x+5}}{\sqrt{x+5}} = x \lim_{x \rightarrow \infty} \frac{\frac{\sqrt{x+5}}{\sqrt{x}}}{\frac{\sqrt{x+5}}{\sqrt{x}}} = x \lim_{x \rightarrow \infty} \frac{\sqrt{1+\frac{5}{x}}}{1+\frac{5}{x}} = \frac{1}{1} = 1$
- (b) $x \lim_{x \rightarrow \infty} \frac{2x}{x+7\sqrt{x}} = x \lim_{x \rightarrow \infty} \frac{\frac{2x}{x}}{\frac{x+7\sqrt{x}}{x}} = x \lim_{x \rightarrow \infty} \frac{2}{1+7\sqrt{\frac{1}{x}}} = \frac{2}{1+0} = 2$

21. (a) The profit function is $P(x) = (c - ex)x - (a + bx) = -ex^2 + (c - b)x - a$. $P'(x) = -2ex + c - b = 0$
 $\Rightarrow x = \frac{c-b}{2e}$. $P''(x) = -2e < 0$ if $e > 0$ so that the profit function is maximized at $x = \frac{c-b}{2e}$.

- (b) The price therefore that corresponds to a production level yielding a maximum profit is

$$p \Big|_{x=\frac{c-b}{2e}} = c - e\left(\frac{c-b}{2e}\right) = \frac{c+b}{2} \text{ dollars.}$$

- (c) The weekly profit at this production level is $P(x) = -e\left(\frac{c-b}{2e}\right)^2 + (c-b)\left(\frac{c-b}{2e}\right) - a = \frac{(c-b)^2}{4e} - a$.

- (d) The tax increases cost to the new profit function is $F(x) = (c - ex)x - (a + bx + tx) = -ex^2 + (c - b - t)x - a$.
 Now $F'(x) = -2ex + c - b - t = 0$ when $x = \frac{c-b-t}{2e} = \frac{c-b-t}{2e}$. Since $F''(x) = -2e < 0$ if $e > 0$, F is maximized when $x = \frac{c-b-t}{2e}$ units per week. Thus the price per unit is $p = c - e\left(\frac{c-b-t}{2e}\right) = \frac{c+b+t}{2}$ dollars. Thus, such a tax increases the cost per unit by $\frac{c+b+t}{2} - \frac{c+b}{2} = \frac{t}{2}$ dollars if units are priced to maximize profit.

22. (a)

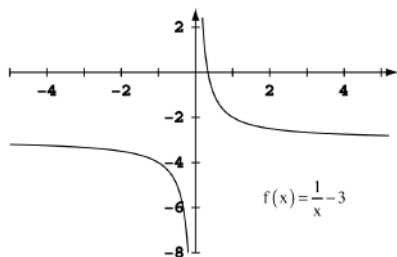

The x -intercept occurs when $\frac{1}{x} - 3 = 0 \Rightarrow \frac{1}{x} = 3 \Rightarrow x = \frac{1}{3}$.

- (b) By Newton's method, $x_{n+1} = x_n - \frac{f(x_n)}{f'(x_n)}$. Here $f'(x_n) = -x_n^{-2} = \frac{-1}{x_n^2}$. So $x_{n+1} = x_n - \frac{\frac{1}{x_n} - 3}{\frac{-1}{x_n^2}} = x_n + \left(\frac{1}{x_n} - 3\right)x_n^2$
 $= x_n + x_n - 3x_n^2 = 2x_n - 3x_n^2 = x_n(2 - 3x_n)$.

23. $x_1 = x_0 - \frac{f(x_0)}{f'(x_0)} = x_0 - \frac{x_0^q - a}{qx_0^{q-1}} = \frac{qx_0^q - x_0^q - a}{qx_0^{q-1}} = \frac{x_0^q(q-1) - a}{qx_0^{q-1}} = x_0 \left(\frac{q-1}{q} \right) + \frac{a}{x_0^{q-1}} \left(\frac{1}{q} \right)$ so that x_1 is a weighted average of x_0 and $\frac{a}{x_0^{q-1}}$ with weights $m_0 = \frac{q-1}{q}$ and $m_1 = \frac{1}{q}$.

In the case where $x_0 = \frac{a}{x_0^{q-1}}$ we have $x_0^q = a$ and $x_1 = \frac{a}{x_0^{q-1}} \left(\frac{q-1}{q} \right) + \frac{a}{x_0^{q-1}} \left(\frac{1}{q} \right) = \frac{a}{x_0^{q-1}} \left(\frac{q-1}{q} + \frac{1}{q} \right) = \frac{a}{x_0^{q-1}}$.

24. We have that $(x-h)^2 + (y-h)^2 = r^2$ and so $2(x-h) + 2(y-h)\frac{dy}{dx} = 0$ and $2 + 2\frac{dy}{dx} + 2(y-h)\frac{d^2y}{dx^2} = 0$ hold.

Thus $2x + 2y\frac{dy}{dx} = 2h + 2h\frac{dy}{dx}$, by the former. Solving for h , we obtain $h = \frac{x + y\frac{dy}{dx}}{1 + \frac{dy}{dx}}$. Substituting this into the second

equation yields $2 + 2\frac{dy}{dx} + 2y\frac{d^2y}{dx^2} - 2\left(\frac{x + y\frac{dy}{dx}}{1 + \frac{dy}{dx}}\right) = 0$. Dividing by 2 results in $1 + \frac{dy}{dx} + y\frac{d^2y}{dx^2} - \left(\frac{x + y\frac{dy}{dx}}{1 + \frac{dy}{dx}}\right) = 0$.

25. (a) $a(t) = s''(t) = -k$ ($k > 0$) $\Rightarrow s'(t) = -kt + C_1$, where $s'(0) = 88 \Rightarrow C_1 = 88 \Rightarrow s'(t) = -kt + 88$. So

$s(t) = \frac{-kt^2}{2} + 88t + C_2$ where $s(0) = 0 \Rightarrow C_2 = 0$ so $s(t) = \frac{-kt^2}{2} + 88t$. Now $s(t) = 100$ when

$\frac{-kt^2}{2} + 88t = 100$. Solving for t we obtain $t = \frac{88 \pm \sqrt{88^2 - 200k}}{k}$. At such t we want $s'(t) = 0$, thus

$-k\left(\frac{88 + \sqrt{88^2 - 200k}}{k}\right) + 88 = 0$ or $-k\left(\frac{88 - \sqrt{88^2 - 200k}}{k}\right) + 88 = 0$. In either case we obtain $88^2 - 200k = 0$

so that $k = \frac{88^2}{200} \approx 38.72$ ft/sec².

- (b) The initial condition that $s'(0) = 44$ ft/sec implies that $s'(t) = -kt + 44$ and $s(t) = \frac{-kt^2}{2} + 44t$ where k is as above.

The car is stopped at a time t such that $s'(t) = -kt + 44 = 0 \Rightarrow t = \frac{44}{k}$. At this time the car has traveled a distance

$s\left(\frac{44}{k}\right) = \frac{-k}{2}\left(\frac{44}{k}\right)^2 + 44\left(\frac{44}{k}\right) = \frac{44^2}{2k} = \frac{968}{k} = 968\left(\frac{200}{88^2}\right) = 25$ feet. Thus halving the initial velocity quarters stopping distance.

26. $h(x) = f^2(x) + g^2(x) \Rightarrow h'(x) = 2f(x)f'(x) + 2g(x)g'(x) = 2[f(x)f'(x) + g(x)g'(x)] = 2[f(x)g'(x) + g(x)(-f'(x))]$
 $= 2 \cdot 0 = 0$. Thus $h(x) = c$, a constant. Since $h(0) = 5$, $h(x) = 5$ for all x in the domain of h . Thus $h(10) = 5$.

27. Yes. The curve $y = x$ satisfies all three conditions since $\frac{dy}{dx} = 1$ everywhere, when $x = 0$, $y = 0$, and $\frac{d^2y}{dx^2} = 0$ everywhere.

28. $y' = 3x^2 + 2$ for all $x \Rightarrow y = x^3 + 2x + C$ where $-1 = 1^3 + 2 \cdot 1 + C \Rightarrow C = -4 \Rightarrow y = x^3 + 2x - 4$.

29. $s''(t) = a = -t^2 \Rightarrow v = s'(t) = \frac{-t^3}{3} + C$. We seek $v_0 = s'(0) = C$. We know that $s(t^*) = b$ for some t^* and s is at a maximum for this t^* . Since $s(t) = \frac{-t^4}{12} + Ct + k$ and $s(0) = 0$ we have that $s(t) = \frac{-t^4}{12} + Ct$ and also $s'(t^*) = 0$ so that

$t^* = (3C)^{1/3}$. So $\frac{[-(3C)^{1/3}]^4}{12} + C(3C)^{1/3} = b \Rightarrow (3C)^{1/3}(C - \frac{3C}{12}) = b \Rightarrow (3C)^{1/3}\left(\frac{3C}{4}\right) = b \Rightarrow 3^{1/3}C^{4/3} = \frac{4b}{3}$

$\Rightarrow C = \frac{(4b)^{3/4}}{3}$. Thus $v_0 = s'(0) = \frac{(4b)^{3/4}}{3} = \frac{2\sqrt{2}}{3}b^{3/4}$.

30. (a) $s''(t) = t^{1/2} - t^{-1/2} \Rightarrow v(t) = s'(t) = \frac{2}{3}t^{3/2} - 2t^{1/2} + k$ where $v(0) = k = \frac{4}{3} \Rightarrow v(t) = \frac{2}{3}t^{3/2} - 2t^{1/2} + \frac{4}{3}$.

(b) $s(t) = \frac{4}{15}t^{5/2} - \frac{4}{3}t^{3/2} + \frac{4}{3}t + k_2$ where $s(0) = k_2 = -\frac{4}{15}$. Thus $s(t) = \frac{4}{15}t^{5/2} - \frac{4}{3}t^{3/2} + \frac{4}{3}t - \frac{4}{15}$.

31. The graph of $f(x) = ax^2 + bx + c$ with $a > 0$ is a parabola opening upwards. Thus $f(x) \geq 0$ for all x if $f(x) = 0$ for at most

one real value of x . The solutions to $f(x) = 0$ are, by the quadratic equation $\frac{-2b \pm \sqrt{(2b)^2 - 4ac}}{2a}$. Thus we require

$(2b)^2 - 4ac \leq 0 \Rightarrow b^2 - ac \leq 0$.

32. (a) Clearly $f(x) = (a_1x + b_1)^2 + \dots + (a_nx + b_n)^2 \geq 0$ for all x . Expanding we see

$f(x) = (a_1^2x^2 + 2a_1b_1x + b_1^2) + \dots + (a_n^2x^2 + 2a_nb_nx + b_n^2)$

$= (a_1^2 + a_2^2 + \dots + a_n^2)x^2 + 2(a_1b_1 + a_2b_2 + \dots + a_nb_n)x + (b_1^2 + b_2^2 + \dots + b_n^2) \geq 0$.

Thus $(a_1b_1 + a_2b_2 + \dots + a_nb_n)^2 - (a_1^2 + a_2^2 + \dots + a_n^2)(b_1^2 + b_2^2 + \dots + b_n^2) \leq 0$ by Exercise 31.

Thus $(a_1b_1 + a_2b_2 + \dots + a_nb_n)^2 \leq (a_1^2 + a_2^2 + \dots + a_n^2)(b_1^2 + b_2^2 + \dots + b_n^2)$.

- (b) Referring to Exercise 31: It is clear that $f(x) = 0$ for some real $x \Leftrightarrow b^2 - 4ac = 0$, by quadratic formula.

Now notice that this implies that

$$\begin{aligned} f(x) &= (a_1x + b_1)^2 + \dots + (a_nx + b_n)^2 \\ &= (a_1^2 + a_2^2 + \dots + a_n^2)x^2 + 2(a_1b_1 + a_2b_2 + \dots + a_nb_n)x + (b_1^2 + b_2^2 + \dots + b_n^2) = 0 \\ &\Leftrightarrow (a_1b_1 + a_2b_2 + \dots + a_nb_n)^2 - (a_1^2 + a_2^2 + \dots + a_n^2)(b_1^2 + b_2^2 + \dots + b_n^2) = 0 \\ &\Leftrightarrow (a_1b_1 + a_2b_2 + \dots + a_nb_n)^2 = (a_1^2 + a_2^2 + \dots + a_n^2)(b_1^2 + b_2^2 + \dots + b_n^2) \end{aligned}$$

But now $f(x) = 0 \Leftrightarrow a_ix + b_i = 0$ for all $i = 1, 2, \dots, n \Leftrightarrow a_ix = -b_i = 0$ for all $i = 1, 2, \dots, n$.

CHAPTER 5 INTEGRATION

5.1 ESTIMATING WITH FINITE SUMS

1. $f(x) = x^2$

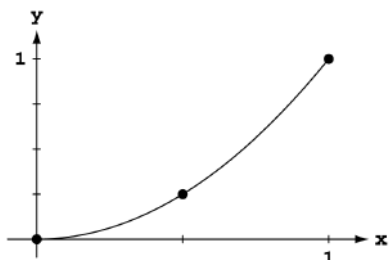

Since f is increasing on $[0, 1]$, we use left endpoints to obtain lower sums and right endpoints to obtain upper sums.

(a) $\Delta x = \frac{1-0}{2} = \frac{1}{2}$ and $x_i = i\Delta x = \frac{i}{2} \Rightarrow$ a lower sum is $\sum_{i=0}^1 \left(\frac{i}{2}\right)^2 \cdot \frac{1}{2} = \frac{1}{2} \left(0^2 + \left(\frac{1}{2}\right)^2\right) = \frac{1}{8}$

(b) $\Delta x = \frac{1-0}{4} = \frac{1}{4}$ and $x_i = i\Delta x = \frac{i}{4} \Rightarrow$ a lower sum is $\sum_{i=0}^3 \left(\frac{i}{4}\right)^2 \cdot \frac{1}{4} = \frac{1}{4} \left(0^2 + \left(\frac{1}{4}\right)^2 + \left(\frac{2}{4}\right)^2 + \left(\frac{3}{4}\right)^2\right) = \frac{1}{4} \cdot \frac{7}{8} = \frac{7}{32}$

(c) $\Delta x = \frac{1-0}{2} = \frac{1}{2}$ and $x_i = i\Delta x = \frac{i}{2} \Rightarrow$ an upper sum is $\sum_{i=1}^2 \left(\frac{i}{2}\right)^2 \cdot \frac{1}{2} = \frac{1}{2} \left(\left(\frac{1}{2}\right)^2 + 1^2\right) = \frac{5}{8}$

(d) $\Delta x = \frac{1-0}{4} = \frac{1}{4}$ and $x_i = i\Delta x = \frac{i}{4} \Rightarrow$ an upper sum is $\sum_{i=1}^4 \left(\frac{i}{4}\right)^2 \cdot \frac{1}{4} = \frac{1}{4} \left(\left(\frac{1}{4}\right)^2 + \left(\frac{2}{4}\right)^2 + \left(\frac{3}{4}\right)^2 + 1^2\right) = \frac{1}{4} \cdot \left(\frac{30}{16}\right) = \frac{15}{32}$

2. $f(x) = x^3$

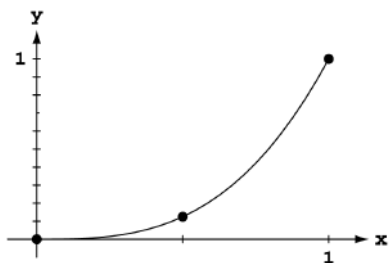

Since f is increasing on $[0, 1]$, we use left endpoints to obtain lower sums and right endpoints to obtain upper sums.

(a) $\Delta x = \frac{1-0}{2} = \frac{1}{2}$ and $x_i = i\Delta x = \frac{i}{2} \Rightarrow$ a lower sum is $\sum_{i=0}^1 \left(\frac{i}{2}\right)^3 \cdot \frac{1}{2} = \frac{1}{2} \left(0^3 + \left(\frac{1}{2}\right)^3\right) = \frac{1}{16}$

(b) $\Delta x = \frac{1-0}{4} = \frac{1}{4}$ and $x_i = i\Delta x = \frac{i}{4} \Rightarrow$ a lower sum is $\sum_{i=0}^3 \left(\frac{i}{4}\right)^3 \cdot \frac{1}{4} = \frac{1}{4} \left(0^3 + \left(\frac{1}{4}\right)^3 + \left(\frac{2}{4}\right)^3 + \left(\frac{3}{4}\right)^3\right) = \frac{36}{256} = \frac{9}{64}$

(c) $\Delta x = \frac{1-0}{2} = \frac{1}{2}$ and $x_i = i\Delta x = \frac{i}{2} \Rightarrow$ an upper sum is $\sum_{i=1}^2 \left(\frac{i}{2}\right)^3 \cdot \frac{1}{2} = \frac{1}{2} \left(\left(\frac{1}{2}\right)^3 + 1^3\right) = \frac{1}{2} \cdot \frac{9}{8} = \frac{9}{16}$

(d) $\Delta x = \frac{1-0}{4} = \frac{1}{4}$ and $x_i = i\Delta x = \frac{i}{4} \Rightarrow$ an upper sum is $\sum_{i=1}^4 \left(\frac{i}{4}\right)^3 \cdot \frac{1}{4} = \frac{1}{4} \left(\left(\frac{1}{4}\right)^3 + \left(\frac{2}{4}\right)^3 + \left(\frac{3}{4}\right)^3 + 1^3\right) = \frac{100}{256} = \frac{25}{64}$

3. $f(x) = \frac{1}{x}$

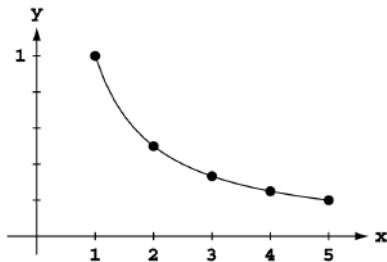

Since f is decreasing on $[0, 1]$, we use left endpoints to obtain upper sums and right endpoints to obtain lower sums.

(a) $\Delta x = \frac{5-1}{2} = 2$ and $x_i = 1 + i\Delta x = 1 + 2i \Rightarrow$ a lower sum is $\sum_{i=1}^2 \frac{1}{x_i} \cdot 2 = 2\left(\frac{1}{3} + \frac{1}{5}\right) = \frac{16}{15}$

(b) $\Delta x = \frac{5-1}{4} = 1$ and $x_i = 1 + i\Delta x = 1 + i \Rightarrow$ a lower sum is $\sum_{i=1}^4 \frac{1}{x_i} \cdot 1 = 1\left(\frac{1}{2} + \frac{1}{3} + \frac{1}{4} + \frac{1}{5}\right) = \frac{77}{60}$

(c) $\Delta x = \frac{5-1}{2} = 2$ and $x_i = 1 + i\Delta x = 1 + 2i \Rightarrow$ an upper sum is $\sum_{i=0}^1 \frac{1}{x_i} \cdot 2 = 2\left(1 + \frac{1}{3}\right) = \frac{8}{3}$

(d) $\Delta x = \frac{5-1}{4} = 1$ and $x_i = 1 + i\Delta x = 1 + i \Rightarrow$ an upper sum is $\sum_{i=0}^3 \frac{1}{x_i} \cdot 1 = 1\left(1 + \frac{1}{2} + \frac{1}{3} + \frac{1}{4}\right) = \frac{25}{12}$

4. $f(x) = 4 - x^2$

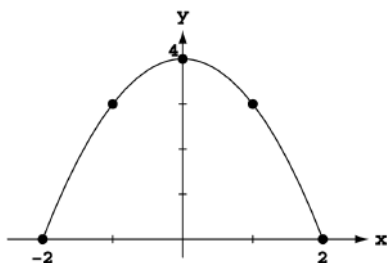

Since f is increasing on $[-2, 0]$ and decreasing on $[0, 2]$, we use left endpoints on $[-2, 0]$ and right endpoints on $[0, 2]$ to obtain lower sums and use right endpoints on $[-2, 0]$ and left endpoints on $[0, 2]$ to obtain upper sums.

(a) $\Delta x = \frac{2-(-2)}{2} = 2$ and $x_i = -2 + i\Delta x = -2 + 2i \Rightarrow$ a lower sum is $2 \cdot (4 - (-2)^2) + 2 \cdot (4 - 2^2) = 0$

(b) $\Delta x = \frac{2-(-2)}{4} = 1$ and $x_i = -2 + i\Delta x = -2 + i \Rightarrow$ a lower sum is $\sum_{i=0}^1 (4 - (x_i)^2) \cdot 1 + \sum_{i=3}^4 (4 - (x_i)^2) \cdot 1$
 $= 1((4 - (-2)^2) + (4 - (-1)^2) + (4 - 1^2) + (4 - 2^2)) = 6$

(c) $\Delta x = \frac{2-(-2)}{2} = 2$ and $x_i = -2 + i\Delta x = -2 + 2i \Rightarrow$ an upper sum is $2 \cdot (4 - (0)^2) + 2 \cdot (4 - 0^2) = 16$

(d) $\Delta x = \frac{2-(-2)}{4} = 1$ and $x_i = -2 + i\Delta x = -2 + i \Rightarrow$ an upper sum is $\sum_{i=1}^2 (4 - (x_i)^2) \cdot 1 + \sum_{i=2}^3 (4 - (x_i)^2) \cdot 1$
 $= 1((4 - (-1)^2) + (4 - 0^2) + (4 - 0^2) + (4 - 1^2)) = 14$

5. $f(x) = x^2$

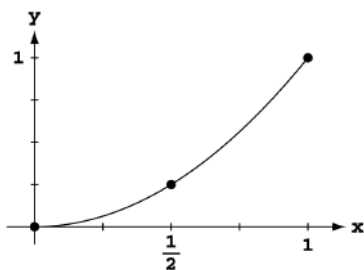

Using 2 rectangles $\Rightarrow \Delta x = \frac{1-0}{2} = \frac{1}{2} \Rightarrow \frac{1}{2}(f(\frac{1}{4}) + f(\frac{3}{4}))$
 $= \frac{1}{2}\left(\left(\frac{1}{4}\right)^2 + \left(\frac{3}{4}\right)^2\right) = \frac{10}{32} = \frac{5}{16}$

Using 4 rectangles $\Rightarrow \Delta x = \frac{1-0}{4} = \frac{1}{4}$
 $\Rightarrow \frac{1}{4}(f(\frac{1}{8}) + f(\frac{3}{8}) + f(\frac{5}{8}) + f(\frac{7}{8}))$
 $= \frac{1}{4}\left(\left(\frac{1}{8}\right)^2 + \left(\frac{3}{8}\right)^2 + \left(\frac{5}{8}\right)^2 + \left(\frac{7}{8}\right)^2\right) = \frac{21}{64}$

6. $f(x) = x^3$

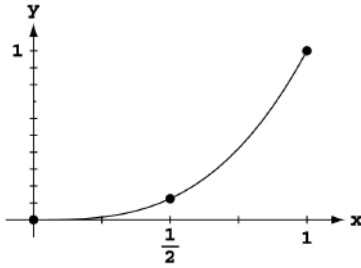

$$\begin{aligned} \text{Using 2 rectangles} &\Rightarrow \Delta x = \frac{1-0}{2} = \frac{1}{2} \Rightarrow \frac{1}{2}(f(\frac{1}{4}) + f(\frac{3}{4})) \\ &= \frac{1}{2}\left(\left(\frac{1}{4}\right)^3 + \left(\frac{3}{4}\right)^3\right) = \frac{28}{2 \cdot 64} = \frac{7}{32} \end{aligned}$$

$$\begin{aligned} \text{Using 4 rectangles} &\Rightarrow \Delta x = \frac{1-0}{4} = \frac{1}{4} \\ &\Rightarrow \frac{1}{4}(f(\frac{1}{8}) + f(\frac{3}{8}) + f(\frac{5}{8}) + f(\frac{7}{8})) \\ &= \frac{1}{4}\left(\frac{1^3+3^3+5^3+7^3}{8^3}\right) = \frac{496}{4 \cdot 8^3} = \frac{124}{8^3} = \frac{31}{128} \end{aligned}$$

7. $f(x) = \frac{1}{x}$

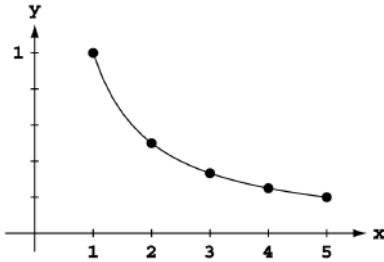

$$\begin{aligned} \text{Using 2 rectangles} &\Rightarrow \Delta x = \frac{5-1}{2} = 2 \Rightarrow 2(f(2) + f(4)) \\ &= 2\left(\frac{1}{2} + \frac{1}{4}\right) = \frac{3}{2} \end{aligned}$$

$$\begin{aligned} \text{Using 4 rectangles} &\Rightarrow \Delta x = \frac{5-1}{4} = 1 \\ &\Rightarrow 1(f(\frac{3}{2}) + f(\frac{5}{2}) + f(\frac{7}{2}) + f(\frac{9}{2})) \\ &= 1\left(\frac{2}{3} + \frac{2}{5} + \frac{2}{7} + \frac{2}{9}\right) = \frac{1488}{3 \cdot 5 \cdot 7 \cdot 9} = \frac{496}{5 \cdot 7 \cdot 9} = \frac{496}{315} \end{aligned}$$

8. $f(x) = 4 - x^2$

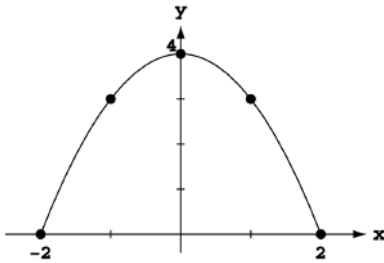

$$\begin{aligned} \text{Using 2 rectangles} &\Rightarrow \Delta x = \frac{2-(-2)}{2} = 2 \Rightarrow 2(f(-1) + f(1)) \\ &= 2(3 + 3) = 12 \end{aligned}$$

$$\begin{aligned} \text{Using 4 rectangles} &\Rightarrow \Delta x = \frac{2-(-2)}{4} = 1 \\ &\Rightarrow 1(f(-\frac{3}{2}) + f(-\frac{1}{2}) + f(\frac{1}{2}) + f(\frac{3}{2})) \\ &= 1\left(\left(4 - \left(-\frac{3}{2}\right)^2\right) + \left(4 - \left(-\frac{1}{2}\right)^2\right) + \left(4 - \left(\frac{1}{2}\right)^2\right) + \left(4 - \left(\frac{3}{2}\right)^2\right)\right) \\ &= 16 - \left(\frac{9}{4} \cdot 2 + \frac{1}{4} \cdot 2\right) = 16 - \frac{10}{2} = 11 \end{aligned}$$

9. (a) $D \approx (0)(1) + (12)(1) + (22)(1) + (10)(1) + (5)(1) + (13)(1) + (11)(1) + (6)(1) + (2)(1) + (6)(1) = 87$ inches
 (b) $D \approx (12)(1) + (22)(1) + (10)(1) + (5)(1) + (13)(1) + (11)(1) + (6)(1) + (2)(1) + (6)(1) + (0)(1) = 87$ inches

10. (a) $D \approx (1)(300) + (1.2)(300) + (1.7)(300) + (2.0)(300) + (1.8)(300) + (1.6)(300) + (1.4)(300) + (1.2)(300) + (1.0)(300) + (1.8)(300) + (1.5)(300) + (1.2)(300) = 5220$ meters (NOTE: 5 minutes = 300 seconds)
 (b) $D \approx (1.2)(300) + (1.7)(300) + (2.0)(300) + (1.8)(300) + (1.6)(300) + (1.4)(300) + (1.2)(300) + (1.0)(300) + (1.8)(300) + (1.5)(300) + (1.2)(300) + (0)(300) = 4920$ meters (NOTE: 5 minutes = 300 seconds)

11. (a) $D \approx (0)(10) + (44)(10) + (15)(10) + (35)(10) + (30)(10) + (44)(10) + (35)(10) + (15)(10) + (22)(10) + (35)(10) + (44)(10) + (30)(10) = 3490$ feet ≈ 0.66 miles
 (b) $D \approx (44)(10) + (15)(10) + (35)(10) + (30)(10) + (44)(10) + (35)(10) + (15)(10) + (22)(10) + (35)(10) + (44)(10) + (30)(10) + (35)(10) = 3840$ feet ≈ 0.73 miles

12. (a) The distance traveled will be the area under the curve. We will use the approximate velocities at the midpoints of each time interval to approximate this area using rectangles. Thus,
 $D \approx (20)(0.001) + (50)(0.001) + (72)(0.001) + (90)(0.001) + (102)(0.001) + (112)(0.001) + (120)(0.001) + (128)(0.001) + (134)(0.001) + (139)(0.001) \approx 0.967$ miles
 (b) Roughly, after 0.0063 hours, the car would have gone 0.484 miles, where 0.0060 hours = 22.7 sec. At 22.7 sec, the velocity was approximately 120 mi/hr.

13. (a) Because the acceleration is decreasing, an upper estimate is obtained using left end-points in summing acceleration $\cdot \Delta t$. Thus, $\Delta t = 1$ and speed $\approx [32.00 + 19.41 + 11.77 + 7.14 + 4.33](1) = 74.65$ ft/sec
 (b) Using right end-points we obtain a lower estimate: speed $\approx [19.41 + 11.77 + 7.14 + 4.33 + 2.63](1) = 45.28$ ft/sec
 (c) Upper estimates for the speed at each second are:

t	0	1	2	3	4	5
v	0	32.00	51.41	63.18	70.32	74.65

Thus, the distance fallen when $t = 3$ seconds is $s \approx [32.00 + 51.41 + 63.18](1) = 146.59$ ft.

14. (a) The speed is a decreasing function of time \Rightarrow right end-points give an lower estimate for the height (distance) attained. Also

t	0	1	2	3	4	5
v	400	368	336	304	272	240

gives the time-velocity table by subtracting the constant $g = 32$ from the speed at each time increment $\Delta t = 1$ sec. Thus, the speed ≈ 240 ft/sec after 5 seconds.

- (b) A lower estimate for height attained is $h \approx [368 + 336 + 304 + 272 + 240](1) = 1520$ ft.

15. Partition $[0, 2]$ into the four subintervals $[0, 0.5]$, $[0.5, 1]$, $[1, 1.5]$, and $[1.5, 2]$. The midpoints of these subintervals are $m_1 = 0.25$, $m_2 = 0.75$, $m_3 = 1.25$, and $m_4 = 1.75$. The heights of the four approximating rectangles are $f(m_1) = (0.25)^3 = \frac{1}{64}$, $f(m_2) = (0.75)^3 = \frac{27}{64}$, $f(m_3) = (1.25)^3 = \frac{125}{64}$, and $f(m_4) = (1.75)^3 = \frac{343}{64}$

Notice that the average value is approximated by $\frac{1}{2} \left[\left(\frac{1}{4}\right)^3 \left(\frac{1}{2}\right) + \left(\frac{3}{4}\right)^3 \left(\frac{1}{2}\right) + \left(\frac{5}{4}\right)^3 \left(\frac{1}{2}\right) + \left(\frac{7}{4}\right)^3 \left(\frac{1}{2}\right) \right] = \frac{31}{16}$

$= \frac{1}{\text{length of } [0,2]} \cdot \left[\begin{array}{l} \text{approximate area under} \\ \text{curve } f(x) = x^3 \end{array} \right]$. We use this observation in solving the next several exercises.

16. Partition $[1, 9]$ into the four subintervals $[1, 3]$, $[3, 5]$, $[5, 7]$, and $[7, 9]$. The midpoints of these subintervals are $m_1 = 2$, $m_2 = 4$, $m_3 = 6$, and $m_4 = 8$. The heights of the four approximating rectangles are $f(m_1) = \frac{1}{2}$, $f(m_2) = \frac{1}{4}$, $f(m_3) = \frac{1}{6}$, and $f(m_4) = \frac{1}{8}$. The width of each rectangle is $\Delta x = 2$. Thus,

$$\text{Area} \approx 2 \left(\frac{1}{2} \right) + 2 \left(\frac{1}{4} \right) + 2 \left(\frac{1}{6} \right) + 2 \left(\frac{1}{8} \right) = \frac{25}{12} \Rightarrow \text{average value} \approx \frac{\text{area}}{\text{length of } [1,9]} = \frac{\left(\frac{25}{12}\right)}{8} = \frac{25}{96}.$$

17. Partition $[0, 2]$ into the four subintervals $[0, 0.5]$, $[0.5, 1]$, $[1, 1.5]$, and $[1.5, 2]$. The midpoints of the subintervals are $m_1 = 0.25$, $m_2 = 0.75$, $m_3 = 1.25$, and $m_4 = 1.75$. The heights of the four approximating rectangles are

$$f(m_1) = \frac{1}{2} + \sin^2 \frac{\pi}{4} = \frac{1}{2} + \frac{1}{2} = 1, f(m_2) = \frac{1}{2} + \sin^2 \frac{3\pi}{4} = \frac{1}{2} + \frac{1}{2} = 1, f(m_3) = \frac{1}{2} + \sin^2 \frac{5\pi}{4} = \frac{1}{2} + \left(-\frac{1}{\sqrt{2}}\right)^2 = \frac{1}{2} + \frac{1}{2} = 1, \text{ and } f(m_4) = \frac{1}{2} + \sin^2 \frac{7\pi}{4} = \frac{1}{2} + \left(-\frac{1}{\sqrt{2}}\right)^2 = 1. \text{ The width of each rectangle is } \Delta x = \frac{1}{2}. \text{ Thus,}$$

$$\text{Area} \approx (1 + 1 + 1 + 1) \left(\frac{1}{2}\right) = 2 \Rightarrow \text{average value} \approx \frac{\text{area}}{\text{length of } [0,2]} = \frac{2}{2} = 1.$$

18. Partition $[0, 4]$ into the four subintervals $[0, 1]$, $[1, 2]$, $[2, 3]$, and $[3, 4]$. The midpoints of the subintervals are $m_1 = \frac{1}{2}$, $m_2 = \frac{3}{2}$, $m_3 = \frac{5}{2}$, and $m_4 = \frac{7}{2}$. The heights of the four approximating rectangles are

$$f(m_1) = 1 - \left(\cos \left(\frac{\pi \left(\frac{1}{2}\right)}{4}\right)\right)^4 = 1 - \left(\cos \left(\frac{\pi}{8}\right)\right)^4 = 0.27145 \text{ (to 5 decimal places),}$$

$$f(m_2) = 1 - \left(\cos \left(\frac{\pi \left(\frac{3}{2}\right)}{4}\right)\right)^4 = 1 - \left(\cos \left(\frac{3\pi}{8}\right)\right)^4 = 0.97855, f(m_3) = 1 - \left(\cos \left(\frac{\pi \left(\frac{5}{2}\right)}{4}\right)\right)^4 = 1 - \left(\cos \left(\frac{5\pi}{8}\right)\right)^4$$

$$= 0.97855, \text{ and } f(m_4) = 1 - \left(\cos \left(\frac{\pi \left(\frac{7}{2}\right)}{4}\right)\right)^4 = 1 - \left(\cos \left(\frac{7\pi}{8}\right)\right)^4 = 0.27145. \text{ The width of each rectangle is}$$

$\Delta x = 1$. Thus, $\text{Area} \approx (0.27145)(1) + (0.97855)(1) + (0.97855)(1) + (0.27145)(1) = 2.5 \Rightarrow$ average

$$\text{value} \approx \frac{\text{area}}{\text{length of } [0,4]} = \frac{2.5}{4} = \frac{5}{8}.$$

19. Since the leakage is increasing, an upper estimate uses right endpoints and a lower estimate uses left endpoints:

(a) upper estimate = $(70)(1) + (97)(1) + (136)(1) + (190)(1) + (265)(1) = 758$ gal,

lower estimate = $(50)(1) + (70)(1) + (97)(1) + (136)(1) + (190)(1) = 543$ gal.

(b) upper estimate = $(70 + 97 + 136 + 190 + 265 + 369 + 516 + 720) = 2363$ gal,

lower estimate = $(50 + 70 + 97 + 136 + 190 + 265 + 369 + 516) = 1693$ gal.

(c) worst case: $2363 + 720t = 25,000 \Rightarrow t \approx 31.4$ hrs;

best case: $1693 + 720t = 25,000 \Rightarrow t \approx 32.4$ hrs

20. Since the pollutant release increases over time, an upper estimate uses right endpoints and a lower estimate uses left endpoints:

(a) upper estimate = $(0.2)(30) + (0.25)(30) + (0.27)(30) + (0.34)(30) + (0.45)(30) + (0.52)(30) = 60.9$ tons

lower estimate = $(0.05)(30) + (0.2)(30) + (0.25)(30) + (0.27)(30) + (0.34)(30) + (0.45)(30) = 46.8$ tons

(b) Using the lower (best case) estimate: $46.8 + (0.52)(30) + (0.63)(30) + (0.70)(30) + (0.81)(30) = 126.6$ tons, so near the end of September 125 tons of pollutants will have been released.

21. (a) The diagonal of the square has length 2, so the side length is $\sqrt{2}$. Area = $(\sqrt{2})^2 = 2$

(b) Think of the octagon as a collection of 16 right triangles with a hypotenuse of length 1 and an acute angle measuring

$$\frac{2\pi}{16} = \frac{\pi}{8}.$$

$$\text{Area} = 16\left(\frac{1}{2}\right)\left(\sin \frac{\pi}{8}\right)\left(\cos \frac{\pi}{8}\right) = 4 \sin \frac{\pi}{4} = 2\sqrt{2} \approx 2.828$$

(c) Think of the 16-gon as a collection of 32 right triangles with a hypotenuse of length 1 and an acute angle measuring

$$\frac{2\pi}{32} = \frac{\pi}{16}.$$

$$\text{Area} = 32\left(\frac{1}{2}\right)\left(\sin \frac{\pi}{16}\right)\left(\cos \frac{\pi}{16}\right) = 8 \sin \frac{\pi}{8} = 2\sqrt{2} \approx 3.061$$

(d) Each area is less than the area of the circle, π . As n increases, the area approaches π .

22. (a) Each of the isosceles triangles is made up of two right triangles having hypotenuse 1 and an acute angle measuring

$$\frac{2\pi}{2n} = \frac{\pi}{n}. \text{ The area of each isosceles triangle is } A_T = 2\left(\frac{1}{2}\right)\left(\sin \frac{\pi}{n}\right)\left(\cos \frac{\pi}{n}\right) = \frac{1}{2} \sin \frac{2\pi}{n}.$$

(b) The area of the polygon is $A_P = nA_T = \frac{n}{2} \sin \frac{2\pi}{n}$, so $\lim_{n \rightarrow \infty} \frac{n}{2} \sin \frac{2\pi}{n} = \lim_{n \rightarrow \infty} \pi \cdot \frac{\sin \frac{2\pi}{n}}{(\frac{2\pi}{n})} = \pi$

(c) Multiply each area by r^2 .

$$A_T = \frac{1}{2}r^2 \sin \frac{2\pi}{n}$$

$$A_P = \frac{n}{2}r^2 \sin \frac{2\pi}{n}$$

$$\lim_{n \rightarrow \infty} A_P = \pi r^2$$

23-26. Example CAS commands:

Maple:

```
with( Student[Calculus1] );
```

```
f := x -> sin(x);
```

```
a := 0;
```

```
b := Pi;
```

```
plot( f(x), x=a..b, title="#23(a) (Section 5.1)" );
```

```
N := [ 100, 200, 1000 ]; # (b)
```

```
for n in N do
```

```
  Xlist := [ a+1.*(b-a)/n*i $ i=0..n ];
```

```
  Ylist := map( f, Xlist );
```

```
end do;
```

```
for n in N do # (c)
```

```
  Avg[n] := evalf(add(y,y=Ylist)/nops(Ylist));
```

```

end do;
avg := FunctionAverage( f(x), x=a..b, output=value );
evalf( avg );
FunctionAverage(f(x),x=a..b,output=plot); # (d)
fsolve( f(x)=avg, x=0.5 );
fsolve( f(x)=avg, x=2.5 );
fsolve( f(x)=Avg[1000], x=0.5 );
fsolve( f(x)=Avg[1000], x=2.5 );

```

Mathematica: (assigned function and values for a and b may vary):

Symbols for π , \rightarrow , powers, roots, fractions, etc. are available in Palettes (under File).

Never insert a space between the name of a function and its argument.

```

Clear[x]
f[x_]:=x Sin[1/x]
{a,b}={π/4, π}
Plot[f[x],{x, a, b}]

```

The following code computes the value of the function for each interval midpoint and then finds the average. Each sequence of commands for a different value of n (number of subdivisions) should be placed in a separate cell.

```

n=100; dx=(b-a)/n;
values=Table[N[f[x]],{x,a+dx/2,b,dx}]
average=Sum[values[[i]],{i,1,Length[values]}/n
n=200; dx=(b-a)/n;
values=Table[N[f[x]],{x,a+dx/2,b,dx}]
average=Sum[values[[i]],{i,1,Length[values]}/n
n=1000; dx=(b-a)/n;
values=Table[N[f[x]],{x,a+dx/2,b,dx}]
average=Sum[values[[i]],{i,1,Length[values]}/n
FindRoot[f[x]==average,{x,a}]

```

5.2 SIGMA NOTATION AND LIMITS OF FINITE SUMS

- $$\sum_{k=1}^2 \frac{6k}{k+1} = \frac{6(1)}{1+1} + \frac{6(2)}{2+1} = \frac{6}{2} + \frac{12}{3} = 7$$
- $$\sum_{k=1}^3 \frac{k-1}{k} = \frac{1-1}{1} + \frac{2-1}{2} + \frac{3-1}{3} = 0 + \frac{1}{2} + \frac{2}{3} = \frac{7}{6}$$
- $$\sum_{k=1}^4 \cos k\pi = \cos(1\pi) + \cos(2\pi) + \cos(3\pi) + \cos(4\pi) = -1 + 1 - 1 + 1 = 0$$
- $$\sum_{k=1}^5 \sin k\pi = \sin(1\pi) + \sin(2\pi) + \sin(3\pi) + \sin(4\pi) + \sin(5\pi) = 0 + 0 + 0 + 0 + 0 = 0$$
- $$\sum_{k=1}^3 (-1)^{k+1} \sin \frac{\pi}{k} = (-1)^{1+1} \sin \frac{\pi}{1} + (-1)^{2+1} \sin \frac{\pi}{2} + (-1)^{3+1} \sin \frac{\pi}{3} = 0 - 1 + \frac{\sqrt{3}}{2} = \frac{\sqrt{3}-2}{2}$$
- $$\begin{aligned} \sum_{k=1}^4 (-1)^k \cos k\pi &= (-1)^1 \cos(1\pi) + (-1)^2 \cos(2\pi) + (-1)^3 \cos(3\pi) + (-1)^4 \cos(4\pi) \\ &= -(-1) + 1 - (-1) + 1 = 4 \end{aligned}$$

$$7. (a) \sum_{k=1}^6 2^{k-1} = 2^{1-1} + 2^{2-1} + 2^{3-1} + 2^{4-1} + 2^{5-1} + 2^{6-1} = 1 + 2 + 4 + 8 + 16 + 32$$

$$(b) \sum_{k=0}^5 2^k = 2^0 + 2^1 + 2^2 + 2^3 + 2^4 + 2^5 = 1 + 2 + 4 + 8 + 16 + 32$$

$$(c) \sum_{k=-1}^4 2^{k+1} = 2^{-1+1} + 2^{0+1} + 2^{1+1} + 2^{2+1} + 2^{3+1} + 2^{4+1} = 1 + 2 + 4 + 8 + 16 + 32$$

All of them represent $1 + 2 + 4 + 8 + 16 + 32$

$$8. (a) \sum_{k=1}^6 (-2)^{k-1} = (-2)^{1-1} + (-2)^{2-1} + (-2)^{3-1} + (-2)^{4-1} + (-2)^{5-1} + (-2)^{6-1} = 1 - 2 + 4 - 8 + 16 - 32$$

$$(b) \sum_{k=0}^5 (-1)^k 2^k = (-1)^0 2^0 + (-1)^1 2^1 + (-1)^2 2^2 + (-1)^3 2^3 + (-1)^4 2^4 + (-1)^5 2^5 = 1 - 2 + 4 - 8 + 16 - 32$$

$$(c) \sum_{k=-2}^3 (-1)^{k+1} 2^{k+2} = (-1)^{-2+1} 2^{-2+2} + (-1)^{-1+1} 2^{-1+2} + (-1)^{0+1} 2^{0+2} + (-1)^{1+1} 2^{1+2} + (-1)^{2+1} 2^{2+2} \\ + (-1)^{3+1} 2^{3+2} = -1 + 2 - 4 + 8 - 16 + 32;$$

(a) and (b) represent $1 - 2 + 4 - 8 + 16 - 32$; (c) is not equivalent to the other two

$$9. (a) \sum_{k=2}^4 \frac{(-1)^{k-1}}{k-1} = \frac{(-1)^{2-1}}{2-1} + \frac{(-1)^{3-1}}{3-1} + \frac{(-1)^{4-1}}{4-1} = -1 + \frac{1}{2} - \frac{1}{3}$$

$$(b) \sum_{k=0}^2 \frac{(-1)^k}{k+1} = \frac{(-1)^0}{0+1} + \frac{(-1)^1}{1+1} + \frac{(-1)^2}{2+1} = 1 - \frac{1}{2} + \frac{1}{3}$$

$$(c) \sum_{k=-1}^1 \frac{(-1)^k}{k+2} = \frac{(-1)^{-1}}{-1+2} + \frac{(-1)^0}{0+2} + \frac{(-1)^1}{1+2} = -1 + \frac{1}{2} - \frac{1}{3}$$

(a) and (c) are equivalent; (b) is not equivalent to the other two.

$$10. (a) \sum_{k=1}^4 (k-1)^2 = (1-1)^2 + (2-1)^2 + (3-1)^2 + (4-1)^2 = 0 + 1 + 4 + 9$$

$$(b) \sum_{k=-1}^3 (k+1)^2 = (-1+1)^2 + (0+1)^2 + (1+1)^2 + (2+1)^2 + (3+1)^2 = 0 + 1 + 4 + 9 + 16$$

$$(c) \sum_{k=-3}^{-1} k^2 = (-3)^2 + (-2)^2 + (-1)^2 = 9 + 4 + 1$$

(a) and (c) are equivalent to each other; (b) is not equivalent to the other two.

$$11. \sum_{k=1}^6 k$$

$$12. \sum_{k=1}^4 k^2$$

$$13. \sum_{k=1}^4 \frac{1}{2^k}$$

$$14. \sum_{k=1}^5 2k$$

$$15. \sum_{k=1}^5 (-1)^{k+1} \frac{1}{k}$$

$$16. \sum_{k=1}^5 (-1)^k \frac{k}{5}$$

$$17. (a) \sum_{k=1}^n 3a_k = 3 \sum_{k=1}^n a_k = 3(-5) = -15$$

$$(b) \sum_{k=1}^n \frac{b_k}{6} = \frac{1}{6} \sum_{k=1}^n b_k = \frac{1}{6}(6) = 1$$

$$(c) \sum_{k=1}^n (a_k + b_k) = \sum_{k=1}^n a_k + \sum_{k=1}^n b_k = -5 + 6 = 1$$

$$(d) \sum_{k=1}^n (a_k - b_k) = \sum_{k=1}^n a_k - \sum_{k=1}^n b_k = -5 - 6 = -11$$

$$(e) \sum_{k=1}^n (b_k - 2a_k) = \sum_{k=1}^n b_k - 2 \sum_{k=1}^n a_k = 6 - 2(-5) = 16$$

18. (a) $\sum_{k=1}^n 8a_k = 8 \sum_{k=1}^n a_k = 8(0) = 0$

(b) $\sum_{k=1}^n 250b_k = 250 \sum_{k=1}^n b_k = 250(1) = 250$

(c) $\sum_{k=1}^n (a_k + 1) = \sum_{k=1}^n a_k + \sum_{k=1}^n 1 = 0 + n = n$

(d) $\sum_{k=1}^n (b_k - 1) = \sum_{k=1}^n b_k - \sum_{k=1}^n 1 = 1 - n$

19. (a) $\sum_{k=1}^{10} k = \frac{10(10+1)}{2} = 55$

(b) $\sum_{k=1}^{10} k^2 = \frac{10(10+1)(2(10)+1)}{6} = 385$

(c) $\sum_{k=1}^{10} k^3 = \left[\frac{10(10+1)}{2} \right]^2 = 55^2 = 3025$

20. (a) $\sum_{k=1}^{13} k = \frac{13(13+1)}{2} = 91$

(b) $\sum_{k=1}^{13} k^2 = \frac{13(13+1)(2(13)+1)}{6} = 819$

(c) $\sum_{k=1}^{13} k^3 = \left[\frac{13(13+1)}{2} \right]^2 = 91^2 = 8281$

21. $\sum_{k=1}^7 -2k = -2 \sum_{k=1}^7 k = -2 \left(\frac{7(7+1)}{2} \right) = -56$

22. $\sum_{k=1}^5 \frac{\pi k}{15} = \frac{\pi}{15} \sum_{k=1}^5 k = \frac{\pi}{15} \left(\frac{5(5+1)}{2} \right) = \pi$

23. $\sum_{k=1}^6 (3 - k^2) = \sum_{k=1}^6 3 - \sum_{k=1}^6 k^2 = 3(6) - \frac{6(6+1)(2(6)+1)}{6} = -73$

24. $\sum_{k=1}^6 (k^2 - 5) = \sum_{k=1}^6 k^2 - \sum_{k=1}^6 5 = \frac{6(6+1)(2(6)+1)}{6} - 5(6) = 61$

25. $\sum_{k=1}^5 k(3k + 5) = \sum_{k=1}^5 (3k^2 + 5k) = 3 \sum_{k=1}^5 k^2 + 5 \sum_{k=1}^5 k = 3 \left(\frac{5(5+1)(2(5)+1)}{6} \right) + 5 \left(\frac{5(5+1)}{2} \right) = 240$

26. $\sum_{k=1}^7 k(2k + 1) = \sum_{k=1}^7 (2k^2 + k) = 2 \sum_{k=1}^7 k^2 + \sum_{k=1}^7 k = 2 \left(\frac{7(7+1)(2(7)+1)}{6} \right) + \frac{7(7+1)}{2} = 308$

27. $\sum_{k=1}^5 \frac{k^3}{225} + \left(\sum_{k=1}^5 k \right)^3 = \frac{1}{225} \sum_{k=1}^5 k^3 + \left(\sum_{k=1}^5 k \right)^3 = \frac{1}{225} \left(\frac{5(5+1)(2(5)+1)}{6} \right)^2 + \left(\frac{5(5+1)}{2} \right)^3 = 3376$

28. $\left(\sum_{k=1}^7 k \right)^2 - \sum_{k=1}^7 \frac{k^3}{4} = \left(\sum_{k=1}^7 k \right)^2 - \frac{1}{4} \sum_{k=1}^7 k^3 = \left(\frac{7(7+1)}{2} \right)^2 - \frac{1}{4} \left(\frac{7(7+1)(2(7)+1)}{6} \right)^2 = 588$

29. (a)

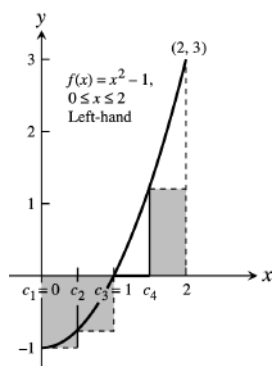

(b)

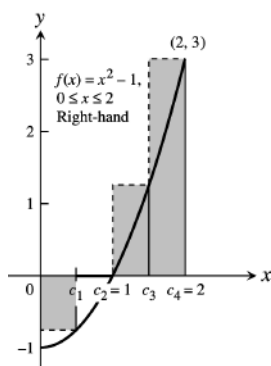

(c)

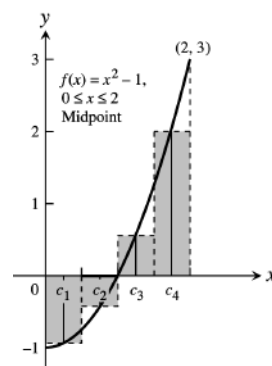

30. (a)

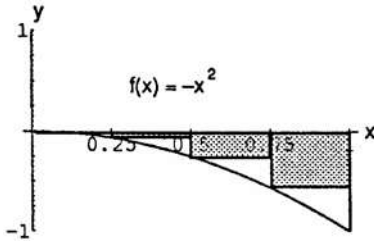

(b)

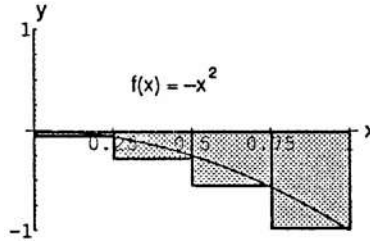

(c)

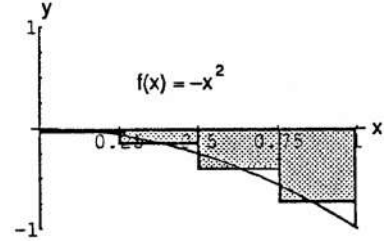

31. (a)

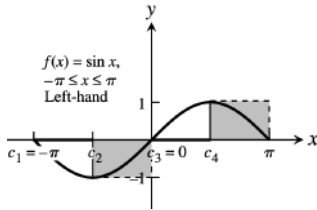

(b)

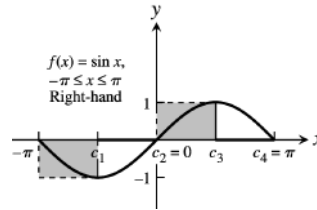

(c)

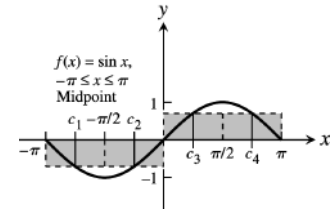

32. (a)

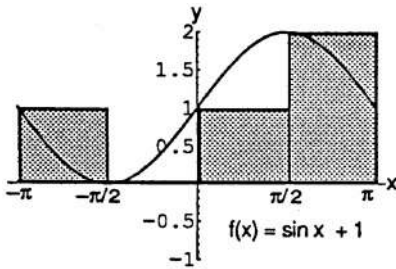

(b)

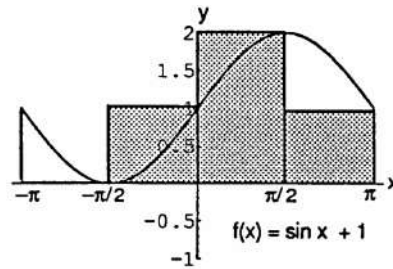

(c)

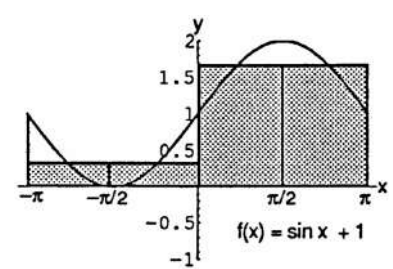

33. $|x_1 - x_0| = |1.2 - 0| = 1.2$, $|x_2 - x_1| = |1.5 - 1.2| = 0.3$, $|x_3 - x_2| = |2.3 - 1.5| = 0.8$, $|x_4 - x_3| = |2.6 - 2.3| = 0.3$, and $|x_5 - x_4| = |3 - 2.6| = 0.4$; the largest is $\|P\| = 1.2$.

34. $|x_1 - x_0| = |-1.6 - (-2)| = 0.4$, $|x_2 - x_1| = |-0.5 - (-1.6)| = 1.1$, $|x_3 - x_2| = |0 - (-0.5)| = 0.5$, $|x_4 - x_3| = |0.8 - 0| = 0.8$, and $|x_5 - x_4| = |1 - 0.8| = 0.2$; the largest is $\|P\| = 1.1$.

35. $f(x) = 1 - x^2$

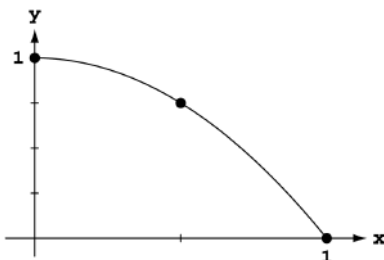

Since f is decreasing on $[0, 1]$ we use left endpoints to obtain upper sums. $\Delta x = \frac{1-0}{n} = \frac{1}{n}$ and $x_i = i\Delta x = \frac{i}{n}$. So an upper sum

$$\text{is } \sum_{i=0}^{n-1} (1 - x_i^2) \frac{1}{n} = \frac{1}{n} \sum_{i=0}^{n-1} \left(1 - \left(\frac{i}{n}\right)^2\right) = \frac{1}{n^2} \sum_{i=0}^{n-1} (n^2 - i^2)$$

$$= \frac{n^3}{n^2} - \frac{1}{n^2} \sum_{i=0}^{n-1} i^2 = 1 - \frac{(n-1)n(2(n-1)+1)}{6n^2} = 1 - \frac{2n^3 - 3n^2 + n}{6n^2}$$

$$= 1 - \frac{2 - \frac{3}{n} + \frac{1}{n^2}}{6}. \text{ Thus,}$$

$$\lim_{n \rightarrow \infty} \sum_{i=0}^{n-1} (1 - x_i^2) \frac{1}{n} = \lim_{n \rightarrow \infty} \left(1 - \frac{2 - \frac{3}{n} + \frac{1}{n^2}}{6}\right) = 1 - \frac{1}{3} = \frac{2}{3}$$

36. $f(x) = 2x$

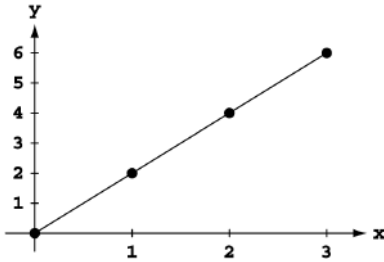

Since f is increasing on $[0, 3]$ we use right endpoints to obtain upper sums. $\Delta x = \frac{3-0}{n} = \frac{3}{n}$ and $x_i = i\Delta x = \frac{3i}{n}$. So an upper sum is $\sum_{i=1}^n 2x_i \left(\frac{3}{n}\right) = \sum_{i=1}^n \frac{6i}{n} \cdot \frac{3}{n} = \frac{18}{n^2} \sum_{i=1}^n i = \frac{18}{n^2} \cdot \frac{n(n+1)}{2} = \frac{9n^2+9n}{n^2}$

$$\text{Thus, } \lim_{n \rightarrow \infty} \sum_{i=1}^n \frac{6i}{n} \cdot \frac{3}{n} = \lim_{n \rightarrow \infty} \frac{9n^2+9n}{n^2} = \lim_{n \rightarrow \infty} \left(9 + \frac{9}{n}\right) = 9.$$

37. $f(x) = x^2 + 1$

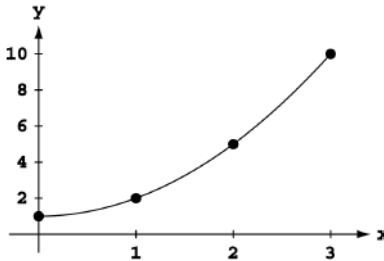

Since f is increasing on $[0, 3]$ we use right endpoints to obtain upper sums. $\Delta x = \frac{3-0}{n} = \frac{3}{n}$ and $x_i = i\Delta x = \frac{3i}{n}$. So an upper sum is $\sum_{i=1}^n (x_i^2 + 1) \frac{3}{n} = \sum_{i=1}^n \left(\left(\frac{3i}{n}\right)^2 + 1\right) \frac{3}{n} = \frac{3}{n} \sum_{i=1}^n \left(\frac{9i^2}{n^2} + 1\right)$

$$= \frac{27}{n} \sum_{i=1}^n i^2 + \frac{3}{n} \cdot n = \frac{27}{n^3} \left(\frac{n(n+1)(2n+1)}{6}\right) + 3$$

$$= \frac{9(2n^3+3n^2+n)}{2n^3} + 3 = \frac{18 + \frac{27}{n} + \frac{9}{n^2}}{2} + 3. \text{ Thus,}$$

$$\lim_{n \rightarrow \infty} \sum_{i=1}^n (x_i^2 + 1) \frac{3}{n} = \lim_{n \rightarrow \infty} \left(\frac{18 + \frac{27}{n} + \frac{9}{n^2}}{2} + 3\right) = 9 + 3 = 12.$$

38. $f(x) = 3x^2$

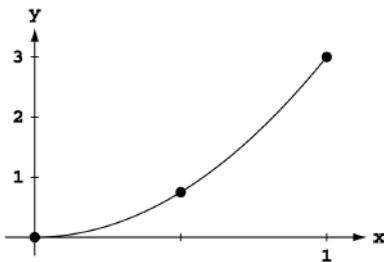

Since f is increasing on $[0, 1]$ we use right endpoints to obtain upper sums. $\Delta x = \frac{1-0}{n} = \frac{1}{n}$ and $x_i = i\Delta x = \frac{i}{n}$. So an upper sum is $\sum_{i=1}^n 3x_i^2 \left(\frac{1}{n}\right) = \sum_{i=1}^n 3\left(\frac{i}{n}\right)^2 \left(\frac{1}{n}\right) = \frac{3}{n^3} \sum_{i=1}^n i^2 = \frac{3}{n^3} \cdot \left(\frac{n(n+1)(2n+1)}{6}\right)$

$$= \frac{2n^3+3n^2+n}{2n^3} = \frac{2 + \frac{3}{n} + \frac{1}{n^2}}{2}. \text{ Thus, } \lim_{n \rightarrow \infty} \sum_{i=1}^n 3x_i^2 \left(\frac{1}{n}\right)$$

$$= \lim_{n \rightarrow \infty} \left(\frac{2 + \frac{3}{n} + \frac{1}{n^2}}{2}\right) = \frac{2}{2} = 1.$$

39. $f(x) = x + x^2 = x(1+x)$

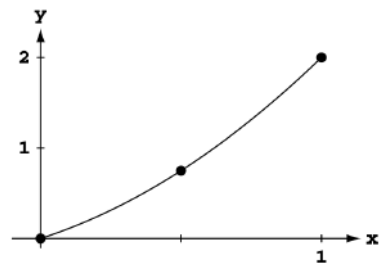

Since f is increasing on $[0, 1]$ we use right endpoints to obtain upper sums. $\Delta x = \frac{1-0}{n} = \frac{1}{n}$ and $x_i = i\Delta x = \frac{i}{n}$. So an upper sum is $\sum_{i=1}^n (x_i + x_i^2) \frac{1}{n} = \sum_{i=1}^n \left(\frac{i}{n} + \left(\frac{i}{n}\right)^2\right) \frac{1}{n} = \frac{1}{n^2} \sum_{i=1}^n i + \frac{1}{n^3} \sum_{i=1}^n i^2$

$$= \frac{1}{n^2} \left(\frac{n(n+1)}{2}\right) + \frac{1}{n^3} \left(\frac{n(n+1)(2n+1)}{6}\right) = \frac{n^2+n}{2n^2} + \frac{2n^3+3n^2+n}{6n^3}$$

$$= \frac{1+\frac{1}{n}}{2} + \frac{2+\frac{3}{n}+\frac{1}{n^2}}{6}. \text{ Thus, } \lim_{n \rightarrow \infty} \sum_{i=1}^n (x_i + x_i^2) \frac{1}{n}$$

$$= \lim_{n \rightarrow \infty} \left[\left(\frac{1+\frac{1}{n}}{2}\right) + \left(\frac{2+\frac{3}{n}+\frac{1}{n^2}}{6}\right)\right] = \frac{1}{2} + \frac{2}{6} = \frac{5}{6}.$$

40. $f(x) = 3x + 2x^2$

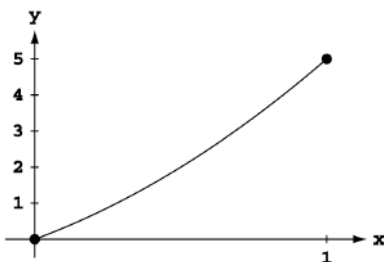

Since f is increasing on $[0, 1]$ we use right endpoints to obtain upper sums. $\Delta x = \frac{1-0}{n} = \frac{1}{n}$ and $x_i = i\Delta x = \frac{i}{n}$. So an upper sum is $\sum_{i=1}^n (3x_i + 2x_i^2) \frac{1}{n} = \sum_{i=1}^n \left(\frac{3i}{n} + 2\left(\frac{i}{n}\right)^2\right) \frac{1}{n} = \frac{3}{n^2} \sum_{i=1}^n i + \frac{2}{n^3} \sum_{i=1}^n i^2$

$$= \frac{3}{n^2} \left(\frac{n(n+1)}{2}\right) + \frac{2}{n^3} \left(\frac{n(n+1)(2n+1)}{6}\right) = \frac{3n^2+3n}{2n^2} + \frac{2n^2+3n+1}{3n^2}$$

$$= \frac{3+\frac{3}{n}}{2} + \frac{2+\frac{3}{n}+\frac{1}{n^2}}{3}. \text{ Thus, } \lim_{n \rightarrow \infty} \sum_{i=1}^n (3x_i + 2x_i^2) \frac{1}{n}$$

$$= \lim_{n \rightarrow \infty} \left[\left(\frac{3+\frac{3}{n}}{2}\right) + \left(\frac{2+\frac{3}{n}+\frac{1}{n^2}}{3}\right)\right] = \frac{3}{2} + \frac{2}{3} = \frac{13}{6}.$$

5.3 THE DEFINITE INTEGRAL

1. $\int_0^2 x^2 dx$
 2. $\int_{-1}^0 2x^3 dx$
 3. $\int_{-7}^5 (x^2 - 3x) dx$
 4. $\int_1^4 \frac{1}{x} dx$
 5. $\int_2^3 \frac{1}{1-x} dx$
 6. $\int_0^1 \sqrt{4-x^2} dx$
 7. $\int_{-\pi/4}^0 (\sec x) dx$
 8. $\int_0^{\pi/4} (\tan x) dx$
9. (a) $\int_2^2 g(x) dx = 0$ (b) $\int_5^1 g(x) dx = -\int_1^5 g(x) dx = -8$
 (c) $\int_1^2 3f(x) dx = 3 \int_1^2 f(x) dx = 3(-4) = -12$ (d) $\int_2^5 f(x) dx = \int_1^5 f(x) dx - \int_1^2 f(x) dx = 6 - (-4) = 10$
 (e) $\int_1^5 [f(x) - g(x)] dx = \int_1^5 f(x) dx - \int_1^5 g(x) dx = 6 - 8 = -2$
 (f) $\int_1^5 [4f(x) - g(x)] dx = 4 \int_1^5 f(x) dx - \int_1^5 g(x) dx = 4(6) - 8 = 16$
 10. (a) $\int_1^9 -2f(x) dx = -2 \int_1^9 f(x) dx = -2(-1) = 2$
 (b) $\int_7^9 [f(x) + h(x)] dx = \int_7^9 f(x) dx + \int_7^9 h(x) dx = 5 + 4 = 9$
 (c) $\int_7^9 [2f(x) - 3h(x)] dx = 2 \int_7^9 f(x) dx - 3 \int_7^9 h(x) dx = 2(5) - 3(4) = -2$
 (d) $\int_9^1 f(x) dx = -\int_1^9 f(x) dx = -(-1) = 1$
 (e) $\int_1^7 f(x) dx = \int_1^9 f(x) dx - \int_7^9 f(x) dx = -1 - 5 = -6$
 (f) $\int_9^7 [h(x) - f(x)] dx = \int_7^9 [f(x) - h(x)] dx = \int_7^9 f(x) dx - \int_7^9 h(x) dx = 5 - 4 = 1$
 11. (a) $\int_1^2 f(u) du = \int_1^2 f(x) dx = 5$ (b) $\int_1^2 \sqrt{3} f(z) dz = \sqrt{3} \int_1^2 f(z) dz = 5\sqrt{3}$
 (c) $\int_2^1 f(t) dt = -\int_1^2 f(t) dt = -5$ (d) $\int_1^2 [-f(x)] dx = -\int_1^2 f(x) dx = -5$
 12. (a) $\int_0^{-3} g(t) dt = -\int_{-3}^0 g(t) dt = -\sqrt{2}$ (b) $\int_{-3}^0 g(u) du = \int_{-3}^0 g(t) dt = \sqrt{2}$
 (c) $\int_{-3}^0 [-g(x)] dx = -\int_{-3}^0 g(x) dx = -\sqrt{2}$ (d) $\int_{-3}^0 \frac{g(r)}{\sqrt{2}} dr = \frac{1}{\sqrt{2}} \int_{-3}^0 g(t) dt = \left(\frac{1}{\sqrt{2}}\right) (\sqrt{2}) = 1$
 13. (a) $\int_3^4 f(z) dz = \int_0^4 f(z) dz - \int_0^3 f(z) dz = 7 - 3 = 4$
 (b) $\int_4^3 f(t) dt = -\int_3^4 f(t) dt = -4$
 14. (a) $\int_1^3 h(r) dr = \int_{-1}^3 h(r) dr - \int_{-1}^1 h(r) dr = 6 - 0 = 6$
 (b) $-\int_3^1 h(u) du = -\left(-\int_1^3 h(u) du\right) = \int_1^3 h(u) du = 6$

15. The area of the trapezoid is $A = \frac{1}{2}(B + b)h$
 $= \frac{1}{2}(5 + 2)(6) = 21 \Rightarrow \int_{-2}^4 \left(\frac{x}{2} + 3\right) dx$
 $= 21$ square units

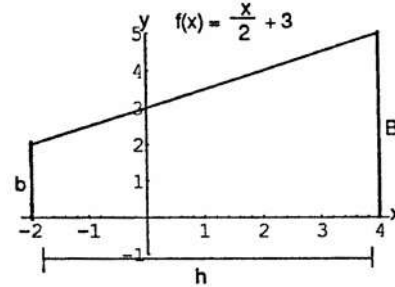

16. The area of the trapezoid is $A = \frac{1}{2}(B + b)h$
 $= \frac{1}{2}(3 + 1)(1) = 2 \Rightarrow \int_{1/2}^{3/2} (-2x + 4) dx$
 $= 2$ square units

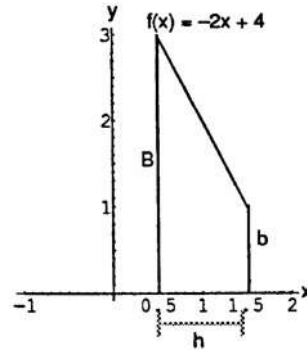

17. The area of the semicircle is $A = \frac{1}{2}\pi r^2 = \frac{1}{2}\pi(3)^2$
 $= \frac{9}{2}\pi \Rightarrow \int_{-3}^3 \sqrt{9 - x^2} dx = \frac{9}{2}\pi$ square units

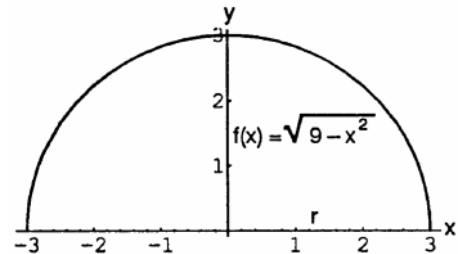

18. The graph of the quarter circle is $A = \frac{1}{4}\pi r^2 = \frac{1}{4}\pi(4)^2$
 $= 4\pi \Rightarrow \int_{-4}^0 \sqrt{16 - x^2} dx = 4\pi$ square units

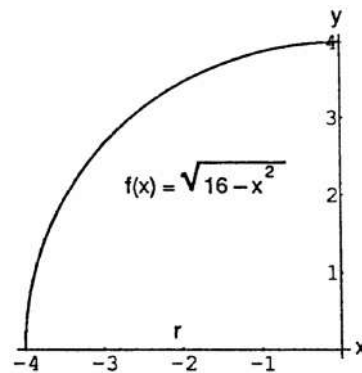

19. The area of the triangle on the left is $A = \frac{1}{2}bh = \frac{1}{2}(2)(2) = 2$. The area of the triangle on the right is $A = \frac{1}{2}bh = \frac{1}{2}(1)(1) = \frac{1}{2}$. Then, the total area is 2.5
 $\Rightarrow \int_{-2}^1 |x| dx = 2.5$ square units

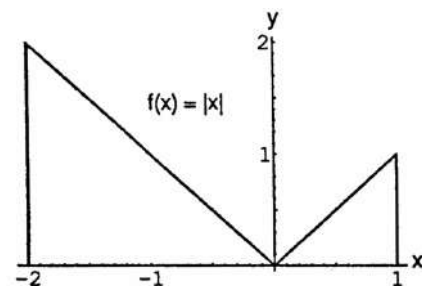

20. The area of the triangle is $A = \frac{1}{2}bh = \frac{1}{2}(2)(1) = 1$

$$\Rightarrow \int_{-1}^1 (1 - |x|) dx = 1 \text{ square unit}$$

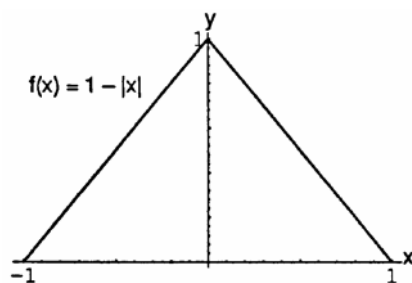

21. The area of the triangular peak is $A = \frac{1}{2}bh = \frac{1}{2}(2)(1) = 1$.

The area of the rectangular base is $S = \ell w = (2)(1) = 2$.

Then the total area is $3 \Rightarrow \int_{-1}^1 (2 - |x|) dx = 3$ square units

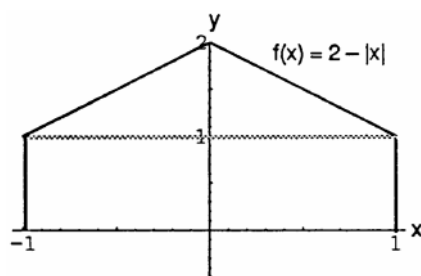

22. $y = 1 + \sqrt{1 - x^2} \Rightarrow y - 1 = \sqrt{1 - x^2}$

$\Rightarrow (y - 1)^2 = 1 - x^2 \Rightarrow x^2 + (y - 1)^2 = 1$, a circle with

center $(0, 1)$ and radius of 1 $\Rightarrow y = 1 + \sqrt{1 - x^2}$ is the upper semicircle. The area of this semicircle is

$A = \frac{1}{2}\pi r^2 = \frac{1}{2}\pi(1)^2 = \frac{\pi}{2}$. The area of the rectangular base is $A = \ell w = (2)(1) = 2$. Then the total area is $2 + \frac{\pi}{2}$

$$\Rightarrow \int_{-1}^1 (1 + \sqrt{1 - x^2}) dx = 2 + \frac{\pi}{2} \text{ square units}$$

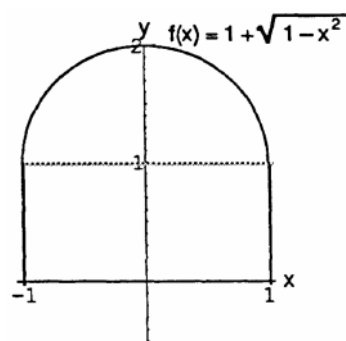

$$23. \int_0^b \frac{x}{2} dx = \frac{1}{2}(b)(\frac{b}{2}) = \frac{b^2}{4}$$

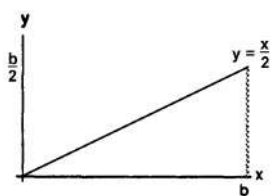

$$24. \int_0^b 4x dx = \frac{1}{2}b(4b) = 2b^2$$

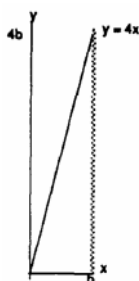

$$25. \int_a^b 2s \, ds = \frac{1}{2} b(2b) - \frac{1}{2} a(2a) = b^2 - a^2$$

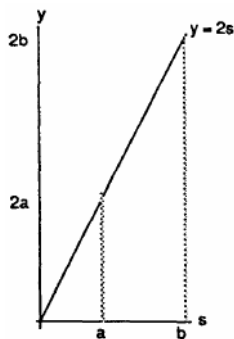

$$26. \int_a^b 3t \, dt = \frac{1}{2} b(3b) - \frac{1}{2} a(3a) = \frac{3}{2} (b^2 - a^2)$$

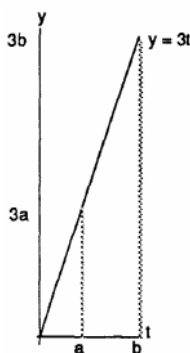

$$27. \int_1^{\sqrt{2}} x \, dx = \frac{(\sqrt{2})^2}{2} - \frac{(1)^2}{2} = \frac{1}{2}$$

$$28. \int_{0.5}^{2.5} x \, dx = \frac{(2.5)^2}{2} - \frac{(0.5)^2}{2} = 3$$

$$29. \int_{\pi}^{2\pi} \theta \, d\theta = \frac{(2\pi)^2}{2} - \frac{\pi^2}{2} = \frac{3\pi^2}{2}$$

$$30. \int_{\sqrt{2}}^{5\sqrt{2}} r \, dr = \frac{(5\sqrt{2})^2}{2} - \frac{(\sqrt{2})^2}{2} = 24$$

$$31. \int_0^{\sqrt[3]{7}} x^2 \, dx = \frac{(\sqrt[3]{7})^3}{3} = \frac{7}{3}$$

$$32. \int_0^{0.3} s^2 \, ds = \frac{(0.3)^3}{3} = 0.009$$

$$33. \int_0^{1/2} t^2 \, dt = \frac{(\frac{1}{2})^3}{3} = \frac{1}{24}$$

$$34. \int_0^{\pi/2} \theta^2 \, d\theta = \frac{(\frac{\pi}{2})^3}{3} = \frac{\pi^3}{24}$$

$$35. \int_a^{2a} x \, dx = \frac{(2a)^2}{2} - \frac{a^2}{2} = \frac{3a^2}{2}$$

$$36. \int_a^{\sqrt{3}a} x \, dx = \frac{(\sqrt{3}a)^2}{2} - \frac{a^2}{2} = a^2$$

$$37. \int_0^{\sqrt[3]{b}} x^2 \, dx = \frac{(\sqrt[3]{b})^3}{3} = \frac{b}{3}$$

$$38. \int_0^{3b} x^2 \, dx = \frac{(3b)^3}{3} = 9b^3$$

$$39. \int_3^1 7 \, dx = 7(1 - 3) = -14$$

$$40. \int_0^{-2} \sqrt{2} \, dx = \sqrt{2}(-2 - 0) = -2\sqrt{2}$$

$$41. \int_0^2 5x \, dx = 5 \int_0^2 x \, dx = 5 \left[\frac{2^2}{2} - \frac{0^2}{2} \right] = 10$$

$$42. \int_3^5 \frac{x}{8} \, dx = \frac{1}{8} \int_3^5 x \, dx = \frac{1}{8} \left[\frac{5^2}{2} - \frac{3^2}{2} \right] = \frac{16}{16} = 1$$

$$43. \int_0^2 (2t - 3) \, dt = 2 \int_0^2 t \, dt - \int_0^2 3 \, dt = 2 \left[\frac{2^2}{2} - \frac{0^2}{2} \right] - 3(2 - 0) = 4 - 6 = -2$$

$$44. \int_0^{\sqrt{2}} (t - \sqrt{2}) \, dt = \int_0^{\sqrt{2}} t \, dt - \int_0^{\sqrt{2}} \sqrt{2} \, dt = \left[\frac{(\sqrt{2})^2}{2} - \frac{0^2}{2} \right] - \sqrt{2} [\sqrt{2} - 0] = 1 - 2 = -1$$

$$45. \int_2^1 \left(1 + \frac{z}{2}\right) \, dz = \int_2^1 1 \, dz + \int_2^1 \frac{z}{2} \, dz = \int_2^1 1 \, dz - \frac{1}{2} \int_1^2 z \, dz = 1[1 - 2] - \frac{1}{2} \left[\frac{2^2}{2} - \frac{1^2}{2} \right] = -1 - \frac{1}{2} \left(\frac{3}{2} \right) = -\frac{7}{4}$$

$$46. \int_3^0 (2z - 3) \, dz = \int_3^0 2z \, dz - \int_3^0 3 \, dz = -2 \int_0^3 z \, dz - \int_3^0 3 \, dz = -2 \left[\frac{3^2}{2} - \frac{0^2}{2} \right] - 3[0 - 3] = -9 + 9 = 0$$

$$47. \int_1^2 3u^2 \, du = 3 \int_1^2 u^2 \, du = 3 \left[\int_0^2 u^2 \, du - \int_0^1 u^2 \, du \right] = 3 \left(\left[\frac{2^3}{3} - \frac{0^3}{3} \right] - \left[\frac{1^3}{3} - \frac{0^3}{3} \right] \right) = 3 \left[\frac{2^3}{3} - \frac{1^3}{3} \right] = 3 \left(\frac{7}{3} \right) = 7$$

$$48. \int_{1/2}^1 24u^2 \, du = 24 \int_{1/2}^1 u^2 \, du = 24 \left[\int_0^1 u^2 \, du - \int_0^{1/2} u^2 \, du \right] = 24 \left[\frac{1}{3} - \frac{(\frac{1}{2})^3}{3} \right] = 24 \left[\frac{(\frac{7}{8})}{3} \right] = 7$$

$$49. \int_0^2 (3x^2 + x - 5) \, dx = 3 \int_0^2 x^2 \, dx + \int_0^2 x \, dx - \int_0^2 5 \, dx = 3 \left[\frac{2^3}{3} - \frac{0^3}{3} \right] + \left[\frac{2^2}{2} - \frac{0^2}{2} \right] - 5[2 - 0] = (8 + 2) - 10 = 0$$

$$50. \int_1^0 (3x^2 + x - 5) \, dx = - \int_0^1 (3x^2 + x - 5) \, dx = - \left[3 \int_0^1 x^2 \, dx + \int_0^1 x \, dx - \int_0^1 5 \, dx \right]$$

$$= - \left[3 \left(\frac{1^3}{3} - \frac{0^3}{3} \right) + \left(\frac{1^2}{2} - \frac{0^2}{2} \right) - 5(1 - 0) \right] = - \left(\frac{3}{2} - 5 \right) = \frac{7}{2}$$

51. Let $\Delta x = \frac{b-0}{n} = \frac{b}{n}$ and let $x_0 = 0, x_1 = \Delta x,$
 $x_2 = 2\Delta x, \dots, x_{n-1} = (n-1)\Delta x, x_n = n\Delta x = b.$
 Let the c_k 's be the right end-points of the subintervals
 $\Rightarrow c_1 = x_1, c_2 = x_2,$ and so on. The rectangles
 defined have areas:

$$f(c_1) \Delta x = f(\Delta x) \Delta x = 3(\Delta x)^2 \Delta x = 3(\Delta x)^3$$

$$f(c_2) \Delta x = f(2\Delta x) \Delta x = 3(2\Delta x)^2 \Delta x = 3(2)^2(\Delta x)^3$$

$$f(c_3) \Delta x = f(3\Delta x) \Delta x = 3(3\Delta x)^2 \Delta x = 3(3)^2(\Delta x)^3$$

$$\vdots$$

$$f(c_n) \Delta x = f(n\Delta x) \Delta x = 3(n\Delta x)^2 \Delta x = 3(n)^2(\Delta x)^3$$

$$\text{Then } S_n = \sum_{k=1}^n f(c_k) \Delta x = \sum_{k=1}^n 3k^2(\Delta x)^3$$

$$= 3(\Delta x)^3 \sum_{k=1}^n k^2 = 3 \left(\frac{b^3}{n^3} \right) \left(\frac{n(n+1)(2n+1)}{6} \right)$$

$$= \frac{b^3}{2} \left(2 + \frac{3}{n} + \frac{1}{n^2} \right) \Rightarrow \int_0^b 3x^2 \, dx = \lim_{n \rightarrow \infty} \frac{b^3}{2} \left(2 + \frac{3}{n} + \frac{1}{n^2} \right) = b^3.$$

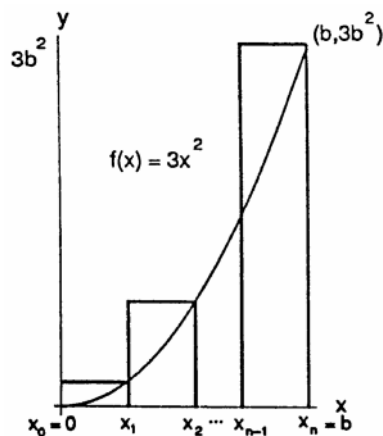

52. Let $\Delta x = \frac{b-0}{n} = \frac{b}{n}$ and let $x_0 = 0, x_1 = \Delta x,$
 $x_2 = 2\Delta x, \dots, x_{n-1} = (n-1)\Delta x, x_n = n\Delta x = b.$
 Let the c_k 's be the right end-points of the subintervals
 $\Rightarrow c_1 = x_1, c_2 = x_2,$ and so on. The rectangles
 defined have areas:

$$f(c_1) \Delta x = f(\Delta x) \Delta x = \pi(\Delta x)^2 \Delta x = \pi(\Delta x)^3$$

$$f(c_2) \Delta x = f(2\Delta x) \Delta x = \pi(2\Delta x)^2 \Delta x = \pi(2)^2(\Delta x)^3$$

$$f(c_3) \Delta x = f(3\Delta x) \Delta x = \pi(3\Delta x)^2 \Delta x = \pi(3)^2(\Delta x)^3$$

$$\vdots$$

$$f(c_n) \Delta x = f(n\Delta x) \Delta x = \pi(n\Delta x)^2 \Delta x = \pi(n)^2(\Delta x)^3$$

$$\text{Then } S_n = \sum_{k=1}^n f(c_k) \Delta x = \sum_{k=1}^n \pi k^2(\Delta x)^3$$

$$= \pi(\Delta x)^3 \sum_{k=1}^n k^2 = \pi \left(\frac{b^3}{n^3} \right) \left(\frac{n(n+1)(2n+1)}{6} \right)$$

$$= \frac{\pi b^3}{6} \left(2 + \frac{3}{n} + \frac{1}{n^2} \right) \Rightarrow \int_0^b \pi x^2 \, dx = \lim_{n \rightarrow \infty} \frac{\pi b^3}{6} \left(2 + \frac{3}{n} + \frac{1}{n^2} \right) = \frac{\pi b^3}{3}.$$

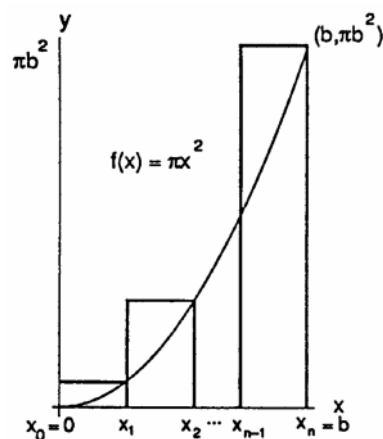

53. Let $\Delta x = \frac{b-0}{n} = \frac{b}{n}$ and let $x_0 = 0, x_1 = \Delta x,$
 $x_2 = 2\Delta x, \dots, x_{n-1} = (n-1)\Delta x, x_n = n\Delta x = b.$

Let the c_k 's be the right end-points of the subintervals
 $\Rightarrow c_1 = x_1, c_2 = x_2,$ and so on. The rectangles
 defined have areas:

$$\begin{aligned} f(c_1) \Delta x &= f(\Delta x) \Delta x = 2(\Delta x)(\Delta x) = 2(\Delta x)^2 \\ f(c_2) \Delta x &= f(2\Delta x) \Delta x = 2(2\Delta x)(\Delta x) = 2(2)(\Delta x)^2 \\ f(c_3) \Delta x &= f(3\Delta x) \Delta x = 2(3\Delta x)(\Delta x) = 2(3)(\Delta x)^2 \\ &\vdots \\ f(c_n) \Delta x &= f(n\Delta x) \Delta x = 2(n\Delta x)(\Delta x) = 2(n)(\Delta x)^2 \end{aligned}$$

$$\begin{aligned} \text{Then } S_n &= \sum_{k=1}^n f(c_k) \Delta x = \sum_{k=1}^n 2k(\Delta x)^2 \\ &= 2(\Delta x)^2 \sum_{k=1}^n k = 2 \left(\frac{b^2}{n^2} \right) \left(\frac{n(n+1)}{2} \right) \\ &= b^2 \left(1 + \frac{1}{n} \right) \Rightarrow \int_0^b 2x \, dx = \lim_{n \rightarrow \infty} b^2 \left(1 + \frac{1}{n} \right) = b^2. \end{aligned}$$

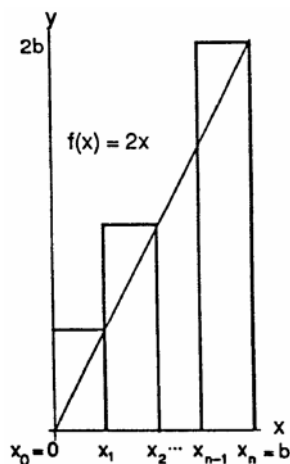

54. Let $\Delta x = \frac{b-0}{n} = \frac{b}{n}$ and let $x_0 = 0, x_1 = \Delta x,$
 $x_2 = 2\Delta x, \dots, x_{n-1} = (n-1)\Delta x, x_n = n\Delta x = b.$

Let the c_k 's be the right end-points of the subintervals
 $\Rightarrow c_1 = x_1, c_2 = x_2,$ and so on. The rectangles
 defined have areas:

$$\begin{aligned} f(c_1) \Delta x &= f(\Delta x) \Delta x = \left(\frac{\Delta x}{2} + 1 \right) (\Delta x) = \frac{1}{2} (\Delta x)^2 + \Delta x \\ f(c_2) \Delta x &= f(2\Delta x) \Delta x = \left(\frac{2\Delta x}{2} + 1 \right) (\Delta x) = \frac{1}{2} (2)(\Delta x)^2 + \Delta x \\ f(c_3) \Delta x &= f(3\Delta x) \Delta x = \left(\frac{3\Delta x}{2} + 1 \right) (\Delta x) = \frac{1}{2} (3)(\Delta x)^2 + \Delta x \\ &\vdots \\ f(c_n) \Delta x &= f(n\Delta x) \Delta x = \left(\frac{n\Delta x}{2} + 1 \right) (\Delta x) = \frac{1}{2} (n)(\Delta x)^2 + \Delta x \end{aligned}$$

$$\begin{aligned} \text{Then } S_n &= \sum_{k=1}^n f(c_k) \Delta x = \sum_{k=1}^n \left(\frac{1}{2} k(\Delta x)^2 + \Delta x \right) = \frac{1}{2} (\Delta x)^2 \sum_{k=1}^n k + \Delta x \sum_{k=1}^n 1 = \frac{1}{2} \left(\frac{b^2}{n^2} \right) \left(\frac{n(n+1)}{2} \right) + \left(\frac{b}{n} \right) (n) \\ &= \frac{1}{4} b^2 \left(1 + \frac{1}{n} \right) + b \Rightarrow \int_0^b \left(\frac{x}{2} + 1 \right) dx = \lim_{n \rightarrow \infty} \left(\frac{1}{4} b^2 \left(1 + \frac{1}{n} \right) + b \right) = \frac{1}{4} b^2 + b. \end{aligned}$$

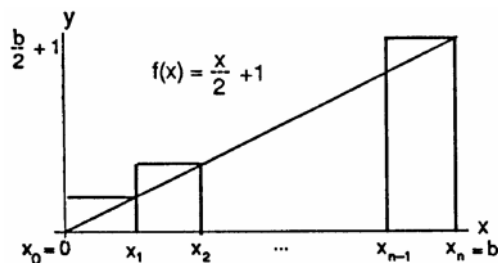

55.
$$\begin{aligned} \text{av}(f) &= \left(\frac{1}{\sqrt{3}-0} \right) \int_0^{\sqrt{3}} (x^2 - 1) \, dx \\ &= \frac{1}{\sqrt{3}} \int_0^{\sqrt{3}} x^2 \, dx - \frac{1}{\sqrt{3}} \int_0^{\sqrt{3}} 1 \, dx \\ &= \frac{1}{\sqrt{3}} \left(\frac{(\sqrt{3})^3}{3} \right) - \frac{1}{\sqrt{3}} (\sqrt{3} - 0) = 1 - 1 = 0. \end{aligned}$$

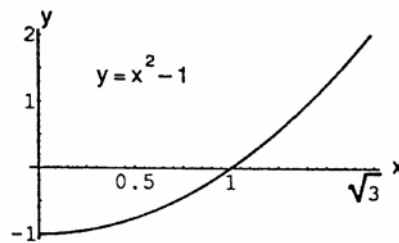

56.
$$\begin{aligned} \text{av}(f) &= \left(\frac{1}{3-0} \right) \int_0^3 \left(-\frac{x^2}{2} \right) dx = \frac{1}{3} \left(-\frac{1}{2} \right) \int_0^3 x^2 dx \\ &= -\frac{1}{6} \left(\frac{3^3}{3} \right) = -\frac{3}{2}; -\frac{x^2}{2} = -\frac{3}{2}. \end{aligned}$$

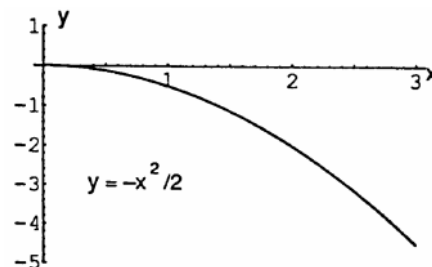

$$\begin{aligned}
 57. \text{av}(f) &= \left(\frac{1}{1-0}\right) \int_0^1 (-3x^2 - 1) \, dx = \\
 &= -3 \int_0^1 x^2 \, dx - \int_0^1 1 \, dx = -3 \left(\frac{1^3}{3}\right) - (1 - 0) \\
 &= -2.
 \end{aligned}$$

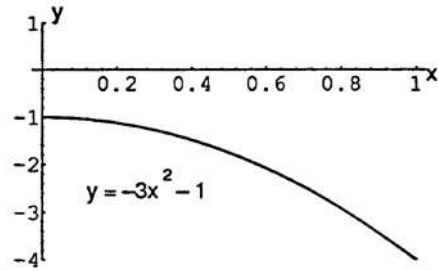

$$\begin{aligned}
 58. \text{av}(f) &= \left(\frac{1}{1-0}\right) \int_0^1 (3x^2 - 3) \, dx = \\
 &= 3 \int_0^1 x^2 \, dx - \int_0^1 3 \, dx = 3 \left(\frac{1^3}{3}\right) - 3(1 - 0) \\
 &= -2.
 \end{aligned}$$

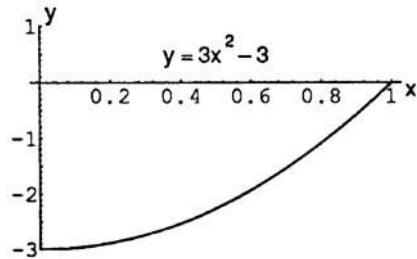

$$\begin{aligned}
 59. \text{av}(f) &= \left(\frac{1}{3-0}\right) \int_0^3 (t - 1)^2 \, dt \\
 &= \frac{1}{3} \int_0^3 t^2 \, dt - \frac{2}{3} \int_0^3 t \, dt + \frac{1}{3} \int_0^3 1 \, dt \\
 &= \frac{1}{3} \left(\frac{3^3}{3}\right) - \frac{2}{3} \left(\frac{3^2}{2} - \frac{0^2}{2}\right) + \frac{1}{3}(3 - 0) = 1.
 \end{aligned}$$

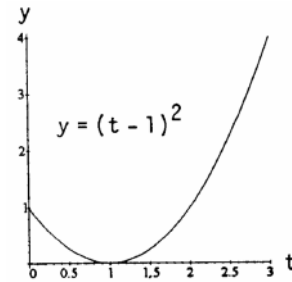

$$\begin{aligned}
 60. \text{av}(f) &= \left(\frac{1}{1-(-2)}\right) \int_{-2}^1 (t^2 - t) \, dt \\
 &= \frac{1}{3} \int_{-2}^1 t^2 \, dt - \frac{1}{3} \int_{-2}^1 t \, dt \\
 &= \frac{1}{3} \int_0^1 t^2 \, dt - \frac{1}{3} \int_0^{-2} t^2 \, dt - \frac{1}{3} \left(\frac{1^2}{2} - \frac{(-2)^2}{2}\right) \\
 &= \frac{1}{3} \left(\frac{1^3}{3}\right) - \frac{1}{3} \left(\frac{(-2)^3}{3}\right) + \frac{1}{2} = \frac{3}{2}.
 \end{aligned}$$

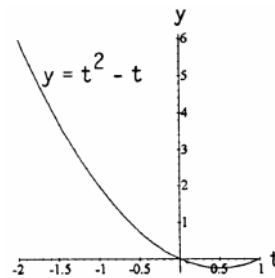

$$\begin{aligned}
 61. (a) \text{av}(g) &= \left(\frac{1}{1-(-1)}\right) \int_{-1}^1 (|x| - 1) \, dx \\
 &= \frac{1}{2} \int_{-1}^0 (-x - 1) \, dx + \frac{1}{2} \int_0^1 (x - 1) \, dx \\
 &= -\frac{1}{2} \int_{-1}^0 x \, dx - \frac{1}{2} \int_{-1}^0 1 \, dx + \frac{1}{2} \int_0^1 x \, dx - \frac{1}{2} \int_0^1 1 \, dx \\
 &= -\frac{1}{2} \left(\frac{0^2}{2} - \frac{(-1)^2}{2}\right) - \frac{1}{2}(0 - (-1)) + \frac{1}{2} \left(\frac{1^2}{2} - \frac{0^2}{2}\right) - \frac{1}{2}(1 - 0) \\
 &= -\frac{1}{2}.
 \end{aligned}$$

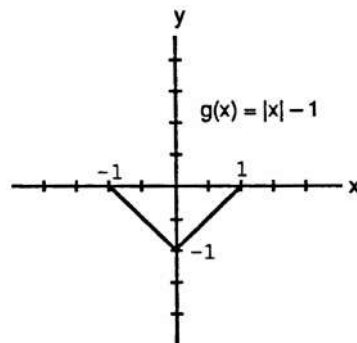

$$\begin{aligned}
 \text{(b) } \text{av}(g) &= \left(\frac{1}{3-1}\right) \int_1^3 (|x| - 1) \, dx = \frac{1}{2} \int_1^3 (x - 1) \, dx \\
 &= \frac{1}{2} \int_1^3 x \, dx - \frac{1}{2} \int_1^3 1 \, dx = \frac{1}{2} \left(\frac{3^2}{2} - \frac{1^2}{2}\right) - \frac{1}{2}(3 - 1) \\
 &= 1.
 \end{aligned}$$

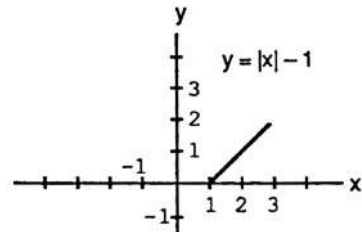

$$\begin{aligned}
 \text{(c) } \text{av}(g) &= \left(\frac{1}{3-(-1)}\right) \int_{-1}^3 (|x| - 1) \, dx \\
 &= \frac{1}{4} \int_{-1}^1 (|x| - 1) \, dx + \frac{1}{4} \int_1^3 (|x| - 1) \, dx \\
 &= \frac{1}{4}(-1 + 2) = \frac{1}{4} \text{ (see parts (a) and (b) above).}
 \end{aligned}$$

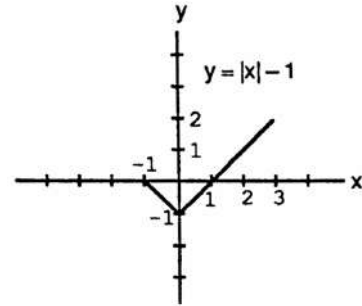

$$\begin{aligned}
 62. \text{ (a) } \text{av}(h) &= \left(\frac{1}{0-(-1)}\right) \int_{-1}^0 -|x| \, dx = \int_{-1}^0 -(-x) \, dx \\
 &= \int_{-1}^0 x \, dx = \frac{0^2}{2} - \frac{(-1)^2}{2} = -\frac{1}{2}.
 \end{aligned}$$

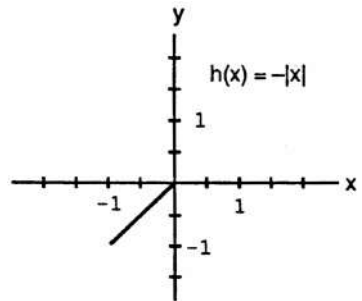

$$\begin{aligned}
 \text{(b) } \text{av}(h) &= \left(\frac{1}{1-0}\right) \int_0^1 -|x| \, dx = -\int_0^1 x \, dx \\
 &= -\left(\frac{1^2}{2} - \frac{0^2}{2}\right) = -\frac{1}{2}.
 \end{aligned}$$

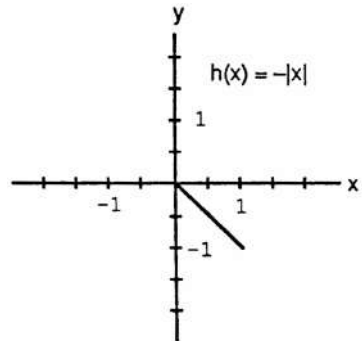

$$\begin{aligned}
 \text{(c) } \text{av}(h) &= \left(\frac{1}{1-(-1)}\right) \int_{-1}^1 -|x| \, dx \\
 &= \frac{1}{2} \left(\int_{-1}^0 -|x| \, dx + \int_0^1 -|x| \, dx\right) \\
 &= \frac{1}{2} \left(-\frac{1}{2} + \left(-\frac{1}{2}\right)\right) = -\frac{1}{2} \text{ (see parts (a) and (b) above).}
 \end{aligned}$$

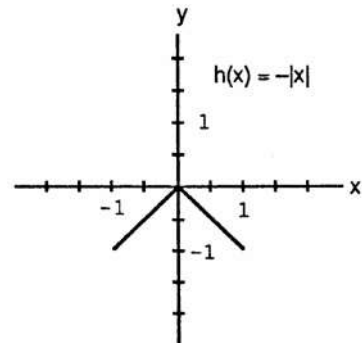

63. To find where $x - x^2 \geq 0$, let $x - x^2 = 0 \Rightarrow x(1 - x) = 0 \Rightarrow x = 0$ or $x = 1$. If $0 < x < 1$, then $0 < x - x^2 \Rightarrow a = 0$ and $b = 1$ maximize the integral.

64. To find where $x^4 - 2x^2 \leq 0$, let $x^4 - 2x^2 = 0 \Rightarrow x^2(x^2 - 2) = 0 \Rightarrow x = 0$ or $x = \pm\sqrt{2}$. By the sign graph, $+++++0 \quad --0 \quad --0 \quad ++++++$, we can see that $x^4 - 2x^2 \leq 0$ on $[-\sqrt{2}, \sqrt{2}] \Rightarrow a = -\sqrt{2}$ and $b = \sqrt{2}$ minimize the integral.

65. $f(x) = \frac{1}{1+x^2}$ is decreasing on $[0, 1] \Rightarrow$ maximum value of f occurs at $0 \Rightarrow \max f = f(0) = 1$; minimum value of f occurs at $1 \Rightarrow \min f = f(1) = \frac{1}{1+1^2} = \frac{1}{2}$. Therefore, $(1 - 0) \min f \leq \int_0^1 \frac{1}{1+x^2} dx \leq (1 - 0) \max f \Rightarrow \frac{1}{2} \leq \int_0^1 \frac{1}{1+x^2} dx \leq 1$. That is, an upper bound = 1 and a lower bound = $\frac{1}{2}$.

66. See Exercise 65 above. On $[0, 0.5]$, $\max f = \frac{1}{1+0^2} = 1$, $\min f = \frac{1}{1+(0.5)^2} = 0.8$. Therefore $(0.5 - 0) \min f \leq \int_0^{0.5} f(x) dx \leq (0.5 - 0) \max f \Rightarrow \frac{2}{5} \leq \int_0^{0.5} \frac{1}{1+x^2} dx \leq \frac{1}{2}$. On $[0.5, 1]$, $\max f = \frac{1}{1+(0.5)^2} = 0.8$ and $\min f = \frac{1}{1+1^2} = 0.5$. Therefore $(1 - 0.5) \min f \leq \int_{0.5}^1 \frac{1}{1+x^2} dx \leq (1 - 0.5) \max f \Rightarrow \frac{1}{4} \leq \int_{0.5}^1 \frac{1}{1+x^2} dx \leq \frac{2}{5}$. Then $\frac{1}{4} + \frac{2}{5} \leq \int_0^{0.5} \frac{1}{1+x^2} dx + \int_{0.5}^1 \frac{1}{1+x^2} dx \leq \frac{1}{2} + \frac{2}{5} \Rightarrow \frac{13}{20} \leq \int_0^1 \frac{1}{1+x^2} dx \leq \frac{9}{10}$.

67. $-1 \leq \sin(x^2) \leq 1$ for all $x \Rightarrow (1 - 0)(-1) \leq \int_0^1 \sin(x^2) dx \leq (1 - 0)(1)$ or $\int_0^1 \sin x^2 dx \leq 1 \Rightarrow \int_0^1 \sin x^2 dx$ cannot equal 2.

68. $f(x) = \sqrt{x+8}$ is increasing on $[0, 1] \Rightarrow \max f = f(1) = \sqrt{1+8} = 3$ and $\min f = f(0) = \sqrt{0+8} = 2\sqrt{2}$. Therefore, $(1 - 0) \min f \leq \int_0^1 \sqrt{x+8} dx \leq (1 - 0) \max f \Rightarrow 2\sqrt{2} \leq \int_0^1 \sqrt{x+8} dx \leq 3$.

69. If $f(x) \geq 0$ on $[a, b]$, then $\min f \geq 0$ and $\max f \geq 0$ on $[a, b]$. Now, $(b - a) \min f \leq \int_a^b f(x) dx \leq (b - a) \max f$. Then $b \geq a \Rightarrow b - a \geq 0 \Rightarrow (b - a) \min f \geq 0 \Rightarrow \int_a^b f(x) dx \geq 0$.

70. If $f(x) \leq 0$ on $[a, b]$, then $\min f \leq 0$ and $\max f \leq 0$. Now, $(b - a) \min f \leq \int_a^b f(x) dx \leq (b - a) \max f$. Then $b \geq a \Rightarrow b - a \geq 0 \Rightarrow (b - a) \max f \leq 0 \Rightarrow \int_a^b f(x) dx \leq 0$.

71. $\sin x \leq x$ for $x \geq 0 \Rightarrow \sin x - x \leq 0$ for $x \geq 0 \Rightarrow \int_0^1 (\sin x - x) dx \leq 0$ (see Exercise 70) $\Rightarrow \int_0^1 \sin x dx - \int_0^1 x dx \leq 0 \Rightarrow \int_0^1 \sin x dx \leq \int_0^1 x dx \Rightarrow \int_0^1 \sin x dx \leq \left(\frac{1^2}{2} - \frac{0^2}{2}\right) \Rightarrow \int_0^1 \sin x dx \leq \frac{1}{2}$. Thus an upper bound is $\frac{1}{2}$.

72. $\sec x \geq 1 + \frac{x^2}{2}$ on $(-\frac{\pi}{2}, \frac{\pi}{2}) \Rightarrow \sec x - \left(1 + \frac{x^2}{2}\right) \geq 0$ on $(-\frac{\pi}{2}, \frac{\pi}{2}) \Rightarrow \int_0^1 \left[\sec x - \left(1 + \frac{x^2}{2}\right)\right] dx \geq 0$ (see Exercise 69) since $[0, 1]$ is contained in $(-\frac{\pi}{2}, \frac{\pi}{2}) \Rightarrow \int_0^1 \sec x dx - \int_0^1 \left(1 + \frac{x^2}{2}\right) dx \geq 0 \Rightarrow \int_0^1 \sec x dx \geq \int_0^1 \left(1 + \frac{x^2}{2}\right) dx \Rightarrow \int_0^1 \sec x dx \geq \int_0^1 1 dx + \frac{1}{2} \int_0^1 x^2 dx \Rightarrow \int_0^1 \sec x dx \geq (1 - 0) + \frac{1}{2} \left(\frac{1^3}{3}\right) \Rightarrow \int_0^1 \sec x dx \geq \frac{7}{6}$. Thus a lower bound is $\frac{7}{6}$.

73. Yes, for the following reasons: $av(f) = \frac{1}{b-a} \int_a^b f(x) dx$ is a constant K . Thus $\int_a^b av(f) dx = \int_a^b K dx = K(b - a) \Rightarrow \int_a^b av(f) dx = (b - a)K = (b - a) \cdot \frac{1}{b-a} \int_a^b f(x) dx = \int_a^b f(x) dx$.

74. All three rules hold. The reasons: On any interval $[a, b]$ on which f and g are integrable, we have:

$$(a) \quad \text{av}(f + g) = \frac{1}{b-a} \int_a^b [f(x) + g(x)] dx = \frac{1}{b-a} \left[\int_a^b f(x) dx + \int_a^b g(x) dx \right] = \frac{1}{b-a} \int_a^b f(x) dx + \frac{1}{b-a} \int_a^b g(x) dx \\ = \text{av}(f) + \text{av}(g)$$

$$(b) \quad \text{av}(kf) = \frac{1}{b-a} \int_a^b kf(x) dx = \frac{1}{b-a} \left[k \int_a^b f(x) dx \right] = k \left[\frac{1}{b-a} \int_a^b f(x) dx \right] = k \text{av}(f)$$

$$(c) \quad \text{av}(f) = \frac{1}{b-a} \int_a^b f(x) dx \leq \frac{1}{b-a} \int_a^b g(x) dx \text{ since } f(x) \leq g(x) \text{ on } [a, b], \text{ and } \frac{1}{b-a} \int_a^b g(x) dx = \text{av}(g).$$

Therefore, $\text{av}(f) \leq \text{av}(g)$.

75. Consider the partition P that subdivides the interval $[a, b]$ into n subintervals of width $\Delta x = \frac{b-a}{n}$ and let c_k be the right endpoint of each subinterval. So the partition is $P = \{a, a + \frac{b-a}{n}, a + \frac{2(b-a)}{n}, \dots, a + \frac{n(b-a)}{n}\}$ and $c_k = a + \frac{k(b-a)}{n}$.

We get the Riemann sum $\sum_{k=1}^n f(c_k) \Delta x = \sum_{k=1}^n c \cdot \frac{b-a}{n} = \frac{c(b-a)}{n} \sum_{k=1}^n 1 = \frac{c(b-a)}{n} \cdot n = c(b-a)$. As $n \rightarrow \infty$ and $\|P\| \rightarrow 0$

this expression remains $c(b-a)$. Thus, $\int_a^b c dx = c(b-a)$.

76. Consider the partition P that subdivides the interval $[a, b]$ into n subintervals of width $\Delta x = \frac{b-a}{n}$ and let c_k be the right endpoint of each subinterval. So the partition is $P = \{a, a + \frac{b-a}{n}, a + \frac{2(b-a)}{n}, \dots, a + \frac{n(b-a)}{n}\}$ and $c_k = a + \frac{k(b-a)}{n}$.

We get the Riemann sum $\sum_{k=1}^n f(c_k) \Delta x = \sum_{k=1}^n c_k^2 \left(\frac{b-a}{n}\right) = \frac{b-a}{n} \sum_{k=1}^n \left(a + \frac{k(b-a)}{n}\right)^2 = \frac{b-a}{n} \sum_{k=1}^n \left(a^2 + \frac{2ak(b-a)}{n} + \frac{k^2(b-a)^2}{n^2}\right)$

$$= \frac{b-a}{n} \left(\sum_{k=1}^n a^2 + \frac{2a(b-a)}{n} \sum_{k=1}^n k + \frac{(b-a)^2}{n^2} \sum_{k=1}^n k^2 \right) = \frac{b-a}{n} \cdot na^2 + \frac{2a(b-a)^2}{n^2} \cdot \frac{n(n+1)}{2} + \frac{(b-a)^3}{n^3} \cdot \frac{n(n+1)(2n+1)}{6}$$

$$= (b-a)a^2 + a(b-a)^2 \cdot \frac{n+1}{n} + \frac{(b-a)^3}{6} \cdot \frac{(n+1)(2n+1)}{n^2} = (b-a)a^2 + a(b-a)^2 \cdot \frac{1+\frac{1}{n}}{1} + \frac{(b-a)^3}{6} \cdot \frac{2+\frac{3}{n}+\frac{1}{n^2}}{1}$$

As $n \rightarrow \infty$ and $\|P\| \rightarrow 0$ this expression has value $(b-a)a^2 + a(b-a)^2 \cdot 1 + \frac{(b-a)^3}{6} \cdot 2$

$$= ba^2 - a^3 + ab^2 - 2a^2b + a^3 + \frac{1}{3}(b^3 - 3b^2a + 3ba^2 - a^3) = \frac{b^3}{3} - \frac{a^3}{3}. \text{ Thus, } \int_a^b x^2 dx = \frac{b^3}{3} - \frac{a^3}{3}.$$

77. (a) $U = \max_1 \Delta x + \max_2 \Delta x + \dots + \max_n \Delta x$ where $\max_1 = f(x_1), \max_2 = f(x_2), \dots, \max_n = f(x_n)$ since f is increasing on $[a, b]$; $L = \min_1 \Delta x + \min_2 \Delta x + \dots + \min_n \Delta x$ where $\min_1 = f(x_0), \min_2 = f(x_1), \dots, \min_n = f(x_{n-1})$ since f is increasing on $[a, b]$. Therefore

$$U - L = (\max_1 - \min_1) \Delta x + (\max_2 - \min_2) \Delta x + \dots + (\max_n - \min_n) \Delta x \\ = (f(x_1) - f(x_0)) \Delta x + (f(x_2) - f(x_1)) \Delta x + \dots + (f(x_n) - f(x_{n-1})) \Delta x = (f(x_n) - f(x_0)) \Delta x = (f(b) - f(a)) \Delta x.$$

(b) $U = \max_1 \Delta x_1 + \max_2 \Delta x_2 + \dots + \max_n \Delta x_n$ where $\max_1 = f(x_1), \max_2 = f(x_2), \dots, \max_n = f(x_n)$ since f is increasing on $[a, b]$; $L = \min_1 \Delta x_1 + \min_2 \Delta x_2 + \dots + \min_n \Delta x_n$ where

$\min_1 = f(x_0), \min_2 = f(x_1), \dots, \min_n = f(x_{n-1})$ since f is increasing on $[a, b]$. Therefore

$$U - L = (\max_1 - \min_1) \Delta x_1 + (\max_2 - \min_2) \Delta x_2 + \dots + (\max_n - \min_n) \Delta x_n \\ = (f(x_1) - f(x_0)) \Delta x_1 + (f(x_2) - f(x_1)) \Delta x_2 + \dots + (f(x_n) - f(x_{n-1})) \Delta x_n$$

$$\leq (f(x_1) - f(x_0)) \Delta x_{\max} + (f(x_2) - f(x_1)) \Delta x_{\max} + \dots + (f(x_n) - f(x_{n-1})) \Delta x_{\max}. \text{ Then}$$

$$U - L \leq (f(x_n) - f(x_0)) \Delta x_{\max} = (f(b) - f(a)) \Delta x_{\max} = |f(b) - f(a)| \Delta x_{\max} \text{ since } f(b) \geq f(a). \text{ Thus}$$

$$\lim_{\|P\| \rightarrow 0} (U - L) = \lim_{\|P\| \rightarrow 0} (f(b) - f(a)) \Delta x_{\max} = 0, \text{ since } \Delta x_{\max} = \|P\|.$$

78. (a) $U = \max_1 \Delta x + \max_2 \Delta x + \dots + \max_n \Delta x$ where
 $\max_1 = f(x_0), \max_2 = f(x_1), \dots, \max_n = f(x_{n-1})$
 since f is decreasing on $[a, b]$;
 $L = \min_1 \Delta x + \min_2 \Delta x + \dots + \min_n \Delta x$ where
 $\min_1 = f(x_1), \min_2 = f(x_2), \dots, \min_n = f(x_n)$
 since f is decreasing on $[a, b]$. Therefore
 $U - L = (\max_1 - \min_1) \Delta x + (\max_2 - \min_2) \Delta x$
 $+ \dots + (\max_n - \min_n) \Delta x$
 $= (f(x_0) - f(x_1)) \Delta x + (f(x_1) - f(x_2)) \Delta x$
 $+ \dots + (f(x_{n-1}) - f(x_n)) \Delta x = (f(x_0) - f(x_n)) \Delta x$
 $= (f(a) - f(b)) \Delta x.$

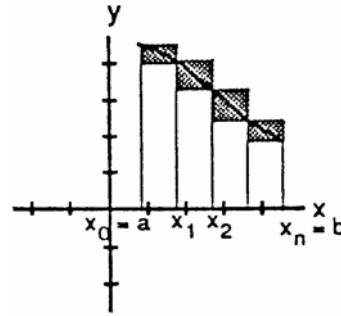

(b) $U = \max_1 \Delta x_1 + \max_2 \Delta x_2 + \dots + \max_n \Delta x_n$ where $\max_1 = f(x_0), \max_2 = f(x_1), \dots, \max_n = f(x_{n-1})$ since f is decreasing on $[a, b]$; $L = \min_1 \Delta x_1 + \min_2 \Delta x_2 + \dots + \min_n \Delta x_n$ where $\min_1 = f(x_1), \min_2 = f(x_2), \dots, \min_n = f(x_n)$ since f is decreasing on $[a, b]$. Therefore
 $U - L = (\max_1 - \min_1) \Delta x_1 + (\max_2 - \min_2) \Delta x_2 + \dots + (\max_n - \min_n) \Delta x_n$
 $= (f(x_0) - f(x_1)) \Delta x_1 + (f(x_1) - f(x_2)) \Delta x_2 + \dots + (f(x_{n-1}) - f(x_n)) \Delta x_n$
 $\leq (f(x_0) - f(x_n)) \Delta x_{\max} = (f(a) - f(b)) \Delta x_{\max} = |f(b) - f(a)| \Delta x_{\max}$ since $f(b) \leq f(a)$. Thus
 $\lim_{\|P\| \rightarrow 0} (U - L) = \lim_{\|P\| \rightarrow 0} |f(b) - f(a)| \Delta x_{\max} = 0$, since $\Delta x_{\max} = \|P\|$.

79. (a) Partition $[0, \frac{\pi}{2}]$ into n subintervals, each of length $\Delta x = \frac{\pi}{2n}$ with points $x_0 = 0, x_1 = \Delta x,$
 $x_2 = 2\Delta x, \dots, x_n = n\Delta x = \frac{\pi}{2}$. Since $\sin x$ is increasing on $[0, \frac{\pi}{2}]$, the upper sum U is the sum of the areas
 of the circumscribed rectangles of areas $f(x_1) \Delta x = (\sin \Delta x) \Delta x, f(x_2) \Delta x = (\sin 2\Delta x) \Delta x, \dots, f(x_n) \Delta x$
 $= (\sin n\Delta x) \Delta x$. Then $U = (\sin \Delta x + \sin 2\Delta x + \dots + \sin n\Delta x) \Delta x = \left[\frac{\cos \frac{\Delta x}{2} - \cos \left(\left(n + \frac{1}{2} \right) \Delta x \right)}{2 \sin \frac{\Delta x}{2}} \right] \Delta x$
 $= \left[\frac{\cos \frac{\pi}{4n} - \cos \left(\left(n + \frac{1}{2} \right) \frac{\pi}{2n} \right)}{2 \sin \frac{\pi}{4n}} \right] \left(\frac{\pi}{2n} \right) = \frac{\pi (\cos \frac{\pi}{4n} - \cos \left(\frac{\pi}{2} + \frac{\pi}{4n} \right))}{4n \sin \frac{\pi}{4n}} = \frac{\cos \frac{\pi}{4n} - \cos \left(\frac{\pi}{2} + \frac{\pi}{4n} \right)}{\left(\frac{\sin \frac{\pi}{4n}}{\frac{\pi}{4n}} \right)}$

(b) The area is $\int_0^{\pi/2} \sin x \, dx = \lim_{n \rightarrow \infty} \frac{\cos \frac{\pi}{4n} - \cos \left(\frac{\pi}{2} + \frac{\pi}{4n} \right)}{\left(\frac{\sin \frac{\pi}{4n}}{\frac{\pi}{4n}} \right)} = \frac{1 - \cos \frac{\pi}{2}}{1} = 1$.

80. (a) The area of the shaded region is $\sum_{i=1}^n \Delta x_i \cdot m_i$ which is equal to L .

(b) The area of the shaded region is $\sum_{i=1}^n \Delta x_i \cdot M_i$ which is equal to U .

(c) The area of the shaded region is the difference in the areas of the shaded regions shown in the second part of the figure and the first part of the figure. Thus this area is $U - L$.

81. By Exercise 80, $U - L = \sum_{i=1}^n \Delta x_i \cdot M_i - \sum_{i=1}^n \Delta x_i \cdot m_i$ where $M_i = \max\{f(x)$ on the i th subinterval} and

$m_i = \min\{f(x)$ on the i th subinterval}. Thus $U - L = \sum_{i=1}^n (M_i - m_i) \Delta x_i < \sum_{i=1}^n \epsilon \cdot \Delta x_i$ provided $\Delta x_i < \delta$ for each

$i = 1, \dots, n$. Since $\sum_{i=1}^n \epsilon \cdot \Delta x_i = \epsilon \sum_{i=1}^n \Delta x_i = \epsilon(b - a)$ the result, $U - L < \epsilon(b - a)$ follows.

82. The car drove the first 150 miles in 5 hours and the second 150 miles in 3 hours, which means it drove 300 miles in 8 hours, for an average of $\frac{300}{8}$ mi/hr

= 37.5 mi/hr. In terms of average values of functions, the function whose average value we seek is

$$v(t) = \begin{cases} 30, & 0 \leq t \leq 5 \\ 50, & 5 < t \leq 8 \end{cases}, \text{ and the average value is}$$

$$\frac{(30)(5) + (50)(3)}{8} = 37.5.$$

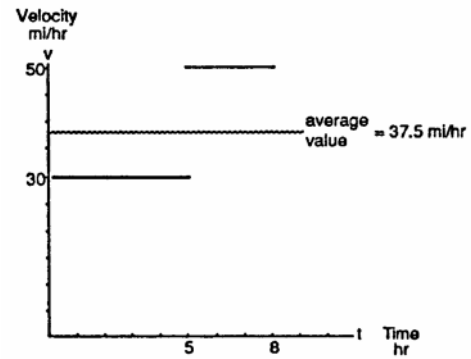

83-88. Example CAS commands:

Maple:

```
with( plots );
with( Student[Calculus1] );
f := x -> 1-x;
a := 0;
b := 1;
N := [ 4, 10, 20, 50 ];
P := [seq( RiemannSum( f(x), x=a..b, partition=n, method=random, output=plot ), n=N )];
display( P, insequence=true );
```

89-92. Example CAS commands:

Maple:

```
with( Student[Calculus1] );
f := x -> sin(x);
a := 0;
b := Pi;
plot( f(x), x=a..b, title="#23(a) (Section 5.1)" );
N := [ 100, 200, 1000 ]; # (b)
for n in N do
  Xlist := [ a+1.*(b-a)/n*i $ i=0..n ];
  Ylist := map( f, Xlist );
end do;
for n in N do # (c)
  Avg[n] := evalf(add(y,y=Ylist)/nops(Ylist));
end do;
avg := FunctionAverage( f(x), x=a..b, output=value );
evalf( avg );
FunctionAverage(f(x),x=a..b,output=plot); # (d)
fsolve( f(x)=avg, x=0.5 );
fsolve( f(x)=avg, x=2.5 );
fsolve( f(x)=Avg[1000], x=0.5 );
fsolve( f(x)=Avg[1000], x=2.5 );
```

83-92. Example CAS commands:

Mathematica: (assigned function and values for a, b, and n may vary)

Sums of rectangles evaluated at left-hand endpoints can be represented and evaluated by this set of commands

```
Clear[x, f, a, b, n]
```

```

{a, b}={0, π}; n=10; dx = (b - a)/n;
f = Sin[x]^2;
xvals =Table[N[x], {x, a, b - dx, dx}];
yvals = f /.x → xvals;
boxes = MapThread[Line[{{#1,0},{#1, #3},{#2, #3},{#2, 0}}&,{xvals, xvals + dx, yvals}];
Plot[f, {x, a, b}, Epilog → boxes];
Sum[yvals[[i]] dx, {i, 1, Length[yvals]}]/N

```

Sums of rectangles evaluated at right-hand endpoints can be represented and evaluated by this set of commands.

```

Clear[x, f, a, b, n]
{a, b}={0, π}; n=10; dx = (b - a)/n;
f = Sin[x]^2;
xvals =Table[N[x], {x, a + dx, b, dx}];
yvals = f /.x → xvals;
boxes = MapThread[Line[{{#1,0},{#1, #3},{#2, #3},{#2, 0}}&,{xvals - dx,xvals, yvals}];
Plot[f, {x, a, b}, Epilog → boxes];
Sum[yvals[[i]] dx, {i, 1,Length[yvals]}]/N

```

Sums of rectangles evaluated at midpoints can be represented and evaluated by this set of commands.

```

Clear[x, f, a, b, n]
{a, b}={0, π}; n=10; dx = (b - a)/n;
f = Sin[x]^2;
xvals =Table[N[x], {x, a + dx/2, b - dx/2, dx}];
yvals = f /.x → xvals;
boxes = MapThread[Line[{{#1,0},{#1, #3},{#2, #3},{#2, 0}}&,{xvals - dx/2, xvals + dx/2, yvals}];
Plot[f, {x, a, b}, Epilog → boxes];
Sum[yvals[[i]] dx, {i, 1, Length[yvals]}]/N

```

5.4 THE FUNDAMENTAL THEOREM OF CALCULUS

- $\int_{-2}^0 (2x + 5) dx = [x^2 + 5x]_{-2}^0 = (0^2 + 5(0)) - ((-2)^2 + 5(-2)) = 6$
- $\int_{-3}^4 (5 - \frac{x}{2}) dx = [5x - \frac{x^2}{4}]_{-3}^4 = (5(4) - \frac{4^2}{4}) - (5(-3) - \frac{(-3)^2}{4}) = \frac{133}{4}$
- $\int_0^4 (3x - \frac{x^3}{4}) dx = [\frac{3x^2}{2} - \frac{x^4}{16}]_0^4 = (\frac{3(4)^2}{2} - \frac{4^4}{16}) - (\frac{3(0)^2}{2} - \frac{(0)^4}{16}) = 8$
- $\int_{-2}^2 (x^3 - 2x + 3) dx = [\frac{x^4}{4} - x^2 + 3x]_{-2}^2 = (\frac{2^4}{4} - 2^2 + 3(2)) - (\frac{(-2)^4}{4} - (-2)^2 + 3(-2)) = 12$
- $\int_0^1 (x^2 + \sqrt{x}) dx = [\frac{x^3}{3} + \frac{2}{3} x^{3/2}]_0^1 = (\frac{1}{3} + \frac{2}{3}) - 0 = 1$
- $\int_0^5 x^{3/2} dx = [\frac{2}{5} x^{5/2}]_0^5 = \frac{2}{5} (5)^{5/2} - 0 = 2(5)^{3/2} = 10\sqrt{5}$
- $\int_1^{32} x^{-6/5} dx = [-5x^{-1/5}]_1^{32} = (-\frac{5}{2}) - (-5) = \frac{5}{2}$
- $\int_{-2}^{-1} \frac{2}{x^2} dx = \int_{-2}^{-1} 2x^{-2} dx = [-2x^{-1}]_{-2}^{-1} = (\frac{-2}{-1}) - (\frac{-2}{-2}) = 1$

9. $\int_0^\pi \sin x \, dx = [-\cos x]_0^\pi = (-\cos \pi) - (-\cos 0) = -(-1) - (-1) = 2$
10. $\int_0^\pi (1 + \cos x) \, dx = [x + \sin x]_0^\pi = (\pi + \sin \pi) - (0 + \sin 0) = \pi$
11. $\int_0^{\pi/3} 2 \sec^2 x \, dx = [2 \tan x]_0^{\pi/3} = (2 \tan(\frac{\pi}{3})) - (2 \tan 0) = 2\sqrt{3} - 0 = 2\sqrt{3}$
12. $\int_{\pi/6}^{5\pi/6} \csc^2 x \, dx = [-\cot x]_{\pi/6}^{5\pi/6} = (-\cot(\frac{5\pi}{6})) - (-\cot(\frac{\pi}{6})) = -(-\sqrt{3}) - (-\sqrt{3}) = 2\sqrt{3}$
13. $\int_{\pi/4}^{3\pi/4} \csc \theta \cot \theta \, d\theta = [-\csc \theta]_{\pi/4}^{3\pi/4} = (-\csc(\frac{3\pi}{4})) - (-\csc(\frac{\pi}{4})) = -\sqrt{2} - (-\sqrt{2}) = 0$
14. $\int_0^{\pi/3} 4 \sec u \tan u \, du = [4 \sec u]_0^{\pi/3} = 4 \sec(\frac{\pi}{3}) - 4 \sec 0 = 4(2) - 4(1) = 4$
15. $\int_{\pi/2}^0 \frac{1+\cos 2t}{2} \, dt = \int_{\pi/2}^0 (\frac{1}{2} + \frac{1}{2} \cos 2t) \, dt = [\frac{1}{2}t + \frac{1}{4} \sin 2t]_{\pi/2}^0 = (\frac{1}{2}(0) + \frac{1}{4} \sin 2(0)) - (\frac{1}{2}(\frac{\pi}{2}) + \frac{1}{4} \sin 2(\frac{\pi}{2})) = -\frac{\pi}{4}$
16. $\int_{-\pi/3}^{\pi/3} \frac{1-\cos 2t}{2} \, dt = \int_{-\pi/3}^{\pi/3} (\frac{1}{2} - \frac{1}{2} \cos 2t) \, dt = [\frac{1}{2}t - \frac{1}{4} \sin 2t]_{-\pi/3}^{\pi/3} = (\frac{1}{2}(\frac{\pi}{3}) - \frac{1}{4} \sin 2(\frac{\pi}{3})) - (\frac{1}{2}(-\frac{\pi}{3}) - \frac{1}{4} \sin 2(-\frac{\pi}{3})) = \frac{\pi}{6} - \frac{1}{4} \sin \frac{2\pi}{3} + \frac{\pi}{6} + \frac{1}{4} \sin(-\frac{2\pi}{3}) = \frac{\pi}{3} - \frac{\sqrt{3}}{4}$
17. $\int_{-\pi/2}^{\pi/2} (8y^2 + \sin y) \, dy = [\frac{8y^3}{3} - \cos y]_{-\pi/2}^{\pi/2} = (\frac{8(\frac{\pi}{2})^3}{3} - \cos \frac{\pi}{2}) - (\frac{8(-\frac{\pi}{2})^3}{3} - \cos(-\frac{\pi}{2})) = \frac{2\pi^3}{3}$
18. $\int_{-\pi/3}^{-\pi/4} (4 \sec^2 t + \frac{\pi}{t^2}) \, dt = \int_{-\pi/3}^{-\pi/4} (4 \sec^2 t + \pi t^{-2}) \, dt = [4 \tan t - \frac{\pi}{t}]_{-\pi/3}^{-\pi/4} = (4 \tan(-\frac{\pi}{4}) - \frac{\pi}{(-\frac{\pi}{4}))} - (4 \tan(\frac{\pi}{3}) - \frac{\pi}{(-\frac{\pi}{3}))} = (4(-1) + 4) - (4(\sqrt{3}) + 3) = 4\sqrt{3} - 3$
19. $\int_1^{-1} (r+1)^2 \, dr = \int_1^{-1} (r^2 + 2r + 1) \, dr = [\frac{r^3}{3} + r^2 + r]_1^{-1} = (\frac{(-1)^3}{3} + (-1)^2 + (-1)) - (\frac{1^3}{3} + 1^2 + 1) = -\frac{8}{3}$
20. $\int_{-\sqrt{3}}^{\sqrt{3}} (t+1)(t^2+4) \, dt = \int_{-\sqrt{3}}^{\sqrt{3}} (t^3 + t^2 + 4t + 4) \, dt = [\frac{t^4}{4} + \frac{t^3}{3} + 2t^2 + 4t]_{-\sqrt{3}}^{\sqrt{3}} = (\frac{(\sqrt{3})^4}{4} + \frac{(\sqrt{3})^3}{3} + 2(\sqrt{3})^2 + 4\sqrt{3}) - (\frac{(-\sqrt{3})^4}{4} + \frac{(-\sqrt{3})^3}{3} + 2(-\sqrt{3})^2 + 4(-\sqrt{3})) = 10\sqrt{3}$
21. $\int_{\sqrt{2}}^1 (\frac{u^7}{2} - \frac{1}{u^5}) \, du = \int_{\sqrt{2}}^1 (\frac{u^7}{2} - u^{-5}) \, du = [\frac{u^8}{16} + \frac{1}{4u^4}]_{\sqrt{2}}^1 = (\frac{1^8}{16} + \frac{1}{4(1)^4}) - (\frac{(\sqrt{2})^8}{16} + \frac{1}{4(\sqrt{2})^4}) = -\frac{3}{4}$
22. $\int_{1/2}^1 (\frac{1}{v^3} - \frac{1}{v^4}) \, dv = \int_{1/2}^1 (v^{-3} - v^{-4}) \, dv = [\frac{-1}{2v^2} + \frac{1}{3v^3}]_{1/2}^1 = (\frac{-1}{2(1)^2} + \frac{1}{3(1)^3}) - (\frac{-1}{2(\frac{1}{2})^2} + \frac{1}{3(\frac{1}{2})^3}) = -\frac{5}{6}$
23. $\int_1^{\sqrt{2}} \frac{s^2 + \sqrt{s}}{s^2} \, ds = \int_1^{\sqrt{2}} (1 + s^{-3/2}) \, ds = [s - \frac{2}{\sqrt{s}}]_1^{\sqrt{2}} = (\sqrt{2} - \frac{2}{\sqrt{\sqrt{2}}}) - (1 - \frac{2}{\sqrt{1}}) = \sqrt{2} - 2^{3/4} + 1 = \sqrt{2} - 4\sqrt{8} + 1$

$$24. \int_9^{16} \frac{1-\sqrt{u}}{\sqrt{u}} du = \int_9^{16} (u^{-1/2} - 1) du = [2\sqrt{u} - u]_9^{16} = (2\sqrt{16} - 16) - (2\sqrt{9} - 9) = 3$$

$$25. \int_{-4}^4 |x| dx = \int_{-4}^0 |x| dx + \int_0^4 |x| dx = -\int_{-4}^0 x dx + \int_0^4 x dx = \left[-\frac{x^2}{2}\right]_{-4}^0 + \left[\frac{x^2}{2}\right]_0^4 = \left(-\frac{0^2}{2} + \frac{(-4)^2}{2}\right) + \left(\frac{4^2}{2} - \frac{0^2}{2}\right) = 16$$

$$26. \int_0^\pi \frac{1}{2} (\cos x + |\cos x|) dx = \int_0^{\pi/2} \frac{1}{2} (\cos x + \cos x) dx + \int_{\pi/2}^\pi \frac{1}{2} (\cos x - \cos x) dx = \int_0^{\pi/2} \cos x dx = [\sin x]_0^{\pi/2} = \sin \frac{\pi}{2} - \sin 0 = 1$$

$$27. (a) \int_0^{\sqrt{x}} \cos t dt = [\sin t]_0^{\sqrt{x}} = \sin \sqrt{x} - \sin 0 = \sin \sqrt{x} \Rightarrow \frac{d}{dx} \left(\int_0^{\sqrt{x}} \cos t dt \right) = \frac{d}{dx} (\sin \sqrt{x}) = \cos \sqrt{x} \left(\frac{1}{2} x^{-1/2} \right) = \frac{\cos \sqrt{x}}{2\sqrt{x}}$$

$$(b) \frac{d}{dx} \left(\int_0^{\sqrt{x}} \cos t dt \right) = (\cos \sqrt{x}) \left(\frac{d}{dx} (\sqrt{x}) \right) = (\cos \sqrt{x}) \left(\frac{1}{2} x^{-1/2} \right) = \frac{\cos \sqrt{x}}{2\sqrt{x}}$$

$$28. (a) \int_1^{\sin x} 3t^2 dt = [t^3]_1^{\sin x} = \sin^3 x - 1 \Rightarrow \frac{d}{dx} \left(\int_1^{\sin x} 3t^2 dt \right) = \frac{d}{dx} (\sin^3 x - 1) = 3 \sin^2 x \cos x$$

$$(b) \frac{d}{dx} \left(\int_1^{\sin x} 3t^2 dt \right) = (3 \sin^2 x) \left(\frac{d}{dx} (\sin x) \right) = 3 \sin^2 x \cos x$$

$$29. (a) \int_0^{t^4} \sqrt{u} du = \int_0^{t^4} u^{1/2} du = \left[\frac{2}{3} u^{3/2} \right]_0^{t^4} = \frac{2}{3} (t^4)^{3/2} - 0 = \frac{2}{3} t^6 \Rightarrow \frac{d}{dt} \left(\int_0^{t^4} \sqrt{u} du \right) = \frac{d}{dt} \left(\frac{2}{3} t^6 \right) = 4t^5$$

$$(b) \frac{d}{dt} \left(\int_0^{t^4} \sqrt{u} du \right) = \sqrt{t^4} \left(\frac{d}{dt} (t^4) \right) = t^2 (4t^3) = 4t^5$$

$$30. (a) \int_0^{\tan \theta} \sec^2 y dy = [\tan y]_0^{\tan \theta} = \tan(\tan \theta) - 0 = \tan(\tan \theta) \Rightarrow \frac{d}{d\theta} \left(\int_0^{\tan \theta} \sec^2 y dy \right) = \frac{d}{d\theta} (\tan(\tan \theta)) = (\sec^2(\tan \theta)) \sec^2 \theta$$

$$(b) \frac{d}{d\theta} \left(\int_0^{\tan \theta} \sec^2 y dy \right) = (\sec^2(\tan \theta)) \left(\frac{d}{d\theta} (\tan \theta) \right) = (\sec^2(\tan \theta)) \sec^2 \theta$$

$$31. y = \int_0^x \sqrt{1+t^2} dt \Rightarrow \frac{dy}{dx} = \sqrt{1+x^2}$$

$$32. y = \int_1^x \frac{1}{t} dt \Rightarrow \frac{dy}{dx} = \frac{1}{x}, x > 0$$

$$33. y = \int_{\sqrt{x}}^0 \sin t^2 dt = -\int_0^{\sqrt{x}} \sin t^2 dt \Rightarrow \frac{dy}{dx} = -(\sin(\sqrt{x})^2) \left(\frac{d}{dx} (\sqrt{x}) \right) = -(\sin x) \left(\frac{1}{2} x^{-1/2} \right) = -\frac{\sin x}{2\sqrt{x}}$$

$$34. y = \int_0^{x^2} \cos \sqrt{t} dt \Rightarrow \frac{dy}{dx} = (\cos \sqrt{x^2}) \left(\frac{d}{dx} (x^2) \right) = 2x \cos |x|$$

$$35. y = \int_0^{\sin x} \frac{dt}{\sqrt{1-t^2}}, |x| < \frac{\pi}{2} \Rightarrow \frac{dy}{dx} = \frac{1}{\sqrt{1-\sin^2 x}} \left(\frac{d}{dx} (\sin x) \right) = \frac{1}{\sqrt{\cos^2 x}} (\cos x) = \frac{\cos x}{|\cos x|} = \frac{\cos x}{\cos x} = 1 \text{ since } |x| < \frac{\pi}{2}$$

$$36. y = \int_0^{\tan x} \frac{dt}{1+t^2} \Rightarrow \frac{dy}{dx} = \left(\frac{1}{1+\tan^2 x} \right) \left(\frac{d}{dx} (\tan x) \right) = \left(\frac{1}{\sec^2 x} \right) (\sec^2 x) = 1$$

37. $-x^2 - 2x = 0 \Rightarrow -x(x + 2) = 0 \Rightarrow x = 0$ or $x = -2$; Area

$$= -\int_{-3}^{-2} (-x^2 - 2x)dx + \int_{-2}^0 (-x^2 - 2x)dx - \int_0^2 (-x^2 - 2x)dx$$

$$= -\left[-\frac{x^3}{3} - x^2\right]_{-3}^{-2} + \left[-\frac{x^3}{3} - x^2\right]_{-2}^0 - \left[-\frac{x^3}{3} - x^2\right]_0^2$$

$$= -\left(\left(-\frac{(-2)^3}{3} - (-2)^2\right) - \left(-\frac{(-3)^3}{3} - (-3)^2\right)\right)$$

$$+ \left(\left(-\frac{0^3}{3} - 0^2\right) - \left(-\frac{(-2)^3}{3} - (-2)^2\right)\right)$$

$$- \left(\left(-\frac{2^3}{3} - 2^2\right) - \left(-\frac{0^3}{3} - 0^2\right)\right) = \frac{28}{3}$$

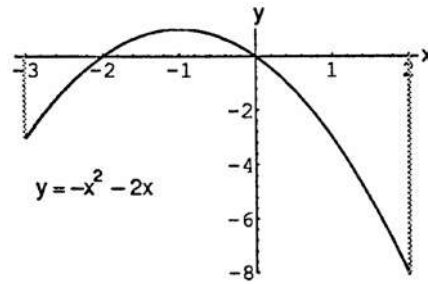

38. $3x^2 - 3 = 0 \Rightarrow x^2 = 1 \Rightarrow x = \pm 1$; because of symmetry about the y-axis, Area = $2\left(-\int_0^1 (3x^2 - 3)dx + \int_1^2 (3x^2 - 3)dx\right)$

$$2\left(-[x^3 - 3x]_0^1 + [x^3 - 3x]_1^2\right) = 2[-((1^3 - 3(1)) - (0^3 - 3(0)))]$$

$$+ ((2^3 - 3(2)) - (1^3 - 3(1))) = 2(6) = 12$$

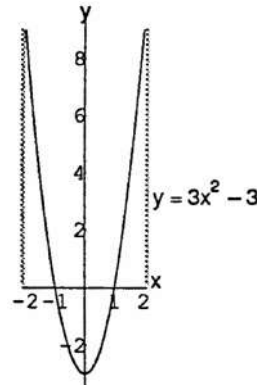

39. $x^3 - 3x^2 + 2x = 0 \Rightarrow x(x^2 - 3x + 2) = 0$
 $\Rightarrow x(x - 2)(x - 1) = 0 \Rightarrow x = 0, 1,$ or 2 ;

Area = $\int_0^1 (x^3 - 3x^2 + 2x)dx - \int_1^2 (x^3 - 3x^2 + 2x)dx$

$$= \left[\frac{x^4}{4} - x^3 + x^2\right]_0^1 - \left[\frac{x^4}{4} - x^3 + x^2\right]_1^2$$

$$= \left(\frac{1^4}{4} - 1^3 + 1^2\right) - \left(\frac{0^4}{4} - 0^3 + 0^2\right)$$

$$- \left[\left(\frac{2^4}{4} - 2^3 + 2^2\right) - \left(\frac{1^4}{4} - 1^3 + 1^2\right)\right] = \frac{1}{2}$$

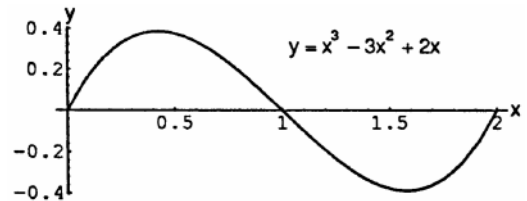

40. $x^3 - 4x = 0 \Rightarrow x(x^2 - 4) = 0 \Rightarrow x(x - 2)(x + 2) = 0$
 $\Rightarrow x = 0, 2,$ or -2 . Area = $\int_{-2}^0 (x^3 - 4x)dx - \int_0^2 (x^3 - 4x)dx$

$$= \left[\frac{x^4}{4} - 2x^2\right]_{-2}^0 - \left[\frac{x^4}{4} - 2x^2\right]_0^2 = \left(\frac{0^4}{4} - 2(0)^2\right)$$

$$- \left(\frac{(-2)^4}{4} - 2(-2)^2\right) - \left[\left(\frac{2^4}{4} - 2(2)^2\right) - \left(\frac{0^4}{4} - 2(0)^2\right)\right] = 8$$

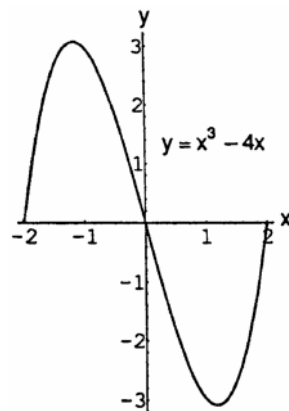

41. $x^{1/3} = 0 \Rightarrow x = 0$; Area = $-\int_{-1}^0 x^{1/3} dx + \int_0^8 x^{1/3} dx$

$$= \left[-\frac{3}{4}x^{4/3}\right]_{-1}^0 + \left[\frac{3}{4}x^{4/3}\right]_0^8$$

$$= \left(-\frac{3}{4}(0)^{4/3}\right) - \left(-\frac{3}{4}(-1)^{4/3}\right) + \left(\frac{3}{4}(8)^{4/3}\right) - \left(\frac{3}{4}(0)^{4/3}\right)$$

$$= \frac{51}{4}$$

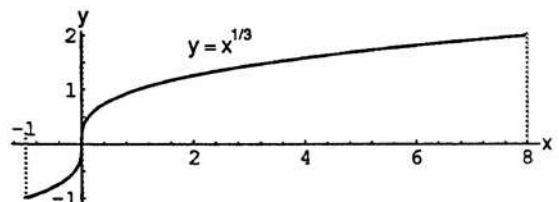

$$42. x^{1/3} - x = 0 \Rightarrow x^{1/3}(1 - x^{2/3}) = 0 \Rightarrow x^{1/3} = 0 \text{ or } \\ 1 - x^{2/3} = 0 \Rightarrow x = 0 \text{ or } 1 = x^{2/3} \Rightarrow x = 0 \text{ or } \\ 1 = x^2 \Rightarrow x = 0 \text{ or } \pm 1;$$

$$\begin{aligned} \text{Area} &= - \int_{-1}^0 (x^{1/3} - x) dx + \int_0^1 (x^{1/3} - x) dx - \int_1^8 (x^{1/3} - x) dx \\ &= - \left[\frac{3}{4} x^{4/3} - \frac{x^2}{2} \right]_{-1}^0 + \left[\frac{3}{4} x^{4/3} - \frac{x^2}{2} \right]_0^1 - \left[\frac{3}{4} x^{4/3} - \frac{x^2}{2} \right]_1^8 \\ &= - \left[\left(\frac{3}{4} (0)^{4/3} - \frac{0^2}{2} \right) - \left(\frac{3}{4} (-1)^{4/3} - \frac{(-1)^2}{2} \right) \right] \\ &\quad + \left[\left(\frac{3}{4} (1)^{4/3} - \frac{1^2}{2} \right) - \left(\frac{3}{4} (0)^{4/3} - \frac{0^2}{2} \right) \right] \\ &\quad - \left[\left(\frac{3}{4} (8)^{4/3} - \frac{8^2}{2} \right) - \left(\frac{3}{4} (1)^{4/3} - \frac{1^2}{2} \right) \right] \\ &= \frac{1}{4} + \frac{1}{4} - \left(-20 - \frac{3}{4} + \frac{1}{2} \right) = \frac{83}{4} \end{aligned}$$

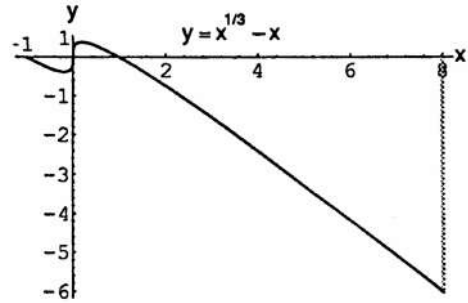

43. The area of the rectangle bounded by the lines $y = 2$, $y = 0$, $x = \pi$, and $x = 0$ is 2π . The area under the curve $y = 1 + \cos x$ on $[0, \pi]$ is $\int_0^\pi (1 + \cos x) dx = [x + \sin x]_0^\pi = (\pi + \sin \pi) - (0 + \sin 0) = \pi$. Therefore the area of the shaded region is $2\pi - \pi = \pi$.

44. The area of the rectangle bounded by the lines $x = \frac{\pi}{6}$, $x = \frac{5\pi}{6}$, $y = \sin \frac{\pi}{6} = \frac{1}{2} = \sin \frac{5\pi}{6}$, and $y = 0$ is $\frac{1}{2} \left(\frac{5\pi}{6} - \frac{\pi}{6} \right) = \frac{\pi}{3}$. The area under the curve $y = \sin x$ on $[\frac{\pi}{6}, \frac{5\pi}{6}]$ is $\int_{\pi/6}^{5\pi/6} \sin x dx = [-\cos x]_{\pi/6}^{5\pi/6} = (-\cos \frac{5\pi}{6}) - (-\cos \frac{\pi}{6}) = -\left(-\frac{\sqrt{3}}{2}\right) + \frac{\sqrt{3}}{2} = \sqrt{3}$. Therefore the area of the shaded region is $\sqrt{3} - \frac{\pi}{3}$.

45. On $[-\frac{\pi}{4}, 0]$: The area of the rectangle bounded by the lines $y = \sqrt{2}$, $y = 0$, $\theta = 0$, and $\theta = -\frac{\pi}{4}$ is $\sqrt{2} \left(\frac{\pi}{4} \right) = \frac{\pi\sqrt{2}}{4}$. The area between the curve $y = \sec \theta \tan \theta$ and $y = 0$ is $-\int_{-\pi/4}^0 \sec \theta \tan \theta d\theta = [-\sec \theta]_{-\pi/4}^0 = (-\sec 0) - (-\sec(-\frac{\pi}{4})) = \sqrt{2} - 1$. Therefore the area of the shaded region on $[-\frac{\pi}{4}, 0]$ is $\frac{\pi\sqrt{2}}{4} + (\sqrt{2} - 1)$.
On $[0, \frac{\pi}{4}]$: The area of the rectangle bounded by $\theta = \frac{\pi}{4}$, $\theta = 0$, $y = \sqrt{2}$, and $y = 0$ is $\sqrt{2} \left(\frac{\pi}{4} \right) = \frac{\pi\sqrt{2}}{4}$. The area under the curve $y = \sec \theta \tan \theta$ is $\int_0^{\pi/4} \sec \theta \tan \theta d\theta = [\sec \theta]_0^{\pi/4} = \sec \frac{\pi}{4} - \sec 0 = \sqrt{2} - 1$. Therefore the area of the shaded region on $[0, \frac{\pi}{4}]$ is $\frac{\pi\sqrt{2}}{4} - (\sqrt{2} - 1)$. Thus, the area of the total shaded region is $\left(\frac{\pi\sqrt{2}}{4} + \sqrt{2} - 1 \right) + \left(\frac{\pi\sqrt{2}}{4} - \sqrt{2} + 1 \right) = \frac{\pi\sqrt{2}}{2}$.

46. The area of the rectangle bounded by the lines $y = 2$, $y = 0$, $t = -\frac{\pi}{4}$, and $t = 1$ is $2 \left(1 - \left(-\frac{\pi}{4}\right) \right) = 2 + \frac{\pi}{2}$. The area under the curve $y = \sec^2 t$ on $[-\frac{\pi}{4}, 0]$ is $\int_{-\pi/4}^0 \sec^2 t dt = [\tan t]_{-\pi/4}^0 = \tan 0 - \tan\left(-\frac{\pi}{4}\right) = 1$. The area under the curve $y = 1 - t^2$ on $[0, 1]$ is $\int_0^1 (1 - t^2) dt = \left[t - \frac{t^3}{3} \right]_0^1 = \left(1 - \frac{1^3}{3} \right) - \left(0 - \frac{0^3}{3} \right) = \frac{2}{3}$. Thus, the total area under the curves on $[-\frac{\pi}{4}, 1]$ is $1 + \frac{2}{3} = \frac{5}{3}$. Therefore the area of the shaded region is $\left(2 + \frac{\pi}{2} \right) - \frac{5}{3} = \frac{1}{3} + \frac{\pi}{2}$.

47. $y = \int_\pi^x \frac{1}{t} dt - 3 \Rightarrow \frac{dy}{dx} = \frac{1}{x}$ and $y(\pi) = \int_\pi^\pi \frac{1}{t} dt - 3 = 0 - 3 = -3 \Rightarrow$ (d) is a solution to this problem.

48. $y = \int_{-1}^x \sec t dt + 4 \Rightarrow \frac{dy}{dx} = \sec x$ and $y(-1) = \int_{-1}^{-1} \sec t dt + 4 = 0 + 4 = 4 \Rightarrow$ (c) is a solution to this problem.

49. $y = \int_0^x \sec t dt + 4 \Rightarrow \frac{dy}{dx} = \sec x$ and $y(0) = \int_0^0 \sec t dt + 4 = 0 + 4 = 4 \Rightarrow$ (b) is a solution to this problem.

50. $y = \int_1^x \frac{1}{t} dt - 3 \Rightarrow \frac{dy}{dx} = \frac{1}{x}$ and $y(1) = \int_1^1 \frac{1}{t} dt - 3 = 0 - 3 = -3 \Rightarrow$ (a) is a solution to this problem.

51. $y = \int_2^x \sec t dt + 3$

52. $y = \int_1^x \sqrt{1+t^2} dt - 2$

53. $s = \int_{t_0}^t f(x) dx + s_0$

54. $v = \int_{t_0}^t g(x) dx + v_0$

55. Area = $\int_{-b/2}^{b/2} (h - \frac{4h}{b^2} x^2) dx = [hx - \frac{4hx^3}{3b^2}]_{-b/2}^{b/2}$
 $= (h(\frac{b}{2}) - \frac{4h(\frac{b}{2})^3}{3b^2}) - (h(-\frac{b}{2}) - \frac{4h(-\frac{b}{2})^3}{3b^2})$
 $= (\frac{bh}{2} - \frac{bh}{6}) - (-\frac{bh}{2} + \frac{bh}{6}) = bh - \frac{bh}{3} = \frac{2}{3} bh$

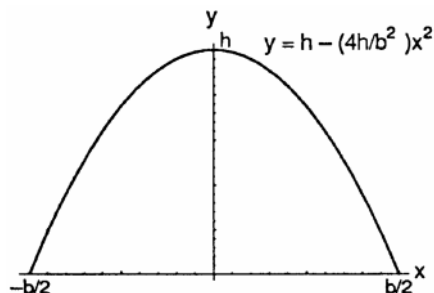

56. $r = \int_0^3 (2 - \frac{2}{(x+1)^2}) dx = 2 \int_0^3 (1 - \frac{1}{(x+1)^2}) dx = 2 [x - (\frac{-1}{x+1})]_0^3 = 2 [(3 + \frac{1}{3+1}) - (0 + \frac{1}{0+1})]$
 $= 2 [3\frac{1}{4} - 1] = 2(2\frac{1}{4}) = 4.5$ or \$4500

57. $\frac{dc}{dx} = \frac{1}{2\sqrt{x}} = \frac{1}{2} x^{-1/2} \Rightarrow c = \int_0^x \frac{1}{2} t^{-1/2} dt = [t^{1/2}]_0^x = \sqrt{x}$
 $c(100) - c(1) = \sqrt{100} - \sqrt{1} = \9.00

58. By Exercise 57, $c(400) - c(100) = \sqrt{400} - \sqrt{100} = 20 - 10 = \10.00

59. (a) $v = \frac{ds}{dt} = \frac{d}{dt} \int_0^t f(x) dx = f(t) \Rightarrow v(5) = f(5) = 2$ m/sec

(b) $a = \frac{dv}{dt}$ is negative since the slope of the tangent line at $t = 5$ is negative

(c) $s = \int_0^3 f(x) dx = \frac{1}{2}(3)(3) = \frac{9}{2}$ m since the integral is the area of the triangle formed by $y = f(x)$, the x-axis, and $x = 3$

(d) $t = 6$ since from $t = 6$ to $t = 9$, the region lies below the x-axis

(e) At $t = 4$ and $t = 7$, since there are horizontal tangents there

(f) Toward the origin between $t = 6$ and $t = 9$ since the velocity is negative on this interval. Away from the origin between $t = 0$ and $t = 6$ since the velocity is positive there.

(g) Right or positive side, because the integral of f from 0 to 9 is positive, there being more area above the x-axis than below it.

60. (a) $v = \frac{dg}{dt} = \frac{d}{dt} \int_0^t g(x) dx = g(t) \Rightarrow v(3) = g(3) = 0$ m/sec.

(b) $a = \frac{dv}{dt}$ is positive, since the slope of the tangent line at $t = 3$ is positive

(c) At $t = 3$, the particle's position is $\int_0^3 g(x) dx = \frac{1}{2}(3)(-6) = -9$

(d) The particle passes through the origin at $t = 6$ because $s(6) = \int_0^6 g(x) dx = 0$

(e) At $t = 7$, since there is a horizontal tangent there

(f) The particle starts at the origin and moves away to the left for $0 < t < 3$. It moves back toward the origin for $3 < t < 6$, passes through the origin at $t = 6$, and moves away to the right for $t > 6$.

(g) Right side, since its position at $t = 9$ is positive, there being more area above the x-axis than below it at $t = 9$.

61. $k > 0 \Rightarrow$ one arch of $y = \sin kx$ will occur over the interval $[0, \frac{\pi}{k}] \Rightarrow$ the area $= \int_0^{\pi/k} \sin kx \, dx = [-\frac{1}{k} \cos kx]_0^{\pi/k}$
 $= -\frac{1}{k} \cos(k(\frac{\pi}{k})) - (-\frac{1}{k} \cos(0)) = \frac{2}{k}$

62. $\lim_{x \rightarrow 0} \frac{1}{x^3} \int_0^x \frac{t^2}{t^4+1} dt = \lim_{x \rightarrow 0} \frac{\int_0^x \frac{t^2}{t^4+1} dt}{\frac{x^3}{3x^2}} = \lim_{x \rightarrow 0} \frac{\frac{x^2}{x^4+1}}{3x^2} = \lim_{x \rightarrow 0} \frac{1}{3(x^4+1)} = \infty.$

63. $\int_1^x f(t) dt = x^2 - 2x + 1 \Rightarrow f(x) = \frac{d}{dx} \int_1^x f(t) dt = \frac{d}{dx} (x^2 - 2x + 1) = 2x - 2$

64. $\int_0^x f(t) dt = x \cos \pi x \Rightarrow f(x) = \frac{d}{dx} \int_0^x f(t) dt = \cos \pi x - \pi x \sin \pi x \Rightarrow f(4) = \cos \pi(4) - \pi(4) \sin \pi(4) = 1$

65. $f(x) = 2 - \int_2^{x+1} \frac{9}{1+t} dt \Rightarrow f'(x) = -\frac{9}{1+(x+1)} = \frac{-9}{x+2} \Rightarrow f'(1) = -3; f(1) = 2 - \int_2^{1+1} \frac{9}{1+t} dt = 2 - 0 = 2;$
 $L(x) = -3(x - 1) + f(1) = -3(x - 1) + 2 = -3x + 5$

66. $g(x) = 3 + \int_1^{x^2} \sec(t - 1) dt \Rightarrow g'(x) = (\sec(x^2 - 1))(2x) = 2x \sec(x^2 - 1) \Rightarrow g'(-1) = 2(-1) \sec((-1)^2 - 1)$
 $= -2; g(-1) = 3 + \int_1^{(-1)^2} \sec(t - 1) dt = 3 + \int_1^1 \sec(t - 1) dt = 3 + 0 = 3; L(x) = -2(x - (-1)) + g(-1)$
 $= -2(x + 1) + 3 = -2x + 1$

67. (a) True: since f is continuous, g is differentiable by Part 1 of the Fundamental Theorem of Calculus.
 (b) True: g is continuous because it is differentiable.
 (c) True, since $g'(1) = f(1) = 0$.
 (d) False, since $g''(1) = f'(1) > 0$.
 (e) True, since $g'(1) = 0$ and $g''(1) = f'(1) > 0$.
 (f) False: $g''(x) = f'(x) > 0$, so g'' never changes sign.
 (g) True, since $g'(1) = f(1) = 0$ and $g'(x) = f(x)$ is an increasing function of x (because $f'(x) > 0$).

68. (a) True: by Part 1 of the Fundamental Theorem of Calculus, $h'(x) = f(x)$. Since f is differentiable for all x , h has a second derivative for all x .
 (b) True: they are continuous because they are differentiable.
 (c) True, since $h'(1) = f(1) = 0$.
 (d) True, since $h'(1) = 0$ and $h''(1) = f'(1) < 0$.
 (e) False, since $h''(1) = f'(1) < 0$.
 (f) False, since $h''(x) = f'(x) < 0$ never changes sign.
 (g) True, since $h'(1) = f(1) = 0$ and $h'(x) = f(x)$ is a decreasing function of x (because $f'(x) < 0$).

69.

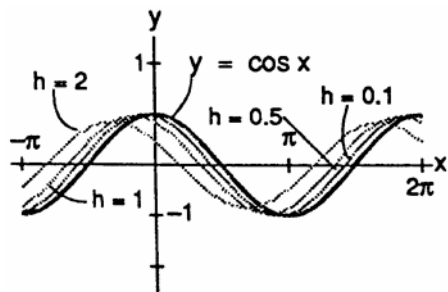

70. The limit is $3x^2$

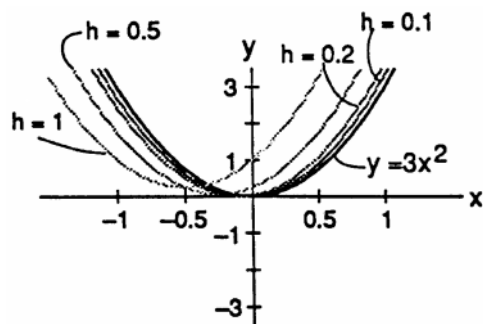

71-74. Example CAS commands:

Maple:

```

with( plots );
f := x -> x^3-4*x^2+3*x;
a := 0;
b := 4;
F := unapply( int(f(t),t=a..x), x );          # (a)
p1 := plot( [f(x),F(x)], x=a..b, legend=["y = f(x)", "y = F(x)"], title="#71(a) (Section 5.4)" );
p1;
dF := D(F);                                  # (b)
q1 := solve( dF(x)=0, x );
pts1 := [ seq( [x,f(x)], x=remove(has,evalf([q1]),I) ) ];
p2 := plot( pts1, style=point, color=blue, symbolsize=18, symbol=diamond, legend="(x,f(x)) where F'(x)=0" );
display( [p1,p2], title="71(b) (Section 5.4)" );
incr := solve( dF(x)>0, x );                  # (c)
decr := solve( dF(x)<0, x );
df := D(f);                                  # (d)
p3 := plot( [df(x),F(x)], x=a..b, legend=["y = f'(x)", "y = F(x)"], title="#71(d) (Section 5.4)" );
p3;
q2 := solve( df(x)=0, x );
pts2 := [ seq( [x,F(x)], x=remove(has,evalf([q2]),I) ) ];
p4 := plot( pts2, style=point, color=blue, symbolsize=18, symbol=diamond, legend="(x,f(x)) where f'(x)=0" );
display( [p3,p4], title="71(d) (Section 5.4)" );

```

75-78. Example CAS commands:

Maple:

```

a := 1;
u := x -> x^2;
f := x -> sqrt(1-x^2);
F := unapply( int( f(t), t=a..u(x) ), x );
dF := D(F);                                  # (b)
cp := solve( dF(x)=0, x );
solve( dF(x)>0, x );
solve( dF(x)<0, x );
d2F := D(dF);                                # (c)
solve( d2F(x)=0, x );
plot( F(x), x=-1..1, title="#75(d) (Section 5.4)" );

```

79. Example CAS commands:

Maple:

```

f := `f`;
q1 := Diff( Int( f(t), t=a..u(x) ), x );
d1 := value( q1 );

```

80. Example CAS commands:

Maple:

```

f := `f`;
q2 := Diff( Int( f(t), t=a..u(x) ), x,x );

```

value(q2);

71-80. Example CAS commands:

Mathematica: (assigned function and values for a, and b may vary)

For transcendental functions the FindRoot is needed instead of the Solve command.

The Map command executes FindRoot over a set of initial guesses

Initial guesses will vary as the functions vary.

```
Clear[x, f, F]
{a, b} = {0, 2π}; f[x_] = Sin[2x] Cos[x/3]
F[x_] = Integrate[f[t], {t, a, x}]
Plot[{f[x], F[x]}, {x, a, b}]
x/.Map[FindRoot[F'[x]==0, {x, #}] &, {2, 3, 5, 6}]
x/.Map[FindRoot[f'[x]==0, {x, #}] &, {1, 2, 4, 5, 6}]
```

Slightly alter above commands for 75 - 80.

```
Clear[x, f, F, u]
a=0; f[x_] = x2 - 2x - 3
u[x_] = 1 - x2
F[x_] = Integrate[f[t], {t, a, u(x)}]
x/.Map[FindRoot[F'[x]==0, {x, #}] &, {1, 2, 3, 4}]
x/.Map[FindRoot[F''[x]==0, {x, #}] &, {1, 2, 3, 4}]
```

After determining an appropriate value for b, the following can be entered

```
b = 4;
Plot[{F[x], {x, a, b}]
```

5.5 INDEFINITE INTEGRALS AND THE SUBSTITUTION RULE

1. Let $u = 3x \Rightarrow du = 3 dx \Rightarrow \frac{1}{3} du = dx$

$$\int \sin 3x dx = \int \frac{1}{3} \sin u du = -\frac{1}{3} \cos u + C = -\frac{1}{3} \cos 3x + C$$

2. Let $u = 2x^2 \Rightarrow du = 4x dx \Rightarrow \frac{1}{4} du = x dx$

$$\int x \sin(2x^2) dx = \int \frac{1}{4} \sin u du = -\frac{1}{4} \cos u + C = -\frac{1}{4} \cos 2x^2 + C$$

3. Let $u = 2t \Rightarrow du = 2 dt \Rightarrow \frac{1}{2} du = dt$

$$\int \sec 2t \tan 2t dt = \int \frac{1}{2} \sec u \tan u du = \frac{1}{2} \sec u + C = \frac{1}{2} \sec 2t + C$$

4. Let $u = 1 - \cos \frac{t}{2} \Rightarrow du = \frac{1}{2} \sin \frac{t}{2} dt \Rightarrow 2 du = \sin \frac{t}{2} dt$

$$\int (1 - \cos \frac{t}{2})^2 (\sin \frac{t}{2}) dt = \int 2u^2 du = \frac{2}{3} u^3 + C = \frac{2}{3} (1 - \cos \frac{t}{2})^3 + C$$

5. Let $u = 7x - 2 \Rightarrow du = 7 dx \Rightarrow \frac{1}{7} du = dx$

$$\int 28(7x - 2)^{-5} dx = \int \frac{1}{7} (28)u^{-5} du = \int 4u^{-5} du = -u^{-4} + C = -(7x - 2)^{-4} + C$$

6. Let $u = x^4 - 1 \Rightarrow du = 4x^3 dx \Rightarrow \frac{1}{4} du = x^3 dx$

$$\int x^3 (x^4 - 1)^2 dx = \int \frac{1}{4} u^2 du = \frac{u^3}{12} + C = \frac{1}{12} (x^4 - 1)^3 + C$$

7. Let $u = 1 - r^3 \Rightarrow du = -3r^2 dr \Rightarrow -3 du = 9r^2 dr$

$$\int \frac{9r^2 dr}{\sqrt{1-r^3}} = \int -3u^{-1/2} du = -3(2)u^{1/2} + C = -6(1-r^3)^{1/2} + C$$

8. Let $u = y^4 + 4y^2 + 1 \Rightarrow du = (4y^3 + 8y) dy \Rightarrow 3 du = 12(y^3 + 2y) dy$

$$\int 12(y^4 + 4y^2 + 1)^2 (y^3 + 2y) dy = \int 3u^2 du = u^3 + C = (y^4 + 4y^2 + 1)^3 + C$$

9. Let $u = x^{3/2} - 1 \Rightarrow du = \frac{3}{2} x^{1/2} dx \Rightarrow \frac{2}{3} du = \sqrt{x} dx$

$$\int \sqrt{x} \sin^2(x^{3/2} - 1) dx = \int \frac{2}{3} \sin^2 u du = \frac{2}{3} \left(\frac{u}{2} - \frac{1}{4} \sin 2u \right) + C = \frac{1}{3} (x^{3/2} - 1) - \frac{1}{6} \sin(2x^{3/2} - 2) + C$$

10. Let $u = -\frac{1}{x} \Rightarrow du = \frac{1}{x^2} dx$

$$\begin{aligned} \int \frac{1}{x^2} \cos^2\left(\frac{1}{x}\right) dx &= \int \cos^2(-u) du = \int \cos^2(u) du = \left(\frac{u}{2} + \frac{1}{4} \sin 2u\right) + C = -\frac{1}{2x} + \frac{1}{4} \sin\left(-\frac{2}{x}\right) + C \\ &= -\frac{1}{2x} - \frac{1}{4} \sin\left(\frac{2}{x}\right) + C \end{aligned}$$

11. (a) Let $u = \cot 2\theta \Rightarrow du = -2 \csc^2 2\theta d\theta \Rightarrow -\frac{1}{2} du = \csc^2 2\theta d\theta$

$$\int \csc^2 2\theta \cot 2\theta d\theta = -\int \frac{1}{2} u du = -\frac{1}{2} \left(\frac{u^2}{2}\right) + C = -\frac{u^2}{4} + C = -\frac{1}{4} \cot^2 2\theta + C$$

(b) Let $u = \csc 2\theta \Rightarrow du = -2 \csc 2\theta \cot 2\theta d\theta \Rightarrow -\frac{1}{2} du = \csc 2\theta \cot 2\theta d\theta$

$$\int \csc^2 2\theta \cot 2\theta d\theta = \int -\frac{1}{2} u du = -\frac{1}{2} \left(\frac{u^2}{2}\right) + C = -\frac{u^2}{4} + C = -\frac{1}{4} \csc^2 2\theta + C$$

12. (a) Let $u = 5x + 8 \Rightarrow du = 5 dx \Rightarrow \frac{1}{5} du = dx$

$$\int \frac{dx}{\sqrt{5x+8}} = \int \frac{1}{5} \left(\frac{1}{\sqrt{u}}\right) du = \frac{1}{5} \int u^{-1/2} du = \frac{1}{5} (2u^{1/2}) + C = \frac{2}{5} u^{1/2} + C = \frac{2}{5} \sqrt{5x+8} + C$$

(b) Let $u = \sqrt{5x+8} \Rightarrow du = \frac{1}{2} (5x+8)^{-1/2} (5) dx \Rightarrow \frac{2}{5} du = \frac{dx}{\sqrt{5x+8}}$

$$\int \frac{dx}{\sqrt{5x+8}} = \int \frac{2}{5} du = \frac{2}{5} u + C = \frac{2}{5} \sqrt{5x+8} + C$$

13. Let $u = 3 - 2s \Rightarrow du = -2 ds \Rightarrow -\frac{1}{2} du = ds$

$$\int \sqrt{3-2s} ds = \int \sqrt{u} \left(-\frac{1}{2} du\right) = -\frac{1}{2} \int u^{1/2} du = \left(-\frac{1}{2}\right) \left(\frac{2}{3} u^{3/2}\right) + C = -\frac{1}{3} (3-2s)^{3/2} + C$$

14. Let $u = 2x + 1 \Rightarrow du = 2 dx \Rightarrow \frac{1}{2} du = dx$

$$\int (2x+1)^3 dx = \int u^3 \left(\frac{1}{2} du\right) = \frac{1}{2} \int u^3 du = \left(\frac{1}{2}\right) \left(\frac{u^4}{4}\right) + C = \frac{1}{8} (2x+1)^4 + C$$

15. Let $u = 5s + 4 \Rightarrow du = 5 ds \Rightarrow \frac{1}{5} du = ds$

$$\int \frac{1}{\sqrt{5s+4}} ds = \int \frac{1}{\sqrt{u}} \left(\frac{1}{5} du\right) = \frac{1}{5} \int u^{-1/2} du = \left(\frac{1}{5}\right) (2u^{1/2}) + C = \frac{2}{5} \sqrt{5s+4} + C$$

16. Let $u = 2 - x \Rightarrow du = -dx \Rightarrow -du = dx$

$$\int \frac{3}{(2-x)^2} dx = \int \frac{3(-du)}{u^2} = -3 \int u^{-2} du = -3 \left(\frac{u^{-1}}{-1}\right) + C = \frac{3}{2-x} + C$$

17. Let $u = 1 - \theta^2 \Rightarrow du = -2\theta d\theta \Rightarrow -\frac{1}{2} du = \theta d\theta$

$$\int \theta^4 \sqrt{1-\theta^2} d\theta = \int^4 \sqrt{u} \left(-\frac{1}{2} du\right) = -\frac{1}{2} \int u^{1/4} du = \left(-\frac{1}{2}\right) \left(\frac{4}{5} u^{5/4}\right) + C = -\frac{2}{5} (1-\theta^2)^{5/4} + C$$

18. Let $u = \theta^2 - 1 \Rightarrow du = 2\theta d\theta \Rightarrow 4 du = 8\theta d\theta$

$$\int 8\theta^3 \sqrt{\theta^2 - 1} d\theta = \int^3 \sqrt{u} (4 du) = 4 \int u^{1/3} du = 4 \left(\frac{3}{4} u^{4/3}\right) + C = 3(\theta^2 - 1)^{4/3} + C$$

19. Let $u = 7 - 3y^2 \Rightarrow du = -6y dy \Rightarrow -\frac{1}{2} du = 3y dy$

$$\int 3y\sqrt{7-3y^2} dy = \int \sqrt{u} \left(-\frac{1}{2} du\right) = -\frac{1}{2} \int u^{1/2} du = \left(-\frac{1}{2}\right) \left(\frac{2}{3} u^{3/2}\right) + C = -\frac{1}{3} (7-3y^2)^{3/2} + C$$

20. Let $u = 2y^2 + 1 \Rightarrow du = 4y dy$

$$\int \frac{4y dy}{\sqrt{2y^2+1}} = \int \frac{1}{\sqrt{u}} du = \int u^{-1/2} du = 2u^{1/2} + C = 2\sqrt{2y^2+1} + C$$

21. Let $u = 1 + \sqrt{x} \Rightarrow du = \frac{1}{2\sqrt{x}} dx \Rightarrow 2 du = \frac{1}{\sqrt{x}} dx$

$$\int \frac{1}{\sqrt{x}(1+\sqrt{x})^2} dx = \int \frac{2 du}{u^2} = -\frac{2}{u} + C = \frac{-2}{1+\sqrt{x}} + C$$

22. Let $u = 1 + \sqrt{x} \Rightarrow du = \frac{1}{2\sqrt{x}} dx \Rightarrow 2 du = \frac{1}{\sqrt{x}} dx$

$$\int \frac{(1+\sqrt{x})^3}{\sqrt{x}} dx = \int u^3 (2 du) = 2 \left(\frac{1}{4} u^4\right) + C = \frac{1}{2} (1 + \sqrt{x})^4 + C$$

23. Let $u = 3z + 4 \Rightarrow du = 3 dz \Rightarrow \frac{1}{3} du = dz$

$$\int \cos(3z+4) dz = \int (\cos u) \left(\frac{1}{3} du\right) = \frac{1}{3} \int \cos u du = \frac{1}{3} \sin u + C = \frac{1}{3} \sin(3z+4) + C$$

24. Let $u = 8z - 5 \Rightarrow du = 8 dz \Rightarrow \frac{1}{8} du = dz$

$$\int \sin(8z-5) dz = \int (\sin u) \left(\frac{1}{8} du\right) = \frac{1}{8} \int \sin u du = \frac{1}{8} (-\cos u) + C = -\frac{1}{8} \cos(8z-5) + C$$

25. Let $u = 3x + 2 \Rightarrow du = 3 dx \Rightarrow \frac{1}{3} du = dx$

$$\int \sec^2(3x+2) dx = \int (\sec^2 u) \left(\frac{1}{3} du\right) = \frac{1}{3} \int \sec^2 u du = \frac{1}{3} \tan u + C = \frac{1}{3} \tan(3x+2) + C$$

26. Let $u = \tan x \Rightarrow du = \sec^2 x dx$

$$\int \tan^2 x \sec^2 x dx = \int u^2 du = \frac{1}{3} u^3 + C = \frac{1}{3} \tan^3 x + C$$

27. Let $u = \sin\left(\frac{x}{3}\right) \Rightarrow du = \frac{1}{3} \cos\left(\frac{x}{3}\right) dx \Rightarrow 3 du = \cos\left(\frac{x}{3}\right) dx$

$$\int \sin^5\left(\frac{x}{3}\right) \cos\left(\frac{x}{3}\right) dx = \int u^5 (3 du) = 3 \left(\frac{1}{6} u^6\right) + C = \frac{1}{2} \sin^6\left(\frac{x}{3}\right) + C$$

28. Let $u = \tan\left(\frac{x}{2}\right) \Rightarrow du = \frac{1}{2} \sec^2\left(\frac{x}{2}\right) dx \Rightarrow 2 du = \sec^2\left(\frac{x}{2}\right) dx$

$$\int \tan^7\left(\frac{x}{2}\right) \sec^2\left(\frac{x}{2}\right) dx = \int u^7 (2 du) = 2 \left(\frac{1}{8} u^8\right) + C = \frac{1}{4} \tan^8\left(\frac{x}{2}\right) + C$$

29. Let $u = \frac{r^3}{18} - 1 \Rightarrow du = \frac{r^2}{6} dr \Rightarrow 6 du = r^2 dr$

$$\int r^2 \left(\frac{r^3}{18} - 1\right)^5 dr = \int u^5 (6 du) = 6 \int u^5 du = 6 \left(\frac{u^6}{6}\right) + C = \left(\frac{r^3}{18} - 1\right)^6 + C$$

30. Let $u = 7 - \frac{r^5}{10} \Rightarrow du = -\frac{1}{2} r^4 dr \Rightarrow -2 du = r^4 dr$

$$\int r^4 \left(7 - \frac{r^5}{10}\right)^3 dr = \int u^3 (-2 du) = -2 \int u^3 du = -2 \left(\frac{u^4}{4}\right) + C = -\frac{1}{2} \left(7 - \frac{r^5}{10}\right)^4 + C$$

31. Let $u = x^{3/2} + 1 \Rightarrow du = \frac{3}{2} x^{1/2} dx \Rightarrow \frac{2}{3} du = x^{1/2} dx$

$$\int x^{1/2} \sin(x^{3/2} + 1) dx = \int (\sin u) \left(\frac{2}{3} du\right) = \frac{2}{3} \int \sin u du = \frac{2}{3} (-\cos u) + C = -\frac{2}{3} \cos(x^{3/2} + 1) + C$$

32. Let $u = x^{4/3} - 8 \Rightarrow du = \frac{4}{3} x^{1/3} dx \Rightarrow \frac{3}{4} du = x^{1/3} dx$
 $\int x^{1/3} \sin(x^{4/3} - 8) dx = \int (\sin u) \left(\frac{3}{4} du\right) = \frac{3}{4} \int \sin u du = \frac{3}{4} (-\cos u) + C = -\frac{3}{4} \cos(x^{4/3} - 8) + C$
33. Let $u = \sec(v + \frac{\pi}{2}) \Rightarrow du = \sec(v + \frac{\pi}{2}) \tan(v + \frac{\pi}{2}) dv$
 $\int \sec(v + \frac{\pi}{2}) \tan(v + \frac{\pi}{2}) dv = \int du = u + C = \sec(v + \frac{\pi}{2}) + C$
34. Let $u = \csc(\frac{v-\pi}{2}) \Rightarrow du = -\frac{1}{2} \csc(\frac{v-\pi}{2}) \cot(\frac{v-\pi}{2}) dv \Rightarrow -2 du = \csc(\frac{v-\pi}{2}) \cot(\frac{v-\pi}{2}) dv$
 $\int \csc(\frac{v-\pi}{2}) \cot(\frac{v-\pi}{2}) dv = \int -2 du = -2u + C = -2 \csc(\frac{v-\pi}{2}) + C$
35. Let $u = \cos(2t + 1) \Rightarrow du = -2 \sin(2t + 1) dt \Rightarrow -\frac{1}{2} du = \sin(2t + 1) dt$
 $\int \frac{\sin(2t+1)}{\cos^2(2t+1)} dt = \int -\frac{1}{2} \frac{du}{u^2} = \frac{1}{2u} + C = \frac{1}{2 \cos(2t+1)} + C$
36. Let $u = 2 + \sin t \Rightarrow du = \cos t dt$
 $\int \frac{6 \cos t}{(2 + \sin t)^3} dt = \int \frac{6}{u^3} du = 6 \int u^{-3} du = 6 \left(\frac{u^{-2}}{-2}\right) + C = -3(2 + \sin t)^{-2} + C$
37. Let $u = \cot y \Rightarrow du = -\csc^2 y dy \Rightarrow -du = \csc^2 y dy$
 $\int \sqrt{\cot y} \csc^2 y dy = \int \sqrt{u} (-du) = -\int u^{1/2} du = -\frac{2}{3} u^{3/2} + C = -\frac{2}{3} (\cot y)^{3/2} + C = -\frac{2}{3} (\cot^3 y)^{1/2} + C$
38. Let $u = \sec z \Rightarrow du = \sec z \tan z dz$
 $\int \frac{\sec z \tan z}{\sqrt{\sec z}} dz = \int \frac{1}{\sqrt{u}} du = \int u^{-1/2} du = 2u^{1/2} + C = 2\sqrt{\sec z} + C$
39. Let $u = \frac{1}{t} - 1 = t^{-1} - 1 \Rightarrow du = -t^{-2} dt \Rightarrow -du = \frac{1}{t^2} dt$
 $\int \frac{1}{t^2} \cos\left(\frac{1}{t} - 1\right) dt = \int (\cos u)(-du) = -\int \cos u du = -\sin u + C = -\sin\left(\frac{1}{t} - 1\right) + C$
40. Let $u = \sqrt{t} + 3 = t^{1/2} + 3 \Rightarrow du = \frac{1}{2} t^{-1/2} dt \Rightarrow 2 du = \frac{1}{\sqrt{t}} dt$
 $\int \frac{1}{\sqrt{t}} \cos(\sqrt{t} + 3) dt = \int (\cos u)(2 du) = 2 \int \cos u du = 2 \sin u + C = 2 \sin(\sqrt{t} + 3) + C$
41. Let $u = \sin \frac{1}{\theta} \Rightarrow du = \left(\cos \frac{1}{\theta}\right) \left(-\frac{1}{\theta^2}\right) d\theta \Rightarrow -du = \frac{1}{\theta^2} \cos \frac{1}{\theta} d\theta$
 $\int \frac{1}{\theta^2} \sin \frac{1}{\theta} \cos \frac{1}{\theta} d\theta = \int -u du = -\frac{1}{2} u^2 + C = -\frac{1}{2} \sin^2 \frac{1}{\theta} + C$
42. Let $u = \csc \sqrt{\theta} \Rightarrow du = \left(-\csc \sqrt{\theta} \cot \sqrt{\theta}\right) \left(\frac{1}{2\sqrt{\theta}}\right) d\theta \Rightarrow -2 du = \frac{1}{\sqrt{\theta}} \cot \sqrt{\theta} \csc \sqrt{\theta} d\theta$
 $\int \frac{\cos \sqrt{\theta}}{\sqrt{\theta} \sin^2 \sqrt{\theta}} d\theta = \int \frac{1}{\sqrt{\theta}} \cot \sqrt{\theta} \csc \sqrt{\theta} d\theta = \int -2 du = -2u + C = -2 \csc \sqrt{\theta} + C = -\frac{2}{\sin \sqrt{\theta}} + C$
43. Let $u = s^3 + 2s^2 - 5s + 5 \Rightarrow du = (3s^2 + 4s - 5) ds$
 $\int (s^3 + 2s^2 - 5s + 5)(3s^2 + 4s - 5) ds = \int u du = \frac{u^2}{2} + C = \frac{(s^3 + 2s^2 - 5s + 5)^2}{2} + C$
44. Let $u = \theta^4 - 2\theta^2 + 8\theta - 2 \Rightarrow du = (4\theta^3 - 4\theta + 8) d\theta \Rightarrow \frac{1}{4} du = (\theta^3 - \theta + 2) d\theta$
 $\int (\theta^4 - 2\theta^2 + 8\theta - 2)(\theta^3 - \theta + 2) d\theta = \int u \left(\frac{1}{4} du\right) = \frac{1}{4} \int u du = \frac{1}{4} \left(\frac{u^2}{2}\right) + C = \frac{(\theta^4 - 2\theta^2 + 8\theta - 2)^2}{8} + C$

45. Let $u = 1 + t^4 \Rightarrow du = 4t^3 dt \Rightarrow \frac{1}{4} du = t^3 dt$

$$\int t^3 (1 + t^4)^3 dt = \int u^3 \left(\frac{1}{4} du\right) = \frac{1}{4} \left(\frac{1}{4} u^4\right) + C = \frac{1}{16} (1 + t^4)^4 + C$$

46. Let $u = 1 - \frac{1}{x} \Rightarrow du = \frac{1}{x^2} dx$

$$\int \sqrt{\frac{x-1}{x^5}} dx = \int \frac{1}{x^2} \sqrt{\frac{x-1}{x}} dx = \int \frac{1}{x^2} \sqrt{1 - \frac{1}{x}} dx = \int \sqrt{u} du = \int u^{1/2} du = \frac{2}{3} u^{3/2} + C = \frac{2}{3} \left(1 - \frac{1}{x}\right)^{3/2} + C$$

47. Let $u = x^2 + 1$. Then $du = 2x dx$ and $\frac{1}{2} du = x dx$ and $x^2 = u - 1$. Thus $\int x^3 \sqrt{x^2 + 1} dx = \int (u - 1) \frac{1}{2} \sqrt{u} du$
 $= \frac{1}{2} \int (u^{3/2} - u^{1/2}) du = \frac{1}{2} \left[\frac{2}{5} u^{5/2} - \frac{2}{3} u^{3/2} \right] + C = \frac{1}{5} u^{5/2} - \frac{1}{3} u^{3/2} + C = \frac{1}{5} (x^2 + 1)^{5/2} - \frac{1}{3} (x^2 + 1)^{3/2} + C$

48. Let $u = x^3 + 1 \Rightarrow du = 3x^2 dx$ and $x^3 = u - 1$. So $\int 3x^5 \sqrt{x^3 + 1} dx = \int (u - 1) \sqrt{u} du = \int (u^{3/2} - u^{1/2}) du$
 $= \frac{2}{5} u^{5/2} - \frac{2}{3} u^{3/2} + C = \frac{2}{5} (x^3 + 1)^{5/2} - \frac{2}{3} (x^3 + 1)^{3/2} + C$

49. (a) Let $u = \tan x \Rightarrow du = \sec^2 x dx$; $v = u^3 \Rightarrow dv = 3u^2 du \Rightarrow 6 dv = 18u^2 du$; $w = 2 + v \Rightarrow dw = dv$

$$\int \frac{18 \tan^2 x \sec^2 x}{(2 + \tan^3 x)^2} dx = \int \frac{18u^2}{(2 + u^3)^2} du = \int \frac{6 dv}{(2 + v)^2} = \int \frac{6 dw}{w^2} = 6 \int w^{-2} dw = -6w^{-1} + C = -\frac{6}{2 + v} + C$$

$$= -\frac{6}{2 + u^3} + C = -\frac{6}{2 + \tan^3 x} + C$$

(b) Let $u = \tan^3 x \Rightarrow du = 3 \tan^2 x \sec^2 x dx \Rightarrow 6 du = 18 \tan^2 x \sec^2 x dx$; $v = 2 + u \Rightarrow dv = du$

$$\int \frac{18 \tan^2 x \sec^2 x}{(2 + \tan^3 x)^2} dx = \int \frac{6 du}{(2 + u)^2} = \int \frac{6 dv}{v^2} = -\frac{6}{v} + C = -\frac{6}{2 + u} + C = -\frac{6}{2 + \tan^3 x} + C$$

(c) Let $u = 2 + \tan^3 x \Rightarrow du = 3 \tan^2 x \sec^2 x dx \Rightarrow 6 du = 18 \tan^2 x \sec^2 x dx$

$$\int \frac{18 \tan^2 x \sec^2 x}{(2 + \tan^3 x)^2} dx = \int \frac{6 du}{u^2} = -\frac{6}{u} + C = -\frac{6}{2 + \tan^3 x} + C$$

50. (a) Let $u = x - 1 \Rightarrow du = dx$; $v = \sin u \Rightarrow dv = \cos u du$; $w = 1 + v^2 \Rightarrow dw = 2v dv \Rightarrow \frac{1}{2} dw = v dv$

$$\int \sqrt{1 + \sin^2(x - 1)} \sin(x - 1) \cos(x - 1) dx = \int \sqrt{1 + \sin^2 u} \sin u \cos u du = \int v \sqrt{1 + v^2} dv$$

$$= \int \frac{1}{2} \sqrt{w} dw = \frac{1}{3} w^{3/2} + C = \frac{1}{3} (1 + v^2)^{3/2} + C = \frac{1}{3} (1 + \sin^2 u)^{3/2} + C = \frac{1}{3} (1 + \sin^2(x - 1))^{3/2} + C$$

(b) Let $u = \sin(x - 1) \Rightarrow du = \cos(x - 1) dx$; $v = 1 + u^2 \Rightarrow dv = 2u du \Rightarrow \frac{1}{2} dv = u du$

$$\int \sqrt{1 + \sin^2(x - 1)} \sin(x - 1) \cos(x - 1) dx = \int u \sqrt{1 + u^2} du = \int \frac{1}{2} \sqrt{v} dv = \int \frac{1}{2} v^{1/2} dv$$

$$= \left(\frac{1}{2}\right) \left(\frac{2}{3}\right) v^{3/2} + C = \frac{1}{3} v^{3/2} + C = \frac{1}{3} (1 + u^2)^{3/2} + C = \frac{1}{3} (1 + \sin^2(x - 1))^{3/2} + C$$

(c) Let $u = 1 + \sin^2(x - 1) \Rightarrow du = 2 \sin(x - 1) \cos(x - 1) dx \Rightarrow \frac{1}{2} du = \sin(x - 1) \cos(x - 1) dx$

$$\int \sqrt{1 + \sin^2(x - 1)} \sin(x - 1) \cos(x - 1) dx = \int \frac{1}{2} \sqrt{u} du = \int \frac{1}{2} u^{1/2} du = \frac{1}{2} \left(\frac{2}{3} u^{3/2}\right) + C$$

$$= \frac{1}{3} (1 + \sin^2(x - 1))^{3/2} + C$$

51. Let $u = 3(2r - 1)^2 + 6 \Rightarrow du = 6(2r - 1)(2) dr \Rightarrow \frac{1}{12} du = (2r - 1) dr$; $v = \sqrt{u} \Rightarrow dv = \frac{1}{2\sqrt{u}} du \Rightarrow \frac{1}{6} dv$

$$= \frac{1}{12\sqrt{u}} du$$

$$\int \frac{(2r - 1) \cos \sqrt{3(2r - 1)^2 + 6}}{\sqrt{3(2r - 1)^2 + 6}} dr = \int \left(\frac{\cos \sqrt{u}}{\sqrt{u}}\right) \left(\frac{1}{12} du\right) = \int (\cos v) \left(\frac{1}{6} dv\right) = \frac{1}{6} \sin v + C = \frac{1}{6} \sin \sqrt{u} + C$$

$$= \frac{1}{6} \sin \sqrt{3(2r - 1)^2 + 6} + C$$

52. Let $u = \cos \sqrt{\theta} \Rightarrow du = (-\sin \sqrt{\theta}) \left(\frac{1}{2\sqrt{\theta}}\right) d\theta \Rightarrow -2 du = \frac{\sin \sqrt{\theta}}{\sqrt{\theta}} d\theta$

$$\int \frac{\sin \sqrt{\theta}}{\sqrt{\theta} \cos^3 \sqrt{\theta}} d\theta = \int \frac{\sin \sqrt{\theta}}{\sqrt{\theta} \sqrt{\cos^3 \sqrt{\theta}}} d\theta = \int \frac{-2 du}{u^{3/2}} = -2 \int u^{-3/2} du = -2 (-2u^{-1/2}) + C = \frac{4}{\sqrt{u}} + C$$

$$= \frac{4}{\sqrt{\cos \sqrt{\theta}}} + C$$

53. Let $u = 3t^2 - 1 \Rightarrow du = 6t dt \Rightarrow 2 du = 12t dt$

$$s = \int 12t (3t^2 - 1)^3 dt = \int u^3 (2 du) = 2 \left(\frac{1}{4} u^4\right) + C = \frac{1}{2} u^4 + C = \frac{1}{2} (3t^2 - 1)^4 + C;$$

$$s = 3 \text{ when } t = 1 \Rightarrow 3 = \frac{1}{2} (3 - 1)^4 + C \Rightarrow 3 = 8 + C \Rightarrow C = -5 \Rightarrow s = \frac{1}{2} (3t^2 - 1)^4 - 5$$

54. Let $u = x^2 + 8 \Rightarrow du = 2x dx \Rightarrow 2 du = 4x dx$

$$y = \int 4x (x^2 + 8)^{-1/3} dx = \int u^{-1/3} (2 du) = 2 \left(\frac{3}{2} u^{2/3}\right) + C = 3u^{2/3} + C = 3(x^2 + 8)^{2/3} + C;$$

$$y = 0 \text{ when } x = 0 \Rightarrow 0 = 3(8)^{2/3} + C \Rightarrow C = -12 \Rightarrow y = 3(x^2 + 8)^{2/3} - 12$$

55. Let $u = t + \frac{\pi}{12} \Rightarrow du = dt$

$$s = \int 8 \sin^2 \left(t + \frac{\pi}{12}\right) dt = \int 8 \sin^2 u du = 8 \left(\frac{u}{2} - \frac{1}{4} \sin 2u\right) + C = 4 \left(t + \frac{\pi}{12}\right) - 2 \sin \left(2t + \frac{\pi}{6}\right) + C;$$

$$s = 8 \text{ when } t = 0 \Rightarrow 8 = 4 \left(\frac{\pi}{12}\right) - 2 \sin \left(\frac{\pi}{6}\right) + C \Rightarrow C = 8 - \frac{\pi}{3} + 1 = 9 - \frac{\pi}{3}$$

$$\Rightarrow s = 4 \left(t + \frac{\pi}{12}\right) - 2 \sin \left(2t + \frac{\pi}{6}\right) + 9 - \frac{\pi}{3} = 4t - 2 \sin \left(2t + \frac{\pi}{6}\right) + 9$$

56. Let $u = \frac{\pi}{4} - \theta \Rightarrow -du = d\theta$

$$r = \int 3 \cos^2 \left(\frac{\pi}{4} - \theta\right) d\theta = -\int 3 \cos^2 u du = -3 \left(\frac{u}{2} + \frac{1}{4} \sin 2u\right) + C = -\frac{3}{2} \left(\frac{\pi}{4} - \theta\right) - \frac{3}{4} \sin \left(\frac{\pi}{2} - 2\theta\right) + C;$$

$$r = \frac{\pi}{8} \text{ when } \theta = 0 \Rightarrow \frac{\pi}{8} = -\frac{3\pi}{8} - \frac{3}{4} \sin \frac{\pi}{2} + C \Rightarrow C = \frac{\pi}{2} + \frac{3}{4} \Rightarrow r = -\frac{3}{2} \left(\frac{\pi}{4} - \theta\right) - \frac{3}{4} \sin \left(\frac{\pi}{2} - 2\theta\right) + \frac{\pi}{2} + \frac{3}{4}$$

$$\Rightarrow r = \frac{3}{2} \theta - \frac{3}{4} \sin \left(\frac{\pi}{2} - 2\theta\right) + \frac{\pi}{8} + \frac{3}{4} \Rightarrow r = \frac{3}{2} \theta - \frac{3}{4} \cos 2\theta + \frac{\pi}{8} + \frac{3}{4}$$

57. Let $u = 2t - \frac{\pi}{2} \Rightarrow du = 2 dt \Rightarrow -2 du = -4 dt$

$$\frac{ds}{dt} = \int -4 \sin \left(2t - \frac{\pi}{2}\right) dt = \int (\sin u)(-2 du) = 2 \cos u + C_1 = 2 \cos \left(2t - \frac{\pi}{2}\right) + C_1;$$

$$\text{at } t = 0 \text{ and } \frac{ds}{dt} = 100 \text{ we have } 100 = 2 \cos \left(-\frac{\pi}{2}\right) + C_1 \Rightarrow C_1 = 100 \Rightarrow \frac{ds}{dt} = 2 \cos \left(2t - \frac{\pi}{2}\right) + 100$$

$$\Rightarrow s = \int \left(2 \cos \left(2t - \frac{\pi}{2}\right) + 100\right) dt = \int (\cos u + 50) du = \sin u + 50u + C_2 = \sin \left(2t - \frac{\pi}{2}\right) + 50 \left(2t - \frac{\pi}{2}\right) + C_2;$$

$$\text{at } t = 0 \text{ and } s = 0 \text{ we have } 0 = \sin \left(-\frac{\pi}{2}\right) + 50 \left(-\frac{\pi}{2}\right) + C_2 \Rightarrow C_2 = 1 + 25\pi$$

$$\Rightarrow s = \sin \left(2t - \frac{\pi}{2}\right) + 100t - 25\pi + (1 + 25\pi) \Rightarrow s = \sin \left(2t - \frac{\pi}{2}\right) + 100t + 1$$

58. Let $u = \tan 2x \Rightarrow du = 2 \sec^2 2x dx \Rightarrow 2 du = 4 \sec^2 2x dx; v = 2x \Rightarrow dv = 2 dx \Rightarrow \frac{1}{2} dv = dx$

$$\frac{dy}{dx} = \int 4 \sec^2 2x \tan 2x dx = \int u(2 du) = u^2 + C_1 = \tan^2 2x + C_1;$$

$$\text{at } x = 0 \text{ and } \frac{dy}{dx} = 4 \text{ we have } 4 = 0 + C_1 \Rightarrow C_1 = 4 \Rightarrow \frac{dy}{dx} = \tan^2 2x + 4 = (\sec^2 2x - 1) + 4 = \sec^2 2x + 3$$

$$\Rightarrow y = \int (\sec^2 2x + 3) dx = \int (\sec^2 v + 3) \left(\frac{1}{2} dv\right) = \frac{1}{2} \tan v + \frac{3}{2} v + C_2 = \frac{1}{2} \tan 2x + 3x + C_2;$$

$$\text{at } x = 0 \text{ and } y = -1 \text{ we have } -1 = \frac{1}{2} (0) + 0 + C_2 \Rightarrow C_2 = -1 \Rightarrow y = \frac{1}{2} \tan 2x + 3x - 1$$

59. Let $u = 2t \Rightarrow du = 2 dt \Rightarrow 3 du = 6 dt$

$$s = \int 6 \sin 2t dt = \int (\sin u)(3 du) = -3 \cos u + C = -3 \cos 2t + C;$$

$$\text{at } t = 0 \text{ and } s = 0 \text{ we have } 0 = -3 \cos 0 + C \Rightarrow C = 3 \Rightarrow s = 3 - 3 \cos 2t \Rightarrow s \left(\frac{\pi}{2}\right) = 3 - 3 \cos(\pi) = 6 \text{ m}$$

60. Let $u = \pi t \Rightarrow du = \pi dt \Rightarrow \pi du = \pi^2 dt$

$$v = \int \pi^2 \cos \pi t dt = \int (\cos u)(\pi du) = \pi \sin u + C_1 = \pi \sin(\pi t) + C_1;$$

$$\text{at } t = 0 \text{ and } v = 8 \text{ we have } 8 = \pi(0) + C_1 \Rightarrow C_1 = 8 \Rightarrow v = \frac{ds}{dt} = \pi \sin(\pi t) + 8 \Rightarrow s = \int (\pi \sin(\pi t) + 8) dt$$

$$= \int \sin u du + 8t + C_2 = -\cos(\pi t) + 8t + C_2; \text{ at } t = 0 \text{ and } s = 0 \text{ we have } 0 = -1 + C_2 \Rightarrow C_2 = 1$$

$$\Rightarrow s = 8t - \cos(\pi t) + 1 \Rightarrow s(1) = 8 - \cos \pi + 1 = 10 \text{ m}$$

61. All three integrations are correct. In each case, the derivative of the function on the right is the integrand on the left, and each formula has an arbitrary constant for generating the remaining antiderivatives. Moreover, $\sin^2 x + C_1 = 1 - \cos^2 x + C_1 \Rightarrow C_2 = 1 + C_1$; also $-\cos^2 x + C_2 = -\frac{\cos 2x}{2} - \frac{1}{2} + C_2 \Rightarrow C_3 = C_2 - \frac{1}{2} = C_1 + \frac{1}{2}$.

62. Both integrations are correct. In each case, the derivative of the function on the right is the integrand on the left, and each formula has an arbitrary constant for generating the remaining antiderivatives. Moreover,

$$\frac{\tan^2 x}{2} + C = \frac{\sec^2 x - 1}{2} + C = \frac{\sec^2 x}{2} + \underbrace{\left(C - \frac{1}{2}\right)}_{\text{a constant}}$$

$$63. \text{ (a) } \left(\frac{1}{60} - 0\right) \int_0^{1/60} V_{\max} \sin 120\pi t \, dt = 60 \left[-V_{\max} \left(\frac{1}{120\pi}\right) \cos(120\pi t)\right]_0^{1/60} = -\frac{V_{\max}}{2\pi} [\cos 2\pi - \cos 0] \\ = -\frac{V_{\max}}{2\pi} [1 - 1] = 0$$

$$\text{(b) } V_{\max} = \sqrt{2} V_{\text{rms}} = \sqrt{2} (240) \approx 339 \text{ volts}$$

$$\text{(c) } \int_0^{1/60} (V_{\max})^2 \sin^2 120\pi t \, dt = (V_{\max})^2 \int_0^{1/60} \left(\frac{1 - \cos 240\pi t}{2}\right) dt = \frac{(V_{\max})^2}{2} \int_0^{1/60} (1 - \cos 240\pi t) dt \\ = \frac{(V_{\max})^2}{2} \left[t - \left(\frac{1}{240\pi}\right) \sin 240\pi t\right]_0^{1/60} = \frac{(V_{\max})^2}{2} \left[\left(\frac{1}{60} - \left(\frac{1}{240\pi}\right) \sin(4\pi)\right) - \left(0 - \left(\frac{1}{240\pi}\right) \sin(0)\right)\right] = \frac{(V_{\max})^2}{120}$$

5.6 SUBSTITUTION AND AREA BETWEEN CURVES

1. (a) Let $u = y + 1 \Rightarrow du = dy$; $y = 0 \Rightarrow u = 1$, $y = 3 \Rightarrow u = 4$

$$\int_0^3 \sqrt{y+1} \, dy = \int_1^4 u^{1/2} \, du = \left[\frac{2}{3} u^{3/2}\right]_1^4 = \left(\frac{2}{3}\right) (4)^{3/2} - \left(\frac{2}{3}\right) (1)^{3/2} = \left(\frac{2}{3}\right) (8) - \left(\frac{2}{3}\right) (1) = \frac{14}{3}$$

(b) Use the same substitution for u as in part (a); $y = -1 \Rightarrow u = 0$, $y = 0 \Rightarrow u = 1$

$$\int_{-1}^0 \sqrt{y+1} \, dy = \int_0^1 u^{1/2} \, du = \left[\frac{2}{3} u^{3/2}\right]_0^1 = \left(\frac{2}{3}\right) (1)^{3/2} - 0 = \frac{2}{3}$$

2. (a) Let $u = 1 - r^2 \Rightarrow du = -2r \, dr \Rightarrow -\frac{1}{2} du = r \, dr$; $r = 0 \Rightarrow u = 1$, $r = 1 \Rightarrow u = 0$

$$\int_0^1 r \sqrt{1-r^2} \, dr = \int_1^0 -\frac{1}{2} \sqrt{u} \, du = \left[-\frac{1}{3} u^{3/2}\right]_1^0 = 0 - \left(-\frac{1}{3}\right) (1)^{3/2} = \frac{1}{3}$$

(b) Use the same substitution for u as in part (a); $r = -1 \Rightarrow u = 0$, $r = 1 \Rightarrow u = 0$

$$\int_{-1}^1 r \sqrt{1-r^2} \, dr = \int_0^0 -\frac{1}{2} \sqrt{u} \, du = 0$$

3. (a) Let $u = \tan x \Rightarrow du = \sec^2 x \, dx$; $x = 0 \Rightarrow u = 0$, $x = \frac{\pi}{4} \Rightarrow u = 1$

$$\int_0^{\pi/4} \tan x \sec^2 x \, dx = \int_0^1 u \, du = \left[\frac{u^2}{2}\right]_0^1 = \frac{1^2}{2} - 0 = \frac{1}{2}$$

(b) Use the same substitution as in part (a); $x = -\frac{\pi}{4} \Rightarrow u = -1$, $x = 0 \Rightarrow u = 0$

$$\int_{-\pi/4}^0 \tan x \sec^2 x \, dx = \int_{-1}^0 u \, du = \left[\frac{u^2}{2}\right]_{-1}^0 = 0 - \frac{1}{2} = -\frac{1}{2}$$

4. (a) Let $u = \cos x \Rightarrow du = -\sin x \, dx \Rightarrow -du = \sin x \, dx$; $x = 0 \Rightarrow u = 1$, $x = \pi \Rightarrow u = -1$

$$\int_0^{\pi} 3 \cos^2 x \sin x \, dx = \int_1^{-1} -3u^2 \, du = \left[-u^3\right]_1^{-1} = -(-1)^3 - (-1)^3 = 2$$

(b) Use the same substitution as in part (a); $x = 2\pi \Rightarrow u = 1$, $x = 3\pi \Rightarrow u = -1$

$$\int_{2\pi}^{3\pi} 3 \cos^2 x \sin x \, dx = \int_1^{-1} -3u^2 \, du = 2$$

5. (a) $u = 1 + t^4 \Rightarrow du = 4t^3 dt \Rightarrow \frac{1}{4} du = t^3 dt$; $t = 0 \Rightarrow u = 1$, $t = 1 \Rightarrow u = 2$

$$\int_0^1 t^3 (1 + t^4)^3 dt = \int_1^2 \frac{1}{4} u^3 du = \left[\frac{u^4}{16} \right]_1^2 = \frac{2^4}{16} - \frac{1^4}{16} = \frac{15}{16}$$

- (b) Use the same substitution as in part (a); $t = -1 \Rightarrow u = 2$, $t = 1 \Rightarrow u = 2$

$$\int_{-1}^1 t^3 (1 + t^4)^3 dt = \int_2^2 \frac{1}{4} u^3 du = 0$$

6. (a) Let $u = t^2 + 1 \Rightarrow du = 2t dt \Rightarrow \frac{1}{2} du = t dt$; $t = 0 \Rightarrow u = 1$, $t = \sqrt{7} \Rightarrow u = 8$

$$\int_0^{\sqrt{7}} t (t^2 + 1)^{1/3} dt = \int_1^8 \frac{1}{2} u^{1/3} du = \left[\left(\frac{1}{2} \right) \left(\frac{3}{4} \right) u^{4/3} \right]_1^8 = \left(\frac{3}{8} \right) (8)^{4/3} - \left(\frac{3}{8} \right) (1)^{4/3} = \frac{45}{8}$$

- (b) Use the same substitution as in part (a); $t = -\sqrt{7} \Rightarrow u = 8$, $t = 0 \Rightarrow u = 1$

$$\int_{-\sqrt{7}}^0 t (t^2 + 1)^{1/3} dt = \int_8^1 \frac{1}{2} u^{1/3} du = - \int_1^8 \frac{1}{2} u^{1/3} du = - \frac{45}{8}$$

7. (a) Let $u = 4 + r^2 \Rightarrow du = 2r dr \Rightarrow \frac{1}{2} du = r dr$; $r = -1 \Rightarrow u = 5$, $r = 1 \Rightarrow u = 5$

$$\int_{-1}^1 \frac{5r}{(4+r^2)^2} dr = 5 \int_5^5 \frac{1}{2} u^{-2} du = 0$$

- (b) Use the same substitution as in part (a); $r = 0 \Rightarrow u = 4$, $r = 1 \Rightarrow u = 5$

$$\int_0^1 \frac{5r}{(4+r^2)^2} dr = 5 \int_4^5 \frac{1}{2} u^{-2} du = 5 \left[-\frac{1}{2} u^{-1} \right]_4^5 = 5 \left(-\frac{1}{2} (5)^{-1} \right) - 5 \left(-\frac{1}{2} (4)^{-1} \right) = \frac{1}{8}$$

8. (a) Let $u = 1 + v^{3/2} \Rightarrow du = \frac{3}{2} v^{1/2} dv \Rightarrow \frac{20}{3} du = 10\sqrt{v} dv$; $v = 0 \Rightarrow u = 1$, $v = 1 \Rightarrow u = 2$

$$\int_0^1 \frac{10\sqrt{v}}{(1+v^{3/2})^2} dv = \int_1^2 \frac{1}{u^2} \left(\frac{20}{3} du \right) = \frac{20}{3} \int_1^2 u^{-2} du = -\frac{20}{3} \left[\frac{1}{u} \right]_1^2 = -\frac{20}{3} \left[\frac{1}{2} - 1 \right] = \frac{10}{3}$$

- (b) Use the same substitution as in part (a); $v = 1 \Rightarrow u = 2$, $v = 4 \Rightarrow u = 1 + 4^{3/2} = 9$

$$\int_1^4 \frac{10\sqrt{v}}{(1+v^{3/2})^2} dv = \int_2^9 \frac{1}{u^2} \left(\frac{20}{3} du \right) = -\frac{20}{3} \left[\frac{1}{u} \right]_2^9 = -\frac{20}{3} \left(\frac{1}{9} - \frac{1}{2} \right) = -\frac{20}{3} \left(-\frac{7}{18} \right) = \frac{70}{27}$$

9. (a) Let $u = x^2 + 1 \Rightarrow du = 2x dx \Rightarrow 2 du = 4x dx$; $x = 0 \Rightarrow u = 1$, $x = \sqrt{3} \Rightarrow u = 4$

$$\int_0^{\sqrt{3}} \frac{4x}{\sqrt{x^2+1}} dx = \int_1^4 \frac{2}{\sqrt{u}} du = \int_1^4 2u^{-1/2} du = \left[4u^{1/2} \right]_1^4 = 4(4)^{1/2} - 4(1)^{1/2} = 4$$

- (b) Use the same substitution as in part (a); $x = -\sqrt{3} \Rightarrow u = 4$, $x = \sqrt{3} \Rightarrow u = 4$

$$\int_{-\sqrt{3}}^{\sqrt{3}} \frac{4x}{\sqrt{x^2+1}} dx = \int_4^4 \frac{2}{\sqrt{u}} du = 0$$

10. (a) Let $u = x^4 + 9 \Rightarrow du = 4x^3 dx \Rightarrow \frac{1}{4} du = x^3 dx$; $x = 0 \Rightarrow u = 9$, $x = 1 \Rightarrow u = 10$

$$\int_0^1 \frac{x^3}{\sqrt{x^4+9}} dx = \int_9^{10} \frac{1}{4} u^{-1/2} du = \left[\frac{1}{4} (2) u^{1/2} \right]_9^{10} = \frac{1}{2} (10)^{1/2} - \frac{1}{2} (9)^{1/2} = \frac{\sqrt{10}-3}{2}$$

- (b) Use the same substitution as in part (a); $x = -1 \Rightarrow u = 10$, $x = 0 \Rightarrow u = 9$

$$\int_{-1}^0 \frac{x^3}{\sqrt{x^4+9}} dx = \int_{10}^9 \frac{1}{4} u^{-1/2} du = - \int_9^{10} \frac{1}{4} u^{-1/2} du = \frac{3-\sqrt{10}}{2}$$

11. (a) Let $u = 1 - \cos 3t \Rightarrow du = 3 \sin 3t dt \Rightarrow \frac{1}{3} du = \sin 3t dt$; $t = 0 \Rightarrow u = 0$, $t = \frac{\pi}{6} \Rightarrow u = 1 - \cos \frac{\pi}{2} = 1$

$$\int_0^{\pi/6} (1 - \cos 3t) \sin 3t dt = \int_0^1 \frac{1}{3} u du = \left[\frac{1}{3} \left(\frac{u^2}{2} \right) \right]_0^1 = \frac{1}{6} (1)^2 - \frac{1}{6} (0)^2 = \frac{1}{6}$$

- (b) Use the same substitution as in part (a); $t = \frac{\pi}{6} \Rightarrow u = 1$, $t = \frac{\pi}{3} \Rightarrow u = 1 - \cos \pi = 2$

$$\int_{\pi/6}^{\pi/3} (1 - \cos 3t) \sin 3t dt = \int_1^2 \frac{1}{3} u du = \left[\frac{1}{3} \left(\frac{u^2}{2} \right) \right]_1^2 = \frac{1}{6} (2)^2 - \frac{1}{6} (1)^2 = \frac{1}{2}$$

12. (a) Let $u = 2 + \tan \frac{t}{2} \Rightarrow du = \frac{1}{2} \sec^2 \frac{t}{2} dt \Rightarrow 2 du = \sec^2 \frac{t}{2} dt$; $t = \frac{-\pi}{2} \Rightarrow u = 2 + \tan \left(\frac{-\pi}{4}\right) = 1$, $t = 0 \Rightarrow u = 2$

$$\int_{-\pi/2}^0 (2 + \tan \frac{t}{2}) \sec^2 \frac{t}{2} dt = \int_1^2 u (2 du) = [u^2]_1^2 = 2^2 - 1^2 = 3$$
- (b) Use the same substitution as in part (a); $t = \frac{-\pi}{2} \Rightarrow u = 1$, $t = \frac{\pi}{2} \Rightarrow u = 3$

$$\int_{-\pi/2}^{\pi/2} (2 + \tan \frac{t}{2}) \sec^2 \frac{t}{2} dt = 2 \int_1^3 u du = [u^2]_1^3 = 3^2 - 1^2 = 8$$
13. (a) Let $u = 4 + 3 \sin z \Rightarrow du = 3 \cos z dz \Rightarrow \frac{1}{3} du = \cos z dz$; $z = 0 \Rightarrow u = 4$, $z = 2\pi \Rightarrow u = 4$

$$\int_0^{2\pi} \frac{\cos z}{\sqrt{4+3 \sin z}} dz = \int_4^4 \frac{1}{\sqrt{u}} \left(\frac{1}{3} du\right) = 0$$
- (b) Use the same substitution as in part (a); $z = -\pi \Rightarrow u = 4 + 3 \sin(-\pi) = 4$, $z = \pi \Rightarrow u = 4$

$$\int_{-\pi}^{\pi} \frac{\cos z}{\sqrt{4+3 \sin z}} dz = \int_4^4 \frac{1}{\sqrt{u}} \left(\frac{1}{3} du\right) = 0$$
14. (a) Let $u = 3 + 2 \cos w \Rightarrow du = -2 \sin w dw \Rightarrow -\frac{1}{2} du = \sin w dw$; $w = -\frac{\pi}{2} \Rightarrow u = 3$, $w = 0 \Rightarrow u = 5$

$$\int_{-\pi/2}^0 \frac{\sin w}{(3+2 \cos w)^2} dw = \int_3^5 u^{-2} \left(-\frac{1}{2} du\right) = \frac{1}{2} [u^{-1}]_3^5 = \frac{1}{2} \left(\frac{1}{5} - \frac{1}{3}\right) = -\frac{1}{15}$$
- (b) Use the same substitution as in part (a); $w = 0 \Rightarrow u = 5$, $w = \frac{\pi}{2} \Rightarrow u = 3$

$$\int_0^{\pi/2} \frac{\sin w}{(3+2 \cos w)^2} dw = \int_5^3 u^{-2} \left(-\frac{1}{2} du\right) = \frac{1}{2} \int_3^5 u^{-2} du = \frac{1}{15}$$
15. Let $u = t^5 + 2t \Rightarrow du = (5t^4 + 2) dt$; $t = 0 \Rightarrow u = 0$, $t = 1 \Rightarrow u = 3$

$$\int_0^1 \sqrt{t^5 + 2t} (5t^4 + 2) dt = \int_0^3 u^{1/2} du = \left[\frac{2}{3} u^{3/2}\right]_0^3 = \frac{2}{3} (3)^{3/2} - \frac{2}{3} (0)^{3/2} = 2\sqrt{3}$$
16. Let $u = 1 + \sqrt{y} \Rightarrow du = \frac{dy}{2\sqrt{y}}$; $y = 1 \Rightarrow u = 2$, $y = 4 \Rightarrow u = 3$

$$\int_1^4 \frac{dy}{2\sqrt{y}(1+\sqrt{y})^2} = \int_2^3 \frac{1}{u^2} du = \int_2^3 u^{-2} du = [-u^{-1}]_2^3 = \left(-\frac{1}{3}\right) - \left(-\frac{1}{2}\right) = \frac{1}{6}$$
17. Let $u = \cos 2\theta \Rightarrow du = -2 \sin 2\theta d\theta \Rightarrow -\frac{1}{2} du = \sin 2\theta d\theta$; $\theta = 0 \Rightarrow u = 1$, $\theta = \frac{\pi}{6} \Rightarrow u = \cos 2\left(\frac{\pi}{6}\right) = \frac{1}{2}$

$$\int_0^{\pi/6} \cos^{-3} 2\theta \sin 2\theta d\theta = \int_1^{1/2} u^{-3} \left(-\frac{1}{2} du\right) = -\frac{1}{2} \int_1^{1/2} u^{-3} du = \left[-\frac{1}{2} \left(\frac{u^{-2}}{-2}\right)\right]_1^{1/2} = \frac{1}{4} \left(\frac{1}{(1/2)^2} - \frac{1}{(1)^2}\right) = \frac{3}{4}$$
18. Let $u = \tan \left(\frac{\theta}{6}\right) \Rightarrow du = \frac{1}{6} \sec^2 \left(\frac{\theta}{6}\right) d\theta \Rightarrow 6 du = \sec^2 \left(\frac{\theta}{6}\right) d\theta$; $\theta = \pi \Rightarrow u = \tan \left(\frac{\pi}{6}\right) = \frac{1}{\sqrt{3}}$, $\theta = \frac{3\pi}{2} \Rightarrow u = \tan \frac{\pi}{4} = 1$

$$\int_{\pi}^{3\pi/2} \cot^5 \left(\frac{\theta}{6}\right) \sec^2 \left(\frac{\theta}{6}\right) d\theta = \int_{1/\sqrt{3}}^1 u^{-5} (6 du) = \left[6 \left(\frac{u^{-4}}{-4}\right)\right]_{1/\sqrt{3}}^1 = \left[-\frac{3}{2u^4}\right]_{1/\sqrt{3}}^1 = -\frac{3}{2(1)^4} - \left(-\frac{3}{2\left(\frac{1}{\sqrt{3}}\right)^4}\right) = 12$$
19. Let $u = 5 - 4 \cos t \Rightarrow du = 4 \sin t dt \Rightarrow \frac{1}{4} du = \sin t dt$; $t = 0 \Rightarrow u = 5 - 4 \cos 0 = 1$, $t = \pi \Rightarrow u = 5 - 4 \cos \pi = 9$

$$\int_0^{\pi} 5(5 - 4 \cos t)^{1/4} \sin t dt = \int_1^9 5u^{1/4} \left(\frac{1}{4} du\right) = \frac{5}{4} \int_1^9 u^{1/4} du = \left[\frac{5}{4} \left(\frac{4}{5} u^{5/4}\right)\right]_1^9 = 9^{5/4} - 1 = 3^{5/2} - 1$$
20. Let $u = 1 - \sin 2t \Rightarrow du = -2 \cos 2t dt \Rightarrow -\frac{1}{2} du = \cos 2t dt$; $t = 0 \Rightarrow u = 1$, $t = \frac{\pi}{4} \Rightarrow u = 0$

$$\int_0^{\pi/4} (1 - \sin 2t)^{3/2} \cos 2t dt = \int_1^0 \left(-\frac{1}{2} u^{3/2}\right) du = \left[-\frac{1}{2} \left(\frac{2}{5} u^{5/2}\right)\right]_1^0 = \left(-\frac{1}{5} (0)^{5/2}\right) - \left(-\frac{1}{5} (1)^{5/2}\right) = \frac{1}{5}$$
21. Let $u = 4y - y^2 + 4y^3 + 1 \Rightarrow du = (4 - 2y + 12y^2) dy$; $y = 0 \Rightarrow u = 1$, $y = 1 \Rightarrow u = 4(1) - (1)^2 + 4(1)^3 + 1 = 8$

$$\int_0^1 (4y - y^2 + 4y^3 + 1)^{-2/3} (12y^2 - 2y + 4) dy = \int_1^8 u^{-2/3} du = \left[3u^{1/3}\right]_1^8 = 3(8)^{1/3} - 3(1)^{1/3} = 3$$

22. Let $u = y^3 + 6y^2 - 12y + 9 \Rightarrow du = (3y^2 + 12y - 12) dy \Rightarrow \frac{1}{3} du = (y^2 + 4y - 4) dy$; $y = 0 \Rightarrow u = 9$, $y = 1 \Rightarrow u = 4$

$$\int_0^1 (y^3 + 6y^2 - 12y + 9)^{-1/2} (y^2 + 4y - 4) dy = \int_9^4 \frac{1}{3} u^{-1/2} du = \left[\frac{1}{3} (2u^{1/2}) \right]_9^4 = \frac{2}{3} (4)^{1/2} - \frac{2}{3} (9)^{1/2} = \frac{2}{3} (2 - 3) = -\frac{2}{3}$$

23. Let $u = \theta^{3/2} \Rightarrow du = \frac{3}{2} \theta^{1/2} d\theta \Rightarrow \frac{2}{3} du = \sqrt{\theta} d\theta$; $\theta = 0 \Rightarrow u = 0$, $\theta = \sqrt[3]{\pi^2} \Rightarrow u = \pi$

$$\int_0^{\sqrt[3]{\pi^2}} \sqrt{\theta} \cos^2(\theta^{3/2}) d\theta = \int_0^\pi \cos^2 u \left(\frac{2}{3} du \right) = \left[\frac{2}{3} \left(\frac{u}{2} + \frac{1}{4} \sin 2u \right) \right]_0^\pi = \frac{2}{3} \left(\frac{\pi}{2} + \frac{1}{4} \sin 2\pi \right) - \frac{2}{3} (0) = \frac{\pi}{3}$$

24. Let $u = 1 + \frac{1}{t} \Rightarrow du = -t^{-2} dt$; $t = -1 \Rightarrow u = 0$, $t = -\frac{1}{2} \Rightarrow u = -1$

$$\int_{-1}^{-1/2} t^{-2} \sin^2 \left(1 + \frac{1}{t} \right) dt = \int_0^{-1} -\sin^2 u du = \left[-\left(\frac{u}{2} - \frac{1}{4} \sin 2u \right) \right]_0^{-1} = -\left[\left(-\frac{1}{2} - \frac{1}{4} \sin(-2) \right) - \left(\frac{0}{2} - \frac{1}{4} \sin 0 \right) \right] = \frac{1}{2} - \frac{1}{4} \sin 2$$

25. Let $u = 4 - x^2 \Rightarrow du = -2x dx \Rightarrow -\frac{1}{2} du = x dx$; $x = -2 \Rightarrow u = 0$, $x = 0 \Rightarrow u = 4$, $x = 2 \Rightarrow u = 0$

$$A = -\int_{-2}^0 x \sqrt{4 - x^2} dx + \int_0^2 x \sqrt{4 - x^2} dx = -\int_0^4 -\frac{1}{2} u^{1/2} du + \int_4^0 -\frac{1}{2} u^{1/2} du = 2 \int_0^4 \frac{1}{2} u^{1/2} du = \int_0^4 u^{1/2} du = \left[\frac{2}{3} u^{3/2} \right]_0^4 = \frac{2}{3} (4)^{3/2} - \frac{2}{3} (0)^{3/2} = \frac{16}{3}$$

26. Let $u = 1 - \cos x \Rightarrow du = \sin x dx$; $x = 0 \Rightarrow u = 0$, $x = \pi \Rightarrow u = 2$

$$\int_0^\pi (1 - \cos x) \sin x dx = \int_0^2 u du = \left[\frac{u^2}{2} \right]_0^2 = \frac{2^2}{2} - \frac{0^2}{2} = 2$$

27. Let $u = 1 + \cos x \Rightarrow du = -\sin x dx \Rightarrow -du = \sin x dx$; $x = -\pi \Rightarrow u = 1 + \cos(-\pi) = 0$, $x = 0 \Rightarrow u = 1 + \cos 0 = 2$

$$A = -\int_{-\pi}^0 3(\sin x) \sqrt{1 + \cos x} dx = -\int_0^2 3u^{1/2} (-du) = 3 \int_0^2 u^{1/2} du = \left[2u^{3/2} \right]_0^2 = 2(2)^{3/2} - 2(0)^{3/2} = 2^{5/2}$$

28. Let $u = \pi + \pi \sin x \Rightarrow du = \pi \cos x dx \Rightarrow \frac{1}{\pi} du = \cos x dx$; $x = -\frac{\pi}{2} \Rightarrow u = \pi + \pi \sin\left(-\frac{\pi}{2}\right) = 0$, $x = 0 \Rightarrow u = \pi$

Because of symmetry about $x = -\frac{\pi}{2}$, $A = 2 \int_{-\pi/2}^0 \frac{\pi}{2} (\cos x) (\sin(\pi + \pi \sin x)) dx = 2 \int_0^\pi \frac{\pi}{2} (\sin u) \left(\frac{1}{\pi} du \right) = \int_0^\pi \sin u du = [-\cos u]_0^\pi = (-\cos \pi) - (-\cos 0) = 2$

29. For the sketch given, $a = 0$, $b = \pi$; $f(x) - g(x) = 1 - \cos^2 x = \sin^2 x = \frac{1 - \cos 2x}{2}$;

$$A = \int_0^\pi \frac{(1 - \cos 2x)}{2} dx = \frac{1}{2} \int_0^\pi (1 - \cos 2x) dx = \frac{1}{2} \left[x - \frac{\sin 2x}{2} \right]_0^\pi = \frac{1}{2} [(\pi - 0) - (0 - 0)] = \frac{\pi}{2}$$

30. For the sketch given, $a = -\frac{\pi}{3}$, $b = \frac{\pi}{3}$; $f(t) - g(t) = \frac{1}{2} \sec^2 t - (-4 \sin^2 t) = \frac{1}{2} \sec^2 t + 4 \sin^2 t$;

$$A = \int_{-\pi/3}^{\pi/3} \left(\frac{1}{2} \sec^2 t + 4 \sin^2 t \right) dt = \frac{1}{2} \int_{-\pi/3}^{\pi/3} \sec^2 t dt + 4 \int_{-\pi/3}^{\pi/3} \sin^2 t dt = \frac{1}{2} \int_{-\pi/3}^{\pi/3} \sec^2 t dt + 4 \int_{-\pi/3}^{\pi/3} \frac{(1 - \cos 2t)}{2} dt = \frac{1}{2} \int_{-\pi/3}^{\pi/3} \sec^2 t dt + 2 \int_{-\pi/3}^{\pi/3} (1 - \cos 2t) dt = \frac{1}{2} [\tan t]_{-\pi/3}^{\pi/3} + 2 \left[t - \frac{\sin 2t}{2} \right]_{-\pi/3}^{\pi/3} = \sqrt{3} + 4 \cdot \frac{\pi}{3} - \sqrt{3} = \frac{4\pi}{3}$$

31. For the sketch given, $a = -2$, $b = 2$; $f(x) - g(x) = 2x^2 - (x^4 - 2x^2) = 4x^2 - x^4$;

$$A = \int_{-2}^2 (4x^2 - x^4) dx = \left[\frac{4x^3}{3} - \frac{x^5}{5} \right]_{-2}^2 = \left(\frac{32}{3} - \frac{32}{5} \right) - \left[-\frac{32}{3} - \left(-\frac{32}{5} \right) \right] = \frac{64}{3} - \frac{64}{5} = \frac{320 - 192}{15} = \frac{128}{15}$$

32. For the sketch given, $c = 0$, $d = 1$; $f(y) - g(y) = y^2 - y^3$;

$$A = \int_0^1 (y^2 - y^3) dy = \int_0^1 y^2 dy - \int_0^1 y^3 dy = \left[\frac{y^3}{3} \right]_0^1 - \left[\frac{y^4}{4} \right]_0^1 = \frac{(1-0)}{3} - \frac{(1-0)}{4} = \frac{1}{3} - \frac{1}{4} = \frac{1}{12}$$

33. For the sketch given, $c = 0$, $d = 1$; $f(y) - g(y) = (12y^2 - 12y^3) - (2y^2 - 2y) = 10y^2 - 12y^3 + 2y$;

$$A = \int_0^1 (10y^2 - 12y^3 + 2y) dy = \int_0^1 10y^2 dy - \int_0^1 12y^3 dy + \int_0^1 2y dy = \left[\frac{10}{3} y^3 \right]_0^1 - \left[\frac{12}{4} y^4 \right]_0^1 + \left[\frac{2}{2} y^2 \right]_0^1 \\ = \left(\frac{10}{3} - 0 \right) - (3 - 0) + (1 - 0) = \frac{4}{3}$$

34. For the sketch given, $a = -1$, $b = 1$; $f(x) - g(x) = x^2 - (-2x^4) = x^2 + 2x^4$;

$$A = \int_{-1}^1 (x^2 + 2x^4) dx = \left[\frac{x^3}{3} + \frac{2x^5}{5} \right]_{-1}^1 = \left(\frac{1}{3} + \frac{2}{5} \right) - \left[-\frac{1}{3} + \left(-\frac{2}{5} \right) \right] = \frac{2}{3} + \frac{4}{5} = \frac{10+12}{15} = \frac{22}{15}$$

35. We want the area between the line $y = 1$, $0 \leq x \leq 2$, and the curve $y = \frac{x^2}{4}$, *minus* the area of a triangle

(formed by $y = x$ and $y = 1$) with base 1 and height 1. Thus, $A = \int_0^2 \left(1 - \frac{x^2}{4} \right) dx - \frac{1}{2} (1)(1) = \left[x - \frac{x^3}{12} \right]_0^2 - \frac{1}{2}$
 $= \left(2 - \frac{8}{12} \right) - \frac{1}{2} = 2 - \frac{2}{3} - \frac{1}{2} = \frac{5}{6}$

36. We want the area between the x-axis and the curve $y = x^2$, $0 \leq x \leq 1$ *plus* the area of a triangle (formed by $x = 1$,

$x + y = 2$, and the x-axis) with base 1 and height 1. Thus, $A = \int_0^1 x^2 dx + \frac{1}{2} (1)(1) = \left[\frac{x^3}{3} \right]_0^1 + \frac{1}{2} = \frac{1}{3} + \frac{1}{2} = \frac{5}{6}$

37. AREA = A1 + A2

A1: For the sketch given, $a = -3$ and we find b by solving the equations $y = x^2 - 4$ and $y = -x^2 - 2x$ simultaneously for x : $x^2 - 4 = -x^2 - 2x \Rightarrow 2x^2 + 2x - 4 = 0 \Rightarrow 2(x+2)(x-1) \Rightarrow x = -2$ or $x = 1$ so

$$b = -2: f(x) - g(x) = (x^2 - 4) - (-x^2 - 2x) = 2x^2 + 2x - 4 \Rightarrow A1 = \int_{-3}^{-2} (2x^2 + 2x - 4) dx \\ = \left[\frac{2x^3}{3} + \frac{2x^2}{2} - 4x \right]_{-3}^{-2} = \left(-\frac{16}{3} + 4 + 8 \right) - (-18 + 9 + 12) = 9 - \frac{16}{3} = \frac{11}{3};$$

A2: For the sketch given, $a = -2$ and $b = 1$: $f(x) - g(x) = (-x^2 - 2x) - (x^2 - 4) = -2x^2 - 2x + 4$

$$\Rightarrow A2 = - \int_{-2}^1 (2x^2 + 2x - 4) dx = - \left[\frac{2x^3}{3} + x^2 - 4x \right]_{-2}^1 = - \left(\frac{2}{3} + 1 - 4 \right) + \left(-\frac{16}{3} + 4 + 8 \right) \\ = -\frac{2}{3} - 1 + 4 - \frac{16}{3} + 4 + 8 = 9;$$

$$\text{Therefore, AREA} = A1 + A2 = \frac{11}{3} + 9 = \frac{38}{3}$$

38. AREA = A1 + A2

A1: For the sketch given, $a = -2$ and $b = 0$: $f(x) - g(x) = (2x^3 - x^2 - 5x) - (-x^2 + 3x) = 2x^3 - 8x$

$$\Rightarrow A1 = \int_{-2}^0 (2x^3 - 8x) dx = \left[\frac{2x^4}{4} - \frac{8x^2}{2} \right]_{-2}^0 = 0 - (8 - 16) = 8;$$

A2: For the sketch given, $a = 0$ and $b = 2$: $f(x) - g(x) = (-x^2 + 3x) - (2x^3 - x^2 - 5x) = 8x - 2x^3$

$$\Rightarrow A2 = \int_0^2 (8x - 2x^3) dx = \left[\frac{8x^2}{2} - \frac{2x^4}{4} \right]_0^2 = (16 - 8) = 8;$$

$$\text{Therefore, AREA} = A1 + A2 = 16$$

39. AREA = A1 + A2 + A3

A1: For the sketch given, $a = -2$ and $b = -1$: $f(x) - g(x) = (-x + 2) - (4 - x^2) = x^2 - x - 2$

$$\Rightarrow A1 = \int_{-2}^{-1} (x^2 - x - 2) dx = \left[\frac{x^3}{3} - \frac{x^2}{2} - 2x \right]_{-2}^{-1} = \left(-\frac{1}{3} - \frac{1}{2} + 2 \right) - \left(-\frac{8}{3} - \frac{4}{2} + 4 \right) = \frac{7}{3} - \frac{1}{2} = \frac{14-3}{6} = \frac{11}{6};$$

A2: For the sketch given, $a = -1$ and $b = 2$: $f(x) - g(x) = (4 - x^2) - (-x + 2) = -x^2 - x - 2$

$$\Rightarrow A2 = - \int_{-1}^2 (x^2 - x - 2) dx = - \left[\frac{x^3}{3} - \frac{x^2}{2} - 2x \right]_{-1}^2 = - \left(\frac{8}{3} - \frac{4}{2} - 4 \right) + \left(-\frac{1}{3} - \frac{1}{2} + 2 \right) = -3 + 8 - \frac{1}{2} = \frac{9}{2};$$

A3: For the sketch given, $a = 2$ and $b = 3$: $f(x) - g(x) = (-x + 2) - (4 - x^2) = x^2 - x - 2$

$$\Rightarrow A_3 = \int_2^3 (x^2 - x - 2) dx = \left[\frac{x^3}{3} - \frac{x^2}{2} - 2x \right]_2^3 = \left(\frac{27}{3} - \frac{9}{2} - 6 \right) - \left(\frac{8}{3} - \frac{4}{2} - 4 \right) = 9 - \frac{9}{2} - \frac{8}{3};$$

Therefore, $\text{AREA} = A_1 + A_2 + A_3 = \frac{11}{6} + \frac{9}{2} + \left(9 - \frac{9}{2} - \frac{8}{3} \right) = 9 - \frac{5}{6} = \frac{49}{6}$

40. $\text{AREA} = A_1 + A_2 + A_3$

A1: For the sketch given, $a = -2$ and $b = 0$: $f(x) - g(x) = \left(\frac{x^3}{3} - x \right) - \frac{x}{3} = \frac{x^3}{3} - \frac{4}{3}x = \frac{1}{3}(x^3 - 4x)$

$$\Rightarrow A_1 = \frac{1}{3} \int_{-2}^0 (x^3 - 4x) dx = \frac{1}{3} \left[\frac{x^4}{4} - 2x^2 \right]_{-2}^0 = 0 - \frac{1}{3}(4 - 8) = \frac{4}{3};$$

A2: For the sketch given, $a = 0$ and we find b by solving the equations $y = \frac{x^3}{3} - x$ and $y = \frac{x}{3}$ simultaneously

for x : $\frac{x^3}{3} - x = \frac{x}{3} \Rightarrow \frac{x^3}{3} - \frac{4}{3}x = 0 \Rightarrow \frac{x}{3}(x - 2)(x + 2) = 0 \Rightarrow x = -2, x = 0, \text{ or } x = 2$ so $b = 2$:

$$f(x) - g(x) = \frac{x}{3} - \left(\frac{x^3}{3} - x \right) = -\frac{1}{3}(x^3 - 4x) \Rightarrow A_2 = -\frac{1}{3} \int_0^2 (x^3 - 4x) dx = \frac{1}{3} \int_0^2 (4x - x^3) dx = \frac{1}{3} \left[2x^2 - \frac{x^4}{4} \right]_0^2 = \frac{1}{3}(8 - 4) = \frac{4}{3};$$

A3: For the sketch given, $a = 2$ and $b = 3$: $f(x) - g(x) = \left(\frac{x^3}{3} - x \right) - \frac{x}{3} = \frac{1}{3}(x^3 - 4x)$

$$\Rightarrow A_3 = \frac{1}{3} \int_2^3 (x^3 - 4x) dx = \frac{1}{3} \left[\frac{x^4}{4} - 2x^2 \right]_2^3 = \frac{1}{3} \left[\left(\frac{81}{4} - 2 \cdot 9 \right) - \left(\frac{16}{4} - 8 \right) \right] = \frac{1}{3} \left(\frac{81}{4} - 14 \right) = \frac{25}{12};$$

Therefore, $\text{AREA} = A_1 + A_2 + A_3 = \frac{4}{3} + \frac{4}{3} + \frac{25}{12} = \frac{32+25}{12} = \frac{19}{4}$

41. $a = -2, b = 2$;

$f(x) - g(x) = 2 - (x^2 - 2) = 4 - x^2$

$$\Rightarrow A = \int_{-2}^2 (4 - x^2) dx = \left[4x - \frac{x^3}{3} \right]_{-2}^2 = \left(8 - \frac{8}{3} \right) - \left(-8 + \frac{8}{3} \right) = 2 \cdot \left(\frac{24}{3} - \frac{8}{3} \right) = \frac{32}{3}$$

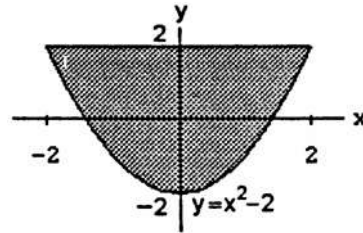

42. $a = -1, b = 3$;

$f(x) - g(x) = (2x - x^2) - (-3) = 2x - x^2 + 3$

$$\Rightarrow A = \int_{-1}^3 (2x - x^2 + 3) dx = \left[x^2 - \frac{x^3}{3} + 3x \right]_{-1}^3 = \left(9 - \frac{27}{3} + 9 \right) - \left(1 + \frac{1}{3} - 3 \right) = 11 - \frac{1}{3} = \frac{32}{3}$$

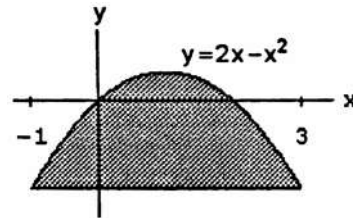

43. $a = 0, b = 2$;

$f(x) - g(x) = 8x - x^4 \Rightarrow A = \int_0^2 (8x - x^4) dx$

$$= \left[\frac{8x^2}{2} - \frac{x^5}{5} \right]_0^2 = 16 - \frac{32}{5} = \frac{80-32}{5} = \frac{48}{5}$$

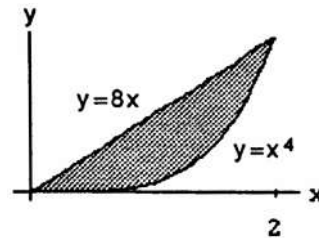

44. Limits of integration: $x^2 - 2x = x \Rightarrow x^2 = 3x$

$\Rightarrow x(x - 3) = 0 \Rightarrow a = 0$ and $b = 3$;

$f(x) - g(x) = x - (x^2 - 2x) = 3x - x^2$

$$\Rightarrow A = \int_0^3 (3x - x^2) dx = \left[\frac{3x^2}{2} - \frac{x^3}{3} \right]_0^3 = \frac{27}{2} - 9 = \frac{27-18}{2} = \frac{9}{2}$$

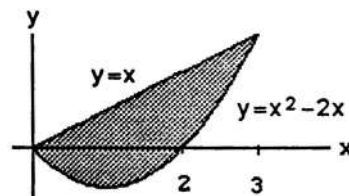

45. Limits of integration: $x^2 = -x^2 + 4x \Rightarrow 2x^2 - 4x = 0$
 $\Rightarrow 2x(x - 2) = 0 \Rightarrow a = 0$ and $b = 2$;
 $f(x) - g(x) = (-x^2 + 4x) - x^2 = -2x^2 + 4x$
 $\Rightarrow A = \int_0^2 (-2x^2 + 4x) dx = \left[\frac{-2x^3}{3} + \frac{4x^2}{2} \right]_0^2$
 $= -\frac{16}{3} + \frac{16}{2} = \frac{-32+48}{6} = \frac{8}{3}$

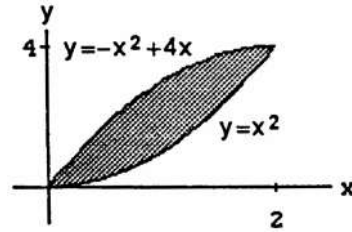

46. Limits of integration: $7 - 2x^2 = x^2 + 4 \Rightarrow 3x^2 - 3 = 0$
 $\Rightarrow 3(x - 1)(x + 1) = 0 \Rightarrow a = -1$ and $b = 1$;
 $f(x) - g(x) = (7 - 2x^2) - (x^2 + 4) = 3 - 3x^2$
 $\Rightarrow A = \int_{-1}^1 (3 - 3x^2) dx = 3 \left[x - \frac{x^3}{3} \right]_{-1}^1$
 $= 3 \left[\left(1 - \frac{1}{3}\right) - \left(-1 + \frac{1}{3}\right) \right] = 6 \left(\frac{2}{3}\right) = 4$

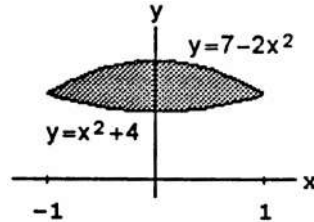

47. Limits of integration: $x^4 - 4x^2 + 4 = x^2$
 $\Rightarrow x^4 - 5x^2 + 4 = 0 \Rightarrow (x^2 - 4)(x^2 - 1) = 0$
 $\Rightarrow (x + 2)(x - 2)(x + 1)(x - 1) = 0 \Rightarrow x = -2, -1, 1, 2$;
 $f(x) - g(x) = (x^4 - 4x^2 + 4) - x^2 = x^4 - 5x^2 + 4$ and
 $g(x) - f(x) = x^2 - (x^4 - 4x^2 + 4) = -x^4 + 5x^2 - 4$
 $\Rightarrow A = \int_{-2}^{-1} (-x^4 + 5x^2 - 4) dx + \int_{-1}^1 (x^4 - 5x^2 + 4) dx$
 $+ \int_1^2 (-x^4 + 5x^2 - 4) dx$
 $= \left[-\frac{x^5}{5} + \frac{5x^3}{3} - 4x \right]_{-2}^{-1} + \left[\frac{x^5}{5} - \frac{5x^3}{3} + 4x \right]_{-1}^1 + \left[-\frac{x^5}{5} + \frac{5x^3}{3} - 4x \right]_1^2$
 $= \left(\frac{1}{5} - \frac{5}{3} + 4\right) - \left(\frac{32}{5} - \frac{40}{3} + 8\right) + \left(\frac{1}{5} - \frac{5}{3} + 4\right) - \left(-\frac{1}{5} + \frac{5}{3} - 4\right) + \left(-\frac{32}{5} + \frac{40}{3} - 8\right) - \left(-\frac{1}{5} + \frac{5}{3} - 4\right)$
 $= -\frac{60}{5} + \frac{60}{3} = \frac{300-180}{15} = 8$

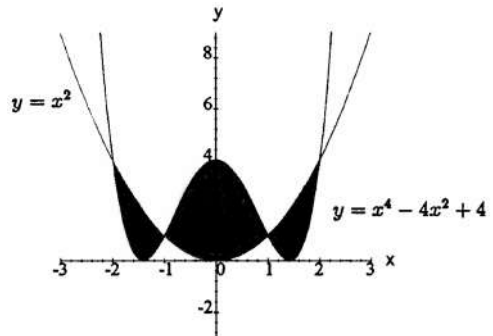

48. Limits of integration: $x\sqrt{a^2 - x^2} = 0 \Rightarrow x = 0$ or
 $\sqrt{a^2 - x^2} = 0 \Rightarrow x = 0$ or $a^2 - x^2 = 0 \Rightarrow x = -a, 0, a$;
 $A = \int_{-a}^0 -x\sqrt{a^2 - x^2} dx + \int_0^a x\sqrt{a^2 - x^2} dx$
 $= \frac{1}{2} \left[\frac{2}{3} (a^2 - x^2)^{3/2} \right]_{-a}^0 - \frac{1}{2} \left[\frac{2}{3} (a^2 - x^2)^{3/2} \right]_0^a$
 $= \frac{1}{3} (a^2)^{3/2} - \left[-\frac{1}{3} (a^2)^{3/2} \right] = \frac{2a^3}{3}$

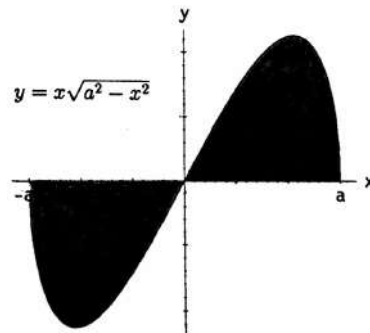

49. Limits of integration: $y = \sqrt{|x|} = \begin{cases} \sqrt{-x}, & x \leq 0 \\ \sqrt{x}, & x \geq 0 \end{cases}$ and
 $5y = x + 6$ or $y = \frac{x}{5} + \frac{6}{5}$; for $x \leq 0$: $\sqrt{-x} = \frac{x}{5} + \frac{6}{5}$
 $\Rightarrow 5\sqrt{-x} = x + 6 \Rightarrow 25(-x) = x^2 + 12x + 36$
 $\Rightarrow x^2 + 37x + 36 = 0 \Rightarrow (x + 1)(x + 36) = 0$
 $\Rightarrow x = -1, -36$ (but $x = -36$ is not a solution);
for $x \geq 0$: $5\sqrt{x} = x + 6 \Rightarrow 25x = x^2 + 12x + 36$
 $\Rightarrow x^2 - 13x + 36 = 0 \Rightarrow (x - 4)(x - 9) = 0$
 $\Rightarrow x = 4, 9$; there are three intersection points and
 $A = \int_{-1}^0 \left(\frac{x+6}{5} - \sqrt{-x}\right) dx + \int_0^4 \left(\frac{x+6}{5} - \sqrt{x}\right) dx + \int_4^9 (\sqrt{x} - \frac{x+6}{5}) dx$

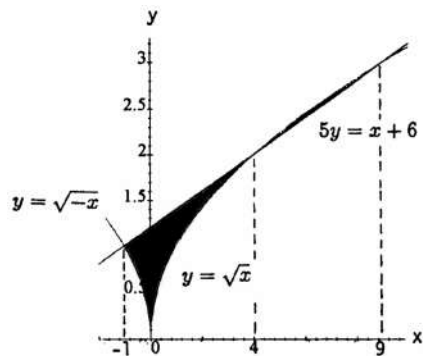

$$= \left[\frac{(x+6)^2}{10} + \frac{2}{3}(-x)^{3/2} \right]_{-1}^0 + \left[\frac{(x+6)^2}{10} - \frac{2}{3}x^{3/2} \right]_0^4 + \left[\frac{2}{3}x^{3/2} - \frac{(x+6)^2}{10} \right]_4^9$$

$$= \left(\frac{36}{10} - \frac{25}{10} - \frac{2}{3} \right) + \left(\frac{100}{10} - \frac{2}{3} \cdot 4^{3/2} - \frac{36}{10} + 0 \right) + \left(\frac{2}{3} \cdot 9^{3/2} - \frac{225}{10} - \frac{2}{3} \cdot 4^{3/2} + \frac{100}{10} \right) = -\frac{50}{10} + \frac{20}{3} = \frac{5}{3}$$

50. Limits of integration:

$$y = |x^2 - 4| = \begin{cases} x^2 - 4, & x \leq -2 \text{ or } x \geq 2 \\ 4 - x^2, & -2 \leq x \leq 2 \end{cases}$$

for $x \leq -2$ and $x \geq 2$: $x^2 - 4 = \frac{x^2}{2} + 4$
 $\Rightarrow 2x^2 - 8 = x^2 + 8 \Rightarrow x^2 = 16 \Rightarrow x = \pm 4$;
 for $-2 \leq x \leq 2$: $4 - x^2 = \frac{x^2}{2} + 4 \Rightarrow 8 - 2x^2 = x^2 + 8$
 $\Rightarrow x^2 = 0 \Rightarrow x = 0$; by symmetry of the graph,

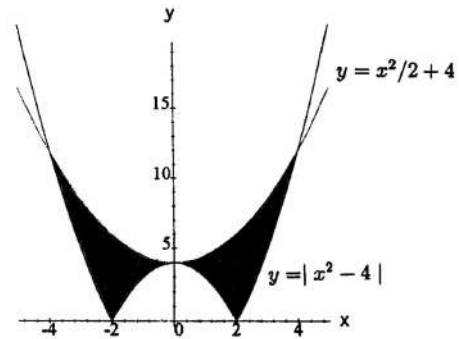

$$A = 2 \int_0^2 \left[\left(\frac{x^2}{2} + 4 \right) - (4 - x^2) \right] dx + 2 \int_2^4 \left[\left(\frac{x^2}{2} + 4 \right) - (x^2 - 4) \right] dx = 2 \left[\frac{x^3}{2} \right]_0^2 + 2 \left[8x - \frac{x^3}{6} \right]_2^4$$

$$= 2 \left(\frac{8}{2} - 0 \right) + 2 \left(32 - \frac{64}{6} - 16 + \frac{8}{6} \right) = 40 - \frac{56}{3} = \frac{64}{3}$$

51. Limits of integration: $c = 0$ and $d = 3$;

$$f(y) - g(y) = 2y^2 - 0 = 2y^2$$

$$\Rightarrow A = \int_0^3 2y^2 dy = \left[\frac{2y^3}{3} \right]_0^3 = 2 \cdot 9 = 18$$

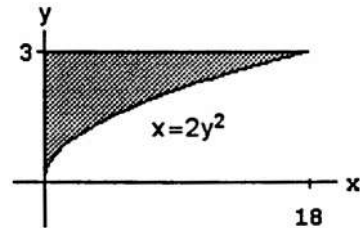

52. Limits of integration: $y^2 = y + 2 \Rightarrow (y + 1)(y - 2) = 0$

$$\Rightarrow c = -1 \text{ and } d = 2; f(y) - g(y) = (y + 2) - y^2$$

$$\Rightarrow A = \int_{-1}^2 (y + 2 - y^2) dy = \left[\frac{y^2}{2} + 2y - \frac{y^3}{3} \right]_{-1}^2$$

$$= \left(\frac{4}{2} + 4 - \frac{8}{3} \right) - \left(\frac{1}{2} - 2 + \frac{1}{3} \right) = 6 - \frac{8}{3} - \frac{1}{2} + 2 - \frac{1}{3} = \frac{9}{2}$$

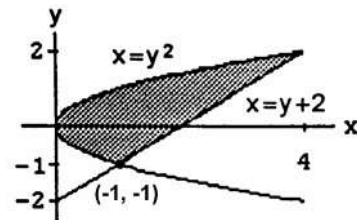

53. Limits of integration: $4x = y^2 - 4$ and $4x = 16 + y$

$$\Rightarrow y^2 - 4 = 16 + y \Rightarrow y^2 - y - 20 = 0 \Rightarrow (y - 5)(y + 4) = 0 \Rightarrow c = -4 \text{ and } d = 5;$$

$$f(y) - g(y) = \left(\frac{16+y}{4} \right) - \left(\frac{y^2-4}{4} \right) = \frac{-y^2+y+20}{4}$$

$$\Rightarrow A = \frac{1}{4} \int_{-4}^5 (-y^2 + y + 20) dy$$

$$= \frac{1}{4} \left[-\frac{y^3}{3} + \frac{y^2}{2} + 20y \right]_{-4}^5$$

$$= \frac{1}{4} \left(-\frac{125}{3} + \frac{25}{2} + 100 \right) - \frac{1}{4} \left(\frac{64}{3} + \frac{16}{2} - 80 \right)$$

$$= \frac{1}{4} \left(-\frac{189}{3} + \frac{9}{2} + 180 \right) = \frac{243}{8}$$

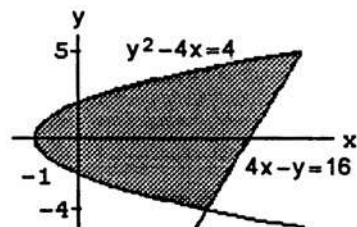

54. Limits of integration: $x = y^2$ and $x = 3 - 2y^2$
 $\Rightarrow y^2 = 3 - 2y^2 \Rightarrow 3y^2 = 3 \Rightarrow 3(y - 1)(y + 1) = 0$
 $\Rightarrow c = -1$ and $d = 1$; $f(y) - g(y) = (3 - 2y^2) - y^2$
 $= 3 - 3y^2 = 3(1 - y^2) \Rightarrow A = 3 \int_{-1}^1 (1 - y^2) dy$
 $= 3 \left[y - \frac{y^3}{3} \right]_{-1}^1 = 3 \left(1 - \frac{1}{3} \right) - 3 \left(-1 + \frac{1}{3} \right)$
 $= 3 \cdot 2 \left(1 - \frac{1}{3} \right) = 4$

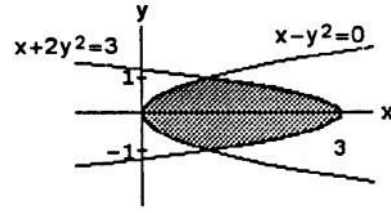

55. Limits of integration: $x = -y^2$ and $x = 2 - 3y^2$
 $\Rightarrow -y^2 = 2 - 3y^2 \Rightarrow 2y^2 - 2 = 0$
 $\Rightarrow 2(y - 1)(y + 1) = 0 \Rightarrow c = -1$ and $d = 1$;
 $f(y) - g(y) = (2 - 3y^2) - (-y^2) = 2 - 2y^2 = 2(1 - y^2)$
 $\Rightarrow A = 2 \int_{-1}^1 (1 - y^2) dy = 2 \left[y - \frac{y^3}{3} \right]_{-1}^1$
 $= 2 \left(1 - \frac{1}{3} \right) - 2 \left(-1 + \frac{1}{3} \right) = 4 \left(\frac{2}{3} \right) = \frac{8}{3}$

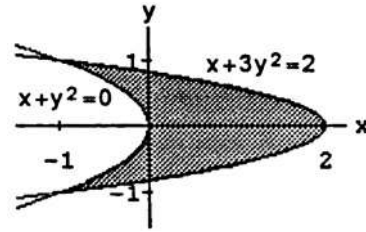

56. Limits of integration: $x = y^{2/3}$ and $x = 2 - y^4$
 $\Rightarrow y^{2/3} = 2 - y^4 \Rightarrow c = -1$ and $d = 1$;
 $f(y) - g(y) = (2 - y^4) - y^{2/3}$
 $\Rightarrow A = \int_{-1}^1 (2 - y^4 - y^{2/3}) dy$
 $= \left[2y - \frac{y^5}{5} - \frac{3}{5} y^{5/3} \right]_{-1}^1$
 $= \left(2 - \frac{1}{5} - \frac{3}{5} \right) - \left(-2 + \frac{1}{5} + \frac{3}{5} \right)$
 $= 2 \left(2 - \frac{1}{5} - \frac{3}{5} \right) = \frac{12}{5}$

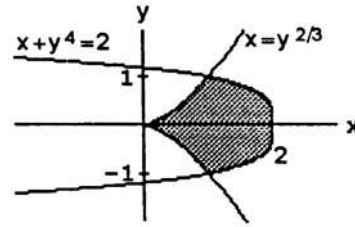

57. Limits of integration: $x = y^2 - 1$ and $x = |y| \sqrt{1 - y^2}$
 $\Rightarrow y^2 - 1 = |y| \sqrt{1 - y^2} \Rightarrow y^4 - 2y^2 + 1 = y^2(1 - y^2)$
 $\Rightarrow y^4 - 2y^2 + 1 = y^2 - y^4 \Rightarrow 2y^4 - 3y^2 + 1 = 0$
 $\Rightarrow (2y^2 - 1)(y^2 - 1) = 0 \Rightarrow 2y^2 - 1 = 0$ or $y^2 - 1 = 0$
 $\Rightarrow y^2 = \frac{1}{2}$ or $y^2 = 1 \Rightarrow y = \pm \frac{\sqrt{2}}{2}$ or $y = \pm 1$.

Substitution shows that $\frac{\pm\sqrt{2}}{2}$ are not solutions $\Rightarrow y = \pm 1$;

for $-1 \leq y \leq 0$, $f(x) - g(x) = -y\sqrt{1 - y^2} - (y^2 - 1)$

$= 1 - y^2 - y(1 - y^2)^{1/2}$, and by symmetry of the graph,

$$A = 2 \int_{-1}^0 [1 - y^2 - y(1 - y^2)^{1/2}] dy$$

$$= 2 \int_{-1}^0 (1 - y^2) dy - 2 \int_{-1}^0 y(1 - y^2)^{1/2} dy$$

$$= 2 \left[y - \frac{y^3}{3} \right]_{-1}^0 + 2 \left(\frac{1}{2} \right) \left[\frac{2(1 - y^2)^{3/2}}{3} \right]_{-1}^0 = 2 \left[(0 - 0) - \left(-1 + \frac{1}{3} \right) \right] + \left(\frac{2}{3} - 0 \right) = 2$$

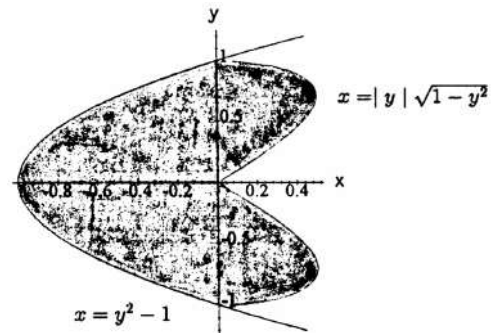

58. AREA = A1 + A2

Limits of integration: $x = 2y$ and $x = y^3 - y^2 \Rightarrow$
 $y^3 - y^2 = 2y \Rightarrow y(y^2 - y - 2) = y(y + 1)(y - 2) = 0$
 $\Rightarrow y = -1, 0, 2:$

$$\text{for } -1 \leq y \leq 0, f(y) - g(y) = y^3 - y^2 - 2y$$

$$\Rightarrow A_1 = \int_{-1}^0 (y^3 - y^2 - 2y) dy = \left[\frac{y^4}{4} - \frac{y^3}{3} - y^2 \right]_{-1}^0$$

$$= 0 - \left(\frac{1}{4} + \frac{1}{3} - 1 \right) = \frac{5}{12};$$

$$\text{for } 0 \leq y \leq 2, f(y) - g(y) = 2y - y^3 + y^2$$

$$\Rightarrow A_2 = \int_0^2 (2y - y^3 + y^2) dy = \left[y^2 - \frac{y^4}{4} + \frac{y^3}{3} \right]_0^2$$

$$\Rightarrow \left(4 - \frac{16}{4} + \frac{8}{3} \right) - 0 = \frac{8}{3};$$

$$\text{Therefore, } A_1 + A_2 = \frac{5}{12} + \frac{8}{3} = \frac{37}{12}$$

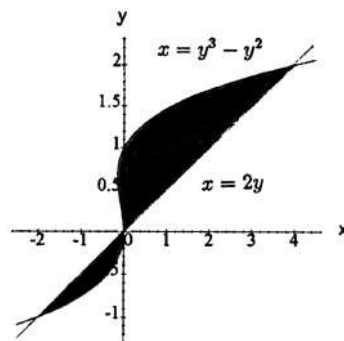
59. Limits of integration: $y = -4x^2 + 4$ and $y = x^4 - 1$

$$\Rightarrow x^4 - 1 = -4x^2 + 4 \Rightarrow x^4 + 4x^2 - 5 = 0$$

$$\Rightarrow (x^2 + 5)(x - 1)(x + 1) = 0 \Rightarrow a = -1 \text{ and } b = 1;$$

$$f(x) - g(x) = -4x^2 + 4 - x^4 + 1 = -4x^2 - x^4 + 5$$

$$\Rightarrow A = \int_{-1}^1 (-4x^2 - x^4 + 5) dx = \left[-\frac{4x^3}{3} - \frac{x^5}{5} + 5x \right]_{-1}^1$$

$$= \left(-\frac{4}{3} - \frac{1}{5} + 5 \right) - \left(\frac{4}{3} + \frac{1}{5} - 5 \right) = 2 \left(-\frac{4}{3} - \frac{1}{5} + 5 \right) = \frac{104}{15}$$

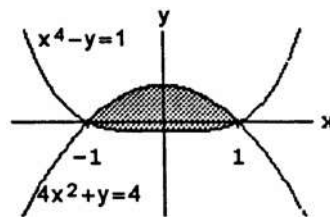
60. Limits of integration: $y = x^3$ and $y = 3x^2 - 4$

$$\Rightarrow x^3 - 3x^2 + 4 = 0 \Rightarrow (x^2 - x - 2)(x - 2) = 0$$

$$\Rightarrow (x + 1)(x - 2)^2 = 0 \Rightarrow a = -1 \text{ and } b = 2;$$

$$f(x) - g(x) = x^3 - (3x^2 - 4) = x^3 - 3x^2 + 4$$

$$\Rightarrow A = \int_{-1}^2 (x^3 - 3x^2 + 4) dx = \left[\frac{x^4}{4} - \frac{3x^3}{3} + 4x \right]_{-1}^2$$

$$= \left(\frac{16}{4} - \frac{24}{3} + 8 \right) - \left(\frac{1}{4} + 1 - 4 \right) = \frac{27}{4}$$

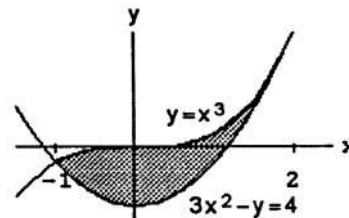
61. Limits of integration: $x = 4 - 4y^2$ and $x = 1 - y^4$

$$\Rightarrow 4 - 4y^2 = 1 - y^4 \Rightarrow y^4 - 4y^2 + 3 = 0$$

$$\Rightarrow (y - \sqrt{3})(y + \sqrt{3})(y - 1)(y + 1) = 0 \Rightarrow c = -1$$

$$\text{and } d = 1 \text{ since } x \geq 0; f(y) - g(y) = (4 - 4y^2) - (1 - y^4)$$

$$= 3 - 4y^2 + y^4 \Rightarrow A = \int_{-1}^1 (3 - 4y^2 + y^4) dy$$

$$= \left[3y - \frac{4y^3}{3} + \frac{y^5}{5} \right]_{-1}^1 = 2 \left(3 - \frac{4}{3} + \frac{1}{5} \right) = \frac{56}{15}$$

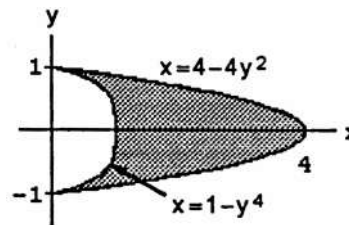
62. Limits of integration: $x = 3 - y^2$ and $x = -\frac{y^2}{4}$

$$\Rightarrow 3 - y^2 = -\frac{y^2}{4} \Rightarrow \frac{3y^2}{4} - 3 = 0 \Rightarrow \frac{3}{4}(y - 2)(y + 2) = 0$$

$$\Rightarrow c = -2 \text{ and } d = 2; f(y) - g(y) = (3 - y^2) - \left(-\frac{y^2}{4} \right)$$

$$= 3 \left(1 - \frac{y^2}{4} \right) \Rightarrow A = 3 \int_{-2}^2 \left(1 - \frac{y^2}{4} \right) dy = 3 \left[y - \frac{y^3}{12} \right]_{-2}^2$$

$$= 3 \left[\left(2 - \frac{8}{12} \right) - \left(-2 + \frac{8}{12} \right) \right] = 3 \left(4 - \frac{16}{12} \right) = 12 - 4 = 8$$

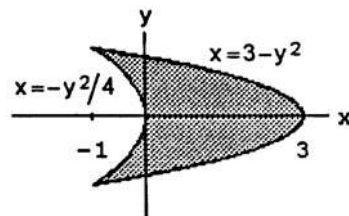

63. $a = 0, b = \pi; f(x) - g(x) = 2 \sin x - \sin 2x$

$$\begin{aligned} \Rightarrow A &= \int_0^{\pi} (2 \sin x - \sin 2x) dx = \left[-2 \cos x + \frac{\cos 2x}{2} \right]_0^{\pi} \\ &= \left[-2(-1) + \frac{1}{2} \right] - \left(-2 \cdot 1 + \frac{1}{2} \right) = 4 \end{aligned}$$

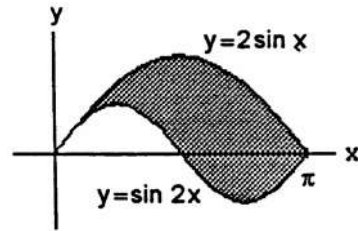

64. $a = -\frac{\pi}{3}, b = \frac{\pi}{3}; f(x) - g(x) = 8 \cos x - \sec^2 x$

$$\begin{aligned} \Rightarrow A &= \int_{-\pi/3}^{\pi/3} (8 \cos x - \sec^2 x) dx = \left[8 \sin x - \tan x \right]_{-\pi/3}^{\pi/3} \\ &= \left(8 \cdot \frac{\sqrt{3}}{2} - \sqrt{3} \right) - \left(-8 \cdot \frac{\sqrt{3}}{2} + \sqrt{3} \right) = 6\sqrt{3} \end{aligned}$$

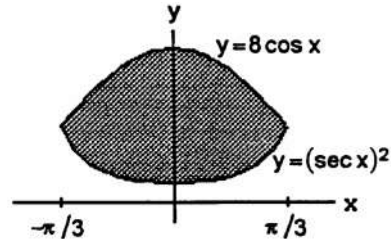

65. $a = -1, b = 1; f(x) - g(x) = (1 - x^2) - \cos\left(\frac{\pi x}{2}\right)$

$$\begin{aligned} \Rightarrow A &= \int_{-1}^1 \left[1 - x^2 - \cos\left(\frac{\pi x}{2}\right) \right] dx = \left[x - \frac{x^3}{3} - \frac{2}{\pi} \sin\left(\frac{\pi x}{2}\right) \right]_{-1}^1 \\ &= \left(1 - \frac{1}{3} - \frac{2}{\pi} \right) - \left(-1 + \frac{1}{3} + \frac{2}{\pi} \right) = 2 \left(\frac{2}{3} - \frac{2}{\pi} \right) = \frac{4}{3} - \frac{4}{\pi} \end{aligned}$$

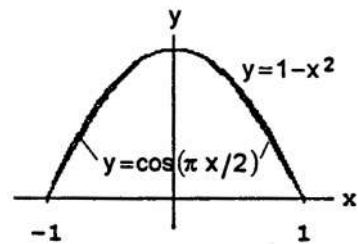

66. $A = A_1 + A_2$

$a_1 = -1, b_1 = 0 \text{ and } a_2 = 0, b_2 = 1;$

$f_1(x) - g_1(x) = x - \sin\left(\frac{\pi x}{2}\right) \text{ and } f_2(x) - g_2(x) = \sin\left(\frac{\pi x}{2}\right) - x$

\Rightarrow by symmetry about the origin,

$$\begin{aligned} A_1 + A_2 &= 2A_1 \Rightarrow A = 2 \int_0^1 \left[\sin\left(\frac{\pi x}{2}\right) - x \right] dx \\ &= 2 \left[-\frac{2}{\pi} \cos\left(\frac{\pi x}{2}\right) - \frac{x^2}{2} \right]_0^1 = 2 \left[\left(-\frac{2}{\pi} \cdot 0 - \frac{1}{2} \right) - \left(-\frac{2}{\pi} \cdot 1 - 0 \right) \right] \\ &= 2 \left(\frac{2}{\pi} - \frac{1}{2} \right) = 2 \left(\frac{4 - \pi}{2\pi} \right) = \frac{4 - \pi}{\pi} \end{aligned}$$

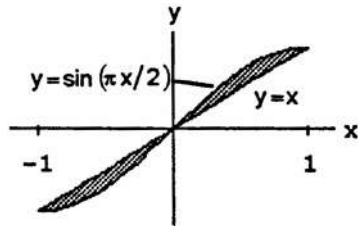

67. $a = -\frac{\pi}{4}, b = \frac{\pi}{4}; f(x) - g(x) = \sec^2 x - \tan^2 x$

$$\begin{aligned} \Rightarrow A &= \int_{-\pi/4}^{\pi/4} (\sec^2 x - \tan^2 x) dx \\ &= \int_{-\pi/4}^{\pi/4} [\sec^2 x - (\sec^2 x - 1)] dx \\ &= \int_{-\pi/4}^{\pi/4} 1 \cdot dx = [x]_{-\pi/4}^{\pi/4} = \frac{\pi}{4} - \left(-\frac{\pi}{4} \right) = \frac{\pi}{2} \end{aligned}$$

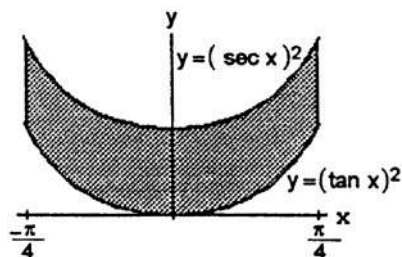

68. $c = -\frac{\pi}{4}, d = \frac{\pi}{4}; f(y) - g(y) = \tan^2 y - (-\tan^2 y) = 2 \tan^2 y$

$$\begin{aligned} &= 2(\sec^2 y - 1) \Rightarrow A = \int_{-\pi/4}^{\pi/4} 2(\sec^2 y - 1) dy \\ &= 2[\tan y - y]_{-\pi/4}^{\pi/4} = 2 \left[\left(1 - \frac{\pi}{4} \right) - \left(-1 + \frac{\pi}{4} \right) \right] \\ &= 4 \left(1 - \frac{\pi}{4} \right) = 4 - \pi \end{aligned}$$

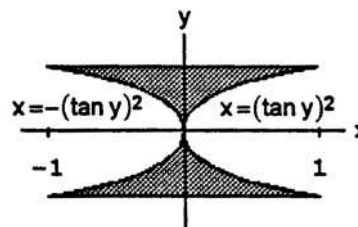

69. $c = 0, d = \frac{\pi}{2}; f(y) - g(y) = 3 \sin y \sqrt{\cos y} - 0 = 3 \sin y \sqrt{\cos y}$
 $\Rightarrow A = 3 \int_0^{\pi/2} \sin y \sqrt{\cos y} dy = -3 \left[\frac{2}{3} (\cos y)^{3/2} \right]_0^{\pi/2}$
 $= -2(0 - 1) = 2$

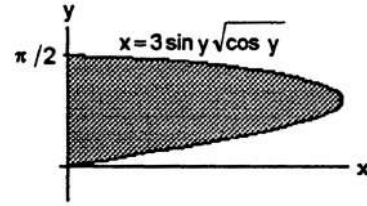

70. $a = -1, b = 1; f(x) - g(x) = \sec^2\left(\frac{\pi x}{3}\right) - x^{1/3}$
 $\Rightarrow A = \int_{-1}^1 [\sec^2\left(\frac{\pi x}{3}\right) - x^{1/3}] dx = \left[\frac{3}{\pi} \tan\left(\frac{\pi x}{3}\right) - \frac{3}{4} x^{4/3} \right]_{-1}^1$
 $= \left(\frac{3}{\pi} \sqrt{3} - \frac{3}{4} \right) - \left[\frac{3}{\pi} (-\sqrt{3}) - \frac{3}{4} \right] = \frac{6\sqrt{3}}{\pi}$

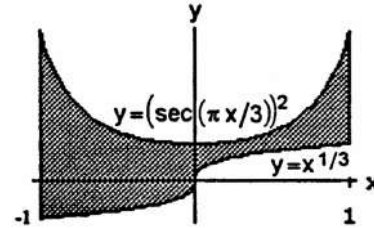

71. $A = A_1 + A_2$
 Limits of integration: $x = y^3$ and $x = y \Rightarrow y = y^3$
 $\Rightarrow y^3 - y = 0 \Rightarrow y(y - 1)(y + 1) = 0 \Rightarrow c_1 = -1, d_1 = 0$
 and $c_2 = 0, d_2 = 1; f_1(y) - g_1(y) = y^3 - y$ and
 $f_2(y) - g_2(y) = y - y^3 \Rightarrow$ by symmetry about the origin,
 $A_1 + A_2 = 2A_2 \Rightarrow A = 2 \int_0^1 (y - y^3) dy = 2 \left[\frac{y^2}{2} - \frac{y^4}{4} \right]_0^1$
 $= 2 \left(\frac{1}{2} - \frac{1}{4} \right) = \frac{1}{2}$

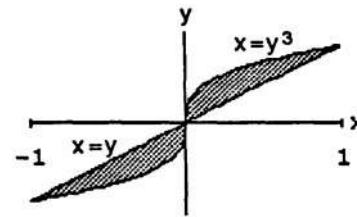

72. $A = A_1 + A_2$
 Limits of integration: $y = x^3$ and $y = x^5 \Rightarrow x^3 = x^5$
 $\Rightarrow x^5 - x^3 = 0 \Rightarrow x^3(x - 1)(x + 1) = 0 \Rightarrow a_1 = -1, b_1 = 0$
 and $a_2 = 0, b_2 = 1; f_1(x) - g_1(x) = x^3 - x^5$ and
 $f_2(x) - g_2(x) = x^5 - x^3 \Rightarrow$ by symmetry about the origin,
 $A_1 + A_2 = 2A_2 \Rightarrow A = 2 \int_0^1 (x^3 - x^5) dx = 2 \left[\frac{x^4}{4} - \frac{x^6}{6} \right]_0^1$
 $= 2 \left(\frac{1}{4} - \frac{1}{6} \right) = \frac{1}{6}$

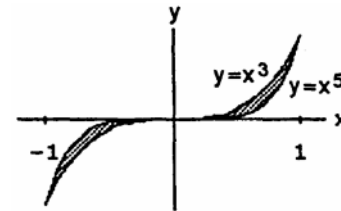

73. $A = A_1 + A_2$
 Limits of integration: $y = x$ and $y = \frac{1}{x^2} \Rightarrow x = \frac{1}{x^2}, x \neq 0$
 $\Rightarrow x^3 = 1 \Rightarrow x = 1, f_1(x) - g_1(x) = x - 0 = x$
 $\Rightarrow A_1 = \int_0^1 x dx = \left[\frac{x^2}{2} \right]_0^1 = \frac{1}{2}; f_2(x) - g_2(x) = \frac{1}{x^2} - 0$
 $= x^{-2} \Rightarrow A_2 = \int_1^2 x^{-2} dx = \left[\frac{-1}{x} \right]_1^2 = -\frac{1}{2} + 1 = \frac{1}{2};$
 $A = A_1 + A_2 = \frac{1}{2} + \frac{1}{2} = 1$

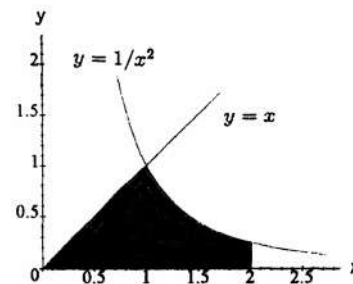

74. Limits of integration: $\sin x = \cos x \Rightarrow x = \frac{\pi}{4} \Rightarrow a = 0$
 and $b = \frac{\pi}{4}$; $f(x) - g(x) = \cos x - \sin x$

$$\begin{aligned} \Rightarrow A &= \int_0^{\pi/4} (\cos x - \sin x) dx = [\sin x + \cos x]_0^{\pi/4} \\ &= \left(\frac{\sqrt{2}}{2} + \frac{\sqrt{2}}{2}\right) - (0 + 1) = \sqrt{2} - 1 \end{aligned}$$

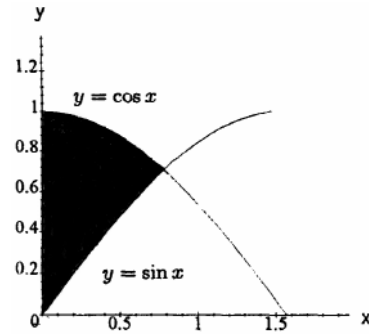

75. (a) The coordinates of the points of intersection of the line and parabola are $c = x^2 \Rightarrow x = \pm \sqrt{c}$ and $y = c$
 (b) $f(y) - g(y) = \sqrt{y} - (-\sqrt{y}) = 2\sqrt{y} \Rightarrow$ the area of the lower section is, $A_L = \int_0^c [f(y) - g(y)] dy$

$$= 2 \int_0^c \sqrt{y} dy = 2 \left[\frac{2}{3} y^{3/2} \right]_0^c = \frac{4}{3} c^{3/2}. \text{ The area of the}$$

entire shaded region can be found by setting $c = 4$: $A = \left(\frac{4}{3}\right) 4^{3/2} = \frac{4 \cdot 8}{3} = \frac{32}{3}$. Since we want c to divide the region into subsections of equal area we have $A = 2A_L \Rightarrow \frac{32}{3} = 2 \left(\frac{4}{3} c^{3/2}\right) \Rightarrow c = 4^{2/3}$

- (c) $f(x) - g(x) = c - x^2 \Rightarrow A_L = \int_{-\sqrt{c}}^{\sqrt{c}} [f(x) - g(x)] dx = \int_{-\sqrt{c}}^{\sqrt{c}} (c - x^2) dx = \left[cx - \frac{x^3}{3} \right]_{-\sqrt{c}}^{\sqrt{c}} = 2 \left[c^{3/2} - \frac{c^{3/2}}{3} \right] = \frac{4}{3} c^{3/2}$. Again, the area of the whole shaded region can be found by setting $c = 4 \Rightarrow A = \frac{32}{3}$. From the condition $A = 2A_L$, we get $\frac{4}{3} c^{3/2} = \frac{32}{3} \Rightarrow c = 4^{2/3}$ as in part (b).

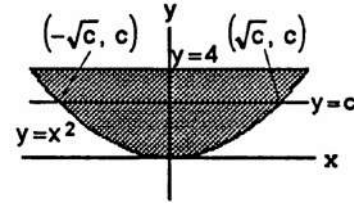

76. (a) Limits of integration: $y = 3 - x^2$ and $y = -1$
 $\Rightarrow 3 - x^2 = -1 \Rightarrow x^2 = 4 \Rightarrow a = -2$ and $b = 2$;
 $f(x) - g(x) = (3 - x^2) - (-1) = 4 - x^2$

$$\begin{aligned} \Rightarrow A &= \int_{-2}^2 (4 - x^2) dx = \left[4x - \frac{x^3}{3} \right]_{-2}^2 \\ &= \left(8 - \frac{8}{3}\right) - \left(-8 + \frac{8}{3}\right) = 16 - \frac{16}{3} = \frac{32}{3} \end{aligned}$$

- (b) Limits of integration: let $x = 0$ in $y = 3 - x^2$
 $\Rightarrow y = 3$; $f(y) - g(y) = \sqrt{3 - y} - (-\sqrt{3 - y})$
 $= 2(3 - y)^{1/2}$

$$\begin{aligned} \Rightarrow A &= 2 \int_{-1}^3 (3 - y)^{1/2} dy = -2 \int_{-1}^3 (3 - y)^{1/2} (-1) dy = (-2) \left[\frac{2(3 - y)^{3/2}}{3} \right]_{-1}^3 = \left(-\frac{4}{3}\right) [0 - (3 + 1)^{3/2}] \\ &= \left(\frac{4}{3}\right) (8) = \frac{32}{3} \end{aligned}$$

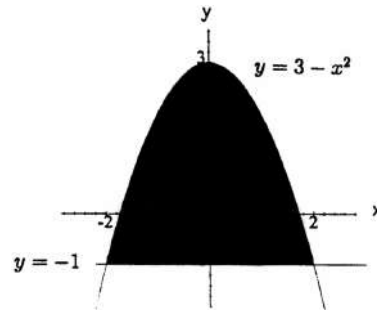

77. Limits of integration: $y = 1 + \sqrt{x}$ and $y = \frac{2}{\sqrt{x}}$
 $\Rightarrow 1 + \sqrt{x} = \frac{2}{\sqrt{x}}, x \neq 0 \Rightarrow \sqrt{x} + x = 2 \Rightarrow x = (2 - x)^2$
 $\Rightarrow x = 4 - 4x + x^2 \Rightarrow x^2 - 5x + 4 = 0$
 $\Rightarrow (x - 4)(x - 1) = 0 \Rightarrow x = 1, 4$ (but $x = 4$ does not satisfy the equation); $y = \frac{2}{\sqrt{x}}$ and $y = \frac{x}{4} \Rightarrow \frac{2}{\sqrt{x}} = \frac{x}{4}$
 $\Rightarrow 8 = x\sqrt{x} \Rightarrow 64 = x^3 \Rightarrow x = 4$.

Therefore, AREA = $A_1 + A_2$: $f_1(x) - g_1(x) = (1 + x^{1/2}) - \frac{x}{4}$

$$\Rightarrow A_1 = \int_0^1 \left(1 + x^{1/2} - \frac{x}{4}\right) dx = \left[x + \frac{2}{3} x^{3/2} - \frac{x^2}{8}\right]_0^1$$

$$\begin{aligned} &= \left(1 + \frac{2}{3} - \frac{1}{8}\right) - 0 = \frac{37}{24}; f_2(x) - g_2(x) = 2x^{-1/2} - \frac{x}{4} \Rightarrow A_2 = \int_1^4 \left(2x^{-1/2} - \frac{x}{4}\right) dx = \left[4x^{1/2} - \frac{x^2}{8}\right]_1^4 \\ &= \left(4 \cdot 2 - \frac{16}{8}\right) - \left(4 - \frac{1}{8}\right) = 4 - \frac{15}{8} = \frac{17}{8}; \text{ Therefore, AREA} = A_1 + A_2 = \frac{37}{24} + \frac{17}{8} = \frac{37+51}{24} = \frac{88}{24} = \frac{11}{3} \end{aligned}$$

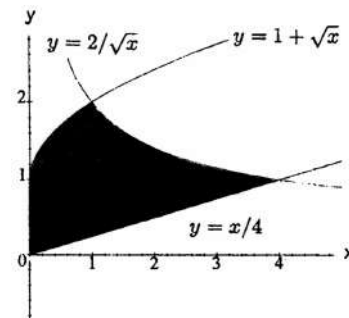

78. Limits of integration: $(y - 1)^2 = 3 - y \Rightarrow y^2 - 2y + 1 = 3 - y \Rightarrow y^2 - y - 2 = 0 \Rightarrow (y - 2)(y + 1) = 0$
 $\Rightarrow y = 2$ since $y > 0$; also, $2\sqrt{y} = 3 - y$
 $\Rightarrow 4y = 9 - 6y + y^2 \Rightarrow y^2 - 10y + 9 = 0$
 $\Rightarrow (y - 9)(y - 1) = 0 \Rightarrow y = 1$ since $y = 9$ does not satisfy the equation;

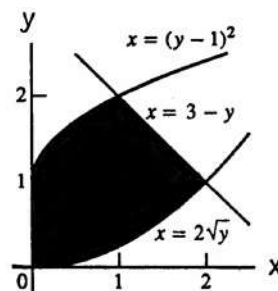

$$\text{AREA} = A_1 + A_2$$

$$f_1(y) - g_1(y) = 2\sqrt{y} - 0 = 2y^{1/2}$$

$$\Rightarrow A_1 = 2 \int_0^1 y^{1/2} dy = 2 \left[\frac{2y^{3/2}}{3} \right]_0^1 = \frac{4}{3}; f_2(y) - g_2(y) = (3 - y) - (y - 1)^2$$

$$\Rightarrow A_2 = \int_1^2 [3 - y - (y - 1)^2] dy = \left[3y - \frac{1}{2}y^2 - \frac{1}{3}(y - 1)^3 \right]_1^2 = \left(6 - 2 - \frac{1}{3} \right) - \left(3 - \frac{1}{2} + 0 \right) = 1 - \frac{1}{3} + \frac{1}{2} = \frac{7}{6};$$

$$\text{Therefore, } A_1 + A_2 = \frac{4}{3} + \frac{7}{6} = \frac{15}{6} = \frac{5}{2}$$

79. Area between parabola and $y = a^2$: $A = 2 \int_0^a (a^2 - x^2) dx = 2 \left[a^2x - \frac{1}{3}x^3 \right]_0^a = 2 \left(a^3 - \frac{a^3}{3} \right) - 0 = \frac{4a^3}{3};$

$$\text{Area of triangle AOC: } \frac{1}{2}(2a)(a^2) = a^3; \text{ limit of ratio} = \lim_{a \rightarrow 0^+} \frac{a^3}{\left(\frac{4a^3}{3}\right)} = \frac{3}{4} \text{ which is independent of } a.$$

$$80. A = \int_a^b 2f(x) dx - \int_a^b f(x) dx = 2 \int_a^b f(x) dx - \int_a^b f(x) dx = \int_a^b f(x) dx = 4$$

81. Neither one; they are both zero. Neither integral takes into account the changes in the formulas for the region's upper and lower bounding curves at $x = 0$. The area of the shaded region is actually

$$A = \int_{-1}^0 [-x - (-x)] dx + \int_0^1 [x - (-x)] dx = \int_{-1}^0 -2x dx + \int_0^1 2x dx = 2.$$

82. It is sometimes true. It is true if $f(x) \geq g(x)$ for all x between a and b . Otherwise it is false. If the graph of f lies below the graph of g for a portion of the interval of integration, the integral over that portion will be negative and the integral over $[a, b]$ will be less than the area between the curves (see Exercise 53).

83. Let $u = 2x \Rightarrow du = 2 dx \Rightarrow \frac{1}{2} du = dx$; $x = 1 \Rightarrow u = 2$, $x = 3 \Rightarrow u = 6$

$$\int_1^3 \frac{\sin 2x}{x} dx = \int_2^6 \frac{\sin u}{\left(\frac{u}{2}\right)} \left(\frac{1}{2} du\right) = \int_2^6 \frac{\sin u}{u} du = [F(u)]_2^6 = F(6) - F(2)$$

84. Let $u = 1 - x \Rightarrow du = -dx \Rightarrow -du = dx$; $x = 0 \Rightarrow u = 1$, $x = 1 \Rightarrow u = 0$

$$\int_0^1 f(1 - x) dx = \int_1^0 f(u)(-du) = -\int_1^0 f(u) du = \int_0^1 f(u) du = \int_0^1 f(x) dx$$

85. (a) Let $u = -x \Rightarrow du = -dx$; $x = -1 \Rightarrow u = 1$, $x = 0 \Rightarrow u = 0$

$$f \text{ odd} \Rightarrow f(-x) = -f(x). \text{ Then } \int_{-1}^0 f(x) dx = \int_1^0 f(-u)(-du) = \int_1^0 -f(u)(-du) = \int_1^0 f(u) du = -\int_0^1 f(u) du = -3$$

- (b) Let $u = -x \Rightarrow du = -dx$; $x = -1 \Rightarrow u = 1$, $x = 0 \Rightarrow u = 0$

$$f \text{ even} \Rightarrow f(-x) = f(x). \text{ Then } \int_{-1}^0 f(x) dx = \int_1^0 f(-u)(-du) = -\int_1^0 f(u) du = \int_0^1 f(u) du = 3$$

86. (a) Consider $\int_{-a}^0 f(x) dx$ when f is odd. Let $u = -x \Rightarrow du = -dx \Rightarrow -du = dx$ and $x = -a \Rightarrow u = a$ and $x = 0$

$$\Rightarrow u = 0. \text{ Thus } \int_{-a}^0 f(x) dx = \int_a^0 -f(-u) du = \int_a^0 f(u) du = -\int_0^a f(u) du = -\int_0^a f(x) dx.$$

$$\text{Thus } \int_{-a}^a f(x) dx = \int_{-a}^0 f(x) dx + \int_0^a f(x) dx = -\int_0^a f(x) dx + \int_0^a f(x) dx = 0.$$

$$(b) \int_{-\pi/2}^{\pi/2} \sin x \, dx = [-\cos x]_{-\pi/2}^{\pi/2} = -\cos\left(\frac{\pi}{2}\right) + \cos\left(-\frac{\pi}{2}\right) = 0 + 0 = 0.$$

87. Let $u = a - x \Rightarrow du = -dx$; $x = 0 \Rightarrow u = a$, $x = a \Rightarrow u = 0$

$$\begin{aligned} I &= \int_0^a \frac{f(x) \, dx}{f(x)+f(a-x)} = \int_a^0 \frac{f(a-u)}{f(a-u)+f(u)} (-du) = \int_0^a \frac{f(a-u)}{f(u)+f(a-u)} du = \int_0^a \frac{f(a-x)}{f(x)+f(a-x)} dx \\ \Rightarrow I + I &= \int_0^a \frac{f(x) \, dx}{f(x)+f(a-x)} + \int_0^a \frac{f(a-x)}{f(x)+f(a-x)} dx = \int_0^a \frac{f(x)+f(a-x)}{f(x)+f(a-x)} dx = \int_0^a dx = [x]_0^a = a - 0 = a. \end{aligned}$$

Therefore, $2I = a \Rightarrow I = \frac{a}{2}$.

88. Let $u = \frac{xy}{t} \Rightarrow du = -\frac{xy}{t^2} dt \Rightarrow -\frac{1}{xy} du = \frac{1}{t} dt \Rightarrow -\frac{1}{u} du = \frac{1}{t} dt$; $t = x \Rightarrow u = y$, $t = xy \Rightarrow u = 1$. Therefore,

$$\int_x^{xy} \frac{1}{t} dt = \int_y^1 -\frac{1}{u} du = -\int_y^1 \frac{1}{u} du = \int_1^y \frac{1}{u} du = \int_1^y \frac{1}{t} dt$$

89. Let $u = x + c \Rightarrow du = dx$; $x = a - c \Rightarrow u = a$, $x = b - c \Rightarrow u = b$

$$\int_{a-c}^{b-c} f(x+c) \, dx = \int_a^b f(u) \, du = \int_a^b f(x) \, dx$$

90. (a)

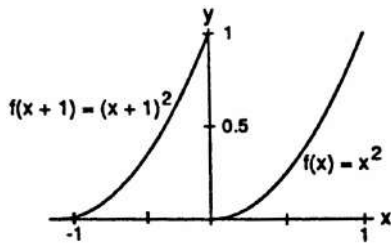

(b)

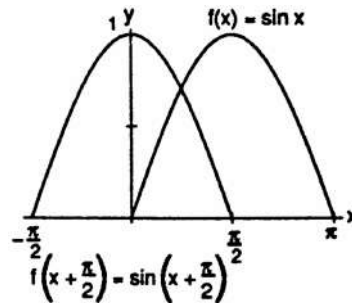

(c)

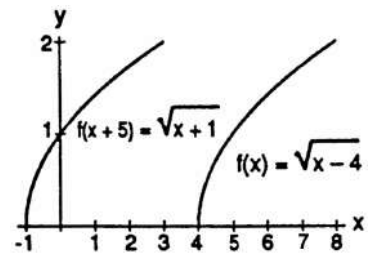

91-94. Example CAS commands:

Maple:

```
f := x -> x^3/3-x^2/2-2*x+1/3;
g := x -> x-1;
plot([f(x),g(x)], x=-5..5, legend=["y = f(x)", "y = g(x)"], title="#91(a) (Section 5.6)");
q1 := [-5, -2, 1, 4]; # (b)
q2 := [seq( fsolve( f(x)=g(x), x=q1[i]..q1[i+1] ), i=1..nops(q1)-1)];
for i from 1 to nops(q2)-1 do # (c)
  area[i] := int( abs(f(x)-g(x)), x=q2[i]..q2[i+1] );
end do;
add( area[i], i=1..nops(q2)-1 ); # (d)
```

Mathematica: (assigned functions may vary)

```
Clear[x, f, g]
f[x_] = x^2 Cos[x]
g[x_] = x^3 - x
Plot[{f[x], g[x]}, {x, -2, 2}]
```

After examining the plots, the initial guesses for FindRoot can be determined.

```
pts = x/.Map[FindRoot[f[x]==g[x],{x,#}]&, {-1, 0, 1}]
i1=NIntegrate[f[x] - g[x], {x, pts[[1]], pts[[2]]}]
i2=NIntegrate[f[x] - g[x], {x, pts[[2]], pts[[3]]}]
i1 + i2
```

CHAPTER 5 PRACTICE EXERCISES

1. (a) Each time subinterval is of length $\Delta t = 0.4$ sec. The distance traveled over each subinterval, using the midpoint rule, is $\Delta h = \frac{1}{2} (v_i + v_{i+1}) \Delta t$, where v_i is the velocity at the left endpoint and v_{i+1} the velocity at the right endpoint of the subinterval. We then add Δh to the height attained so far at the left endpoint v_i to arrive at the height associated with velocity v_{i+1} at the right endpoint. Using this methodology we build the following table based on the figure in the text:

t (sec)	0	0.4	0.8	1.2	1.6	2.0	2.4	2.8	3.2	3.6	4.0	4.4	4.8	5.2	5.6	6.0
v (fps)	0	10	25	55	100	190	180	165	150	140	130	115	105	90	76	65
h (ft)	0	2	9	25	56	114	188	257	320	378	432	481	525	564	592	620.2

t (sec)	6.4	6.8	7.2	7.6	8.0
v (fps)	50	37	25	12	0
h (ft)	643.2	660.6	672	679.4	681.8

NOTE: Your table values may vary slightly from ours depending on the v -values you read from the graph. Remember that some shifting of the graph occurs in the printing process.

The total height attained is about 680 ft.

- (b) The graph is based on the table in part (a).

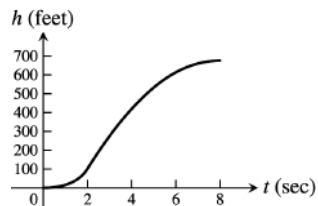

2. (a) Each time subinterval is of length $\Delta t = 1$ sec. The distance traveled over each subinterval, using the midpoint rule, is $\Delta s = \frac{1}{2} (v_i + v_{i+1}) \Delta t$, where v_i is the velocity at the left, and v_{i+1} the velocity at the right, endpoint of the subinterval. We then add Δs to the distance attained so far at the left endpoint v_i to arrive at the distance associated with velocity v_{i+1} at the right endpoint. Using this methodology we build the table given below based on the figure in the text, obtaining approximately 26 m for the total distance traveled:

t (sec)	0	1	2	3	4	5	6	7	8	9	10
v (m/sec)	0	0.5	1.2	2	3.4	4.5	4.8	4.5	3.5	2	0
s (m)	0	0.25	1.1	2.7	5.4	9.35	14	18.65	22.65	25.4	26.4

- (b) The graph shows the distance traveled by the moving body as a function of time for $0 \leq t \leq 10$.

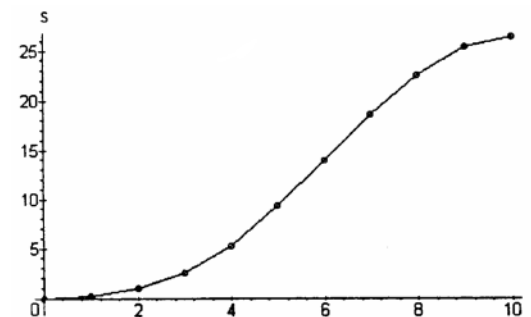

3. (a) $\sum_{k=1}^{10} \frac{a_k}{4} = \frac{1}{4} \sum_{k=1}^{10} a_k = \frac{1}{4}(-2) = -\frac{1}{2}$ (b) $\sum_{k=1}^{10} (b_k - 3a_k) = \sum_{k=1}^{10} b_k - 3 \sum_{k=1}^{10} a_k = 25 - 3(-2) = 31$
 (c) $\sum_{k=1}^{10} (a_k + b_k - 1) = \sum_{k=1}^{10} a_k + \sum_{k=1}^{10} b_k - \sum_{k=1}^{10} 1 = -2 + 25 - (1)(10) = 13$

$$(d) \sum_{k=1}^{10} \left(\frac{5}{2} - b_k\right) = \sum_{k=1}^{10} \frac{5}{2} - \sum_{k=1}^{10} b_k = \frac{5}{2}(10) - 25 = 0$$

$$4. (a) \sum_{k=1}^{20} 3a_k = 3 \sum_{k=1}^{20} a_k = 3(0) = 0 \quad (b) \sum_{k=1}^{20} (a_k + b_k) = \sum_{k=1}^{20} a_k + \sum_{k=1}^{20} b_k = 0 + 7 = 7$$

$$(c) \sum_{k=1}^{20} \left(\frac{1}{2} - \frac{2b_k}{7}\right) = \sum_{k=1}^{20} \frac{1}{2} - \frac{2}{7} \sum_{k=1}^{20} b_k = \frac{1}{2}(20) - \frac{2}{7}(7) = 8$$

$$(d) \sum_{k=1}^{20} (a_k - 2) = \sum_{k=1}^{20} a_k - \sum_{k=1}^{20} 2 = 0 - 2(20) = -40$$

$$5. \text{ Let } u = 2x - 1 \Rightarrow du = 2 dx \Rightarrow \frac{1}{2} du = dx; x = 1 \Rightarrow u = 1, x = 5 \Rightarrow u = 9$$

$$\int_1^5 (2x - 1)^{-1/2} dx = \int_1^9 u^{-1/2} \left(\frac{1}{2} du\right) = \left[\frac{1}{2} u^{1/2}\right]_1^9 = 3 - \frac{1}{2} = \frac{5}{2}$$

$$6. \text{ Let } u = x^2 - 1 \Rightarrow du = 2x dx \Rightarrow \frac{1}{2} du = x dx; x = 1 \Rightarrow u = 0, x = 3 \Rightarrow u = 8$$

$$\int_1^3 x(x^2 - 1)^{1/3} dx = \int_0^8 u^{1/3} \left(\frac{1}{2} du\right) = \left[\frac{3}{8} u^{4/3}\right]_0^8 = \frac{3}{8}(16 - 0) = 6$$

$$7. \text{ Let } u = \frac{x}{2} \Rightarrow 2 du = dx; x = -\pi \Rightarrow u = -\frac{\pi}{2}, x = 0 \Rightarrow u = 0$$

$$\int_{-\pi}^0 \cos\left(\frac{x}{2}\right) dx = \int_{-\pi/2}^0 (\cos u)(2 du) = [2 \sin u]_{-\pi/2}^0 = 2 \sin 0 - 2 \sin\left(-\frac{\pi}{2}\right) = 2(0 - (-1)) = 2$$

$$8. \text{ Let } u = \sin x \Rightarrow du = \cos x dx; x = 0 \Rightarrow u = 0, x = \frac{\pi}{2} \Rightarrow u = 1$$

$$\int_0^{\pi/2} (\sin x)(\cos x) dx = \int_0^1 u du = \left[\frac{u^2}{2}\right]_0^1 = \frac{1}{2}$$

$$9. (a) \int_{-2}^2 f(x) dx = \frac{1}{3} \int_{-2}^2 3 f(x) dx = \frac{1}{3}(12) = 4$$

$$(b) \int_2^5 f(x) dx = \int_{-2}^5 f(x) dx - \int_{-2}^2 f(x) dx = 6 - 4 = 2$$

$$(c) \int_5^{-2} g(x) dx = - \int_{-2}^5 g(x) dx = -2$$

$$(d) \int_{-2}^5 (-\pi g(x)) dx = -\pi \int_{-2}^5 g(x) dx = -\pi(2) = -2\pi$$

$$(e) \int_{-2}^5 \left(\frac{f(x)+g(x)}{5}\right) dx = \frac{1}{5} \int_{-2}^5 f(x) dx + \frac{1}{5} \int_{-2}^5 g(x) dx = \frac{1}{5}(6) + \frac{1}{5}(2) = \frac{8}{5}$$

$$10. (a) \int_0^2 g(x) dx = \frac{1}{7} \int_0^2 7 g(x) dx = \frac{1}{7}(7) = 1$$

$$(b) \int_1^2 g(x) dx = \int_0^2 g(x) dx - \int_0^1 g(x) dx = 1 - 2 = -1$$

$$(c) \int_2^0 f(x) dx = - \int_0^2 f(x) dx = -\pi$$

$$(d) \int_0^2 \sqrt{2} f(x) dx = \sqrt{2} \int_0^2 f(x) dx = \sqrt{2}(\pi) = \pi\sqrt{2}$$

$$(e) \int_0^2 [g(x) - 3 f(x)] dx = \int_0^2 g(x) dx - 3 \int_0^2 f(x) dx = 1 - 3\pi$$

$$11. x^2 - 4x + 3 = 0 \Rightarrow (x - 3)(x - 1) = 0 \Rightarrow x = 3 \text{ or } x = 1;$$

$$\text{Area} = \int_0^1 (x^2 - 4x + 3) dx - \int_1^3 (x^2 - 4x + 3) dx$$

$$= \left[\frac{x^3}{3} - 2x^2 + 3x\right]_0^1 - \left[\frac{x^3}{3} - 2x^2 + 3x\right]_1^3$$

$$= \left[\left(\frac{1^3}{3} - 2(1)^2 + 3(1)\right) - 0\right]$$

$$- \left[\left(\frac{3^3}{3} - 2(3)^2 + 3(3)\right) - \left(\frac{1^3}{3} - 2(1)^2 + 3(1)\right)\right]$$

$$= \left(\frac{1}{3} + 1\right) - [0 - \left(\frac{1}{3} + 1\right)] = \frac{8}{3}$$

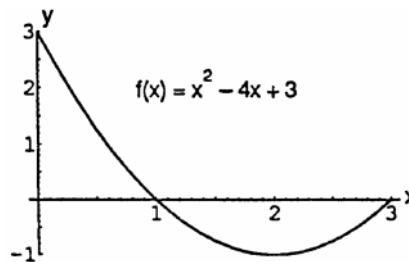

$$12. 1 - \frac{x^2}{4} = 0 \Rightarrow 4 - x^2 - 0 \Rightarrow x = \pm 2;$$

$$\begin{aligned} \text{Area} &= \int_{-2}^2 \left(1 - \frac{x^2}{4}\right) dx - \int_2^3 \left(1 - \frac{x^2}{4}\right) dx \\ &= \left[x - \frac{x^3}{12}\right]_{-2}^2 - \left[x - \frac{x^3}{12}\right]_2^3 \\ &= \left[\left(2 - \frac{2^3}{12}\right) - \left(-2 - \frac{(-2)^3}{12}\right)\right] - \left[\left(3 - \frac{3^3}{12}\right) - \left(2 - \frac{2^3}{12}\right)\right] \\ &= \left[\frac{4}{3} - \left(-\frac{4}{3}\right)\right] - \left(\frac{3}{4} - \frac{4}{3}\right) = \frac{13}{4} \end{aligned}$$

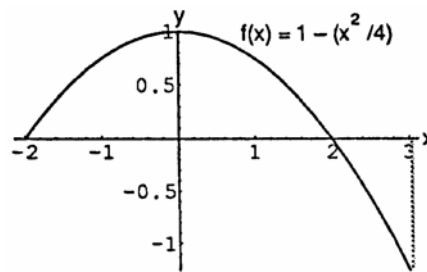

$$13. 5 - 5x^{2/3} = 0 \Rightarrow 1 - x^{2/3} = 0 \Rightarrow x = \pm 1;$$

$$\begin{aligned} \text{Area} &= \int_{-1}^1 (5 - 5x^{2/3}) dx - \int_1^8 (5 - 5x^{2/3}) dx \\ &= [5x - 3x^{5/3}]_{-1}^1 - [5x - 3x^{5/3}]_1^8 \\ &= [(5(1) - 3(1)^{5/3}) - (5(-1) - 3(-1)^{5/3})] \\ &\quad - [(5(8) - 3(8)^{5/3}) - (5(1) - 3(1)^{5/3})] \\ &= [2 - (-2)] - [(40 - 96) - 2] = 62 \end{aligned}$$

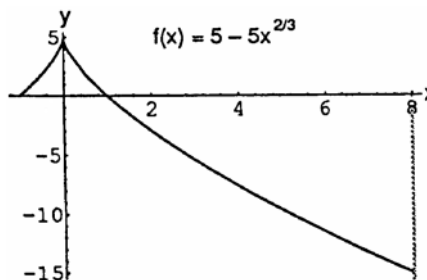

$$14. 1 - \sqrt{x} = 0 \Rightarrow x = 1;$$

$$\begin{aligned} \text{Area} &= \int_0^1 (1 - \sqrt{x}) dx - \int_1^4 (1 - \sqrt{x}) dx \\ &= \left[x - \frac{2}{3}x^{3/2}\right]_0^1 - \left[x - \frac{2}{3}x^{3/2}\right]_1^4 \\ &= \left[\left(1 - \frac{2}{3}(1)^{3/2}\right) - 0\right] - \left[\left(4 - \frac{2}{3}(4)^{3/2}\right) - \left(1 - \frac{2}{3}(1)^{3/2}\right)\right] \\ &= \frac{1}{3} - \left[\left(4 - \frac{16}{3}\right) - \frac{1}{3}\right] = 2 \end{aligned}$$

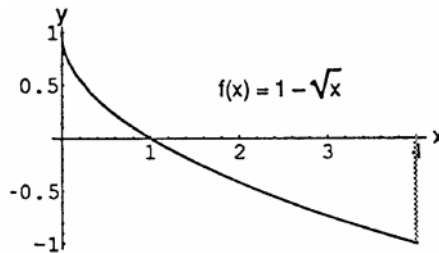

$$15. f(x) = x, g(x) = \frac{1}{x^2}, a = 1, b = 2 \Rightarrow A = \int_a^b [f(x) - g(x)] dx$$

$$= \int_1^2 \left(x - \frac{1}{x^2}\right) dx = \left[\frac{x^2}{2} + \frac{1}{x}\right]_1^2 = \left(\frac{4}{2} + \frac{1}{2}\right) - \left(\frac{1}{2} + 1\right) = 1$$

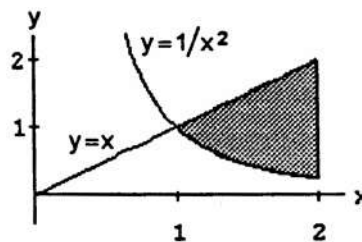

$$16. f(x) = x, g(x) = \frac{1}{\sqrt{x}}, a = 1, b = 2 \Rightarrow A = \int_a^b [f(x) - g(x)] dx$$

$$= \int_1^2 \left(x - \frac{1}{\sqrt{x}}\right) dx = \left[\frac{x^2}{2} - 2\sqrt{x}\right]_1^2$$

$$= \left(\frac{4}{2} - 2\sqrt{2}\right) - \left(\frac{1}{2} - 2\right) = \frac{7-4\sqrt{2}}{2}$$

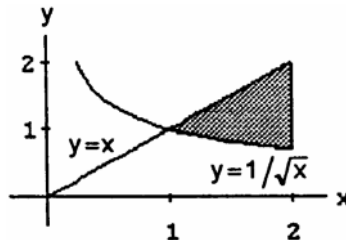

$$17. f(x) = (1 - \sqrt{x})^2, g(x) = 0, a = 0, b = 1 \Rightarrow A = \int_a^b [f(x) - g(x)] dx = \int_0^1 (1 - \sqrt{x})^2 dx = \int_0^1 (1 - 2\sqrt{x} + x) dx$$

$$= \int_0^1 (1 - 2x^{1/2} + x) dx = \left[x - \frac{4}{3}x^{3/2} + \frac{x^2}{2}\right]_0^1 = 1 - \frac{4}{3} + \frac{1}{2} = \frac{1}{6}(6 - 8 + 3) = \frac{1}{6}$$

$$18. f(x) = (1 - x^3)^2, g(x) = 0, a = 0, b = 1 \Rightarrow A = \int_a^b [f(x) - g(x)] dx = \int_0^1 (1 - x^3)^2 dx = \int_0^1 (1 - 2x^3 + x^6) dx$$

$$= \left[x - \frac{x^4}{2} + \frac{x^7}{7}\right]_0^1 = 1 - \frac{1}{2} + \frac{1}{7} = \frac{9}{14}$$

19. $f(y) = 2y^2, g(y) = 0, c = 0, d = 3$
 $\Rightarrow A = \int_c^d [f(y) - g(y)] dy = \int_0^3 (2y^2 - 0) dy$
 $= 2 \int_0^3 y^2 dy = \frac{2}{3} [y^3]_0^3 = 18$

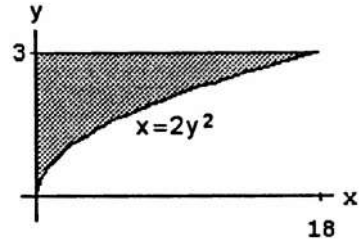

20. $f(y) = 4 - y^2, g(y) = 0, c = -2, d = 2$
 $\Rightarrow A = \int_c^d [f(y) - g(y)] dy = \int_{-2}^2 (4 - y^2) dy$
 $= \left[4y - \frac{y^3}{3} \right]_{-2}^2 = 2 \left(8 - \frac{8}{3} \right) = \frac{32}{3}$

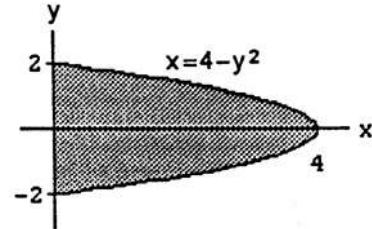

21. Let us find the intersection points: $\frac{y^2}{4} = \frac{y+2}{4}$
 $\Rightarrow y^2 - y - 2 = 0 \Rightarrow (y - 2)(y + 1) = 0 \Rightarrow y = -1$
 or $y = 2 \Rightarrow c = -1, d = 2; f(y) = \frac{y+2}{4}, g(y) = \frac{y^2}{4}$
 $\Rightarrow A = \int_c^d [f(y) - g(y)] dy = \int_{-1}^2 \left(\frac{y+2}{4} - \frac{y^2}{4} \right) dy$
 $= \frac{1}{4} \int_{-1}^2 (y + 2 - y^2) dy = \frac{1}{4} \left[\frac{y^2}{2} + 2y - \frac{y^3}{3} \right]_{-1}^2$
 $= \frac{1}{4} \left[\left(\frac{4}{2} + 4 - \frac{8}{3} \right) - \left(\frac{1}{2} - 2 + \frac{1}{3} \right) \right] = \frac{9}{8}$

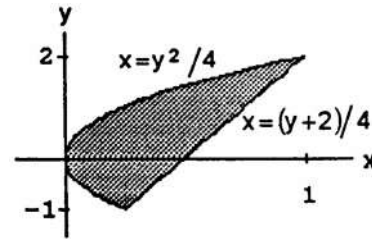

22. Let us find the intersection points: $\frac{y^2-4}{4} = \frac{y+16}{4}$
 $\Rightarrow y^2 - y - 20 = 0 \Rightarrow (y - 5)(y + 4) = 0 \Rightarrow y = -4$
 or $y = 5 \Rightarrow c = -4, d = 5; f(y) = \frac{y+16}{4}, g(y) = \frac{y^2-4}{4}$
 $\Rightarrow A = \int_c^d [f(y) - g(y)] dy = \int_{-4}^5 \left(\frac{y+16}{4} - \frac{y^2-4}{4} \right) dy$
 $= \frac{1}{4} \int_{-4}^5 (y + 20 - y^2) dy = \frac{1}{4} \left[\frac{y^2}{2} + 20y - \frac{y^3}{3} \right]_{-4}^5$
 $= \frac{1}{4} \left[\left(\frac{25}{2} + 100 - \frac{125}{3} \right) - \left(\frac{16}{2} - 80 + \frac{64}{3} \right) \right]$
 $= \frac{1}{4} \left(\frac{9}{2} + 180 - 63 \right) = \frac{1}{4} \left(\frac{9}{2} + 117 \right) = \frac{1}{8} (9 + 234) = \frac{243}{8}$

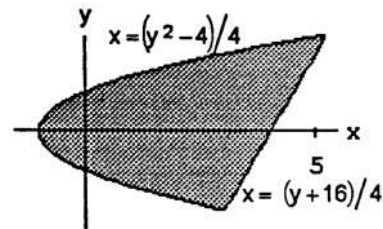

23. $f(x) = x, g(x) = \sin x, a = 0, b = \frac{\pi}{4}$
 $\Rightarrow A = \int_a^b [f(x) - g(x)] dx = \int_0^{\pi/4} (x - \sin x) dx$
 $= \left[\frac{x^2}{2} + \cos x \right]_0^{\pi/4} = \left(\frac{\pi^2}{32} + \frac{\sqrt{2}}{2} \right) - 1$

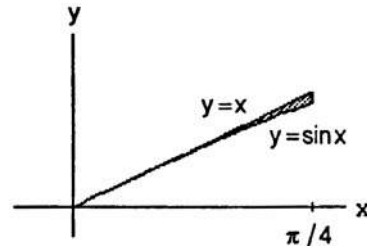

24. $f(x) = 1, g(x) = |\sin x|, a = -\frac{\pi}{2}, b = \frac{\pi}{2}$
 $\Rightarrow A = \int_a^b [f(x) - g(x)] dx = \int_{-\pi/2}^{\pi/2} (1 - |\sin x|) dx$
 $= \int_{-\pi/2}^0 (1 + \sin x) dx + \int_0^{\pi/2} (1 - \sin x) dx$
 $= 2 \int_0^{\pi/2} (1 - \sin x) dx = 2[x + \cos x]_0^{\pi/2}$
 $= 2 \left(\frac{\pi}{2} - 1 \right) = \pi - 2$

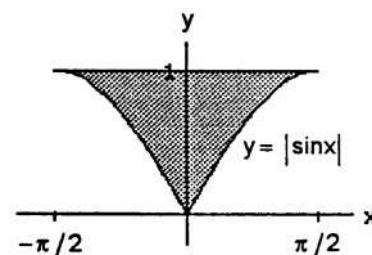

25. $a = 0, b = \pi, f(x) - g(x) = 2 \sin x - \sin 2x$

$$\Rightarrow A = \int_0^\pi (2 \sin x - \sin 2x) dx = \left[-2 \cos x + \frac{\cos 2x}{2}\right]_0^\pi$$

$$= \left[-2 \cdot (-1) + \frac{1}{2}\right] - \left(-2 \cdot 1 + \frac{1}{2}\right) = 4$$

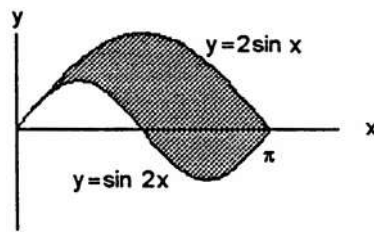

26. $a = -\frac{\pi}{3}, b = \frac{\pi}{3}, f(x) - g(x) = 8 \cos x - \sec^2 x$

$$\Rightarrow A = \int_{-\pi/3}^{\pi/3} (8 \cos x - \sec^2 x) dx = [8 \sin x - \tan x]_{-\pi/3}^{\pi/3}$$

$$= \left(8 \cdot \frac{\sqrt{3}}{2} - \sqrt{3}\right) - \left(-8 \cdot \frac{\sqrt{3}}{2} + \sqrt{3}\right) = 6\sqrt{3}$$

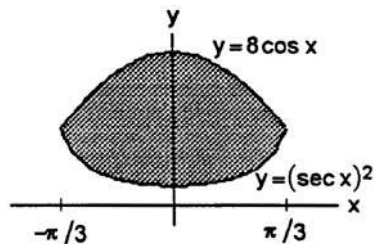

27. $f(y) = \sqrt{y}, g(y) = 2 - y, c = 1, d = 2$

$$\Rightarrow A = \int_c^d [f(y) - g(y)] dy = \int_1^2 [\sqrt{y} - (2 - y)] dy$$

$$= \int_1^2 (\sqrt{y} - 2 + y) dy = \left[\frac{2}{3} y^{3/2} - 2y + \frac{y^2}{2}\right]_1^2$$

$$= \left(\frac{4}{3} \sqrt{2} - 4 + 2\right) - \left(\frac{2}{3} - 2 + \frac{1}{2}\right) = \frac{4}{3} \sqrt{2} - \frac{7}{6} = \frac{8\sqrt{2}-7}{6}$$

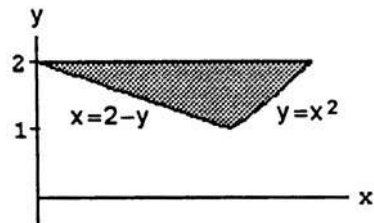

28. $f(y) = 6 - y, g(y) = y^2, c = 1, d = 2$

$$\Rightarrow A = \int_c^d [f(y) - g(y)] dy = \int_1^2 (6 - y - y^2) dy$$

$$= \left[6y - \frac{y^2}{2} - \frac{y^3}{3}\right]_1^2 = \left(12 - 2 - \frac{8}{3}\right) - \left(6 - \frac{1}{2} - \frac{1}{3}\right)$$

$$= 4 - \frac{7}{3} + \frac{1}{2} = \frac{24-14+3}{6} = \frac{13}{6}$$

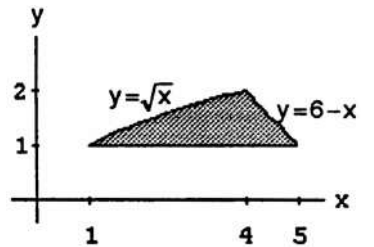

29. $f(x) = x^3 - 3x^2 = x^2(x - 3) \Rightarrow f'(x) = 3x^2 - 6x = 3x(x - 2) \Rightarrow f' = \begin{matrix} + & + & + & + & | & - & - & - & - & | & + & + & + & + \end{matrix}$

$$\Rightarrow f(0) = 0 \text{ is a maximum and } f(2) = -4 \text{ is a minimum. } A = -\int_0^3 (x^3 - 3x^2) dx = -\left[\frac{x^4}{4} - x^3\right]_0^3$$

$$= -\left(\frac{81}{4} - 27\right) = \frac{27}{4}$$

30. $A = \int_0^a (a^{1/2} - x^{1/2})^2 dx = \int_0^a (a - 2\sqrt{a}x^{1/2} + x) dx = \left[ax - \frac{4}{3}\sqrt{a}x^{3/2} + \frac{x^2}{2}\right]_0^a = a^2 - \frac{4}{3}\sqrt{a} \cdot a\sqrt{a} + \frac{a^2}{2}$

$$= a^2 \left(1 - \frac{4}{3} + \frac{1}{2}\right) = \frac{a^2}{6} (6 - 8 + 3) = \frac{a^2}{6}$$

31. The area above the x-axis is $A_1 = \int_0^1 (y^{2/3} - y) dy$

$$= \left[\frac{3y^{5/3}}{5} - \frac{y^2}{2}\right]_0^1 = \frac{1}{10}; \text{ the area below the x-axis is}$$

$$A_2 = \int_{-1}^0 (y^{2/3} - y) dy = \left[\frac{3y^{5/3}}{5} - \frac{y^2}{2}\right]_{-1}^0 = \frac{11}{10}$$

$$\Rightarrow \text{the total area is } A_1 + A_2 = \frac{6}{5}$$

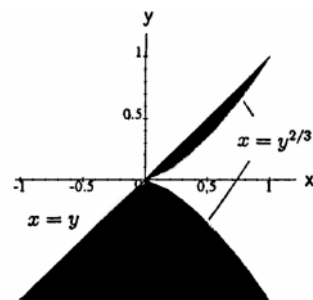

$$\begin{aligned}
32. A &= \int_0^{\pi/4} (\cos x - \sin x) dx + \int_{\pi/4}^{5\pi/4} (\sin x - \cos x) dx \\
&+ \int_{5\pi/4}^{3\pi/2} (\cos x - \sin x) dx = [\sin x + \cos x]_0^{\pi/4} \\
&+ [-\cos x - \sin x]_{\pi/4}^{5\pi/4} + [\sin x + \cos x]_{5\pi/4}^{3\pi/2} \\
&= \left[\left(\frac{\sqrt{2}}{2} + \frac{\sqrt{2}}{2} \right) - (0 + 1) \right] + \left[\left(\frac{\sqrt{2}}{2} + \frac{\sqrt{2}}{2} \right) - \left(-\frac{\sqrt{2}}{2} - \frac{\sqrt{2}}{2} \right) \right] \\
&+ \left[(-1 + 0) - \left(-\frac{\sqrt{2}}{2} - \frac{\sqrt{2}}{2} \right) \right] = \frac{8\sqrt{2}}{2} - 2 = 4\sqrt{2} - 2
\end{aligned}$$

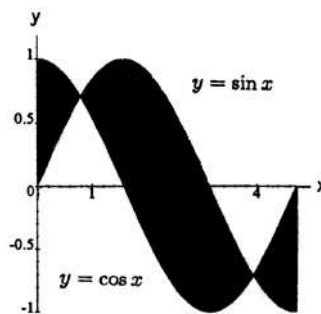

$$33. y = x^2 + \int_1^x \frac{1}{t} dt \Rightarrow \frac{dy}{dx} = 2x + \frac{1}{x} \Rightarrow \frac{d^2y}{dx^2} = 2 - \frac{1}{x^2}; y(1) = 1 + \int_1^1 \frac{1}{t} dt = 1 \text{ and } y'(1) = 2 + 1 = 3$$

$$34. y = \int_0^x (1 + 2\sqrt{\sec t}) dt \Rightarrow \frac{dy}{dx} = 1 + 2\sqrt{\sec x} \Rightarrow \frac{d^2y}{dx^2} = 2 \left(\frac{1}{2} \right) (\sec x)^{-1/2} (\sec x \tan x) = \sqrt{\sec x} (\tan x);$$

$$x = 0 \Rightarrow y = \int_0^0 (1 + 2\sqrt{\sec t}) dt = 0 \text{ and } x = 0 \Rightarrow \frac{dy}{dx} = 1 + 2\sqrt{\sec 0} = 3$$

$$35. y = \int_5^x \frac{\sin t}{t} dt - 3 \Rightarrow \frac{dy}{dx} = \frac{\sin x}{x}; x = 5 \Rightarrow y = \int_5^5 \frac{\sin t}{t} dt - 3 = -3$$

$$36. y = \int_{-1}^x \sqrt{2 - \sin^2 t} dt + 2 \text{ so that } \frac{dy}{dx} = \sqrt{2 - \sin^2 x}; x = -1 \Rightarrow y = \int_{-1}^{-1} \sqrt{2 - \sin^2 t} dt + 2 = 2$$

$$37. \text{ Let } u = \cos x \Rightarrow du = -\sin x dx \Rightarrow -du = \sin x dx$$

$$\int 2(\cos x)^{-1/2} \sin x dx = \int 2u^{-1/2}(-du) = -2 \int u^{-1/2} du = -2 \left(\frac{u^{1/2}}{1/2} \right) + C = -4u^{1/2} + C$$

$$= -4(\cos x)^{1/2} + C$$

$$38. \text{ Let } u = \tan x \Rightarrow du = \sec^2 x dx$$

$$\int (\tan x)^{-3/2} \sec^2 x dx = \int u^{-3/2} du = \frac{u^{-1/2}}{(-1/2)} + C = -2u^{-1/2} + C = \frac{-2}{(\tan x)^{1/2}} + C$$

$$39. \text{ Let } u = 2\theta + 1 \Rightarrow du = 2 d\theta \Rightarrow \frac{1}{2} du = d\theta$$

$$\int [2\theta + 1 + 2 \cos(2\theta + 1)] d\theta = \int (u + 2 \cos u) \left(\frac{1}{2} du \right) = \frac{u^2}{4} + \sin u + C_1 = \frac{(2\theta + 1)^2}{4} + \sin(2\theta + 1) + C_1$$

$$= \theta^2 + \theta + \sin(2\theta + 1) + C, \text{ where } C = C_1 + \frac{1}{4} \text{ is still an arbitrary constant}$$

$$40. \text{ Let } u = 2\theta - \pi \Rightarrow du = 2 d\theta \Rightarrow \frac{1}{2} du = d\theta$$

$$\int \left(\frac{1}{\sqrt{2\theta - \pi}} + 2 \sec^2(2\theta - \pi) \right) d\theta = \int \left(\frac{1}{\sqrt{u}} + 2 \sec^2 u \right) \left(\frac{1}{2} du \right) = \frac{1}{2} \int (u^{-1/2} + 2 \sec^2 u) du$$

$$= \frac{1}{2} \left(\frac{u^{1/2}}{1/2} \right) + \frac{1}{2} (2 \tan u) + C = u^{1/2} + \tan u + C = (2\theta - \pi)^{1/2} + \tan(2\theta - \pi) + C$$

$$41. \int \left(t - \frac{2}{t} \right) \left(t + \frac{2}{t} \right) dt = \int \left(t^2 - \frac{4}{t^2} \right) dt = \int (t^2 - 4t^{-2}) dt = \frac{t^3}{3} - 4 \left(\frac{t^{-1}}{-1} \right) + C = \frac{t^3}{3} + \frac{4}{t} + C$$

$$42. \int \frac{(t+1)^2 - 1}{t^4} dt = \int \frac{t^2 + 2t}{t^4} dt = \int \left(\frac{1}{t^2} + \frac{2}{t^3} \right) dt = \int (t^{-2} + 2t^{-3}) dt = \frac{t^{-1}}{(-1)} + 2 \left(\frac{t^{-2}}{-2} \right) + C = -\frac{1}{t} - \frac{1}{t^2} + C$$

$$43. \text{ Let } u = 2t^{3/2} \Rightarrow du = 3\sqrt{t} dt \Rightarrow \frac{1}{3} du = \sqrt{t} dt$$

$$\int \sqrt{t} \sin(2t^{3/2}) dt = \frac{1}{3} \int \sin u du = -\frac{1}{3} \cos u + C = -\frac{1}{3} \cos(2t^{3/2}) + C$$

$$44. \text{ Let } u = 1 + \sec \theta \Rightarrow du = \sec \theta \tan \theta d\theta \Rightarrow \int \sec \theta \tan \theta \sqrt{1 + \sec \theta} d\theta = \int u^{1/2} du = \frac{2}{3} u^{3/2} + C \\ = \frac{2}{3} (1 + \sec \theta)^{3/2} + C$$

$$45. \int_{-1}^1 (3x^2 - 4x + 7) dx = [x^3 - 2x^2 + 7x]_{-1}^1 = [1^3 - 2(1)^2 + 7(1)] - [(-1)^3 - 2(-1)^2 + 7(-1)] = 6 - (-10) = 16$$

$$46. \int_0^1 (8s^3 - 12s^2 + 5) ds = [2s^4 - 4s^3 + 5s]_0^1 = [2(1)^4 - 4(1)^3 + 5(1)] - 0 = 3$$

$$47. \int_1^2 \frac{4}{v^2} dv = \int_1^2 4v^{-2} dv = [-4v^{-1}]_1^2 = \left(-\frac{4}{2}\right) - \left(-\frac{4}{1}\right) = 2$$

$$48. \int_1^{27} x^{-4/3} dx = [-3x^{-1/3}]_1^{27} = -3(27)^{-1/3} - (-3(1)^{-1/3}) = -3\left(\frac{1}{3}\right) + 3(1) = 2$$

$$49. \int_1^4 \frac{dt}{t\sqrt{t}} = \int_1^4 \frac{dt}{t^{3/2}} = \int_1^4 t^{-3/2} dt = [-2t^{-1/2}]_1^4 = \frac{-2}{\sqrt{4}} - \frac{(-2)}{\sqrt{1}} = 1$$

$$50. \text{ Let } x = 1 + \sqrt{u} \Rightarrow dx = \frac{1}{2} u^{-1/2} du \Rightarrow 2 dx = \frac{du}{\sqrt{u}}; u = 1 \Rightarrow x = 2, u = 4 \Rightarrow x = 3$$

$$\int_1^4 \frac{(1 + \sqrt{u})^{1/2}}{\sqrt{u}} du = \int_2^3 x^{1/2} (2 dx) = \left[2 \left(\frac{2}{3}\right) x^{3/2}\right]_2^3 = \frac{4}{3} (3^{3/2}) - \frac{4}{3} (2^{3/2}) = 4\sqrt{3} - \frac{8}{3}\sqrt{2} = \frac{4}{3} (3\sqrt{3} - 2\sqrt{2})$$

$$51. \text{ Let } u = 2x + 1 \Rightarrow du = 2 dx \Rightarrow 18 du = 36 dx; x = 0 \Rightarrow u = 1, x = 1 \Rightarrow u = 3$$

$$\int_0^1 \frac{36 dx}{(2x+1)^3} = \int_1^3 18u^{-3} du = \left[\frac{18u^{-2}}{-2}\right]_1^3 = \left[\frac{-9}{u^2}\right]_1^3 = \left(\frac{-9}{9}\right) - \left(\frac{-9}{1}\right) = 8$$

$$52. \text{ Let } u = 7 - 5r \Rightarrow du = -5 dr \Rightarrow -\frac{1}{5} du = dr; r = 0 \Rightarrow u = 7, r = 1 \Rightarrow u = 2$$

$$\int_0^1 \frac{dr}{\sqrt[3]{(7-5r)^2}} = \int_7^2 (7-5r)^{-2/3} dr = \int_7^2 u^{-2/3} \left(-\frac{1}{5} du\right) = -\frac{1}{5} [3u^{1/3}]_7^2 = \frac{3}{5} (3\sqrt[3]{7} - 3\sqrt[3]{2})$$

$$53. \text{ Let } u = 1 - x^{2/3} \Rightarrow du = -\frac{2}{3} x^{-1/3} dx \Rightarrow -\frac{3}{2} du = x^{-1/3} dx; x = \frac{1}{8} \Rightarrow u = 1 - \left(\frac{1}{8}\right)^{2/3} = \frac{3}{4}, \\ x = 1 \Rightarrow u = 1 - 1^{2/3} = 0$$

$$\int_{1/8}^1 x^{-1/3} (1 - x^{2/3})^{3/2} dx = \int_{3/4}^0 u^{3/2} \left(-\frac{3}{2} du\right) = \left[\left(-\frac{3}{2}\right) \left(\frac{u^{5/2}}{5/2}\right)\right]_{3/4}^0 = \left[-\frac{3}{5} u^{5/2}\right]_{3/4}^0 = -\frac{3}{5} (0)^{5/2} - \left(-\frac{3}{5}\right) \left(\frac{3}{4}\right)^{5/2} \\ = \frac{27\sqrt{3}}{160}$$

$$54. \text{ Let } u = 1 + 9x^4 \Rightarrow du = 36x^3 dx \Rightarrow \frac{1}{36} du = x^3 dx; x = 0 \Rightarrow u = 1, x = \frac{1}{2} \Rightarrow u = 1 + 9\left(\frac{1}{2}\right)^4 = \frac{25}{16}$$

$$\int_0^{1/2} x^3 (1 + 9x^4)^{-3/2} dx = \int_1^{25/16} u^{-3/2} \left(\frac{1}{36} du\right) = \left[\frac{1}{36} \left(\frac{u^{-1/2}}{-1/2}\right)\right]_1^{25/16} = \left[-\frac{1}{18} u^{-1/2}\right]_1^{25/16} \\ = -\frac{1}{18} \left(\frac{25}{16}\right)^{-1/2} - \left(-\frac{1}{18} (1)^{-1/2}\right) = \frac{1}{90}$$

$$55. \text{ Let } u = 5r \Rightarrow du = 5 dr \Rightarrow \frac{1}{5} du = dr; r = 0 \Rightarrow u = 0, r = \pi \Rightarrow u = 5\pi$$

$$\int_0^\pi \sin^2 5r dr = \int_0^{5\pi} (\sin^2 u) \left(\frac{1}{5} du\right) = \frac{1}{5} \left[\frac{u}{2} - \frac{\sin 2u}{4}\right]_0^{5\pi} = \left(\frac{\pi}{2} - \frac{\sin 10\pi}{20}\right) - \left(0 - \frac{\sin 0}{20}\right) = \frac{\pi}{2}$$

$$56. \text{ Let } u = 4t - \frac{\pi}{4} \Rightarrow du = 4 dt \Rightarrow \frac{1}{4} du = dt; t = 0 \Rightarrow u = -\frac{\pi}{4}, t = \frac{\pi}{4} \Rightarrow u = \frac{3\pi}{4}$$

$$\int_0^{\pi/4} \cos^2 \left(4t - \frac{\pi}{4}\right) dt = \int_{-\pi/4}^{3\pi/4} (\cos^2 u) \left(\frac{1}{4} du\right) = \frac{1}{4} \left[\frac{u}{2} + \frac{\sin 2u}{4}\right]_{-\pi/4}^{3\pi/4} = \frac{1}{4} \left(\frac{3\pi}{8} + \frac{\sin \left(\frac{3\pi}{2}\right)}{4}\right) - \frac{1}{4} \left(-\frac{\pi}{8} + \frac{\sin \left(-\frac{\pi}{2}\right)}{4}\right) \\ = \frac{\pi}{8} - \frac{1}{16} + \frac{1}{16} = \frac{\pi}{8}$$

$$57. \int_0^{\pi/3} \sec^2 \theta \, d\theta = [\tan \theta]_0^{\pi/3} = \tan \frac{\pi}{3} - \tan 0 = \sqrt{3}$$

$$58. \int_{\pi/4}^{3\pi/4} \csc^2 x \, dx = [-\cot x]_{\pi/4}^{3\pi/4} = \left(-\cot \frac{3\pi}{4}\right) - \left(-\cot \frac{\pi}{4}\right) = 2$$

$$59. \text{ Let } u = \frac{x}{6} \Rightarrow du = \frac{1}{6} dx \Rightarrow 6 du = dx; x = \pi \Rightarrow u = \frac{\pi}{6}, x = 3\pi \Rightarrow u = \frac{\pi}{2}$$

$$\int_{\pi}^{3\pi} \cot^2 \frac{x}{6} \, dx = \int_{\pi/6}^{\pi/2} 6 \cot^2 u \, du = 6 \int_{\pi/6}^{\pi/2} (\csc^2 u - 1) \, du = [6(-\cot u - u)]_{\pi/6}^{\pi/2} = 6 \left(-\cot \frac{\pi}{2} - \frac{\pi}{2}\right) - 6 \left(-\cot \frac{\pi}{6} - \frac{\pi}{6}\right)$$

$$= 6\sqrt{3} - 2\pi$$

$$60. \text{ Let } u = \frac{\theta}{3} \Rightarrow du = \frac{1}{3} d\theta \Rightarrow 3 du = d\theta; \theta = 0 \Rightarrow u = 0, \theta = \pi \Rightarrow u = \frac{\pi}{3}$$

$$\int_0^{\pi} \tan^2 \frac{\theta}{3} \, d\theta = \int_0^{\pi/3} (\sec^2 \frac{\theta}{3} - 1) \, d\theta = \int_0^{\pi/3} 3(\sec^2 u - 1) \, du = [3 \tan u - 3u]_0^{\pi/3}$$

$$= \left[3 \tan \frac{\pi}{3} - 3 \left(\frac{\pi}{3}\right)\right] - (3 \tan 0 - 0) = 3\sqrt{3} - \pi$$

$$61. \int_{-\pi/3}^0 \sec x \tan x \, dx = [\sec x]_{-\pi/3}^0 = \sec 0 - \sec \left(-\frac{\pi}{3}\right) = 1 - 2 = -1$$

$$62. \int_{\pi/4}^{3\pi/4} \csc z \cot z \, dz = [-\csc z]_{\pi/4}^{3\pi/4} = \left(-\csc \frac{3\pi}{4}\right) - \left(-\csc \frac{\pi}{4}\right) = -\sqrt{2} + \sqrt{2} = 0$$

$$63. \text{ Let } u = \sin x \Rightarrow du = \cos x \, dx; x = 0 \Rightarrow u = 0, x = \frac{\pi}{2} \Rightarrow u = 1$$

$$\int_0^{\pi/2} 5(\sin x)^{3/2} \cos x \, dx = \int_0^1 5u^{3/2} \, du = \left[5 \left(\frac{2}{5}\right) u^{5/2}\right]_0^1 = [2u^{5/2}]_0^1 = 2(1)^{5/2} - 2(0)^{5/2} = 2$$

$$64. \text{ Let } u = 1 - x^2 \Rightarrow du = -2x \, dx \Rightarrow -du = 2x \, dx; x = -1 \Rightarrow u = 0, x = 1 \Rightarrow u = 0$$

$$\int_{-1}^1 2x \sin(1 - x^2) \, dx = \int_0^0 -\sin u \, du = 0$$

$$65. \text{ Let } u = \sin 3x \Rightarrow du = 3 \cos 3x \, dx \Rightarrow \frac{1}{3} du = \cos 3x \, dx; x = -\frac{\pi}{2} \Rightarrow u = \sin \left(-\frac{3\pi}{2}\right) = 1, x = \frac{\pi}{2} \Rightarrow u = \sin \left(\frac{3\pi}{2}\right) = -1$$

$$\int_{-\pi/2}^{\pi/2} 15 \sin^4 3x \cos 3x \, dx = \int_1^{-1} 15u^4 \left(\frac{1}{3} du\right) = \int_1^{-1} 5u^4 \, du = [u^5]_1^{-1} = (-1)^5 - (1)^5 = -2$$

$$66. \text{ Let } u = \cos \left(\frac{x}{2}\right) \Rightarrow du = -\frac{1}{2} \sin \left(\frac{x}{2}\right) \, dx \Rightarrow -2 du = \sin \left(\frac{x}{2}\right) \, dx; x = 0 \Rightarrow u = \cos \left(\frac{0}{2}\right) = 1, x = \frac{2\pi}{3} \Rightarrow u = \cos \left(\frac{2\pi}{3}\right) = \frac{1}{2}$$

$$\int_0^{2\pi/3} \cos^{-4} \left(\frac{x}{2}\right) \sin \left(\frac{x}{2}\right) \, dx = \int_1^{1/2} u^{-4} (-2 du) = \left[-2 \left(\frac{u^{-3}}{-3}\right)\right]_1^{1/2} = \frac{2}{3} \left(\frac{1}{2}\right)^{-3} - \frac{2}{3} (1)^{-3} = \frac{2}{3} (8 - 1) = \frac{14}{3}$$

$$67. \text{ Let } u = 1 + 3 \sin^2 x \Rightarrow du = 6 \sin x \cos x \, dx \Rightarrow \frac{1}{2} du = 3 \sin x \cos x \, dx; x = 0 \Rightarrow u = 1, x = \frac{\pi}{2} \Rightarrow u = 1 + 3 \sin^2 \frac{\pi}{2} = 4$$

$$\int_0^{\pi/2} \frac{3 \sin x \cos x}{\sqrt{1 + 3 \sin^2 x}} \, dx = \int_1^4 \frac{1}{\sqrt{u}} \left(\frac{1}{2} du\right) = \int_1^4 \frac{1}{2} u^{-1/2} \, du = \left[\frac{1}{2} \left(\frac{u^{1/2}}{1/2}\right)\right]_1^4 = [u^{1/2}]_1^4 = 4^{1/2} - 1^{1/2} = 1$$

$$68. \text{ Let } u = 1 + 7 \tan x \Rightarrow du = 7 \sec^2 x \, dx \Rightarrow \frac{1}{7} du = \sec^2 x \, dx; x = 0 \Rightarrow u = 1 + 7 \tan 0 = 1, x = \frac{\pi}{4} \Rightarrow u = 1 + 7 \tan \frac{\pi}{4} = 8$$

$$\int_0^{\pi/4} \frac{\sec^2 x}{(1 + 7 \tan x)^{2/3}} \, dx = \int_1^8 \frac{1}{u^{2/3}} \left(\frac{1}{7} du\right) = \int_1^8 \frac{1}{7} u^{-2/3} \, du = \left[\frac{1}{7} \left(\frac{u^{1/3}}{1/3}\right)\right]_1^8 = \left[\frac{3}{7} u^{1/3}\right]_1^8 = \frac{3}{7} (8)^{1/3} - \frac{3}{7} (1)^{1/3} = \frac{3}{7}$$

69. Let $u = \sec \theta \Rightarrow du = \sec \theta \tan \theta d\theta$; $\theta = 0 \Rightarrow u = \sec 0 = 1$, $\theta = \frac{\pi}{3} \Rightarrow u = \sec \frac{\pi}{3} = 2$

$$\begin{aligned} \int_0^{\pi/3} \frac{\tan \theta}{\sqrt{2 \sec \theta}} d\theta &= \int_0^{\pi/3} \frac{\sec \theta \tan \theta}{\sec \theta \sqrt{2 \sec \theta}} d\theta = \int_0^{\pi/3} \frac{\sec \theta \tan \theta}{\sqrt{2} (\sec \theta)^{3/2}} d\theta = \int_1^2 \frac{1}{\sqrt{2} u^{3/2}} du = \frac{1}{\sqrt{2}} \int_1^2 u^{-3/2} du \\ &= \frac{1}{\sqrt{2}} \left[\frac{u^{-1/2}}{(-1/2)} \right]_1^2 = \left[-\frac{2}{\sqrt{2}u} \right]_1^2 = -\frac{2}{\sqrt{2}(2)} - \left(-\frac{2}{\sqrt{2}(1)} \right) = \sqrt{2} - 1 \end{aligned}$$

70. Let $u = \sin \sqrt{t} \Rightarrow du = (\cos \sqrt{t}) \left(\frac{1}{2} t^{-1/2} \right) dt = \frac{\cos \sqrt{t}}{2\sqrt{t}} dt \Rightarrow 2 du = \frac{\cos \sqrt{t}}{\sqrt{t}} dt$; $t = \frac{\pi^2}{36} \Rightarrow u = \sin \frac{\pi}{6} = \frac{1}{2}$,
 $t = \frac{\pi^2}{4} \Rightarrow u = \sin \frac{\pi}{2} = 1$

$$\int_{\pi^2/36}^{\pi^2/4} \frac{\cos \sqrt{t}}{\sqrt{t} \sin \sqrt{t}} dt = \int_{1/2}^1 \frac{1}{\sqrt{u}} (2 du) = 2 \int_{1/2}^1 u^{-1/2} du = [4\sqrt{u}]_{1/2}^1 = 4\sqrt{1} - 4\sqrt{1/2} = 2(2 - \sqrt{2})$$

71. (a) $av(f) = \frac{1}{1-(-1)} \int_{-1}^1 (mx + b) dx = \frac{1}{2} \left[\frac{mx^2}{2} + bx \right]_{-1}^1 = \frac{1}{2} \left[\left(\frac{m(1)^2}{2} + b(1) \right) - \left(\frac{m(-1)^2}{2} + b(-1) \right) \right] = \frac{1}{2} (2b) = b$

$$\begin{aligned} \text{(b) } av(f) &= \frac{1}{k-(-k)} \int_{-k}^k (mx + b) dx = \frac{1}{2k} \left[\frac{mx^2}{2} + bx \right]_{-k}^k = \frac{1}{2k} \left[\left(\frac{m(k)^2}{2} + b(k) \right) - \left(\frac{m(-k)^2}{2} + b(-k) \right) \right] \\ &= \frac{1}{2k} (2bk) = b \end{aligned}$$

72. (a) $y_{av} = \frac{1}{3-0} \int_0^3 \sqrt{3x} dx = \frac{1}{3} \int_0^3 \sqrt{3} x^{1/2} dx = \frac{\sqrt{3}}{3} \left[\frac{2}{3} x^{3/2} \right]_0^3 = \frac{\sqrt{3}}{3} \left[\frac{2}{3} (3)^{3/2} - \frac{2}{3} (0)^{3/2} \right] = \frac{\sqrt{3}}{3} (2\sqrt{3}) = 2$

$$\text{(b) } y_{av} = \frac{1}{a-0} \int_0^a \sqrt{ax} dx = \frac{1}{a} \int_0^a \sqrt{a} x^{1/2} dx = \frac{\sqrt{a}}{a} \left[\frac{2}{3} x^{3/2} \right]_0^a = \frac{\sqrt{a}}{a} \left(\frac{2}{3} (a)^{3/2} - \frac{2}{3} (0)^{3/2} \right) = \frac{\sqrt{a}}{a} \left(\frac{2}{3} a\sqrt{a} \right) = \frac{2}{3} a$$

73. $f'_{av} = \frac{1}{b-a} \int_a^b \sqrt{ax} f'(x) dx = \frac{1}{b-a} [f(x)]_a^b = \frac{1}{b-a} [f(b) - f(a)] = \frac{f(b) - f(a)}{b-a}$ so the average value of f' over $[a, b]$ is the slope of the secant line joining the points $(a, f(a))$ and $(b, f(b))$, which is the average rate of change of f over $[a, b]$.

74. Yes, because the average value of f on $[a, b]$ is $\frac{1}{b-a} \int_a^b f(x) dx$. If the length of the interval is 2, then $b - a = 2$ and the average value of the function is $\frac{1}{2} \int_a^b f(x) dx$.

75. We want to evaluate

$$\frac{1}{365-0} \int_0^{365} f(x) dx = \frac{1}{365} \int_0^{365} \left(37 \sin \left[\frac{2\pi}{365} (x - 101) \right] + 25 \right) dx = \frac{37}{365} \int_0^{365} \sin \left[\frac{2\pi}{365} (x - 101) \right] dx + \frac{25}{365} \int_0^{365} dx$$

Notice that the period of $y = \sin \left[\frac{2\pi}{365} (x - 101) \right]$ is $\frac{2\pi}{\frac{2\pi}{365}} = 365$ and that we are integrating this function over an interval of

length 365. Thus the value of $\frac{37}{365} \int_0^{365} \sin \left[\frac{2\pi}{365} (x - 101) \right] dx + \frac{25}{365} \int_0^{365} dx$ is $\frac{37}{365} \cdot 0 + \frac{25}{365} \cdot 365 = 25$.

76. $\frac{1}{675-20} \int_{20}^{675} (8.27 + 10^{-5}(26T - 1.87T^2)) dT = \frac{1}{655} \left[8.27T + \frac{26T^2}{2 \cdot 10^5} - \frac{1.87T^3}{3 \cdot 10^5} \right]_{20}^{675}$

$$= \frac{1}{655} \left(\left[8.27(675) + \frac{26(675)^2}{2 \cdot 10^5} - \frac{1.87(675)^3}{3 \cdot 10^5} \right] - \left[8.27(20) + \frac{26(20)^2}{2 \cdot 10^5} - \frac{1.87(20)^3}{3 \cdot 10^5} \right] \right) \approx \frac{1}{655} (3724.44 - 165.40)$$

$= 5.43 =$ the average value of C_v on $[20, 675]$. To find the temperature T at which $C_v = 5.43$, solve

$5.43 = 8.27 + 10^{-5}(26T - 1.87T^2)$ for T . We obtain $1.87T^2 - 26T - 284000 = 0$

$$\Rightarrow T = \frac{26 \pm \sqrt{(26)^2 - 4(1.87)(-284000)}}{2(1.87)} = \frac{26 \pm \sqrt{2124996}}{3.74}. \text{ So } T = -382.82 \text{ or } T = 396.72. \text{ Only } T = 396.72 \text{ lies in the}$$

interval $[20, 675]$, so $T = 396.72^\circ\text{C}$.

77. $\frac{dy}{dx} = \sqrt{2 + \cos^3 x}$

$$78. \frac{dy}{dx} = \sqrt{2 + \cos^3(7x^2)} \cdot \frac{d}{dx}(7x^2) = 14x\sqrt{2 + \cos^3(7x^2)}$$

$$79. \frac{dy}{dx} = \frac{d}{dx} \left(-\int_1^x \frac{6}{3+t^4} dt \right) = -\frac{6}{3+x^4}$$

$$80. \frac{dy}{dx} = \frac{d}{dx} \left(\int_{\sec x}^2 \frac{1}{t^2+1} dt \right) = -\frac{d}{dx} \left(\int_2^{\sec x} \frac{1}{t^2+1} dt \right) = -\frac{1}{\sec^2 x + 1} \frac{d}{dx}(\sec x) = -\frac{\sec x \tan x}{1 + \sec^2 x}$$

81. Yes. The function f , being differentiable on $[a, b]$, is then continuous on $[a, b]$. The Fundamental Theorem of Calculus says that every continuous function on $[a, b]$ is the derivative of a function on $[a, b]$.

82. The second part of the Fundamental Theorem of Calculus states that if $F(x)$ is an antiderivative of $f(x)$ on $[a, b]$, then $\int_a^b f(x) dx = F(b) - F(a)$. In particular, if $F(x)$ is an antiderivative of $\sqrt{1+x^4}$ on $[0, 1]$, then $\int_0^1 \sqrt{1+x^4} dx = F(1) - F(0)$.

$$83. y = \int_1^x \sqrt{1+t^2} dt = -\int_1^x \sqrt{1+t^2} dt \Rightarrow \frac{dy}{dx} = \frac{d}{dx} \left[-\int_1^x \sqrt{1+t^2} dt \right] = -\frac{d}{dx} \left[\int_1^x \sqrt{1+t^2} dt \right] = -\sqrt{1+x^2}$$

$$84. y = \int_{\cos x}^0 \frac{1}{1-t^2} dt = -\int_0^{\cos x} \frac{1}{1-t^2} dt \Rightarrow \frac{dy}{dx} = \frac{d}{dx} \left[-\int_0^{\cos x} \frac{1}{1-t^2} dt \right] = -\frac{d}{dx} \left[\int_0^{\cos x} \frac{1}{1-t^2} dt \right]$$

$$= -\left(\frac{1}{1-\cos^2 x} \right) \left(\frac{d}{dx}(\cos x) \right) = -\left(\frac{1}{\sin^2 x} \right) (-\sin x) = \frac{1}{\sin x} = \csc x$$

85. We estimate the area A using midpoints of the vertical intervals, and we will estimate the width of the parking lot on each interval by averaging the widths at top and bottom. This gives the estimate

$$A \approx 15 \cdot \left(\frac{0+36}{2} + \frac{36+54}{2} + \frac{54+51}{2} + \frac{51+49.5}{2} + \frac{49.5+54}{2} + \frac{54+64.4}{2} + \frac{64.4+67.5}{2} + \frac{67.5+42}{2} \right)$$

$$A \approx 5961 \text{ ft}^2. \text{ The cost is Area} \cdot (\$2.10/\text{ft}^2) \approx (5961 \text{ ft}^2) (\$2.10/\text{ft}^2) = \$12,518.10 \Rightarrow \text{the job cannot be done for } \$11,000.$$

86. (a) Before the chute opens for A, $a = -32 \text{ ft/sec}^2$. Since the helicopter is hovering, $v_0 = 0 \text{ ft/sec}$

$$\Rightarrow v = \int -32 dt = -32t + v_0 = -32t. \text{ Then } s_0 = 6400 \text{ ft} \Rightarrow s = \int -32t dt = -16t^2 + s_0 = -16t^2 + 6400.$$

At $t = 4 \text{ sec}$, $s = -16(4)^2 + 6400 = 6144 \text{ ft}$ when A's chute opens;

(b) For B, $s_0 = 7000 \text{ ft}$, $v_0 = 0$, $a = -32 \text{ ft/sec}^2 \Rightarrow v = \int -32 dt = -32t + v_0 = -32t \Rightarrow s = \int -32t dt$

$$= -16t^2 + s_0 = -16t^2 + 7000. \text{ At } t = 13 \text{ sec}, s = -16(13)^2 + 7000 = 4296 \text{ ft}$$
 when B's chute opens;

(c) After the chutes open, $v = -16 \text{ ft/sec} \Rightarrow s = \int -16 dt = -16t + s_0$. For A, $s_0 = 6144 \text{ ft}$ and for B,

$s_0 = 4296 \text{ ft}$. Therefore, for A, $s = -16t + 6144$ and for B, $s = -16t + 4296$. When they hit the ground,

$$s = 0 \Rightarrow \text{for A, } 0 = -16t + 6144 \Rightarrow t = \frac{6144}{16} = 384 \text{ seconds, and for B, } 0 = -16t + 4296 \Rightarrow t = \frac{4296}{16}$$

$= 268.5 \text{ seconds}$ to hit the ground after the chutes open. Since B's chute opens 58 seconds after A's opens

\Rightarrow B hits the ground first.

$$87. \text{av}(I) = \frac{1}{30} \int_0^{30} (1200 - 40t) dt = \frac{1}{30} [1200t - 20t^2]_0^{30} = \frac{1}{30} [(1200(30) - 20(30)^2) - (1200(0) - 20(0)^2)]$$

$$= \frac{1}{30} (18,000) = 600; \text{ Average Daily Holding Cost} = (600)(\$0.03) = \$18$$

$$88. \text{av}(I) = \frac{1}{14} \int_0^{14} (600 + 600t) dt = \frac{1}{14} [600t + 300t^2]_0^{14} = \frac{1}{14} [600(14) + 300(14)^2 - 0] = 4800; \text{ Average Daily Holding Cost} = (4800)(\$0.04) = \$192$$

$$89. \text{av}(I) = \frac{1}{30} \int_0^{30} \left(450 - \frac{t^2}{2}\right) dt = \frac{1}{30} \left[450t - \frac{t^3}{6}\right]_0^{30} = \frac{1}{30} \left[450(30) - \frac{30^3}{6} - 0\right] = 300; \text{Average Daily Holding Cost} \\ = (300)(\$0.02) = \$6$$

$$90. \text{av}(I) = \frac{1}{60} \int_0^{60} \left(600 - 20\sqrt{15t}\right) dt = \frac{1}{60} \int_0^{60} \left(600 - 20\sqrt{15}t^{1/2}\right) dt = \frac{1}{60} \left[600t - 20\sqrt{15}\left(\frac{2}{3}\right)t^{3/2}\right]_0^{60} \\ = \frac{1}{60} \left[600(60) - \frac{40\sqrt{15}}{3}(60)^{3/2} - 0\right] = \frac{1}{60} \left(36,000 - \left(\frac{320}{3}\right)15^2\right) = 200; \text{Average Daily Holding Cost} \\ = (200)(\$0.005) = \$1.00$$

CHAPTER 5 ADDITIONAL AND ADVANCED EXERCISES

1. (a) Yes, because $\int_0^1 f(x) dx = \frac{1}{7} \int_0^1 7f(x) dx = \frac{1}{7}(7) = 1$
 (b) No. For example, $\int_0^1 8x dx = [4x^2]_0^1 = 4$, but $\int_0^1 \sqrt{8x} dx = \left[2\sqrt{2}\left(\frac{x^{3/2}}{3/2}\right)\right]_0^1 = \frac{4\sqrt{2}}{3}(1^{3/2} - 0^{3/2}) \\ = \frac{4\sqrt{2}}{3} \neq \sqrt{4}$
2. (a) True: $\int_5^2 f(x) dx = -\int_2^5 f(x) dx = -3$
 (b) True: $\int_{-2}^5 [f(x) + g(x)] dx = \int_{-2}^5 f(x) dx + \int_{-2}^5 g(x) dx = \int_{-2}^2 f(x) dx + \int_2^5 f(x) dx + \int_{-2}^5 g(x) dx \\ = 4 + 3 + 2 = 9$
 (c) False: $\int_{-2}^5 f(x) dx = 4 + 3 = 7 > 2 = \int_{-2}^5 g(x) dx \Rightarrow \int_{-2}^5 [f(x) - g(x)] dx > 0 \Rightarrow \int_{-2}^5 [g(x) - f(x)] dx < 0$.
 On the other hand, $f(x) \leq g(x) \Rightarrow [g(x) - f(x)] \geq 0 \Rightarrow \int_{-2}^5 [g(x) - f(x)] dx \geq 0$ which is a contradiction.
3. $y = \frac{1}{a} \int_0^x f(t) \sin a(x-t) dt = \frac{1}{a} \int_0^x f(t) \sin ax \cos at dt - \frac{1}{a} \int_0^x f(t) \cos ax \sin at dt \\ = \frac{\sin ax}{a} \int_0^x f(t) \cos at dt - \frac{\cos ax}{a} \int_0^x f(t) \sin at dt \Rightarrow \frac{dy}{dx} = \cos ax \left(\int_0^x f(t) \cos at dt\right) \\ + \frac{\sin ax}{a} \left(\frac{d}{dx} \int_0^x f(t) \cos at dt\right) + \sin ax \int_0^x f(t) \sin at dt - \frac{\cos ax}{a} \left(\frac{d}{dx} \int_0^x f(t) \sin at dt\right) \\ = \cos ax \int_0^x f(t) \cos at dt + \frac{\sin ax}{a} (f(x) \cos ax) + \sin ax \int_0^x f(t) \sin at dt - \frac{\cos ax}{a} (f(x) \sin ax) \\ \Rightarrow \frac{dy}{dx} = \cos ax \int_0^x f(t) \cos at dt + \sin ax \int_0^x f(t) \sin at dt$. Next,
 $\frac{d^2y}{dx^2} = -a \sin ax \int_0^x f(t) \cos at dt + (\cos ax) \left(\frac{d}{dx} \int_0^x f(t) \cos at dt\right) + a \cos ax \int_0^x f(t) \sin at dt \\ + (\sin ax) \left(\frac{d}{dx} \int_0^x f(t) \sin at dt\right) = -a \sin ax \int_0^x f(t) \cos at dt + (\cos ax)f(x) \cos ax \\ + a \cos ax \int_0^x f(t) \sin at dt + (\sin ax)f(x) \sin ax = -a \sin ax \int_0^x f(t) \cos at dt + a \cos ax \int_0^x f(t) \sin at dt + f(x)$.
 Therefore, $y'' + a^2y = a \cos ax \int_0^x f(t) \sin at dt - a \sin ax \int_0^x f(t) \cos at dt + f(x) \\ + a^2 \left(\frac{\sin ax}{a} \int_0^x f(t) \cos at dt - \frac{\cos ax}{a} \int_0^x f(t) \sin at dt\right) = f(x)$. Note also that $y'(0) = y(0) = 0$.
4. $x = \int_0^y \frac{1}{\sqrt{1+4t^2}} dt \Rightarrow \frac{d}{dx}(x) = \frac{d}{dx} \int_0^y \frac{1}{\sqrt{1+4t^2}} dt = \frac{d}{dy} \left[\int_0^y \frac{1}{\sqrt{1+4t^2}} dt\right] \left(\frac{dy}{dx}\right)$ from the chain rule
 $\Rightarrow 1 = \frac{1}{\sqrt{1+4y^2}} \left(\frac{dy}{dx}\right) \Rightarrow \frac{dy}{dx} = \sqrt{1+4y^2}$. Then $\frac{d^2y}{dx^2} = \frac{d}{dx}(\sqrt{1+4y^2}) = \frac{d}{dy}(\sqrt{1+4y^2}) \left(\frac{dy}{dx}\right) \\ = \frac{1}{2}(1+4y^2)^{-1/2} (8y) \left(\frac{dy}{dx}\right) = \frac{4y \left(\frac{dy}{dx}\right)}{\sqrt{1+4y^2}} = \frac{4y(\sqrt{1+4y^2})}{\sqrt{1+4y^2}} = 4y$. Thus $\frac{d^2y}{dx^2} = 4y$, and the constant of

proportionality is 4.

$$5. (a) \int_0^{x^2} f(t) dt = x \cos \pi x \Rightarrow \frac{d}{dx} \int_0^{x^2} f(t) dt = \cos \pi x - \pi x \sin \pi x \Rightarrow f(x^2)(2x) = \cos \pi x - \pi x \sin \pi x$$

$$\Rightarrow f(x^2) = \frac{\cos \pi x - \pi x \sin \pi x}{2x}. \text{ Thus, } x = 2 \Rightarrow f(4) = \frac{\cos 2\pi - 2\pi \sin 2\pi}{4} = \frac{1}{4}$$

$$(b) \int_0^{f(x)} t^2 dt = \left[\frac{t^3}{3} \right]_0^{f(x)} = \frac{1}{3} (f(x))^3 \Rightarrow \frac{1}{3} (f(x))^3 = x \cos \pi x \Rightarrow (f(x))^3 = 3x \cos \pi x \Rightarrow f(x) = \sqrt[3]{3x \cos \pi x}$$

$$\Rightarrow f(4) = \sqrt[3]{3(4) \cos 4\pi} = \sqrt[3]{12}$$

$$6. \int_0^a f(x) dx = \frac{a^2}{2} + \frac{a}{2} \sin a + \frac{\pi}{2} \cos a. \text{ Let } F(a) = \int_0^a f(t) dt \Rightarrow f(a) = F'(a). \text{ Now } F(a) = \frac{a^2}{2} + \frac{a}{2} \sin a + \frac{\pi}{2} \cos a$$

$$\Rightarrow f(a) = F'(a) = a + \frac{1}{2} \sin a + \frac{a}{2} \cos a - \frac{\pi}{2} \sin a \Rightarrow f\left(\frac{\pi}{2}\right) = \frac{\pi}{2} + \frac{1}{2} \sin \frac{\pi}{2} + \frac{\left(\frac{\pi}{2}\right)}{2} \cos \frac{\pi}{2} - \frac{\pi}{2} \sin \frac{\pi}{2} = \frac{\pi}{2} + \frac{1}{2} - \frac{\pi}{2} = \frac{1}{2}$$

$$7. \int_1^b f(x) dx = \sqrt{b^2 + 1} - \sqrt{2} \Rightarrow f(b) = \frac{d}{db} \int_1^b f(x) dx = \frac{1}{2} (b^2 + 1)^{-1/2} (2b) = \frac{b}{\sqrt{b^2 + 1}} \Rightarrow f(x) = \frac{x}{\sqrt{x^2 + 1}}$$

8. The derivative of the left side of the equation is: $\frac{d}{dx} \left[\int_0^x \left[\int_0^u f(t) dt \right] du \right] = \int_0^x f(t) dt$; the derivative of the right

side of the equation is: $\frac{d}{dx} \left[\int_0^x f(u)(x-u) du \right] = \frac{d}{dx} \int_0^x f(u)x du - \frac{d}{dx} \int_0^x u f(u) du$

$$= \frac{d}{dx} \left[x \int_0^x f(u) du \right] - \frac{d}{dx} \int_0^x u f(u) du = \int_0^x f(u) du + x \left[\frac{d}{dx} \int_0^x f(u) du \right] - x f(x) = \int_0^x f(u) du + x f(x) - x f(x)$$

$$= \int_0^x f(u) du. \text{ Since each side has the same derivative, they differ by a constant, and since both sides equal 0}$$

when $x = 0$, the constant must be 0. Therefore, $\int_0^x \left[\int_0^u f(t) dt \right] du = \int_0^x f(u)(x-u) du$.

$$9. \frac{dy}{dx} = 3x^2 + 2 \Rightarrow y = \int (3x^2 + 2) dx = x^3 + 2x + C. \text{ Then } (1, -1) \text{ on the curve} \Rightarrow 1^3 + 2(1) + C = -1 \Rightarrow C = -4$$

$$\Rightarrow y = x^3 + 2x - 4$$

10. The acceleration due to gravity downward is $-32 \text{ ft/sec}^2 \Rightarrow v = \int -32 dt = -32t + v_0$, where v_0 is the initial velocity $\Rightarrow v = -32t + v_0 \Rightarrow s = \int (-32t + v_0) dt = -16t^2 + v_0 t + C$. If the release point, at $t = 0$, is $s = 0$, then $C = 0 \Rightarrow s = -16t^2 + v_0 t$. Then $s = 17 \Rightarrow 17 = -16t^2 + v_0 t \Rightarrow 16t^2 - v_0 t + 17 = 0$. The discriminant of this quadratic equation is -64 which says there is no real time when $s = 17$ ft. You had better duck.

$$11. \int_{-8}^3 f(x) dx = \int_{-8}^0 x^{2/3} dx + \int_0^3 -4 dx$$

$$= \left[\frac{3}{5} x^{5/3} \right]_{-8}^0 + [-4x]_0^3$$

$$= \left(0 - \frac{3}{5} (-8)^{5/3} \right) + (-4(3) - 0) = \frac{96}{5} - 12$$

$$= \frac{36}{5}$$

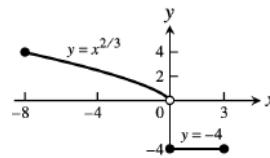

$$12. \int_{-4}^3 f(x) dx = \int_{-4}^0 \sqrt{-x} dx + \int_0^3 (x^2 - 4) dx$$

$$= \left[-\frac{2}{3} (-x)^{3/2} \right]_{-4}^0 + \left[\frac{x^3}{3} - 4x \right]_0^3$$

$$= \left[0 - \left(-\frac{2}{3} (4)^{3/2} \right) \right] + \left[\left(\frac{3^3}{3} - 4(3) \right) - 0 \right]$$

$$= \frac{16}{3} - 3 = \frac{7}{3}$$

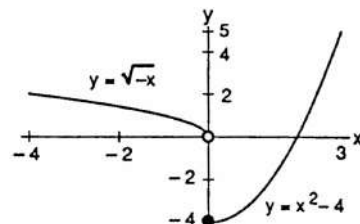

$$\begin{aligned}
 13. \int_0^2 g(t) dt &= \int_0^1 t dt + \int_1^2 \sin \pi t dt \\
 &= \left[\frac{t^2}{2} \right]_0^1 + \left[-\frac{1}{\pi} \cos \pi t \right]_1^2 \\
 &= \left(\frac{1}{2} - 0 \right) + \left[-\frac{1}{\pi} \cos 2\pi - \left(-\frac{1}{\pi} \cos \pi \right) \right] \\
 &= \frac{1}{2} - \frac{2}{\pi}
 \end{aligned}$$

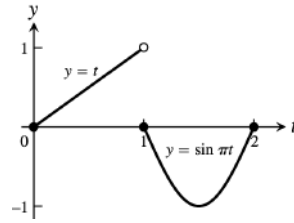

$$\begin{aligned}
 14. \int_0^2 h(z) dz &= \int_0^1 \sqrt{1-z} dz + \int_1^2 (7z-6)^{-1/3} dz \\
 &= \left[-\frac{2}{3} (1-z)^{3/2} \right]_0^1 + \left[\frac{3}{14} (7z-6)^{2/3} \right]_1^2 \\
 &= \left[-\frac{2}{3} (1-1)^{3/2} - \left(-\frac{2}{3} (1-0)^{3/2} \right) \right] \\
 &\quad + \left[\frac{3}{14} (7(2)-6)^{2/3} - \frac{3}{14} (7(1)-6)^{2/3} \right] \\
 &= \frac{2}{3} + \left(\frac{6}{7} - \frac{3}{14} \right) = \frac{55}{42}
 \end{aligned}$$

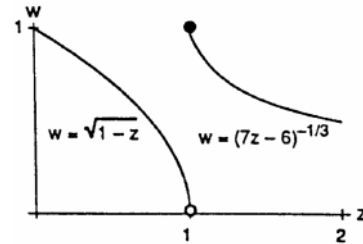

$$\begin{aligned}
 15. \int_{-2}^2 f(x) dx &= \int_{-2}^{-1} dx + \int_{-1}^1 (1-x^2) dx + \int_1^2 2 dx \\
 &= [x]_{-2}^{-1} + \left[x - \frac{x^3}{3} \right]_{-1}^1 + [2x]_1^2 \\
 &= (-1 - (-2)) + \left[\left(1 - \frac{1^3}{3} \right) - \left(-1 - \frac{(-1)^3}{3} \right) \right] + [2(2) - 2(1)] \\
 &= 1 + \frac{2}{3} - \left(-\frac{2}{3} \right) + 4 - 2 = \frac{13}{3}
 \end{aligned}$$

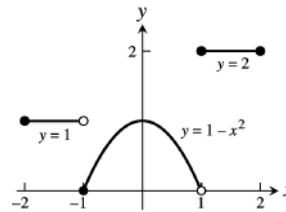

$$\begin{aligned}
 16. \int_{-1}^2 h(r) dr &= \int_{-1}^0 r dr + \int_0^1 (1-r^2) dr + \int_1^2 2 dr \\
 &= \left[\frac{r^2}{2} \right]_{-1}^0 + \left[r - \frac{r^3}{3} \right]_0^1 + [r^2]_1^2 \\
 &= \left(0 - \frac{(-1)^2}{2} \right) + \left(\left(1 - \frac{1^3}{3} \right) - 0 \right) + (2 - 1) \\
 &= -\frac{1}{2} + \frac{2}{3} + 1 = \frac{7}{6}
 \end{aligned}$$

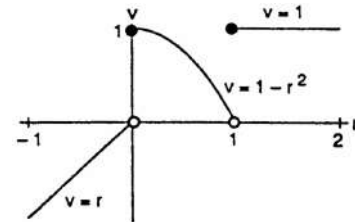

$$\begin{aligned}
 17. \text{Ave. value} &= \frac{1}{b-a} \int_a^b f(x) dx = \frac{1}{2-0} \int_0^2 f(x) dx = \frac{1}{2} \left[\int_0^1 x dx + \int_1^2 (x-1) dx \right] \\
 &= \frac{1}{2} \left[\left(\frac{1^2}{2} - 0 \right) + \left(\frac{2^2}{2} - 2 \right) - \left(\frac{1^2}{2} - 1 \right) \right] = \frac{1}{2}
 \end{aligned}$$

$$18. \text{Ave. value} = \frac{1}{b-a} \int_a^b f(x) dx = \frac{1}{3-0} \int_0^3 f(x) dx = \frac{1}{3} \left[\int_0^1 dx + \int_1^2 0 dx + \int_2^3 dx \right] = \frac{1}{3} [1 - 0 + 0 + 3 - 2] = \frac{2}{3}$$

$$19. f(x) = \int_{1/x}^x \frac{1}{t} dt \Rightarrow f'(x) = \frac{1}{x} \left(\frac{dx}{dx} \right) - \left(\frac{1}{x} \right) \left(\frac{d}{dx} \left(\frac{1}{x} \right) \right) = \frac{1}{x} - x \left(-\frac{1}{x^2} \right) = \frac{1}{x} + \frac{1}{x} = \frac{2}{x}$$

$$\begin{aligned}
 20. f(x) &= \int_{\cos x}^{\sin x} \frac{1}{t} \frac{1}{1-t^2} dt \Rightarrow f'(x) = \left(\frac{1}{1-\sin^2 x} \right) \left(\frac{d}{dx} (\sin x) \right) - \left(\frac{1}{1-\cos^2 x} \right) \left(\frac{d}{dx} (\cos x) \right) \\
 &= \frac{1}{\cos x} + \frac{1}{\sin x}
 \end{aligned}$$

$$21. g(y) = \int_{\sqrt{y}}^{2\sqrt{y}} \sin t^2 dt \Rightarrow g'(y) = \left(\sin (2\sqrt{y})^2 \right) \left(\frac{d}{dy} (2\sqrt{y}) \right) - \left(\sin (\sqrt{y})^2 \right) \left(\frac{d}{dy} (\sqrt{y}) \right) = \frac{\sin 4y}{\sqrt{y}} - \frac{\sin y}{2\sqrt{y}}$$

$$\begin{aligned}
 22. f(x) &= \int_x^{x+3} t(5-t) dt \Rightarrow f'(x) = (x+3)(5-(x+3)) \left(\frac{d}{dx} (x+3) \right) - x(5-x) \left(\frac{dx}{dx} \right) \\
 &= (x+3)(2-x) - x(5-x) = 6 - x - x^2 - 5x + x^2 = 6 - 6x. \text{ Thus } f'(x) = 0 \Rightarrow 6 - 6x = 0 \Rightarrow x = 1. \text{ Also, } f''(x) = -6 < 0 \Rightarrow x = 1 \text{ gives a}
 \end{aligned}$$

maximum.

23. Let $f(x) = x^5$ on $[0, 1]$. Partition $[0, 1]$ into n subintervals with $\Delta x = \frac{1-0}{n} = \frac{1}{n}$. Then $\frac{1}{n}, \frac{2}{n}, \dots, \frac{n}{n}$ are the right-hand endpoints of the subintervals. Since f is increasing on $[0, 1]$, $U = \sum_{j=1}^n \left(\frac{j}{n}\right)^5 \left(\frac{1}{n}\right)$ is the upper sum for

$$\begin{aligned} f(x) = x^5 \text{ on } [0, 1] &\Rightarrow \lim_{n \rightarrow \infty} \sum_{j=1}^n \left(\frac{j}{n}\right)^5 \left(\frac{1}{n}\right) = \lim_{n \rightarrow \infty} \frac{1}{n} \left[\left(\frac{1}{n}\right)^5 + \left(\frac{2}{n}\right)^5 + \dots + \left(\frac{n}{n}\right)^5 \right] = \lim_{n \rightarrow \infty} \left[\frac{1^5 + 2^5 + \dots + n^5}{n^6} \right] \\ &= \int_0^1 x^5 dx = \left[\frac{x^6}{6} \right]_0^1 = \frac{1}{6} \end{aligned}$$

24. Let $f(x) = x^3$ on $[0, 1]$. Partition $[0, 1]$ into n subintervals with $\Delta x = \frac{1-0}{n} = \frac{1}{n}$. Then $\frac{1}{n}, \frac{2}{n}, \dots, \frac{n}{n}$ are the right-hand endpoints of the subintervals. Since f is increasing on $[0, 1]$, $U = \sum_{j=1}^n \left(\frac{j}{n}\right)^3 \left(\frac{1}{n}\right)$ is the upper sum for

$$\begin{aligned} f(x) = x^3 \text{ on } [0, 1] &\Rightarrow \lim_{n \rightarrow \infty} \sum_{j=1}^n \left(\frac{j}{n}\right)^3 \left(\frac{1}{n}\right) = \lim_{n \rightarrow \infty} \frac{1}{n} \left[\left(\frac{1}{n}\right)^3 + \left(\frac{2}{n}\right)^3 + \dots + \left(\frac{n}{n}\right)^3 \right] = \lim_{n \rightarrow \infty} \left[\frac{1^3 + 2^3 + \dots + n^3}{n^4} \right] \\ &= \int_0^1 x^3 dx = \left[\frac{x^4}{4} \right]_0^1 = \frac{1}{4} \end{aligned}$$

25. Let $y = f(x)$ on $[0, 1]$. Partition $[0, 1]$ into n subintervals with $\Delta x = \frac{1-0}{n} = \frac{1}{n}$. Then $\frac{1}{n}, \frac{2}{n}, \dots, \frac{n}{n}$ are the right-hand endpoints of the subintervals. Since f is continuous on $[0, 1]$, $\sum_{j=1}^n f\left(\frac{j}{n}\right) \left(\frac{1}{n}\right)$ is a Riemann sum of

$$y = f(x) \text{ on } [0, 1] \Rightarrow \lim_{n \rightarrow \infty} \sum_{j=1}^n f\left(\frac{j}{n}\right) \left(\frac{1}{n}\right) = \lim_{n \rightarrow \infty} \frac{1}{n} \left[f\left(\frac{1}{n}\right) + f\left(\frac{2}{n}\right) + \dots + f\left(\frac{n}{n}\right) \right] = \int_0^1 f(x) dx$$

26. (a) $\lim_{n \rightarrow \infty} \frac{1}{n^2} [2 + 4 + 6 + \dots + 2n] = \lim_{n \rightarrow \infty} \frac{1}{n} \left[\frac{2}{n} + \frac{4}{n} + \frac{6}{n} + \dots + \frac{2n}{n} \right] = \int_0^1 2x dx = [x^2]_0^1 = 1$, where $f(x) = 2x$ on $[0, 1]$ (see Exercise 25)

(b) $\lim_{n \rightarrow \infty} \frac{1}{n^{16}} [1^{15} + 2^{15} + \dots + n^{15}] = \lim_{n \rightarrow \infty} \frac{1}{n} \left[\left(\frac{1}{n}\right)^{15} + \left(\frac{2}{n}\right)^{15} + \dots + \left(\frac{n}{n}\right)^{15} \right] = \int_0^1 x^{15} dx = \left[\frac{x^{16}}{16} \right]_0^1 = \frac{1}{16}$, where $f(x) = x^{15}$ on $[0, 1]$ (see Exercise 25)

(c) $\lim_{n \rightarrow \infty} \frac{1}{n} \left[\sin \frac{\pi}{n} + \sin \frac{2\pi}{n} + \dots + \sin \frac{n\pi}{n} \right] = \int_0^1 \sin n\pi dx = \left[-\frac{1}{\pi} \cos \pi x \right]_0^1 = -\frac{1}{\pi} \cos \pi - \left(-\frac{1}{\pi} \cos 0 \right) = \frac{2}{\pi}$, where $f(x) = \sin \pi x$ on $[0, 1]$ (see Exercise 25)

(d) $\lim_{n \rightarrow \infty} \frac{1}{n^{17}} [1^{15} + 2^{15} + \dots + n^{15}] = \left(\lim_{n \rightarrow \infty} \frac{1}{n} \right) \left(\lim_{n \rightarrow \infty} \frac{1}{n^{16}} [1^{15} + 2^{15} + \dots + n^{15}] \right) = \left(\lim_{n \rightarrow \infty} \frac{1}{n} \right) \int_0^1 x^{15} dx = 0 \left(\frac{1}{16} \right) = 0$ (see part (b) above)

(e) $\lim_{n \rightarrow \infty} \frac{1}{n^{15}} [1^{15} + 2^{15} + \dots + n^{15}] = \lim_{n \rightarrow \infty} \frac{n}{n^{16}} [1^{15} + 2^{15} + \dots + n^{15}] = \left(\lim_{n \rightarrow \infty} n \right) \left(\lim_{n \rightarrow \infty} \frac{1}{n^{16}} [1^{15} + 2^{15} + \dots + n^{15}] \right) = \left(\lim_{n \rightarrow \infty} n \right) \int_0^1 x^{15} dx = \infty$ (see part (b) above)

27. (a) Let the polygon be inscribed in a circle of radius r . If we draw a radius from the center of the circle (and the polygon) to each vertex of the polygon, we have n isosceles triangles formed (the equal sides are equal to r , the radius of the circle) and a vertex angle of θ_n where $\theta_n = \frac{2\pi}{n}$. The area of each triangle is

$$A_n = \frac{1}{2} r^2 \sin \theta_n \Rightarrow \text{the area of the polygon is } A = nA_n = \frac{n r^2}{2} \sin \theta_n = \frac{n r^2}{2} \sin \frac{2\pi}{n}.$$

(b) $\lim_{n \rightarrow \infty} A = \lim_{n \rightarrow \infty} \frac{n r^2}{2} \sin \frac{2\pi}{n} = \lim_{n \rightarrow \infty} \frac{n \pi r^2}{2\pi} \sin \frac{2\pi}{n} = \lim_{n \rightarrow \infty} (\pi r^2) \frac{\sin\left(\frac{2\pi}{n}\right)}{\left(\frac{2\pi}{n}\right)} = (\pi r^2) \lim_{2\pi/n \rightarrow 0} \frac{\sin\left(\frac{2\pi}{n}\right)}{\left(\frac{2\pi}{n}\right)} = \pi r^2$

28. $y = \sin x + \int_x^\pi \cos 2t dt + 1 = \sin x - \int_\pi^x \cos 2t dt + 1 \Rightarrow y' = \cos x - \cos(2x)$; when $x = \pi$ we have

$$y' = \cos \pi - \cos(2\pi) = -1 - 1 = -2. \text{ And } y'' = -\sin x + 2\sin(2x); \text{ when } x = \pi, y = \sin \pi + \int_x^\pi \cos 2t dt + 1 = 0 + 0 + 1 = 1.$$

29. (a) $g(1) = \int_1^1 f(t) dt = 0$

(b) $g(3) = \int_1^3 f(t) dt = -\frac{1}{2}(2)(1) = -1$

(c) $g(-1) = \int_1^{-1} f(t) dt = -\int_{-1}^1 f(t) dt = -\frac{1}{4}(\pi 2^2) = -\pi$

(d) $g'(x) = f(x) = 0 \Rightarrow x = -3, 1, 3$ and the sign chart for $g'(x) = f(x)$ is $\begin{array}{c|ccc|ccc} & -3 & & 1 & & 3 & & \\ \hline & + & + & + & - & - & - & + & + & + \end{array}$. So g has a relative maximum at $x = 1$.

(e) $g'(-1) = f(-1) = 2$ is the slope and $g(-1) = \int_1^{-1} f(t) dt = -\pi$, by (c). Thus the equation is $y + \pi = 2(x + 1)$
 $y = 2x + 2 - \pi$.

(f) $g''(x) = f'(x) = 0$ at $x = -1$ and $g''(x) = f'(x)$ is negative on $(-3, -1)$ and positive on $(-1, 1)$ so there is an inflection point for g at $x = -1$. We notice that $g''(x) = f'(x) < 0$ for x on $(-1, 2)$ and $g''(x) = f'(x) > 0$ for x on $(2, 4)$, even though $g''(2)$ does not exist, g has a tangent line at $x = 2$, so there is an inflection point at $x = 2$.

(g) g is continuous on $[-3, 4]$ and so it attains its absolute maximum and minimum values on this interval. We saw in (d) that $g'(x) = 0 \Rightarrow x = -3, 1, 3$. We have that

$$g(-3) = \int_1^{-3} f(t) dt = -\int_{-3}^1 f(t) dt = -\frac{\pi 2^2}{2} = -2\pi$$

$$g(1) = \int_1^1 f(t) dt = 0$$

$$g(3) = \int_1^3 f(t) dt = -1$$

$$g(4) = \int_1^4 f(t) dt = -1 + \frac{1}{2} \cdot 1 \cdot 1 = -\frac{1}{2}$$

Thus, the absolute minimum is -2π and the absolute maximum is 0. Thus, the range is $[-2\pi, 0]$.

NOTES:

NOTES:

CHAPTER 6 APPLICATIONS OF DEFINITE INTEGRALS

6.1 VOLUMES BY SLICING AND ROTATION ABOUT AN AXIS

- $A = \pi(\text{radius})^2$ and $\text{radius} = \sqrt{1-x^2} \Rightarrow A(x) = \pi(1-x^2)$
 - $A = \text{width} \cdot \text{height}$, $\text{width} = \text{height} = 2\sqrt{1-x^2} \Rightarrow A(x) = 4(1-x^2)$
 - $A = (\text{side})^2$ and $\text{diagonal} = \sqrt{2}(\text{side}) \Rightarrow A = \frac{(\text{diagonal})^2}{2}$; $\text{diagonal} = 2\sqrt{1-x^2} \Rightarrow A(x) = 2(1-x^2)$
 - $A = \frac{\sqrt{3}}{4}(\text{side})^2$ and $\text{side} = 2\sqrt{1-x^2} \Rightarrow A(x) = \sqrt{3}(1-x^2)$
- $A = \pi(\text{radius})^2$ and $\text{radius} = \sqrt{x} \Rightarrow A(x) = \pi x$
 - $A = \text{width} \cdot \text{height}$, $\text{width} = \text{height} = 2\sqrt{x} \Rightarrow A(x) = 4x$
 - $A = (\text{side})^2$ and $\text{diagonal} = \sqrt{2}(\text{side}) \Rightarrow A = \frac{(\text{diagonal})^2}{2}$; $\text{diagonal} = 2\sqrt{x} \Rightarrow A(x) = 2x$
 - $A = \frac{\sqrt{3}}{4}(\text{side})^2$ and $\text{side} = 2\sqrt{x} \Rightarrow A(x) = \sqrt{3}x$
- $A(x) = \frac{(\text{diagonal})^2}{2} = \frac{(\sqrt{x} - (-\sqrt{x}))^2}{2} = 2x$ (see Exercise 1c); $a = 0, b = 4$;
 $V = \int_a^b A(x) dx = \int_0^4 2x dx = [x^2]_0^4 = 16$
- $A(x) = \frac{\pi(\text{diameter})^2}{4} = \frac{\pi[(2-x^2) - x^2]^2}{4} = \frac{\pi[2(1-x^2)]^2}{4} = \pi(1-2x^2+x^4)$; $a = -1, b = 1$;
 $V = \int_a^b A(x) dx = \int_{-1}^1 \pi(1-2x^2+x^4) dx = \pi \left[x - \frac{2}{3}x^3 + \frac{x^5}{5} \right]_{-1}^1 = 2\pi \left(1 - \frac{2}{3} + \frac{1}{5} \right) = \frac{16\pi}{15}$
- $A(x) = (\text{edge})^2 = \left[\sqrt{1-x^2} - (-\sqrt{1-x^2}) \right]^2 = \left(2\sqrt{1-x^2} \right)^2 = 4(1-x^2)$; $a = -1, b = 1$;
 $V = \int_a^b A(x) dx = \int_{-1}^1 4(1-x^2) dx = 4 \left[x - \frac{x^3}{3} \right]_{-1}^1 = 8 \left(1 - \frac{1}{3} \right) = \frac{16}{3}$
- $A(x) = \frac{(\text{diagonal})^2}{2} = \frac{[\sqrt{1-x^2} - (-\sqrt{1-x^2})]^2}{2} = \frac{(2\sqrt{1-x^2})^2}{2} = 2(1-x^2)$ (see Exercise 1c); $a = -1, b = 1$;
 $V = \int_a^b A(x) dx = 2 \int_{-1}^1 (1-x^2) dx = 2 \left[x - \frac{x^3}{3} \right]_{-1}^1 = 4 \left(1 - \frac{1}{3} \right) = \frac{8}{3}$
- STEP 1) $A(x) = \frac{1}{2}(\text{side}) \cdot (\text{side}) \cdot \left(\sin \frac{\pi}{3}\right) = \frac{1}{2} \cdot (2\sqrt{\sin x}) \cdot (2\sqrt{\sin x}) \left(\sin \frac{\pi}{3}\right) = \sqrt{3} \sin x$
STEP 2) $a = 0, b = \pi$
STEP 3) $V = \int_a^b A(x) dx = \sqrt{3} \int_0^\pi \sin x dx = [-\sqrt{3} \cos x]_0^\pi = \sqrt{3}(1+1) = 2\sqrt{3}$
 - STEP 1) $A(x) = (\text{side})^2 = (2\sqrt{\sin x})^2 = 4 \sin x$
STEP 2) $a = 0, b = \pi$
STEP 3) $V = \int_a^b A(x) dx = \int_0^\pi 4 \sin x dx = [-4 \cos x]_0^\pi = 8$
- STEP 1) $A(x) = \frac{\pi(\text{diameter})^2}{4} = \frac{\pi}{4}(\sec x - \tan x)^2 = \frac{\pi}{4}(\sec^2 x + \tan^2 x - 2 \sec x \tan x)$
 $= \frac{\pi}{4} \left[\sec^2 x + (\sec^2 x - 1) - 2 \frac{\sin x}{\cos^2 x} \right]$
STEP 2) $a = -\frac{\pi}{3}, b = \frac{\pi}{3}$
STEP 3) $V = \int_a^b A(x) dx = \int_{-\pi/3}^{\pi/3} \frac{\pi}{4} \left(2 \sec^2 x - 1 - \frac{2 \sin x}{\cos^2 x} \right) dx = \frac{\pi}{4} \left[2 \tan x - x + 2 \left(-\frac{1}{\cos x} \right) \right]_{-\pi/3}^{\pi/3}$

$$= \frac{\pi}{4} \left[2\sqrt{3} - \frac{\pi}{3} + 2 \left(-\frac{1}{\frac{1}{2}} \right) - \left(-2\sqrt{3} + \frac{\pi}{3} + 2 \left(-\frac{1}{\frac{1}{2}} \right) \right) \right] = \frac{\pi}{4} \left(4\sqrt{3} - \frac{2\pi}{3} \right)$$

(b) STEP 1) $A(x) = (\text{edge})^2 = (\sec x - \tan x)^2 = (2 \sec^2 x - 1 - 2 \frac{\sin x}{\cos^2 x})$

STEP 2) $a = -\frac{\pi}{3}, b = \frac{\pi}{3}$

STEP 3) $V = \int_a^b A(x) dx = \int_{-\pi/3}^{\pi/3} (2 \sec^2 x - 1 - \frac{2 \sin x}{\cos^2 x}) dx = 2 \left(2\sqrt{3} - \frac{\pi}{3} \right) = 4\sqrt{3} - \frac{2\pi}{3}$

9. $A(y) = \frac{\pi}{4} (\text{diameter})^2 = \frac{\pi}{4} (\sqrt{5}y^2 - 0)^2 = \frac{5\pi}{4} y^4;$

$c = 0, d = 2; V = \int_c^d A(y) dy = \int_0^2 \frac{5\pi}{4} y^4 dy$

$= \left[\left(\frac{5\pi}{4} \right) \left(\frac{y^5}{5} \right) \right]_0^2 = \frac{\pi}{4} (2^5 - 0) = 8\pi$

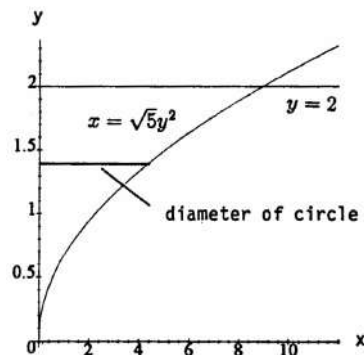

10. $A(y) = \frac{1}{2} (\text{leg})(\text{leg}) = \frac{1}{2} [\sqrt{1-y^2} - (-\sqrt{1-y^2})]^2 = \frac{1}{2} (2\sqrt{1-y^2})^2 = 2(1-y^2); c = -1, d = 1;$

$V = \int_c^d A(y) dy = \int_{-1}^1 2(1-y^2) dy = 2 \left[y - \frac{y^3}{3} \right]_{-1}^1 = 4 \left(1 - \frac{1}{3} \right) = \frac{8}{3}$

11. (a) It follows from Cavalieri's Principle that the volume of a column is the same as the volume of a right prism with a square base of side length s and altitude h . Thus, STEP 1) $A(x) = (\text{side length})^2 = s^2;$

STEP 2) $a = 0, b = h;$ STEP 3) $V = \int_a^b A(x) dx = \int_0^h s^2 dx = s^2 h$

(b) From Cavalieri's Principle we conclude that the volume of the column is the same as the volume of the prism described above, regardless of the number of turns $\Rightarrow V = s^2 h$

12. 1) The solid and the cone have the same altitude of 12.

2) The cross sections of the solid are disks of diameter $x - \left(\frac{x}{2}\right) = \frac{x}{2}$. If we place the vertex of the cone at the origin of the coordinate system and make its axis of symmetry coincide with the x -axis then the cone's cross sections will be circular disks of diameter $\frac{x}{4} - \left(-\frac{x}{4}\right) = \frac{x}{2}$ (see accompanying figure).

3) The solid and the cone have equal altitudes and identical parallel cross sections. From Cavalieri's Principle we conclude that the solid and the cone have the same volume.

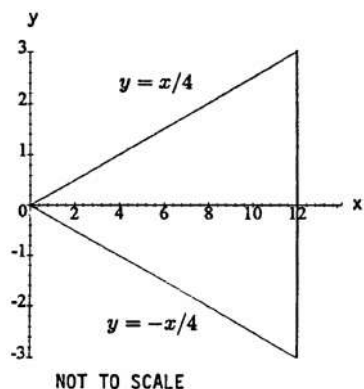

13. $R(x) = y = 1 - \frac{x}{2} \Rightarrow V = \int_0^2 \pi[R(x)]^2 dx = \pi \int_0^2 \left(1 - \frac{x}{2}\right)^2 dx = \pi \int_0^2 \left(1 - x + \frac{x^2}{4}\right) dx = \pi \left[x - \frac{x^2}{2} + \frac{x^3}{12} \right]_0^2$
 $= \pi \left(2 - \frac{4}{2} + \frac{8}{12} \right) = \frac{2\pi}{3}$

14. $R(y) = x = \frac{3y}{2} \Rightarrow V = \int_0^2 \pi[R(y)]^2 dy = \pi \int_0^2 \left(\frac{3y}{2}\right)^2 dy = \pi \int_0^2 \frac{9}{4} y^2 dy = \pi \left[\frac{3}{4} y^3 \right]_0^2 = \pi \cdot \frac{3}{4} \cdot 8 = 6\pi$

15. $R(x) = \tan\left(\frac{\pi}{4}y\right); u = \frac{\pi}{4}y \Rightarrow du = \frac{\pi}{4}dy \Rightarrow 4du = \pi dy; y = 0 \Rightarrow u = 0, y = 1 \Rightarrow u = \frac{\pi}{4};$

$V = \int_0^1 \pi[R(y)]^2 dy = \pi \int_0^1 [\tan\left(\frac{\pi}{4}y\right)]^2 dy = 4 \int_0^{\pi/4} \tan^2 u du = 4 \int_0^{\pi/4} (-1 + \sec^2 u) du = 4[-u + \tan u]_0^{\pi/4}$

$$= 4 \left(-\frac{\pi}{4} + 1 - 0 \right) = 4 - \pi$$

16. $R(x) = \sin x \cos x$; $R(x) = 0 \Rightarrow a = 0$ and $b = \frac{\pi}{2}$ are the limits of integration; $V = \int_0^{\pi/2} \pi[R(x)]^2 dx$
 $= \pi \int_0^{\pi/2} (\sin x \cos x)^2 dx = \pi \int_0^{\pi/2} \frac{(\sin 2x)^2}{4} dx$; $[u = 2x \Rightarrow du = 2 dx \Rightarrow \frac{du}{8} = \frac{dx}{4}$; $x = 0 \Rightarrow u = 0$,
 $x = \frac{\pi}{2} \Rightarrow u = \pi] \rightarrow V = \pi \int_0^{\pi} \frac{1}{8} \sin^2 u du = \frac{\pi}{8} \left[\frac{u}{2} - \frac{1}{4} \sin 2u \right]_0^{\pi} = \frac{\pi}{8} \left[\left(\frac{\pi}{2} - 0 \right) - 0 \right] = \frac{\pi^2}{16}$

17. $R(x) = x^2 \Rightarrow V = \int_0^2 \pi[R(x)]^2 dx = \pi \int_0^2 (x^2)^2 dx$
 $= \pi \int_0^2 x^4 dx = \pi \left[\frac{x^5}{5} \right]_0^2 = \frac{32\pi}{5}$

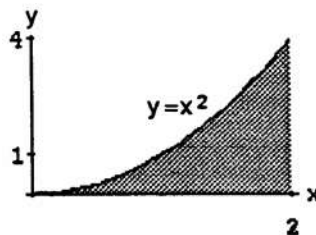

18. $R(x) = x^3 \Rightarrow V = \int_0^2 \pi[R(x)]^2 dx = \pi \int_0^2 (x^3)^2 dx$
 $= \pi \int_0^2 x^6 dx = \pi \left[\frac{x^7}{7} \right]_0^2 = \frac{128\pi}{7}$

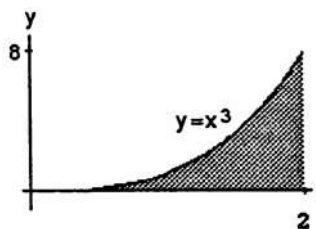

19. $R(x) = \sqrt{9 - x^2} \Rightarrow V = \int_{-3}^3 \pi[R(x)]^2 dx = \pi \int_{-3}^3 (9 - x^2) dx$
 $= \pi \left[9x - \frac{x^3}{3} \right]_{-3}^3 = 2\pi \left[9(3) - \frac{27}{3} \right] = 2 \cdot \pi \cdot 18 = 36\pi$

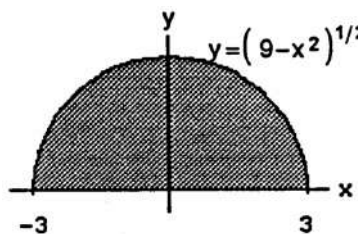

20. $R(x) = x - x^2 \Rightarrow V = \int_0^1 \pi[R(x)]^2 dx = \pi \int_0^1 (x - x^2)^2 dx$
 $= \pi \int_0^1 (x^2 - 2x^3 + x^4) dx = \pi \left[\frac{x^3}{3} - \frac{2x^4}{4} + \frac{x^5}{5} \right]_0^1$
 $= \pi \left(\frac{1}{3} - \frac{1}{2} + \frac{1}{5} \right) = \frac{\pi}{30} (10 - 15 + 6) = \frac{\pi}{30}$

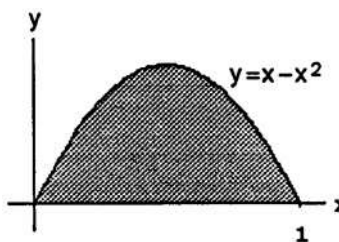

21. $R(x) = \sqrt{\cos x} \Rightarrow V = \int_0^{\pi/2} \pi[R(x)]^2 dx = \pi \int_0^{\pi/2} \cos x dx$
 $= \pi [\sin x]_0^{\pi/2} = \pi(1 - 0) = \pi$

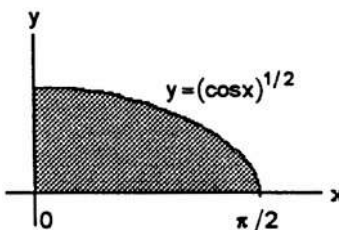

$$22. R(x) = \sec x \Rightarrow V = \int_{-\pi/4}^{\pi/4} \pi[R(x)]^2 dx = \pi \int_{-\pi/4}^{\pi/4} \sec^2 x dx$$

$$= \pi [\tan x]_{-\pi/4}^{\pi/4} = \pi[1 - (-1)] = 2\pi$$

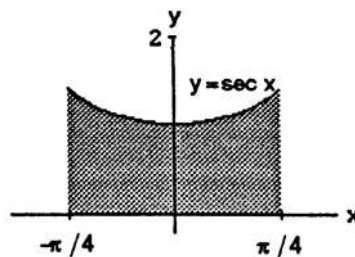

$$23. R(x) = \sqrt{2} - \sec x \tan x \Rightarrow V = \int_0^{\pi/4} \pi[R(x)]^2 dx$$

$$= \pi \int_0^{\pi/4} (\sqrt{2} - \sec x \tan x)^2 dx$$

$$= \pi \int_0^{\pi/4} (2 - 2\sqrt{2} \sec x \tan x + \sec^2 x \tan^2 x) dx$$

$$= \pi \left(\int_0^{\pi/4} 2 dx - 2\sqrt{2} \int_0^{\pi/4} \sec x \tan x dx + \int_0^{\pi/4} (\tan x)^2 \sec^2 x dx \right)$$

$$= \pi \left([2x]_0^{\pi/4} - 2\sqrt{2} [\sec x]_0^{\pi/4} + \left[\frac{\tan^3 x}{3} \right]_0^{\pi/4} \right)$$

$$= \pi \left[\left(\frac{\pi}{2} - 0 \right) - 2\sqrt{2} (\sqrt{2} - 1) + \frac{1}{3} (1^3 - 0) \right] = \pi \left(\frac{\pi}{2} + 2\sqrt{2} - \frac{11}{3} \right)$$

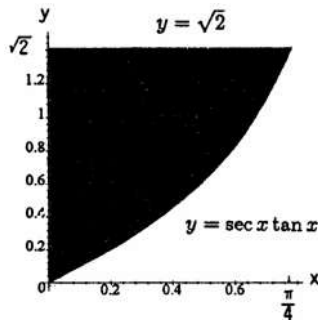

$$24. R(x) = 2 - 2 \sin x = 2(1 - \sin x) \Rightarrow V = \int_0^{\pi/2} \pi[R(x)]^2 dx$$

$$= \pi \int_0^{\pi/2} 4(1 - \sin x)^2 dx = 4\pi \int_0^{\pi/2} (1 + \sin^2 x - 2 \sin x) dx$$

$$= 4\pi \int_0^{\pi/2} \left[1 + \frac{1}{2}(1 - \cos 2x) - 2 \sin x \right] dx$$

$$= 4\pi \int_0^{\pi/2} \left(\frac{3}{2} - \frac{\cos 2x}{2} - 2 \sin x \right) dx$$

$$= 4\pi \left[\frac{3}{2}x - \frac{\sin 2x}{4} + 2 \cos x \right]_0^{\pi/2}$$

$$= 4\pi \left[\left(\frac{3\pi}{4} - 0 + 0 \right) - (0 - 0 + 2) \right] = \pi(3\pi - 8)$$

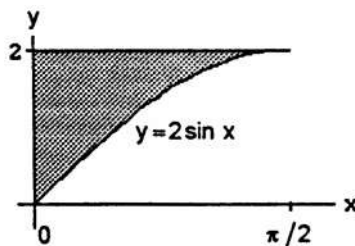

$$25. R(y) = \sqrt{5} \cdot y^2 \Rightarrow V = \int_{-1}^1 \pi[R(y)]^2 dy = \pi \int_{-1}^1 5y^4 dy$$

$$= \pi [y^5]_{-1}^1 = \pi[1 - (-1)] = 2\pi$$

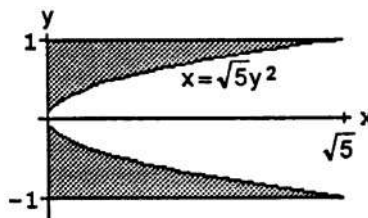

$$26. R(y) = y^{3/2} \Rightarrow V = \int_0^2 \pi[R(y)]^2 dy = \pi \int_0^2 y^3 dy$$

$$= \pi \left[\frac{y^4}{4} \right]_0^2 = 4\pi$$

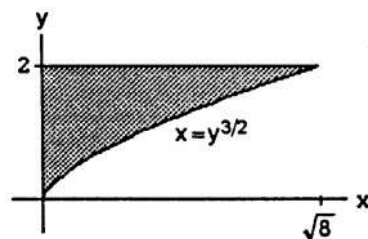

$$27. R(y) = \sqrt{2 \sin 2y} \Rightarrow V = \int_0^{\pi/2} \pi[R(y)]^2 dy$$

$$= \pi \int_0^{\pi/2} 2 \sin 2y dy = \pi [-\cos 2y]_0^{\pi/2}$$

$$= \pi[1 - (-1)] = 2\pi$$

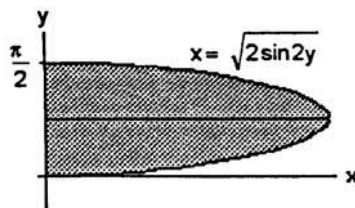

$$\begin{aligned}
 28. \quad R(y) &= \sqrt{\cos \frac{\pi y}{4}} \Rightarrow V = \int_{-2}^0 \pi [R(y)]^2 dy \\
 &= \pi \int_{-2}^0 \cos \left(\frac{\pi y}{4} \right) dy = 4 \left[\sin \frac{\pi y}{4} \right]_{-2}^0 = 4[0 - (-1)] = 4
 \end{aligned}$$

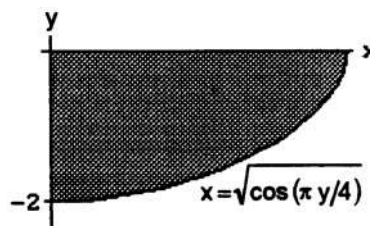

$$\begin{aligned}
 29. \quad R(y) &= \frac{2}{y+1} \Rightarrow V = \int_0^3 \pi [R(y)]^2 dy = 4\pi \int_0^3 \frac{1}{(y+1)^2} dy \\
 &= 4\pi \left[\frac{-1}{y+1} \right]_0^3 = 4\pi \left[-\frac{1}{4} - (-1) \right] = 3\pi
 \end{aligned}$$

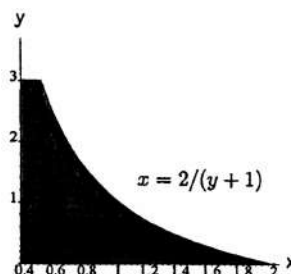

$$\begin{aligned}
 30. \quad R(y) &= \frac{\sqrt{2y}}{y^2+1} \Rightarrow V = \int_0^1 \pi [R(y)]^2 dy = \pi \int_0^1 2y (y^2+1)^{-2} dy; \\
 [u &= y^2+1 \Rightarrow du = 2y dy; y=0 \Rightarrow u=1, y=1 \Rightarrow u=2] \\
 \rightarrow V &= \pi \int_1^2 u^{-2} du = \pi \left[-\frac{1}{u} \right]_1^2 = \pi \left[-\frac{1}{2} - (-1) \right] = \frac{\pi}{2}
 \end{aligned}$$

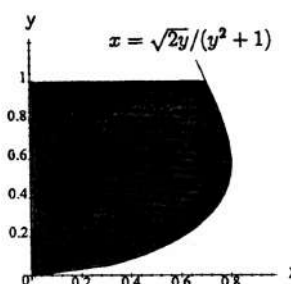

$$\begin{aligned}
 31. \quad \text{For the sketch given, } a &= -\frac{\pi}{2}, b = \frac{\pi}{2}; R(x) = 1, r(x) = \sqrt{\cos x}; V = \int_a^b \pi ([R(x)]^2 - [r(x)]^2) dx \\
 &= \int_{-\pi/2}^{\pi/2} \pi (1 - \cos x) dx = 2\pi \int_0^{\pi/2} (1 - \cos x) dx = 2\pi [x - \sin x]_0^{\pi/2} = 2\pi \left(\frac{\pi}{2} - 1 \right) = \pi^2 - 2\pi
 \end{aligned}$$

$$\begin{aligned}
 32. \quad \text{For the sketch given, } c &= 0, d = \frac{\pi}{4}; R(y) = 1, r(y) = \tan y; V = \int_c^d \pi ([R(y)]^2 - [r(y)]^2) dy \\
 &= \pi \int_0^{\pi/4} (1 - \tan^2 y) dy = \pi \int_0^{\pi/4} (2 - \sec^2 y) dy = \pi [2y - \tan y]_0^{\pi/4} = \pi \left(\frac{\pi}{2} - 1 \right) = \frac{\pi^2}{2} - \pi
 \end{aligned}$$

$$\begin{aligned}
 33. \quad r(x) &= x \text{ and } R(x) = 1 \Rightarrow V = \int_0^1 \pi ([R(x)]^2 - [r(x)]^2) dx \\
 &= \int_0^1 \pi (1 - x^2) dx = \pi \left[x - \frac{x^3}{3} \right]_0^1 = \pi \left[\left(1 - \frac{1}{3} \right) - 0 \right] = \frac{2\pi}{3}
 \end{aligned}$$

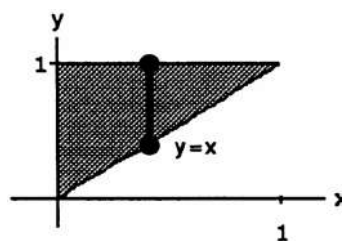

$$\begin{aligned}
 34. \quad r(x) &= 2\sqrt{x} \text{ and } R(x) = 2 \Rightarrow V = \int_0^1 \pi ([R(x)]^2 - [r(x)]^2) dx \\
 &= \pi \int_0^1 (4 - 4x) dx = 4\pi \left[x - \frac{x^2}{2} \right]_0^1 = 4\pi \left(1 - \frac{1}{2} \right) = 2\pi
 \end{aligned}$$

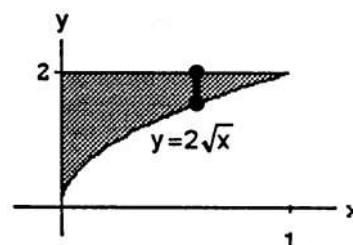

35. $r(x) = x^2 + 1$ and $R(x) = x + 3$

$$\begin{aligned} \Rightarrow V &= \int_{-1}^2 \pi ([R(x)]^2 - [r(x)]^2) dx \\ &= \pi \int_{-1}^2 [(x+3)^2 - (x^2+1)^2] dx \\ &= \pi \int_{-1}^2 [(x^2+6x+9) - (x^4+2x^2+1)] dx \\ &= \pi \int_{-1}^2 (-x^4 - x^2 + 6x + 8) dx \\ &= \pi \left[-\frac{x^5}{5} - \frac{x^3}{3} + \frac{6x^2}{2} + 8x \right]_{-1}^2 \\ &= \pi \left[\left(-\frac{32}{5} - \frac{8}{3} + \frac{24}{2} + 16 \right) - \left(\frac{1}{5} + \frac{1}{3} + \frac{6}{2} - 8 \right) \right] = \pi \left(-\frac{33}{5} - 3 + 28 - 3 + 8 \right) = \pi \left(\frac{5 \cdot 30 - 33}{5} \right) = \frac{117\pi}{5} \end{aligned}$$

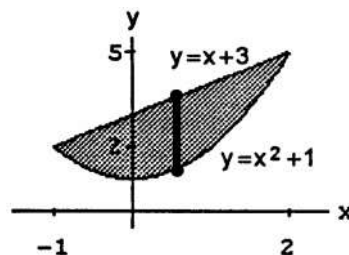

36. $r(x) = 2 - x$ and $R(x) = 4 - x^2$

$$\begin{aligned} \Rightarrow V &= \int_{-1}^2 \pi ([R(x)]^2 - [r(x)]^2) dx \\ &= \pi \int_{-1}^2 [(4-x^2)^2 - (2-x)^2] dx \\ &= \pi \int_{-1}^2 [(16-8x^2+x^4) - (4-4x+x^2)] dx \\ &= \pi \int_{-1}^2 (12+4x-9x^2+x^4) dx \\ &= \pi \left[12x + 2x^2 - 3x^3 + \frac{x^5}{5} \right]_{-1}^2 \\ &= \pi \left[\left(24 + 8 - 24 + \frac{32}{5} \right) - \left(-12 + 2 + 3 - \frac{1}{5} \right) \right] = \pi \left(15 + \frac{33}{5} \right) = \frac{108\pi}{5} \end{aligned}$$

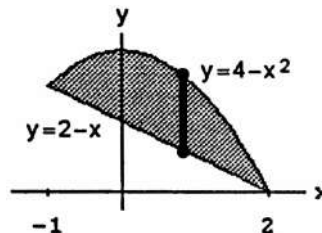

37. $r(x) = \sec x$ and $R(x) = \sqrt{2}$

$$\begin{aligned} \Rightarrow V &= \int_{-\pi/4}^{\pi/4} \pi ([R(x)]^2 - [r(x)]^2) dx \\ &= \pi \int_{-\pi/4}^{\pi/4} (2 - \sec^2 x) dx = \pi [2x - \tan x]_{-\pi/4}^{\pi/4} \\ &= \pi \left[\left(\frac{\pi}{2} - 1 \right) - \left(-\frac{\pi}{2} + 1 \right) \right] = \pi(\pi - 2) \end{aligned}$$

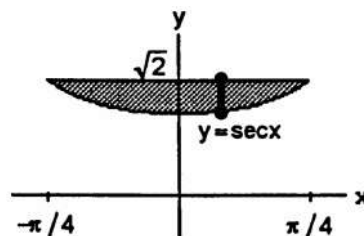

38. $R(x) = \sec x$ and $r(x) = \tan x$

$$\begin{aligned} \Rightarrow V &= \int_0^1 \pi ([R(x)]^2 - [r(x)]^2) dx \\ &= \pi \int_0^1 (\sec^2 x - \tan^2 x) dx = \pi \int_0^1 1 dx = \pi [x]_0^1 = \pi \end{aligned}$$

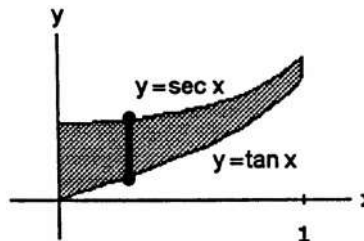

39. $r(y) = 1$ and $R(y) = 1 + y$

$$\begin{aligned} \Rightarrow V &= \int_0^1 \pi ([R(y)]^2 - [r(y)]^2) dy \\ &= \pi \int_0^1 [(1+y)^2 - 1] dy = \pi \int_0^1 (1+2y+y^2-1) dy \\ &= \pi \int_0^1 (2y+y^2) dy = \pi \left[y^2 + \frac{y^3}{3} \right]_0^1 = \pi \left(1 + \frac{1}{3} \right) = \frac{4\pi}{3} \end{aligned}$$

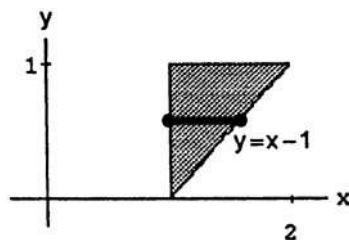

$$\begin{aligned}
 40. \quad R(y) &= 1 \text{ and } r(y) = 1 - y \Rightarrow V = \int_0^1 \pi ([R(y)]^2 - [r(y)]^2) dy \\
 &= \pi \int_0^1 [1 - (1 - y)^2] dy = \pi \int_0^1 [1 - (1 - 2y + y^2)] dy \\
 &= \pi \int_0^1 (2y - y^2) dy = \pi \left[y^2 - \frac{y^3}{3} \right]_0^1 = \pi \left(1 - \frac{1}{3} \right) = \frac{2\pi}{3}
 \end{aligned}$$

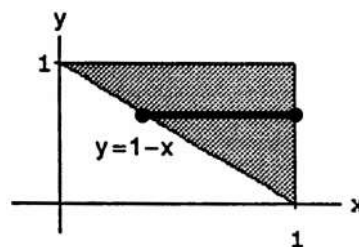

$$\begin{aligned}
 41. \quad R(y) &= 2 \text{ and } r(y) = \sqrt{y} \\
 \Rightarrow V &= \int_0^4 \pi ([R(y)]^2 - [r(y)]^2) dy \\
 &= \pi \int_0^4 (4 - y) dy = \pi \left[4y - \frac{y^2}{2} \right]_0^4 = \pi(16 - 8) = 8\pi
 \end{aligned}$$

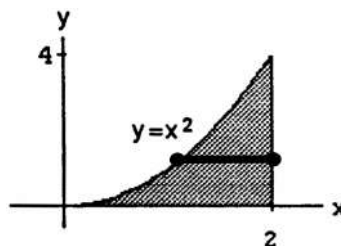

$$\begin{aligned}
 42. \quad R(y) &= \sqrt{3} \text{ and } r(y) = \sqrt{3 - y^2} \\
 \Rightarrow V &= \int_0^{\sqrt{3}} \pi ([R(y)]^2 - [r(y)]^2) dy \\
 &= \pi \int_0^{\sqrt{3}} [3 - (3 - y^2)] dy = \pi \int_0^{\sqrt{3}} y^2 dy \\
 &= \pi \left[\frac{y^3}{3} \right]_0^{\sqrt{3}} = \pi\sqrt{3}
 \end{aligned}$$

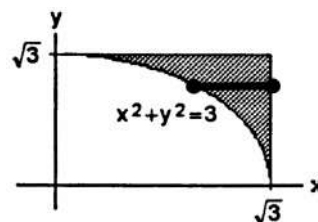

$$\begin{aligned}
 43. \quad R(y) &= 2 \text{ and } r(y) = 1 + \sqrt{y} \\
 \Rightarrow V &= \int_0^1 \pi ([R(y)]^2 - [r(y)]^2) dy \\
 &= \pi \int_0^1 [4 - (1 + \sqrt{y})^2] dy \\
 &= \pi \int_0^1 (4 - 1 - 2\sqrt{y} - y) dy \\
 &= \pi \int_0^1 (3 - 2\sqrt{y} - y) dy \\
 &= \pi \left[3y - \frac{4}{3}y^{3/2} - \frac{y^2}{2} \right]_0^1 \\
 &= \pi \left(3 - \frac{4}{3} - \frac{1}{2} \right) = \pi \left(\frac{18-8-3}{6} \right) = \frac{7\pi}{6}
 \end{aligned}$$

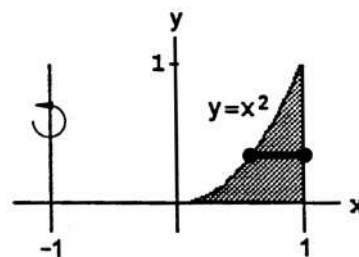

$$\begin{aligned}
 44. \quad R(y) &= 2 - y^{1/3} \text{ and } r(y) = 1 \\
 \Rightarrow V &= \int_0^1 \pi ([R(y)]^2 - [r(y)]^2) dy \\
 &= \pi \int_0^1 [(2 - y^{1/3})^2 - 1] dy \\
 &= \pi \int_0^1 (4 - 4y^{1/3} + y^{2/3} - 1) dy \\
 &= \pi \int_0^1 (3 - 4y^{1/3} + y^{2/3}) dy \\
 &= \pi \left[3y - 3y^{4/3} + \frac{3y^{5/3}}{5} \right]_0^1 = \pi \left(3 - 3 + \frac{3}{5} \right) = \frac{3\pi}{5}
 \end{aligned}$$

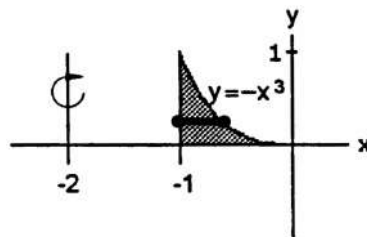

45. (a) $r(x) = \sqrt{x}$ and $R(x) = 2$

$$\begin{aligned} \Rightarrow V &= \int_0^4 \pi ([R(x)]^2 - [r(x)]^2) dx \\ &= \pi \int_0^4 (4 - x) dx = \pi \left[4x - \frac{x^2}{2} \right]_0^4 = \pi(16 - 8) = 8\pi \end{aligned}$$

(b) $r(y) = 0$ and $R(y) = y^2$

$$\begin{aligned} \Rightarrow V &= \int_0^2 \pi ([R(y)]^2 - [r(y)]^2) dy \\ &= \pi \int_0^2 y^4 dy = \pi \left[\frac{y^5}{5} \right]_0^2 = \frac{32\pi}{5} \end{aligned}$$

(c) $r(x) = 0$ and $R(x) = 2 - \sqrt{x} \Rightarrow V = \int_0^4 \pi ([R(x)]^2 - [r(x)]^2) dx = \pi \int_0^4 (2 - \sqrt{x})^2 dx$

$$= \pi \int_0^4 (4 - 4\sqrt{x} + x) dx = \pi \left[4x - \frac{8x^{3/2}}{3} + \frac{x^2}{2} \right]_0^4 = \pi \left(16 - \frac{64}{3} + \frac{16}{2} \right) = \frac{8\pi}{3}$$

(d) $r(y) = 4 - y^2$ and $R(y) = 4 \Rightarrow V = \int_0^2 \pi ([R(y)]^2 - [r(y)]^2) dy = \pi \int_0^2 [16 - (4 - y^2)^2] dy$

$$= \pi \int_0^2 (16 - 16 + 8y^2 - y^4) dy = \pi \int_0^2 (8y^2 - y^4) dy = \pi \left[\frac{8}{3}y^3 - \frac{y^5}{5} \right]_0^2 = \pi \left(\frac{64}{3} - \frac{32}{5} \right) = \frac{224\pi}{15}$$

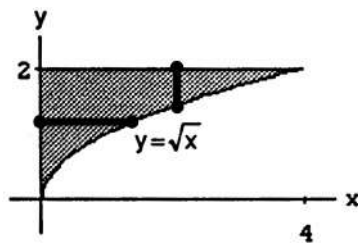

46. (a) $r(y) = 0$ and $R(y) = 1 - \frac{y}{2}$

$$\begin{aligned} \Rightarrow V &= \int_0^2 \pi ([R(y)]^2 - [r(y)]^2) dy \\ &= \pi \int_0^2 \left(1 - \frac{y}{2} \right)^2 dy = \pi \int_0^2 \left(1 - y + \frac{y^2}{4} \right) dy \\ &= \pi \left[y - \frac{y^2}{2} + \frac{y^3}{12} \right]_0^2 = \pi \left(2 - \frac{4}{2} + \frac{8}{12} \right) = \frac{2\pi}{3} \end{aligned}$$

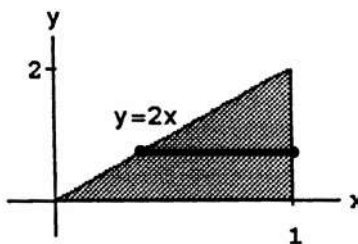

(b) $r(y) = 1$ and $R(y) = 2 - \frac{y}{2}$

$$\begin{aligned} \Rightarrow V &= \int_0^2 \pi ([R(y)]^2 - [r(y)]^2) dy = \pi \int_0^2 \left[\left(2 - \frac{y}{2} \right)^2 - 1 \right] dy = \pi \int_0^2 \left(4 - 2y + \frac{y^2}{4} - 1 \right) dy \\ &= \pi \int_0^2 \left(3 - 2y + \frac{y^2}{4} \right) dy = \pi \left[3y - y^2 + \frac{y^3}{12} \right]_0^2 = \pi \left(6 - 4 + \frac{8}{12} \right) = \pi \left(2 + \frac{2}{3} \right) = \frac{8\pi}{3} \end{aligned}$$

47. (a) $r(x) = 0$ and $R(x) = 1 - x^2$

$$\begin{aligned} \Rightarrow V &= \int_{-1}^1 \pi ([R(x)]^2 - [r(x)]^2) dx \\ &= \pi \int_{-1}^1 (1 - x^2)^2 dx = \pi \int_{-1}^1 (1 - 2x^2 + x^4) dx \\ &= \pi \left[x - \frac{2x^3}{3} + \frac{x^5}{5} \right]_{-1}^1 = 2\pi \left(1 - \frac{2}{3} + \frac{1}{5} \right) \\ &= 2\pi \left(\frac{15-10+3}{15} \right) = \frac{16\pi}{15} \end{aligned}$$

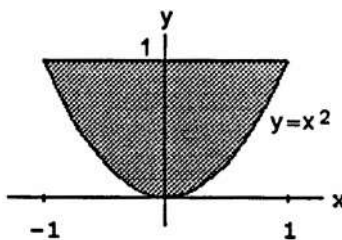

(b) $r(x) = 1$ and $R(x) = 2 - x^2 \Rightarrow V = \int_{-1}^1 \pi ([R(x)]^2 - [r(x)]^2) dx = \pi \int_{-1}^1 [(2 - x^2)^2 - 1] dx$

$$\begin{aligned} &= \pi \int_{-1}^1 (4 - 4x^2 + x^4 - 1) dx = \pi \int_{-1}^1 (3 - 4x^2 + x^4) dx = \pi \left[3x - \frac{4}{3}x^3 + \frac{x^5}{5} \right]_{-1}^1 = 2\pi \left(3 - \frac{4}{3} + \frac{1}{5} \right) \\ &= \frac{2\pi}{15} (45 - 20 + 3) = \frac{56\pi}{15} \end{aligned}$$

(c) $r(x) = 1 + x^2$ and $R(x) = 2 \Rightarrow V = \int_{-1}^1 \pi ([R(x)]^2 - [r(x)]^2) dx = \pi \int_{-1}^1 [4 - (1 + x^2)^2] dx$

$$\begin{aligned} &= \pi \int_{-1}^1 (4 - 1 - 2x^2 - x^4) dx = \pi \int_{-1}^1 (3 - 2x^2 - x^4) dx = \pi \left[3x - \frac{2}{3}x^3 - \frac{x^5}{5} \right]_{-1}^1 = 2\pi \left(3 - \frac{2}{3} - \frac{1}{5} \right) \\ &= \frac{2\pi}{15} (45 - 10 - 3) = \frac{64\pi}{15} \end{aligned}$$

48. (a) $r(x) = 0$ and $R(x) = -\frac{h}{b}x + h$

$$\begin{aligned} \Rightarrow V &= \int_0^b \pi ([R(x)]^2 - [r(x)]^2) dx \\ &= \pi \int_0^b \left(-\frac{h}{b}x + h\right)^2 dx \\ &= \pi \int_0^b \left(\frac{h^2}{b^2}x^2 - \frac{2h^2}{b}x + h^2\right) dx \\ &= \pi h^2 \left[\frac{x^3}{3b^2} - \frac{x^2}{b} + x\right]_0^b = \pi h^2 \left(\frac{b}{3} - b + b\right) = \frac{\pi h^2 b}{3} \end{aligned}$$

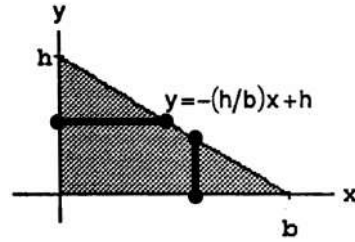

(b) $r(y) = 0$ and $R(y) = b\left(1 - \frac{y}{h}\right) \Rightarrow V = \int_0^h \pi ([R(y)]^2 - [r(y)]^2) dy = \pi b^2 \int_0^h \left(1 - \frac{y}{h}\right)^2 dy$
 $= \pi b^2 \int_0^h \left(1 - \frac{2y}{h} + \frac{y^2}{h^2}\right) dy = \pi b^2 \left[y - \frac{y^2}{h} + \frac{y^3}{3h^2}\right]_0^h = \pi b^2 \left(h - h + \frac{h}{3}\right) = \frac{\pi b^2 h}{3}$

49. $R(y) = b + \sqrt{a^2 - y^2}$ and $r(y) = b - \sqrt{a^2 - y^2}$

$$\begin{aligned} \Rightarrow V &= \int_{-a}^a \pi ([R(y)]^2 - [r(y)]^2) dy \\ &= \pi \int_{-a}^a \left[(b + \sqrt{a^2 - y^2})^2 - (b - \sqrt{a^2 - y^2})^2\right] dy \\ &= \pi \int_{-a}^a 4b\sqrt{a^2 - y^2} dy = 4b\pi \int_{-a}^a \sqrt{a^2 - y^2} dy \\ &= 4b\pi \cdot \text{area of semicircle of radius } a = 4b\pi \cdot \frac{\pi a^2}{2} = 2a^2 b \pi^2 \end{aligned}$$

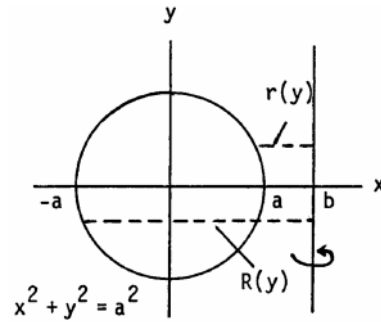

50. (a) A cross section has radius $r = \sqrt{2y}$ and area $\pi r^2 = 2\pi y$. The volume is $\int_0^5 2\pi y dy = \pi [y^2]_0^5 = 25\pi$.

(b) $V(h) = \int A(h)dh$, so $\frac{dV}{dh} = A(h)$. Therefore $\frac{dV}{dt} = \frac{dV}{dh} \cdot \frac{dh}{dt} = A(h) \cdot \frac{dh}{dt}$, so $\frac{dh}{dt} = \frac{1}{A(h)} \cdot \frac{dV}{dt}$.

For $h = 4$, the area is $2\pi(4) = 8\pi$, so $\frac{dh}{dt} = \frac{1}{8\pi} \cdot 3 \frac{\text{units}^3}{\text{sec}} = \frac{3}{8\pi} \cdot \frac{\text{units}^3}{\text{sec}}$.

51. (a) $R(y) = \sqrt{a^2 - y^2} \Rightarrow V = \pi \int_{-a}^{h-a} (a^2 - y^2) dy = \pi \left[a^2 y - \frac{y^3}{3} \right]_{-a}^{h-a} = \pi \left[a^2 h - a^3 - \frac{(h-a)^3}{3} - \left(-a^3 + \frac{a^3}{3}\right) \right]$
 $= \pi \left[a^2 h - \frac{1}{3}(h^3 - 3h^2 a + 3ha^2 - a^3) - \frac{a^3}{3} \right] = \pi \left(a^2 h - \frac{h^3}{3} + h^2 a - ha^2 \right) = \frac{\pi h^2(3a-h)}{3}$

(b) Given $\frac{dV}{dt} = 0.2 \text{ m}^3/\text{sec}$ and $a = 5 \text{ m}$, find $\frac{dh}{dt} \Big|_{h=4}$. From part (a), $V(h) = \frac{\pi h^2(15-h)}{3} = 5\pi h^2 - \frac{\pi h^3}{3}$
 $\Rightarrow \frac{dV}{dh} = 10\pi h - \pi h^2 \Rightarrow \frac{dV}{dt} = \frac{dV}{dh} \cdot \frac{dh}{dt} = \pi h(10-h) \frac{dh}{dt} \Rightarrow \frac{dh}{dt} \Big|_{h=4} = \frac{0.2}{4\pi(10-4)} = \frac{1}{(20\pi)(6)} = \frac{1}{120\pi} \text{ m/sec.}$

52. Suppose the solid is produced by revolving $y = 2 - x$ about the y -axis. Cast a shadow of the solid on a plane parallel to the xy -plane.

Use an approximation such as the Trapezoid Rule, to

estimate $\int_a^b \pi [R(y)]^2 dy \approx \sum_{k=1}^n \pi \left(\frac{d_k}{2}\right)^2 \Delta y$.

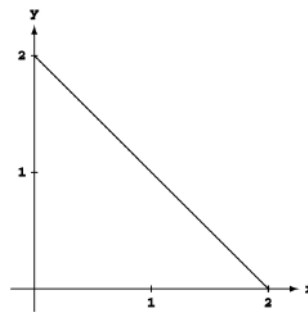

53. The cross section of a solid right circular cylinder with a cone removed is a disk with radius R from which a disk of radius h has been removed. Thus its area is $A_1 = \pi R^2 - \pi h^2 = \pi (R^2 - h^2)$. The cross section of the hemisphere is a disk of radius $\sqrt{R^2 - h^2}$. Therefore its area is $A_2 = \pi (\sqrt{R^2 - h^2})^2 = \pi (R^2 - h^2)$. We can see that $A_1 = A_2$. The altitudes of both solids are R . Applying Cavalieri's Principle we find

Volume of Hemisphere = (Volume of Cylinder) - (Volume of Cone) = $(\pi R^2)R - \frac{1}{3}\pi(R^2)R = \frac{2}{3}\pi R^3$.

54. $R(x) = \frac{rx}{h} \Rightarrow V = \int_0^h \pi[R(x)]^2 dx = \pi \int_0^h \frac{r^2 x^2}{h^2} dx = \frac{\pi r^2}{h^2} \left[\frac{x^3}{3} \right]_0^h = \left(\frac{\pi r^2}{h^2} \right) \left(\frac{h^3}{3} \right) = \frac{1}{3} \pi r^2 h$, the volume of a cone of radius r and height h .

55. $R(y) = \sqrt{256 - y^2} \Rightarrow V = \int_{-16}^{-7} \pi[R(y)]^2 dy = \pi \int_{-16}^{-7} (256 - y^2) dy = \pi \left[256y - \frac{y^3}{3} \right]_{-16}^{-7}$
 $= \pi \left[(256)(-7) + \frac{7^3}{3} - \left((256)(-16) + \frac{16^3}{3} \right) \right] = \pi \left(\frac{7^3}{3} + 256(16 - 7) - \frac{16^3}{3} \right) = 1053\pi \text{ cm}^3 \approx 3308 \text{ cm}^3$

56. $R(x) = \frac{x}{12} \sqrt{36 - x^2} \Rightarrow V = \int_0^6 \pi[R(x)]^2 dx = \pi \int_0^6 \frac{x^2}{144} (36 - x^2) dx = \frac{\pi}{144} \int_0^6 (36x^2 - x^4) dx$
 $= \frac{\pi}{144} \left[12x^3 - \frac{x^5}{5} \right]_0^6 = \frac{\pi}{144} \left(12 \cdot 6^3 - \frac{6^5}{5} \right) = \frac{\pi \cdot 6^3}{144} \left(12 - \frac{36}{5} \right) = \left(\frac{196\pi}{144} \right) \left(\frac{60 - 36}{5} \right) = \frac{36\pi}{5} \text{ cm}^3$. The plumb bob will weigh about $W = (8.5) \left(\frac{36\pi}{5} \right) \approx 192 \text{ gm}$, to the nearest gram.

57. (a) $R(x) = |c - \sin x|$, so $V = \pi \int_0^\pi [R(x)]^2 dx = \pi \int_0^\pi (c - \sin x)^2 dx = \pi \int_0^\pi (c^2 - 2c \sin x + \sin^2 x) dx$
 $= \pi \int_0^\pi \left(c^2 - 2c \sin x + \frac{1 - \cos 2x}{2} \right) dx = \pi \int_0^\pi \left(c^2 + \frac{1}{2} - 2c \sin x - \frac{\cos 2x}{2} \right) dx$
 $= \pi \left[\left(c^2 + \frac{1}{2} \right) x + 2c \cos x - \frac{\sin 2x}{4} \right]_0^\pi = \pi \left[\left(c^2 \pi + \frac{\pi}{2} - 2c - 0 \right) - \left(0 + 2c - 0 \right) \right] = \pi \left(c^2 \pi + \frac{\pi}{2} - 4c \right)$. Let $V(c) = \pi \left(c^2 \pi + \frac{\pi}{2} - 4c \right)$. We find the extreme values of $V(c)$: $\frac{dV}{dc} = \pi(2c\pi - 4) = 0 \Rightarrow c = \frac{2}{\pi}$ is a critical point, and $V\left(\frac{2}{\pi}\right) = \pi \left(\frac{4}{\pi} + \frac{\pi}{2} - \frac{8}{\pi} \right) = \pi \left(\frac{\pi}{2} - \frac{4}{\pi} \right) = \frac{\pi^2}{2} - 4$; Evaluate V at the endpoints: $V(0) = \frac{\pi^2}{2}$ and $V(1) = \pi \left(\frac{3}{2} \pi - 4 \right) = \frac{\pi^2}{2} - (4 - \pi)\pi$. Now we see that the function's absolute minimum value is $\frac{\pi^2}{2} - 4$, taken on at the critical point $c = \frac{2}{\pi}$. (See also the accompanying graph.)

(b) From the discussion in part (a) we conclude that the function's absolute maximum value is $\frac{\pi^2}{2}$, taken on at the endpoint $c = 0$.

(c) The graph of the solid's volume as a function of c for $0 \leq c \leq 1$ is given at the right. As c moves away from $[0, 1]$ the volume of the solid increases without bound. If we approximate the solid as a set of solid disks, we can see that the radius of a typical disk increases without bounds as c moves away from $[0, 1]$.

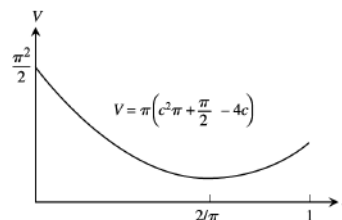

58. (a) $R(x) = 1 - \frac{x^2}{16} \Rightarrow V = \int_{-4}^4 \pi[R(x)]^2 dx$
 $= \pi \int_{-4}^4 \left(1 - \frac{x^2}{16} \right)^2 dx = \pi \int_{-4}^4 \left(1 - \frac{x^2}{8} + \frac{x^4}{16^2} \right) dx$
 $= \pi \left[x - \frac{x^3}{24} + \frac{x^5}{5 \cdot 16^2} \right]_{-4}^4 = 2\pi \left(4 - \frac{4^3}{24} + \frac{4^5}{5 \cdot 16^2} \right)$
 $= 2\pi \left(4 - \frac{8}{3} + \frac{4}{5} \right) = \frac{2\pi}{15} (60 - 40 + 12) = \frac{64\pi}{15} \text{ ft}^3$

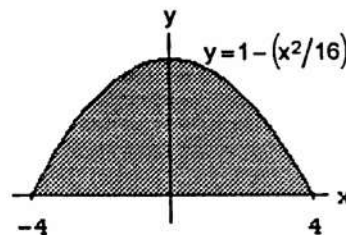

(b) The helicopter will be able to fly $\left(\frac{64\pi}{15} \right) (7.481)(2) \approx 201$ additional miles.

6.2 VOLUME BY CYLINDRICAL SHELLS

1. For the sketch given, $a = 0$, $b = 2$;

$$V = \int_a^b 2\pi \left(\begin{array}{c} \text{shell} \\ \text{radius} \end{array} \right) \left(\begin{array}{c} \text{shell} \\ \text{height} \end{array} \right) dx = \int_0^2 2\pi x \left(1 + \frac{x^2}{4} \right) dx = 2\pi \int_0^2 \left(x + \frac{x^3}{4} \right) dx = 2\pi \left[\frac{x^2}{2} + \frac{x^4}{16} \right]_0^2 = 2\pi \left(\frac{4}{2} + \frac{16}{16} \right) = 2\pi \cdot 3 = 6\pi$$

2. For the sketch given, $a = 0$, $b = 2$;

$$V = \int_a^b 2\pi \left(\begin{array}{c} \text{shell} \\ \text{radius} \end{array} \right) \left(\begin{array}{c} \text{shell} \\ \text{height} \end{array} \right) dx = \int_0^2 2\pi x \left(2 - \frac{x^2}{4} \right) dx = 2\pi \int_0^2 \left(2x - \frac{x^3}{4} \right) dx = 2\pi \left[x^2 - \frac{x^4}{16} \right]_0^2 = 2\pi(4 - 1) = 6\pi$$

3. For the sketch given, $c = 0$, $d = \sqrt{2}$;

$$V = \int_c^d 2\pi \left(\begin{array}{c} \text{shell} \\ \text{radius} \end{array} \right) \left(\begin{array}{c} \text{shell} \\ \text{height} \end{array} \right) dy = \int_0^{\sqrt{2}} 2\pi y \cdot (y^2) dy = 2\pi \int_0^{\sqrt{2}} y^3 dy = 2\pi \left[\frac{y^4}{4} \right]_0^{\sqrt{2}} = 2\pi$$

4. For the sketch given, $c = 0$, $d = \sqrt{3}$;

$$V = \int_c^d 2\pi \left(\begin{array}{c} \text{shell} \\ \text{radius} \end{array} \right) \left(\begin{array}{c} \text{shell} \\ \text{height} \end{array} \right) dy = \int_0^{\sqrt{3}} 2\pi y \cdot [3 - (3 - y^2)] dy = 2\pi \int_0^{\sqrt{3}} y^3 dy = 2\pi \left[\frac{y^4}{4} \right]_0^{\sqrt{3}} = \frac{9\pi}{2}$$

5. For the sketch given, $a = 0$, $b = \sqrt{3}$;

$$V = \int_a^b 2\pi \left(\begin{array}{c} \text{shell} \\ \text{radius} \end{array} \right) \left(\begin{array}{c} \text{shell} \\ \text{height} \end{array} \right) dx = \int_0^{\sqrt{3}} 2\pi x \cdot (\sqrt{x^2 + 1}) dx;$$

$$[u = x^2 + 1 \Rightarrow du = 2x dx; x = 0 \Rightarrow u = 1, x = \sqrt{3} \Rightarrow u = 4]$$

$$\rightarrow V = \pi \int_1^4 u^{1/2} du = \pi \left[\frac{2}{3} u^{3/2} \right]_1^4 = \frac{2\pi}{3} (4^{3/2} - 1) = \left(\frac{2\pi}{3} \right) (8 - 1) = \frac{14\pi}{3}$$

6. For the sketch given, $a = 0$, $b = 3$;

$$V = \int_a^b 2\pi \left(\begin{array}{c} \text{shell} \\ \text{radius} \end{array} \right) \left(\begin{array}{c} \text{shell} \\ \text{height} \end{array} \right) dx = \int_0^3 2\pi x \left(\frac{9x}{\sqrt{x^3 + 9}} \right) dx;$$

$$[u = x^3 + 9 \Rightarrow du = 3x^2 dx \Rightarrow 3 du = 9x^2 dx; x = 0 \Rightarrow u = 9, x = 3 \Rightarrow u = 36]$$

$$\rightarrow V = 2\pi \int_9^{36} 3u^{-1/2} du = 6\pi [2u^{1/2}]_9^{36} = 12\pi (\sqrt{36} - \sqrt{9}) = 36\pi$$

7. $a = 0$, $b = 2$;

$$V = \int_a^b 2\pi \left(\begin{array}{c} \text{shell} \\ \text{radius} \end{array} \right) \left(\begin{array}{c} \text{shell} \\ \text{height} \end{array} \right) dx = \int_0^2 2\pi x \left[x - \left(-\frac{x}{2} \right) \right] dx$$

$$= \int_0^2 2\pi x^2 \cdot \frac{3}{2} dx = \pi \int_0^2 3x^2 dx = \pi [x^3]_0^2 = 8\pi$$

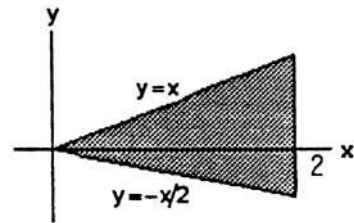

8. $a = 0$, $b = 1$;

$$V = \int_a^b 2\pi \left(\begin{array}{c} \text{shell} \\ \text{radius} \end{array} \right) \left(\begin{array}{c} \text{shell} \\ \text{height} \end{array} \right) dx = \int_0^1 2\pi x \left(2x - \frac{x}{2} \right) dx$$

$$= \pi \int_0^1 2 \left(\frac{3x^2}{2} \right) dx = \pi \int_0^1 3x^2 dx = \pi [x^3]_0^1 = \pi$$

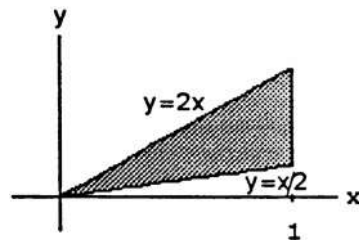

9. $a = 0$, $b = 1$;

$$V = \int_a^b 2\pi \left(\begin{array}{c} \text{shell} \\ \text{radius} \end{array} \right) \left(\begin{array}{c} \text{shell} \\ \text{height} \end{array} \right) dx = \int_0^1 2\pi x [(2-x) - x^2] dx$$

$$= 2\pi \int_0^1 (2x - x^2 - x^3) dx = 2\pi \left[x^2 - \frac{x^3}{3} - \frac{x^4}{4} \right]_0^1$$

$$= 2\pi \left(1 - \frac{1}{3} - \frac{1}{4} \right) = 2\pi \left(\frac{12-4-3}{12} \right) = \frac{10\pi}{12} = \frac{5\pi}{6}$$

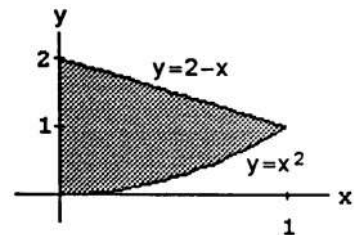

10. $a = 0, b = 1$;

$$\begin{aligned} V &= \int_a^b 2\pi \left(\begin{matrix} \text{shell} \\ \text{radius} \end{matrix} \right) \left(\begin{matrix} \text{shell} \\ \text{height} \end{matrix} \right) dx = \int_0^1 2\pi x [(2 - x^2) - x^2] dx \\ &= 2\pi \int_0^1 x(2 - 2x^2) dx = 4\pi \int_0^1 (x - x^3) dx \\ &= 4\pi \left[\frac{x^2}{2} - \frac{x^4}{4} \right]_0^1 = 4\pi \left(\frac{1}{2} - \frac{1}{4} \right) = \pi \end{aligned}$$

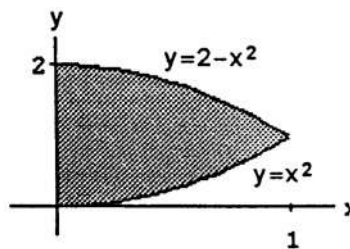

11. $a = 0, b = 1$;

$$\begin{aligned} V &= \int_a^b 2\pi \left(\begin{matrix} \text{shell} \\ \text{radius} \end{matrix} \right) \left(\begin{matrix} \text{shell} \\ \text{height} \end{matrix} \right) dx = \int_0^1 2\pi x [\sqrt{x} - (2x - 1)] dx \\ &= 2\pi \int_0^1 (x^{3/2} - 2x^2 + x) dx = 2\pi \left[\frac{2}{5} x^{5/2} - \frac{2}{3} x^3 + \frac{1}{2} x^2 \right]_0^1 \\ &= 2\pi \left(\frac{2}{5} - \frac{2}{3} + \frac{1}{2} \right) = 2\pi \left(\frac{12 - 20 + 15}{30} \right) = \frac{7\pi}{15} \end{aligned}$$

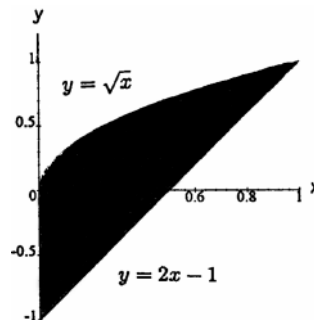

12. $a = 1, b = 4$;

$$\begin{aligned} V &= \int_a^b 2\pi \left(\begin{matrix} \text{shell} \\ \text{radius} \end{matrix} \right) \left(\begin{matrix} \text{shell} \\ \text{height} \end{matrix} \right) dx = \int_1^4 2\pi x \left(\frac{3}{2} x^{-1/2} \right) dx \\ &= 3\pi \int_1^4 x^{1/2} dx = 3\pi \left[\frac{2}{3} x^{3/2} \right]_1^4 = 2\pi (4^{3/2} - 1) \\ &= 2\pi(8 - 1) = 14\pi \end{aligned}$$

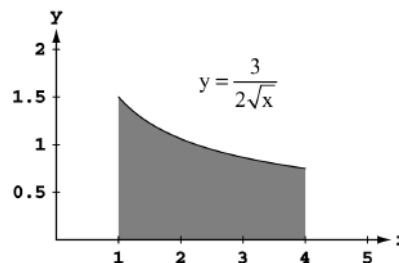

13. (a) $xf(x) = \begin{cases} x \cdot \frac{\sin x}{x}, & 0 < x \leq \pi \\ x, & x = 0 \end{cases} \Rightarrow xf(x) = \begin{cases} \sin x, & 0 < x \leq \pi \\ 0, & x = 0 \end{cases}$; since $\sin 0 = 0$ we have

$$xf(x) = \begin{cases} \sin x, & 0 < x \leq \pi \\ \sin x, & x = 0 \end{cases} \Rightarrow xf(x) = \sin x, 0 \leq x \leq \pi$$

(b) $V = \int_a^b 2\pi \left(\begin{matrix} \text{shell} \\ \text{radius} \end{matrix} \right) \left(\begin{matrix} \text{shell} \\ \text{height} \end{matrix} \right) dx = \int_0^\pi 2\pi x \cdot f(x) dx$ and $x \cdot f(x) = \sin x, 0 \leq x \leq \pi$ by part (a)
 $\Rightarrow V = 2\pi \int_0^\pi \sin x dx = 2\pi[-\cos x]_0^\pi = 2\pi(-\cos \pi + \cos 0) = 4\pi$

14. (a) $xg(x) = \begin{cases} x \cdot \frac{\tan^2 x}{x}, & 0 < x \leq \pi/4 \\ x \cdot 0, & x = 0 \end{cases} \Rightarrow xg(x) = \begin{cases} \tan^2 x, & 0 < x \leq \pi/4 \\ 0, & x = 0 \end{cases}$; since $\tan 0 = 0$ we have

$$xg(x) = \begin{cases} \tan^2 x, & 0 < x \leq \pi/4 \\ \tan^2 x, & x = 0 \end{cases} \Rightarrow xg(x) = \tan^2 x, 0 \leq x \leq \pi/4$$

(b) $V = \int_a^b 2\pi \left(\begin{matrix} \text{shell} \\ \text{radius} \end{matrix} \right) \left(\begin{matrix} \text{shell} \\ \text{height} \end{matrix} \right) dx = \int_0^{\pi/4} 2\pi x \cdot g(x) dx$ and $x \cdot g(x) = \tan^2 x, 0 \leq x \leq \pi/4$ by part (a)
 $\Rightarrow V = 2\pi \int_0^{\pi/4} \tan^2 x dx = 2\pi \int_0^{\pi/4} (\sec^2 x - 1) dx = 2\pi[\tan x - x]_0^{\pi/4} = 2\pi \left(1 - \frac{\pi}{4} \right) = \frac{4\pi - \pi^2}{2}$

15. $c = 0, d = 2$;

$$\begin{aligned} V &= \int_c^d 2\pi \left(\begin{array}{c} \text{shell} \\ \text{radius} \end{array} \right) \left(\begin{array}{c} \text{shell} \\ \text{height} \end{array} \right) dy = \int_0^2 2\pi y [\sqrt{y} - (-y)] dy \\ &= 2\pi \int_0^2 (y^{3/2} + y^2) dy = 2\pi \left[\frac{2y^{5/2}}{5} + \frac{y^3}{3} \right]_0^2 \\ &= 2\pi \left[\frac{2}{5} (\sqrt{2})^5 + \frac{2^3}{3} \right] = 2\pi \left(\frac{8\sqrt{2}}{5} + \frac{8}{3} \right) = 16\pi \left(\frac{\sqrt{2}}{5} + \frac{1}{3} \right) \\ &= \frac{16\pi}{15} (3\sqrt{2} + 5) \end{aligned}$$

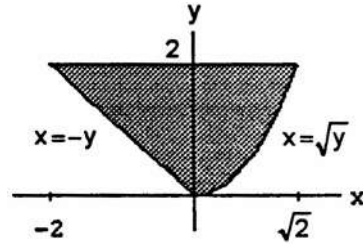
 16. $c = 0, d = 2$;

$$\begin{aligned} V &= \int_c^d 2\pi \left(\begin{array}{c} \text{shell} \\ \text{radius} \end{array} \right) \left(\begin{array}{c} \text{shell} \\ \text{height} \end{array} \right) dy = \int_0^2 2\pi y [y^2 - (-y)] dy \\ &= 2\pi \int_0^2 (y^3 + y^2) dy = 2\pi \left[\frac{y^4}{4} + \frac{y^3}{3} \right]_0^2 = 16\pi \left(\frac{2}{4} + \frac{1}{3} \right) \\ &= 16\pi \left(\frac{5}{6} \right) = \frac{40\pi}{3} \end{aligned}$$

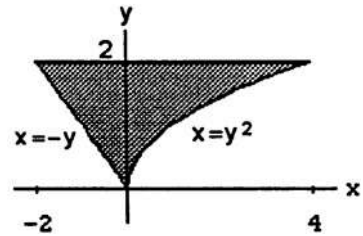
 17. $c = 0, d = 2$;

$$\begin{aligned} V &= \int_c^d 2\pi \left(\begin{array}{c} \text{shell} \\ \text{radius} \end{array} \right) \left(\begin{array}{c} \text{shell} \\ \text{height} \end{array} \right) dy = \int_0^2 2\pi y (2y - y^2) dy \\ &= 2\pi \int_0^2 (2y^2 - y^3) dy = 2\pi \left[\frac{2y^3}{3} - \frac{y^4}{4} \right]_0^2 = 2\pi \left(\frac{16}{3} - \frac{16}{4} \right) \\ &= 32\pi \left(\frac{1}{3} - \frac{1}{4} \right) = \frac{32\pi}{12} = \frac{8\pi}{3} \end{aligned}$$

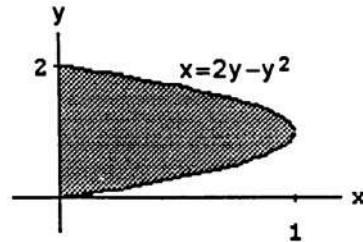
 18. $c = 0, d = 1$;

$$\begin{aligned} V &= \int_c^d 2\pi \left(\begin{array}{c} \text{shell} \\ \text{radius} \end{array} \right) \left(\begin{array}{c} \text{shell} \\ \text{height} \end{array} \right) dy = \int_0^1 2\pi y (2y - y^2 - y) dy \\ &= 2\pi \int_0^1 y (y - y^2) dy = 2\pi \int_0^1 (y^2 - y^3) dy \\ &= 2\pi \left[\frac{y^3}{3} - \frac{y^4}{4} \right]_0^1 = 2\pi \left(\frac{1}{3} - \frac{1}{4} \right) = \frac{\pi}{6} \end{aligned}$$

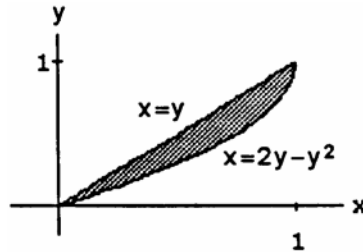
 19. $c = 0, d = 1$;

$$\begin{aligned} V &= \int_c^d 2\pi \left(\begin{array}{c} \text{shell} \\ \text{radius} \end{array} \right) \left(\begin{array}{c} \text{shell} \\ \text{height} \end{array} \right) dy = 2\pi \int_0^1 y [y - (-y)] dy \\ &= 2\pi \int_0^1 2y^2 dy = \frac{4\pi}{3} [y^3]_0^1 = \frac{4\pi}{3} \end{aligned}$$

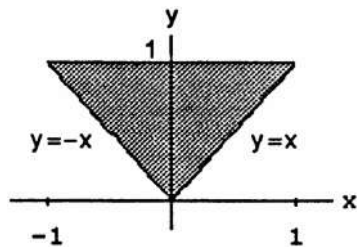

 20. $c = 0, d = 2$;

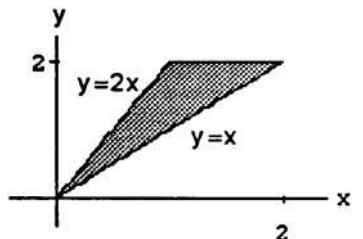
$$\begin{aligned} V &= \int_c^d 2\pi \left(\begin{array}{c} \text{shell} \\ \text{radius} \end{array} \right) \left(\begin{array}{c} \text{shell} \\ \text{height} \end{array} \right) dy = \int_0^2 2\pi y \left(y - \frac{y}{2} \right) dy \\ &= 2\pi \int_0^2 \frac{y^2}{2} dy = \frac{\pi}{3} [y^3]_0^2 = \frac{8\pi}{3} \end{aligned}$$

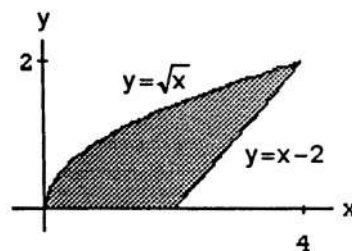

21. $c = 0, d = 2$;

$$\begin{aligned} V &= \int_c^d 2\pi \left(\frac{\text{shell}}{\text{radius}} \right) \left(\frac{\text{shell}}{\text{height}} \right) dy = \int_0^2 2\pi y [(2+y) - y^2] dy \\ &= 2\pi \int_0^2 (2y + y^2 - y^3) dy = 2\pi \left[y^2 + \frac{y^3}{3} - \frac{y^4}{4} \right]_0^2 \\ &= 2\pi \left(4 + \frac{8}{3} - \frac{16}{4} \right) = \frac{\pi}{6} (48 + 32 - 48) = \frac{16\pi}{3} \end{aligned}$$

22. $c = 0, d = 1$;

$$\begin{aligned} V &= \int_c^d 2\pi \left(\frac{\text{shell}}{\text{radius}} \right) \left(\frac{\text{shell}}{\text{height}} \right) dy = \int_0^1 2\pi y [(2-y) - y^2] dy \\ &= 2\pi \int_0^1 (2y - y^2 - y^3) dy = 2\pi \left[y^2 - \frac{y^3}{3} - \frac{y^4}{4} \right]_0^1 \\ &= 2\pi \left(1 - \frac{1}{3} - \frac{1}{4} \right) = \frac{\pi}{6} (12 - 4 - 3) = \frac{5\pi}{6} \end{aligned}$$

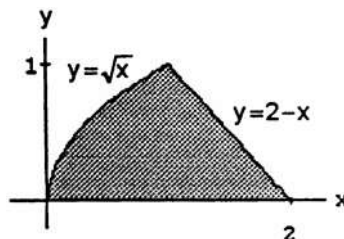

$$\begin{aligned} 23. \text{ (a) } V &= \int_c^d 2\pi \left(\frac{\text{shell}}{\text{radius}} \right) \left(\frac{\text{shell}}{\text{height}} \right) dy = \int_0^1 2\pi y \cdot 12 (y^2 - y^3) dy = 24\pi \int_0^1 (y^3 - y^4) dy = 24\pi \left[\frac{y^4}{4} - \frac{y^5}{5} \right]_0^1 \\ &= 24\pi \left(\frac{1}{4} - \frac{1}{5} \right) = \frac{24\pi}{20} = \frac{6\pi}{5} \end{aligned}$$

$$\begin{aligned} \text{ (b) } V &= \int_c^d 2\pi \left(\frac{\text{shell}}{\text{radius}} \right) \left(\frac{\text{shell}}{\text{height}} \right) dy = \int_0^1 2\pi (1-y) [12(y^2 - y^3)] dy = 24\pi \int_0^1 (1-y)(y^2 - y^3) dy \\ &= 24\pi \int_0^1 (y^2 - 2y^3 + y^4) dy = 24\pi \left[\frac{y^3}{3} - \frac{y^4}{2} + \frac{y^5}{5} \right]_0^1 = 24\pi \left(\frac{1}{3} - \frac{1}{2} + \frac{1}{5} \right) = 24\pi \left(\frac{10}{30} - \frac{6}{30} + \frac{6}{30} \right) = \frac{4\pi}{5} \end{aligned}$$

$$\begin{aligned} \text{ (c) } V &= \int_c^d 2\pi \left(\frac{\text{shell}}{\text{radius}} \right) \left(\frac{\text{shell}}{\text{height}} \right) dy = \int_0^1 2\pi \left(\frac{8}{5} - y \right) [12(y^2 - y^3)] dy = 24\pi \int_0^1 \left(\frac{8}{5} - y \right) (y^2 - y^3) dy \\ &= 24\pi \int_0^1 \left(\frac{8}{5}y^2 - \frac{13}{5}y^3 + y^4 \right) dy = 24\pi \left[\frac{8}{15}y^3 - \frac{13}{20}y^4 + \frac{y^5}{5} \right]_0^1 = 24\pi \left(\frac{8}{15} - \frac{13}{20} + \frac{1}{5} \right) = \frac{24\pi}{60} (32 - 39 + 12) \\ &= \frac{24\pi}{12} = 2\pi \end{aligned}$$

$$\begin{aligned} \text{ (d) } V &= \int_c^d 2\pi \left(\frac{\text{shell}}{\text{radius}} \right) \left(\frac{\text{shell}}{\text{height}} \right) dy = \int_0^1 2\pi \left(y + \frac{2}{5} \right) [12(y^2 - y^3)] dy = 24\pi \int_0^1 \left(y + \frac{2}{5} \right) (y^2 - y^3) dy \\ &= 24\pi \int_0^1 (y^3 - y^4 + \frac{2}{5}y^2 - \frac{2}{5}y^3) dy = 24\pi \int_0^1 \left(\frac{2}{5}y^2 + \frac{3}{5}y^3 - y^4 \right) dy = 24\pi \left[\frac{2}{15}y^3 + \frac{3}{20}y^4 - \frac{y^5}{5} \right]_0^1 \\ &= 24\pi \left(\frac{2}{15} + \frac{3}{20} - \frac{1}{5} \right) = \frac{24\pi}{60} (8 + 9 - 12) = \frac{24\pi}{12} = 2\pi \end{aligned}$$

$$\begin{aligned} 24. \text{ (a) } V &= \int_c^d 2\pi \left(\frac{\text{shell}}{\text{radius}} \right) \left(\frac{\text{shell}}{\text{height}} \right) dy = \int_0^2 2\pi y \left[\frac{y^2}{2} - \left(\frac{y^4}{4} - \frac{y^2}{2} \right) \right] dy = \int_0^2 2\pi y \left(y^2 - \frac{y^4}{4} \right) dy = 2\pi \int_0^2 \left(y^3 - \frac{y^5}{4} \right) dy \\ &= 2\pi \left[\frac{y^4}{4} - \frac{y^6}{24} \right]_0^2 = 2\pi \left(\frac{2^4}{4} - \frac{2^6}{24} \right) = 32\pi \left(\frac{1}{4} - \frac{1}{6} \right) = 32\pi \left(\frac{1}{4} - \frac{1}{6} \right) = 32\pi \left(\frac{2}{24} \right) = \frac{8\pi}{3} \end{aligned}$$

$$\begin{aligned} \text{ (b) } V &= \int_c^d 2\pi \left(\frac{\text{shell}}{\text{radius}} \right) \left(\frac{\text{shell}}{\text{height}} \right) dy = \int_0^2 2\pi (2-y) \left[\frac{y^2}{2} - \left(\frac{y^4}{4} - \frac{y^2}{2} \right) \right] dy = \int_0^2 2\pi (2-y) \left(y^2 - \frac{y^4}{4} \right) dy \\ &= 2\pi \int_0^2 \left(2y^2 - \frac{y^4}{2} - y^3 + \frac{y^5}{4} \right) dy = 2\pi \left[\frac{2y^3}{3} - \frac{y^5}{10} - \frac{y^4}{4} + \frac{y^6}{24} \right]_0^2 = 2\pi \left(\frac{16}{3} - \frac{32}{10} - \frac{16}{4} + \frac{64}{24} \right) = \frac{8\pi}{5} \end{aligned}$$

$$\begin{aligned} \text{ (c) } V &= \int_c^d 2\pi \left(\frac{\text{shell}}{\text{radius}} \right) \left(\frac{\text{shell}}{\text{height}} \right) dy = \int_0^2 2\pi (5-y) \left[\frac{y^2}{2} - \left(\frac{y^4}{4} - \frac{y^2}{2} \right) \right] dy = \int_0^2 2\pi (5-y) \left(y^2 - \frac{y^4}{4} \right) dy \\ &= 2\pi \int_0^2 \left(5y^2 - \frac{5}{4}y^4 - y^3 + \frac{y^5}{4} \right) dy = 2\pi \left[\frac{5y^3}{3} - \frac{5y^5}{20} - \frac{y^4}{4} + \frac{y^6}{24} \right]_0^2 = 2\pi \left(\frac{40}{3} - \frac{160}{20} - \frac{16}{4} + \frac{64}{24} \right) = 8\pi \end{aligned}$$

$$\begin{aligned} \text{ (d) } V &= \int_c^d 2\pi \left(\frac{\text{shell}}{\text{radius}} \right) \left(\frac{\text{shell}}{\text{height}} \right) dy = \int_0^2 2\pi \left(y + \frac{5}{8} \right) \left[\frac{y^2}{2} - \left(\frac{y^4}{4} - \frac{y^2}{2} \right) \right] dy = \int_0^2 2\pi \left(y + \frac{5}{8} \right) \left(y^2 - \frac{y^4}{4} \right) dy \\ &= 2\pi \int_0^2 \left(y^3 - \frac{y^5}{4} + \frac{5}{8}y^2 - \frac{5}{32}y^4 \right) dy = 2\pi \left[\frac{y^4}{4} - \frac{y^6}{24} + \frac{5y^3}{24} - \frac{5y^5}{160} \right]_0^2 = 2\pi \left(\frac{16}{4} - \frac{64}{24} + \frac{40}{24} - \frac{160}{160} \right) = 4\pi \end{aligned}$$

$$\begin{aligned}
 25. \text{ (a) About } x\text{-axis: } V &= \int_c^d 2\pi \left(\begin{array}{c} \text{shell} \\ \text{radius} \end{array} \right) \left(\begin{array}{c} \text{shell} \\ \text{height} \end{array} \right) dy \\
 &= \int_0^1 2\pi y(\sqrt{y} - y) dy = 2\pi \int_0^1 (y^{3/2} - y^2) dy \\
 &= 2\pi \left[\frac{2}{5} y^{5/2} - \frac{1}{3} y^3 \right]_0^1 = 2\pi \left(\frac{2}{5} - \frac{1}{3} \right) = \frac{2\pi}{15}
 \end{aligned}$$

$$\begin{aligned}
 \text{About } y\text{-axis: } V &= \int_a^b 2\pi \left(\begin{array}{c} \text{shell} \\ \text{radius} \end{array} \right) \left(\begin{array}{c} \text{shell} \\ \text{height} \end{array} \right) dx \\
 &= \int_0^1 2\pi x(x - x^2) dx = 2\pi \int_0^1 (x^2 - x^3) dx \\
 &= 2\pi \left[\frac{x^3}{3} - \frac{x^4}{4} \right]_0^1 = 2\pi \left(\frac{1}{3} - \frac{1}{4} \right) = \frac{\pi}{6}
 \end{aligned}$$

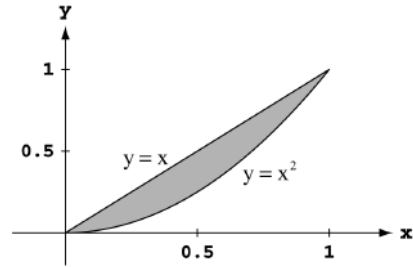

$$\begin{aligned}
 \text{(b) About } x\text{-axis: } R(x) = x \text{ and } r(x) = x^2 \Rightarrow V &= \int_a^b \pi [R(x)^2 - r(x)^2] dx = \int_0^1 \pi [x^2 - x^4] dx \\
 &= \pi \left[\frac{x^3}{3} - \frac{x^5}{5} \right]_0^1 = \pi \left(\frac{1}{3} - \frac{1}{5} \right) = \frac{2\pi}{15}
 \end{aligned}$$

$$\begin{aligned}
 \text{About } y\text{-axis: } R(y) = \sqrt{y} \text{ and } r(y) = y \Rightarrow V &= \int_c^d \pi [R(y)^2 - r(y)^2] dy = \int_0^1 \pi [y - y^2] dy \\
 &= \pi \left[\frac{y^2}{2} - \frac{y^3}{3} \right]_0^1 = \pi \left(\frac{1}{2} - \frac{1}{3} \right) = \frac{\pi}{6}
 \end{aligned}$$

$$\begin{aligned}
 26. \text{ (a) } V &= \int_a^b \pi [R(x)^2 - r(x)^2] dx = \pi \int_0^4 \left[\left(\frac{x}{2} + 2 \right)^2 - x^2 \right] dx \\
 &= \pi \int_0^4 \left(-\frac{3}{4}x^2 + 2x + 4 \right) dx = \pi \left[-\frac{3}{4}x^3 + x^2 + 4x \right]_0^4 \\
 &= \pi(-16 + 16 + 16) = 16\pi
 \end{aligned}$$

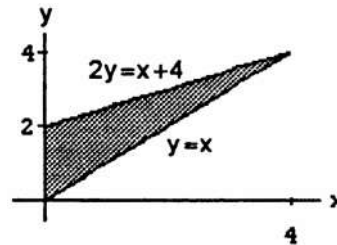

$$\begin{aligned}
 \text{(b) } V &= \int_a^b 2\pi \left(\begin{array}{c} \text{shell} \\ \text{radius} \end{array} \right) \left(\begin{array}{c} \text{shell} \\ \text{height} \end{array} \right) dx = \int_0^4 2\pi x \left(\frac{x}{2} + 2 - x \right) dx \\
 &= \int_0^4 2\pi x \left(2 - \frac{x}{2} \right) dx = 2\pi \int_0^4 \left(2x - \frac{x^2}{2} \right) dx \\
 &= 2\pi \left[x^2 - \frac{x^3}{6} \right]_0^4 = 2\pi \left(16 - \frac{64}{6} \right) = \frac{32\pi}{3}
 \end{aligned}$$

$$\begin{aligned}
 \text{(c) } V &= \int_a^b 2\pi \left(\begin{array}{c} \text{shell} \\ \text{radius} \end{array} \right) \left(\begin{array}{c} \text{shell} \\ \text{height} \end{array} \right) dx = \int_0^4 2\pi (4-x) \left(\frac{x}{2} + 2 - x \right) dx = \int_0^4 2\pi (4-x) \left(2 - \frac{x}{2} \right) dx = 2\pi \int_0^4 \left(8 - 4x + \frac{x^2}{2} \right) dx \\
 &= 2\pi \left[8x - 2x^2 + \frac{x^3}{6} \right]_0^4 = 2\pi \left(32 - 32 + \frac{64}{6} \right) = \frac{64\pi}{3}
 \end{aligned}$$

$$\begin{aligned}
 \text{(d) } V &= \int_a^b \pi [R(x)^2 - r(x)^2] dx = \pi \int_0^4 \left[(8-x)^2 - \left(6 - \frac{x}{2} \right)^2 \right] dx = \pi \int_0^4 \left[(64 - 16x + x^2) - \left(36 - 6x + \frac{x^2}{4} \right) \right] dx \\
 &= \pi \int_0^4 \left(\frac{3}{4}x^2 - 10x + 28 \right) dx = \pi \left[\frac{3}{4}x^3 - 5x^2 + 28x \right]_0^4 = \pi [16 - (5)(16) + (7)(16)] = \pi(3)(16) = 48\pi
 \end{aligned}$$

$$\begin{aligned}
 27. \text{ (a) } V &= \int_c^d 2\pi \left(\begin{array}{c} \text{shell} \\ \text{radius} \end{array} \right) \left(\begin{array}{c} \text{shell} \\ \text{height} \end{array} \right) dy = \int_1^2 2\pi y(y-1) dy \\
 &= 2\pi \int_1^2 (y^2 - y) dy = 2\pi \left[\frac{y^3}{3} - \frac{y^2}{2} \right]_1^2 \\
 &= 2\pi \left[\left(\frac{8}{3} - \frac{4}{2} \right) - \left(\frac{1}{3} - \frac{1}{2} \right) \right] \\
 &= 2\pi \left(\frac{7}{3} - 2 + \frac{1}{2} \right) = \frac{\pi}{3} (14 - 12 + 3) = \frac{5\pi}{3}
 \end{aligned}$$

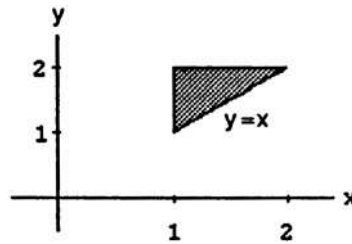

$$\begin{aligned}
 \text{(b) } V &= \int_a^b 2\pi \left(\begin{array}{c} \text{shell} \\ \text{radius} \end{array} \right) \left(\begin{array}{c} \text{shell} \\ \text{height} \end{array} \right) dx \\
 &= \int_1^2 2\pi x(2-x) dx = 2\pi \int_1^2 (2x - x^2) dx = 2\pi \left[x^2 - \frac{x^3}{3} \right]_1^2 = 2\pi \left[\left(4 - \frac{8}{3} \right) - \left(1 - \frac{1}{3} \right) \right] \\
 &= 2\pi \left[\left(\frac{12-8}{3} \right) - \left(\frac{3-1}{3} \right) \right] = 2\pi \left(\frac{4}{3} - \frac{2}{3} \right) = \frac{4\pi}{3}
 \end{aligned}$$

$$\begin{aligned}
 \text{(c) } V &= \int_a^b 2\pi \left(\begin{array}{c} \text{shell} \\ \text{radius} \end{array} \right) \left(\begin{array}{c} \text{shell} \\ \text{height} \end{array} \right) dx = \int_1^2 2\pi \left(\frac{10}{3} - x \right) (2-x) dx = 2\pi \int_1^2 \left(\frac{20}{3} - \frac{16}{3}x + x^2 \right) dx \\
 &= 2\pi \left[\frac{20}{3}x - \frac{8}{3}x^2 + \frac{1}{3}x^3 \right]_1^2 = 2\pi \left[\left(\frac{40}{3} - \frac{32}{3} + \frac{8}{3} \right) - \left(\frac{20}{3} - \frac{8}{3} + \frac{1}{3} \right) \right] = 2\pi \left(\frac{3}{3} \right) = 2\pi
 \end{aligned}$$

$$\text{(d) } V = \int_c^d 2\pi \left(\begin{array}{c} \text{shell} \\ \text{radius} \end{array} \right) \left(\begin{array}{c} \text{shell} \\ \text{height} \end{array} \right) dy = \int_1^2 2\pi (y-1)(y-1) dy = 2\pi \int_1^2 (y-1)^2 dy = 2\pi \left[\frac{(y-1)^3}{3} \right]_1^2 = \frac{2\pi}{3}$$

$$\begin{aligned}
 28. \text{ (a) } V &= \int_c^d 2\pi \left(\begin{array}{c} \text{shell} \\ \text{radius} \end{array} \right) \left(\begin{array}{c} \text{shell} \\ \text{height} \end{array} \right) dy = \int_0^2 2\pi y(y^2 - 0) dy \\
 &= 2\pi \int_0^2 y^3 dy = 2\pi \left[\frac{y^4}{4} \right]_0^2 = 2\pi \left(\frac{2^4}{4} \right) = 8\pi
 \end{aligned}$$

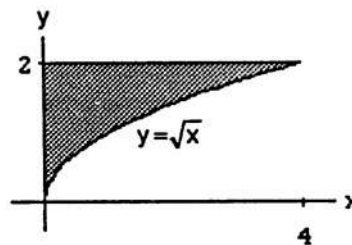

$$\begin{aligned}
 \text{(b) } V &= \int_a^b 2\pi \left(\begin{array}{c} \text{shell} \\ \text{radius} \end{array} \right) \left(\begin{array}{c} \text{shell} \\ \text{height} \end{array} \right) dx \\
 &= \int_0^4 2\pi x(2 - \sqrt{x}) dx = 2\pi \int_0^4 (2x - x^{3/2}) dx \\
 &= 2\pi \left[x^2 - \frac{2}{5} x^{5/2} \right]_0^4 = 2\pi \left(16 - \frac{2 \cdot 2^5}{5} \right) \\
 &= 2\pi \left(16 - \frac{64}{5} \right) = \frac{2\pi}{5} (80 - 64) = \frac{32\pi}{5}
 \end{aligned}$$

$$\begin{aligned}
 \text{(c) } V &= \int_a^b 2\pi \left(\begin{array}{c} \text{shell} \\ \text{radius} \end{array} \right) \left(\begin{array}{c} \text{shell} \\ \text{height} \end{array} \right) dx = \int_0^4 2\pi(4-x)(2-\sqrt{x}) dx = 2\pi \int_0^4 (8 - 4x^{1/2} - 2x + x^{3/2}) dx \\
 &= 2\pi \left[8x - \frac{8}{3} x^{3/2} - x^2 + \frac{2}{5} x^{5/2} \right]_0^4 = 2\pi \left(32 - \frac{64}{3} - 16 + \frac{64}{5} \right) = \frac{2\pi}{15} (240 - 320 + 192) = \frac{2\pi}{15} (112) = \frac{224\pi}{15}
 \end{aligned}$$

$$\begin{aligned}
 \text{(d) } V &= \int_c^d 2\pi \left(\begin{array}{c} \text{shell} \\ \text{radius} \end{array} \right) \left(\begin{array}{c} \text{shell} \\ \text{height} \end{array} \right) dy = \int_0^2 2\pi(2-y)(y^2) dy = 2\pi \int_0^2 (2y^2 - y^3) dy = 2\pi \left[\frac{2}{3} y^3 - \frac{y^4}{4} \right]_0^2 \\
 &= 2\pi \left(\frac{16}{3} - \frac{16}{4} \right) = \frac{32\pi}{12} (4 - 3) = \frac{8\pi}{3}
 \end{aligned}$$

$$\begin{aligned}
 29. \text{ (a) } V &= \int_c^d 2\pi \left(\begin{array}{c} \text{shell} \\ \text{radius} \end{array} \right) \left(\begin{array}{c} \text{shell} \\ \text{height} \end{array} \right) dy = \int_0^1 2\pi y(y - y^3) dy \\
 &= \int_0^1 2\pi (y^2 - y^4) dy = 2\pi \left[\frac{y^3}{3} - \frac{y^5}{5} \right]_0^1 = 2\pi \left(\frac{1}{3} - \frac{1}{5} \right) \\
 &= \frac{4\pi}{15}
 \end{aligned}$$

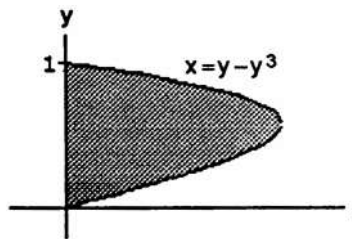

$$\begin{aligned}
 \text{(b) } V &= \int_c^d 2\pi \left(\begin{array}{c} \text{shell} \\ \text{radius} \end{array} \right) \left(\begin{array}{c} \text{shell} \\ \text{height} \end{array} \right) dy \\
 &= \int_0^1 2\pi(1-y)(y - y^3) dy \\
 &= 2\pi \int_0^1 (y - y^2 - y^3 + y^4) dy = 2\pi \left[\frac{y^2}{2} - \frac{y^3}{3} - \frac{y^4}{4} + \frac{y^5}{5} \right]_0^1 = 2\pi \left(\frac{1}{2} - \frac{1}{3} - \frac{1}{4} + \frac{1}{5} \right) = \frac{2\pi}{60} (30 - 20 - 15 + 12) = \frac{7\pi}{30}
 \end{aligned}$$

$$\begin{aligned}
 30. \text{ (a) } V &= \int_c^d 2\pi \left(\begin{array}{c} \text{shell} \\ \text{radius} \end{array} \right) \left(\begin{array}{c} \text{shell} \\ \text{height} \end{array} \right) dy \\
 &= \int_0^1 2\pi y [1 - (y - y^3)] dy \\
 &= 2\pi \int_0^1 (y - y^2 + y^4) dy = 2\pi \left[\frac{y^2}{2} - \frac{y^3}{3} + \frac{y^5}{5} \right]_0^1 \\
 &= 2\pi \left(\frac{1}{2} - \frac{1}{3} + \frac{1}{5} \right) = \frac{2\pi}{30} (15 - 10 + 6) \\
 &= \frac{11\pi}{15}
 \end{aligned}$$

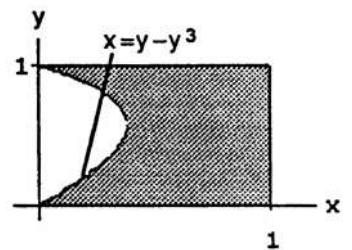

(b) Use the washer method:

$$\begin{aligned}
 V &= \int_c^d \pi [R^2(y) - r^2(y)] dy = \int_0^1 \pi [1^2 - (y - y^3)^2] dy = \pi \int_0^1 (1 - y^2 - y^6 + 2y^4) dy = \pi \left[y - \frac{y^3}{3} - \frac{y^7}{7} + \frac{2y^5}{5} \right]_0^1 \\
 &= \pi \left(1 - \frac{1}{3} - \frac{1}{7} + \frac{2}{5} \right) = \frac{\pi}{105} (105 - 35 - 15 + 42) = \frac{97\pi}{105}
 \end{aligned}$$

(c) Use the washer method:

$$\begin{aligned}
 V &= \int_c^d \pi [R^2(y) - r^2(y)] dy = \int_0^1 \pi [1^2 - (y - y^3)^2] dy = \pi \int_0^1 [1 - 2(y - y^3) + (y - y^3)^2] dy \\
 &= \pi \int_0^1 (1 + y^2 + y^6 - 2y + 2y^3 - 2y^4) dy = \pi \left[y + \frac{y^3}{3} + \frac{y^7}{7} - y^2 + \frac{y^4}{2} - \frac{2y^5}{5} \right]_0^1 = \pi \left(1 + \frac{1}{3} + \frac{1}{7} - 1 + \frac{1}{2} - \frac{2}{5} \right) \\
 &= \frac{\pi}{210} (70 + 30 + 105 - 2 \cdot 42) = \frac{121\pi}{210}
 \end{aligned}$$

$$\begin{aligned}
 \text{(d) } V &= \int_c^d 2\pi \left(\begin{array}{c} \text{shell} \\ \text{radius} \end{array} \right) \left(\begin{array}{c} \text{shell} \\ \text{height} \end{array} \right) dy = \int_0^1 2\pi(1-y)[1 - (y - y^3)] dy = 2\pi \int_0^1 (1-y)(1-y+y^3) dy \\
 &= 2\pi \int_0^1 (1 - y + y^3 - y + y^2 - y^4) dy = 2\pi \int_0^1 (1 - 2y + y^2 + y^3 - y^4) dy = 2\pi \left[y - y^2 + \frac{y^3}{3} + \frac{y^4}{4} - \frac{y^5}{5} \right]_0^1 \\
 &= 2\pi \left(1 - 1 + \frac{1}{3} + \frac{1}{4} - \frac{1}{5} \right) = \frac{2\pi}{60} (20 + 15 - 12) = \frac{23\pi}{30}
 \end{aligned}$$

$$\begin{aligned}
 31. \text{ (a) } V &= \int_c^d 2\pi \left(\begin{array}{c} \text{shell} \\ \text{radius} \end{array} \right) \left(\begin{array}{c} \text{shell} \\ \text{height} \end{array} \right) dy = \int_0^2 2\pi y (\sqrt{8y} - y^2) dy \\
 &= 2\pi \int_0^2 (2\sqrt{2}y^{3/2} - y^3) dy = 2\pi \left[\frac{4\sqrt{2}}{5} y^{5/2} - \frac{y^4}{4} \right]_0^2 \\
 &= 2\pi \left(\frac{4\sqrt{2} \cdot (\sqrt{2})^5}{5} - \frac{2^4}{4} \right) = 2\pi \left(\frac{4 \cdot 2^3}{5} - \frac{4 \cdot 4}{4} \right) \\
 &= 2\pi \cdot 4 \left(\frac{8}{5} - 1 \right) = \frac{8\pi}{5} (8 - 5) = \frac{24\pi}{5}
 \end{aligned}$$

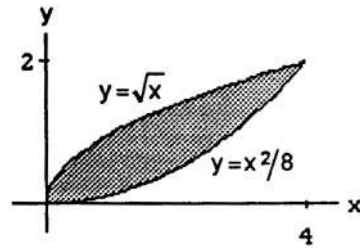

$$\begin{aligned}
 \text{(b) } V &= \int_a^b 2\pi \left(\begin{array}{c} \text{shell} \\ \text{radius} \end{array} \right) \left(\begin{array}{c} \text{shell} \\ \text{height} \end{array} \right) dx = \int_0^4 2\pi x \left(\sqrt{x} - \frac{x^2}{8} \right) dx = 2\pi \int_0^4 \left(x^{3/2} - \frac{x^3}{8} \right) dx = 2\pi \left[\frac{2}{5} x^{5/2} - \frac{x^4}{32} \right]_0^4 \\
 &= 2\pi \left(\frac{2 \cdot 2^5}{5} - \frac{4^4}{32} \right) = 2\pi \left(\frac{2^6}{5} - \frac{2^8}{32} \right) = \frac{\pi \cdot 2^7}{160} (32 - 20) = \frac{\pi \cdot 2^9 \cdot 3}{160} = \frac{\pi \cdot 2^4 \cdot 3}{5} = \frac{48\pi}{5}
 \end{aligned}$$

$$\begin{aligned}
 32. \text{ (a) } V &= \int_a^b 2\pi \left(\begin{array}{c} \text{shell} \\ \text{radius} \end{array} \right) \left(\begin{array}{c} \text{shell} \\ \text{height} \end{array} \right) dx \\
 &= \int_0^1 2\pi x [(2x - x^2) - x] dx \\
 &= 2\pi \int_0^1 x(x - x^2) dx = 2\pi \int_0^1 (x^2 - x^3) dx \\
 &= 2\pi \left[\frac{x^3}{3} - \frac{x^4}{4} \right]_0^1 = 2\pi \left(\frac{1}{3} - \frac{1}{4} \right) = \frac{\pi}{6}
 \end{aligned}$$

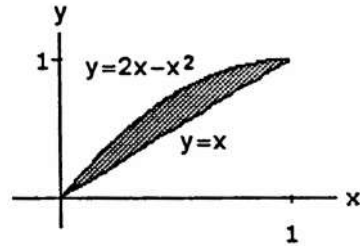

$$\begin{aligned}
 \text{(b) } V &= \int_a^b 2\pi \left(\begin{array}{c} \text{shell} \\ \text{radius} \end{array} \right) \left(\begin{array}{c} \text{shell} \\ \text{height} \end{array} \right) dx = \int_0^1 2\pi(1-x)[(2x-x^2)-x] dx = 2\pi \int_0^1 (1-x)(x-x^2) dx \\
 &= 2\pi \int_0^1 (x-2x^2+x^3) dx = 2\pi \left[\frac{x^2}{2} - \frac{2}{3}x^3 + \frac{x^4}{4} \right]_0^1 = 2\pi \left(\frac{1}{2} - \frac{2}{3} + \frac{1}{4} \right) = \frac{2\pi}{12} (6 - 8 + 3) = \frac{\pi}{6}
 \end{aligned}$$

$$\begin{aligned}
 33. \text{ (a) } V &= \int_a^b \pi [R^2(x) - r^2(x)] dx = \pi \int_{1/16}^1 (x^{-1/2} - 1) dx \\
 &= \pi [2x^{1/2} - x]_{1/16}^1 = \pi \left[(2 - 1) - \left(2 \cdot \frac{1}{4} - \frac{1}{16} \right) \right] \\
 &= \pi \left(1 - \frac{7}{16} \right) = \frac{9\pi}{16}
 \end{aligned}$$

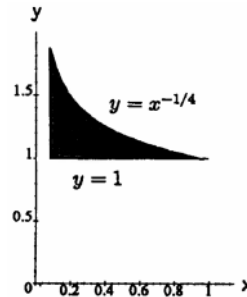

$$\begin{aligned}
 \text{(b) } V &= \int_a^b 2\pi \left(\begin{array}{c} \text{shell} \\ \text{radius} \end{array} \right) \left(\begin{array}{c} \text{shell} \\ \text{height} \end{array} \right) dy = \int_1^2 2\pi y \left(\frac{1}{y^4} - \frac{1}{16} \right) dy \\
 &= 2\pi \int_1^2 \left(y^{-3} - \frac{y}{16} \right) dy = 2\pi \left[-\frac{1}{2} y^{-2} - \frac{y^2}{32} \right]_1^2 \\
 &= 2\pi \left[\left(-\frac{1}{8} - \frac{1}{8} \right) - \left(-\frac{1}{2} - \frac{1}{32} \right) \right] = 2\pi \left(\frac{1}{4} + \frac{1}{32} \right) \\
 &= \frac{2\pi}{32} (8 + 1) = \frac{9\pi}{16}
 \end{aligned}$$

$$\begin{aligned}
 34. \text{ (a) } V &= \int_c^d \pi [R^2(y) - r^2(y)] dy = \int_1^2 \pi \left(\frac{1}{y^4} - \frac{1}{16} \right) dy \\
 &= \pi \left[-\frac{1}{3} y^{-3} - \frac{y}{16} \right]_1^2 = \pi \left[\left(-\frac{1}{24} - \frac{1}{8} \right) - \left(-\frac{1}{3} - \frac{1}{16} \right) \right] \\
 &= \frac{\pi}{48} (-2 - 6 + 16 + 3) = \frac{11\pi}{48}
 \end{aligned}$$

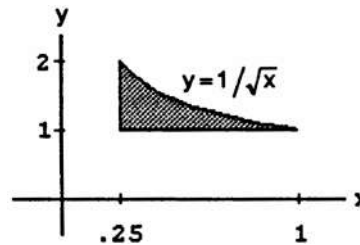

$$\begin{aligned}
 \text{(b) } V &= \int_a^b 2\pi \left(\begin{array}{c} \text{shell} \\ \text{radius} \end{array} \right) \left(\begin{array}{c} \text{shell} \\ \text{height} \end{array} \right) dx = \int_{1/4}^1 2\pi x \left(\frac{1}{\sqrt{x}} - 1 \right) dx \\
 &= 2\pi \int_{1/4}^1 (x^{1/2} - x) dx = 2\pi \left[\frac{2}{3} x^{3/2} - \frac{x^2}{2} \right]_{1/4}^1 \\
 &= 2\pi \left[\left(\frac{2}{3} - \frac{1}{2} \right) - \left(\frac{2}{3} \cdot \frac{1}{8} - \frac{1}{32} \right) \right] = \pi \left(\frac{4}{3} - 1 - \frac{1}{6} + \frac{1}{16} \right) = \frac{\pi}{48} (4 \cdot 16 - 48 - 8 + 3) = \frac{11\pi}{48}
 \end{aligned}$$

$$35. \text{ (a) Disk: } V = V_1 - V_2$$

$$V_1 = \int_{a_1}^{b_1} \pi [R_1(x)]^2 dx \text{ and } V_2 = \int_{a_2}^{b_2} \pi [R_2(x)]^2 dx \text{ with } R_1(x) = \sqrt{\frac{x+2}{3}} \text{ and } R_2(x) = \sqrt{x},$$

$$a_1 = -2, b_1 = 1; a_2 = 0, b_2 = 1 \Rightarrow \text{two integrals are required}$$

$$\text{(b) Washer: } V = V_1 - V_2$$

$$V_1 = \int_{a_1}^{b_1} \pi ([R_1(x)]^2 - [r_1(x)]^2) dx \text{ with } R_1(x) = \sqrt{\frac{x+2}{3}} \text{ and } r_1(x) = 0; a_1 = -2 \text{ and } b_1 = 0;$$

$$V_2 = \int_{a_2}^{b_2} \pi ([R_2(x)]^2 - [r_2(x)]^2) dx \text{ with } R_2(x) = \sqrt{\frac{x+2}{3}} \text{ and } r_2(x) = \sqrt{x}; a_2 = 0 \text{ and } b_2 = 1$$

\Rightarrow two integrals are required

- (c) *Shell*: $V = \int_c^d 2\pi \left(\frac{\text{shell}}{\text{radius}}\right) \left(\frac{\text{shell}}{\text{height}}\right) dy = \int_c^d 2\pi y \left(\frac{\text{shell}}{\text{height}}\right) dy$ where shell height $= y^2 - (3y^2 - 2) = 2 - 2y^2$; $c = 0$ and $d = 1$. Only *one* integral is required. It is, therefore preferable to use the *shell* method. However, whichever method you use, you will get $V = \pi$.

36. (a) *Disk*: $V = V_1 - V_2 - V_3$

$$V_i = \int_{c_i}^{d_i} \pi [R_i(y)]^2 dy, i = 1, 2, 3 \text{ with } R_1(y) = 1 \text{ and } c_1 = -1, d_1 = 1; R_2(y) = \sqrt{y} \text{ and } c_2 = 0 \text{ and } d_2 = 1;$$

$$R_3(y) = (-y)^{1/4} \text{ and } c_3 = -1, d_3 = 0 \Rightarrow \text{three integrals are required}$$

- (b) *Washer*: $V = V_1 + V_2$

$$V_i = \int_{c_i}^{d_i} \pi ([R_i(y)]^2 - [r_i(y)]^2) dy, i = 1, 2 \text{ with } R_1(y) = 1, r_1(y) = \sqrt{y}, c_1 = 0 \text{ and } d_1 = 1;$$

$$R_2(y) = 1, r_2(y) = (-y)^{1/4}, c_2 = -1 \text{ and } d_2 = 0 \Rightarrow \text{two integrals are required}$$

- (c) *Shell*: $V = \int_a^b 2\pi \left(\frac{\text{shell}}{\text{radius}}\right) \left(\frac{\text{shell}}{\text{height}}\right) dx = \int_a^b 2\pi x \left(\frac{\text{shell}}{\text{height}}\right) dx$, where shell height $= x^2 - (-x^4) = x^2 + x^4$, $a = 0$ and $b = 1 \Rightarrow$ only one integral is required. It is, therefore preferable to use the *shell* method. However, whichever method you use, you will get $V = \frac{5\pi}{6}$.

6.3 LENGTHS OF PLANE CURVES

$$1. \frac{dx}{dt} = -1 \text{ and } \frac{dy}{dt} = 3 \Rightarrow \sqrt{\left(\frac{dx}{dt}\right)^2 + \left(\frac{dy}{dt}\right)^2} = \sqrt{(-1)^2 + (3)^2} = \sqrt{10}$$

$$\Rightarrow \text{Length} = \int_{-2/3}^1 \sqrt{10} dt = \sqrt{10} [t]_{-2/3}^1 = \sqrt{10} - \left(-\frac{2}{3}\sqrt{10}\right) = \frac{5\sqrt{10}}{3}$$

$$2. \frac{dx}{dt} = -\sin t \text{ and } \frac{dy}{dt} = 1 + \cos t \Rightarrow \sqrt{\left(\frac{dx}{dt}\right)^2 + \left(\frac{dy}{dt}\right)^2} = \sqrt{(-\sin t)^2 + (1 + \cos t)^2} = \sqrt{2 + 2\cos t}$$

$$\Rightarrow \text{Length} = \int_0^\pi \sqrt{2 + 2\cos t} dt = \sqrt{2} \int_0^\pi \sqrt{\frac{1 + \cos t}{2}} (1 + \cos t) dt = \sqrt{2} \int_0^\pi \sqrt{\frac{\sin^2 t}{1 - \cos t}} dt$$

$$= \sqrt{2} \int_0^\pi \frac{\sin t}{\sqrt{1 - \cos t}} dt \text{ (since } \sin t \geq 0 \text{ on } [0, \pi]); [u = 1 - \cos t \Rightarrow du = \sin t dt; t = 0 \Rightarrow u = 0,$$

$$t = \pi \Rightarrow u = 2] \rightarrow \sqrt{2} \int_0^2 u^{-1/2} du = \sqrt{2} [2u^{1/2}]_0^2 = 4$$

$$3. \frac{dx}{dt} = 3t^2 \text{ and } \frac{dy}{dt} = 3t \Rightarrow \sqrt{\left(\frac{dx}{dt}\right)^2 + \left(\frac{dy}{dt}\right)^2} = \sqrt{(3t^2)^2 + (3t)^2} = \sqrt{9t^4 + 9t^2} = 3t\sqrt{t^2 + 1} \text{ (since } t \geq 0 \text{ on } [0, \sqrt{3}])$$

$$\Rightarrow \text{Length} = \int_0^{\sqrt{3}} 3t\sqrt{t^2 + 1} dt; [u = t^2 + 1 \Rightarrow \frac{3}{2} du = 3t dt; t = 0 \Rightarrow u = 1, t = \sqrt{3} \Rightarrow u = 4]$$

$$\rightarrow \int_1^4 \frac{3}{2} u^{1/2} du = [u^{3/2}]_1^4 = (8 - 1) = 7$$

$$4. \frac{dx}{dt} = t \text{ and } \frac{dy}{dt} = (2t + 1)^{1/2} \Rightarrow \sqrt{\left(\frac{dx}{dt}\right)^2 + \left(\frac{dy}{dt}\right)^2} = \sqrt{t^2 + (2t + 1)} = \sqrt{(t + 1)^2} = |t + 1| = t + 1 \text{ since } 0 \leq t \leq 4$$

$$\Rightarrow \text{Length} = \int_0^4 (t + 1) dt = \left[\frac{t^2}{2} + t\right]_0^4 = (8 + 4) = 12$$

$$5. \frac{dx}{dt} = (2t + 3)^{1/2} \text{ and } \frac{dy}{dt} = 1 + t \Rightarrow \sqrt{\left(\frac{dx}{dt}\right)^2 + \left(\frac{dy}{dt}\right)^2} = \sqrt{(2t + 3) + (1 + t)^2} = \sqrt{t^2 + 4t + 4} = |t + 2| = t + 2$$

$$\text{since } 0 \leq t \leq 3 \Rightarrow \text{Length} = \int_0^3 (t + 2) dt = \left[\frac{t^2}{2} + 2t\right]_0^3 = \frac{21}{2}$$

$$\begin{aligned}
 6. \quad \frac{dx}{dt} &= 8t \cos t \text{ and } \frac{dy}{dt} = 8t \sin t \Rightarrow \sqrt{\left(\frac{dx}{dt}\right)^2 + \left(\frac{dy}{dt}\right)^2} = \sqrt{(8t \cos t)^2 + (8t \sin t)^2} = \sqrt{64t^2 \cos^2 t + 64t^2 \sin^2 t} \\
 &= |8t| = 8t \text{ since } 0 \leq t \leq \frac{\pi}{2} \Rightarrow \text{Length} = \int_0^{\pi/2} 8t \, dt = [4t^2]_0^{\pi/2} = \pi^2
 \end{aligned}$$

$$\begin{aligned}
 7. \quad \frac{dy}{dx} &= \frac{1}{3} \cdot \frac{3}{2} (x^2 + 2)^{1/2} \cdot 2x = \sqrt{(x^2 + 2)} \cdot x \\
 &\Rightarrow L = \int_0^3 \sqrt{1 + (x^2 + 2)x^2} \, dx = \int_0^3 \sqrt{1 + 2x^2 + x^4} \, dx \\
 &= \int_0^3 \sqrt{(1 + x^2)^2} \, dx = \int_0^3 (1 + x^2) \, dx = \left[x + \frac{x^3}{3} \right]_0^3 \\
 &= 3 + \frac{27}{3} = 12
 \end{aligned}$$

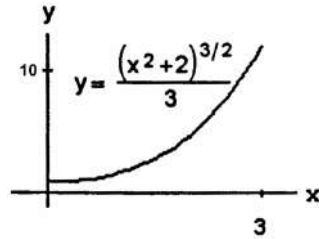

$$\begin{aligned}
 8. \quad \frac{dy}{dx} &= \frac{3}{2} \sqrt{x} \Rightarrow L = \int_0^4 \sqrt{1 + \frac{9}{4}x} \, dx; [u = 1 + \frac{9}{4}x \\
 &\Rightarrow du = \frac{9}{4} dx \Rightarrow \frac{4}{9} du = dx; x = 0 \Rightarrow u = 1; x = 4 \\
 &\Rightarrow u = 10] \rightarrow L = \int_1^{10} u^{1/2} \left(\frac{4}{9} du\right) = \frac{4}{9} \left[\frac{2}{3} u^{3/2}\right]_1^{10} \\
 &= \frac{8}{27} (10\sqrt{10} - 1)
 \end{aligned}$$

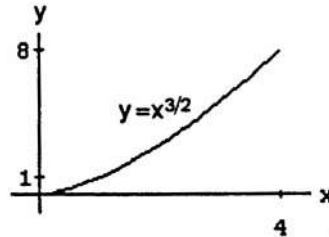

$$\begin{aligned}
 9. \quad \frac{dx}{dy} &= y^2 - \frac{1}{4y^2} \Rightarrow \left(\frac{dx}{dy}\right)^2 = y^4 - \frac{1}{2} + \frac{1}{16y^4} \\
 &\Rightarrow L = \int_1^3 \sqrt{1 + y^4 - \frac{1}{2} + \frac{1}{16y^4}} \, dy \\
 &= \int_1^3 \sqrt{y^4 + \frac{1}{2} + \frac{1}{16y^4}} \, dy \\
 &= \int_1^3 \sqrt{\left(y^2 + \frac{1}{4y^2}\right)^2} \, dy = \int_1^3 \left(y^2 + \frac{1}{4y^2}\right) \, dy \\
 &= \left[\frac{y^3}{3} - \frac{y^{-1}}{4}\right]_1^3 = \left(\frac{27}{3} - \frac{1}{12}\right) - \left(\frac{1}{3} - \frac{1}{4}\right) = 9 - \frac{1}{12} - \frac{1}{3} + \frac{1}{4} = 9 + \frac{(-1-4+3)}{12} = 9 + \frac{(-2)}{12} = \frac{53}{6}
 \end{aligned}$$

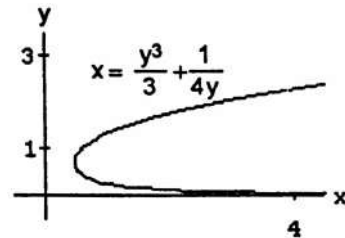

$$\begin{aligned}
 10. \quad \frac{dx}{dy} &= \frac{1}{2} y^{1/2} - \frac{1}{2} y^{-1/2} \Rightarrow \left(\frac{dx}{dy}\right)^2 = \frac{1}{4} \left(y - 2 + \frac{1}{y}\right) \\
 &\Rightarrow L = \int_1^9 \sqrt{1 + \frac{1}{4} \left(y - 2 + \frac{1}{y}\right)} \, dy \\
 &= \int_1^9 \sqrt{\frac{1}{4} \left(y + 2 + \frac{1}{y}\right)} \, dy = \int_1^9 \frac{1}{2} \sqrt{\left(\sqrt{y} + \frac{1}{\sqrt{y}}\right)^2} \, dy \\
 &= \frac{1}{2} \int_1^9 (y^{1/2} + y^{-1/2}) \, dy = \frac{1}{2} \left[\frac{2}{3} y^{3/2} + 2y^{1/2}\right]_1^9 \\
 &= \left[\frac{y^{3/2}}{3} + y^{1/2}\right]_1^9 = \left(\frac{3^3}{3} + 3\right) - \left(\frac{1}{3} + 1\right) = 11 - \frac{1}{3} = \frac{32}{3}
 \end{aligned}$$

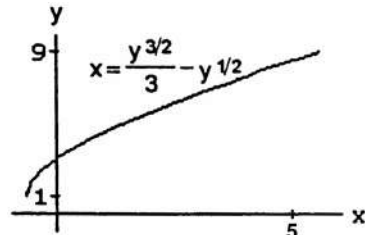

$$\begin{aligned}
 11. \quad \frac{dx}{dy} &= y^3 - \frac{1}{4y^3} \Rightarrow \left(\frac{dx}{dy}\right)^2 = y^6 - \frac{1}{2} + \frac{1}{16y^6} \\
 &\Rightarrow L = \int_1^2 \sqrt{1 + y^6 - \frac{1}{2} + \frac{1}{16y^6}} \, dy \\
 &= \int_1^2 \sqrt{y^6 + \frac{1}{2} + \frac{1}{16y^6}} \, dy = \int_1^2 \sqrt{\left(y^3 + \frac{y^{-3}}{4}\right)^2} \, dy \\
 &= \int_1^2 \left(y^3 + \frac{y^{-3}}{4}\right) \, dy = \left[\frac{y^4}{4} - \frac{y^{-2}}{8}\right]_1^2 \\
 &= \left(\frac{16}{4} - \frac{1}{(16)(2)}\right) - \left(\frac{1}{4} - \frac{1}{8}\right) = 4 - \frac{1}{32} - \frac{1}{4} + \frac{1}{8} = \frac{128-1-8+4}{32} = \frac{123}{32}
 \end{aligned}$$

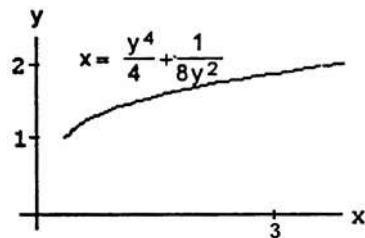

$$\begin{aligned}
 12. \quad \frac{dx}{dy} &= \frac{y^2}{2} - \frac{1}{2y^2} \Rightarrow \left(\frac{dx}{dy}\right)^2 = \frac{1}{4}(y^4 - 2 + y^{-4}) \\
 &\Rightarrow L = \int_2^3 \sqrt{1 + \frac{1}{4}(y^4 - 2 + y^{-4})} dy \\
 &= \int_2^3 \sqrt{\frac{1}{4}(y^4 + 2 + y^{-4})} dy \\
 &= \frac{1}{2} \int_2^3 \sqrt{(y^2 + y^{-2})^2} dy = \frac{1}{2} \int_2^3 (y^2 + y^{-2}) dy \\
 &= \frac{1}{2} \left[\frac{y^3}{3} - y^{-1} \right]_2^3 = \frac{1}{2} \left[\left(\frac{27}{3} - \frac{1}{3}\right) - \left(\frac{8}{3} - \frac{1}{2}\right) \right] = \frac{1}{2} \left(\frac{26}{3} - \frac{8}{3} + \frac{1}{2}\right) = \frac{1}{2} \left(6 + \frac{1}{2}\right) = \frac{13}{4}
 \end{aligned}$$

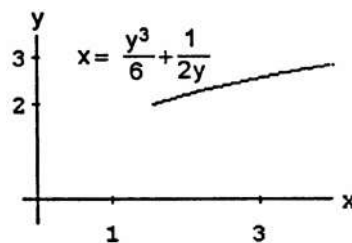

$$\begin{aligned}
 13. \quad \frac{dy}{dx} &= x^{1/3} - \frac{1}{4}x^{-1/3} \Rightarrow \left(\frac{dy}{dx}\right)^2 = x^{2/3} - \frac{1}{2} + \frac{x^{-2/3}}{16} \\
 &\Rightarrow L = \int_1^8 \sqrt{1 + x^{2/3} - \frac{1}{2} + \frac{x^{-2/3}}{16}} dx \\
 &= \int_1^8 \sqrt{x^{2/3} + \frac{1}{2} + \frac{x^{-2/3}}{16}} dx \\
 &= \int_1^8 \sqrt{\left(x^{1/3} + \frac{1}{4}x^{-1/3}\right)^2} dx = \int_1^8 \left(x^{1/3} + \frac{1}{4}x^{-1/3}\right) dx \\
 &= \left[\frac{3}{4}x^{4/3} + \frac{3}{8}x^{2/3}\right]_1^8 = \frac{3}{8} \left[2x^{4/3} + x^{2/3}\right]_1^8 \\
 &= \frac{3}{8} \left[(2 \cdot 2^4 + 2^2) - (2 + 1)\right] = \frac{3}{8} (32 + 4 - 3) = \frac{99}{8}
 \end{aligned}$$

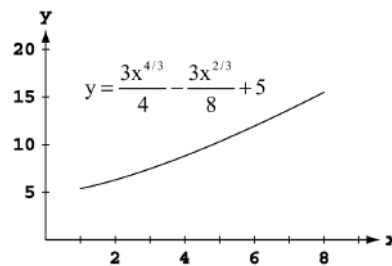

$$\begin{aligned}
 14. \quad \frac{dy}{dx} &= x^2 + 2x + 1 - \frac{4}{(4x+4)^2} = x^2 + 2x + 1 - \frac{1}{(1+x)^2} \\
 &= (1+x)^2 - \frac{1}{(1+x)^2} \Rightarrow \left(\frac{dy}{dx}\right)^2 = (1+x)^4 - \frac{1}{2} + \frac{1}{16(1+x)^4} \\
 &\Rightarrow L = \int_0^2 \sqrt{1 + (1+x)^4 - \frac{1}{2} + \frac{(1+x)^{-4}}{16}} dx \\
 &= \int_0^2 \sqrt{(1+x)^4 + \frac{1}{2} + \frac{(1+x)^{-4}}{16}} dx \\
 &= \int_0^2 \sqrt{\left[(1+x)^2 + \frac{(1+x)^{-2}}{4}\right]^2} dx \\
 &= \int_0^2 \left[(1+x)^2 + \frac{(1+x)^{-2}}{4}\right] dx; [u = 1+x \Rightarrow du = dx; x=0 \Rightarrow u=1, x=2 \Rightarrow u=3] \\
 &\rightarrow L = \int_1^3 \left(u^2 + \frac{1}{4}u^{-2}\right) du = \left[\frac{u^3}{3} - \frac{1}{4}u^{-1}\right]_1^3 = \left(9 - \frac{1}{12}\right) - \left(\frac{1}{3} - \frac{1}{4}\right) = \frac{108-1-4+3}{12} = \frac{106}{12} = \frac{53}{6}
 \end{aligned}$$

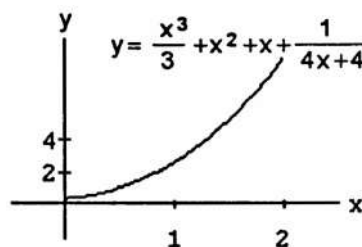

$$\begin{aligned}
 15. \quad \frac{dx}{dy} &= \sqrt{\sec^4 y - 1} \Rightarrow \left(\frac{dx}{dy}\right)^2 = \sec^4 y - 1 \\
 &\Rightarrow L = \int_{-\pi/4}^{\pi/4} \sqrt{1 + (\sec^4 y - 1)} dy = \int_{-\pi/4}^{\pi/4} \sec^2 y dy \\
 &= [\tan y]_{-\pi/4}^{\pi/4} = 1 - (-1) = 2
 \end{aligned}$$

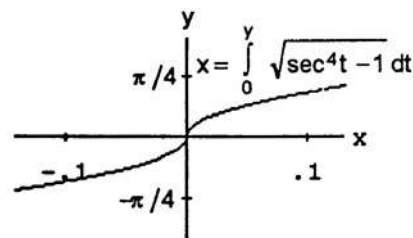

$$\begin{aligned}
 16. \quad \frac{dy}{dx} &= \sqrt{3x^4 - 1} \Rightarrow \left(\frac{dy}{dx}\right)^2 = 3x^4 - 1 \\
 &\Rightarrow L = \int_{-2}^{-1} \sqrt{1 + (3x^4 - 1)} dx = \int_{-2}^{-1} \sqrt{3} x^2 dx \\
 &= \sqrt{3} \left[\frac{x^3}{3}\right]_{-2}^{-1} = \frac{\sqrt{3}}{3} [-1 - (-2)^3] = \frac{\sqrt{3}}{3} (-1 + 8) = \frac{7\sqrt{3}}{3}
 \end{aligned}$$

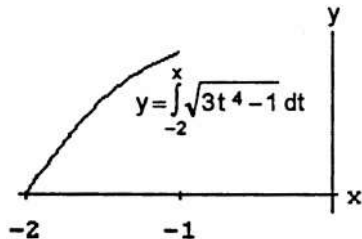

17. (a) $\frac{dy}{dx} = 2x \Rightarrow \left(\frac{dy}{dx}\right)^2 = 4x^2$
 $\Rightarrow L = \int_{-1}^2 \sqrt{1 + \left(\frac{dy}{dx}\right)^2} dx$
 $= \int_{-1}^2 \sqrt{1 + 4x^2} dx$
 (c) $L \approx 6.13$

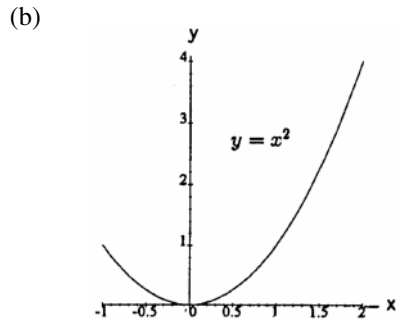

18. (a) $\frac{dy}{dx} = \sec^2 x \Rightarrow \left(\frac{dy}{dx}\right)^2 = \sec^4 x$
 $\Rightarrow L = \int_{-\pi/3}^0 \sqrt{1 + \sec^4 x} dx$
 (c) $L \approx 2.06$

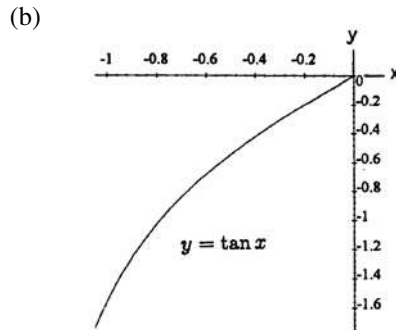

19. (a) $\frac{dx}{dy} = \cos y \Rightarrow \left(\frac{dx}{dy}\right)^2 = \cos^2 y$
 $\Rightarrow L = \int_0^\pi \sqrt{1 + \cos^2 y} dy$
 (c) $L \approx 3.82$

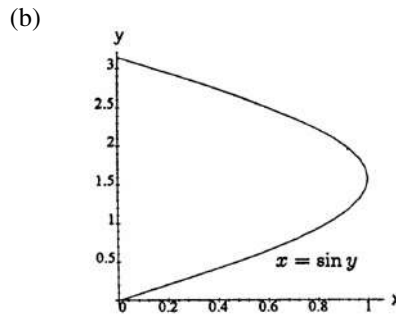

20. (a) $\frac{dx}{dy} = -\frac{y}{\sqrt{1-y^2}} \Rightarrow \left(\frac{dx}{dy}\right)^2 = \frac{y^2}{1-y^2}$
 $\Rightarrow L = \int_{-1/2}^{1/2} \sqrt{1 + \frac{y^2}{1-y^2}} dy = \int_{-1/2}^{1/2} \sqrt{\frac{1}{1-y^2}} dy$
 $= \int_{-1/2}^{1/2} (1-y^2)^{-1/2} dy$
 (c) $L \approx 1.05$

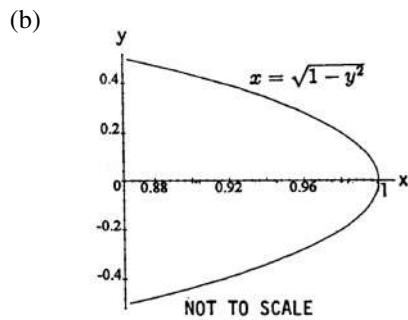

21. (a) $2y + 2 = 2 \frac{dx}{dy} \Rightarrow \left(\frac{dx}{dy}\right)^2 = (y + 1)^2$
 $\Rightarrow L = \int_{-1}^3 \sqrt{1 + (y + 1)^2} dy$
 (c) $L \approx 9.29$

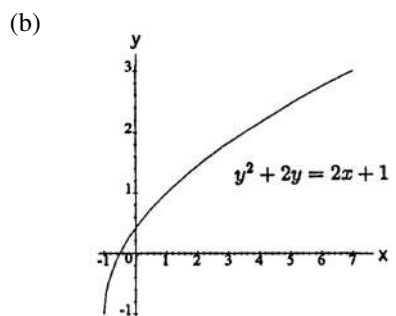

22. (a) $\frac{dy}{dx} = \cos x - \cos x + x \sin x \Rightarrow \left(\frac{dy}{dx}\right)^2 = x^2 \sin^2 x$
 $\Rightarrow L = \int_0^\pi \sqrt{1 + x^2 \sin^2 x} \, dx$
 (c) $L \approx 4.70$

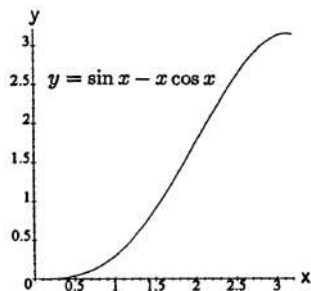

23. (a) $\frac{dy}{dx} = \tan x \Rightarrow \left(\frac{dy}{dx}\right)^2 = \tan^2 x$
 $\Rightarrow L = \int_0^{\pi/6} \sqrt{1 + \tan^2 x} \, dx = \int_0^{\pi/6} \sqrt{\frac{\sin^2 x + \cos^2 x}{\cos^2 x}} \, dx$
 $= \int_0^{\pi/6} \frac{dx}{\cos x} = \int_0^{\pi/6} \sec x \, dx$
 (c) $L \approx 0.55$

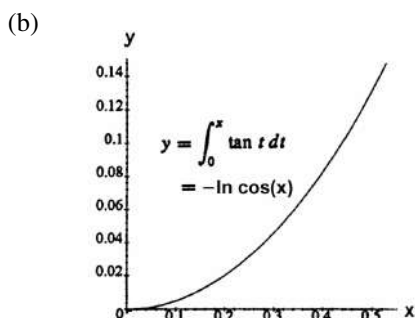

24. (a) $\frac{dx}{dy} = \sqrt{\sec^2 y - 1} \Rightarrow \left(\frac{dx}{dy}\right)^2 = \sec^2 y - 1$
 $\Rightarrow L = \int_{-\pi/3}^{\pi/4} \sqrt{1 + (\sec^2 y - 1)} \, dy$
 $= \int_{-\pi/3}^{\pi/4} |\sec y| \, dy = \int_{-\pi/3}^{\pi/4} \sec y \, dy$
 (c) $L \approx 2.20$

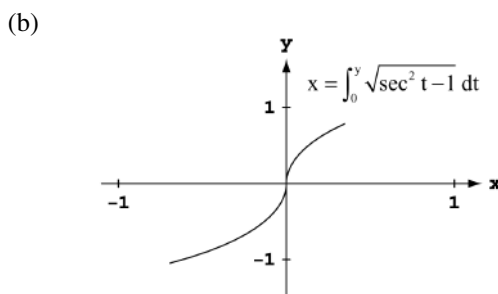

25. $\sqrt{2}x = \int_0^x \sqrt{1 + \left(\frac{dy}{dt}\right)^2} \, dt, x \geq 0 \Rightarrow \sqrt{2} = \sqrt{1 + \left(\frac{dy}{dx}\right)^2} \Rightarrow \frac{dy}{dx} = \pm 1 \Rightarrow y = f(x) = \pm x + C$ where C is any real number.

26. (a) From the accompanying figure and definition of the differential (change along the tangent line) we see that $dy = f'(x_{k-1}) \Delta x_k \Rightarrow$ length of k th tangent fin is $\sqrt{(\Delta x_k)^2 + (dy)^2} = \sqrt{(\Delta x_k)^2 + [f'(x_{k-1}) \Delta x_k]^2}$.

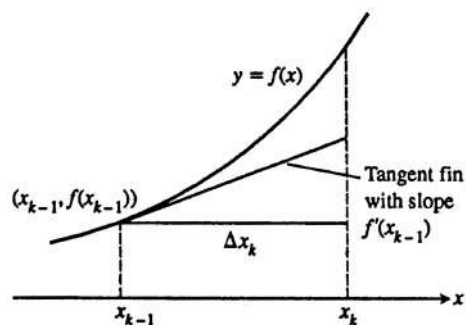

(b) Length of curve $= \lim_{n \rightarrow \infty} \sum_{k=1}^n (\text{length of } k\text{th tangent fin}) = \lim_{n \rightarrow \infty} \sum_{k=1}^n \sqrt{(\Delta x_k)^2 + [f'(x_{k-1}) \Delta x_k]^2}$
 $= \lim_{n \rightarrow \infty} \sum_{k=1}^n \sqrt{1 + [f'(x_{k-1})]^2} \Delta x_k = \int_a^b \sqrt{1 + [f'(x)]^2} \, dx$

27. (a) $\left(\frac{dy}{dx}\right)^2$ corresponds to $\frac{1}{4x}$ here, so take $\frac{dy}{dx}$ as $\frac{1}{2\sqrt{x}}$. Then $y = \sqrt{x} + C$ and since $(1, 1)$ lies on the curve, $C = 0$. So $y = \sqrt{x}$ from $(1, 1)$ to $(4, 2)$.
 (b) Only one. We know the derivative of the function and the value of the function at one value of x .

28. (a) $\left(\frac{dx}{dy}\right)^2$ corresponds to $\frac{1}{y^4}$ here, so take $\frac{dy}{dx}$ as $\frac{1}{y^2}$. Then $x = -\frac{1}{y} + C$ and, since $(0, 1)$ lies on the curve, $C = 1$
So $y = \frac{1}{1-x}$.

(b) Only one. We know the derivative of the function and the value of the function at one value of x .

29. (a) $\frac{dx}{dt} = -2 \sin 2t$ and $\frac{dy}{dt} = 2 \cos 2t \Rightarrow \sqrt{\left(\frac{dx}{dt}\right)^2 + \left(\frac{dy}{dt}\right)^2} = \sqrt{(-2 \sin 2t)^2 + (2 \cos 2t)^2} = 2$
 $\Rightarrow \text{Length} = \int_0^{\pi/2} 2 dt = [2t]_0^{\pi/2} = \pi$

(b) $\frac{dx}{dt} = \pi \cos \pi t$ and $\frac{dy}{dt} = -\pi \sin \pi t \Rightarrow \sqrt{\left(\frac{dx}{dt}\right)^2 + \left(\frac{dy}{dt}\right)^2} = \sqrt{(\pi \cos \pi t)^2 + (-\pi \sin \pi t)^2} = \pi$
 $\Rightarrow \text{Length} = \int_{-1/2}^{1/2} \pi dt = [\pi t]_{-1/2}^{1/2} = \pi$

30. $x = a(\theta - \sin \theta) \Rightarrow \frac{dx}{d\theta} = a(1 - \cos \theta) \Rightarrow \left(\frac{dx}{d\theta}\right)^2 = a^2(1 - 2 \cos \theta + \cos^2 \theta)$ and $y = a(1 - \cos \theta)$
 $\Rightarrow \frac{dy}{d\theta} = a \sin \theta \Rightarrow \left(\frac{dy}{d\theta}\right)^2 = a^2 \sin^2 \theta \Rightarrow \text{Length} = \int_0^{2\pi} \sqrt{\left(\frac{dx}{d\theta}\right)^2 + \left(\frac{dy}{d\theta}\right)^2} d\theta = \int_0^{2\pi} \sqrt{2a^2(1 - \cos \theta)} d\theta$
 $= a\sqrt{2} \int_0^{2\pi} \sqrt{2} \sqrt{\frac{1 - \cos \theta}{2}} d\theta = 2a \int_0^{2\pi} \left|\sin \frac{\theta}{2}\right| d\theta = 2a \int_0^{2\pi} \sin \frac{\theta}{2} d\theta = -4a \left[\cos \frac{\theta}{2}\right]_0^{2\pi} = 8a$

31-36. Example CAS commands:

Maple:

```
with( plots );
with( Student[Calculus1] );
with( student );
f := x -> sqrt(1-x^2); a := -1;
b := 1;
N := [2, 4, 8 ];
for n in N do
  xx := [seq( a+i*(b-a)/n, i=0..n )];
  pts := [seq([x,f(x)],x=xx)];
  L := simplify(add( distance(pts[i+1],pts[i]), i=1..n )); # (b)
  T := sprintf("#31(a) (Section 6.3)\nnn=%3d L=%8.5f\n", n, L );
  P[n] := plot( [f(x),pts], x=a..b, title=T ); # (a)
end do;
display( [seq(P[n],n=N)], insequence=true, scaling=constrained );
L := ArcLength( f(x), x=a..b, output=integral );
L = evalf( L ); # (c)
```

37-40. Example CAS commands:

Maple:

```
with( plots );
with( student );
x := t -> t^3/3;
y := t -> t^2/2;
a := 0;
b := 1;
N := [2, 4, 8 ];
for n in N do
  tt := [seq( a+i*(b-a)/n, i=0..n )];
  pts := [seq([x(t),y(t)],t=tt)];
```

```

L := simplify(add( student[distance](pts[i+1],pts[i]), i=1..n )); # (b)
T := sprintf("#37(a) (Section 6.3)\nn=%3d L=%8.5f\n", n, L);
P[n] := plot( [[x(t),y(t),t=a..b],pts], title=T); # (a)
end do:
display( [seq(P[n],n=N)], insequence=true );
ds := t -> sqrt( simplify(D(x)(t)^2 + D(y)(t)^2) ); # (c)
L := Int( ds(t), t=a..b );
L = evalf(L);

```

31-40. Example CAS commands:

Mathematica: (assigned function and values for a, b, and n may vary)

```

Clear[x, f]
{a, b} = {-1, 1}; f[x_] = Sqrt[1 - x^2]
p1 = Plot[f[x], {x, a, b}]
n = 8;
pts = Table[{xn, f[xn]}, {xn, a, b, (b - a)/n}]/N
Show[{p1, Graphics[{Line[pts]}]}]
Sum[ Sqrt[ (pts[[i + 1, 1]] - pts[[i, 1]])^2 + (pts[[i + 1, 2]] - pts[[i, 2]])^2 ], {i, 1, n} ]
NIntegrate[ Sqrt[ 1 + f[x]^2 ], {x, a, b} ]

```

6.4 MOMENTS AND CENTERS OF MASS

- Because the children are balanced, the moment of the system about the origin must be equal to zero:
 $5 \cdot 80 = x \cdot 100 \Rightarrow x = 4$ ft, the distance of the 100-lb child from the fulcrum.
- Suppose the log has length $2a$. Align the log along the x -axis so the 100-lb end is placed at $x = -a$ and the 200-lb end at $x = a$. Then the center of mass \bar{x} satisfies $\bar{x} = \frac{100(-a) + 200(a)}{300} \Rightarrow \bar{x} = \frac{a}{3}$. That is, \bar{x} is located at a distance $a - \frac{a}{3} = \frac{2a}{3} = \frac{1}{3}(2a)$ which is $\frac{1}{3}$ of the length of the log from the 200-lb (heavier) end (see figure) or $\frac{2}{3}$ of the way from the lighter end toward the heavier end.

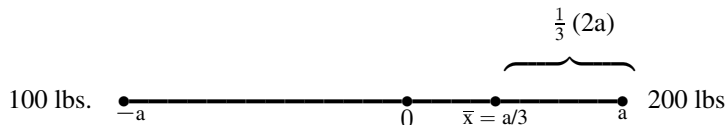

- The center of mass of each rod is in its center (see Example 1). The rod system is equivalent to two point masses located at the centers of the rods at coordinates $(\frac{1}{2}, 0)$ and $(0, \frac{1}{2})$. Therefore $\bar{x} = \frac{m_y}{m}$

$$= \frac{x_1 m_1 + x_2 m_2}{m_1 + m_2} = \frac{\frac{1}{2} \cdot m + 0}{m + m} = \frac{L}{4}$$
 and $\bar{y} = \frac{m_x}{m} = \frac{y_1 m_2 + y_2 m_1}{m_1 + m_2} = \frac{0 + \frac{1}{2} \cdot m}{m + m} = \frac{L}{4} \Rightarrow (\frac{L}{4}, \frac{L}{4})$ is the center of mass location.
- Let the rods have lengths $x = L$ and $y = 2L$. The center of mass of each rod is in its center (see Example 1). The rod system is equivalent to two point masses located at the centers of the rods at coordinates $(\frac{1}{2}, 0)$ and $(0, L)$. Therefore $\bar{x} = \frac{\frac{1}{2} \cdot m + 0 \cdot 2m}{m + 2m} = \frac{L}{6}$ and $\bar{y} = \frac{0 \cdot m + L \cdot 2m}{m + 2m} = \frac{2L}{3} \Rightarrow (\frac{L}{6}, \frac{2L}{3})$ is the center of mass location.
- $M_0 = \int_0^2 x \cdot 4 \, dx = \left[4 \frac{x^2}{2} \right]_0^2 = 4 \cdot \frac{4}{2} = 8$; $M = \int_0^2 4 \, dx = [4x]_0^2 = 4 \cdot 2 = 8 \Rightarrow \bar{x} = \frac{M_0}{M} = 1$
- $M_0 = \int_1^3 x \cdot 4 \, dx = \left[4 \frac{x^2}{2} \right]_1^3 = \frac{4}{2}(9 - 1) = 16$; $M = \int_1^3 4 \, dx = [4x]_1^3 = 12 - 4 = 8 \Rightarrow \bar{x} = \frac{M_0}{M} = \frac{16}{8} = 2$

$$7. M_0 = \int_0^3 x \left(1 + \frac{x}{3}\right) dx = \int_0^3 \left(x + \frac{x^2}{3}\right) dx = \left[\frac{x^2}{2} + \frac{x^3}{9}\right]_0^3 = \left(\frac{9}{2} + \frac{27}{9}\right) = \frac{15}{2}; M = \int_0^3 \left(1 + \frac{x}{3}\right) dx = \left[x + \frac{x^2}{6}\right]_0^3 = 3 + \frac{9}{6} = \frac{9}{2} \Rightarrow \bar{x} = \frac{M_0}{M} = \frac{(\frac{15}{2})}{(\frac{9}{2})} = \frac{15}{9} = \frac{5}{3}$$

$$8. M_0 = \int_0^4 x \left(2 - \frac{x}{4}\right) dx = \int_0^4 \left(2x - \frac{x^2}{4}\right) dx = \left[x^2 - \frac{x^3}{12}\right]_0^4 = \left(16 - \frac{64}{12}\right) = 16 - \frac{16}{3} = 16 \cdot \frac{2}{3} = \frac{32}{3}; M = \int_0^4 \left(2 - \frac{x}{4}\right) dx = \left[2x - \frac{x^2}{8}\right]_0^4 = 8 - \frac{16}{8} = 6 \Rightarrow \bar{x} = \frac{M_0}{M} = \frac{32}{3 \cdot 6} = \frac{16}{9}$$

$$9. M_0 = \int_1^4 x \left(1 + \frac{1}{\sqrt{x}}\right) dx = \int_1^4 \left(x + x^{1/2}\right) dx = \left[\frac{x^2}{2} + \frac{2x^{3/2}}{3}\right]_1^4 = \left(8 + \frac{16}{3}\right) - \left(\frac{1}{2} + \frac{2}{3}\right) = \frac{15}{2} + \frac{14}{3} = \frac{45+28}{6} = \frac{73}{6}; M = \int_1^4 \left(1 + x^{-1/2}\right) dx = \left[x + 2x^{1/2}\right]_1^4 = (4 + 4) - (1 + 2) = 5 \Rightarrow \bar{x} = \frac{M_0}{M} = \frac{(\frac{73}{6})}{5} = \frac{73}{30}$$

$$10. M_0 = \int_{1/4}^1 x \cdot 3 \left(x^{-3/2} + x^{-5/2}\right) dx = 3 \int_{1/4}^1 \left(x^{-1/2} + x^{-3/2}\right) dx = 3 \left[2x^{1/2} - \frac{2}{x^{1/2}}\right]_{1/4}^1 = 3 \left[(2 - 2) - \left(2 \cdot \frac{1}{2} - \frac{2}{(\frac{1}{2})}\right)\right] = 3(4 - 1) = 9; M = 3 \int_{1/4}^1 \left(x^{-3/2} + x^{-5/2}\right) dx = 3 \left[\frac{-2}{x^{1/2}} - \frac{2}{3x^{3/2}}\right]_{1/4}^1 = 3 \left[(-2 - \frac{2}{3}) - (-4 - \frac{16}{3})\right] = 3 \left(2 + \frac{14}{3}\right) = 6 + 14 = 20 \Rightarrow \bar{x} = \frac{M_0}{M} = \frac{9}{20}$$

$$11. M_0 = \int_0^1 x(2-x) dx + \int_1^2 x \cdot x dx = \int_0^1 (2x - x^2) dx + \int_1^2 x^2 dx = \left[\frac{2x^2}{2} - \frac{x^3}{3}\right]_0^1 + \left[\frac{x^3}{3}\right]_1^2 = \left(1 - \frac{1}{3}\right) + \left(\frac{8}{3} - \frac{1}{3}\right) = \frac{9}{3} = 3; M = \int_0^1 (2-x) dx + \int_1^2 x dx = \left[2x - \frac{x^2}{2}\right]_0^1 + \left[\frac{x^2}{2}\right]_1^2 = \left(2 - \frac{1}{2}\right) + \left(\frac{4}{2} - \frac{1}{2}\right) = 3 \Rightarrow \bar{x} = \frac{M_0}{M} = 1$$

$$12. M_0 = \int_0^1 x(x+1) dx + \int_1^2 2x dx = \int_0^1 (x^2 + x) dx + \int_1^2 2x dx = \left[\frac{x^3}{3} + \frac{x^2}{2}\right]_0^1 + [x^2]_1^2 = \left(\frac{1}{3} + \frac{1}{2}\right) + (4 - 1) = 3 + \frac{5}{6} = \frac{23}{6}; M = \int_0^1 (x+1) dx + \int_1^2 2 dx = \left[\frac{x^2}{2} + x\right]_0^1 + [2x]_1^2 = \left(\frac{1}{2} + 1\right) + (4 - 2) = 2 + \frac{3}{2} = \frac{7}{2} \Rightarrow \bar{x} = \frac{M_0}{M} = \left(\frac{23}{6}\right) \left(\frac{2}{7}\right) = \frac{23}{21}$$

13. Since the plate is symmetric about the y -axis and its density is constant, the distribution of mass is symmetric about the y -axis and the center of mass lies on the y -axis. This means that $\bar{x} = 0$. It remains to find $\bar{y} = \frac{M_x}{M}$. We model the distribution of mass with *vertical strips*. The typical strip has center of mass:

$$(\tilde{x}, \tilde{y}) = \left(x, \frac{x^2+4}{2}\right), \text{ length: } 4 - x^2, \text{ width: } dx, \text{ area:}$$

$$dA = (4 - x^2) dx, \text{ mass: } dm = \delta dA = \delta(4 - x^2) dx. \text{ The moment of the strip about the } x\text{-axis is}$$

$$\tilde{y} dm = \left(\frac{x^2+4}{2}\right) \delta(4 - x^2) dx = \frac{\delta}{2} (16 - x^4) dx. \text{ The moment of the plate about the } x\text{-axis is } M_x = \int \tilde{y} dm$$

$$= \int_{-2}^2 \frac{\delta}{2} (16 - x^4) dx = \frac{\delta}{2} \left[16x - \frac{x^5}{5}\right]_{-2}^2 = \frac{\delta}{2} \left[\left(16 \cdot 2 - \frac{2^5}{5}\right) - \left(-16 \cdot 2 + \frac{2^5}{5}\right)\right] = \frac{\delta \cdot 2}{2} \left(32 - \frac{32}{5}\right) = \frac{128\delta}{5}. \text{ The mass of the}$$

$$\text{plate is } M = \int \delta(4 - x^2) dx = \delta \left[4x - \frac{x^3}{3}\right]_{-2}^2 = 2\delta \left(8 - \frac{8}{3}\right) = \frac{32\delta}{3}. \text{ Therefore } \bar{y} = \frac{M_x}{M} = \frac{(\frac{128\delta}{5})}{(\frac{32\delta}{3})} = \frac{12}{5}. \text{ The plate's center of mass is the point } (\bar{x}, \bar{y}) = \left(0, \frac{12}{5}\right).$$

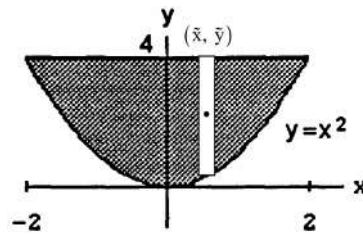

14. Applying the symmetry argument analogous to the one in Exercise 13, we find $\bar{x} = 0$. To find $\bar{y} = \frac{M_x}{M}$, we use the *vertical strips* technique. The typical strip has center of mass: $(\tilde{x}, \tilde{y}) = (x, \frac{25-x^2}{2})$, length: $25 - x^2$, width: dx , area: $dA = (25 - x^2)dx$, mass: $dm = \delta dA = \delta(25 - x^2) dx$. The moment of the strip about the x -axis is

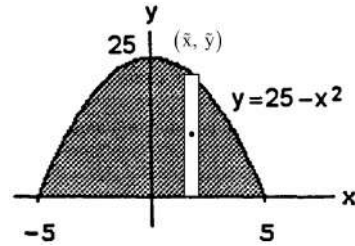

$$\begin{aligned} \tilde{y} dm &= \left(\frac{25-x^2}{2}\right) \delta(25 - x^2) dx = \frac{\delta}{2}(25 - x^2)^2 dx. \text{ The moment of the plate about the } x\text{-axis is } M_x = \int \tilde{y} dm \\ &= \int_{-5}^5 \frac{\delta}{2}(25 - x^2)^2 dx = \frac{\delta}{2} \int_{-5}^5 (625 - 50x^2 + x^4) dx = \frac{\delta}{2} \left[625x - \frac{50}{3}x^3 + \frac{x^5}{5}\right]_{-5}^5 = 2 \cdot \frac{\delta}{2} \left(625 \cdot 5 - \frac{50}{3} \cdot 5^3 + \frac{5^5}{5}\right) \\ &= \delta \cdot 625 \left(5 - \frac{10}{3} + 1\right) = \delta \cdot 625 \cdot \left(\frac{8}{3}\right). \text{ The mass of the plate is } M = \int dm = \int_{-5}^5 \delta(25 - x^2) dx = \delta \left[25x - \frac{x^3}{3}\right]_{-5}^5 \\ &= 2\delta \left(5^3 - \frac{5^3}{3}\right) = \frac{4}{3} \delta \cdot 5^3. \text{ Therefore } \bar{y} = \frac{M_x}{M} = \frac{\delta \cdot 5^4 \cdot (\frac{8}{3})}{\delta \cdot 5^3 \cdot (\frac{4}{3})} = 10. \text{ The plate's center of mass is the point } (\bar{x}, \bar{y}) = (0, 10). \end{aligned}$$

15. Intersection points: $x - x^2 = -x \Rightarrow 2x - x^2 = 0 \Rightarrow x(2 - x) = 0 \Rightarrow x = 0$ or $x = 2$. The typical *vertical strip* has center of mass: $(\tilde{x}, \tilde{y}) = (x, \frac{(x-x^2)+(-x)}{2}) = (x, -\frac{x^2}{2})$, length: $(x - x^2) - (-x) = 2x - x^2$, width: dx , area: $dA = (2x - x^2) dx$, mass: $dm = \delta dA = \delta(2x - x^2) dx$. The moment of the strip about the x -axis is

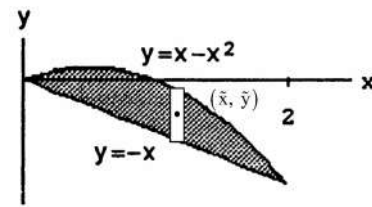

$$\begin{aligned} \tilde{y} dm &= \left(-\frac{x^2}{2}\right) \delta(2x - x^2) dx; \text{ about the } y\text{-axis it is } \tilde{x} dm = x \cdot \delta(2x - x^2) dx. \text{ Thus, } M_x = \int \tilde{y} dm \\ &= -\int_0^2 \left(\frac{\delta}{2}x^2\right)(2x - x^2) dx = -\frac{\delta}{2} \int_0^2 (2x^3 - x^4) dx = -\frac{\delta}{2} \left[\frac{x^4}{2} - \frac{x^5}{5}\right]_0^2 = -\frac{\delta}{2} \left(2^3 - \frac{2^5}{5}\right) = -\frac{\delta}{2} \cdot 2^3 \left(1 - \frac{4}{5}\right) \\ &= -\frac{4\delta}{5}; M_y = \int \tilde{x} dm = \int_0^2 x \cdot \delta(2x - x^2) dx = \delta \int_0^2 (2x^2 - x^3) dx = \delta \left[\frac{2}{3}x^3 - \frac{x^4}{4}\right]_0^2 = \delta \left(2 \cdot \frac{2^3}{3} - \frac{2^4}{4}\right) = \frac{\delta \cdot 2^4}{12} = \frac{4\delta}{3}; \\ M &= \int dm = \int_0^2 \delta(2x - x^2) dx = \delta \int_0^2 (2x - x^2) dx = \delta \left[x^2 - \frac{x^3}{3}\right]_0^2 = \delta \left(4 - \frac{8}{3}\right) = \frac{4\delta}{3}. \text{ Therefore, } \bar{x} = \frac{M_y}{M} \\ &= \left(\frac{4\delta}{3}\right) \left(\frac{3}{4\delta}\right) = 1 \text{ and } \bar{y} = \frac{M_x}{M} = \left(-\frac{4\delta}{5}\right) \left(\frac{3}{4\delta}\right) = -\frac{3}{5} \Rightarrow (\bar{x}, \bar{y}) = \left(1, -\frac{3}{5}\right) \text{ is the center of mass.} \end{aligned}$$

16. Intersection points: $x^2 - 3 = -2x^2 \Rightarrow 3x^2 - 3 = 0 \Rightarrow 3(x - 1)(x + 1) = 0 \Rightarrow x = -1$ or $x = 1$. Applying the symmetry argument analogous to the one in Exercise 13, we find $\bar{x} = 0$. The typical *vertical strip* has center of mass:

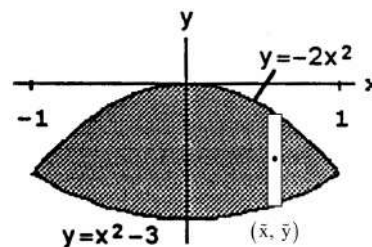

$$\begin{aligned} (\tilde{x}, \tilde{y}) &= \left(x, \frac{-2x^2+(x^2-3)}{2}\right) = \left(x, \frac{-x^2-3}{2}\right), \\ \text{length: } &-2x^2 - (x^2 - 3) = 3(1 - x^2), \text{ width: } dx, \\ \text{area: } &dA = 3(1 - x^2) dx, \text{ mass: } dm = \delta dA = 3\delta(1 - x^2) dx. \\ \text{The moment of the strip about the } x\text{-axis is} \\ \tilde{y} dm &= \frac{3}{2} \delta(-x^2 - 3)(1 - x^2) dx = \frac{3}{2} \delta(x^4 + 3x^2 - x^2 - 3) dx = \frac{3}{2} \delta(x^4 + 2x^2 - 3) dx; M_x = \int \tilde{y} dm \\ &= \frac{3}{2} \delta \int_{-1}^1 (x^4 + 2x^2 - 3) dx = \frac{3}{2} \delta \left[\frac{x^5}{5} + \frac{2x^3}{3} - 3x\right]_{-1}^1 = \frac{3}{2} \cdot \delta \cdot 2 \left(\frac{1}{5} + \frac{2}{3} - 3\right) = 3\delta \left(\frac{3+10-45}{15}\right) = -\frac{32\delta}{5}; \\ M &= \int dm = 3\delta \int_{-1}^1 (1 - x^2) dx = 3\delta \left[x - \frac{x^3}{3}\right]_{-1}^1 = 3\delta \cdot 2 \left(1 - \frac{1}{3}\right) = 4\delta. \text{ Therefore, } \bar{y} = \frac{M_x}{M} = -\frac{\delta \cdot 32}{5 \cdot \delta \cdot 4} = -\frac{8}{5} \\ &\Rightarrow (\bar{x}, \bar{y}) = \left(0, -\frac{8}{5}\right) \text{ is the center of mass.} \end{aligned}$$

17. The typical *horizontal* strip has center of mass:

$$(\tilde{x}, \tilde{y}) = \left(\frac{y-y^3}{2}, y \right), \text{ length: } y - y^3, \text{ width: } dy,$$

$$\text{area: } dA = (y - y^3) dy, \text{ mass: } dm = \delta dA = \delta (y - y^3) dy.$$

The moment of the strip about the y-axis is

$$\tilde{x} dm = \delta \left(\frac{y-y^3}{2} \right) (y - y^3) dy = \frac{\delta}{2} (y - y^3)^2 dy$$

$$= \frac{\delta}{2} (y^2 - 2y^4 + y^6) dy; \text{ the moment about the x-axis is}$$

$$\tilde{y} dm = \delta y (y - y^3) dy = \delta (y^2 - y^4) dy. \text{ Thus, } M_x = \int \tilde{y} dm = \delta \int_0^1 (y^2 - y^4) dy = \delta \left[\frac{y^3}{3} - \frac{y^5}{5} \right]_0^1 = \delta \left(\frac{1}{3} - \frac{1}{5} \right) = \frac{2\delta}{15};$$

$$M_y = \int \tilde{x} dm = \frac{\delta}{2} \int_0^1 (y^2 - 2y^4 + y^6) dy = \frac{\delta}{2} \left[\frac{y^3}{3} - \frac{2y^5}{5} + \frac{y^7}{7} \right]_0^1 = \frac{\delta}{2} \left(\frac{1}{3} - \frac{2}{5} + \frac{1}{7} \right) = \frac{\delta}{2} \left(\frac{35-42+15}{3 \cdot 5 \cdot 7} \right) = \frac{4\delta}{105}; M = \int dm$$

$$= \delta \int_0^1 (y - y^3) dy = \delta \left[\frac{y^2}{2} - \frac{y^4}{4} \right]_0^1 = \delta \left(\frac{1}{2} - \frac{1}{4} \right) = \frac{\delta}{4}. \text{ Therefore, } \bar{x} = \frac{M_y}{M} = \left(\frac{4\delta}{105} \right) \left(\frac{4}{\delta} \right) = \frac{16}{105} \text{ and } \bar{y} = \frac{M_x}{M} = \left(\frac{2\delta}{15} \right) \left(\frac{4}{\delta} \right)$$

$$= \frac{8}{15} \Rightarrow (\bar{x}, \bar{y}) = \left(\frac{16}{105}, \frac{8}{15} \right) \text{ is the center of mass.}$$

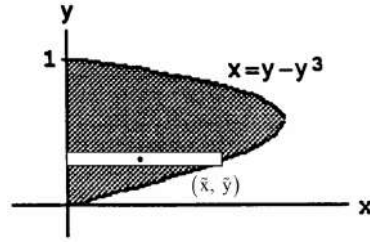

18. Intersection points: $y = y^2 - y \Rightarrow y^2 - 2y = 0$

$$\Rightarrow y(y - 2) = 0 \Rightarrow y = 0 \text{ or } y = 2. \text{ The typical}$$

horizontal strip has center of mass:

$$(\tilde{x}, \tilde{y}) = \left(\frac{(y^2-y)+y}{2}, y \right) = \left(\frac{y^2}{2}, y \right),$$

$$\text{length: } y - (y^2 - y) = 2y - y^2, \text{ width: } dy,$$

$$\text{area: } dA = (2y - y^2) dy, \text{ mass: } dm = \delta dA = \delta (2y - y^2) dy.$$

The moment about the y-axis is $\tilde{x} dm = \frac{\delta}{2} \cdot y^2 (2y - y^2) dy$

$$= \frac{\delta}{2} (2y^3 - y^4) dy; \text{ the moment about the x-axis is } \tilde{y} dm = \delta y (2y - y^2) dy = \delta (2y^2 - y^3) dy. \text{ Thus,}$$

$$M_x = \int \tilde{y} dm = \int_0^2 \delta (2y^2 - y^3) dy = \delta \left[\frac{2y^3}{3} - \frac{y^4}{4} \right]_0^2 = \delta \left(\frac{16}{3} - \frac{16}{4} \right) = \frac{16\delta}{12} (4 - 3) = \frac{4\delta}{3}; M_y = \int \tilde{x} dm$$

$$= \int_0^2 \frac{\delta}{2} (2y^3 - y^4) dy = \frac{\delta}{2} \left[\frac{y^4}{2} - \frac{y^5}{5} \right]_0^2 = \frac{\delta}{2} \left(8 - \frac{32}{5} \right) = \frac{\delta}{2} \left(\frac{40-32}{5} \right) = \frac{4\delta}{5}; M = \int dm = \int_0^2 \delta (2y - y^2) dy$$

$$= \delta \left[y^2 - \frac{y^3}{3} \right]_0^2 = \delta \left(4 - \frac{8}{3} \right) = \frac{4\delta}{3}. \text{ Therefore, } \bar{x} = \frac{M_y}{M} = \left(\frac{4\delta}{5} \right) \left(\frac{3}{4\delta} \right) = \frac{3}{5} \text{ and } \bar{y} = \frac{M_x}{M} = \left(\frac{4\delta}{3} \right) \left(\frac{3}{4\delta} \right) = 1$$

$$\Rightarrow (\bar{x}, \bar{y}) = \left(\frac{3}{5}, 1 \right) \text{ is the center of mass.}$$

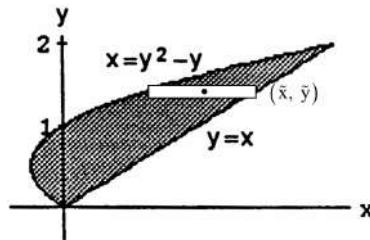

19. Applying the symmetry argument analogous to the one used

in Exercise 13, we find $\bar{x} = 0$. The typical *vertical* strip has

center of mass: $(\tilde{x}, \tilde{y}) = \left(x, \frac{\cos x}{2} \right)$, length: $\cos x$, width: dx ,

area: $dA = \cos x dx$, mass: $dm = \delta dA = \delta \cos x dx$. The

moment of the strip about the x-axis is $\tilde{y} dm = \delta \cdot \frac{\cos x}{2} \cdot \cos x dx$

$$= \frac{\delta}{2} \cos^2 x dx = \frac{\delta}{2} \left(\frac{1 + \cos 2x}{2} \right) dx = \frac{\delta}{4} (1 + \cos 2x) dx; \text{ thus,}$$

$$M_x = \int \tilde{y} dm = \int_{-\pi/2}^{\pi/2} \frac{\delta}{4} (1 + \cos 2x) dx = \frac{\delta}{4} \left[x + \frac{\sin 2x}{2} \right]_{-\pi/2}^{\pi/2} = \frac{\delta}{4} \left[\left(\frac{\pi}{2} + 0 \right) - \left(-\frac{\pi}{2} \right) \right] = \frac{\delta\pi}{4}; M = \int dm = \delta \int_{-\pi/2}^{\pi/2} \cos x dx$$

$$= \delta [\sin x]_{-\pi/2}^{\pi/2} = 2\delta. \text{ Therefore, } \bar{y} = \frac{M_x}{M} = \frac{\delta\pi}{4 \cdot 2\delta} = \frac{\pi}{8} \Rightarrow (\bar{x}, \bar{y}) = \left(0, \frac{\pi}{8} \right) \text{ is the center of mass.}$$

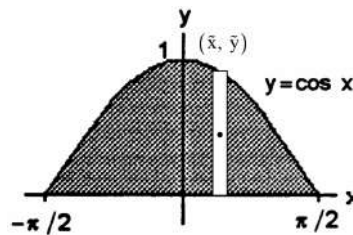

20. Applying the symmetry argument analogous to the one used

in Exercise 13, we find $\bar{x} = 0$. The typical *vertical* strip has

center of mass: $(\tilde{x}, \tilde{y}) = \left(x, \frac{\sec^2 x}{2} \right)$, length: $\sec^2 x$, width: dx ,

area: $dA = \sec^2 x dx$, mass: $dm = \delta dA = \delta \sec^2 x dx$. The

moment about the x-axis is $\tilde{y} dm = \left(\frac{\sec^2 x}{2} \right) (\delta \sec^2 x) dx$

$$= \frac{\delta}{2} \sec^4 x dx. M_x = \int_{-\pi/4}^{\pi/4} \tilde{y} dm = \frac{\delta}{2} \int_{-\pi/4}^{\pi/4} \sec^4 x dx$$

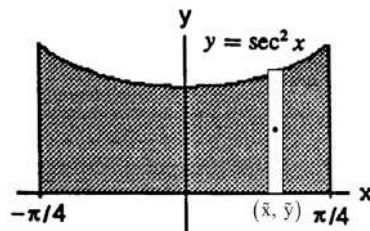

$$\begin{aligned}
 &= \frac{\delta}{2} \int_{-\pi/4}^{\pi/4} (\tan^2 x + 1) (\sec^2 x) dx = \frac{\delta}{2} \int_{-\pi/4}^{\pi/4} (\tan x)^2 (\sec^2 x) dx + \frac{\delta}{2} \int_{-\pi/4}^{\pi/4} \sec^2 x dx = \frac{\delta}{2} \left[\frac{(\tan x)^3}{3} \right]_{-\pi/4}^{\pi/4} + \frac{\delta}{2} [\tan x]_{-\pi/4}^{\pi/4} \\
 &= \frac{\delta}{2} \left[\frac{1}{3} - \left(-\frac{1}{3}\right) \right] + \frac{\delta}{2} [1 - (-1)] = \frac{\delta}{3} + \delta = \frac{4\delta}{3}; M = \int dm = \delta \int_{-\pi/4}^{\pi/4} \sec^2 x dx = \delta [\tan x]_{-\pi/4}^{\pi/4} = \delta [1 - (-1)] = 2\delta. \\
 &\text{Therefore, } \bar{y} = \frac{M_x}{M} = \left(\frac{4\delta}{3}\right) \left(\frac{1}{2\delta}\right) = \frac{2}{3} \Rightarrow (\bar{x}, \bar{y}) = \left(0, \frac{2}{3}\right) \text{ is the center of mass.}
 \end{aligned}$$

21. Since the plate is symmetric about the line $x = 1$ and its density is constant, the distribution of mass is symmetric about this line and the center of mass lies on it. This means that $\bar{x} = 1$. The typical vertical strip has center of mass:

$$(\tilde{x}, \tilde{y}) = \left(x, \frac{(2x-x^2)+(2x^2-4x)}{2}\right) = \left(x, \frac{x^2-2x}{2}\right),$$

length: $(2x - x^2) - (2x^2 - 4x) = -3x^2 + 6x = 3(2x - x^2)$,

width: dx , area: $dA = 3(2x - x^2) dx$, mass: $dm = \delta dA = 3\delta(2x - x^2) dx$. The moment about the x -axis is

$$\tilde{y} dm = \frac{3}{2} \delta (x^2 - 2x)(2x - x^2) dx = -\frac{3}{2} \delta (x^2 - 2x)^2 dx$$

$$= -\frac{3}{2} \delta (x^4 - 4x^3 + 4x^2) dx. \text{ Thus, } M_x = \int \tilde{y} dm = -\int_0^2 \frac{3}{2} \delta (x^4 - 4x^3 + 4x^2) dx = -\frac{3}{2} \delta \left[\frac{x^5}{5} - x^4 + \frac{4}{3} x^3 \right]_0^2$$

$$= -\frac{3}{2} \delta \left(\frac{2^5}{5} - 2^4 + \frac{4}{3} \cdot 2^3 \right) = -\frac{3}{2} \delta \cdot 2^4 \left(\frac{2}{5} - 1 + \frac{2}{3} \right) = -\frac{3}{2} \delta \cdot 2^4 \left(\frac{6-15+10}{15} \right) = -\frac{8\delta}{5}; M = \int dm$$

$$= \int_0^2 3\delta(2x - x^2) dx = 3\delta \left[x^2 - \frac{x^3}{3} \right]_0^2 = 3\delta \left(4 - \frac{8}{3} \right) = 4\delta. \text{ Therefore, } \bar{y} = \frac{M_x}{M} = \left(-\frac{8\delta}{5}\right) \left(\frac{1}{4\delta}\right) = -\frac{2}{5}$$

$$\Rightarrow (\bar{x}, \bar{y}) = \left(1, -\frac{2}{5}\right) \text{ is the center of mass.}$$

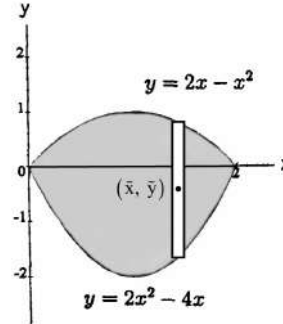

22. (a) Since the plate is symmetric about the line $x = y$ and its density is constant, the distribution of mass is symmetric about this line. This means that $\bar{x} = \bar{y}$. The typical vertical strip has center of mass:

$$(\tilde{x}, \tilde{y}) = \left(x, \frac{\sqrt{9-x^2}}{2}\right), \text{ length: } \sqrt{9-x^2}, \text{ width: } dx,$$

area: $dA = \sqrt{9-x^2} dx$,

mass: $dm = \delta dA = \delta \sqrt{9-x^2} dx$.

The moment about the x -axis is

$$\tilde{y} dm = \delta \left(\frac{\sqrt{9-x^2}}{2}\right) \sqrt{9-x^2} dx = \frac{\delta}{2} (9-x^2) dx. \text{ Thus, } M_x = \int \tilde{y} dm = \int_0^3 \frac{\delta}{2} (9-x^2) dx = \frac{\delta}{2} \left[9x - \frac{x^3}{3} \right]_0^3$$

$$= \frac{\delta}{2} (27-9) = 9\delta; M = \int dm = \int \delta dA = \delta \int dA = \delta (\text{Area of a quarter of a circle of radius 3}) = \delta \left(\frac{9\pi}{4}\right) = \frac{9\pi\delta}{4}.$$

Therefore, $\bar{y} = \frac{M_x}{M} = (9\delta) \left(\frac{4}{9\pi\delta}\right) = \frac{4}{\pi} \Rightarrow (\bar{x}, \bar{y}) = \left(\frac{4}{\pi}, \frac{4}{\pi}\right)$ is the center of mass.

- (b) Applying the symmetry argument analogous to the one used in Exercise 13, we find that $\bar{x} = 0$. The typical vertical strip has the same parameters as in part (a).

$$\text{Thus, } M_x = \int \tilde{y} dm = \int_{-3}^3 \frac{\delta}{2} (9-x^2) dx$$

$$= 2 \int_0^3 \frac{\delta}{2} (9-x^2) dx = 2(9\delta) = 18\delta;$$

$$M = \int dm = \int \delta dA = \delta \int dA$$

$$= \delta (\text{Area of a semi-circle of radius 3}) = \delta \left(\frac{9\pi}{2}\right) = \frac{9\pi\delta}{2}. \text{ Therefore, } \bar{y} = \frac{M_x}{M} = (18\delta) \left(\frac{2}{9\pi\delta}\right) = \frac{4}{\pi}, \text{ the same } \bar{y}$$

as in part (a) $\Rightarrow (\bar{x}, \bar{y}) = \left(0, \frac{4}{\pi}\right)$ is the center of mass.

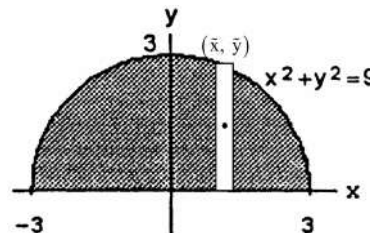
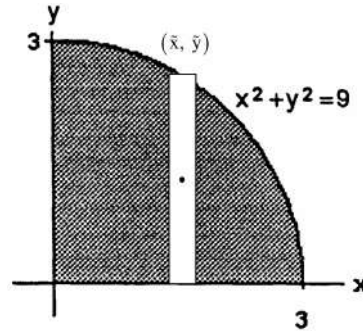

23. Since the plate is symmetric about the line $x = y$ and its density is constant, the distribution of mass is symmetric about this line. This means that $\bar{x} = \bar{y}$. The typical *vertical* strip has

center of mass: $(\tilde{x}, \tilde{y}) = \left(x, \frac{3 + \sqrt{9 - x^2}}{2}\right)$,

length: $3 - \sqrt{9 - x^2}$, width: dx ,

area: $dA = (3 - \sqrt{9 - x^2}) dx$,

mass: $dm = \delta dA = \delta (3 - \sqrt{9 - x^2}) dx$.

The moment about the x -axis is

$\tilde{y} dm = \delta \frac{(3 + \sqrt{9 - x^2})(3 - \sqrt{9 - x^2})}{2} dx = \frac{\delta}{2} [9 - (9 - x^2)] dx = \frac{\delta x^2}{2} dx$. Thus, $M_x = \int_0^3 \frac{\delta x^2}{2} dx = \frac{\delta}{6} [x^3]_0^3 = \frac{9\delta}{2}$. The area equals the area of a square with side length 3 minus one quarter the area of a disk with radius 3 $\Rightarrow A = 3^2 - \frac{\pi 9}{4} = \frac{9}{4}(4 - \pi) \Rightarrow M = \delta A = \frac{9\delta}{4}(4 - \pi)$. Therefore, $\bar{y} = \frac{M_x}{M} = \left(\frac{9\delta}{2}\right) \left[\frac{4}{9\delta(4 - \pi)}\right] = \frac{2}{4 - \pi} \Rightarrow (\bar{x}, \bar{y}) = \left(\frac{2}{4 - \pi}, \frac{2}{4 - \pi}\right)$ is the center of mass.

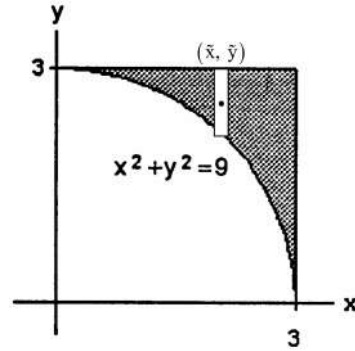

24. Applying the symmetry argument analogous to the one used in Exercise 13, we find that $\bar{y} = 0$. The typical *vertical* strip

has center of mass: $(\tilde{x}, \tilde{y}) = \left(x, \frac{\frac{1}{x^3} - (-\frac{1}{x^3})}{2}\right) = (x, 0)$,

length: $\frac{1}{x^3} - (-\frac{1}{x^3}) = \frac{2}{x^3}$, width: dx , area: $dA = \frac{2}{x^3} dx$,

mass: $dm = \delta dA = \frac{2\delta}{x^3} dx$. The moment about the y -axis is

$\tilde{x} dm = x \cdot \frac{2\delta}{x^3} dx = \frac{2\delta}{x^2} dx$. Thus, $M_y = \int_1^a \frac{2\delta}{x^2} dx$

$= 2\delta \left[-\frac{1}{x}\right]_1^a = 2\delta \left(-\frac{1}{a} + 1\right) = \frac{2\delta(a-1)}{a}$; $M = \int dm = \int_1^a \frac{2\delta}{x^3} dx = \delta \left[-\frac{1}{x^2}\right]_1^a = \delta \left(-\frac{1}{a^2} + 1\right) = \frac{\delta(a^2-1)}{a^2}$. Therefore,

$\bar{x} = \frac{M_y}{M} = \left[\frac{2\delta(a-1)}{a}\right] \left[\frac{a^2}{\delta(a^2-1)}\right] = \frac{2a}{a+1} \Rightarrow (\bar{x}, \bar{y}) = \left(\frac{2a}{a+1}, 0\right)$. Also, $\lim_{a \rightarrow \infty} \bar{x} = 2$.

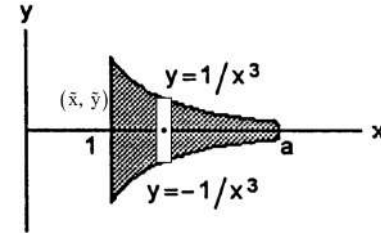

25. $M_x = \int \tilde{y} dm = \int_1^2 \left(\frac{\frac{2}{x^2}}{2}\right) \cdot \delta \cdot \left(\frac{2}{x^2}\right) dx$
 $= \int_1^2 \left(\frac{1}{x^2}\right) (x^2) \left(\frac{2}{x^2}\right) dx = \int_1^2 \frac{2}{x^2} dx = 2 \int_1^2 x^{-2} dx$
 $= 2 \left[-x^{-1}\right]_1^2 = 2 \left[\left(-\frac{1}{2}\right) - (-1)\right] = 2 \left(\frac{1}{2}\right) = 1;$

$M_y = \int \tilde{x} dm = \int_1^2 x \cdot \delta \cdot \left(\frac{2}{x^2}\right) dx$

$= \int_1^2 x (x^2) \left(\frac{2}{x^2}\right) dx = 2 \int_1^2 x dx = 2 \left[\frac{x^2}{2}\right]_1^2$

$= 2 \left(2 - \frac{1}{2}\right) = 4 - 1 = 3;$ $M = \int dm = \int_1^2 \delta \left(\frac{2}{x^2}\right) dx = \int_1^2 x^2 \left(\frac{2}{x^2}\right) dx = 2 \int_1^2 dx = 2[x]_1^2 = 2(2 - 1) = 2$. So

$\bar{x} = \frac{M_y}{M} = \frac{3}{2}$ and $\bar{y} = \frac{M_x}{M} = \frac{1}{2} \Rightarrow (\bar{x}, \bar{y}) = \left(\frac{3}{2}, \frac{1}{2}\right)$ is the center of mass.

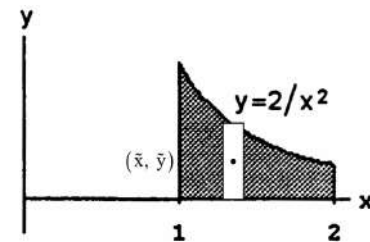

26. We use the *vertical* strip approach:

$M_x = \int \tilde{y} dm = \int_0^1 \frac{(x+x^2)}{2} (x - x^2) \cdot \delta dx$

$= \frac{1}{2} \int_0^1 (x^2 - x^4) \cdot 12x dx$

$= 6 \int_0^1 (x^3 - x^5) dx = 6 \left[\frac{x^4}{4} - \frac{x^6}{6}\right]_0^1$

$= 6 \left(\frac{1}{4} - \frac{1}{6}\right) = \frac{6}{4} - 1 = \frac{1}{2};$

$M_y = \int \tilde{x} dm = \int_0^1 x (x - x^2) \cdot \delta dx = \int_0^1 (x^2 - x^3) \cdot 12x dx = 12 \int_0^1 (x^3 - x^4) dx = 12 \left[\frac{x^4}{4} - \frac{x^5}{5}\right]_0^1 = 12 \left(\frac{1}{4} - \frac{1}{5}\right)$

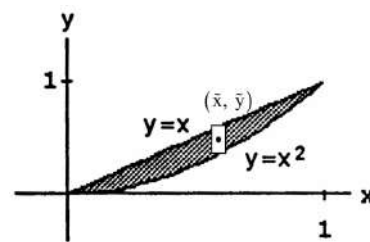

$$= \frac{12}{20} = \frac{3}{5}; M = \int dm = \int_0^1 (x - x^2) \cdot \delta dx = 12 \int_0^1 (x^2 - x^3) dx = 12 \left[\frac{x^3}{3} - \frac{x^4}{4} \right]_0^1 = 12 \left(\frac{1}{3} - \frac{1}{4} \right) = \frac{12}{12} = 1. \text{ So}$$

$$\bar{x} = \frac{M_y}{M} = \frac{3}{5} \text{ and } \bar{y} = \frac{M_x}{M} = \frac{1}{2} \Rightarrow \left(\frac{3}{5}, \frac{1}{2} \right) \text{ is the center of mass.}$$

27. (a) We use the shell method: $V = \int_a^b 2\pi (\text{shell radius}) (\text{shell height}) dx = \int_1^4 2\pi x \left[\frac{4}{\sqrt{x}} - \left(-\frac{4}{\sqrt{x}} \right) \right] dx$
 $= 16\pi \int_1^4 \frac{x}{\sqrt{x}} dx = 16\pi \int_1^4 x^{1/2} dx = 16\pi \left[\frac{2}{3} x^{3/2} \right]_1^4 = 16\pi \left(\frac{2}{3} \cdot 8 - \frac{2}{3} \right) = \frac{32\pi}{3} (8 - 1) = \frac{224\pi}{3}$

(b) Since the plate is symmetric about the x-axis and its density $\delta(x) = \frac{1}{x}$ is a function of x alone, the distribution of its mass is symmetric about the x-axis. This means that $\bar{y} = 0$. We use the vertical strip approach to find \bar{x} : $M_y = \int \tilde{x} dm = \int_1^4 x \cdot \left[\frac{4}{\sqrt{x}} - \left(-\frac{4}{\sqrt{x}} \right) \right] \cdot \delta dx = \int_1^4 x \cdot \frac{8}{\sqrt{x}} \cdot \frac{1}{x} dx = 8 \int_1^4 x^{-1/2} dx$
 $= 8 \left[2x^{1/2} \right]_1^4 = 8(2 \cdot 2 - 2) = 16$; $M = \int dm = \int_1^4 \left[\frac{4}{\sqrt{x}} - \left(-\frac{4}{\sqrt{x}} \right) \right] \cdot \delta dx = 8 \int_1^4 \left(\frac{1}{\sqrt{x}} \right) \left(\frac{1}{x} \right) dx = 8 \int_1^4 x^{-3/2} dx$
 $= 8 \left[-2x^{-1/2} \right]_1^4 = 8[-1 - (-2)] = 8$. So $\bar{x} = \frac{M_y}{M} = \frac{16}{8} = 2 \Rightarrow (\bar{x}, \bar{y}) = (2, 0)$ is the center of mass.

(c)

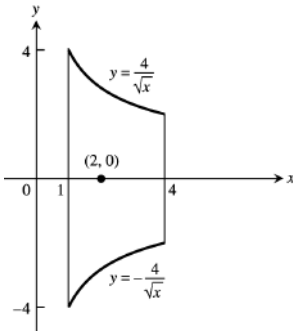

28. (a) We use the disk method: $V = \int_a^b \pi R^2(x) dx = \int_1^4 \pi \left(\frac{4}{x^2} \right) dx = 4\pi \int_1^4 x^{-2} dx = 4\pi \left[-\frac{1}{x} \right]_1^4$
 $= 4\pi \left[\frac{-1}{4} - (-1) \right] = \pi[-1 + 4] = 3\pi$

(b) We model the distribution of mass with vertical strips: $M_x = \int \tilde{y} dm = \int_1^4 \frac{2}{x} \cdot \left(\frac{2}{x} \right) \cdot \delta dx = \int_1^4 \frac{2}{x^2} \cdot \sqrt{x} dx$
 $= 2 \int_1^4 x^{-3/2} dx = 2 \left[\frac{-2}{\sqrt{x}} \right]_1^4 = 2[-1 - (-2)] = 2$; $M_y = \int \tilde{x} dm = \int_1^4 x \cdot \frac{2}{x} \cdot \delta dx = 2 \int_1^4 x^{1/2} dx$
 $= 2 \left[\frac{2x^{3/2}}{3} \right]_1^4 = 2 \left[\frac{16}{3} - \frac{2}{3} \right] = \frac{28}{3}$; $M = \int dm = \int_1^4 \frac{2}{x} \cdot \delta dx = 2 \int_1^4 \frac{\sqrt{x}}{x} dx = 2 \int_1^4 x^{-1/2} dx = 2 \left[2x^{1/2} \right]_1^4$
 $= 2(4 - 2) = 4$. So $\bar{x} = \frac{M_y}{M} = \frac{(28/3)}{4} = \frac{7}{3}$ and $\bar{y} = \frac{M_x}{M} = \frac{2}{4} = \frac{1}{2} \Rightarrow (\bar{x}, \bar{y}) = \left(\frac{7}{3}, \frac{1}{2} \right)$ is the center of mass.

(c)

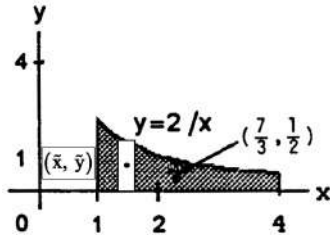

29. The mass of a horizontal strip is $dm = \delta dA = \delta L dy$, where L is the width of the triangle at a distance of y above its base on the x-axis as shown in the figure in the text. Also, by similar triangles we have $\frac{L}{b} = \frac{h-y}{h}$

$$\Rightarrow L = \frac{b}{h}(h-y). \text{ Thus, } M_x = \int \tilde{y} dm = \int_0^h \delta y \left(\frac{b}{h} \right) (h-y) dy = \frac{\delta b}{h} \int_0^h (hy - y^2) dy = \frac{\delta b}{h} \left[\frac{hy^2}{2} - \frac{y^3}{3} \right]_0^h$$

$$= \frac{\delta b}{h} \left(\frac{h^3}{2} - \frac{h^3}{3} \right) = \delta bh^2 \left(\frac{1}{2} - \frac{1}{3} \right) = \frac{\delta bh^2}{6}; M = \int dm = \int_0^h \delta \left(\frac{b}{h} \right) (h-y) dy = \frac{\delta b}{h} \int_0^h (h-y) dy = \frac{\delta b}{h} \left[hy - \frac{y^2}{2} \right]_0^h$$

$$= \frac{\delta b}{h} \left(h^2 - \frac{h^2}{2} \right) = \frac{\delta bh}{2}. \text{ So } \bar{y} = \frac{M_x}{M} = \left(\frac{\delta bh^2}{6} \right) \left(\frac{2}{\delta bh} \right) = \frac{h}{3} \Rightarrow \text{the center of mass lies above the base of the}$$

triangle one-third of the way toward the opposite vertex. Similarly the other two sides of the triangle can be placed on the x-axis and the same results will occur. Therefore the centroid does lie at the intersection of the medians, as claimed.

30. From the symmetry about the y-axis it follows that $\bar{x} = 0$. It also follows that the line through the points $(0, 0)$ and $(0, 3)$ is a median $\Rightarrow \bar{y} = \frac{1}{3}(3 - 0) = 1 \Rightarrow (\bar{x}, \bar{y}) = (0, 1)$.

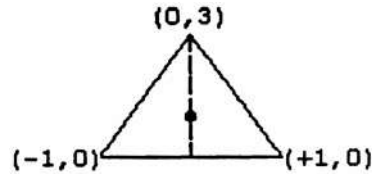

31. From the symmetry about the line $x = y$ it follows that $\bar{x} = \bar{y}$. It also follows that the line through the points $(0, 0)$ and $(\frac{1}{2}, \frac{1}{2})$ is a median $\Rightarrow \bar{y} = \bar{x} = \frac{2}{3} \cdot (\frac{1}{2} - 0) = \frac{1}{3} \Rightarrow (\bar{x}, \bar{y}) = (\frac{1}{3}, \frac{1}{3})$.

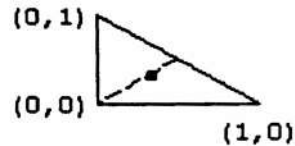

32. From the symmetry about the line $x = y$ it follows that $\bar{x} = \bar{y}$. It also follows that the line through the point $(0, 0)$ and $(\frac{a}{2}, \frac{a}{2})$ is a median $\Rightarrow \bar{y} = \bar{x} = \frac{2}{3} (\frac{a}{2} - 0) = \frac{1}{3} a \Rightarrow (\bar{x}, \bar{y}) = (\frac{a}{3}, \frac{a}{3})$.

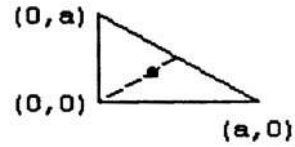

33. The point of intersection of the median from the vertex $(0, b)$ to the opposite side has coordinates $(0, \frac{a}{2})$ $\Rightarrow \bar{y} = (b - 0) \cdot \frac{1}{3} = \frac{b}{3}$ and $\bar{x} = (\frac{a}{2} - 0) \cdot \frac{2}{3} = \frac{a}{3} \Rightarrow (\bar{x}, \bar{y}) = (\frac{a}{3}, \frac{b}{3})$.

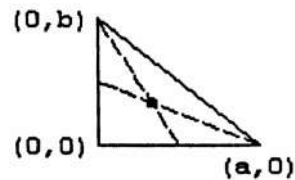

34. From the symmetry about the line $x = \frac{a}{2}$ it follows that $\bar{x} = \frac{a}{2}$. It also follows that the line through the points $(\frac{a}{2}, 0)$ and $(\frac{a}{2}, b)$ is a median $\Rightarrow \bar{y} = \frac{1}{3}(b - 0) = \frac{b}{3} \Rightarrow (\bar{x}, \bar{y}) = (\frac{a}{2}, \frac{b}{3})$.

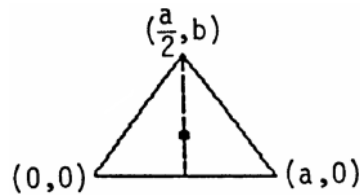

35. $y = x^{1/2} \Rightarrow dy = \frac{1}{2} x^{-1/2} dx$
 $\Rightarrow ds = \sqrt{(dx)^2 + (dy)^2} = \sqrt{1 + \frac{1}{4x}} dx$;
 $M_x = \delta \int_0^2 \sqrt{x} \sqrt{1 + \frac{1}{4x}} dx$
 $= \delta \int_0^2 \sqrt{x + \frac{1}{4}} dx = \frac{2\delta}{3} \left[(x + \frac{1}{4})^{3/2} \right]_0^2$
 $= \frac{2\delta}{3} \left[(2 + \frac{1}{4})^{3/2} - (\frac{1}{4})^{3/2} \right]$
 $= \frac{2\delta}{3} \left[(\frac{9}{4})^{3/2} - (\frac{1}{4})^{3/2} \right] = \frac{2\delta}{3} \left(\frac{27}{8} - \frac{1}{8} \right) = \frac{13\delta}{6}$

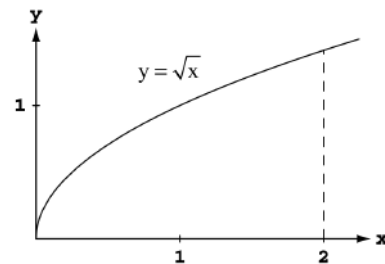

36. $y = x^3 \Rightarrow dy = 3x^2 dx$

$$\Rightarrow dx = \sqrt{(dx)^2 + (3x^2 dx)^2} = \sqrt{1 + 9x^4} dx;$$

$$M_x = \delta \int_0^1 x^3 \sqrt{1 + 9x^4} dx;$$

$$[u = 1 + 9x^4 \Rightarrow du = 36x^3 dx \Rightarrow \frac{1}{36} du = x^3 dx;$$

$$x = 0 \Rightarrow u = 1, x = 1 \Rightarrow u = 10]$$

$$\rightarrow M_x = \delta \int_1^{10} \frac{1}{36} u^{1/2} du = \frac{\delta}{36} \left[\frac{2}{3} u^{3/2} \right]_1^{10} = \frac{\delta}{54} (10^{3/2} - 1)$$

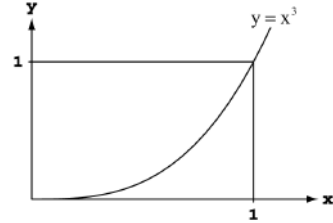

37. From Example 6 we have $M_x = \int_0^\pi a(a \sin \theta)(k \sin \theta) d\theta = a^2 k \int_0^\pi \sin^2 \theta d\theta = \frac{a^2 k}{2} \int_0^\pi (1 - \cos 2\theta) d\theta$
 $= \frac{a^2 k}{2} \left[\theta - \frac{\sin 2\theta}{2} \right]_0^\pi = \frac{a^2 k \pi}{2}$; $M_y = \int_0^\pi a(a \cos \theta)(k \sin \theta) d\theta = a^2 k \int_0^\pi \sin \theta \cos \theta d\theta = \frac{a^2 k}{2} [\sin^2 \theta]_0^\pi = 0$;
 $M = \int_0^\pi ak \sin \theta d\theta = ak[-\cos \theta]_0^\pi = 2ak$. Therefore, $\bar{x} = \frac{M_y}{M} = 0$ and $\bar{y} = \frac{M_x}{M} = \left(\frac{a^2 k \pi}{2} \right) \left(\frac{1}{2ak} \right) = \frac{a\pi}{4} \Rightarrow (0, \frac{a\pi}{4})$
 is the center of mass.

38. $M_x = \int \tilde{y} dm = \int_0^\pi (a \sin \theta) \cdot \delta \cdot a d\theta$

$$= \int_0^\pi (a^2 \sin \theta) (1 + k |\cos \theta|) d\theta$$

$$= a^2 \int_0^{\pi/2} (\sin \theta)(1 + k \cos \theta) d\theta$$

$$+ a^2 \int_{\pi/2}^\pi (\sin \theta)(1 - k \cos \theta) d\theta$$

$$= a^2 \int_0^{\pi/2} \sin \theta d\theta + a^2 k \int_0^{\pi/2} \sin \theta \cos \theta d\theta + a^2 \int_{\pi/2}^\pi \sin \theta d\theta - a^2 k \int_{\pi/2}^\pi \sin \theta \cos \theta d\theta$$

$$= a^2 [-\cos \theta]_0^{\pi/2} + a^2 k \left[\frac{\sin^2 \theta}{2} \right]_0^{\pi/2} + a^2 [-\cos \theta]_{\pi/2}^\pi - a^2 k \left[\frac{\sin^2 \theta}{2} \right]_{\pi/2}^\pi$$

$$= a^2 [0 - (-1)] + a^2 k \left(\frac{1}{2} - 0 \right) + a^2 [(-1) - 0] - a^2 k \left(0 - \frac{1}{2} \right) = a^2 + \frac{a^2 k}{2} + a^2 + \frac{a^2 k}{2}$$

$$= 2a^2 + a^2 k = a^2(2 + k);$$

$$M_y = \int \tilde{x} dm = \int_0^\pi (a \cos \theta) \cdot \delta \cdot a d\theta = \int_0^\pi (a^2 \cos \theta) (1 + k |\cos \theta|) d\theta$$

$$= a^2 \int_0^{\pi/2} (\cos \theta)(1 + k \cos \theta) d\theta + a^2 \int_{\pi/2}^\pi (\cos \theta)(1 - k \cos \theta) d\theta$$

$$= a^2 \int_0^{\pi/2} \cos \theta d\theta + a^2 k \int_0^{\pi/2} \left(\frac{1 + \cos 2\theta}{2} \right) d\theta + a^2 \int_{\pi/2}^\pi \cos \theta d\theta - a^2 k \int_{\pi/2}^\pi \left(\frac{1 + \cos 2\theta}{2} \right) d\theta$$

$$= a^2 [\sin \theta]_0^{\pi/2} + \frac{a^2 k}{2} \left[\theta + \frac{\sin 2\theta}{2} \right]_0^{\pi/2} + a^2 [\sin \theta]_{\pi/2}^\pi - \frac{a^2 k}{2} \left[\theta + \frac{\sin 2\theta}{2} \right]_{\pi/2}^\pi$$

$$= a^2(1 - 0) + \frac{a^2 k}{2} \left[\left(\frac{\pi}{2} - 0 \right) - (0 + 0) \right] + a^2(0 - 1) - \frac{a^2 k}{2} \left[(\pi + 0) - \left(\frac{\pi}{2} + 0 \right) \right] = a^2 + \frac{a^2 k \pi}{4} - a^2 - \frac{a^2 k \pi}{4} = 0;$$

$$M = \int_0^\pi \delta \cdot a d\theta = a \int_0^\pi (1 + k |\cos \theta|) d\theta = a \int_0^{\pi/2} (1 + k \cos \theta) d\theta + a \int_{\pi/2}^\pi (1 - k \cos \theta) d\theta$$

$$= a \left[\theta + k \sin \theta \right]_0^{\pi/2} + a \left[\theta - k \sin \theta \right]_{\pi/2}^\pi = a \left[\left(\frac{\pi}{2} + k \right) - 0 \right] + a \left[(\pi + 0) - \left(\frac{\pi}{2} - k \right) \right]$$

$$= \frac{a\pi}{2} + ak + a \left(\frac{\pi}{2} + k \right) = a\pi + 2ak = a(\pi + 2k). \text{ So } \bar{x} = \frac{M_y}{M} = 0 \text{ and } \bar{y} = \frac{M_x}{M} = \frac{a^2(2+k)}{a(\pi+2k)} = \frac{a(2+k)}{\pi+2k}$$

$$\Rightarrow \left(0, \frac{2a+ka}{\pi+2k} \right) \text{ is the center of mass.}$$

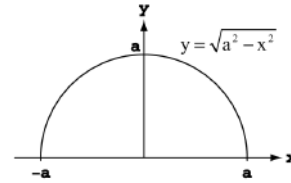

39. Consider the curve as an infinite number of line segments joined together. From the derivation of arc length we have that the length of a particular segment is $ds = \sqrt{(dx)^2 + (dy)^2}$. This implies that

$$M_x = \int \delta y ds, M_y = \int \delta x ds \text{ and } M = \int \delta ds. \text{ If } \delta \text{ is constant, then } \bar{x} = \frac{M_y}{M} = \frac{\int x ds}{\int ds} = \frac{\int x ds}{\text{length}} \text{ and}$$

$$\bar{y} = \frac{M_x}{M} = \frac{\int y ds}{\int ds} = \frac{\int y ds}{\text{length}}.$$

40. Applying the symmetry argument analogous to the one used in Exercise 13, we find that $\bar{x} = 0$. The typical

vertical strip has center of mass: $(\bar{x}, \bar{y}) = \left(x, \frac{a + \frac{x^2}{4p}}{2}\right)$, length: $a - \frac{x^2}{4p}$, width: dx , area: $dA = \left(a - \frac{x^2}{4p}\right) dx$,
 mass: $dm = \delta dA = \delta \left(a - \frac{x^2}{4p}\right) dx$. Thus, $M_x = \int \bar{y} dm = \int_{-2\sqrt{pa}}^{2\sqrt{pa}} \frac{1}{2} \left(a + \frac{x^2}{4p}\right) \left(a - \frac{x^2}{4p}\right) \delta dx$
 $= \frac{\delta}{2} \int_{-2\sqrt{pa}}^{2\sqrt{pa}} \left(a^2 - \frac{x^4}{16p^2}\right) dx = \frac{\delta}{2} \left[a^2 x - \frac{x^5}{80p^2} \right]_{-2\sqrt{pa}}^{2\sqrt{pa}} = 2 \cdot \frac{\delta}{2} \left[a^2 x - \frac{x^5}{80p^2} \right]_0^{2\sqrt{pa}} = \delta \left(2a^2 \sqrt{pa} - \frac{2^5 p^2 a^2 \sqrt{pa}}{80p^2} \right)$
 $= 2a^2 \delta \sqrt{pa} \left(1 - \frac{16}{80} \right) = 2a^2 \delta \sqrt{pa} \left(\frac{80-16}{80} \right) = 2a^2 \delta \sqrt{pa} \left(\frac{64}{80} \right) = \frac{8a^2 \delta \sqrt{pa}}{5}$; $M = \int dm = \delta \int_{-2\sqrt{pa}}^{2\sqrt{pa}} \left(a - \frac{x^2}{4p}\right) dx$
 $= \delta \left[ax - \frac{x^3}{12p} \right]_{-2\sqrt{pa}}^{2\sqrt{pa}} = 2 \cdot \delta \left[ax - \frac{x^3}{12p} \right]_0^{2\sqrt{pa}} = 2\delta \left(2a\sqrt{pa} - \frac{2^3 pa \sqrt{pa}}{12p} \right) = 4a\delta \sqrt{pa} \left(1 - \frac{4}{12} \right) = 4a\delta \sqrt{pa} \left(\frac{12-4}{12} \right)$
 $= \frac{8a\delta \sqrt{pa}}{3}$. So $\bar{y} = \frac{M_x}{M} = \left(\frac{8a^2 \delta \sqrt{pa}}{5} \right) \left(\frac{3}{8a\delta \sqrt{pa}} \right) = \frac{3}{5} a$, as claimed.

41. Since the density is constant, its value will not affect our answers, so we can set $\delta = 1$.

A generalization of Example 6 yields $M_x = \int \bar{y} dm = \int_{\pi/2-\alpha}^{\pi/2+\alpha} a^2 \sin \theta d\theta = a^2 [-\cos \theta]_{\pi/2-\alpha}^{\pi/2+\alpha}$
 $= a^2 [-\cos(\frac{\pi}{2} + \alpha) + \cos(\frac{\pi}{2} - \alpha)] = a^2(\sin \alpha + \sin \alpha) = 2a^2 \sin \alpha$; $M = \int dm = \int_{\pi/2-\alpha}^{\pi/2+\alpha} a d\theta = a[\theta]_{\pi/2-\alpha}^{\pi/2+\alpha}$
 $= a[(\frac{\pi}{2} + \alpha) - (\frac{\pi}{2} - \alpha)] = 2a\alpha$. Thus, $\bar{y} = \frac{M_x}{M} = \frac{2a^2 \sin \alpha}{2a\alpha} = \frac{a \sin \alpha}{\alpha}$. Now $s = a(2\alpha)$ and $a \sin \alpha = \frac{c}{2}$
 $\Rightarrow c = 2a \sin \alpha$. Then $\bar{y} = \frac{a(2a \sin \alpha)}{2a\alpha} = \frac{ac}{s}$, as claimed.

42. (a) First, we note that $\bar{y} = (\text{distance from origin to } \overline{AB}) + d \Rightarrow \frac{a \sin \alpha}{\alpha} = a \cos \alpha + d \Rightarrow d = \frac{a(\sin \alpha - \alpha \cos \alpha)}{\alpha}$.

Moreover, $h = a - a \cos \alpha \Rightarrow \frac{d}{h} = \frac{a(\sin \alpha - \alpha \cos \alpha)}{a(\alpha - \alpha \cos \alpha)} = \frac{\sin \alpha - \alpha \cos \alpha}{\alpha - \alpha \cos \alpha}$. The graphs below suggest that

$$\lim_{\alpha \rightarrow 0^+} \frac{\sin \alpha - \alpha \cos \alpha}{\alpha - \alpha \cos \alpha} \approx \frac{2}{3}.$$

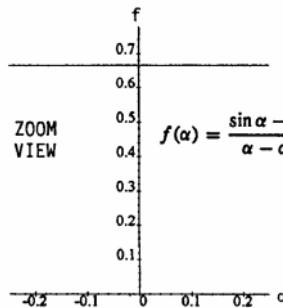
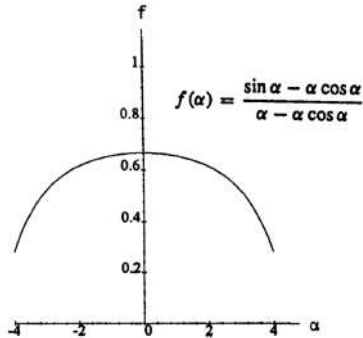

(b)	α	0.2	0.4	0.6	0.8	1.0
	$f(\alpha)$	0.666222	0.664879	0.662615	0.659389	0.655145

6.5 AREAS OF SURFACES OF REVOLUTION AND THE THEOREMS OF PAPPUS

1. (a) $\frac{dy}{dx} = \sec^2 x \Rightarrow \left(\frac{dy}{dx}\right)^2 = \sec^4 x$
 $\Rightarrow S = 2\pi \int_0^{\pi/4} (\tan x) \sqrt{1 + \sec^4 x} dx$
 (c) $S \approx 3.84$

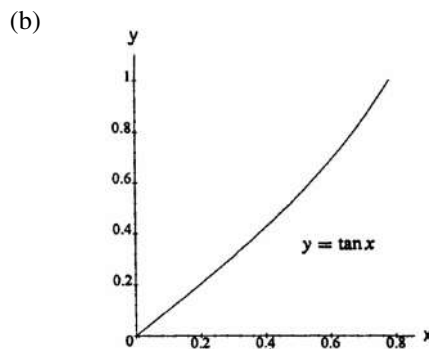

2. (a) $\frac{dy}{dx} = 2x \Rightarrow \left(\frac{dy}{dx}\right)^2 = 4x^2$
 $\Rightarrow S = 2\pi \int_0^2 x^2 \sqrt{1 + 4x^2} dx$
 (c) $S \approx 53.23$

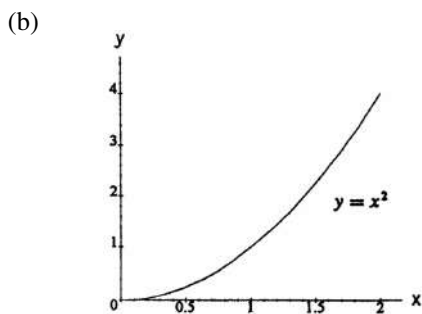

3. (a) $xy = 1 \Rightarrow x = \frac{1}{y} \Rightarrow \frac{dx}{dy} = -\frac{1}{y^2} \Rightarrow \left(\frac{dx}{dy}\right)^2 = \frac{1}{y^4}$
 $\Rightarrow S = 2\pi \int_1^2 \frac{1}{y} \sqrt{1 + y^{-4}} dy$
 (c) $S \approx 5.02$

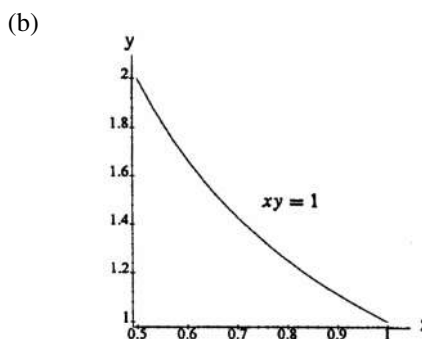

4. (a) $\frac{dx}{dy} = \cos y \Rightarrow \left(\frac{dx}{dy}\right)^2 = \cos^2 y$
 $\Rightarrow S = 2\pi \int_0^\pi (\sin y) \sqrt{1 + \cos^2 y} dy$
 (c) $S \approx 14.42$

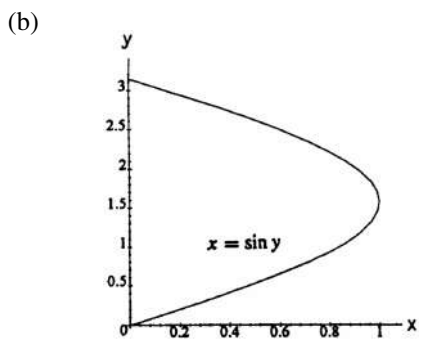

5. (a) $x^{1/2} + y^{1/2} = 3 \Rightarrow y = (3 - x^{1/2})^2$
 $\Rightarrow \frac{dy}{dx} = 2(3 - x^{1/2}) \left(-\frac{1}{2}x^{-1/2}\right)$
 $\Rightarrow \left(\frac{dy}{dx}\right)^2 = (1 - 3x^{-1/2})^2$
 $\Rightarrow S = 2\pi \int_1^4 (3 - x^{1/2})^2 \sqrt{1 + (1 - 3x^{-1/2})^2} dx$
 (c) $S \approx 63.37$

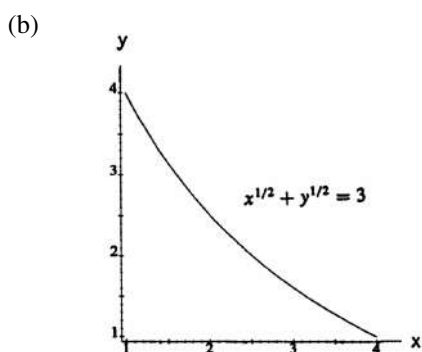

6. (a) $\frac{dx}{dy} = 1 + y^{-1/2} \Rightarrow \left(\frac{dx}{dy}\right)^2 = (1 + y^{-1/2})^2$
 $\Rightarrow S = 2\pi \int_1^2 (y + 2\sqrt{y}) \sqrt{1 + (1 + y^{-1/2})^2} dx$
 (c) $S \approx 51.33$

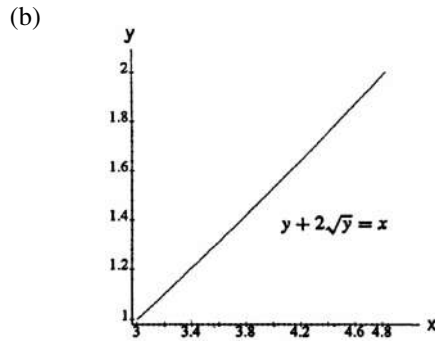

7. (a) $\frac{dx}{dy} = \tan y \Rightarrow \left(\frac{dx}{dy}\right)^2 = \tan^2 y$
 $\Rightarrow S = 2\pi \int_0^{\pi/3} \left(\int_0^y \tan t dt\right) \sqrt{1 + \tan^2 y} dy$
 $= 2\pi \int_0^{\pi/3} \left(\int_0^y \tan t dt\right) \sec y dy$
 (c) $S \approx 2.08$

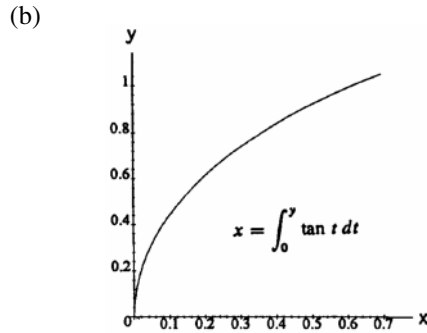

8. (a) $\frac{dy}{dx} = \sqrt{x^2 - 1} \Rightarrow \left(\frac{dy}{dx}\right)^2 = x^2 - 1$
 $\Rightarrow S = 2\pi \int_1^{\sqrt{5}} \left(\int_1^x \sqrt{t^2 - 1} dt\right) \sqrt{1 + (x^2 - 1)} dx$
 $= 2\pi \int_1^{\sqrt{5}} \left(\int_1^x \sqrt{t^2 - 1} dt\right) x dx$
 (c) $S \approx 8.55$

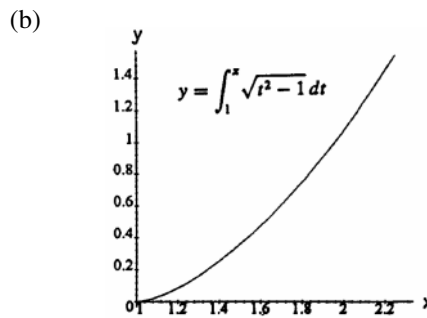

9. $y = \frac{x}{2} \Rightarrow \frac{dy}{dx} = \frac{1}{2}; S = \int_a^b 2\pi y \sqrt{1 + \left(\frac{dy}{dx}\right)^2} dx \Rightarrow S = \int_0^4 2\pi \left(\frac{x}{2}\right) \sqrt{1 + \frac{1}{4}} dx = \frac{\pi\sqrt{5}}{2} \int_0^4 x dx$
 $= \frac{\pi\sqrt{5}}{2} \left[\frac{x^2}{2}\right]_0^4 = 4\pi\sqrt{5}$; Geometry formula: base circumference = $2\pi(2)$, slant height = $\sqrt{4^2 + 2^2} = 2\sqrt{5}$
 \Rightarrow Lateral surface area = $\frac{1}{2} (4\pi) (2\sqrt{5}) = 4\pi\sqrt{5}$ in agreement with the integral value

10. $y = \frac{x}{2} \Rightarrow x = 2y \Rightarrow \frac{dx}{dy} = 2; S = \int_c^d 2\pi x \sqrt{1 + \left(\frac{dx}{dy}\right)^2} dy = \int_0^2 2\pi \cdot 2y \sqrt{1 + 2^2} dy = 4\pi\sqrt{5} \int_0^2 y dy = 2\pi\sqrt{5} [y^2]_0^2$
 $= 2\pi\sqrt{5} \cdot 4 = 8\pi\sqrt{5}$; Geometry formula: base circumference = $2\pi(4)$, slant height = $\sqrt{4^2 + 2^2} = 2\sqrt{5}$
 \Rightarrow Lateral surface area = $\frac{1}{2} (8\pi) (2\sqrt{5}) = 8\pi\sqrt{5}$ in agreement with the integral value

11. $\frac{dy}{dx} = \frac{1}{2}; S = \int_a^b 2\pi y \sqrt{1 + \left(\frac{dy}{dx}\right)^2} dx = \int_1^3 2\pi \frac{(x+1)}{2} \sqrt{1 + \left(\frac{1}{2}\right)^2} dx = \frac{\pi\sqrt{5}}{2} \int_1^3 (x+1) dx = \frac{\pi\sqrt{5}}{2} \left[\frac{x^2}{2} + x\right]_1^3$
 $= \frac{\pi\sqrt{5}}{2} \left[\left(\frac{9}{2} + 3\right) - \left(\frac{1}{2} + 1\right)\right] = \frac{\pi\sqrt{5}}{2} (4 + 2) = 3\pi\sqrt{5}$; Geometry formula: $r_1 = \frac{1}{2} + \frac{1}{2} = 1, r_2 = \frac{3}{2} + \frac{1}{2} = 2$,
 slant height = $\sqrt{(2-1)^2 + (3-1)^2} = \sqrt{5} \Rightarrow$ Frustum surface area = $\pi(r_1 + r_2) \times$ slant height = $\pi(1 + 2)\sqrt{5}$
 $= 3\pi\sqrt{5}$ in agreement with the integral value

12. $y = \frac{x}{2} + \frac{1}{2} \Rightarrow x = 2y - 1 \Rightarrow \frac{dx}{dy} = 2$; $S = \int_c^d 2\pi x \sqrt{1 + \left(\frac{dx}{dy}\right)^2} dy = \int_1^2 2\pi(2y - 1)\sqrt{1 + 4} dy = 2\pi\sqrt{5} \int_1^2 (2y - 1) dy$
 $= 2\pi\sqrt{5} [y^2 - y]_1^2 = 2\pi\sqrt{5} [(4 - 2) - (1 - 1)] = 4\pi\sqrt{5}$; Geometry formula: $r_1 = 1, r_2 = 3$,
 slant height $= \sqrt{(2 - 1)^2 + (3 - 1)^2} = \sqrt{5} \Rightarrow$ Frustum surface area $= \pi(1 + 3)\sqrt{5} = 4\pi\sqrt{5}$ in agreement with
 the integral value

13. $\frac{dy}{dx} = \frac{x^2}{3} \Rightarrow \left(\frac{dy}{dx}\right)^2 = \frac{x^4}{9} \Rightarrow S = \int_0^2 \frac{2\pi x^3}{9} \sqrt{1 + \frac{x^4}{9}} dx$;
 $[u = 1 + \frac{x^4}{9} \Rightarrow du = \frac{4}{9} x^3 dx \Rightarrow \frac{1}{4} du = \frac{x^3}{9} dx$;
 $x = 0 \Rightarrow u = 1, x = 2 \Rightarrow u = \frac{25}{9}]$
 $\rightarrow S = 2\pi \int_1^{25/9} u^{1/2} \cdot \frac{1}{4} du = \frac{\pi}{2} \left[\frac{2}{3} u^{3/2} \right]_1^{25/9}$
 $= \frac{\pi}{3} \left(\frac{125}{27} - 1 \right) = \frac{\pi}{3} \left(\frac{125 - 27}{27} \right) = \frac{98\pi}{81}$

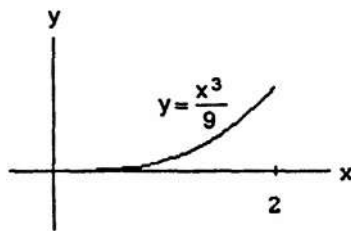

14. $\frac{dy}{dx} = \frac{1}{2} x^{-1/2} \Rightarrow \left(\frac{dy}{dx}\right)^2 = \frac{1}{4x}$
 $\Rightarrow S = \int_{3/4}^{15/4} 2\pi\sqrt{x} \sqrt{1 + \frac{1}{4x}} dx$
 $= 2\pi \int_{3/4}^{15/4} \sqrt{x + \frac{1}{4}} dx = 2\pi \left[\frac{2}{3} \left(x + \frac{1}{4}\right)^{3/2} \right]_{3/4}^{15/4}$
 $= \frac{4\pi}{3} \left[\left(\frac{15}{4} + \frac{1}{4}\right)^{3/2} - \left(\frac{3}{4} + \frac{1}{4}\right)^{3/2} \right] = \frac{4\pi}{3} \left[\left(\frac{4}{2}\right)^3 - 1 \right]$
 $= \frac{4\pi}{3} (8 - 1) = \frac{28\pi}{3}$

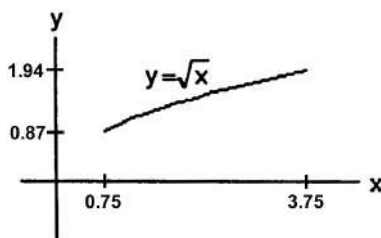

15. $\frac{dy}{dx} = \frac{1}{2} \frac{(2-2x)}{\sqrt{2x-x^2}} = \frac{1-x}{\sqrt{2x-x^2}} \Rightarrow \left(\frac{dy}{dx}\right)^2 = \frac{(1-x)^2}{2x-x^2}$
 $\Rightarrow S = \int_{0.5}^{1.5} 2\pi\sqrt{2x-x^2} \sqrt{1 + \frac{(1-x)^2}{2x-x^2}} dx$
 $= 2\pi \int_{0.5}^{1.5} \sqrt{2x-x^2} \frac{\sqrt{2x-x^2+1-2x+x^2}}{\sqrt{2x-x^2}} dx$
 $= 2\pi \int_{0.5}^{1.5} dx = 2\pi [x]_{0.5}^{1.5} = 2\pi$

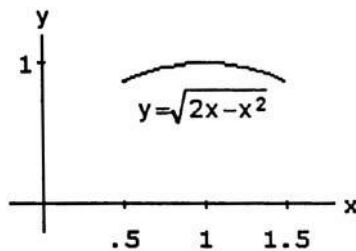

16. $\frac{dy}{dx} = \frac{1}{2\sqrt{x+1}} \Rightarrow \left(\frac{dy}{dx}\right)^2 = \frac{1}{4(x+1)}$
 $\Rightarrow S = \int_1^5 2\pi\sqrt{x+1} \sqrt{1 + \frac{1}{4(x+1)}} dx$
 $= 2\pi \int_1^5 \sqrt{(x+1) + \frac{1}{4}} dx = 2\pi \int_1^5 \sqrt{x + \frac{5}{4}} dx$
 $= 2\pi \left[\frac{2}{3} \left(x + \frac{5}{4}\right)^{3/2} \right]_1^5 = \frac{4\pi}{3} \left[\left(5 + \frac{5}{4}\right)^{3/2} - \left(1 + \frac{5}{4}\right)^{3/2} \right]$
 $= \frac{4\pi}{3} \left[\left(\frac{25}{4}\right)^{3/2} - \left(\frac{9}{4}\right)^{3/2} \right] = \frac{4\pi}{3} \left(\frac{5^3}{2^3} - \frac{3^3}{2^3} \right)$
 $= \frac{\pi}{6} (125 - 27) = \frac{98\pi}{6} = \frac{49\pi}{3}$

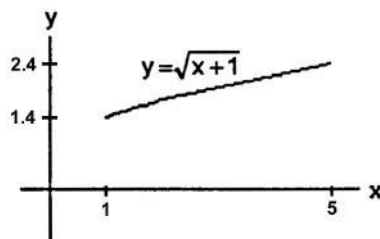

17. $\frac{dx}{dy} = y^2 \Rightarrow \left(\frac{dx}{dy}\right)^2 = y^4 \Rightarrow S = \int_0^1 \frac{2\pi y^3}{3} \sqrt{1 + y^4} dy$;
 $[u = 1 + y^4 \Rightarrow du = 4y^3 dy \Rightarrow \frac{1}{4} du = y^3 dy; y = 0$
 $\Rightarrow u = 1, y = 1 \Rightarrow u = 2] \rightarrow S = \int_1^2 2\pi \left(\frac{1}{3}\right) u^{1/2} \left(\frac{1}{4} du\right)$
 $= \frac{\pi}{6} \int_1^2 u^{1/2} du = \frac{\pi}{6} \left[\frac{2}{3} u^{3/2} \right]_1^2 = \frac{\pi}{9} (\sqrt{8} - 1)$

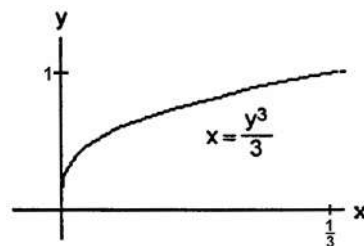

18. $x = (\frac{1}{3}y^{3/2} - y^{1/2}) \leq 0$, when $1 \leq y \leq 3$. To get positive area, we take $x = -(\frac{1}{3}y^{3/2} - y^{1/2})$

$$\begin{aligned} \Rightarrow \frac{dx}{dy} &= -\frac{1}{2}(y^{1/2} - y^{-1/2}) \Rightarrow \left(\frac{dx}{dy}\right)^2 = \frac{1}{4}(y - 2 + y^{-1}) \\ \Rightarrow S &= -\int_1^3 2\pi \left(\frac{1}{3}y^{3/2} - y^{1/2}\right) \sqrt{1 + \frac{1}{4}(y - 2 + y^{-1})} dy \\ &= -2\pi \int_1^3 \left(\frac{1}{3}y^{3/2} - y^{1/2}\right) \sqrt{\frac{1}{4}(y + 2 + y^{-1})} dy \\ &= -2\pi \int_1^3 \left(\frac{1}{3}y^{3/2} - y^{1/2}\right) \frac{\sqrt{(y^{1/2} + y^{-1/2})^2}}{2} dy = -\pi \int_1^3 y^{1/2} \left(\frac{1}{3}y - 1\right) \left(y^{1/2} + \frac{1}{y^{1/2}}\right) dy \\ &= -\pi \int_1^3 \left(\frac{1}{3}y^2 - \frac{2}{3}y - 1\right) dy = -\pi \left[\frac{y^3}{9} - \frac{y^2}{3} - y\right]_1^3 = -\pi \left[\left(\frac{27}{9} - \frac{9}{3} - 3\right) - \left(\frac{1}{9} - \frac{1}{3} - 1\right)\right] \\ &= -\pi \left(-3 - \frac{1}{9} + \frac{1}{3} + 1\right) = -\frac{\pi}{9}(-18 - 1 + 3) = \frac{16\pi}{9} \end{aligned}$$

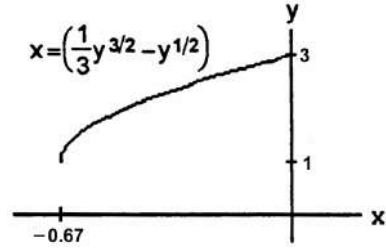

19. $\frac{dx}{dy} = \frac{-1}{\sqrt{4-y}} \Rightarrow \left(\frac{dx}{dy}\right)^2 = \frac{1}{4-y} \Rightarrow S = \int_0^{15/4} 2\pi \cdot 2\sqrt{4-y} \sqrt{1 + \frac{1}{4-y}} dy = 4\pi \int_0^{15/4} \sqrt{(4-y) + 1} dy$
 $= 4\pi \int_0^{15/4} \sqrt{5-y} dy = -4\pi \left[\frac{2}{3}(5-y)^{3/2}\right]_0^{15/4} = -\frac{8\pi}{3} \left[\left(5 - \frac{15}{4}\right)^{3/2} - 5^{3/2}\right] = -\frac{8\pi}{3} \left[\left(\frac{5}{4}\right)^{3/2} - 5^{3/2}\right]$
 $= \frac{8\pi}{3} \left(5\sqrt{5} - \frac{5\sqrt{5}}{8}\right) = \frac{8\pi}{3} \left(\frac{40\sqrt{5} - 5\sqrt{5}}{8}\right) = \frac{35\pi\sqrt{5}}{3}$
20. $\frac{dx}{dy} = \frac{1}{\sqrt{2y-1}} \Rightarrow \left(\frac{dx}{dy}\right)^2 = \frac{1}{2y-1} \Rightarrow S = \int_{5/8}^1 2\pi \sqrt{2y-1} \sqrt{1 + \frac{1}{2y-1}} dy = 2\pi \int_{5/8}^1 \sqrt{(2y-1) + 1} dy$
 $= 2\pi \int_{5/8}^1 \sqrt{2} y^{1/2} dy = 2\pi \sqrt{2} \left[\frac{2}{3} y^{3/2}\right]_{5/8}^1 = \frac{4\pi\sqrt{2}}{3} \left[1^{3/2} - \left(\frac{5}{8}\right)^{3/2}\right] = \frac{4\pi\sqrt{2}}{3} \left(1 - \frac{5\sqrt{5}}{8\sqrt{8}}\right)$
 $= \frac{4\pi\sqrt{2}}{3} \left(\frac{8 \cdot 2\sqrt{2} - 5\sqrt{5}}{8 \cdot 2\sqrt{2}}\right) = \frac{\pi}{12} (16\sqrt{2} - 5\sqrt{5})$
21. $ds = \sqrt{dx^2 + dy^2} = \sqrt{\left(y^3 - \frac{1}{4y^3}\right)^2 + 1} dy = \sqrt{\left(y^6 - \frac{1}{2} + \frac{1}{16y^6}\right) + 1} dy = \sqrt{\left(y^6 + \frac{1}{2} + \frac{1}{16y^6}\right)} dy$
 $= \sqrt{\left(y^3 + \frac{1}{4y^3}\right)^2} dy = \left(y^3 + \frac{1}{4y^3}\right) dy; S = \int_1^2 2\pi y ds = 2\pi \int_1^2 y \left(y^3 + \frac{1}{4y^3}\right) dy = 2\pi \int_1^2 \left(y^4 + \frac{1}{4}y^{-2}\right) dy$
 $= 2\pi \left[\frac{y^5}{5} - \frac{1}{4}y^{-1}\right]_1^2 = 2\pi \left[\left(\frac{32}{5} - \frac{1}{8}\right) - \left(\frac{1}{5} - \frac{1}{4}\right)\right] = 2\pi \left(\frac{31}{5} + \frac{1}{8}\right) = \frac{2\pi}{40} (8 \cdot 31 + 5) = \frac{253\pi}{20}$
22. $y = \frac{1}{3}(x^2 + 2)^{3/2} \Rightarrow dy = x\sqrt{x^2 + 2} dx \Rightarrow ds = \sqrt{1 + (2x^2 + x^4)} dx \Rightarrow S = 2\pi \int_0^{\sqrt{2}} x \sqrt{1 + 2x^2 + x^4} dx$
 $= 2\pi \int_0^{\sqrt{2}} x \sqrt{(x^2 + 1)^2} dx = 2\pi \int_0^{\sqrt{2}} x(x^2 + 1) dx = 2\pi \int_0^{\sqrt{2}} (x^3 + x) dx = 2\pi \left[\frac{x^4}{4} + \frac{x^2}{2}\right]_0^{\sqrt{2}} = 2\pi \left(\frac{4}{4} + \frac{2}{2}\right) = 4\pi$
23. $y = \sqrt{a^2 - x^2} \Rightarrow \frac{dy}{dx} = \frac{1}{2}(a^2 - x^2)^{-1/2}(-2x) = \frac{-x}{\sqrt{a^2 - x^2}} \Rightarrow \left(\frac{dy}{dx}\right)^2 = \frac{x^2}{(a^2 - x^2)}$
 $\Rightarrow S = 2\pi \int_{-a}^a \sqrt{a^2 - x^2} \sqrt{1 + \frac{x^2}{(a^2 - x^2)}} dx = 2\pi \int_{-a}^a \sqrt{(a^2 - x^2) + x^2} dx = 2\pi \int_{-a}^a a dx = 2\pi a[x]_{-a}^a$
 $= 2\pi a[a - (-a)] = (2\pi a)(2a) = 4\pi a^2$
24. $y = \frac{r}{h}x \Rightarrow \frac{dy}{dx} = \frac{r}{h} \Rightarrow \left(\frac{dy}{dx}\right)^2 = \frac{r^2}{h^2} \Rightarrow S = 2\pi \int_0^h \frac{r}{h}x \sqrt{1 + \frac{r^2}{h^2}} dx = 2\pi \int_0^h \frac{r}{h}x \sqrt{\frac{h^2 + r^2}{h^2}} dx$
 $= \frac{2\pi r}{h} \sqrt{\frac{h^2 + r^2}{h^2}} \int_0^h x dx = \frac{2\pi r}{h^2} \sqrt{h^2 + r^2} \left[\frac{x^2}{2}\right]_0^h = \frac{2\pi r}{h^2} \sqrt{h^2 + r^2} \left(\frac{h^2}{2}\right) = \pi r \sqrt{h^2 + r^2}$
25. $y = \cos x \Rightarrow \frac{dy}{dx} = -\sin x \Rightarrow \left(\frac{dy}{dx}\right)^2 = \sin^2 x \Rightarrow S = 2\pi \int_{-\pi/2}^{\pi/2} (\cos x) \sqrt{1 + \sin^2 x} dx$

26. $y = (1 - x^{2/3})^{3/2} \Rightarrow \frac{dy}{dx} = \frac{3}{2} (1 - x^{2/3})^{1/2} (-\frac{2}{3} x^{-1/3}) = -\frac{(1-x^{2/3})^{1/2}}{x^{1/3}} \Rightarrow \left(\frac{dy}{dx}\right)^2 = \frac{1-x^{2/3}}{x^{2/3}} = \frac{1}{x^{2/3}} - 1$
 $\Rightarrow S = 2 \int_0^1 2\pi (1 - x^{2/3})^{3/2} \sqrt{1 + \left(\frac{1}{x^{2/3}} - 1\right)} dx = 4\pi \int_0^1 (1 - x^{2/3})^{3/2} \sqrt{x^{-2/3}} dx$
 $= 4\pi \int_0^1 (1 - x^{2/3})^{3/2} x^{-1/3} dx; [u = 1 - x^{2/3} \Rightarrow du = -\frac{2}{3} x^{-1/3} dx \Rightarrow -\frac{3}{2} du = x^{-1/3} dx;$
 $x = 0 \Rightarrow u = 1, x = 1 \Rightarrow u = 0] \rightarrow S = 4\pi \int_1^0 u^{3/2} (-\frac{3}{2} du) = -6\pi \left[\frac{2}{5} u^{5/2}\right]_1^0 = -6\pi (0 - \frac{2}{5}) = \frac{12\pi}{5}$
27. The area of the surface of one wok is $S = \int_c^d 2\pi x \sqrt{1 + \left(\frac{dx}{dy}\right)^2} dy$. Now, $x^2 + y^2 = 16^2 \Rightarrow x = \sqrt{16^2 - y^2}$
 $\Rightarrow \frac{dx}{dy} = \frac{-y}{\sqrt{16^2 - y^2}} \Rightarrow \left(\frac{dx}{dy}\right)^2 = \frac{y^2}{16^2 - y^2}; S = \int_{-16}^{-7} 2\pi \sqrt{16^2 - y^2} \sqrt{1 + \frac{y^2}{16^2 - y^2}} dy = 2\pi \int_{-16}^{-7} \sqrt{(16^2 - y^2) + y^2} dy$
 $= 2\pi \int_{-16}^{-7} 16 dy = 32\pi \cdot 9 = 288\pi \approx 904.78 \text{ cm}^2$. The enamel needed to cover one surface of one wok is
 $V = S \cdot 0.5 \text{ mm} = S \cdot 0.05 \text{ cm} = (904.78)(0.05) \text{ cm}^3 = 45.24 \text{ cm}^3$. For 5000 woks, we need
 $5000 \cdot V = 5000 \cdot 45.24 \text{ cm}^3 = (5)(45.24)L = 226.2L \Rightarrow 226.2 \text{ liters of each color are needed.}$
28. $y = \sqrt{r^2 - x^2} \Rightarrow \frac{dy}{dx} = -\frac{1}{2} \frac{2x}{\sqrt{r^2 - x^2}} = \frac{-x}{\sqrt{r^2 - x^2}} \Rightarrow \left(\frac{dx}{dy}\right)^2 = \frac{x^2}{r^2 - x^2}; S = 2\pi \int_a^{a+h} \sqrt{r^2 - x^2} \sqrt{1 + \frac{x^2}{r^2 - x^2}} dx$
 $= 2\pi \int_a^{a+h} \sqrt{(r^2 - x^2) + x^2} dx = 2\pi r \int_a^{a+h} dx = 2\pi rh$, which is independent of a .
29. $y = \sqrt{R^2 - x^2} \Rightarrow \frac{dy}{dx} = -\frac{1}{2} \frac{2x}{\sqrt{R^2 - x^2}} = \frac{-x}{\sqrt{R^2 - x^2}} \Rightarrow \left(\frac{dx}{dy}\right)^2 = \frac{x^2}{R^2 - x^2}; S = 2\pi \int_a^{a+h} \sqrt{R^2 - x^2} \sqrt{1 + \frac{x^2}{R^2 - x^2}} dx$
 $= 2\pi \int_a^{a+h} \sqrt{(R^2 - x^2) + x^2} dx = 2\pi R \int_a^{a+h} dx = 2\pi Rh$
30. (a) $x^2 + y^2 = 45^2 \Rightarrow x = \sqrt{45^2 - y^2} \Rightarrow \frac{dx}{dy} = \frac{-y}{\sqrt{45^2 - y^2}} \Rightarrow \left(\frac{dx}{dy}\right)^2 = \frac{y^2}{45^2 - y^2};$
 $S = \int_{-22.5}^{45} 2\pi \sqrt{45^2 - y^2} \sqrt{1 + \frac{y^2}{45^2 - y^2}} dy = 2\pi \int_{-22.5}^{45} \sqrt{(45^2 - y^2) + y^2} dy = 2\pi \cdot 45 \int_{-22.5}^{45} dy$
 $= (2\pi)(45)(67.5) = 6075\pi \text{ square feet}$
 (b) 19,085 square feet
31. $y = x \Rightarrow \left(\frac{dy}{dx}\right) = 1 \Rightarrow \left(\frac{dy}{dx}\right)^2 = 1 \Rightarrow S = 2\pi \int_{-1}^2 |x| \sqrt{1 + 1} dx = 2\pi \int_{-1}^0 (-x)\sqrt{2} dx + 2\pi \int_0^2 x\sqrt{2} dx$
 $= -2\sqrt{2}\pi \left[\frac{x^2}{2}\right]_{-1}^0 + 2\sqrt{2}\pi \left[\frac{x^2}{2}\right]_0^2 = -2\sqrt{2}\pi (0 - \frac{1}{2}) + 2\sqrt{2}\pi(2 - 0) = 5\sqrt{2}\pi$
32. $\frac{dy}{dx} = \frac{x^2}{3} \Rightarrow \left(\frac{dy}{dx}\right)^2 = \frac{x^4}{9} \Rightarrow$ by symmetry of the graph that $S = 2 \int_{-\sqrt{3}}^0 2\pi \left(-\frac{x^3}{9}\right) \sqrt{1 + \frac{x^4}{9}} dx; [u = 1 + \frac{x^4}{9}$
 $\Rightarrow du = \frac{4}{9} x^3 dx \Rightarrow -\frac{1}{4} du = -\frac{x^3}{9} dx; x = -\sqrt{3} \Rightarrow u = 2, x = 0 \Rightarrow u = 1] \rightarrow S = 4\pi \int_2^1 u^{1/2} (-\frac{1}{4}) du$
 $= -\pi \int_2^1 u^{1/2} du = -\pi \left[\frac{2}{3} u^{3/2}\right]_2^1 = -\pi \left(\frac{2}{3} - \frac{2}{3} \sqrt{8}\right) = \frac{2\pi}{3} (\sqrt{8} - 1)$. If the absolute value bars are dropped the
 integral for $S = \int_{-\sqrt{3}}^{\sqrt{3}} 2\pi f(x) ds$ will equal zero since $\int_{-\sqrt{3}}^{\sqrt{3}} 2\pi \left(\frac{x^3}{9}\right) \sqrt{1 + \frac{x^4}{9}} dx$ is the integral of an odd function
 over the symmetric interval $-\sqrt{3} \leq x \leq \sqrt{3}$.
33. $\frac{dx}{dt} = -\sin t$ and $\frac{dy}{dt} = \cos t \Rightarrow \sqrt{\left(\frac{dx}{dt}\right)^2 + \left(\frac{dy}{dt}\right)^2} = \sqrt{(-\sin t)^2 + (\cos t)^2} = 1 \Rightarrow S = \int 2\pi y ds$
 $= \int_0^{2\pi} 2\pi(2 + \sin t)(1) dt = 2\pi [2t - \cos t]_0^{2\pi} = 2\pi[(4\pi - 1) - (0 - 1)] = 8\pi^2$

$$34. \frac{dx}{dt} = t^{1/2} \text{ and } \frac{dy}{dt} = t^{-1/2} \Rightarrow \sqrt{\left(\frac{dx}{dt}\right)^2 + \left(\frac{dy}{dt}\right)^2} = \sqrt{t + t^{-1}} = \sqrt{\frac{t^2+1}{t}} \Rightarrow S = \int 2\pi x \, ds$$

$$= \int_0^{\sqrt{3}} 2\pi \left(\frac{2}{3} t^{3/2}\right) \sqrt{\frac{t^2+1}{t}} \, dt = \frac{4\pi}{3} \int_0^{\sqrt{3}} t \sqrt{t^2+1} \, dt; [u = t^2 + 1 \Rightarrow du = 2t \, dt; t = 0 \Rightarrow u = 1,$$

$$[t = \sqrt{3} \Rightarrow u = 4] \rightarrow \int_1^4 \frac{2\pi}{3} \sqrt{u} \, du = \left[\frac{4\pi}{9} u^{3/2}\right]_1^4 = \frac{28\pi}{9}$$

Note: $\int_0^{\sqrt{3}} 2\pi \left(\frac{2}{3} t^{3/2}\right) \sqrt{\frac{t^2+1}{t}} \, dt$ is an improper integral but $\lim_{t \rightarrow 0^+} f(t)$ exists and is equal to 0, where $f(t) = 2\pi \left(\frac{2}{3} t^{3/2}\right) \sqrt{\frac{t^2+1}{t}}$. Thus the discontinuity is removable: define $F(t) = f(t)$ for $t > 0$ and $F(0) = 0$
 $\Rightarrow \int_0^{\sqrt{3}} F(t) \, dt = \frac{28\pi}{9}$.

$$35. \frac{dx}{dt} = 1 \text{ and } \frac{dy}{dt} = t + \sqrt{2} \Rightarrow \sqrt{\left(\frac{dx}{dt}\right)^2 + \left(\frac{dy}{dt}\right)^2} = \sqrt{1^2 + (t + \sqrt{2})^2} = \sqrt{t^2 + 2\sqrt{2}t + 3} \Rightarrow S = \int 2\pi x \, ds$$

$$= \int_{-\sqrt{2}}^{\sqrt{2}} 2\pi (t + \sqrt{2}) \sqrt{t^2 + 2\sqrt{2}t + 3} \, dt; [u = t^2 + 2\sqrt{2}t + 3 \Rightarrow du = (2t + 2\sqrt{2}) \, dt; t = -\sqrt{2} \Rightarrow u = 1,$$

$$t = \sqrt{2} \Rightarrow u = 9] \rightarrow \int_1^9 \pi \sqrt{u} \, du = \left[\frac{2}{3} \pi u^{3/2}\right]_1^9 = \frac{2\pi}{3} (27 - 1) = \frac{52\pi}{3}$$

$$36. \frac{dx}{dt} = a(1 - \cos t) \text{ and } \frac{dy}{dt} = a \sin t \Rightarrow \sqrt{\left(\frac{dx}{dt}\right)^2 + \left(\frac{dy}{dt}\right)^2} = \sqrt{[a(1 - \cos t)]^2 + (a \sin t)^2}$$

$$= \sqrt{a^2 - 2a^2 \cos t + a^2 \cos^2 t + a^2 \sin^2 t} = \sqrt{2a^2 - 2a^2 \cos t} = a\sqrt{2} \sqrt{1 - \cos t} \Rightarrow S = \int 2\pi y \, ds$$

$$= \int_0^{2\pi} 2\pi a(1 - \cos t) \cdot a\sqrt{2} \sqrt{1 - \cos t} \, dt = 2\sqrt{2} \pi a^2 \int_0^{2\pi} (1 - \cos t)^{3/2} \, dt$$

$$37. \frac{dx}{dt} = 2 \text{ and } \frac{dy}{dt} = 1 \Rightarrow \sqrt{\left(\frac{dx}{dt}\right)^2 + \left(\frac{dy}{dt}\right)^2} = \sqrt{2^2 + 1^2} = \sqrt{5} \Rightarrow S = \int 2\pi y \, ds = \int_0^1 2\pi(t+1)\sqrt{5} \, dt$$

$$= 2\pi\sqrt{5} \left[\frac{t^2}{2} + t\right]_0^1 = 3\pi\sqrt{5}. \text{ Check: slant height is } \sqrt{5} \Rightarrow \text{Area is } \pi(1+2)\sqrt{5} = 3\pi\sqrt{5}.$$

$$38. \frac{dx}{dt} = h \text{ and } \frac{dy}{dt} = r \Rightarrow \sqrt{\left(\frac{dx}{dt}\right)^2 + \left(\frac{dy}{dt}\right)^2} = \sqrt{h^2 + r^2} \Rightarrow S = \int 2\pi y \, ds = \int_0^1 2\pi r t \sqrt{h^2 + r^2} \, dt$$

$$= 2\pi r \sqrt{h^2 + r^2} \int_0^1 t \, dt = 2\pi r \sqrt{h^2 + r^2} \left[\frac{t^2}{2}\right]_0^1 = \pi r \sqrt{h^2 + r^2}. \text{ Check: slant height is } \sqrt{h^2 + r^2} \Rightarrow \text{Area is } \pi r \sqrt{h^2 + r^2}.$$

39. (a) An equation of the tangent line segment is (see figure) $y = f(m_k) + f'(m_k)(x - m_k)$.

When $x = x_{k-1}$ we have

$$r_1 = f(m_k) + f'(m_k)(x_{k-1} - m_k)$$

$$= f(m_k) + f'(m_k) \left(-\frac{\Delta x_k}{2}\right) = f(m_k) - f'(m_k) \frac{\Delta x_k}{2};$$

when $x = x_k$ we have

$$r_2 = f(m_k) + f'(m_k)(x_k - m_k)$$

$$= f(m_k) + f'(m_k) \frac{\Delta x_k}{2};$$

(b) $L_k^2 = (\Delta x_k)^2 + (r_2 - r_1)^2$

$$= (\Delta x_k)^2 + \left[f'(m_k) \frac{\Delta x_k}{2} - \left(-f'(m_k) \frac{\Delta x_k}{2}\right)\right]^2$$

$$= (\Delta x_k)^2 + [f'(m_k) \Delta x_k]^2 \Rightarrow L_k = \sqrt{(\Delta x_k)^2 + [f'(m_k) \Delta x_k]^2}, \text{ as claimed}$$

(c) From geometry it is a fact that the lateral surface area of the frustum obtained by revolving the tangent line segment about the x -axis is given by $\Delta S_k = \pi(r_1 + r_2)L_k = \pi[2f(m_k)] \sqrt{(\Delta x_k)^2 + [f'(m_k) \Delta x_k]^2}$ using parts (a) and (b) above. Thus, $\Delta S_k = 2\pi f(m_k) \sqrt{1 + [f'(m_k)]^2} \Delta x_k$.

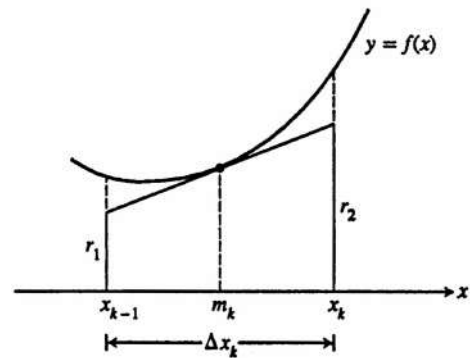

$$(d) S = \lim_{n \rightarrow \infty} \sum_{k=1}^n \Delta S_k = \lim_{n \rightarrow \infty} \sum_{k=1}^n 2\pi f(m_k) \sqrt{1 + [f'(m_k)]^2} \Delta x_k = \int_a^b 2\pi f(x) \sqrt{1 + [f'(x)]^2} dx$$

$$40. S = \int_a^b 2\pi f(x) dx = \int_0^{\sqrt{3}} 2\pi \cdot \frac{x}{\sqrt{3}} dx = \frac{\pi}{\sqrt{3}} [x^2]_0^{\sqrt{3}} = \frac{3\pi}{\sqrt{3}} = \sqrt{3}\pi$$

41. The centroid of the square is located at $(2, 2)$. The volume is $V = (2\pi)(\bar{y})(A) = (2\pi)(2)(8) = 32\pi$ and the surface area is $S = (2\pi)(\bar{y})(L) = (2\pi)(2)(4\sqrt{8}) = 32\sqrt{2}\pi$ (where $\sqrt{8}$ is the length of a side).

42. The midpoint of the hypotenuse of the triangle is $(\frac{3}{2}, 3)$

$\Rightarrow y = 2x$ is an equation of the median \Rightarrow the line $y = 2x$ contains the centroid. The point $(\frac{3}{2}, 3)$ is $\frac{3\sqrt{5}}{2}$ units from the origin \Rightarrow the x-coordinate of the

centroid solves the equation $\sqrt{(x - \frac{3}{2})^2 + (2x - 3)^2}$

$$= \frac{\sqrt{5}}{2} \Rightarrow (x^2 - 3x + \frac{9}{4}) + (4x^2 - 12x + 9) = \frac{5}{4}$$

$$\Rightarrow 5x^2 - 15x + 9 = -1$$

$$\Rightarrow x^2 - 3x + 2 = (x - 2)(x - 1) = 0 \Rightarrow \bar{x} = 1 \text{ since the centroid must lie inside the triangle } \Rightarrow \bar{y} = 2. \text{ By the}$$

Theorem of Pappus, the volume is $V = (\text{distance traveled by the centroid})(\text{area of the region}) = 2\pi(5 - \bar{x}) [\frac{1}{2}(3)(6)]$

$$= (2\pi)(4)(9) = 72\pi$$

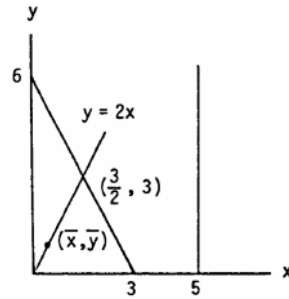

43. The centroid is located at $(2, 0) \Rightarrow V = (2\pi)(\bar{x})(A) = (2\pi)(2)(\pi) = 4\pi^2$

44. We create the cone by revolving the triangle with vertices $(0, 0)$, (h, r) and $(h, 0)$ about the x-axis (see the accompanying figure). Thus, the cone has height h and base radius r . By Theorem of Pappus, the lateral surface area swept out by the hypotenuse L is given by $S = 2\pi\bar{y}L = 2\pi(\frac{r}{2})\sqrt{h^2 + r^2} = \pi r\sqrt{r^2 + h^2}$. To calculate the volume we need the position of the centroid of the triangle. From the diagram we see that

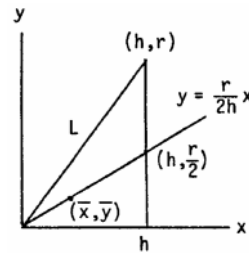

the centroid lies on the line $y = \frac{r}{2h}x$. The x-coordinate of the centroid solves the equation $\sqrt{(x - h)^2 + (\frac{r}{2h}x - \frac{r}{2})^2}$

$$= \frac{1}{3}\sqrt{h^2 + \frac{r^2}{4}} \Rightarrow \left(\frac{4h^2 + r^2}{4h^2}\right)x^2 - \left(\frac{4h^2 + r^2}{2h}\right)x + \frac{r^2}{4} + \frac{2(r^2 + 4h^2)}{9} = 0 \Rightarrow x = \frac{2h}{3} \text{ or } \frac{4h}{3} \Rightarrow \bar{x} = \frac{2h}{3}, \text{ since the centroid must lie}$$

inside the triangle $\Rightarrow \bar{y} = \frac{r}{2h}\bar{x} = \frac{r}{3}$. By the Theorem of Pappus, $V = [2\pi(\frac{r}{3})] (\frac{1}{2}hr) = \frac{1}{3}\pi r^2h$.

$$45. S = 2\pi\bar{y}L \Rightarrow 4\pi a^2 = (2\pi\bar{y})(\pi a) \Rightarrow \bar{y} = \frac{2a}{\pi}, \text{ and by symmetry } \bar{x} = 0$$

$$46. S = 2\pi\rho L \Rightarrow [2\pi(a - \frac{2a}{\pi})](\pi a) = 2\pi a^2(\pi - 2)$$

$$47. V = 2\pi\bar{y}A \Rightarrow \frac{4}{3}\pi ab^2 = (2\pi\bar{y})(\frac{\pi ab}{2}) \Rightarrow \bar{y} = \frac{4b}{3\pi} \text{ and by symmetry } \bar{x} = 0$$

$$48. V = 2\pi\rho A \Rightarrow V = [2\pi(a + \frac{4a}{3\pi})] \left(\frac{\pi a^2}{2}\right) = \frac{\pi a^3(3\pi + 4)}{3}$$

49. $V = 2\pi\rho A = (2\pi)(\text{area of the region}) \cdot (\text{distance from the centroid to the line } y = x - a)$. We must find the distance from $(0, \frac{4a}{3\pi})$ to $y = x - a$. The line containing the centroid and perpendicular to $y = x - a$ has slope -1 and contains the point $(0, \frac{4a}{3\pi})$. This line is $y = -x + \frac{4a}{3\pi}$. The intersection of $y = x - a$ and $y = -x + \frac{4a}{3\pi}$ is the point $(\frac{4a + 3a\pi}{6\pi}, \frac{4a - 3a\pi}{6\pi})$. Thus, the distance from the centroid to the line $y = x - a$ is

$$\sqrt{\left(\frac{4a+3a\pi}{6\pi}\right)^2 + \left(\frac{4a}{3\pi} - \frac{4a}{6\pi} + \frac{3a\pi}{6\pi}\right)^2} = \frac{\sqrt{2}(4a+3a\pi)}{6\pi} \Rightarrow V = (2\pi) \left(\frac{\sqrt{2}(4a+3a\pi)}{6\pi}\right) \left(\frac{\pi a^2}{2}\right) = \frac{\sqrt{2}\pi a^3(4+3\pi)}{6}$$

50. The line perpendicular to $y = x - a$ and passing through the centroid $(0, \frac{2a}{\pi})$ has equation $y = -x + \frac{2a}{\pi}$. The intersection of the two perpendicular lines occurs when $x - a = -x + \frac{2a}{\pi} \Rightarrow x = \frac{2a+a\pi}{2\pi} \Rightarrow y = \frac{2a-a\pi}{2\pi}$. Thus the distance from the centroid to the line $y = x - a$ is $\sqrt{\left(\frac{2a+a\pi}{2} - 0\right)^2 + \left(\frac{2a-a\pi}{2} - \frac{2a}{2}\right)^2} = \frac{a(2+\pi)}{\sqrt{2\pi}}$.

Therefore, by the Theorem of Pappus the surface area is $S = 2\pi \left[\frac{a(2+\pi)}{\sqrt{2\pi}}\right] (\pi a) = \sqrt{2}\pi a^2(2 + \pi)$.

51. From Example 4 and Pappus's Theorem for Volumes we have the moment about the x -axis is $M_x = \bar{y}M$
 $= \left(\frac{4a}{3\pi}\right) \left(\frac{\pi a^2}{2}\right) = \frac{2a^3}{3}$.

6.6 WORK

- The force required to stretch the spring from its natural length of 2 m to a length of 5 m is $F(x) = kx$. The work done by F is $W = \int_0^3 F(x) dx = k \int_0^3 x dx = \frac{k}{2} [x^2]_0^3 = \frac{9k}{2}$. This work is equal to 1800 J $\Rightarrow \frac{9}{2}k = 1800 \Rightarrow k = 400$ N/m
- (a) We find the force constant from Hooke's Law: $F = kx \Rightarrow k = \frac{F}{x} \Rightarrow k = \frac{800}{4} = 200$ lb/in.
 (b) The work done to stretch the spring 2 inches beyond its natural length is $W = \int_0^2 kx dx = 200 \int_0^2 x dx = 200 \left[\frac{x^2}{2}\right]_0^2 = 200(2 - 0) = 400$ in \cdot lb = 33.3 ft \cdot lb
 (c) We substitute $F = 1600$ into the equation $F = 200x$ to find $1600 = 200x \Rightarrow x = 8$ in.
- We find the force constant from Hooke's law: $F = kx$. A force of 2 N stretches the spring to 0.02 m $\Rightarrow 2 = k \cdot (0.02) \Rightarrow k = 100 \frac{\text{N}}{\text{m}}$. The force of 4 N will stretch the rubber band y m, where $F = ky \Rightarrow y = \frac{F}{k} \Rightarrow y = \frac{4\text{N}}{100 \frac{\text{N}}{\text{m}}} \Rightarrow y = 0.04$ m = 4 cm. The work done to stretch the rubber band 0.04 m is $W = \int_0^{0.04} kx dx = 100 \int_0^{0.04} x dx = 100 \left[\frac{x^2}{2}\right]_0^{0.04} = \frac{(100)(0.04)^2}{2} = 0.08$ J
- We find the force constant from Hooke's law: $F = kx \Rightarrow k = \frac{F}{x} \Rightarrow k = \frac{90}{1} \Rightarrow k = 90 \frac{\text{N}}{\text{m}}$. The work done to stretch the spring 5 m beyond its natural length is $W = \int_0^5 kx dx = 90 \int_0^5 x dx = 90 \left[\frac{x^2}{2}\right]_0^5 = (90) \left(\frac{25}{2}\right) = 1125$ J
- (a) We find the spring's constant from Hooke's law: $F = kx \Rightarrow k = \frac{F}{x} = \frac{21,714}{8-5} = \frac{21,714}{3} \Rightarrow k = 7238 \frac{\text{lb}}{\text{in}}$
 (b) The work done to compress the assembly the first half inch is $W = \int_0^{0.5} kx dx = 7238 \int_0^{0.5} x dx = 7238 \left[\frac{x^2}{2}\right]_0^{0.5} = (7238) \frac{(0.5)^2}{2} = \frac{(7238)(0.25)}{2} \approx 905$ in \cdot lb. The work done to compress the assembly the second half inch is: $W = \int_{0.5}^{1.0} kx dx = 7238 \int_{0.5}^{1.0} x dx = 7238 \left[\frac{x^2}{2}\right]_{0.5}^{1.0} = \frac{7238}{2} [1 - (0.5)^2] = \frac{(7238)(0.75)}{2} \approx 2714$ in \cdot lb
- First, we find the force constant from Hooke's law: $F = kx \Rightarrow k = \frac{F}{x} = \frac{150}{\left(\frac{1}{16}\right)} = 16 \cdot 150 = 2,400 \frac{\text{lb}}{\text{in}}$. If someone compresses the scale $x = \frac{1}{8}$ in, he/she must weigh $F = kx = 2,400 \left(\frac{1}{8}\right) = 300$ lb. The work done to compress the scale this far is $W = \int_0^{1/8} kx dx = 2400 \left[\frac{x^2}{2}\right]_0^{1/8} = \frac{2400}{2 \cdot 64} = 18.75$ lb \cdot in. = $\frac{25}{16}$ ft \cdot lb

7. The force required to haul up the rope is equal to the rope's weight, which varies steadily and is proportional to x , the length of the rope still hanging: $F(x) = 0.624x$. The work done is: $W = \int_0^{50} F(x) dx = \int_0^{50} 0.624x dx$
 $= 0.624 \left[\frac{x^2}{2} \right]_0^{50} = 780 \text{ J}$
8. The weight of sand decreases steadily by 72 lb over the 18 ft, at 4 lb/ft. So the weight of sand when the bag is x ft off the ground is $F(x) = 144 - 4x$. The work done is: $W = \int_a^b F(x) dx = \int_0^{18} (144 - 4x) dx = [144x - 2x^2]_0^{18} = 1944 \text{ ft} \cdot \text{lb}$
9. The force required to lift the cable is equal to the weight of the cable paid out: $F(x) = (4.5)(180 - x)$ where x is the position of the car off the first floor. The work done is: $W = \int_0^{180} F(x) dx = 4.5 \int_0^{180} (180 - x) dx$
 $= 4.5 \left[180x - \frac{x^2}{2} \right]_0^{180} = 4.5 \left(180^2 - \frac{180^2}{2} \right) = \frac{4.5 \cdot 180^2}{2} = 72,900 \text{ ft} \cdot \text{lb}$
10. Since the force is acting toward the origin, it acts opposite to the positive x -direction. Thus $F(x) = -\frac{k}{x^2}$. The work done is $W = \int_a^b -\frac{k}{x^2} dx = k \int_a^b -\frac{1}{x^2} dx = k \left[\frac{1}{x} \right]_a^b = k \left(\frac{1}{b} - \frac{1}{a} \right) = \frac{k(a-b)}{ab}$
11. The force against the piston is $F = pA$. If $V = Ax$, where x is the height of the cylinder, then $dV = A dx$
 $\Rightarrow \text{Work} = \int F dx = \int pA dx = \int_{(p_1, V_1)}^{(p_2, V_2)} p dV$.
12. $pV^{1.4} = c$, a constant $\Rightarrow p = cV^{-1.4}$. If $V_1 = 243 \text{ in}^3$ and $p_1 = 50 \text{ lb/in}^3$, then $c = (50)(243)^{1.4} = 109,350 \text{ lb}$.
 Thus $W = \int_{243}^{32} 109,350V^{-1.4} dV = \left[-\frac{109,350}{0.4V^{0.4}} \right]_{243}^{32} = -\frac{109,350}{0.4} \left(\frac{1}{32^{0.4}} - \frac{1}{243^{0.4}} \right) = -\frac{109,350}{0.4} \left(\frac{1}{4} - \frac{1}{9} \right)$
 $= -\frac{(109,350)(5)}{(0.4)(36)} = -37,968.75 \text{ in} \cdot \text{lb}$. Note that when a system is compressed, the work done by the system is negative.
13. Let r = the constant rate of leakage. Since the bucket is leaking at a constant rate and the bucket is rising at a constant rate, the amount of water in the bucket is proportional to $(20 - x)$, the distance the bucket is being raised. The leakage rate of the water is 0.8 lb/ft raised and the weight of the water in the bucket is $F = 0.8(20 - x)$. So:
 $W = \int_0^{20} 0.8(20 - x) dx = 0.8 \left[20x - \frac{x^2}{2} \right]_0^{20} = 160 \text{ ft} \cdot \text{lb}$.
14. Let r = the constant rate of leakage. Since the bucket is leaking at a constant rate and the bucket is rising at a constant rate, the amount of water in the bucket is proportional to $(20 - x)$, the distance the bucket is being raised. The leakage rate of the water is 2 lb/ft raised and the weight of the water in the bucket is $F = 2(20 - x)$. So:
 $W = \int_0^{20} 2(20 - x) dx = 2 \left[20x - \frac{x^2}{2} \right]_0^{20} = 400 \text{ ft} \cdot \text{lb}$.
 Note that since the force in Exercise 14 is 2.5 times the force in Exercise 13 at each elevation, the total work is also 2.5 times as great.

15. We will use the coordinate system given.

- (a) The typical slab between the planes at y and $y + \Delta y$ has a volume of $\Delta V = (10)(12) \Delta y = 120 \Delta y \text{ ft}^3$. The force F required to lift the slab is equal to its weight:
 $F = 62.4 \Delta V = 62.4 \cdot 120 \Delta y \text{ lb}$. The distance through which F must act is about y ft, so the work done lifting the slab is about $\Delta W = \text{force} \times \text{distance}$
 $= 62.4 \cdot 120 \cdot y \cdot \Delta y \text{ ft} \cdot \text{lb}$. The work it takes to lift all the water is approximately $W \approx \sum_0^{20} \Delta W$

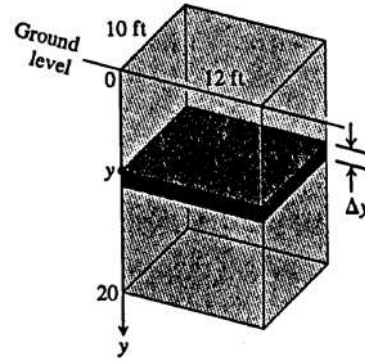

$$= \sum_0^{20} 62.4 \cdot 120y \cdot \Delta y \text{ ft} \cdot \text{lb}. \text{ This is a Riemann sum for}$$

the function $62.4 \cdot 120y$ over the interval $0 \leq y \leq 20$. The work of pumping the tank empty is the limit of these sums:

$$W = \int_0^{20} 62.4 \cdot 120y \, dy = (62.4)(120) \left[\frac{y^2}{2} \right]_0^{20} = (62.4)(120) \left(\frac{400}{2} \right) = (62.4)(120)(200) = 1,497,600 \text{ ft} \cdot \text{lb}$$

- (b) The time t it takes to empty the full tank with $\left(\frac{5}{11}\right)$ -hp motor is $t = \frac{W}{250 \frac{\text{ft} \cdot \text{lb}}{\text{sec}}} = \frac{1,497,600 \text{ ft} \cdot \text{lb}}{250 \frac{\text{ft} \cdot \text{lb}}{\text{sec}}} = 5990.4 \text{ sec}$
 $= 1.664 \text{ hr} \Rightarrow t \approx 1 \text{ hr and } 40 \text{ min}$

- (c) Following all the steps of part (a), we find that the work it takes to lower the water level 10 ft is

$$W = \int_0^{10} 62.4 \cdot 120y \, dy = (62.4)(120) \left[\frac{y^2}{2} \right]_0^{10} = (62.4)(120) \left(\frac{100}{2} \right) = 374,400 \text{ ft} \cdot \text{lb} \text{ and the time is } t = \frac{W}{250 \frac{\text{ft} \cdot \text{lb}}{\text{sec}}}$$

$$= 1497.6 \text{ sec} = 0.416 \text{ hr} \approx 25 \text{ min}$$

- (d) In a location where water weighs $62.26 \frac{\text{lb}}{\text{ft}^3}$:

a) $W = (62.26)(24,000) = 1,494,240 \text{ ft} \cdot \text{lb}$.

b) $t = \frac{1,494,240}{250} = 5976.96 \text{ sec} \approx 1.660 \text{ hr} \Rightarrow t \approx 1 \text{ hr and } 40 \text{ min}$

In a location where water weighs $62.59 \frac{\text{lb}}{\text{ft}^3}$

a) $W = (62.59)(24,000) = 1,502,160 \text{ ft} \cdot \text{lb}$

b) $t = \frac{1,502,160}{250} = 6008.64 \text{ sec} \approx 1.669 \text{ hr} \Rightarrow t \approx 1 \text{ hr and } 40.1 \text{ min}$

16. We will use the coordinate system given.

- (a) The typical slab between the planes at y and $y + \Delta y$ has a volume of $\Delta V = (20)(12) \Delta y = 240 \Delta y \text{ ft}^3$. The force F required to lift the slab is equal to its weight:
 $F = 62.4 \Delta V = 62.4 \cdot 240 \Delta y \text{ lb}$. The distance through which F must act is about y ft, so the work done lifting the slab is about $\Delta W = \text{force} \times \text{distance}$

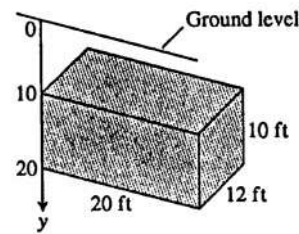

$$= 62.4 \cdot 240 \cdot y \cdot \Delta y \text{ ft} \cdot \text{lb}. \text{ The work it takes to lift all the water is approximately } W \approx \sum_{10}^{20} \Delta W$$

$$= \sum_{10}^{20} 62.4 \cdot 240y \cdot \Delta y \text{ ft} \cdot \text{lb}. \text{ This is a Riemann sum for the function } 62.4 \cdot 240y \text{ over the interval}$$

$10 \leq y \leq 20$. The work it takes to empty the cistern is the limit of these sums: $W = \int_{10}^{20} 62.4 \cdot 240y \, dy$

$$= (62.4)(240) \left[\frac{y^2}{2} \right]_{10}^{20} = (62.4)(240)(200 - 50) = (62.4)(240)(150) = 2,246,400 \text{ ft} \cdot \text{lb}$$

- (b) $t = \frac{W}{275 \frac{\text{ft} \cdot \text{lb}}{\text{sec}}} = \frac{2,246,400 \text{ ft} \cdot \text{lb}}{275} \approx 8168.73 \text{ sec} \approx 2.27 \text{ hours} \approx 2 \text{ hr and } 16.1 \text{ min}$

- (c) Following all the steps of part (a), we find that the work it takes to empty the tank halfway is

$$W = \int_{10}^{15} 62.4 \cdot 240y \, dy = (62.4)(240) \left[\frac{y^2}{2} \right]_{10}^{15} = (62.4)(240) \left(\frac{225}{2} - \frac{100}{2} \right) = (62.4)(240) \left(\frac{125}{2} \right) = 936,000 \text{ ft} \cdot \text{lb}$$

Then the time is $t = \frac{W}{275 \frac{\text{ft} \cdot \text{lb}}{\text{sec}}} = \frac{936,000}{275} \approx 3403.64 \text{ sec} \approx 56.7 \text{ min}$

(d) In a location where water weighs $62.26 \frac{\text{lb}}{\text{ft}^3}$:

a) $W = (62.26)(240)(150) = 2,241,360 \text{ ft} \cdot \text{lb}$.

b) $t = \frac{2,241,360}{275} = 8150.40 \text{ sec} = 2.264 \text{ hours} \approx 2 \text{ hr and } 15.8 \text{ min}$

c) $W = (62.26)(240) \left(\frac{125}{2}\right) = 933,900 \text{ ft} \cdot \text{lb}$; $t = \frac{933,900}{275} = 3396 \text{ sec} \approx 0.94 \text{ hours} \approx 56.6 \text{ min}$

In a location where water weighs $62.59 \frac{\text{lb}}{\text{ft}^3}$:

a) $W = (62.59)(240)(150) = 2,253,240 \text{ ft} \cdot \text{lb}$.

b) $t = \frac{2,253,240}{275} = 8193.60 \text{ sec} = 2.276 \text{ hours} \approx 2 \text{ hr and } 16.56 \text{ min}$

c) $W = (62.59)(240) \left(\frac{125}{2}\right) = 938,850 \text{ ft} \cdot \text{lb}$; $t = \frac{938,850}{275} \approx 3414 \text{ sec} \approx 0.95 \text{ hours} \approx 56.9 \text{ min}$

17. The slab is a disk of area $\pi x^2 = \pi \left(\frac{y}{2}\right)^2$, thickness Δy , and height below the top of the tank $(10 - y)$. So the work to pump the oil in this slab, ΔW , is $57(10 - y)\pi \left(\frac{y}{2}\right)^2$. The work to pump all the oil to the top of the tank is

$$W = \int_0^{10} \frac{57\pi}{4} (10y^2 - y^3) dy = \frac{57\pi}{4} \left[\frac{10y^3}{3} - \frac{y^4}{4} \right]_0^{10} = 11,875\pi \text{ ft} \cdot \text{lb} \approx 37,306 \text{ ft} \cdot \text{lb}.$$

18. Each slab of oil is to be pumped to a height of 14 ft. So the work to pump a slab is $(14 - y)(\pi) \left(\frac{y}{2}\right)^2$ and since the tank is half full and the volume of the original cone is $V = \frac{1}{3}\pi r^2 h = \frac{1}{3}\pi(5^2)(10) = \frac{250\pi}{3} \text{ ft}^3$, half the volume $= \frac{250\pi}{6} \text{ ft}^3$, and

with half the volume the cone is filled to a height y , $\frac{250\pi}{6} = \frac{1}{3}\pi \frac{y^2}{4} y \Rightarrow y = \sqrt[3]{500} \text{ ft}$. So $W = \int_0^{\sqrt[3]{500}} \frac{57\pi}{4} (14y^2 - y^3) dy$
 $= \frac{57\pi}{4} \left[\frac{14y^3}{3} - \frac{y^4}{4} \right]_0^{\sqrt[3]{500}} \approx 60,042 \text{ ft} \cdot \text{lb}.$

19. The typical slab between the planes at y and $y + \Delta y$ has a volume of $\Delta V = \pi(\text{radius})^2(\text{thickness}) = \pi \left(\frac{20}{2}\right)^2 \Delta y = \pi \cdot 100 \Delta y \text{ ft}^3$. The force F required to lift the slab is equal to its weight: $F = 51.2 \Delta V = 51.2 \cdot 100\pi \Delta y \text{ lb}$

$\Rightarrow F = 5120\pi \Delta y \text{ lb}$. The distance through which F must act is about $(30 - y) \text{ ft}$. The work it takes to lift all the

kerosene is approximately $W \approx \sum_0^{30} \Delta W = \sum_0^{30} 5120\pi(30 - y) \Delta y \text{ ft} \cdot \text{lb}$ which is a Riemann sum. The work to pump the

tank dry is the limit of these sums: $W = \int_0^{30} 5120\pi(30 - y) dy = 5120\pi \left[30y - \frac{y^2}{2} \right]_0^{30} = 5120\pi \left(\frac{900}{2}\right) = (5120)(450\pi) \approx 7,238,229.48 \text{ ft} \cdot \text{lb}$

20. (Alternate Solution) Each method must pump all of the water the 15 ft to the base of the tank. Pumping to the rim requires all the water to be pumped an additional 6 feet. Pumping into the bottom requires that the water be pumped an average of 3 additional feet. Thus pumping through the valve requires $\sqrt{3} \text{ ft}(4\pi)6 \text{ ft}^3(62.4 \text{ lb/ft}^3) \approx 14,115 \text{ ft} \cdot \text{lb}$ less work and thus less time.

21. (a) Follow all the steps of Example 5 but make the substitution of $64.5 \frac{\text{lb}}{\text{ft}^3}$ for $57 \frac{\text{lb}}{\text{ft}^3}$. Then,

$$W = \int_0^8 \frac{64.5\pi}{4} (10 - y)y^2 dy = \frac{64.5\pi}{4} \left[\frac{10y^3}{3} - \frac{y^4}{4} \right]_0^8 = \frac{64.5\pi}{4} \left(\frac{10 \cdot 8^3}{3} - \frac{8^4}{4} \right) = \left(\frac{64.5\pi}{4} \right) (8^3) \left(\frac{10}{3} - 2 \right) \\ = \frac{64.5\pi \cdot 8^3}{3} = 21.5\pi \cdot 8^3 \approx 34,582.65 \text{ ft} \cdot \text{lb}$$

(b) Exactly as done in Example 5 but change the distance through which F acts to distance $\approx (13 - y) \text{ ft}$.

$$\text{Then } W = \int_0^8 \frac{57\pi}{4} (13 - y)y^2 dy = \frac{57\pi}{4} \left[\frac{13y^3}{3} - \frac{y^4}{4} \right]_0^8 = \frac{57\pi}{4} \left(\frac{13 \cdot 8^3}{3} - \frac{8^4}{4} \right) = \left(\frac{57\pi}{4} \right) (8^3) \left(\frac{13}{3} - 2 \right) = \frac{57\pi \cdot 8^3 \cdot 7}{3 \cdot 4} \\ = (19\pi)(8^2)(7)(2) \approx 53,482.5 \text{ ft} \cdot \text{lb}$$

22. The typical slab between the planes of y and $y + \Delta y$ has a volume of about $\Delta V = \pi(\text{radius})^2(\text{thickness})$

$$= \pi(\sqrt{y})^2 \Delta y = \pi y \Delta y \text{ m}^3. \text{ The force } F(y) \text{ is equal to the slab's weight: } F(y) = 10,000 \frac{\text{N}}{\text{m}^3} \cdot \Delta V$$

$= \pi 10,000 y \Delta y \text{ N}$. The height of the tank is $4^2 = 16 \text{ m}$. The distance through which $F(y)$ must act to lift the slab to the level of the top of the tank is about $(16 - y) \text{ m}$, so the work done lifting the slab is about

$\Delta W = 10,000\pi y(16 - y) \Delta y$ N · m. The work done lifting all the slabs from $y = 0$ to $y = 16$ to the top is approximately $W \approx \sum_0^{16} 10,000\pi y(16 - y) \Delta y$. Taking the limit of these Riemann sums, we get

$$W = \int_0^{16} 10,000\pi y(16 - y) dy = 10,000\pi \int_0^{16} (16y - y^2) dy = 10,000\pi \left[\frac{16y^2}{2} - \frac{y^3}{3} \right]_0^{16} = 10,000\pi \left(\frac{16^3}{2} - \frac{16^3}{3} \right) \\ = \frac{10,000 \cdot \pi \cdot 16^3}{6} \approx 21,446,605.9 \text{ J}$$

23. The typical slab between the planes at y and $y + \Delta y$ has a volume of about $\Delta V = \pi(\text{radius})^2(\text{thickness})$
 $= \pi(\sqrt{25 - y^2})^2 \Delta y \text{ m}^3$. The force $F(y)$ required to lift this slab is equal to its weight: $F(y) = 9800 \cdot \Delta V$
 $= 9800\pi(\sqrt{25 - y^2})^2 \Delta y = 9800\pi(25 - y^2) \Delta y$ N. The distance through which $F(y)$ must act to lift the slab to the level of 4 m above the top of the reservoir is about $(4 - y)$ m, so the work done is approximately $\Delta W \approx 9800\pi(25 - y^2)(4 - y) \Delta y$ N · m. The work done lifting all the slabs from $y = -5$ m to $y = 0$ m is approximately $W \approx \sum_{-5}^0 9800\pi(25 - y^2)(4 - y) \Delta y$ N · m. Taking the limit of these Riemann sums, we get

$$W = \int_{-5}^0 9800\pi(25 - y^2)(4 - y) dy = 9800\pi \int_{-5}^0 (100 - 25y - 4y^2 + y^3) dy = 9800\pi \left[100y - \frac{25}{2}y^2 - \frac{4}{3}y^3 + \frac{y^4}{4} \right]_{-5}^0 \\ = -9800\pi \left(-500 - \frac{25 \cdot 25}{2} + \frac{4}{3} \cdot 125 + \frac{625}{4} \right) \approx 15,073,099.75 \text{ J}$$

24. The typical slab between the planes at y and $y + \Delta y$ has a volume of about $\Delta V = \pi(\text{radius})^2(\text{thickness})$
 $= \pi(\sqrt{100 - y^2})^2 \Delta y = \pi(100 - y^2) \Delta y \text{ ft}^3$. The force is $F(y) = \frac{56 \text{ lb}}{\text{ft}^3} \cdot \Delta V = 56\pi(100 - y^2) \Delta y$ lb. The distance through which $F(y)$ must act to lift the slab to the level of 2 ft above the top of the tank is about $(12 - y)$ ft, so the work done is $\Delta W \approx 56\pi(100 - y^2)(12 - y) \Delta y$ lb · ft. The work done lifting all the slabs from $y = 0$ ft to $y = 10$ ft is approximately $W \approx \sum_0^{10} 56\pi(100 - y^2)(12 - y) \Delta y$ lb · ft. Taking the limit of these

$$\text{Riemann sums, we get } W = \int_0^{10} 56\pi(100 - y^2)(12 - y) dy = 56\pi \int_0^{10} (100 - y^2)(12 - y) dy \\ = 56\pi \int_0^{10} (1200 - 100y - 12y^2 + y^3) dy = 56\pi \left[1200y - \frac{100y^2}{2} - \frac{12y^3}{3} + \frac{y^4}{4} \right]_0^{10} \\ = 56\pi \left(12,000 - \frac{10,000}{2} - 4 \cdot 1000 + \frac{10,000}{4} \right) = (56\pi) \left(12 - 5 - 4 + \frac{5}{2} \right) (1000) \approx 967,611 \text{ ft} \cdot \text{lb}.$$

It would cost $(0.5)(967,611) = 483,805\text{¢} = \4838.05 . Yes, you can afford to hire the firm.

25. $F = m \frac{dv}{dt} = mv \frac{dv}{dx}$ by the chain rule $\Rightarrow W = \int_{x_1}^{x_2} mv \frac{dv}{dx} dx = m \int_{x_1}^{x_2} \left(v \frac{dv}{dx} \right) dx = m \left[\frac{1}{2} v^2(x) \right]_{x_1}^{x_2}$
 $= \frac{1}{2} m [v^2(x_2) - v^2(x_1)] = \frac{1}{2} mv_2^2 - \frac{1}{2} mv_1^2$, as claimed.

26. weight = 2 oz = $\frac{2}{16}$ lb; mass = $\frac{\text{weight}}{32} = \frac{\frac{1}{8}}{32} = \frac{1}{256}$ slugs; $W = \left(\frac{1}{2}\right) \left(\frac{1}{256} \text{ slugs}\right) (160 \text{ ft/sec})^2 \approx 50 \text{ ft} \cdot \text{lb}$

27. 90 mph = $\frac{90 \text{ mi}}{1 \text{ hr}} \cdot \frac{1 \text{ hr}}{60 \text{ min}} \cdot \frac{1 \text{ min}}{60 \text{ sec}} \cdot \frac{5280 \text{ ft}}{1 \text{ mi}} = 132 \text{ ft/sec}$; $m = \frac{0.3125 \text{ lb}}{32 \text{ ft/sec}^2} = \frac{0.3125}{32}$ slugs;
 $W = \left(\frac{1}{2}\right) \left(\frac{0.3125 \text{ lb}}{32 \text{ ft/sec}^2}\right) (132 \text{ ft/sec})^2 \approx 85.1 \text{ ft} \cdot \text{lb}$

28. weight = 1.6 oz = 0.1 lb $\Rightarrow m = \frac{0.1 \text{ lb}}{32 \text{ ft/sec}^2} = \frac{1}{320}$ slugs; $W = \left(\frac{1}{2}\right) \left(\frac{1}{320} \text{ slugs}\right) (280 \text{ ft/sec})^2 = 122.5 \text{ ft} \cdot \text{lb}$

29. weight = 2 oz = $\frac{1}{8}$ lb $\Rightarrow m = \frac{\frac{1}{8}}{32} \text{ slugs} = \frac{1}{256}$ slugs; 124 mph = $\frac{(124)(5280)}{(60)(60)} \approx 181.87 \text{ ft/sec}$;
 $W = \left(\frac{1}{2}\right) \left(\frac{1}{256} \text{ slugs}\right) (181.87 \text{ ft/sec})^2 \approx 64.6 \text{ ft} \cdot \text{lb}$

30. weight = 14.5 oz = $\frac{14.5}{16}$ lb $\Rightarrow m = \frac{14.5}{(16)(32)} \text{ slugs}$; $W = \left(\frac{1}{2}\right) \left(\frac{14.5}{(16)(32)} \text{ slugs}\right) (88 \text{ ft/sec})^2 \approx 109.7 \text{ ft} \cdot \text{lb}$

31. weight = 6.5 oz = $\frac{6.5}{16}$ lb $\Rightarrow m = \frac{6.5}{(16)(32)} \text{ slugs}$; $W = \left(\frac{1}{2}\right) \left(\frac{6.5}{(16)(32)} \text{ slugs}\right) (132 \text{ ft/sec})^2 \approx 110.6 \text{ ft} \cdot \text{lb}$

32. $F = (18 \text{ lb/ft})x \Rightarrow W = \int_0^{1/6} 18x \, dx = [9x^2]_0^{1/6} = \frac{1}{4} \text{ ft} \cdot \text{lb}$. Now $W = \frac{1}{2} mv^2 - \frac{1}{2} mv_1^2$, where $W = \frac{1}{4} \text{ ft} \cdot \text{lb}$, $m = \frac{\frac{1}{32}}{\frac{1}{256}} = \frac{1}{256} \text{ slugs}$ and $v_1 = 0 \text{ ft/sec}$. Thus, $\frac{1}{4} \text{ ft} \cdot \text{lb} = (\frac{1}{2}) (\frac{1}{256} \text{ slugs}) v^2 \Rightarrow v = 8\sqrt{2} \text{ ft/sec}$. With $v = 0$ at the top of the bearing's path and $v = 8\sqrt{2} - 32t \Rightarrow t = \frac{\sqrt{2}}{4} \text{ sec}$ when the bearing is at the top of its path. The height the bearing reaches is $s = 8\sqrt{2}t - 16t^2 \Rightarrow$ at $t = \frac{\sqrt{2}}{4}$ the bearing reaches a height of $(8\sqrt{2}) (\frac{\sqrt{2}}{4}) - (16) (\frac{\sqrt{2}}{4})^2 = 2 \text{ ft}$

33. (a) From the diagram,

$$r(y) = 60 - x = 60 - \sqrt{50^2 - (y - 325)^2}$$

for $325 \leq y \leq 375$ ft.

(b) The volume of a horizontal slice of the funnel

$$\begin{aligned} \text{is } \Delta V &\approx \pi [r(y)]^2 \Delta y \\ &= \pi \left[60 - \sqrt{50^2 - (y - 325)^2} \right]^2 \Delta y \end{aligned}$$

(c) The work required to lift the single slice of water is $\Delta W \approx 62.4 \Delta V (375 - y)$

$$= 62.4(375 - y) \pi \left[60 - \sqrt{50^2 - (y - 325)^2} \right]^2 \Delta y.$$

The total work to pump out the funnel is W

$$\begin{aligned} &= \int_{325}^{375} 62.4(375 - y) \pi \left[60 - \sqrt{50^2 - (y - 325)^2} \right]^2 dy \\ &\approx 6.3358 \cdot 10^7 \text{ ft} \cdot \text{lb}. \end{aligned}$$

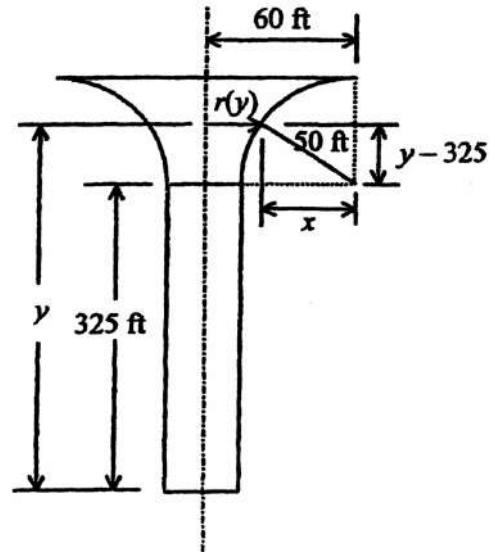

34. (a) From the result in Example 6, the work to pump out the throat is 1,353,869,354 ft · lb. Therefore, the total work required to pump out the throat and the funnel is 1,353,869,354 + 63,358,000 = 1,417,227,354 ft · lb.

(b) In horsepower-hours, the work required to pump out the glory hole is $\frac{1,417,227,354}{1.98 \cdot 10^6} = 715.8$. Therefore, it would take $\frac{715.8 \text{ hp} \cdot \text{h}}{1000 \text{ hp}} = 0.7158 \text{ hours} \approx 43 \text{ minutes}$.

35. We imagine the milkshake divided into thin slabs by planes perpendicular to the y-axis at the points of a partition of the interval [0, 7]. The typical slab between the planes at y and y + Δy has a volume of about $\Delta V = \pi(\text{radius})^2(\text{thickness}) = \pi \left(\frac{y+17.5}{14} \right)^2 \Delta y \text{ in}^3$. The force F(y) required to lift this slab is equal to its weight: $F(y) = \frac{4}{9} \Delta V = \frac{4\pi}{9} \left(\frac{y+17.5}{14} \right)^2 \Delta y \text{ oz}$. The distance through which F(y) must act to lift this slab to the level of 1 inch above the top is about (8 - y) in. The work done lifting the slab is about

$$\Delta W = \left(\frac{4\pi}{9} \right) \frac{(y+17.5)^2}{14^2} (8 - y) \Delta y \text{ in} \cdot \text{oz}.$$

The work done lifting all the slabs from y = 0 to y = 7 is approximately $W = \sum_0^7 \frac{4\pi}{9 \cdot 14^2} (y + 17.5)^2 (8 - y) \Delta y \text{ in} \cdot \text{oz}$ which is a Riemann sum. The work is the limit of

$$\begin{aligned} \text{these sums as the norm of the partition goes to zero: } W &= \int_0^7 \frac{4\pi}{9 \cdot 14^2} (y + 17.5)^2 (8 - y) dy \\ &= \frac{4\pi}{9 \cdot 14^2} \int_0^7 (2450 - 26.25y - 27y^2 - y^3) dy = \frac{4\pi}{9 \cdot 14^2} \left[-\frac{y^4}{4} - 9y^3 - \frac{26.25}{2} y^2 + 2450y \right]_0^7 \\ &= \frac{4\pi}{9 \cdot 14^2} \left[-\frac{7^4}{4} - 9 \cdot 7^3 - \frac{26.25}{2} \cdot 7^2 + 2450 \cdot 7 \right] \approx 91.32 \text{ in} \cdot \text{oz} \end{aligned}$$

36. We fill the pipe and the tank. To find the work required to fill the tank follow Example 6 with radius = 10 ft. Then $\Delta V = \pi \cdot 100 \Delta y \text{ ft}^3$. The force required will be $F = 62.4 \cdot \Delta V = 62.4 \cdot 100\pi \Delta y = 6240\pi \Delta y \text{ lb}$. The distance through which F must act is y so the work done lifting the slab is about $\Delta W_1 = 6240\pi \cdot y \cdot \Delta y \text{ lb} \cdot \text{ft}$. The work it takes to

lift all the water into the tank is: $W_1 \approx \sum_{360}^{385} \Delta W_1 = \sum_{360}^{385} 6240\pi \cdot y \cdot \Delta y$ lb · ft. Taking the limit we end up with

$$W_1 = \int_{360}^{385} 6240\pi y \, dy = 6240\pi \left[\frac{y^2}{2} \right]_{360}^{385} = \frac{6240\pi}{2} [385^2 - 360^2] \approx 182,557,949 \text{ ft} \cdot \text{lb}$$

To find the work required to fill the pipe, do as above, but take the radius to be $\frac{4}{2}$ in = $\frac{1}{6}$ ft.

Then $\Delta V = \pi \cdot \frac{1}{36} \Delta y$ ft³ and $F = 62.4 \cdot \Delta V = \frac{62.4\pi}{36} \Delta y$. Also take different limits of summation and

$$\text{integration: } W_2 \approx \sum_0^{360} \Delta W_2 \Rightarrow W_2 = \int_0^{360} \frac{62.4}{36} \pi y \, dy = \frac{62.4\pi}{36} \left[\frac{y^2}{2} \right]_0^{360} = \left(\frac{62.4\pi}{36} \right) \left(\frac{360^2}{2} \right) \approx 352,864 \text{ ft} \cdot \text{lb}.$$

The total work is $W = W_1 + W_2 \approx 182,557,949 + 352,864 \approx 182,910,813$ ft · lb. The time it takes to fill the tank and the pipe is $\text{Time} = \frac{W}{1650} \approx \frac{182,910,813}{1650} \approx 110,855 \text{ sec} \approx 31 \text{ hr}$

$$\begin{aligned} 37. \text{ Work} &= \int_{6,370,000}^{35,780,000} \frac{1000 \text{ MG}}{r^2} \, dr = 1000 \text{ MG} \int_{6,370,000}^{35,780,000} \frac{dr}{r^2} = 1000 \text{ MG} \left[-\frac{1}{r} \right]_{6,370,000}^{35,780,000} \\ &= (1000) (5.975 \cdot 10^{24}) (6.672 \cdot 10^{-11}) \left(\frac{1}{6,370,000} - \frac{1}{35,780,000} \right) \approx 5.144 \times 10^{10} \text{ J} \end{aligned}$$

$$\begin{aligned} 38. \text{ (a) Let } \rho &\text{ be the x-coordinate of the second electron. Then } r^2 = (\rho - 1)^2 \Rightarrow W = \int_{-1}^0 F(\rho) \, d\rho \\ &= \int_{-1}^0 \frac{(23 \times 10^{-29})}{(\rho - 1)^2} \, d\rho = - \left[\frac{23 \times 10^{-29}}{\rho - 1} \right]_{-1}^0 = (23 \times 10^{-29}) \left(1 - \frac{1}{2} \right) = 11.5 \times 10^{-29} \end{aligned}$$

(b) $W = W_1 + W_2$ where W_1 is the work done against the field of the first electron and W_2 is the work done against the field of the second electron. Let ρ be the x-coordinate of the third electron. Then $r_1^2 = (\rho - 1)^2$

$$\begin{aligned} \text{and } r_2^2 &= (\rho + 1)^2 \Rightarrow W_1 = \int_3^5 \frac{23 \times 10^{-29}}{r_1^2} \, d\rho = \int_3^5 \frac{23 \times 10^{-29}}{(\rho - 1)^2} \, d\rho = -23 \times 10^{-29} \left[\frac{1}{\rho - 1} \right]_3^5 \\ &= (-23 \times 10^{-29}) \left(\frac{1}{4} - \frac{1}{2} \right) = \frac{23}{4} \times 10^{-29}, \text{ and } W_2 = \int_3^5 \frac{23 \times 10^{-29}}{r_2^2} \, d\rho = \int_3^5 \frac{23 \times 10^{-29}}{(\rho + 1)^2} \, d\rho \\ &= -23 \times 10^{-29} \left[\frac{1}{\rho + 1} \right]_3^5 = (-23 \times 10^{-29}) \left(\frac{1}{6} - \frac{1}{4} \right) = \frac{23 \times 10^{-29}}{12} (3 - 2) = \frac{23}{12} \times 10^{-29}. \text{ Therefore} \\ W &= W_1 + W_2 = \left(\frac{23}{4} \times 10^{-29} \right) + \left(\frac{23}{12} \times 10^{-29} \right) = \frac{23}{3} \times 10^{-29} \approx 7.67 \times 10^{-29} \text{ J} \end{aligned}$$

6.7 FLUID PRESSURES AND FORCES

1. To find the width of the plate at a typical depth y , we first find an equation for the line of the plate's right-hand edge: $y = x - 5$. If we let x denote the width of the right-hand half of the triangle at depth y , then $x = 5 + y$ and the total width is $L(y) = 2x = 2(5 + y)$. The depth of the strip is $(-y)$. The force exerted by the

$$\begin{aligned} \text{water against one side of the plate is therefore } F &= \int_{-5}^{-2} w(-y) \cdot L(y) \, dy = \int_{-5}^{-2} 62.4 \cdot (-y) \cdot 2(5 + y) \, dy \\ &= 124.8 \int_{-5}^{-2} (-5y - y^2) \, dy = 124.8 \left[-\frac{5}{2}y^2 - \frac{1}{3}y^3 \right]_{-5}^{-2} = 124.8 \left[\left(-\frac{5}{2} \cdot 4 + \frac{1}{3} \cdot 8 \right) - \left(-\frac{5}{2} \cdot 25 + \frac{1}{3} \cdot 125 \right) \right] \\ &= (124.8) \left(\frac{105}{2} - \frac{117}{3} \right) = (124.8) \left(\frac{315 - 234}{6} \right) = 1684.8 \text{ lb} \end{aligned}$$

2. An equation for the line of the plate's right-hand edge is $y = x - 3 \Rightarrow x = y + 3$. Thus the total width is $L(y) = 2x = 2(y + 3)$. The depth of the strip is $(2 - y)$. The force exerted by the water is

$$\begin{aligned} F &= \int_{-3}^0 w(2 - y)L(y) \, dy = \int_{-3}^0 62.4 \cdot (2 - y) \cdot 2(3 + y) \, dy = 124.8 \int_{-3}^0 (6 - y - y^2) \, dy = 124.8 \left[6y - \frac{y^2}{2} - \frac{y^3}{3} \right]_{-3}^0 \\ &= (-124.8) \left(-18 - \frac{9}{2} + 9 \right) = (-124.8) \left(-\frac{27}{2} \right) = 1684.8 \text{ lb} \end{aligned}$$

3. Using the coordinate system of Exercise 4, we find the equation for the line of the plate's right-hand edge is $y = x - 3 \Rightarrow x = y + 3$. Thus the total width is $L(y) = 2x = 2(y + 3)$. The depth of the strip changes to $(4 - y)$

$$\begin{aligned} \Rightarrow F &= \int_{-3}^0 w(4 - y)L(y) \, dy = \int_{-3}^0 62.4 \cdot (4 - y) \cdot 2(y + 3) \, dy = 124.8 \int_{-3}^0 (12 + y - y^2) \, dy \\ &= 124.8 \left[12y + \frac{y^2}{2} - \frac{y^3}{3} \right]_{-3}^0 = (-124.8) \left(-36 + \frac{9}{2} + 9 \right) = (-124.8) \left(-\frac{45}{2} \right) = 2808 \text{ lb} \end{aligned}$$

4. Using the coordinate system of Exercise 4, we see that the equation for the line of the plate's right-hand edge remains the same: $y = x - 3 \Rightarrow x = 3 + y$ and $L(y) = 2x = 2(y + 3)$. The depth of the strip changes to $(-y)$

$$\Rightarrow F = \int_{-3}^0 w(-y)L(y) dy = \int_{-3}^0 62.4 \cdot (-y) \cdot 2(y + 3) dy = 124.8 \int_{-3}^0 (-y^2 - 3y) dy = 124.8 \left[-\frac{y^3}{3} - \frac{3}{2}y^2 \right]_{-3}^0$$

$$= (-124.8) \left(\frac{27}{3} - \frac{27}{2} \right) = \frac{(-124.8)(27)(2-3)}{6} = 561.6 \text{ lb}$$

5. Using the coordinate system of Exercise 4, we find the equation for the line of the plate's right-hand edge to be $y = 2x - 4 \Rightarrow x = \frac{y+4}{2}$ and $L(y) = 2x = y + 4$. The depth of the strip is $(1 - y)$.

(a) $F = \int_{-4}^0 w(1 - y)L(y) dy = \int_{-4}^0 62.4 \cdot (1 - y)(y + 4) dy = 62.4 \int_{-4}^0 (4 - 3y - y^2) dy = 62.4 \left[4y - \frac{3y^2}{2} - \frac{y^3}{3} \right]_{-4}^0$

$$= (-62.4) \left[(-4)(4) - \frac{(3)(16)}{2} + \frac{64}{3} \right] = (-62.4) \left(-16 - 24 + \frac{64}{3} \right) = \frac{(-62.4)(-120+64)}{3} = 1164.8 \text{ lb}$$

(b) $F = (-64.0) \left[(-4)(4) - \frac{(3)(16)}{2} + \frac{64}{3} \right] = \frac{(-64.0)(-120+64)}{3} \approx 1194.7 \text{ lb}$

6. Using the coordinate system given, we find an equation for the line of the plate's right-hand edge to be $y = -2x + 4$

$$\Rightarrow x = \frac{4-y}{2} \text{ and } L(y) = 2x = 4 - y. \text{ The depth of the strip is } (1 - y) \Rightarrow F = \int_0^1 w(1 - y)(4 - y) dy$$

$$= 62.4 \int_0^1 (y^2 - 5y + 4) dy = 62.4 \left[\frac{y^3}{3} - \frac{5y^2}{2} + 4y \right]_0^1$$

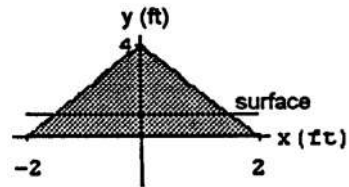
$$= (62.4) \left(\frac{1}{3} - \frac{5}{2} + 4 \right) = (62.4) \left(\frac{2-15+24}{6} \right) = \frac{(62.4)(11)}{6} = 114.4 \text{ lb}$$

7. Using the coordinate system given in the accompanying figure, we see that the total width is $L(y) = 63$ and the depth of the strip is $(33.5 - y) \Rightarrow F = \int_0^{33} w(33.5 - y)L(y) dy$

$$= \int_0^{33} \frac{64}{12^3} \cdot (33.5 - y) \cdot 63 dy = \left(\frac{64}{12^3} \right) (63) \int_0^{33} (33.5 - y) dy$$

$$= \left(\frac{64}{12^3} \right) (63) \left[33.5y - \frac{y^2}{2} \right]_0^{33} = \left(\frac{64 \cdot 63}{12^3} \right) \left[(33.5)(33) - \frac{33^2}{2} \right]$$

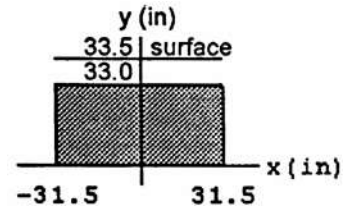
$$= \frac{(64)(63)(33)(67-33)}{(2)(12^3)} = 1309 \text{ lb}$$

8. (a) Use the coordinate system given in the accompanying figure. The depth of the strip is $(\frac{11}{6} - y)$ ft

$$\Rightarrow F = \int_0^{11/6} w \left(\frac{11}{6} - y \right) (\text{width}) dy$$

$$= (62.4)(\text{width}) \int_0^{11/6} \left(\frac{11}{6} - y \right) dy$$

$$= (62.4)(\text{width}) \left[\frac{11}{6}y - \frac{y^2}{2} \right]_0^{11/6}$$

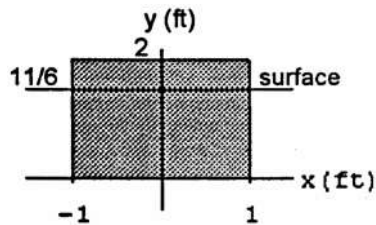
$$= (62.4)(\text{width}) \left[\left(\frac{11}{6} \right)^2 \cdot \frac{1}{2} \right] \Rightarrow F_{\text{end}} = (62.4)(2) \left(\frac{121}{36} \right) \left(\frac{1}{2} \right) \approx 209.73 \text{ lb and } F_{\text{side}} = (62.4)(4) \left(\frac{121}{36} \right) \left(\frac{1}{2} \right) \approx 419.47 \text{ lb}$$

(b) Use the coordinate system given in the accompanying figure. Find Y from the condition that the entire volume of the water is conserved (no spilling): $\frac{11}{6} \cdot 2 \cdot 4 = 2 \cdot 2 \cdot Y$

$$\Rightarrow Y = \frac{11}{3} \text{ ft. The depth of a typical strip is } \left(\frac{11}{3} - y \right) \text{ ft and the total width is } L(y) = 2 \text{ ft. Thus,}$$

$$F = \int_0^{11/3} w \left(\frac{11}{3} - y \right) L(y) dy$$

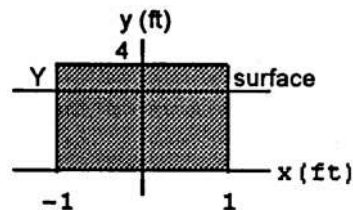
$$= \int_0^{11/3} (62.4) \left(\frac{11}{3} - y \right) \cdot 2 dy = (62.4)(2) \left[\frac{11}{3}y - \frac{y^2}{2} \right]_0^{11/3} = (62.4)(2) \left[\left(\frac{11}{2} \right) \left(\frac{11}{3} \right)^2 \right] = \frac{(62.4)(121)}{9} \approx 838.93 \text{ lb} \Rightarrow \text{the fluid force doubles.}$$

9. Using the coordinate system given in the accompanying figure, we see that the right-hand edge is $x = \sqrt{1 - y^2}$ so the total width is $L(y) = 2x = 2\sqrt{1 - y^2}$ and the depth of the strip is $(-y)$. The force exerted by the water is therefore $F = \int_{-1}^0 w \cdot (-y) \cdot 2\sqrt{1 - y^2} dy$

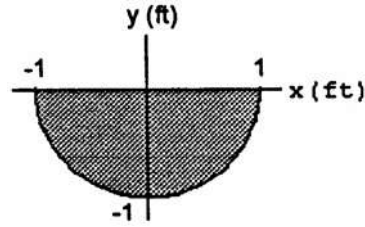

$$= 62.4 \int_{-1}^0 \sqrt{1 - y^2} d(1 - y^2) = 62.4 \left[\frac{2}{3} (1 - y^2)^{3/2} \right]_{-1}^0 = (62.4) \left(\frac{2}{3} \right) (1 - 0) = 416 \text{ lb}$$

10. Using the same coordinate system as in Exercise 15, the right-hand edge is $x = \sqrt{3^2 - y^2}$ and the total width is $L(y) = 2x = 2\sqrt{9 - y^2}$. The depth of the strip is $(-y)$. The force exerted by the milk is therefore $F = \int_{-3}^0 w \cdot (-y) \cdot 2\sqrt{9 - y^2} dy = 64.5 \int_{-3}^0 \sqrt{9 - y^2} d(9 - y^2) = 64.5 \left[\frac{2}{3} (9 - y^2)^{3/2} \right]_{-3}^0 = (64.5) \left(\frac{2}{3} \right) (27 - 0) = (64.5)(18) = 1161 \text{ lb}$

11. The coordinate system is given in the text. The right-hand edge is $x = \sqrt{y}$ and the total width is $L(y) = 2x = 2\sqrt{y}$.
- (a) The depth of the strip is $(2 - y)$ so the force exerted by the liquid on the gate is $F = \int_0^1 w(2 - y)L(y) dy = \int_0^1 50(2 - y) \cdot 2\sqrt{y} dy = 100 \int_0^1 (2 - y)\sqrt{y} dy = 100 \int_0^1 (2y^{1/2} - y^{3/2}) dy = 100 \left[\frac{4}{3} y^{3/2} - \frac{2}{5} y^{5/2} \right]_0^1 = 100 \left(\frac{4}{3} - \frac{2}{5} \right) = \left(\frac{100}{15} \right) (20 - 6) = 93.33 \text{ lb}$
- (b) We need to solve $160 = \int_0^1 w(H - y) \cdot 2\sqrt{y} dy$ for h . $160 = 100 \left(\frac{2H}{3} - \frac{2}{5} \right) \Rightarrow H = 3 \text{ ft}$.

12. Use the coordinate system given in the accompanying figure. The total width is $L(y) = 1$.
- (a) The depth of the strip is $(3 - 1) - y = (2 - y)$ ft. The force exerted by the fluid in the window is $F = \int_0^1 w(2 - y)L(y) dy = 62.4 \int_0^1 (2 - y) \cdot 1 dy = (62.4) \left[2y - \frac{y^2}{2} \right]_0^1 = (62.4) \left(2 - \frac{1}{2} \right) = \frac{(62.4)(3)}{2} = 93.6 \text{ lb}$
- (b) Suppose that H is the maximum height to which the tank can be filled without exceeding its design limitation. This means that the depth of a typical strip is $(H - 1) - y$ and the force is

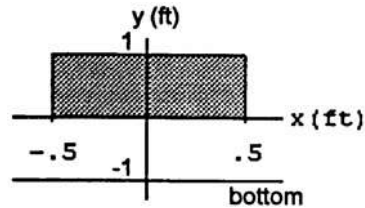

$$F = \int_0^1 w[(H - 1) - y]L(y) dy = F_{\max}, \text{ where}$$

$$F_{\max} = 312 \text{ lb. Thus, } F_{\max} = w \int_0^1 [(H - 1) - y] \cdot 1 dy = (62.4) \left[(H - 1)y - \frac{y^2}{2} \right]_0^1 = (62.4) \left(H - \frac{3}{2} \right) = \left(\frac{62.4}{2} \right) (2H - 3) = -93.6 + 62.4H. \text{ Then } F_{\max} = -93.6 + 62.4H \Rightarrow 312 = -93.6 + 62.4H \Rightarrow H = \frac{405.6}{62.4} = 6.5 \text{ ft}$$

13. Suppose that h is the maximum height. Using the coordinate system given in the text, we find an equation for the line of the end plate's right-hand edge is $y = \frac{5}{2}x \Rightarrow x = \frac{2}{5}y$. The total width is $L(y) = 2x = \frac{4}{5}y$ and the depth of the typical horizontal strip at level y is $(h - y)$. Then the force is $F = \int_0^h w(h - y)L(y) dy = F_{\max}$, where $F_{\max} = 6667 \text{ lb}$. Hence, $F_{\max} = w \int_0^h (h - y) \cdot \frac{4}{5}y dy = (62.4) \left(\frac{4}{5} \right) \int_0^h (hy - y^2) dy = (62.4) \left(\frac{4}{5} \right) \left[\frac{hy^2}{2} - \frac{y^3}{3} \right]_0^h = (62.4) \left(\frac{4}{5} \right) \left(\frac{h^3}{2} - \frac{h^3}{3} \right) = (62.4) \left(\frac{4}{5} \right) \left(\frac{1}{6} \right) h^3 = (10.4) \left(\frac{4}{5} \right) h^3 \Rightarrow h = \sqrt[3]{\left(\frac{5}{4} \right) \left(\frac{F_{\max}}{10.4} \right)} = \sqrt[3]{\left(\frac{5}{4} \right) \left(\frac{6667}{10.4} \right)} \approx 9.288 \text{ ft}$. The volume of water which the tank can hold is $V = \frac{1}{2}(\text{Base})(\text{Height}) \cdot 30$, where $\text{Height} = h$ and $\frac{1}{2}(\text{Base}) = \frac{2}{5}h \Rightarrow V = \left(\frac{2}{5}h^2 \right) (30) = 12h^2 \approx 12(9.288)^2 \approx 1035 \text{ ft}^3$.

14. (a) After 9 hours of filling there are $V = 1000 \cdot 9 = 9000$ cubic feet of water in the pool. The level of the water is $h = \frac{V}{\text{Area}}$, where $\text{Area} = 50 \cdot 30 = 1500 \Rightarrow h = \frac{9000}{1500} = 6$ ft. The depth of the typical horizontal strip at level y is then $(6 - y)$ for the coordinate system given in the text. An equation for the drain plate's right-hand edge is $y = x \Rightarrow$ total width is $L(y) = 2x = 2y$. Thus the force against the drain plate is

$$F = \int_0^1 w(6 - y)L(y) dy = 62.4 \int_0^1 (6 - y) \cdot 2y dy = (62.4)(2) \int_0^1 (6y - y^2) dy = (62.4)(2) \left[\frac{6y^2}{2} - \frac{y^3}{3} \right]_0^1 \\ = (124.8) \left(3 - \frac{1}{3} \right) = (124.8) \left(\frac{8}{3} \right) = 332.8 \text{ lb}$$

- (b) Suppose that h is the maximum height. Then, the depth of a typical strip is $(h - y)$ and the force

$$F = \int_0^1 w(h - y)L(y) dy = F_{\max}, \text{ where } F_{\max} = 520 \text{ lb. Hence, } F_{\max} = (62.4) \int_0^1 (h - y) \cdot 2y dy \\ = 124.8 \int_0^1 (hy - y^2) dy = (124.8) \left[\frac{hy^2}{2} - \frac{y^3}{3} \right]_0^1 = (124.8) \left(\frac{h}{2} - \frac{1}{3} \right) = (20.8)(3h - 2) \Rightarrow \frac{520}{20.8} = 3h - 2 \\ \Rightarrow h = \frac{27}{3} = 9 \text{ ft}$$

15. The pressure at level y is $p(y) = w \cdot y \Rightarrow$ the average pressure is $\bar{p} = \frac{1}{b} \int_0^b p(y) dy = \frac{1}{b} \int_0^b w \cdot y dy = \frac{1}{b} w \left[\frac{y^2}{2} \right]_0^b \\ = \left(\frac{w}{b} \right) \left(\frac{b^2}{2} \right) = \frac{wb}{2}$. This is the pressure at level $\frac{b}{2}$, which is the pressure at the middle of the plate.

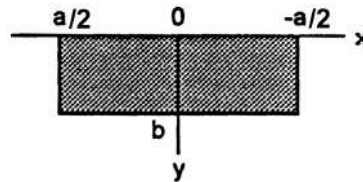

16. The force exerted by the fluid is $F = \int_0^b w(\text{depth})(\text{length}) dy = \int_0^b w \cdot y \cdot a dy = (w \cdot a) \int_0^b y dy = (w \cdot a) \left[\frac{y^2}{2} \right]_0^b \\ = w \left(\frac{ab^2}{2} \right) = \left(\frac{wb}{2} \right) (ab) = \bar{p} \cdot \text{Area}$, where \bar{p} is the average value of the pressure (see Exercise 21).

17. When the water reaches the top of the tank the force on the movable side is $\int_{-2}^0 (62.4) (2\sqrt{4 - y^2}) (-y) dy \\ = (62.4) \int_{-2}^0 (4 - y^2)^{1/2} (-2y) dy = (62.4) \left[\frac{2}{3} (4 - y^2)^{3/2} \right]_{-2}^0 = (62.4) \left(\frac{2}{3} \right) (4^{3/2}) = 332.8 \text{ ft} \cdot \text{lb}$. The force compressing the spring is $F = 100x$, so when the tank is full we have $332.8 = 100x \Rightarrow x \approx 3.33$ ft. Therefore the movable end does not reach the required 5 ft to allow drainage \Rightarrow the tank will overflow.

18. (a) Using the given coordinate system we see that the total width is $L(y) = 3$ and the depth of the strip is $(3 - y)$.

$$\text{Thus, } F = \int_0^3 w(3 - y)L(y) dy = \int_0^3 (62.4)(3 - y) \cdot 3 dy \\ = (62.4)(3) \int_0^3 (3 - y) dy = (62.4)(3) \left[3y - \frac{y^2}{2} \right]_0^3 \\ = (62.4)(3) \left(9 - \frac{9}{2} \right) = (62.4)(3) \left(\frac{9}{2} \right) = 842.4 \text{ lb}$$

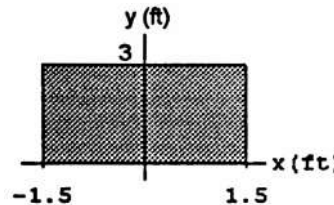

- (b) Find a new water level Y such that $F_Y = (0.75)(842.4 \text{ lb}) = 631.8 \text{ lb}$. The new depth of the strip is $(Y - y)$ and Y is the new upper limit of integration. Thus, $F_Y = \int_0^Y w(Y - y)L(y) dy$

$$= 62.4 \int_0^Y (Y - y) \cdot 3 dy = (62.4)(3) \int_0^Y (Y - y) dy = (62.4)(3) \left[Yy - \frac{y^2}{2} \right]_0^Y = (62.4)(3) \left(Y^2 - \frac{Y^2}{2} \right) \\ = (62.4)(3) \left(\frac{Y^2}{2} \right)$$
. Therefore, $Y = \sqrt{\frac{2F_Y}{(62.4)(3)}} = \sqrt{\frac{1263.6}{187.2}} = \sqrt{6.75} \approx 2.598$ ft. So, $\Delta Y = 3 - Y \approx 3 - 2.598 \approx 0.402$ ft ≈ 4.8 in

19. Use a coordinate system with $y = 0$ at the bottom of the carton and with $L(y) = 3.75$ and the depth of a typical strip being $(7.75 - y)$. Then $F = \int_0^{7.75} w(7.75 - y)L(y) dy = \left(\frac{64.5}{12^3} \right) (3.75) \int_0^{7.75} (7.75 - y) dy = \left(\frac{64.5}{12^3} \right) (3.75) \left[7.75y - \frac{y^2}{2} \right]_0^{7.75} \\ = \left(\frac{64.5}{12^3} \right) (3.75) \frac{(7.75)^2}{2} \approx 4.2 \text{ lb}$

20. The force against the base is $F_{\text{base}} = pA = whA = w \cdot h \cdot (\text{length})(\text{width}) = \left(\frac{57}{12^3}\right) (10)(5.75)(3.5) \approx 6.64$ lb.
 To find the fluid force against each side, use a coordinate system with $y = 0$ at the bottom of the can, so that the depth of a typical strip is $(10 - y)$: $F = \int_0^{10} w(10 - y) \left(\frac{\text{width of}}{\text{the side}}\right) dy = \left(\frac{57}{12^3}\right) \left(\frac{\text{width of}}{\text{the side}}\right) \left[10y - \frac{y^2}{2}\right]_0^{10}$
 $= \left(\frac{57}{12^3}\right) \left(\frac{\text{width of}}{\text{the side}}\right) \left(\frac{100}{2}\right) \Rightarrow F_{\text{end}} = \left(\frac{57}{12^3}\right) (50)(3.5) \approx 5.773$ lb and $F_{\text{side}} = \left(\frac{57}{12^3}\right) (50)(5.75) \approx 9.484$ lb
21. (a) An equation of the right-hand edge is $y = \frac{3}{2}x \Rightarrow x = \frac{2}{3}y$ and $L(y) = 2x = \frac{4y}{3}$. The depth of the strip is $(3 - y) \Rightarrow F = \int_0^3 w(3 - y)L(y) dy = \int_0^3 (62.4)(3 - y) \left(\frac{4}{3}y\right) dy = (62.4) \cdot \left(\frac{4}{3}\right) \int_0^3 (3y - y^2) dy$
 $= (62.4) \left(\frac{4}{3}\right) \left[\frac{3}{2}y^2 - \frac{y^3}{3}\right]_0^3 = (62.4) \left(\frac{4}{3}\right) \left[\frac{27}{2} - \frac{27}{3}\right] = (62.4) \left(\frac{4}{3}\right) \left(\frac{27}{6}\right) = 374.4$ lb
- (b) We want to find a new water level Y such that $F_Y = \frac{1}{2}(374.4) = 187.2$ lb. The new depth of the strip is $(Y - y)$, and Y is the new upper limit of integration. Thus, $F_Y = \int_0^Y w(Y - y)L(y) dy$
 $= 62.4 \int_0^Y (Y - y) \left(\frac{4}{3}y\right) dy = (62.4) \left(\frac{4}{3}\right) \int_0^Y (Yy - y^2) dy = (62.4) \left(\frac{4}{3}\right) \left[Y \cdot \frac{y^2}{2} - \frac{y^3}{3}\right]_0^Y = (62.4) \left(\frac{4}{3}\right) \left(\frac{Y^3}{2} - \frac{Y^3}{3}\right)$
 $= (62.4) \left(\frac{2}{9}\right) Y^3$. Therefore $Y^3 = \frac{9F_Y}{2(62.4)} = \frac{(9)(187.2)}{124.8} \Rightarrow Y = \sqrt[3]{\frac{(9)(187.2)}{124.8}} = \sqrt[3]{13.5} \approx 2.3811$ ft. So,
 $\Delta Y = 3 - Y \approx 3 - 2.3811 \approx 0.6189$ ft ≈ 7.5 in. to the nearest half inch.
- (c) No, it does not matter how long the trough is. The fluid pressure and the resulting force depend only on depth of the water.
22. The area of a strip of the face of height Δy and parallel to the base is $100\left(\frac{26}{24}\right) \cdot \Delta y$, where the factor of $\frac{26}{24}$ accounts for the inclination of the face of the dam. With the origin at the bottom of the dam, the force on the face is then:
 $F = \int_0^{24} w(24 - y)(100)\left(\frac{26}{24}\right) dy = 6760 \left[24y - \frac{y^2}{2}\right]_0^{24} = 6760 \left(24^2 - \frac{24^2}{2}\right) = 1,946,880$ lb.

CHAPTER 6 PRACTICE EXERCISES

1. $A(x) = \frac{\pi}{4} (\text{diameter})^2 = \frac{\pi}{4} (\sqrt{x} - x^2)^2$
 $= \frac{\pi}{4} (x - 2\sqrt{x} \cdot x^2 + x^4)$; $a = 0, b = 1$
 $\Rightarrow V = \int_a^b A(x) dx = \frac{\pi}{4} \int_0^1 (x - 2x^{5/2} + x^4) dx$
 $= \frac{\pi}{4} \left[\frac{x^2}{2} - \frac{4}{7}x^{7/2} + \frac{x^5}{5}\right]_0^1 = \frac{\pi}{4} \left(\frac{1}{2} - \frac{4}{7} + \frac{1}{5}\right)$
 $= \frac{\pi}{4 \cdot 70} (35 - 40 + 14) = \frac{9\pi}{280}$
2. $A(x) = \frac{1}{2} (\text{side})^2 \left(\sin \frac{\pi}{3}\right) = \frac{\sqrt{3}}{4} (2\sqrt{x} - x)^2$
 $= \frac{\sqrt{3}}{4} (4x - 4x\sqrt{x} + x^2)$; $a = 0, b = 4$
 $\Rightarrow V = \int_a^b A(x) dx = \frac{\sqrt{3}}{4} \int_0^4 (4x - 4x^{3/2} + x^2) dx$
 $= \frac{\sqrt{3}}{4} \left[2x^2 - \frac{8}{5}x^{5/2} + \frac{x^3}{3}\right]_0^4 = \frac{\sqrt{3}}{4} \left(32 - \frac{8 \cdot 32}{5} + \frac{64}{3}\right)$
 $= \frac{32\sqrt{3}}{4} \left(1 - \frac{8}{5} + \frac{2}{3}\right) = \frac{8\sqrt{3}}{15} (15 - 24 + 10) = \frac{8\sqrt{3}}{15}$

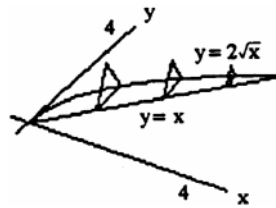
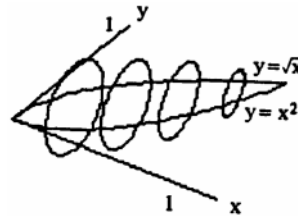

$$\begin{aligned}
 3. \quad A(x) &= \frac{\pi}{4} (\text{diameter})^2 = \frac{\pi}{4} (2 \sin x - 2 \cos x)^2 \\
 &= \frac{\pi}{4} \cdot 4 (\sin^2 x - 2 \sin x \cos x + \cos^2 x) \\
 &= \pi(1 - \sin 2x); \quad a = \frac{\pi}{4}, \quad b = \frac{5\pi}{4} \\
 \Rightarrow V &= \int_a^b A(x) \, dx = \pi \int_{\pi/4}^{5\pi/4} (1 - \sin 2x) \, dx \\
 &= \pi \left[x + \frac{\cos 2x}{2} \right]_{\pi/4}^{5\pi/4} \\
 &= \pi \left[\left(\frac{5\pi}{4} + \frac{\cos \frac{5\pi}{2}}{2} \right) - \left(\frac{\pi}{4} - \frac{\cos \frac{\pi}{2}}{2} \right) \right] = \pi^2
 \end{aligned}$$

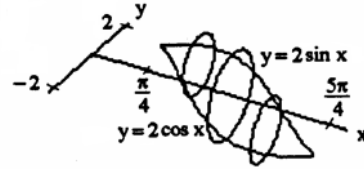

$$\begin{aligned}
 4. \quad A(x) &= (\text{edge})^2 = \left((\sqrt{6} - \sqrt{x})^2 - 0 \right)^2 = (\sqrt{6} - \sqrt{x})^4 = 36 - 24\sqrt{6}\sqrt{x} + 36x - 4\sqrt{6}x^{3/2} + x^2; \\
 a = 0, \quad b = 6 \Rightarrow V &= \int_a^b A(x) \, dx = \int_0^6 (36 - 24\sqrt{6}\sqrt{x} + 36x - 4\sqrt{6}x^{3/2} + x^2) \, dx \\
 &= \left[36x - 24\sqrt{6} \cdot \frac{2}{3} x^{3/2} + 18x^2 - 4\sqrt{6} \cdot \frac{2}{5} x^{5/2} + \frac{x^3}{3} \right]_0^6 = 216 - 16 \cdot \sqrt{6} \sqrt{6} \cdot 6 + 18 \cdot 6^2 - \frac{8}{5} \sqrt{6} \sqrt{6} \cdot 6^2 + \frac{6^3}{3} \\
 &= 216 - 576 + 648 - \frac{1728}{5} + 72 = 360 - \frac{1728}{5} = \frac{1800 - 1728}{5} = \frac{72}{5}
 \end{aligned}$$

$$\begin{aligned}
 5. \quad A(x) &= \frac{\pi}{4} (\text{diameter})^2 = \frac{\pi}{4} \left(2\sqrt{x} - \frac{x^2}{4} \right)^2 = \frac{\pi}{4} \left(4x - x^{5/2} + \frac{x^4}{16} \right); \quad a = 0, \quad b = 4 \Rightarrow V = \int_a^b A(x) \, dx \\
 &= \frac{\pi}{4} \int_0^4 \left(4x - x^{5/2} + \frac{x^4}{16} \right) \, dx = \frac{\pi}{4} \left[2x^2 - \frac{2}{7} x^{7/2} + \frac{x^5}{5 \cdot 16} \right]_0^4 = \frac{\pi}{4} \left(32 - 32 \cdot \frac{8}{7} + \frac{2}{5} \cdot 32 \right) \\
 &= \frac{32\pi}{4} \left(1 - \frac{8}{7} + \frac{2}{5} \right) = \frac{8\pi}{35} (35 - 40 + 14) = \frac{72\pi}{35}
 \end{aligned}$$

$$\begin{aligned}
 6. \quad A(x) &= \frac{1}{2} (\text{edge})^2 \sin \left(\frac{\pi}{3} \right) = \frac{\sqrt{3}}{4} [2\sqrt{x} - (-2\sqrt{x})]^2 \\
 &= \frac{\sqrt{3}}{4} (4\sqrt{x})^2 = 4\sqrt{3}x; \quad a = 0, \quad b = 1 \\
 \Rightarrow V &= \int_a^b A(x) \, dx = \int_0^1 4\sqrt{3}x \, dx = \left[2\sqrt{3}x^2 \right]_0^1 \\
 &= 2\sqrt{3}
 \end{aligned}$$

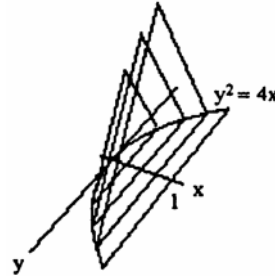

7. (a) *disk method:*

$$\begin{aligned}
 V &= \int_a^b \pi R^2(x) \, dx = \int_{-1}^1 \pi (3x^4)^2 \, dx = \pi \int_{-1}^1 9x^8 \, dx \\
 &= \pi [x^9]_{-1}^1 = 2\pi
 \end{aligned}$$

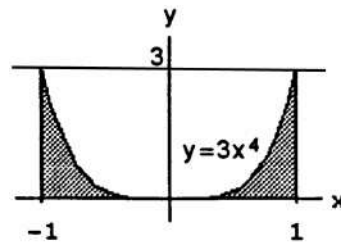

(b) *shell method:*

$$V = \int_a^b 2\pi \left(\begin{smallmatrix} \text{shell} \\ \text{radius} \end{smallmatrix} \right) \left(\begin{smallmatrix} \text{shell} \\ \text{height} \end{smallmatrix} \right) \, dx = \int_0^1 2\pi x (3x^4) \, dx = 2\pi \cdot 3 \int_0^1 x^5 \, dx = 2\pi \cdot 3 \left[\frac{x^6}{6} \right]_0^1 = \pi$$

Note: The lower limit of integration is 0 rather than -1.

(c) *shell method:*

$$V = \int_a^b 2\pi \left(\begin{smallmatrix} \text{shell} \\ \text{radius} \end{smallmatrix} \right) \left(\begin{smallmatrix} \text{shell} \\ \text{height} \end{smallmatrix} \right) \, dx = 2\pi \int_{-1}^1 (1-x)(3x^4) \, dx = 2\pi \left[\frac{3x^5}{5} - \frac{x^6}{2} \right]_{-1}^1 = 2\pi \left[\left(\frac{3}{5} - \frac{1}{2} \right) - \left(-\frac{3}{5} - \frac{1}{2} \right) \right] = \frac{12\pi}{5}$$

(d) *washer method:*

$$\begin{aligned}
 R(x) &= 3, \quad r(x) = 3 - 3x^4 = 3(1 - x^4) \Rightarrow V = \int_a^b \pi [R^2(x) - r^2(x)] \, dx = \int_{-1}^1 \pi [9 - 9(1 - x^4)^2] \, dx \\
 &= 9\pi \int_{-1}^1 [1 - (1 - 2x^4 + x^8)] \, dx = 9\pi \int_{-1}^1 (2x^4 - x^8) \, dx = 9\pi \left[\frac{2x^5}{5} - \frac{x^9}{9} \right]_{-1}^1 = 18\pi \left[\frac{2}{5} - \frac{1}{9} \right] = \frac{2\pi \cdot 13}{5} = \frac{26\pi}{5}
 \end{aligned}$$

8. (a) *washer method:*

$$R(x) = \frac{4}{x^3}, r(x) = \frac{1}{2} \Rightarrow V = \int_a^b \pi [R^2(x) - r^2(x)] dx = \int_1^2 \pi \left[\left(\frac{4}{x^3}\right)^2 - \left(\frac{1}{2}\right)^2 \right] dx = \pi \left[-\frac{16}{5} x^{-5} - \frac{x}{4} \right]_1^2$$

$$= \pi \left[\left(-\frac{16}{5 \cdot 32} - \frac{1}{2}\right) - \left(-\frac{16}{5} - \frac{1}{4}\right) \right] = \pi \left(-\frac{1}{10} - \frac{1}{2} + \frac{16}{5} + \frac{1}{4}\right) = \frac{\pi}{20} (-2 - 10 + 64 + 5) = \frac{57\pi}{20}$$

(b) *shell method:*

$$V = 2\pi \int_1^2 x \left(\frac{4}{x^3} - \frac{1}{2}\right) dx = 2\pi \left[-4x^{-1} - \frac{x^2}{4}\right]_1^2 = 2\pi \left[(-\frac{4}{2} - 1) - (-4 - \frac{1}{4})\right] = 2\pi \left(\frac{5}{4}\right) = \frac{5\pi}{2}$$

(c) *shell method:*

$$V = 2\pi \int_a^b \left(\frac{\text{shell}}{\text{radius}}\right) \left(\frac{\text{shell}}{\text{height}}\right) dx = 2\pi \int_1^2 (2-x) \left(\frac{4}{x^3} - \frac{1}{2}\right) dx = 2\pi \int_1^2 \left(\frac{8}{x^3} - \frac{4}{x^2} - 1 + \frac{x}{2}\right) dx$$

$$= 2\pi \left[-\frac{4}{x^2} + \frac{4}{x} - x + \frac{x^2}{4}\right]_1^2 = 2\pi \left[(-1 + 2 - 2 + 1) - (-4 + 4 - 1 + \frac{1}{4})\right] = \frac{3\pi}{2}$$

(d) *washer method:*

$$V = \int_a^b \pi [R^2(x) - r^2(x)] dx$$

$$= \pi \int_1^2 \left[\left(\frac{7}{2}\right)^2 - \left(4 - \frac{4}{x^3}\right)^2\right] dx$$

$$= \frac{49\pi}{4} - 16\pi \int_1^2 (1 - 2x^{-3} + x^{-6}) dx$$

$$= \frac{49\pi}{4} - 16\pi \left[x + x^{-2} - \frac{x^{-5}}{5}\right]_1^2$$

$$= \frac{49\pi}{4} - 16\pi \left[\left(2 + \frac{1}{4} - \frac{1}{5 \cdot 32}\right) - \left(1 + 1 - \frac{1}{5}\right)\right]$$

$$= \frac{49\pi}{4} - 16\pi \left(\frac{1}{4} - \frac{1}{160} + \frac{1}{5}\right)$$

$$= \frac{49\pi}{4} - \frac{16\pi}{160} (40 - 1 + 32) = \frac{49\pi}{4} - \frac{71\pi}{10} = \frac{103\pi}{20}$$

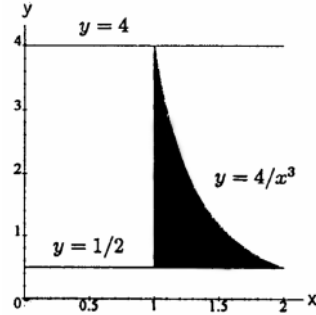

9. (a) *disk method:*

$$V = \pi \int_1^5 (\sqrt{x-1})^2 dx = \pi \int_1^5 (x-1) dx = \pi \left[\frac{x^2}{2} - x\right]_1^5$$

$$= \pi \left[\left(\frac{25}{2} - 5\right) - \left(\frac{1}{2} - 1\right)\right] = \pi \left(\frac{24}{2} - 4\right) = 8\pi$$

(b) *washer method:*

$$R(y) = 5, r(y) = y^2 + 1 \Rightarrow V = \int_c^d \pi [R^2(y) - r^2(y)] dy = \pi \int_{-2}^2 [25 - (y^2 + 1)^2] dy$$

$$= \pi \int_{-2}^2 (25 - y^4 - 2y^2 - 1) dy = \pi \int_{-2}^2 (24 - y^4 - 2y^2) dy = \pi \left[24y - \frac{y^5}{5} - \frac{2}{3}y^3\right]_{-2}^2 = 2\pi \left(24 \cdot 2 - \frac{32}{5} - \frac{2}{3} \cdot 8\right)$$

$$= 32\pi \left(3 - \frac{2}{5} - \frac{1}{3}\right) = \frac{32\pi}{15} (45 - 6 - 5) = \frac{1088\pi}{15}$$

(c) *disk method:*

$$R(y) = 5 - (y^2 + 1) = 4 - y^2$$

$$\Rightarrow V = \int_c^d \pi R^2(y) dy = \int_{-2}^2 \pi (4 - y^2)^2 dy$$

$$= \pi \int_{-2}^2 (16 - 8y^2 + y^4) dy$$

$$= \pi \left[16y - \frac{8y^3}{3} + \frac{y^5}{5}\right]_{-2}^2 = 2\pi \left(32 - \frac{64}{3} + \frac{32}{5}\right)$$

$$= 64\pi \left(1 - \frac{2}{3} + \frac{1}{5}\right) = \frac{64\pi}{15} (15 - 10 + 3) = \frac{512\pi}{15}$$

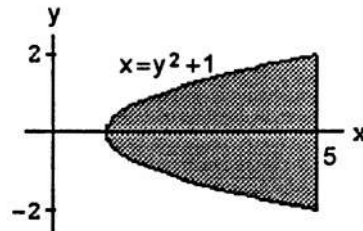

10. (a) *shell method:*

$$V = \int_c^d 2\pi \left(\frac{\text{shell}}{\text{radius}}\right) \left(\frac{\text{shell}}{\text{height}}\right) dy = \int_0^4 2\pi y \left(y - \frac{y^2}{4}\right) dy$$

$$= 2\pi \int_0^4 \left(y^2 - \frac{y^3}{4}\right) dy = 2\pi \left[\frac{y^3}{3} - \frac{y^4}{16}\right]_0^4 = 2\pi \left(\frac{64}{3} - \frac{64}{4}\right)$$

$$= \frac{2\pi}{12} \cdot 64 = \frac{32\pi}{3}$$

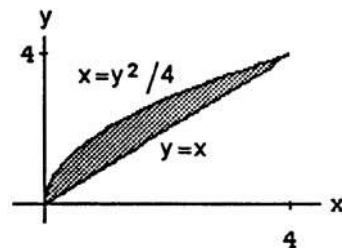

(b) *shell method*:

$$\begin{aligned} V &= \int_a^b 2\pi \left(\begin{array}{c} \text{shell} \\ \text{radius} \end{array} \right) \left(\begin{array}{c} \text{shell} \\ \text{height} \end{array} \right) dx = \int_0^4 2\pi x (2\sqrt{x} - x) dx = 2\pi \int_0^4 (2x^{3/2} - x^2) dx = 2\pi \left[\frac{4}{5} x^{5/2} - \frac{x^3}{3} \right]_0^4 \\ &= 2\pi \left(\frac{4}{5} \cdot 32 - \frac{64}{3} \right) = \frac{128\pi}{15} \end{aligned}$$

(c) *shell method*:

$$\begin{aligned} V &= \int_a^b 2\pi \left(\begin{array}{c} \text{shell} \\ \text{radius} \end{array} \right) \left(\begin{array}{c} \text{shell} \\ \text{height} \end{array} \right) dx = \int_0^4 2\pi(4-x)(2\sqrt{x}-x) dx = 2\pi \int_0^4 (8x^{1/2} - 4x - 2x^{3/2} + x^2) dx \\ &= 2\pi \left[\frac{16}{3} x^{3/2} - 2x^2 - \frac{4}{5} x^{5/2} + \frac{x^3}{3} \right]_0^4 = 2\pi \left(\frac{16}{3} \cdot 8 - 32 - \frac{4}{5} \cdot 32 + \frac{64}{3} \right) = 64\pi \left(\frac{4}{3} - 1 - \frac{4}{5} + \frac{2}{3} \right) \\ &= 64\pi \left(1 - \frac{4}{5} \right) = \frac{64\pi}{5} \end{aligned}$$

(d) *shell method*:

$$\begin{aligned} V &= \int_c^d 2\pi \left(\begin{array}{c} \text{shell} \\ \text{radius} \end{array} \right) \left(\begin{array}{c} \text{shell} \\ \text{height} \end{array} \right) dy = \int_0^4 2\pi(4-y) \left(y - \frac{y^2}{4} \right) dy = 2\pi \int_0^4 \left(4y - y^2 - y^2 + \frac{y^3}{4} \right) dy \\ &= 2\pi \int_0^4 \left(4y - 2y^2 + \frac{y^3}{4} \right) dy = 2\pi \left[2y^2 - \frac{2}{3} y^3 + \frac{y^4}{16} \right]_0^4 = 2\pi \left(32 - \frac{2}{3} \cdot 64 + 16 \right) = 32\pi \left(2 - \frac{8}{3} + 1 \right) = \frac{32\pi}{3} \end{aligned}$$

11. *disk method*:

$$R(x) = \tan x, a = 0, b = \frac{\pi}{3} \Rightarrow V = \pi \int_0^{\pi/3} \tan^2 x dx = \pi \int_0^{\pi/3} (\sec^2 x - 1) dx = \pi [\tan x - x]_0^{\pi/3} = \frac{\pi(3\sqrt{3}-\pi)}{3}$$

12. *disk method*:

$$\begin{aligned} V &= \pi \int_0^\pi (2 - \sin x)^2 dx = \pi \int_0^\pi (4 - 4 \sin x + \sin^2 x) dx = \pi \int_0^\pi \left(4 - 4 \sin x + \frac{1 - \cos 2x}{2} \right) dx \\ &= \pi \left[4x + 4 \cos x + \frac{x}{2} - \frac{\sin 2x}{4} \right]_0^\pi = \pi \left[\left(4\pi - 4 + \frac{\pi}{2} - 0 \right) - (0 + 4 + 0 - 0) \right] = \pi \left(\frac{9\pi}{2} - 8 \right) = \frac{\pi}{2} (9\pi - 16) \end{aligned}$$

13. (a) *disk method*:

$$\begin{aligned} V &= \pi \int_0^2 (x^2 - 2x)^2 dx = \pi \int_0^2 (x^4 - 4x^3 + 4x^2) dx = \pi \left[\frac{x^5}{5} - x^4 + \frac{4}{3} x^3 \right]_0^2 = \pi \left(\frac{32}{5} - 16 + \frac{32}{3} \right) \\ &= \frac{16\pi}{15} (6 - 15 + 10) = \frac{16\pi}{15} \end{aligned}$$

(b) *washer method*:

$$V = \int_0^2 \pi \left[1^2 - (x^2 - 2x + 1)^2 \right] dx = \int_0^2 \pi dx + \int_0^2 \pi (x-1)^4 dx = 2\pi - \left[\pi \frac{(x-1)^5}{5} \right]_0^2 = 2\pi - \pi \cdot \frac{2}{5} = \frac{8\pi}{5}$$

(c) *shell method*:

$$\begin{aligned} V &= \int_a^b 2\pi \left(\begin{array}{c} \text{shell} \\ \text{radius} \end{array} \right) \left(\begin{array}{c} \text{shell} \\ \text{height} \end{array} \right) dx = 2\pi \int_0^2 (2-x) [-(x^2-2x)] dx = 2\pi \int_0^2 (2-x)(2x-x^2) dx \\ &= 2\pi \int_0^2 (4x - 2x^2 - 2x^2 + x^3) dx = 2\pi \int_0^2 (x^3 - 4x^2 + 4x) dx = 2\pi \left[\frac{x^4}{4} - \frac{4}{3} x^3 + 2x^2 \right]_0^2 = 2\pi \left(4 - \frac{32}{3} + 8 \right) \\ &= \frac{2\pi}{3} (36 - 32) = \frac{8\pi}{3} \end{aligned}$$

(d) *washer method*:

$$\begin{aligned} V &= \pi \int_0^2 [2 - (x^2 - 2x)]^2 dx - \pi \int_0^2 2^2 dx = \pi \int_0^2 [4 - 4(x^2 - 2x) + (x^2 - 2x)^2] dx - 8\pi \\ &= \pi \int_0^2 (4 - 4x^2 + 8x + x^4 - 4x^3 + 4x^2) dx - 8\pi = \pi \int_0^2 (x^4 - 4x^3 + 8x + 4) dx - 8\pi \\ &= \pi \left[\frac{x^5}{5} - x^4 + 4x^2 + 4x \right]_0^2 - 8\pi = \pi \left(\frac{32}{5} - 16 + 16 + 8 \right) - 8\pi = \frac{\pi}{5} (32 + 40) - 8\pi = \frac{72\pi}{5} - \frac{40\pi}{5} = \frac{32\pi}{5} \end{aligned}$$

14. *disk method*:

$$V = 2\pi \int_0^{\pi/4} 4 \tan^2 x dx = 8\pi \int_0^{\pi/4} (\sec^2 x - 1) dx = 8\pi [\tan x - x]_0^{\pi/4} = 2\pi(4 - \pi)$$

15. The material removed from the sphere consists of a cylinder and two "caps." From the diagram, the height of the cylinder is $2h$, where $h^2 + (\sqrt{3})^2 = 2^2$, i.e. $h = 1$. Thus

$$V_{\text{cyl}} = (2h)\pi(\sqrt{3})^2 = 6\pi \text{ ft}^3. \text{ To get the volume of a cap,}$$

$$\text{use the disk method and } x^2 + y^2 = 2^2: V_{\text{cap}} = \int_1^2 \pi x^2 dy$$

$$= \int_1^2 \pi(4 - y^2) dy = \pi \left[4y - \frac{y^3}{3} \right]_1^2$$

$$= \pi \left[\left(8 - \frac{8}{3} \right) - \left(4 - \frac{1}{3} \right) \right] = \frac{5\pi}{3} \text{ ft}^3. \text{ Therefore,}$$

$$V_{\text{removed}} = V_{\text{cyl}} + 2V_{\text{cap}} = 6\pi + \frac{10\pi}{3} = \frac{28\pi}{3} \text{ ft}^3.$$

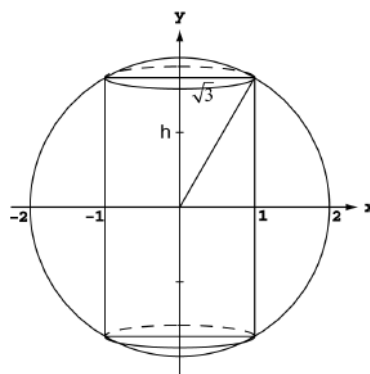

16. We rotate the region enclosed by the curve $y = \sqrt{12\left(1 - \frac{4x^2}{121}\right)}$ and the x -axis around the x -axis. To find the volume we use the *disk* method: $V = \int_a^b \pi R^2(x) dx = \int_{-11/2}^{11/2} \pi \left(\sqrt{12\left(1 - \frac{4x^2}{121}\right)} \right)^2 dx = \pi \int_{-11/2}^{11/2} 12\left(1 - \frac{4x^2}{121}\right) dx$
- $$= 12\pi \int_{-11/2}^{11/2} \left(1 - \frac{4x^2}{121}\right) dx = 12\pi \left[x - \frac{4x^3}{363} \right]_{-11/2}^{11/2} = 24\pi \left[\frac{11}{2} - \left(\frac{4}{363}\right) \left(\frac{11}{2}\right)^3 \right] = 132\pi \left[1 - \left(\frac{4}{363}\right) \left(\frac{11^2}{4}\right) \right]$$
- $$= 132\pi \left(1 - \frac{1}{3} \right) = \frac{264\pi}{3} = 88\pi \approx 276 \text{ in}^3$$

17. $y = x^{1/2} - \frac{x^{3/2}}{3} \Rightarrow \frac{dy}{dx} = \frac{1}{2}x^{-1/2} - \frac{1}{2}x^{1/2} \Rightarrow \left(\frac{dy}{dx}\right)^2 = \frac{1}{4}\left(\frac{1}{x} - 2 + x\right) \Rightarrow L = \int_1^4 \sqrt{1 + \frac{1}{4}\left(\frac{1}{x} - 2 + x\right)} dx$
- $$\Rightarrow L = \int_1^4 \sqrt{\frac{1}{4}\left(\frac{1}{x} + 2 + x\right)} dx = \int_1^4 \sqrt{\frac{1}{4}\left(x^{-1/2} + x^{1/2}\right)^2} dx = \int_1^4 \frac{1}{2}\left(x^{-1/2} + x^{1/2}\right) dx = \frac{1}{2} \left[2x^{1/2} + \frac{2}{3}x^{3/2} \right]_1^4$$
- $$= \frac{1}{2} \left[\left(4 + \frac{2}{3} \cdot 8 \right) - \left(2 + \frac{2}{3} \right) \right] = \frac{1}{2} \left(2 + \frac{14}{3} \right) = \frac{10}{3}$$

18. $x = y^{2/3} \Rightarrow \frac{dx}{dy} = \frac{2}{3}x^{-1/3} \Rightarrow \left(\frac{dx}{dy}\right)^2 = \frac{4x^{-2/3}}{9} \Rightarrow L = \int_1^8 \sqrt{1 + \left(\frac{dx}{dy}\right)^2} dy = \int_1^8 \sqrt{1 + \frac{4}{9x^{2/3}}} dy$
- $$= \int_1^8 \frac{\sqrt{9x^{2/3} + 4}}{3x^{1/3}} dx = \frac{1}{3} \int_1^8 \sqrt{9x^{2/3} + 4} (x^{-1/3}) dx; [u = 9x^{2/3} + 4 \Rightarrow du = 6y^{-1/3} dy; x = 1 \Rightarrow u = 13,$$
- $$x = 8 \Rightarrow u = 40] \rightarrow L = \frac{1}{18} \int_{13}^{40} u^{1/2} du = \frac{1}{18} \left[\frac{2}{3} u^{3/2} \right]_{13}^{40} = \frac{1}{27} [40^{3/2} - 13^{3/2}] \approx 7.634$$

19. $y = \frac{5}{12}x^{6/5} - \frac{5}{8}x^{4/5} \Rightarrow \frac{dy}{dx} = \frac{1}{2}x^{1/5} - \frac{1}{2}x^{-1/5} \Rightarrow \left(\frac{dy}{dx}\right)^2 = \frac{1}{4}(x^{2/5} - 2 + x^{-2/5})$
- $$\Rightarrow L = \int_1^{32} \sqrt{1 + \frac{1}{4}(x^{2/5} - 2 + x^{-2/5})} dx \Rightarrow L = \int_1^{32} \sqrt{\frac{1}{4}(x^{2/5} + 2 + x^{-2/5})} dx = \int_1^{32} \sqrt{\frac{1}{4}(x^{1/5} + x^{-1/5})^2} dx$$
- $$= \int_1^{32} \frac{1}{2}(x^{1/5} + x^{-1/5}) dx = \frac{1}{2} \left[\frac{5}{6}x^{6/5} + \frac{5}{4}x^{4/5} \right]_1^{32} = \frac{1}{2} \left[\left(\frac{5}{6} \cdot 2^6 + \frac{5}{4} \cdot 2^4 \right) - \left(\frac{5}{6} + \frac{5}{4} \right) \right] = \frac{1}{2} \left(\frac{315}{6} + \frac{75}{4} \right)$$
- $$= \frac{1}{48} (1260 + 450) = \frac{1710}{48} = \frac{285}{8}$$

20. $x = \frac{1}{12}y^3 + \frac{1}{y} \Rightarrow \frac{dx}{dy} = \frac{1}{4}y^2 - \frac{1}{y^2} \Rightarrow \left(\frac{dx}{dy}\right)^2 = \frac{1}{16}y^4 - \frac{1}{2} + \frac{1}{y^4} \Rightarrow L = \int_1^2 \sqrt{1 + \left(\frac{1}{16}y^4 - \frac{1}{2} + \frac{1}{y^4}\right)} dy$
- $$= \int_1^2 \sqrt{\frac{1}{16}y^4 + \frac{1}{2} + \frac{1}{y^4}} dy = \int_1^2 \sqrt{\left(\frac{1}{4}y^2 + \frac{1}{y^2}\right)^2} dy = \int_1^2 \left(\frac{1}{4}y^2 + \frac{1}{y^2}\right) dy = \left[\frac{1}{12}y^3 - \frac{1}{y} \right]_1^2$$
- $$= \left(\frac{8}{12} - \frac{1}{2} \right) - \left(\frac{1}{12} - 1 \right) = \frac{7}{12} + \frac{1}{2} = \frac{13}{12}$$

21. $\frac{dx}{dt} = -5 \sin t + 5 \sin 5t$ and $\frac{dy}{dt} = 5 \cos t - 5 \cos 5t \Rightarrow \sqrt{\left(\frac{dx}{dt}\right)^2 + \left(\frac{dy}{dt}\right)^2}$
- $$= \sqrt{(-5 \sin t + 5 \sin 5t)^2 + (5 \cos t - 5 \cos 5t)^2}$$
- $$= 5\sqrt{\sin^2 5t - 2 \sin t \sin 5t + \sin^2 t + \cos^2 t - 2 \cos t \cos 5t + \cos^2 5t} = 5\sqrt{2 - 2(\sin t \sin 5t + \cos t \cos 5t)}$$
- $$= 5\sqrt{2(1 - \cos 4t)} = 5\sqrt{4\left(\frac{1}{2}\right)(1 - \cos 4t)} = 10\sqrt{\sin^2 2t} = 10|\sin 2t| = 10\sin 2t \text{ (since } 0 \leq t \leq \frac{\pi}{2}\text{)}$$

$$\Rightarrow \text{Length} = \int_0^{\pi/2} 10 \sin 2t \, dt = [-5 \cos 2t]_0^{\pi/2} = (-5)(-1) - (-5)(1) = 10$$

$$\begin{aligned} 22. \frac{dx}{dt} &= 3t^2 - 12t \text{ and } \frac{dy}{dt} = 3t^2 + 12t \Rightarrow \sqrt{\left(\frac{dx}{dt}\right)^2 + \left(\frac{dy}{dt}\right)^2} = \sqrt{(3t^2 - 12t)^2 + (3t^2 + 12t)^2} = \sqrt{288t^2 + 18t^4} \\ &= 3\sqrt{2} |t| \sqrt{16 + t^2} \Rightarrow \text{Length} = \int_0^1 3\sqrt{2} |t| \sqrt{16 + t^2} \, dt = 3\sqrt{2} \int_0^1 t \sqrt{16 + t^2} \, dt; \left[u = 16 + t^2 \Rightarrow du = 2t \, dt \right. \\ &\Rightarrow \frac{1}{2} du = t \, dt; t = 0 \Rightarrow u = 16; t = 1 \Rightarrow u = 17 \left. \right]; \frac{3\sqrt{2}}{2} \int_{16}^{17} \sqrt{u} \, du = \frac{3\sqrt{2}}{2} \left[\frac{2}{3} u^{3/2} \right]_{16}^{17} = \frac{3\sqrt{2}}{2} \left(\frac{2}{3} (17)^{3/2} - \frac{2}{3} (16)^{3/2} \right) \\ &= \frac{3\sqrt{2}}{2} \cdot \frac{2}{3} \left((17)^{3/2} - 64 \right) = \sqrt{2} \left((17)^{3/2} - 64 \right) \approx 8.617. \end{aligned}$$

$$\begin{aligned} 23. \frac{dx}{d\theta} &= -3 \sin \theta \text{ and } \frac{dy}{d\theta} = 3 \cos \theta \Rightarrow \sqrt{\left(\frac{dx}{d\theta}\right)^2 + \left(\frac{dy}{d\theta}\right)^2} = \sqrt{(-3 \sin \theta)^2 + (3 \cos \theta)^2} = \sqrt{3(\sin^2 \theta + \cos^2 \theta)} = 3 \\ \Rightarrow \text{Length} &= \int_0^{3\pi/2} 3 \, d\theta = 3 \int_0^{3\pi/2} d\theta = 3 \left(\frac{3\pi}{2} - 0 \right) = \frac{9\pi}{2} \end{aligned}$$

$$\begin{aligned} 24. x &= t^2 \text{ and } y = \frac{t^3}{3} - t, -\sqrt{3} \leq t \leq \sqrt{3} \Rightarrow \frac{dx}{dt} = 2t \text{ and } \frac{dy}{dt} = t^2 - 1 \Rightarrow \text{Length} = \int_{-\sqrt{3}}^{\sqrt{3}} \sqrt{(2t)^2 + (t^2 - 1)^2} \, dt \\ &= \int_{-\sqrt{3}}^{\sqrt{3}} \sqrt{t^4 + 2t^2 + 1} \, dt = \int_{-\sqrt{3}}^{\sqrt{3}} \sqrt{t^4 + 2t^2 + 1} \, dt = \int_{-\sqrt{3}}^{\sqrt{3}} \sqrt{(t^2 + 1)^2} \, dt = \int_{-\sqrt{3}}^{\sqrt{3}} (t^2 + 1) \, dt = \left[\frac{t^3}{3} + t \right]_{-\sqrt{3}}^{\sqrt{3}} \\ &= 4\sqrt{3} \end{aligned}$$

25. Intersection points: $3 - x^2 = 2x^2 \Rightarrow 3x^2 - 3 = 0$
 $\Rightarrow 3(x - 1)(x + 1) = 0 \Rightarrow x = -1$ or $x = 1$. Symmetry suggests that $\bar{x} = 0$. The typical vertical strip has center of mass: $(\tilde{x}, \tilde{y}) = \left(x, \frac{2x^2 + (3 - x^2)}{2} \right) = \left(x, \frac{x^2 + 3}{2} \right)$, length: $(3 - x^2) - 2x^2 = 3(1 - x^2)$, width: dx , area: $dA = 3(1 - x^2) \, dx$, and mass: $dm = \delta \cdot dA = 3\delta(1 - x^2) \, dx \Rightarrow$ the moment about the x -axis is

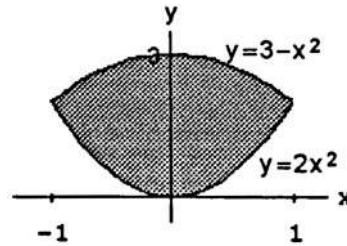

$$\begin{aligned} \tilde{y} \, dm &= \frac{3}{2} \delta (x^2 + 3)(1 - x^2) \, dx = \frac{3}{2} \delta (-x^4 - 2x^2 + 3) \, dx \Rightarrow M_x = \int \tilde{y} \, dm = \frac{3}{2} \delta \int_{-1}^1 (-x^4 - 2x^2 + 3) \, dx \\ &= \frac{3}{2} \delta \left[-\frac{x^5}{5} - \frac{2x^3}{3} + 3x \right]_{-1}^1 = 3\delta \left(-\frac{1}{5} - \frac{2}{3} + 3 \right) = \frac{3\delta}{15} (-3 - 10 + 45) = \frac{32\delta}{5}; M = \int dm = 3\delta \int_{-1}^1 (1 - x^2) \, dx \\ &= 3\delta \left[x - \frac{x^3}{3} \right]_{-1}^1 = 6\delta \left(1 - \frac{1}{3} \right) = 4\delta \Rightarrow \bar{y} = \frac{M_x}{M} = \frac{32\delta}{5 \cdot 4\delta} = \frac{8}{5}. \text{ Therefore, the centroid is } (\bar{x}, \bar{y}) = \left(0, \frac{8}{5} \right). \end{aligned}$$

26. Symmetry suggests that $\bar{x} = 0$. The typical vertical strip has center of mass: $(\tilde{x}, \tilde{y}) = \left(x, \frac{x^2}{2} \right)$, length: x^2 , width: dx , area: $dA = x^2 \, dx$, mass: $dm = \delta \cdot dA = \delta x^2 \, dx$
 \Rightarrow the moment about the x -axis is $\tilde{y} \, dm = \frac{\delta}{2} x^2 \cdot x^2 \, dx = \frac{\delta}{2} x^4 \, dx \Rightarrow M_x = \int \tilde{y} \, dm = \frac{\delta}{2} \int_{-2}^2 x^4 \, dx = \frac{\delta}{10} [x^5]_{-2}^2$
 $= \frac{2\delta}{10} (2^5) = \frac{32\delta}{5}; M = \int dm = \delta \int_{-2}^2 x^2 \, dx = \delta \left[\frac{x^3}{3} \right]_{-2}^2 = \frac{2\delta}{3} (2^3) = \frac{16\delta}{3} \Rightarrow \bar{y} = \frac{M_x}{M} = \frac{32 \cdot \delta \cdot 3}{5 \cdot 16 \cdot \delta} = \frac{6}{5}$. Therefore, the centroid is $(\bar{x}, \bar{y}) = \left(0, \frac{6}{5} \right)$.

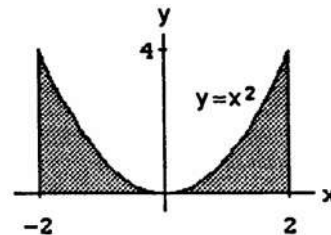

27. The typical *vertical* strip has: center of mass: (\tilde{x}, \tilde{y})

$$= \left(x, \frac{4 + \frac{x^2}{4}}{2} \right), \text{ length: } 4 - \frac{x^2}{4}, \text{ width: } dx,$$

$$\text{area: } dA = \left(4 - \frac{x^2}{4} \right) dx, \text{ mass: } dm = \delta \cdot dA$$

$$= \delta \left(4 - \frac{x^2}{4} \right) dx \Rightarrow \text{the moment about the x-axis is}$$

$$\tilde{y} dm = \delta \cdot \frac{\left(4 + \frac{x^2}{4} \right)}{2} \left(4 - \frac{x^2}{4} \right) dx = \frac{\delta}{2} \left(16 - \frac{x^4}{16} \right) dx; \text{ the}$$

$$\text{moment about the y-axis is } \tilde{x} dm = \delta \left(4 - \frac{x^2}{4} \right) \cdot x dx = \delta \left(4x - \frac{x^3}{4} \right) dx. \text{ Thus, } M_x = \int \tilde{y} dm = \frac{\delta}{2} \int_0^4 \left(16 - \frac{x^4}{16} \right) dx$$

$$= \frac{\delta}{2} \left[16x - \frac{x^5}{5 \cdot 16} \right]_0^4 = \frac{\delta}{2} \left[64 - \frac{64}{5} \right] = \frac{128\delta}{5}; M_y = \int \tilde{x} dm = \delta \int_0^4 \left(4x - \frac{x^3}{4} \right) dx = \delta \left[2x^2 - \frac{x^4}{16} \right]_0^4$$

$$= \delta(32 - 16) = 16\delta; M = \int dm = \delta \int_0^4 \left(4 - \frac{x^2}{4} \right) dx = \delta \left[4x - \frac{x^3}{12} \right]_0^4 = \delta \left(16 - \frac{64}{12} \right) = \frac{32\delta}{3}$$

$$\Rightarrow \bar{x} = \frac{M_y}{M} = \frac{16\delta \cdot 3}{32\delta} = \frac{3}{2} \text{ and } \bar{y} = \frac{M_x}{M} = \frac{128\delta \cdot 3}{5 \cdot 32\delta} = \frac{12}{5}. \text{ Therefore, the centroid is } (\bar{x}, \bar{y}) = \left(\frac{3}{2}, \frac{12}{5} \right).$$

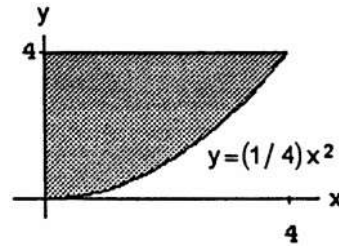

28. A typical *horizontal* strip has:

$$\text{center of mass: } (\tilde{x}, \tilde{y}) = \left(\frac{y^2 + 2y}{2}, y \right), \text{ length: } 2y - y^2,$$

$$\text{width: } dy, \text{ area: } dA = (2y - y^2) dy, \text{ mass: } dm = \delta \cdot dA = \delta(2y - y^2) dy; \text{ the moment about the x-axis is}$$

$$\tilde{y} dm = \delta \cdot y \cdot (2y - y^2) dy = \delta(2y^2 - y^3); \text{ the moment}$$

$$\text{about the y-axis is } \tilde{x} dm = \delta \cdot \frac{(y^2 + 2y)}{2} \cdot (2y - y^2) dy$$

$$= \frac{\delta}{2} (4y^2 - y^4) dy \Rightarrow M_x = \int \tilde{y} dm = \delta \int_0^2 (2y^2 - y^3) dy$$

$$= \delta \left[\frac{2}{3} y^3 - \frac{y^4}{4} \right]_0^2 = \delta \left(\frac{2}{3} \cdot 8 - \frac{16}{4} \right) = \delta \left(\frac{16}{3} - \frac{16}{4} \right) = \frac{\delta \cdot 16}{12} = \frac{4\delta}{3}; M_y = \int \tilde{x} dm = \frac{\delta}{2} \int_0^2 (4y^2 - y^4) dy = \frac{\delta}{2} \left[\frac{4}{3} y^3 - \frac{y^5}{5} \right]_0^2$$

$$= \frac{\delta}{2} \left(\frac{4 \cdot 8}{3} - \frac{32}{5} \right) = \frac{32\delta}{15}; M = \int dm = \delta \int_0^2 (2y - y^2) dy = \delta \left[y^2 - \frac{y^3}{3} \right]_0^2 = \delta \left(4 - \frac{8}{3} \right) = \frac{4\delta}{3} \Rightarrow \bar{x} = \frac{M_y}{M} = \frac{\delta \cdot 32 \cdot 3}{15 \cdot \delta \cdot 4} = \frac{8}{5} \text{ and}$$

$$\bar{y} = \frac{M_x}{M} = \frac{4 \cdot \delta \cdot 3}{3 \cdot \delta \cdot 4} = 1. \text{ Therefore, the centroid is } (\bar{x}, \bar{y}) = \left(\frac{8}{5}, 1 \right).$$

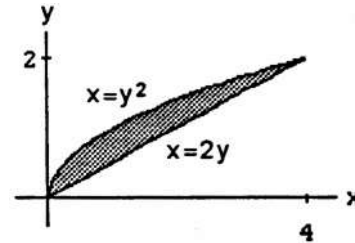

29. A typical horizontal strip has: center of mass: (\tilde{x}, \tilde{y})

$$= \left(\frac{y^2 + 2y}{2}, y \right), \text{ length: } 2y - y^2, \text{ width: } dy,$$

$$\text{area: } dA = (2y - y^2) dy, \text{ mass: } dm = \delta \cdot dA$$

$$= (1 + y)(2y - y^2) dy \Rightarrow \text{the moment about the}$$

$$\text{x-axis is } \tilde{y} dm = y(1 + y)(2y - y^2) dy$$

$$= (2y^2 + 2y^3 - y^3 - y^4) dy$$

$$= (2y^2 + y^3 - y^4) dy; \text{ the moment about the y-axis is}$$

$$\tilde{x} dm = \left(\frac{y^2 + 2y}{2} \right) (1 + y)(2y - y^2) dy = \frac{1}{2} (4y^2 - y^4)(1 + y) dy = \frac{1}{2} (4y^2 + 4y^3 - y^4 - y^5) dy$$

$$\Rightarrow M_x = \int \tilde{y} dm = \int_0^2 (2y^2 + y^3 - y^4) dy = \left[\frac{2}{3} y^3 + \frac{y^4}{4} - \frac{y^5}{5} \right]_0^2 = \left(\frac{16}{3} + \frac{16}{4} - \frac{32}{5} \right) = 16 \left(\frac{1}{3} + \frac{1}{4} - \frac{2}{5} \right)$$

$$= \frac{16}{60} (20 + 15 - 24) = \frac{4}{15} (11) = \frac{44}{15}; M_y = \int \tilde{x} dm = \int_0^2 \frac{1}{2} (4y^2 + 4y^3 - y^4 - y^5) dy = \frac{1}{2} \left[\frac{4}{3} y^3 + y^4 - \frac{y^5}{5} - \frac{y^6}{6} \right]_0^2$$

$$= \frac{1}{2} \left(\frac{4 \cdot 2^3}{3} + 2^4 - \frac{2^5}{5} - \frac{2^6}{6} \right) = 4 \left(\frac{4}{3} + 2 - \frac{4}{5} - \frac{8}{6} \right) = 4 \left(2 - \frac{4}{5} \right) = \frac{24}{5}; M = \int dm = \int_0^2 (1 + y)(2y - y^2) dy$$

$$= \int_0^2 (2y + y^2 - y^3) dy = \left[y^2 + \frac{y^3}{3} - \frac{y^4}{4} \right]_0^2 = \left(4 + \frac{8}{3} - \frac{16}{4} \right) = \frac{8}{3} \Rightarrow \bar{x} = \frac{M_y}{M} = \left(\frac{24}{5} \right) \left(\frac{3}{8} \right) = \frac{9}{5} \text{ and } \bar{y} = \frac{M_x}{M}$$

$$= \left(\frac{44}{15} \right) \left(\frac{3}{8} \right) = \frac{44}{40} = \frac{11}{10}. \text{ Therefore, the center of mass is } (\bar{x}, \bar{y}) = \left(\frac{9}{5}, \frac{11}{10} \right).$$

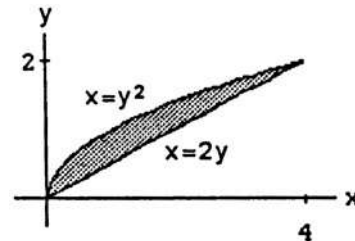

30. A typical vertical strip has: center of mass: $(\tilde{x}, \tilde{y}) = \left(x, \frac{3}{2x^{3/2}} \right)$, length: $\frac{3}{x^{3/2}}$, width: dx ,

$$\text{area: } dA = \frac{3}{x^{3/2}} dx, \text{ mass: } dm = \delta \cdot dA = \delta \cdot \frac{3}{x^{3/2}} dx \Rightarrow \text{the moment about the x-axis is}$$

$$\tilde{y} \, dm = \frac{3}{2x^{3/2}} \cdot \delta \frac{3}{x^{3/2}} \, dx = \frac{9\delta}{2x^3} \, dx; \text{ the moment about the y-axis is } \tilde{x} \, dm = x \cdot \delta \frac{3}{x^{3/2}} \, dx = \frac{3\delta}{x^{1/2}} \, dx.$$

$$(a) \, M_x = \delta \int_1^9 \frac{1}{2} \left(\frac{9}{x^3} \right) \, dx = \frac{9\delta}{2} \left[-\frac{x^{-2}}{2} \right]_1^9 = \frac{20\delta}{9}; \, M_y = \delta \int_1^9 x \left(\frac{3}{x^{3/2}} \right) \, dx = 3\delta \left[2x^{1/2} \right]_1^9 = 12\delta;$$

$$M = \delta \int_1^9 \frac{3}{x^{3/2}} \, dx = -6\delta \left[x^{-1/2} \right]_1^9 = 4\delta \Rightarrow \bar{x} = \frac{M_y}{M} = \frac{12\delta}{4\delta} = 3 \text{ and } \bar{y} = \frac{M_x}{M} = \frac{(20\delta/9)}{4\delta} = \frac{5}{9}$$

$$(b) \, M_x = \int_1^9 \frac{x}{2} \left(\frac{9}{x^3} \right) \, dx = \frac{9}{2} \left[-\frac{1}{x} \right]_1^9 = 4; \, M_y = \int_1^9 x^2 \left(\frac{3}{x^{3/2}} \right) \, dx = \left[2x^{3/2} \right]_1^9 = 52; \, M = \int_1^9 x \left(\frac{3}{x^{3/2}} \right) \, dx = 6 \left[x^{1/2} \right]_1^9 = 12 \Rightarrow \bar{x} = \frac{M_y}{M} = \frac{13}{3} \text{ and } \bar{y} = \frac{M_x}{M} = \frac{1}{3}$$

$$31. \, S = \int_a^b 2\pi y \sqrt{1 + \left(\frac{dy}{dx} \right)^2} \, dx; \, \frac{dy}{dx} = \frac{1}{\sqrt{2x+1}} \Rightarrow \left(\frac{dy}{dx} \right)^2 = \frac{1}{2x+1} \Rightarrow S = \int_0^3 2\pi \sqrt{2x+1} \sqrt{1 + \frac{1}{2x+1}} \, dx \\ = 2\pi \int_0^3 \sqrt{2x+1} \sqrt{\frac{2x+2}{2x+1}} \, dx = 2\sqrt{2}\pi \int_0^3 \sqrt{x+1} \, dx = 2\sqrt{2}\pi \left[\frac{2}{3} (x+1)^{3/2} \right]_0^3 = 2\sqrt{2}\pi \cdot \frac{2}{3} (8-1) = \frac{28\pi\sqrt{2}}{3}$$

$$32. \, S = \int_a^b 2\pi y \sqrt{1 + \left(\frac{dy}{dx} \right)^2} \, dx; \, \frac{dy}{dx} = x^2 \Rightarrow \left(\frac{dy}{dx} \right)^2 = x^4 \Rightarrow S = \int_0^1 2\pi \cdot \frac{x^3}{3} \sqrt{1+x^4} \, dx = \frac{\pi}{6} \int_0^1 \sqrt{1+x^4} (4x^3) \, dx \\ = \frac{\pi}{6} \int_0^1 \sqrt{1+x^4} \, d(1+x^4) = \frac{\pi}{6} \left[\frac{2}{3} (1+x^4)^{3/2} \right]_0^1 = \frac{\pi}{9} [2\sqrt{2}-1]$$

$$33. \, S = \int_c^d 2\pi x \sqrt{1 + \left(\frac{dx}{dy} \right)^2} \, dy; \, \frac{dx}{dy} = \frac{(\frac{3}{2})(4-2y)}{\sqrt{4y-y^2}} = \frac{2-y}{\sqrt{4y-y^2}} \Rightarrow 1 + \left(\frac{dx}{dy} \right)^2 = \frac{4y-y^2+4-4y+y^2}{4y-y^2} = \frac{4}{4y-y^2} \\ \Rightarrow S = \int_1^2 2\pi \sqrt{4y-y^2} \sqrt{\frac{4}{4y-y^2}} \, dy = 4\pi \int_1^2 dx = 4\pi$$

$$34. \, S = \int_c^d 2\pi x \sqrt{1 + \left(\frac{dx}{dy} \right)^2} \, dy; \, \frac{dx}{dy} = \frac{1}{2\sqrt{y}} \Rightarrow 1 + \left(\frac{dx}{dy} \right)^2 = 1 + \frac{1}{4y} = \frac{4y+1}{4y} \Rightarrow S = \int_2^6 2\pi \sqrt{y} \cdot \frac{\sqrt{4y+1}}{\sqrt{4y}} \, dy \\ = \pi \int_2^6 \sqrt{4y+1} \, dy = \frac{\pi}{4} \left[\frac{2}{3} (4y+1)^{3/2} \right]_2^6 = \frac{\pi}{6} (125-27) = \frac{\pi}{6} (98) = \frac{49\pi}{3}$$

$$35. \, x = \frac{t^2}{2} \text{ and } y = 2t, \, 0 \leq t \leq \sqrt{5} \Rightarrow \frac{dx}{dt} = t \text{ and } \frac{dy}{dt} = 2 \Rightarrow \text{Surface Area} = \int_0^{\sqrt{5}} 2\pi(2t)\sqrt{t^2+4} \, dt = \int_4^9 2\pi u^{1/2} \, du \\ = 2\pi \left[\frac{2}{3} u^{3/2} \right]_4^9 = \frac{76\pi}{3}, \text{ where } u = t^2 + 4 \Rightarrow du = 2t \, dt; \, t = 0 \Rightarrow u = 4, \, t = \sqrt{5} \Rightarrow u = 9$$

$$36. \, x = t^2 + \frac{1}{2t} \text{ and } y = 4\sqrt{t}, \, \frac{1}{\sqrt{2}} \leq t \leq 1 \Rightarrow \frac{dx}{dt} = 2t - \frac{1}{2t^2} \text{ and } \frac{dy}{dt} = \frac{2}{\sqrt{t}} \\ \Rightarrow \text{Surface Area} = \int_{1/\sqrt{2}}^1 2\pi \left(t^2 + \frac{1}{2t} \right) \sqrt{\left(2t - \frac{1}{2t^2} \right)^2 + \left(\frac{2}{\sqrt{t}} \right)^2} \, dt = 2\pi \int_{1/\sqrt{2}}^1 \left(t^2 + \frac{1}{2t} \right) \sqrt{\left(2t + \frac{1}{2t^2} \right)^2} \, dt \\ = 2\pi \int_{1/\sqrt{2}}^1 \left(t^2 + \frac{1}{2t} \right) \left(2t + \frac{1}{2t^2} \right) \, dt = 2\pi \int_{1/\sqrt{2}}^1 \left(2t^3 + \frac{3}{2} + \frac{1}{4} t^{-3} \right) \, dt = 2\pi \left[\frac{1}{2} t^4 + \frac{3}{2} t - \frac{1}{8} t^{-2} \right]_{1/\sqrt{2}}^1 \\ = 2\pi \left(2 - \frac{3\sqrt{2}}{4} \right)$$

37. The equipment alone: the force required to lift the equipment is equal to its weight $\Rightarrow F_1(x) = 100 \, \text{N}$.

The work done is $W_1 = \int_a^b F_1(x) \, dx = \int_0^{40} 100 \, dx = [100x]_0^{40} = 4000 \, \text{J}$; the rope alone: the force required to lift the rope is equal to the weight of the rope paid out at elevation $x \Rightarrow F_2(x) = 0.8(40-x)$. The work done is $W_2 = \int_a^b F_2(x) \, dx = \int_0^{40} 0.8(40-x) \, dx = 0.8 \left[40x - \frac{x^2}{2} \right]_0^{40} = 0.8 \left(40^2 - \frac{40^2}{2} \right) = \frac{(0.8)(1600)}{2} = 640 \, \text{J}$; the total work is $W = W_1 + W_2 = 4000 + 640 = 4640 \, \text{J}$

38. The force required to lift the water is equal to the water's weight, which varies steadily from $8 \cdot 800 \, \text{lb}$ to $8 \cdot 400 \, \text{lb}$ over the 4750 ft elevation. When the truck is x ft off the base of Mt. Washington, the water weight is $F(x) = 8 \cdot 800 \cdot \left(\frac{2 \cdot 4750 - x}{2 \cdot 4750} \right) = (6400) \left(1 - \frac{x}{9500} \right) \, \text{lb}$. The work done is $W = \int_a^b F(x) \, dx$

$$= \int_0^{4750} 6400 \left(1 - \frac{x}{9500}\right) dx = 6400 \left[x - \frac{x^2}{2 \cdot 9500} \right]_0^{4750} = 6400 \left(4750 - \frac{4750^2}{4 \cdot 4750} \right) = \left(\frac{3}{4}\right) (6400)(4750) = 22,800,000 \text{ ft} \cdot \text{lb}$$

39. Force constant: $F = kx \Rightarrow 20 = k \cdot 1 \Rightarrow k = 20 \text{ lb/ft}$; the work to stretch the spring 1 ft is

$$W = \int_0^1 kx \, dx = k \int_0^1 x \, dx = \left[20 \frac{x^2}{2} \right]_0^1 = 10 \text{ ft} \cdot \text{lb}; \text{ the work to stretch the spring an additional foot is}$$

$$W = \int_1^2 kx \, dx = k \int_1^2 x \, dx = 20 \left[\frac{x^2}{2} \right]_1^2 = 20 \left(\frac{4}{2} - \frac{1}{2} \right) = 20 \left(\frac{3}{2} \right) = 30 \text{ ft} \cdot \text{lb}$$

40. Force constant: $F = kx \Rightarrow 200 = k(0.8) \Rightarrow k = 250 \text{ N/m}$; the 300 N force stretches the spring $x = \frac{F}{k}$

$$= \frac{300}{250} = 1.2 \text{ m}; \text{ the work required to stretch the spring that far is then } W = \int_0^{1.2} F(x) \, dx = \int_0^{1.2} 250x \, dx = [125x^2]_0^{1.2} = 125(1.2)^2 = 180 \text{ J}$$

41. We imagine the water divided into thin slabs by planes perpendicular to the y -axis at the points of a partition of the interval $[0, 8]$. The typical slab between the planes at y and $y + \Delta y$ has a volume of about $\Delta V = \pi(\text{radius})^2(\text{thickness})$

$$= \pi \left(\frac{5}{4}y\right)^2 \Delta y = \frac{25\pi}{16} y^2 \Delta y \text{ ft}^3. \text{ The force } F(y) \text{ required to lift this slab is equal to its weight: } F(y) = 62.4 \Delta V$$

$$= \frac{(62.4)(25)}{16} \pi y^2 \Delta y \text{ lb. The distance through which } F(y) \text{ must act to lift this slab to the level 6 ft above the top is}$$

about $(6 + 8 - y) \text{ ft}$, so the work done lifting the slab is about $\Delta W = \frac{(62.4)(25)}{16} \pi y^2 (14 - y) \Delta y \text{ ft} \cdot \text{lb}$. The work done

lifting all the slabs from $y = 0$ to $y = 8$ to the level 6 ft above the top is approximately

$$W \approx \sum_0^8 \frac{(62.4)(25)}{16} \pi y^2 (14 - y) \Delta y \text{ ft} \cdot \text{lb} \text{ so the work to pump the water is the limit of these Riemann sums as the norm of}$$

$$\text{the partition goes to zero: } W = \int_0^8 \frac{(62.4)(25)}{16} \pi y^2 (14 - y) \, dy = \frac{(62.4)(25)\pi}{16} \int_0^8 (14y^2 - y^3) \, dy = (62.4) \left(\frac{25\pi}{16}\right) \left[\frac{14}{3} y^3 - \frac{y^4}{4} \right]_0^8 = (62.4) \left(\frac{25\pi}{16}\right) \left(\frac{14}{3} \cdot 8^3 - \frac{8^4}{4} \right) \approx 418,208.81 \text{ ft} \cdot \text{lb}$$

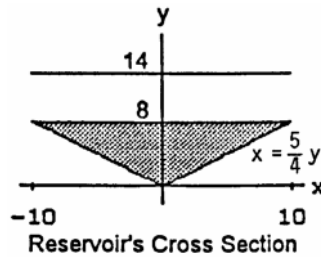

42. The same as in Exercise 41, but change the distance through which $F(y)$ must act to $(8 - y)$ rather than $(6 + 8 - y)$. Also change the upper limit of integration from 8 to 5. The integral is:

$$W = \int_0^5 \frac{(62.4)(25)\pi}{16} y^2 (8 - y) \, dy = (62.4) \left(\frac{25\pi}{16}\right) \int_0^5 (8y^2 - y^3) \, dy = (62.4) \left(\frac{25\pi}{16}\right) \left[\frac{8}{3} y^3 - \frac{y^4}{4} \right]_0^5 = (62.4) \left(\frac{25\pi}{16}\right) \left(\frac{8}{3} \cdot 5^3 - \frac{5^4}{4} \right) \approx 54,241.56 \text{ ft} \cdot \text{lb}$$

43. The tank's cross section looks like the figure in Exercise 41 with right edge given by $x = \frac{5}{10}y = \frac{y}{2}$. A typical

horizontal slab has volume $\Delta V = \pi(\text{radius})^2(\text{thickness}) = \pi \left(\frac{y}{2}\right)^2 \Delta y = \frac{\pi}{4} y^2 \Delta y$. The force required to lift this slab is its weight: $F(y) = 60 \cdot \frac{\pi}{4} y^2 \Delta y$. The distance through which $F(y)$ must act is $(2 + 10 - y) \text{ ft}$, so the

work to pump the liquid is $W = 60 \int_0^{10} \pi(12 - y) \left(\frac{y^2}{4}\right) \, dy = 15\pi \left[\frac{12y^3}{3} - \frac{y^4}{4} \right]_0^{10} = 22,500\pi \text{ ft} \cdot \text{lb}$; the time needed to empty the tank is $\frac{22,500 \text{ ft} \cdot \text{lb}}{275 \text{ ft} \cdot \text{lb/sec}} \approx 257 \text{ sec}$

44. A typical horizontal slab has volume about $\Delta V = (20)(2x)\Delta y = (20) (2\sqrt{16 - y^2}) \Delta y$ and the force required to lift this slab is its weight $F(y) = (57)(20) (2\sqrt{16 - y^2}) \Delta y$. The distance through which $F(y)$ must act is $(6 + 4 - y) \text{ ft}$, so the work to pump the olive oil from the half-full tank is

$$W = 57 \int_{-4}^0 (10 - y)(20) (2\sqrt{16 - y^2}) \, dy = 2880 \int_{-4}^0 10\sqrt{16 - y^2} \, dy + 1140 \int_{-4}^0 (16 - y^2)^{1/2} (-2y) \, dy$$

$$= 22,800 \cdot (\text{area of a quarter circle having radius 4}) + \frac{2}{3}(1140) \left[(16 - y^2)^{3/2} \right]_{-4}^0 = (22,800)(4\pi) + 48,640$$

$$= 335,153.25 \text{ ft} \cdot \text{lb}$$

$$45. F = \int_a^b W \cdot \left(\frac{\text{strip}}{\text{depth}} \right) \cdot L(y) dy \Rightarrow F = 2 \int_0^2 (62.4)(2 - y)(2y) dy = 249.6 \int_0^2 (2y - y^2) dy = 249.6 \left[y^2 - \frac{y^3}{3} \right]_0^2$$

$$= (249.6) \left(4 - \frac{8}{3} \right) = (249.6) \left(\frac{4}{3} \right) = 332.8 \text{ lb}$$

$$46. F = \int_a^b W \cdot \left(\frac{\text{strip}}{\text{depth}} \right) \cdot L(y) dy \Rightarrow F = \int_0^{5/6} 75 \left(\frac{5}{6} - y \right) (2y + 4) dy = 75 \int_0^{5/6} \left(\frac{5}{3}y + \frac{10}{3} - 2y^2 - 4y \right) dy$$

$$= 75 \int_0^{5/6} \left(\frac{10}{3} - \frac{7}{3}y - 2y^2 \right) dy = 75 \left[\frac{10}{3}y - \frac{7}{6}y^2 - \frac{2}{3}y^3 \right]_0^{5/6} = (75) \left[\left(\frac{50}{18} \right) - \left(\frac{7}{6} \right) \left(\frac{25}{36} \right) - \left(\frac{2}{3} \right) \left(\frac{125}{216} \right) \right]$$

$$= (75) \left(\frac{25}{9} - \frac{175}{216} - \frac{250}{3 \cdot 216} \right) = \left(\frac{75}{9 \cdot 216} \right) (25 \cdot 216 - 175 \cdot 9 - 250 \cdot 3) = \frac{(75)(3075)}{9 \cdot 216} \approx 118.63 \text{ lb.}$$

$$47. F = \int_a^b W \cdot \left(\frac{\text{strip}}{\text{depth}} \right) \cdot L(y) dy \Rightarrow F = 62.4 \int_0^4 (9 - y) \left(2 \cdot \frac{\sqrt{y}}{2} \right) dy = 62.4 \int_0^4 (9y^{1/2} - 3y^{3/2}) dy$$

$$= 62.4 \left[6y^{3/2} - \frac{2}{5}y^{5/2} \right]_0^4 = (62.4) \left(6 \cdot 8 - \frac{2}{5} \cdot 32 \right) = \left(\frac{62.4}{5} \right) (48 \cdot 5 - 64) = \frac{(62.4)(176)}{5} = 2196.48 \text{ lb}$$

48. Place the origin at the bottom of the tank. Then $F = \int_0^h W \cdot \left(\frac{\text{strip}}{\text{depth}} \right) \cdot L(y) dy$, h = the height of the mercury column, strip depth = $h - y$, $L(y) = 1 \Rightarrow F = \int_0^h 849(h - y) 1 dy = (849) \int_0^h (h - y) dy = 849 \left[hy - \frac{y^2}{2} \right]_0^h = 849 \left(h^2 - \frac{h^2}{2} \right)$

$$= \frac{849}{2}h^2. \text{ Now solve } \frac{849}{2}h^2 = 40000 \text{ to get } h \approx 9.707 \text{ ft. The volume of the mercury is } s^2h = 1^2 \cdot 9.707 = 9.707 \text{ ft}^3.$$

$$49. F = w_1 \int_0^6 (8 - y)(2)(6 - y) dy + w_2 \int_{-6}^0 (8 - y)(2)(y + 6) dy = 2w_1 \int_0^6 (48 - 14y + y^2) dy + 2w_2 \int_{-6}^0 (48 + 2y - y^2) dy$$

$$= 2w_1 \left[48y - 7y^2 + \frac{y^3}{3} \right]_0^6 + 2w_2 \left[48y + y^2 - \frac{y^3}{3} \right]_{-6}^0 = 216w_1 + 360w_2$$

$$50. (a) F = 62.4 \int_0^6 (10 - y) \left[\left(8 - \frac{y}{6} \right) - \left(\frac{y}{6} \right) \right] dy$$

$$= \frac{62.4}{3} \int_0^6 (240 - 34y + y^2) dy$$

$$= \frac{62.4}{3} \left[240y - 17y^2 + \frac{y^3}{3} \right]_0^6 = \frac{62.4}{3} (1440 - 612 + 72)$$

$$= 18,720 \text{ lb.}$$

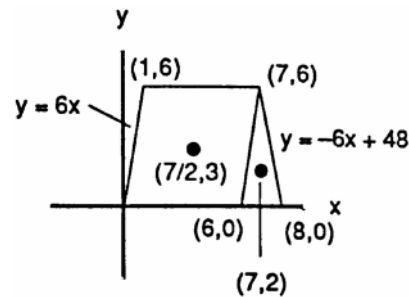

(b) The centroid $\left(\frac{7}{2}, 3 \right)$ of the parallelogram is located at the intersection of $y = \frac{6}{7}x$ and $y = -\frac{6}{5}x + \frac{36}{5}$. The centroid of the triangle is located at $(7, 2)$. Therefore, $F = (62.4)(7)(36) + (62.4)(8)(6) = (300)(62.4) = 18,720 \text{ lb}$

CHAPTER 6 ADDITIONAL AND ADVANCED EXERCISES

- $V = \pi \int_a^b [f(x)]^2 dx = b^2 - ab \Rightarrow \pi \int_a^x [f(t)]^2 dt = x^2 - ax$ for all $x > a \Rightarrow \pi [f(x)]^2 = 2x - a \Rightarrow f(x) = \pm \sqrt{\frac{2x - a}{\pi}}$
- $V = \pi \int_0^a [f(x)]^2 dx = a^2 + a \Rightarrow \pi \int_0^x [f(t)]^2 dt = x^2 + x$ for all $x > a \Rightarrow \pi [f(x)]^2 = 2x + 1 \Rightarrow f(x) = \pm \sqrt{\frac{2x + 1}{\pi}}$
- $s(x) = Cx \Rightarrow \int_0^x \sqrt{1 + [f'(t)]^2} dt = Cx \Rightarrow \sqrt{1 + [f'(x)]^2} = C \Rightarrow f'(x) = \sqrt{C^2 - 1}$ for $C \geq 1$
 $\Rightarrow f(x) = \int_0^x \sqrt{C^2 - 1} dt + k$. Then $f(0) = a \Rightarrow a = 0 + k \Rightarrow f(x) = \int_0^x \sqrt{C^2 - 1} dt + a \Rightarrow f(x) = x\sqrt{C^2 - 1} + a$, where $C \geq 1$.

4. (a) The graph of $f(x) = \sin x$ traces out a path from $(0, 0)$ to $(\alpha, \sin \alpha)$ whose length is $L = \int_0^\alpha \sqrt{1 + \cos^2 \theta} d\theta$. The line segment from $(0, 0)$ to $(\alpha, \sin \alpha)$ has length $\sqrt{(\alpha - 0)^2 + (\sin \alpha - 0)^2} = \sqrt{\alpha^2 + \sin^2 \alpha}$. Since the shortest distance between two points is the length of the straight line segment joining them, we have immediately that $\int_0^\alpha \sqrt{1 + \cos^2 \theta} d\theta > \sqrt{\alpha^2 + \sin^2 \alpha}$ if $0 < \alpha \leq \frac{\pi}{2}$.

(b) In general, if $y = f(x)$ is continuously differentiable and $f(0) = 0$, then $\int_0^\alpha \sqrt{1 + [f'(t)]^2} dt > \sqrt{\alpha^2 + f^2(\alpha)}$ for $\alpha > 0$.

5. From the symmetry of $y = 1 - x^n$, n even, about the y -axis for $-1 \leq x \leq 1$, we have $\bar{x} = 0$. To find $\bar{y} = \frac{M_x}{M}$, we use the vertical strips technique. The typical strip has center of mass: $(\tilde{x}, \tilde{y}) = (x, \frac{1-x^n}{2})$, length: $1 - x^n$, width: dx , area: $dA = (1 - x^n) dx$, mass: $dm = 1 \cdot dA = (1 - x^n) dx$. The moment of the strip about the x -axis is $\tilde{y} dm = \frac{(1-x^n)^2}{2} dx \Rightarrow M_x = \int_{-1}^1 \frac{(1-x^n)^2}{2} dx = 2 \int_0^1 \frac{1}{2} (1 - 2x^n + x^{2n}) dx = [x - \frac{2x^{n+1}}{n+1} + \frac{x^{2n+1}}{2n+1}]_0^1 = 1 - \frac{2}{n+1} + \frac{1}{2n+1} = \frac{(n+1)(2n+1) - 2(2n+1) + (n+1)}{(n+1)(2n+1)} = \frac{2n^2 + 3n + 1 - 4n - 2 + n + 1}{(n+1)(2n+1)} = \frac{2n^2}{(n+1)(2n+1)}$. Also, $M = \int_{-1}^1 dA = \int_{-1}^1 (1 - x^n) dx = 2 \int_0^1 (1 - x^n) dx = 2 [x - \frac{x^{n+1}}{n+1}]_0^1 = 2(1 - \frac{1}{n+1}) = \frac{2n}{n+1}$. Therefore, $\bar{y} = \frac{M_x}{M} = \frac{2n^2}{(n+1)(2n+1)} \cdot \frac{(n+1)}{2n} = \frac{n}{2n+1} \Rightarrow (0, \frac{n}{2n+1})$ is the location of the centroid. As $n \rightarrow \infty$, $\bar{y} \rightarrow \frac{1}{2}$ so the limiting position of the centroid is $(0, \frac{1}{2})$.

6. Align the telephone pole along the x -axis as shown in the accompanying figure. The slope of the top length of pole is

$$\frac{(\frac{14.5}{8\pi} - \frac{9}{8\pi})}{40} = \frac{1}{8\pi} \cdot \frac{1}{40} \cdot (14.5 - 9) = \frac{5.5}{8\pi \cdot 40} = \frac{11}{8\pi \cdot 80}$$

Thus, $y = \frac{9}{8\pi} + \frac{11}{8\pi \cdot 80} x = \frac{1}{8\pi} (9 + \frac{11}{80} x)$ is an equation of the line representing the top of the pole. Then,

$$M_y = \int_a^b x \cdot \pi y^2 dx = \pi \int_0^{40} x [\frac{1}{8\pi} (9 + \frac{11}{80} x)]^2 dx$$

$$= \frac{1}{64\pi} \int_0^{40} x (9 + \frac{11}{80} x)^2 dx; M = \int_a^b \pi y^2 dx$$

$= \pi \int_0^{40} [\frac{1}{8\pi} (9 + \frac{11}{80} x)]^2 dx = \frac{1}{64\pi} \int_0^{40} (9 + \frac{11}{80} x)^2 dx$. Thus, $\bar{x} = \frac{M_y}{M} \approx \frac{129,700}{5623.3} \approx 23.06$ (using a calculator to compute the integrals). By symmetry about the x -axis, $\bar{y} = 0$ so the center of mass is about 23 ft from the top of the pole.

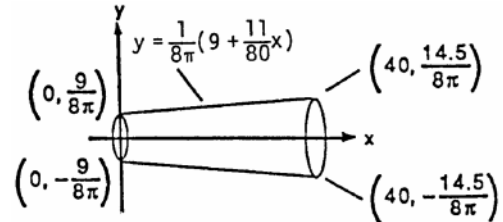

7. (a) Consider a single vertical strip with center of mass (\tilde{x}, \tilde{y}) . If the plate lies to the right of the line, then the moment of this strip about the line $x = b$ is $(\tilde{x} - b) dm = (\tilde{x} - b) \delta dA \Rightarrow$ the plate's first moment about $x = b$ is the integral $\int (x - b) \delta dA = \int \delta x dA - \int \delta b dA = M_y - b \delta A$.

(b) If the plate lies to the left of the line, the moment of a vertical strip about the line $x = b$ is

$$(b - \tilde{x}) dm = (b - \tilde{x}) \delta dA \Rightarrow \text{the plate's first moment about } x = b \text{ is } \int (b - x) \delta dA = \int b \delta dA - \int \delta x dA = b \delta A - M_y.$$

8. (a) By symmetry of the plate about the x -axis, $\bar{y} = 0$. A typical vertical strip has center of mass:

$(\tilde{x}, \tilde{y}) = (x, 0)$, length: $4\sqrt{ax}$, width: dx , area: $4\sqrt{ax} dx$, mass: $dm = \delta dA = kx \cdot 4\sqrt{ax} dx$, for some proportionality constant k . The moment of the strip about the y -axis is $M_y = \int \tilde{x} dm = \int_0^a 4kx^2 \sqrt{ax} dx = 4k\sqrt{a} \int_0^a x^{5/2} dx = 4k\sqrt{a} [\frac{2}{7} x^{7/2}]_0^a = 4ka^{1/2} \cdot \frac{2}{7} a^{7/2} = \frac{8ka^4}{7}$. Also, $M = \int dm = \int_0^a 4kx\sqrt{ax} dx = 4k\sqrt{a} \int_0^a x^{3/2} dx = 4k\sqrt{a} [\frac{2}{5} x^{5/2}]_0^a = 4ka^{1/2} \cdot \frac{2}{5} a^{5/2} = \frac{8ka^3}{5}$. Thus, $\bar{x} = \frac{M_y}{M} = \frac{8ka^4}{7} \cdot \frac{5}{8ka^3} = \frac{5}{7} a \Rightarrow (\bar{x}, \bar{y}) = (\frac{5a}{7}, 0)$ is the center of mass.

(b) A typical horizontal strip has center of mass: $(\tilde{x}, \tilde{y}) = (\frac{\frac{y^2}{4a} + a}{2}, y) = (\frac{y^2 + 4a^2}{8a}, y)$, length: $a - \frac{y^2}{4a}$, width: dy , area: $(a - \frac{y^2}{4a}) dy$, mass: $dm = \delta dA = |y| (a - \frac{y^2}{4a}) dy$. Thus, $M_x = \int \tilde{y} dm$

$$\begin{aligned}
&= \int_{-2a}^{2a} y |y| \left(a - \frac{y^2}{4a} \right) dy = \int_{-2a}^0 -y^2 \left(a - \frac{y^2}{4a} \right) dy + \int_0^{2a} y^2 \left(a - \frac{y^2}{4a} \right) dy \\
&= \int_{-2a}^0 \left(-ay^2 + \frac{y^4}{4a} \right) dy + \int_0^{2a} \left(ay^2 - \frac{y^4}{4a} \right) dy = \left[-\frac{a}{3} y^3 + \frac{y^5}{20a} \right]_{-2a}^0 + \left[\frac{a}{3} y^3 - \frac{y^5}{20a} \right]_0^{2a} \\
&= -\frac{8a^4}{3} + \frac{32a^5}{20a} + \frac{8a^4}{3} - \frac{32a^5}{20a} = 0; M_y = \int \tilde{x} \, dm = \int_{-2a}^{2a} \left(\frac{y^2 + 4a^2}{8a} \right) |y| \left(a - \frac{y^2}{4a} \right) dy \\
&= \frac{1}{8a} \int_{-2a}^{2a} |y| (y^2 + 4a^2) \left(\frac{4a^2 - y^2}{4a} \right) dy = \frac{1}{32a^2} \int_{-2a}^{2a} |y| (16a^4 - y^4) dy \\
&= \frac{1}{32a^2} \int_{-2a}^0 (-16a^4 y + y^5) dy + \frac{1}{32a^2} \int_0^{2a} (16a^4 y - y^5) dy = \frac{1}{32a^2} \left[-8a^4 y^2 + \frac{y^6}{6} \right]_{-2a}^0 + \frac{1}{32a^2} \left[8a^4 y^2 - \frac{y^6}{6} \right]_0^{2a} \\
&= \frac{1}{32a^2} \left[8a^4 \cdot 4a^2 - \frac{64a^6}{6} \right] + \frac{1}{32a^2} \left[8a^4 \cdot 4a^2 - \frac{64a^6}{6} \right] = \frac{1}{16a^2} \left(32a^6 - \frac{32a^6}{3} \right) = \frac{1}{16a^2} \cdot \frac{2}{3} (32a^6) = \frac{4}{3} a^4; \\
M &= \int dm = \int_{-2a}^{2a} |y| \left(\frac{4a^2 - y^2}{4a} \right) dy = \frac{1}{4a} \int_{-2a}^{2a} |y| (4a^2 - y^2) dy \\
&= \frac{1}{4a} \int_{-2a}^0 (-4a^2 y + y^3) dy + \frac{1}{4a} \int_0^{2a} (4a^2 y - y^3) dy = \frac{1}{4a} \left[-2a^2 y^2 + \frac{y^4}{4} \right]_{-2a}^0 + \frac{1}{4a} \left[2a^2 y^2 - \frac{y^4}{4} \right]_0^{2a} \\
&= 2 \cdot \frac{1}{4a} \left(2a^2 \cdot 4a^2 - \frac{16a^4}{4} \right) = \frac{1}{2a} (8a^4 - 4a^4) = 2a^3. \text{ Therefore, } \bar{x} = \frac{M_y}{M} = \left(\frac{4}{3} a^4 \right) \left(\frac{1}{2a^3} \right) = \frac{2a}{3} \text{ and } \\
\bar{y} &= \frac{M_x}{M} = 0 \text{ is the center of mass.}
\end{aligned}$$

9. (a) On $[0, a]$ a typical *vertical* strip has center of mass: $(\tilde{x}, \tilde{y}) = \left(x, \frac{\sqrt{b^2 - x^2} + \sqrt{a^2 - x^2}}{2} \right)$,

length: $\sqrt{b^2 - x^2} - \sqrt{a^2 - x^2}$, width: dx , area: $dA = \left(\sqrt{b^2 - x^2} - \sqrt{a^2 - x^2} \right) dx$, mass: $dm = \delta \, dA$

$= \delta \left(\sqrt{b^2 - x^2} - \sqrt{a^2 - x^2} \right) dx$. On $[a, b]$ a typical *vertical* strip has center of mass:

$(\tilde{x}, \tilde{y}) = \left(x, \frac{\sqrt{b^2 - x^2}}{2} \right)$, length: $\sqrt{b^2 - x^2}$, width: dx , area: $dA = \sqrt{b^2 - x^2} \, dx$,

mass: $dm = \delta \, dA = \delta \sqrt{b^2 - x^2} \, dx$. Thus, $M_x = \int \tilde{y} \, dm$

$$\begin{aligned}
&= \int_0^a \frac{1}{2} \left(\sqrt{b^2 - x^2} + \sqrt{a^2 - x^2} \right) \delta \left(\sqrt{b^2 - x^2} - \sqrt{a^2 - x^2} \right) dx + \int_a^b \frac{1}{2} \sqrt{b^2 - x^2} \delta \sqrt{b^2 - x^2} dx \\
&= \frac{\delta}{2} \int_0^a \left[(b^2 - x^2) - (a^2 - x^2) \right] dx + \frac{\delta}{2} \int_a^b (b^2 - x^2) dx = \frac{\delta}{2} \int_0^a (b^2 - a^2) dx + \frac{\delta}{2} \int_a^b (b^2 - x^2) dx \\
&= \frac{\delta}{2} \left[(b^2 - a^2) x \right]_0^a + \frac{\delta}{2} \left[b^2 x - \frac{x^3}{3} \right]_a^b = \frac{\delta}{2} \left[(b^2 - a^2) a \right] + \frac{\delta}{2} \left[\left(b^3 - \frac{b^3}{3} \right) - \left(b^2 a - \frac{a^3}{3} \right) \right] \\
&= \frac{\delta}{2} (ab^2 - a^3) + \frac{\delta}{2} \left(\frac{2}{3} b^3 - ab^2 + \frac{a^3}{3} \right) = \frac{\delta b^3}{3} - \frac{\delta a^3}{3} = \delta \left(\frac{b^3 - a^3}{3} \right); M_y = \int \tilde{x} \, dm \\
&= \int_0^a x \delta \left(\sqrt{b^2 - x^2} - \sqrt{a^2 - x^2} \right) dx + \int_a^b x \delta \sqrt{b^2 - x^2} dx \\
&= \delta \int_0^a x (b^2 - x^2)^{1/2} dx - \delta \int_0^a x (a^2 - x^2)^{1/2} dx + \delta \int_a^b x (b^2 - x^2)^{1/2} dx \\
&= \frac{-\delta}{2} \left[\frac{2(b^2 - x^2)^{3/2}}{3} \right]_0^a + \frac{\delta}{2} \left[\frac{2(a^2 - x^2)^{3/2}}{3} \right]_0^a - \frac{\delta}{2} \left[\frac{2(b^2 - x^2)^{3/2}}{3} \right]_a^b \\
&= -\frac{\delta}{3} \left[(b^2 - a^2)^{3/2} - (b^2)^{3/2} \right] + \frac{\delta}{3} \left[0 - (a^2)^{3/2} \right] - \frac{\delta}{3} \left[0 - (b^2 - a^2)^{3/2} \right] = \frac{\delta b^3}{3} - \frac{\delta a^3}{3} = \frac{\delta (b^3 - a^3)}{3} = M_x;
\end{aligned}$$

We calculate the mass geometrically: $M = \delta A = \delta \left(\frac{\pi b^2}{4} \right) - \delta \left(\frac{\pi a^2}{4} \right) = \frac{\delta \pi}{4} (b^2 - a^2)$. Thus, $\bar{x} = \frac{M_y}{M}$

$$= \frac{\delta (b^3 - a^3)}{3} \cdot \frac{4}{\delta \pi (b^2 - a^2)} = \frac{4}{3\pi} \left(\frac{b^3 - a^3}{b^2 - a^2} \right) = \frac{4}{3\pi} \frac{(b-a)(a^2 + ab + b^2)}{(b-a)(b+a)} = \frac{4(a^2 + ab + b^2)}{3\pi(a+b)}; \text{ likewise}$$

$$\bar{y} = \frac{M_x}{M} = \frac{4(a^2 + ab + b^2)}{3\pi(a+b)}.$$

- (b) $\lim_{b \rightarrow a} \frac{4}{3\pi} \left(\frac{a^2 + ab + b^2}{a+b} \right) = \left(\frac{4}{3\pi} \right) \left(\frac{a^2 + a^2 + a^2}{a+a} \right) = \left(\frac{4}{3\pi} \right) \left(\frac{3a^2}{2a} \right) = \frac{2a}{\pi} \Rightarrow (\bar{x}, \bar{y}) = \left(\frac{2a}{\pi}, \frac{2a}{\pi} \right)$ is the limiting position of the centroid as $b \rightarrow a$. This is the centroid of a circle of radius a (and we note the two circles coincide when $b = a$).

10. Since the area of the triangle is 36, the diagram may be labeled as shown at the right. The centroid of the triangle is $(\frac{a}{3}, \frac{2a}{3})$. The shaded portion is $144 - 36 = 108$. Write $(\underline{x}, \underline{y})$ for the centroid of the remaining region. The centroid of the whole square is obviously $(6, 6)$. Think of the square as a sheet of uniform density, so that the centroid of the square is the average of the centroids of the two regions, weighted by area:

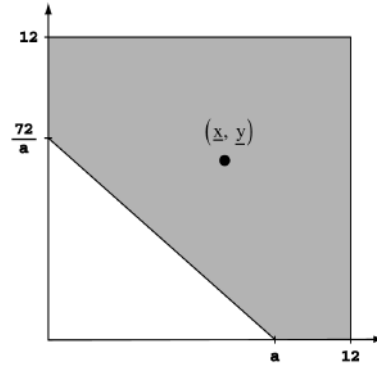

$$6 = \frac{36(\frac{a}{3}) + 108(\underline{x})}{144} \text{ and } 6 = \frac{36(\frac{2a}{3}) + 108(\underline{y})}{144}$$

which we solve to get $\underline{x} = 8 - \frac{a}{9}$ and $\underline{y} = \frac{8(a-1)}{a}$. Set

$$\underline{x} = 7 \text{ in. (Given). It follows that } a = 9, \text{ whence } \underline{y} = \frac{64}{9}$$

$= 7\frac{1}{9}$ in. The distances of the centroid $(\underline{x}, \underline{y})$ from the other sides are easily computed. (Note that if we set $\underline{y} = 7$ in. above, we will find $\underline{x} = 7\frac{1}{9}$.)

11. $y = 2\sqrt{x} \Rightarrow ds = \sqrt{\frac{1}{x} + 1} dx \Rightarrow A = \int_0^3 2\sqrt{x} \sqrt{\frac{1}{x} + 1} dx = \frac{4}{3} [(1+x)^{3/2}]_0^3 = \frac{28}{3}$

12. This surface is a triangle having a base of $2\pi a$ and a height of $2\pi ak$. Therefore the surface area is $\frac{1}{2}(2\pi a)(2\pi ak) = 2\pi^2 a^2 k$.

13. $F = ma = t^2 \Rightarrow \frac{d^2x}{dt^2} = a = \frac{t^2}{m} \Rightarrow v = \frac{dx}{dt} = \frac{t^3}{3m} + C$; $v = 0$ when $t = 0 \Rightarrow C = 0 \Rightarrow \frac{dx}{dt} = \frac{t^3}{3m} \Rightarrow x = \frac{t^4}{12m} + C_1$;
 $x = 0$ when $t = 0 \Rightarrow C_1 = 0 \Rightarrow x = \frac{t^4}{12m}$. Then $x = h \Rightarrow t = (12mh)^{1/4}$. The work done is

$$W = \int F dx = \int_0^{(12mh)^{1/4}} F(t) \cdot \frac{dx}{dt} dt = \int_0^{(12mh)^{1/4}} t^2 \cdot \frac{t^3}{3m} dt = \frac{1}{3m} \left[\frac{t^6}{6} \right]_0^{(12mh)^{1/4}} = \left(\frac{1}{18m} \right) (12mh)^{6/4}$$

$$= \frac{(12mh)^{3/2}}{18m} = \frac{12mh \cdot \sqrt{12mh}}{18m} = \frac{2h}{3} \cdot 2\sqrt{3mh} = \frac{4h}{3} \sqrt{3mh}$$

14. Converting to pounds and feet, $2 \text{ lb/in} = \frac{2 \text{ lb}}{1 \text{ in}} \cdot \frac{12 \text{ in}}{1 \text{ ft}} = 24 \text{ lb/ft}$. Thus, $F = 24x \Rightarrow W = \int_0^{1/2} 24x dx = [12x^2]_0^{1/2} = 3 \text{ ft} \cdot \text{lb}$. Since $W = \frac{1}{2} mv_0^2 - \frac{1}{2} mv_1^2$, where $W = 3 \text{ ft} \cdot \text{lb}$, $m = (\frac{1}{10} \text{ lb}) (\frac{1}{32 \text{ ft/sec}^2}) = \frac{1}{320} \text{ slugs}$, and $v_1 = 0 \text{ ft/sec}$, we have $3 = (\frac{1}{2}) (\frac{1}{320} v_0^2) \Rightarrow v_0^2 = 3 \cdot 640$. For the projectile height, $s = -16t^2 + v_0 t$ (since $s = 0$ at $t = 0$) $\Rightarrow \frac{ds}{dt} = v = -32t + v_0$. At the top of the ball's path, $v = 0 \Rightarrow t = \frac{v_0}{32}$ and the height is $s = -16 (\frac{v_0}{32})^2 + v_0 (\frac{v_0}{32}) = \frac{v_0^2}{64} = \frac{3 \cdot 640}{64} = 30 \text{ ft}$.

15. The submerged triangular plate is depicted in the figure at the right. The hypotenuse of the triangle has slope $-1 \Rightarrow y - (-2) = -(x - 0) \Rightarrow x = -(y + 2)$ is an equation of the hypotenuse. Using a typical horizontal strip, the fluid pressure is $F = \int (62.4) \cdot \left(\frac{\text{strip}}{\text{depth}} \right) \cdot \left(\frac{\text{strip}}{\text{length}} \right) dy$

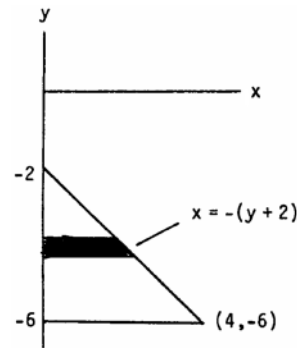

$$= \int_{-6}^{-2} (62.4)(-y)[- (y + 2)] dy = 62.4 \int_{-6}^{-2} (y^2 + 2y) dy$$

$$= 62.4 \left[\frac{y^3}{3} + y^2 \right]_{-6}^{-2} = (62.4) \left[\left(-\frac{8}{3} + 4 \right) - \left(-\frac{216}{3} + 36 \right) \right]$$

$$= (62.4) \left(\frac{208}{3} - 32 \right) = \frac{(62.4)(112)}{3} \approx 2329.6 \text{ lb}$$

16. Consider a rectangular plate of length ℓ and width w .
The length is parallel with the surface of the fluid of weight density ω . The force on one side of the plate is

$$F = \omega \int_{-w}^0 (-y)(\ell) dy = -\omega\ell \left[\frac{y^2}{2} \right]_{-w}^0 = \frac{\omega\ell w^2}{2}.$$

The average force on one side of the plate is $F_{av} = \frac{\omega}{w} \int_{-w}^0 (-y) dy$
 $= \frac{\omega}{w} \left[-\frac{y^2}{2} \right]_{-w}^0 = \frac{\omega w}{2}.$ Therefore the force $\frac{\omega\ell w^2}{2}$
 $= \left(\frac{\omega w}{2} \right) (\ell w) = (\text{the average pressure up and down}) \cdot (\text{the area of the plate}).$

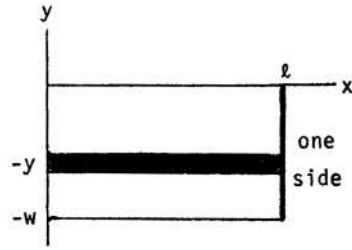

17. (a) We establish a coordinate system as shown. A typical horizontal strip has: center of pressure: (\tilde{x}, \tilde{y})

$$= \left(\frac{b}{2}, y \right), \text{ length: } L(y) = b, \text{ width: } dy, \text{ area: } dA = b dy, \text{ pressure: } dp = \omega |y| dA = \omega b |y| dy$$

$$\Rightarrow F_x = \int \tilde{y} dp = \int_{-h}^0 y \cdot \omega b |y| dy = -\omega b \int_{-h}^0 y^2 dy$$

$$= -\omega b \left[\frac{y^3}{3} \right]_{-h}^0 = -\omega b \left[0 - \left(\frac{-h^3}{3} \right) \right] = \frac{-\omega b h^3}{3};$$

$$F = \int dp = \int_{-h}^0 \omega |y| L(y) dy = -\omega b \int_{-h}^0 y dy$$

$$= -\omega b \left[\frac{y^2}{2} \right]_{-h}^0 = -\omega b \left[0 - \frac{h^2}{2} \right] = \frac{\omega b h^2}{2}.$$
 Thus, $\bar{y} = \frac{F_x}{F} = \frac{\left(\frac{-\omega b h^3}{3} \right)}{\left(\frac{\omega b h^2}{2} \right)} = \frac{-2h}{3} \Rightarrow$ the distance below the surface is $\frac{2}{3} h$.

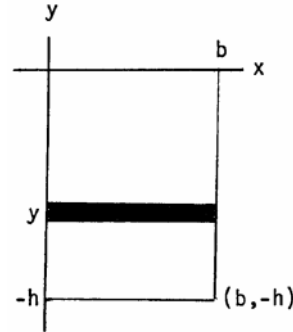

- (b) A typical horizontal strip has length $L(y)$. By similar triangles from the figure at the right, $\frac{L(y)}{b} = \frac{-y-a}{h}$

$$\Rightarrow L(y) = -\frac{b}{h}(y+a).$$
 Thus, a typical strip has center of pressure: $(\tilde{x}, \tilde{y}) = (\tilde{x}, y)$, length: $L(y) = -\frac{b}{h}(y+a)$, width: dy , area: $dA = -\frac{b}{h}(y+a) dy$, pressure: $dp = \omega |y| dA = \omega(-y) \left(-\frac{b}{h} \right) (y+a) dy$

$$= \frac{\omega b}{h} (y^2 + ay) dy \Rightarrow F_x = \int \tilde{y} dp$$

$$= \int_{-(a+h)}^{-a} y \cdot \frac{\omega b}{h} (y^2 + ay) dy = \frac{\omega b}{h} \int_{-(a+h)}^{-a} (y^3 + ay^2) dy$$

$$= \frac{\omega b}{h} \left[\frac{y^4}{4} + \frac{ay^3}{3} \right]_{-(a+h)}^{-a}$$

$$= \frac{\omega b}{h} \left[\left(\frac{a^4}{4} - \frac{a^4}{3} \right) - \left(\frac{(a+h)^4}{4} - \frac{a(a+h)^3}{3} \right) \right] = \frac{\omega b}{h} \left[\frac{a^4 - (a+h)^4}{4} - \frac{a^4 - a(a+h)^3}{3} \right]$$

$$= \frac{\omega b}{12h} [3(a^4 - (a^4 + 4a^3h + 6a^2h^2 + 4ah^3 + h^4)) - 4(a^4 - a(a^3 + 3a^2h + 3ah^2 + h^3))]$$

$$= \frac{\omega b}{12h} (12a^3h + 12a^2h^2 + 4ah^3 - 12a^3h - 18a^2h^2 - 12ah^3 - 3h^4) = \frac{\omega b}{12h} (-6a^2h^2 - 8ah^3 - 3h^4)$$

$$= \frac{-\omega b h}{12} (6a^2 + 8ah + 3h^2); F = \int dp = \int \omega |y| L(y) dy = \frac{\omega b}{h} \int_{-(a+h)}^{-a} (y^2 + ay) dy = \frac{\omega b}{h} \left[\frac{y^3}{3} + \frac{ay^2}{2} \right]_{-(a+h)}^{-a}$$

$$= \frac{\omega b}{h} \left[\left(\frac{-a^3}{3} + \frac{a^3}{2} \right) - \left(\frac{-(a+h)^3}{3} + \frac{a(a+h)^2}{2} \right) \right] = \frac{\omega b}{h} \left[\frac{(a+h)^3 - a^3}{3} + \frac{a^3 - a(a+h)^2}{2} \right]$$

$$= \frac{\omega b}{h} \left[\frac{a^3 + 3a^2h + 3ah^2 + h^3 - a^3}{3} + \frac{a^3 - (a^3 + 2a^2h + ah^2)}{2} \right] = \frac{\omega b}{6h} [2(3a^2h + 3ah^2 + h^3) - 3(2a^2h + ah^2)]$$

$$= \frac{\omega b}{6h} (6a^2h + 6ah^2 + 2h^3 - 6a^2h - 3ah^2) = \frac{\omega b}{6h} (3ah^2 + 2h^3) = \frac{\omega b h}{6} (3a + 2h).$$
 Thus, $\bar{y} = \frac{F_x}{F}$

$$= \frac{\left(\frac{-\omega b h}{12} \right) (6a^2 + 8ah + 3h^2)}{\left(\frac{\omega b h}{6} \right) (3a + 2h)} = \left(\frac{-1}{2} \right) \left(\frac{6a^2 + 8ah + 3h^2}{3a + 2h} \right) \Rightarrow \text{the distance below the surface is}$$

$$\frac{6a^2 + 8ah + 3h^2}{6a + 4h}.$$

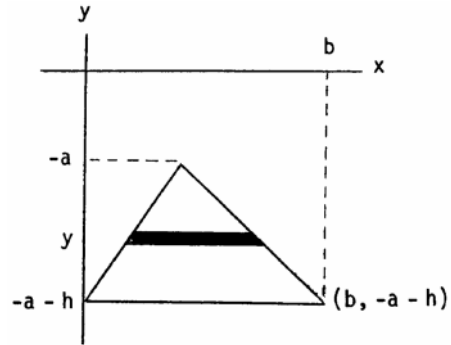

CHAPTER 7 TRANSCENDENTAL FUNCTIONS

7.1 INVERSE FUNCTIONS AND THEIR DERIVATIVES

1. Yes one-to-one, the graph passes the horizontal test.
2. Not one-to-one, the graph fails the horizontal test.
3. Not one-to-one since (for example) the horizontal line $y = 2$ intersects the graph twice.
4. Not one-to-one, the graph fails the horizontal test.
5. Yes one-to-one, the graph passes the horizontal test
6. Yes one-to-one, the graph passes the horizontal test

7. Domain: $0 < x \leq 1$, Range: $0 \leq y$

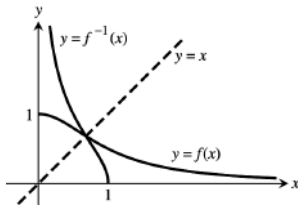

8. Domain: $x < 1$, Range: $y > 0$

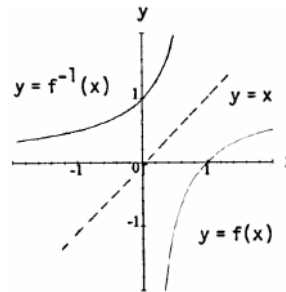

9. Domain: $-1 \leq x \leq 1$, Range: $-\frac{\pi}{2} \leq y \leq \frac{\pi}{2}$

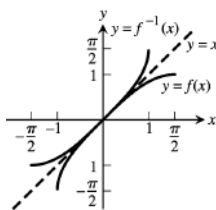

10. Domain: $-\infty < x < \infty$, Range: $-\frac{\pi}{2} < y \leq \frac{\pi}{2}$

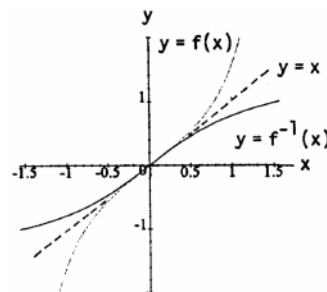

11. The graph is symmetric about $y = x$.

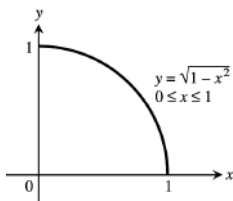

$$(b) \ y = \sqrt{1-x^2} \Rightarrow y^2 = 1-x^2 \Rightarrow x^2 = 1-y^2 \Rightarrow x = \sqrt{1-y^2} \Rightarrow y = \sqrt{1-x^2} = f^{-1}(x)$$

12. The graph is symmetric about $y = x$.

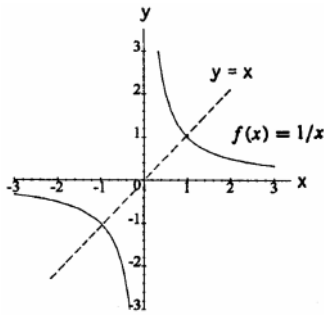

$$y = \frac{1}{x} \Rightarrow x = \frac{1}{y} \Rightarrow y = \frac{1}{x} = f^{-1}(x)$$

13. Step 1: $y = x^2 + 1 \Rightarrow x^2 = y - 1 \Rightarrow x = \sqrt{y - 1}$

Step 2: $y = \sqrt{x - 1} = f^{-1}(x)$

14. Step 1: $y = x^2 \Rightarrow x = -\sqrt{y}$, since $x \leq 0$.

Step 2: $y = -\sqrt{x} = f^{-1}(x)$

15. Step 1: $y = x^3 - 1 \Rightarrow x^3 = y + 1 \Rightarrow x = (y + 1)^{1/3}$

Step 2: $y = \sqrt[3]{x + 1} = f^{-1}(x)$

16. Step 1: $y = x^2 - 2x + 1 \Rightarrow y = (x - 1)^2 \Rightarrow \sqrt{y} = x - 1$, since $x \geq 1 \Rightarrow x = 1 + \sqrt{y}$

Step 2: $y = 1 + \sqrt{x} = f^{-1}(x)$

17. Step 1: $y = (x + 1)^2 \Rightarrow \sqrt{y} = x + 1$, since $x \geq -1 \Rightarrow x = \sqrt{y} - 1$

Step 2: $y = \sqrt{x} - 1 = f^{-1}(x)$

18. Step 1: $y = x^{2/3} \Rightarrow x = y^{3/2}$

Step 2: $y = x^{3/2} = f^{-1}(x)$

19. Step 1: $y = x^5 \Rightarrow x = y^{1/5}$

Step 2: $y = \sqrt[5]{x} = f^{-1}(x)$;

Domain and Range of f^{-1} : all reals;

$$f(f^{-1}(x)) = (x^{1/5})^5 = x \text{ and } f^{-1}(f(x)) = (x^5)^{1/5} = x$$

20. Step 1: $y = x^4 \Rightarrow x = y^{1/4}$

Step 2: $y = \sqrt[4]{x} = f^{-1}(x)$;

Domain of f^{-1} : $x \geq 0$, Range of f^{-1} : $y \geq 0$;

$$f(f^{-1}(x)) = (x^{1/4})^4 = x \text{ and } f^{-1}(f(x)) = (x^4)^{1/4} = x$$

21. Step 1: $y = x^3 + 1 \Rightarrow x^3 = y - 1 \Rightarrow x = (y - 1)^{1/3}$

Step 2: $y = \sqrt[3]{x - 1} = f^{-1}(x)$;

Domain and Range of f^{-1} : all reals;

$$f(f^{-1}(x)) = ((x - 1)^{1/3})^3 + 1 = (x - 1) + 1 = x \text{ and } f^{-1}(f(x)) = ((x^3 + 1) - 1)^{1/3} = (x^3)^{1/3} = x$$

22. Step 1: $y = \frac{1}{2}x - \frac{7}{2} \Rightarrow \frac{1}{2}x = y + \frac{7}{2} \Rightarrow x = 2y + 7$

Step 2: $y = 2x + 7 = f^{-1}(x)$;

Domain and Range of f^{-1} : all reals;

$f(f^{-1}(x)) = \frac{1}{2}(2x + 7) - \frac{7}{2} = (x + \frac{7}{2}) - \frac{7}{2} = x$ and $f^{-1}(f(x)) = 2(\frac{1}{2}x - \frac{7}{2}) + 7 = (x - 7) + 7 = x$

23. Step 1: $y = \frac{1}{x^2} \Rightarrow x^2 = \frac{1}{y} \Rightarrow x = \frac{1}{\sqrt{y}}$

Step 2: $y = \frac{1}{\sqrt{x}} = f^{-1}(x)$

Domain of f^{-1} : $x > 0$, Range of f^{-1} : $y > 0$;

$f(f^{-1}(x)) = \frac{1}{(\frac{1}{\sqrt{x}})^2} = \frac{1}{(\frac{1}{x})} = x$ and $f^{-1}(f(x)) = \frac{1}{\sqrt{\frac{1}{x^2}}} = \frac{1}{(\frac{1}{x})} = x$ since $x > 0$

24. Step 1: $y = \frac{1}{x^3} \Rightarrow x^3 = \frac{1}{y} \Rightarrow x = \frac{1}{y^{1/3}}$

Step 2: $y = \frac{1}{x^{1/3}} = \sqrt[3]{\frac{1}{x}} = f^{-1}(x)$;

Domain of f^{-1} : $x \neq 0$, Range of f^{-1} : $y \neq 0$;

$f(f^{-1}(x)) = \frac{1}{(x^{-1/3})^3} = \frac{1}{x^{-1}} = x$ and $f^{-1}(f(x)) = (\frac{1}{x^3})^{-1/3} = (\frac{1}{x})^{-1} = x$

25. (a) $y = 2x + 3 \Rightarrow 2x = y - 3$

$\Rightarrow x = \frac{y}{2} - \frac{3}{2} \Rightarrow f^{-1}(x) = \frac{x}{2} - \frac{3}{2}$

(c) $\frac{df}{dx}\bigg|_{x=-1} = 2$, $\frac{df^{-1}}{dx}\bigg|_{x=1} = \frac{1}{2}$

(b)

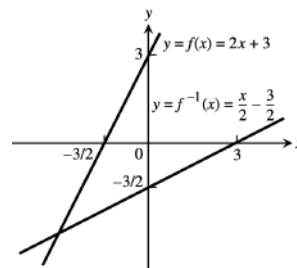

26. (a) $y = \frac{1}{5}x + 7 \Rightarrow \frac{1}{5}x = y - 7$

$\Rightarrow x = 5y - 35 \Rightarrow f^{-1}(x) = 5x - 35$

(c) $\frac{df}{dx}\bigg|_{x=-1} = \frac{1}{5}$, $\frac{df^{-1}}{dx}\bigg|_{x=34/5} = 5$

(b)

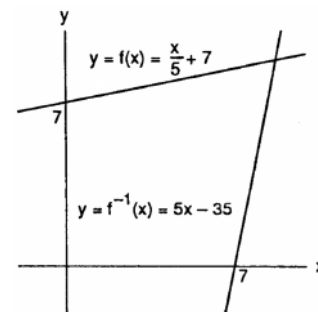

27. (a) $y = 5 - 4x \Rightarrow 4x = 5 - y$

$\Rightarrow x = \frac{5}{4} - \frac{y}{4} \Rightarrow f^{-1}(x) = \frac{5}{4} - \frac{x}{4}$

(c) $\frac{df}{dx}\bigg|_{x=1/2} = -4$, $\frac{df^{-1}}{dx}\bigg|_{x=3} = -\frac{1}{4}$

(b)

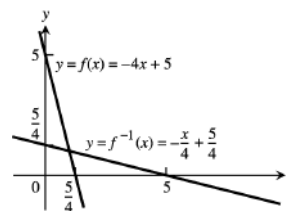

28. (a) $y = 2x^2 \Rightarrow x^2 = \frac{1}{2}y$
 $\Rightarrow x = \frac{1}{\sqrt{2}}\sqrt{y} \Rightarrow f^{-1}(x) = \sqrt{\frac{x}{2}}$
 (c) $\frac{df}{dx}\Big|_{x=5} = 4x\Big|_{x=5} = 20,$
 $\frac{df^{-1}}{dx}\Big|_{x=50} = \frac{1}{2\sqrt{2}}x^{-1/2}\Big|_{x=50} = \frac{1}{20}$

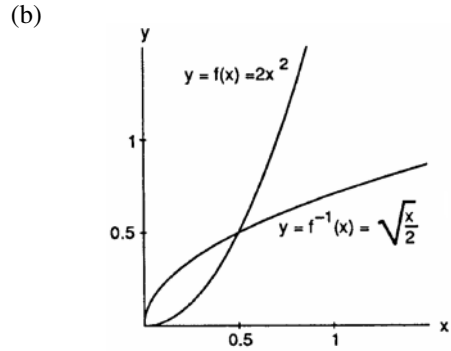

29. (a) $f(g(x)) = (\sqrt[3]{x})^3 = x, g(f(x)) = \sqrt[3]{x^3} = x$
 (c) $f'(x) = 3x^2 \Rightarrow f'(1) = 3, f'(-1) = 3;$
 $g'(x) = \frac{1}{3}x^{-2/3} \Rightarrow g'(1) = \frac{1}{3}, g'(-1) = \frac{1}{3}$
 (d) The line $y = 0$ is tangent to $f(x) = x^3$ at $(0, 0);$
 the line $x = 0$ is tangent to $g(x) = \sqrt[3]{x}$ at $(0, 0)$

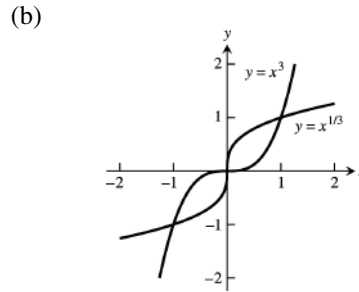

30. (a) $h(k(x)) = \frac{1}{4}((4x)^{1/3})^3 = x,$
 $k(h(x)) = \left(4 \cdot \frac{x^3}{4}\right)^{1/3} = x$
 (c) $h'(x) = \frac{3x^2}{4} \Rightarrow h'(2) = 3, h'(-2) = 3;$
 $k'(x) = \frac{4}{3}(4x)^{-2/3} \Rightarrow k'(2) = \frac{1}{3}, k'(-2) = \frac{1}{3}$
 (d) The line $y = 0$ is tangent to $h(x) = \frac{x^3}{4}$ at $(0, 0);$
 the line $x = 0$ is tangent to $k(x) = (4x)^{1/3}$ at $(0, 0)$

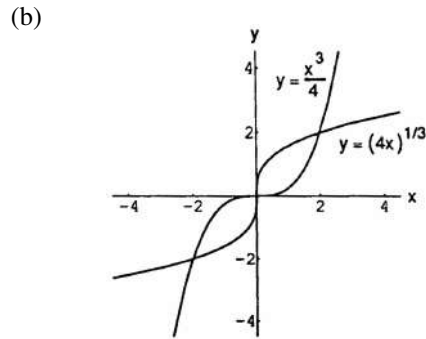

31. $\frac{df}{dx} = 3x^2 - 6x \Rightarrow \frac{df^{-1}}{dx}\Big|_{x=f(3)} = \frac{1}{\frac{df}{dx}}\Big|_{x=3} = \frac{1}{9}$

32. $\frac{df}{dx} = 2x - 4 \Rightarrow \frac{df^{-1}}{dx}\Big|_{x=f(5)} = \frac{1}{\frac{df}{dx}}\Big|_{x=5} = \frac{1}{6}$

33. $\frac{df^{-1}}{dx}\Big|_{x=4} = \frac{df^{-1}}{dx}\Big|_{x=f(2)} = \frac{1}{\frac{df}{dx}}\Big|_{x=2} = \frac{1}{\left(\frac{1}{3}\right)} = 3$

34. $\frac{dg^{-1}}{dx}\Big|_{x=0} = \frac{dg^{-1}}{dx}\Big|_{x=f(0)} = \frac{1}{\frac{dg}{dx}}\Big|_{x=0} = \frac{1}{2}$

35. (a) $y = mx \Rightarrow x = \frac{1}{m}y \Rightarrow f^{-1}(x) = \frac{1}{m}x$
 (b) The graph of $y = f^{-1}(x)$ is a line through the origin with slope $\frac{1}{m}.$

36. $y = mx + b \Rightarrow x = \frac{y}{m} - \frac{b}{m} \Rightarrow f^{-1}(x) = \frac{1}{m}x - \frac{b}{m};$ the graph of $f^{-1}(x)$ is a line with slope $\frac{1}{m}$ and y-intercept $-\frac{b}{m}.$

37. (a) $y = x + 1 \Rightarrow x = y - 1 \Rightarrow f^{-1}(x) = x - 1$
 (b) $y = x + b \Rightarrow x = y - b \Rightarrow f^{-1}(x) = x - b$
 (c) Their graphs will be parallel to one another and lie on opposite sides of the line $y = x$ equidistant from that line.

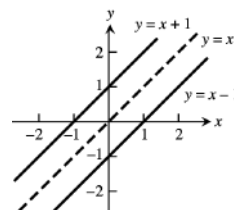

38. (a) $y = -x + 1 \Rightarrow x = -y + 1 \Rightarrow f^{-1}(x) = 1 - x$;
the lines intersect at a right angle
(b) $y = -x + b \Rightarrow x = -y + b \Rightarrow f^{-1}(x) = b - x$;
the lines intersect at a right angle
(c) Such a function is its own inverse.

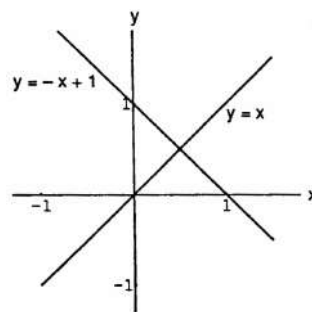

39. Let $x_1 \neq x_2$ be two numbers in the domain of an increasing function f . Then, either $x_1 < x_2$ or $x_1 > x_2$ which implies $f(x_1) < f(x_2)$ or $f(x_1) > f(x_2)$, since $f(x)$ is increasing. In either case, $f(x_1) \neq f(x_2)$ and f is one-to-one. Similar arguments hold if f is decreasing.
40. $f(x)$ is increasing since $x_2 > x_1 \Rightarrow \frac{1}{3}x_2 + \frac{5}{6} > \frac{1}{3}x_1 + \frac{5}{6}$; $\frac{df}{dx} = \frac{1}{3} \Rightarrow \frac{df^{-1}}{dx} = \frac{1}{(\frac{1}{3})} = 3$
41. $f(x)$ is increasing since $x_2 > x_1 \Rightarrow 27x_2^3 > 27x_1^3$; $y = 27x^3 \Rightarrow x = \frac{1}{3}y^{1/3} \Rightarrow f^{-1}(x) = \frac{1}{3}x^{1/3}$;
 $\frac{df}{dx} = 81x^2 \Rightarrow \frac{df^{-1}}{dx} = \frac{1}{81x^2} \Big|_{\frac{1}{3}x^{1/3}} = \frac{1}{9x^{2/3}} = \frac{1}{9}x^{-2/3}$
42. $f(x)$ is decreasing since $x_2 > x_1 \Rightarrow 1 - 8x_2^3 < 1 - 8x_1^3$; $y = 1 - 8x^3 \Rightarrow x = \frac{1}{2}(1 - y)^{1/3} \Rightarrow f^{-1}(x) = \frac{1}{2}(1 - x)^{1/3}$;
 $\frac{df}{dx} = -24x^2 \Rightarrow \frac{df^{-1}}{dx} = \frac{1}{-24x^2} \Big|_{\frac{1}{2}(1-x)^{1/3}} = \frac{-1}{6(1-x)^{2/3}} = -\frac{1}{6}(1-x)^{-2/3}$
43. $f(x)$ is decreasing since $x_2 > x_1 \Rightarrow (1 - x_2)^3 < (1 - x_1)^3$; $y = (1 - x)^3 \Rightarrow x = 1 - y^{1/3} \Rightarrow f^{-1}(x) = 1 - x^{1/3}$;
 $\frac{df}{dx} = -3(1 - x)^2 \Rightarrow \frac{df^{-1}}{dx} = \frac{1}{-3(1-x)^2} \Big|_{1-x^{1/3}} = \frac{-1}{3x^{2/3}} = -\frac{1}{3}x^{-2/3}$
44. $f(x)$ is increasing since $x_2 > x_1 \Rightarrow x_2^{5/3} > x_1^{5/3}$; $y = x^{5/3} \Rightarrow x = y^{3/5} \Rightarrow f^{-1}(x) = x^{3/5}$;
 $\frac{df}{dx} = \frac{5}{3}x^{2/3} \Rightarrow \frac{df^{-1}}{dx} = \frac{1}{\frac{5}{3}x^{2/3}} \Big|_{x^{3/5}} = \frac{3}{5x^{2/5}} = \frac{3}{5}x^{-2/5}$
45. The function $g(x)$ is also one-to-one. The reasoning: $f(x)$ is one-to-one means that if $x_1 \neq x_2$ then $f(x_1) \neq f(x_2)$, so $-f(x_1) \neq -f(x_2)$ and therefore $g(x_1) \neq g(x_2)$. Therefore $g(x)$ is one-to-one as well.
46. The function $h(x)$ is also one-to-one. The reasoning: $f(x)$ is one-to-one means that if $x_1 \neq x_2$ then $f(x_1) \neq f(x_2)$, so $\frac{1}{f(x_1)} \neq \frac{1}{f(x_2)}$, and therefore $h(x_1) \neq h(x_2)$.
47. The composite is one-to-one also. The reasoning: If $x_1 \neq x_2$ then $g(x_1) \neq g(x_2)$ because g is one-to-one. Since $g(x_1) \neq g(x_2)$, we also have $f(g(x_1)) \neq f(g(x_2))$ because f is one-to-one. Thus, $f \circ g$ is one-to-one because $x_1 \neq x_2 \Rightarrow f(g(x_1)) \neq f(g(x_2))$.
48. Yes, g must be one-to-one. If g were not one-to-one, there would exist numbers $x_1 \neq x_2$ in the domain of g with $g(x_1) = g(x_2)$. For these numbers we would also have $f(g(x_1)) = f(g(x_2))$, contradicting the assumption that $f \circ g$ is one-to-one.

49. The first integral is the area between $f(x)$ and the x -axis over $a \leq x \leq b$. The second integral is the area between $f(x)$ and the y -axis for $f(a) \leq y \leq f(b)$. The sum of the integrals is the area of the larger rectangle with corners at $(0, 0)$, $(b, 0)$, $(b, f(b))$ and $(0, f(b))$ minus the area of the smaller rectangle with vertices at $(0, 0)$, $(a, 0)$, $(a, f(a))$ and $(0, f(a))$. That is, the sum of the integrals is $bf(b) - af(a)$.

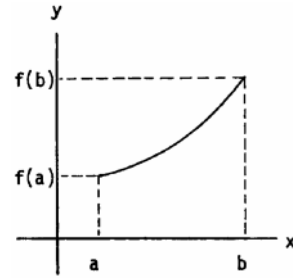

50. $f'(x) = \frac{(cx+d)a - (ax+b)c}{(cx+d)^2} = \frac{ad-bc}{(cx+d)^2}$. Thus if $ad - bc \neq 0$, $f'(x)$ is either always positive or always negative. Hence $f(x)$ is either always increasing or always decreasing. It follows that $f(x)$ is one-to-one if $ad - bc \neq 0$.

51. $(g \circ f)(x) = x \Rightarrow g(f(x)) = x \Rightarrow g'(f(x))f'(x) = 1$

52. $W(a) = \int_{f(a)}^{f(b)} \pi \left[(f^{-1}(y))^2 - a^2 \right] dy = 0 = \int_a^b 2\pi x [f(a) - f(x)] dx = S(a)$; $W'(t) = \pi \left[(f^{-1}(f(t)))^2 - a^2 \right] f'(t)$
 $= \pi (t^2 - a^2) f'(t)$; also $S(t) = 2\pi f(t) \int_a^t x dx - 2\pi \int_a^t x f(x) dx = [\pi f(t)t^2 - \pi f(t)a^2] - 2\pi \int_a^t x f(x) dx$
 $\Rightarrow S'(t) = \pi t^2 f'(t) + 2\pi t f(t) - \pi a^2 f'(t) - 2\pi t f(t) = \pi (t^2 - a^2) f'(t) \Rightarrow W'(t) = S'(t)$. Therefore, $W(t) = S(t)$ for all $t \in [a, b]$.

53-60. Example CAS commands:

Maple:

```
with(plots);#53
f := x -> sqrt(3*x-2);
domain := 2/3 .. 4;
x0 := 3;
Df := D(f); # (a)
plot( [f(x),Df(x)], x=domain, color=[red,blue], linestyle=[1,3], legend=["y=f(x)", "y=f'(x)"],
      title="#53(a) (Section 7.1)");
q1 := solve( y=f(x), x); # (b)
g := unapply( q1, y );
m1 := Df(x0); # (c)
t1 := f(x0)+m1*(x-x0);
y=t1;
m2 := 1/Df(x0); # (d)
t2 := g(f(x0)) + m2*(x-f(x0));
y=t2;
domaing := map(f,domain); # (e)
p1 := plot( [f(x),x], x=domain, color=[pink,green], linestyle=[1,9], thickness=[3,0] );
p2 := plot( g(x), x=domaing, color=cyan, linestyle=3, thickness=4 );
p3 := plot( t1, x=x0-1..x0+1, color=red, linestyle=4, thickness=0 );
p4 := plot( t2, x=f(x0)-1..f(x0)+1, color=blue, linestyle=7, thickness=1 );
p5 := plot( [ [x0,f(x0)], [f(x0),x0] ], color=green );
display( [p1,p2,p3,p4,p5], scaling=constrained, title="#53(e) (Section 7.1)");
```

Mathematica: (assigned function and values for a , b , and x_0 may vary)

If a function requires the odd root of a negative number, begin by loading the RealOnly package that allows Mathematica to do this. See section 2.5 for details.

```
<<Miscellaneous`RealOnly`
Clear[x, y]
```

```

{a,b} = {-2, 1}; x0 = 1/2 ;
f[x_] = (3x + 2) / (2x - 11)
Plot[{f[x], f'[x]}, {x, a, b}]
solx = Solve[y == f[x], x]
g[y_] = x /. solx[[1]]
y0 = f[x0]
ftan[x_] = y0 + f'[x0] (x-x0)
gtan[y_] = x0 + 1/f'[x0] (y - y0)
Plot[{f[x], ftan[x], g[x], gtan[x], Identity[x]}, {x, a, b},
Epilog -> Line[{x0, y0}, {y0, x0}], PlotRange -> {{a,b},{a,b}}, AspectRatio -> Automatic]

```

61-62. Example CAS commands:

Maple:

```

with( plots );
eq := cos(y) = x^(1/5);
domain := 0 .. 1;
x0 := 1/2;
f := unapply( solve( eq, y ), x ); # (a)
Df := D(f);
plot( [f(x),Df(x)], x=domain, color=[red,blue], linestyle=[1,3], legend=["y=f(x)","y=f'(x)"],
title="#62(a) (Section 7.1)" );
q1 := solve( eq, x ); # (b)
g := unapply( q1, y );
m1 := Df(x0); # (c)
t1 := f(x0)+m1*(x-x0);
y=t1;
m2 := 1/Df(x0); # (d)
t2 := g(f(x0)) + m2*(x-f(x0));
y=t2;
domaing := map(f,domain); # (e)
p1 := plot( [f(x),x], x=domain, color=[pink,green], linestyle=[1,9], thickness=[3,0] );
p2 := plot( g(x), x=domaing, color=cyan, linestyle=3, thickness=4 );
p3 := plot( t1, x=x0-1..x0+1, color=red, linestyle=4, thickness=0 );
p4 := plot( t2, x=f(x0)-1..f(x0)+1, color=blue, linestyle=7, thickness=1 );
p5 := plot( [ [x0,f(x0)], [f(x0),x0] ], color=green );
display( [p1,p2,p3,p4,p5], scaling=constrained, title="#62(e) (Section 7.1)" );

```

Mathematica: (assigned function and values for a, b, and x0 may vary)

For problems 61 and 62, the code is just slightly altered. At times, different "parts" of solutions need to be used, as in the definitions of f[x] and g[y]

```

Clear[x, y]
{a,b} = {0, 1}; x0 = 1/2 ;
eqn = Cos[y] == x1/5
soly = Solve[eqn, y]
f[x_] = y /. soly[[2]]
Plot[{f[x], f'[x]}, {x, a, b}]
solx = Solve[eqn, x]
g[y_] = x /. solx[[1]]
y0 = f[x0]
ftan[x_] = y0 + f'[x0] (x - x0)

```

$$\text{gtan}[y_] = x0 + 1/f[x0] (y - y0)$$

$$\text{Plot}[\{f[x], \text{ftan}[x], g[x], \text{gtan}[x], \text{Identity}[x]\}, \{x, a, b\},$$

$$\text{Epilog} \rightarrow \text{Line}[\{\{x0, y0\}, \{y0, x0\}\}], \text{PlotRange} \rightarrow \{\{a, b\}, \{a, b\}\}, \text{AspectRatio} \rightarrow \text{Automatic}]$$

7.2 NATURAL LOGARITHMS

1. (a) $\ln 0.75 = \ln \frac{3}{4} = \ln 3 - \ln 4 = \ln 3 - \ln 2^2 = \ln 3 - 2 \ln 2$
 (b) $\ln \frac{4}{9} = \ln 4 - \ln 9 = \ln 2^2 - \ln 3^2 = 2 \ln 2 - 2 \ln 3$
 (c) $\ln \frac{1}{2} = \ln 1 - \ln 2 = -\ln 2$ (d) $\ln \sqrt[3]{9} = \frac{1}{3} \ln 9 = \frac{1}{3} \ln 3^2 = \frac{2}{3} \ln 3$
 (e) $\ln 3\sqrt{2} = \ln 3 + \ln 2^{1/2} = \ln 3 + \frac{1}{2} \ln 2$
 (f) $\ln \sqrt{13.5} = \frac{1}{2} \ln 13.5 = \frac{1}{2} \ln \frac{27}{2} = \frac{1}{2} (\ln 3^3 - \ln 2) = \frac{1}{2} (3 \ln 3 - \ln 2)$
2. (a) $\ln \frac{1}{125} = \ln 1 - 3 \ln 5 = -3 \ln 5$ (b) $\ln 9.8 = \ln \frac{49}{5} = \ln 7^2 - \ln 5 = 2 \ln 7 - \ln 5$
 (c) $\ln 7\sqrt{7} = \ln 7^{3/2} = \frac{3}{2} \ln 7$ (d) $\ln 1225 = \ln 35^2 = 2 \ln 35 = 2 \ln 5 + 2 \ln 7$
 (e) $\ln 0.056 = \ln \frac{7}{125} = \ln 7 - \ln 5^3 = \ln 7 - 3 \ln 5$
 (f) $\frac{\ln 35 + \ln \frac{1}{2}}{\ln 25} = \frac{\ln 5 + \ln 7 - \ln 2}{2 \ln 5} = \frac{1}{2}$
3. (a) $\ln \sin \theta - \ln \left(\frac{\sin \theta}{5}\right) = \ln \left(\frac{\sin \theta}{\frac{\sin \theta}{5}}\right) = \ln 5$ (b) $\ln (3x^2 - 9x) + \ln \left(\frac{1}{3x}\right) = \ln \left(\frac{3x^2 - 9x}{3x}\right) = \ln (x - 3)$
 (c) $\frac{1}{2} \ln (4t^4) - \ln 2 = \ln \sqrt{4t^4} - \ln 2 = \ln 2t^2 - \ln 2 = \ln \left(\frac{2t^2}{2}\right) = \ln (t^2)$
4. (a) $\ln \sec \theta + \ln \cos \theta = \ln [(\sec \theta)(\cos \theta)] = \ln 1 = 0$
 (b) $\ln (8x + 4) - \ln 2^2 = \ln (8x + 4) - \ln 4 = \ln \left(\frac{8x+4}{4}\right) = \ln (2x + 1)$
 (c) $3 \ln \sqrt[3]{t^2 - 1} - \ln (t + 1) = 3 \ln (t^2 - 1)^{1/3} - \ln (t + 1) = 3 \left(\frac{1}{3}\right) \ln (t^2 - 1) - \ln (t + 1) = \ln \left(\frac{(t+1)(t-1)}{(t+1)}\right) = \ln (t - 1)$
5. $y = \ln 3x \Rightarrow y' = \left(\frac{1}{3x}\right) (3) = \frac{1}{x}$ 6. $y = \ln kx \Rightarrow y' = \left(\frac{1}{kx}\right) (k) = \frac{1}{x}$
7. $y = \ln (t^2) \Rightarrow \frac{dy}{dt} = \left(\frac{1}{t^2}\right) (2t) = \frac{2}{t}$ 8. $y = \ln (t^{3/2}) \Rightarrow \frac{dy}{dt} = \left(\frac{1}{t^{3/2}}\right) \left(\frac{3}{2} t^{1/2}\right) = \frac{3}{2t}$
9. $y = \ln \frac{3}{x} = \ln 3x^{-1} \Rightarrow \frac{dy}{dx} = \left(\frac{1}{3x^{-1}}\right) (-3x^{-2}) = -\frac{1}{x}$
10. $y = \ln \frac{10}{x} = \ln 10x^{-1} \Rightarrow \frac{dy}{dx} = \left(\frac{1}{10x^{-1}}\right) (-10x^{-2}) = -\frac{1}{x}$
11. $y = \ln (\theta + 1) \Rightarrow \frac{dy}{d\theta} = \left(\frac{1}{\theta+1}\right) (1) = \frac{1}{\theta+1}$ 12. $y = \ln (2\theta + 2) \Rightarrow \frac{dy}{d\theta} = \left(\frac{1}{2\theta+2}\right) (2) = \frac{1}{\theta+1}$
13. $y = \ln x^3 \Rightarrow \frac{dy}{dx} = \left(\frac{1}{x^3}\right) (3x^2) = \frac{3}{x}$ 14. $y = (\ln x)^3 \Rightarrow \frac{dy}{dx} = 3(\ln x)^2 \cdot \frac{d}{dx} (\ln x) = \frac{3(\ln x)^2}{x}$
15. $y = t(\ln t)^2 \Rightarrow \frac{dy}{dt} = (\ln t)^2 + 2t(\ln t) \cdot \frac{d}{dt} (\ln t) = (\ln t)^2 + \frac{2t \ln t}{t} = (\ln t)^2 + 2 \ln t$
16. $y = t\sqrt{\ln t} = t(\ln t)^{1/2} \Rightarrow \frac{dy}{dt} = (\ln t)^{1/2} + \frac{1}{2} t(\ln t)^{-1/2} \cdot \frac{d}{dt} (\ln t) = (\ln t)^{1/2} + \frac{t(\ln t)^{-1/2}}{2t} = (\ln t)^{1/2} + \frac{1}{2(\ln t)^{1/2}}$
17. $y = \frac{x^4}{4} \ln x - \frac{x^4}{16} \Rightarrow \frac{dy}{dx} = x^3 \ln x + \frac{x^4}{4} \cdot \frac{1}{x} - \frac{4x^3}{16} = x^3 \ln x$

$$18. y = \frac{x^3}{3} \ln x - \frac{x^3}{9} \Rightarrow \frac{dy}{dx} = x^2 \ln x + \frac{x^3}{3} \cdot \frac{1}{x} - \frac{3x^2}{9} = x^2 \ln x$$

$$19. y = \frac{\ln t}{t} \Rightarrow \frac{dy}{dt} = \frac{t \left(\frac{1}{t}\right) - (\ln t)(1)}{t^2} = \frac{1 - \ln t}{t^2}$$

$$20. y = \frac{1 + \ln t}{t} \Rightarrow \frac{dy}{dt} = \frac{t \left(\frac{1}{t}\right) - (1 + \ln t)(1)}{t^2} = \frac{1 - 1 - \ln t}{t^2} = -\frac{\ln t}{t^2}$$

$$21. y = \frac{\ln x}{1 + \ln x} \Rightarrow y' = \frac{(1 + \ln x) \left(\frac{1}{x}\right) - (\ln x) \left(\frac{1}{x}\right)}{(1 + \ln x)^2} = \frac{\frac{1}{x} + \frac{\ln x}{x} - \frac{\ln x}{x}}{(1 + \ln x)^2} = \frac{1}{x(1 + \ln x)^2}$$

$$22. y = \frac{x \ln x}{1 + \ln x} \Rightarrow y' = \frac{(1 + \ln x) \left(\ln x + x \cdot \frac{1}{x}\right) - (x \ln x) \left(\frac{1}{x}\right)}{(1 + \ln x)^2} = \frac{(1 + \ln x)^2 - \ln x}{(1 + \ln x)^2} = 1 - \frac{\ln x}{(1 + \ln x)^2}$$

$$23. y = \ln(\ln x) \Rightarrow y' = \left(\frac{1}{\ln x}\right) \left(\frac{1}{x}\right) = \frac{1}{x \ln x}$$

$$24. y = \ln(\ln(\ln x)) \Rightarrow y' = \frac{1}{\ln(\ln x)} \cdot \frac{d}{dx}(\ln(\ln x)) = \frac{1}{\ln(\ln x)} \cdot \frac{1}{\ln x} \cdot \frac{d}{dx}(\ln x) = \frac{1}{x(\ln x) \ln(\ln x)}$$

$$25. y = \theta[\sin(\ln \theta) + \cos(\ln \theta)] \Rightarrow \frac{dy}{d\theta} = [\sin(\ln \theta) + \cos(\ln \theta)] + \theta \left[\cos(\ln \theta) \cdot \frac{1}{\theta} - \sin(\ln \theta) \cdot \frac{1}{\theta}\right] \\ = \sin(\ln \theta) + \cos(\ln \theta) + \cos(\ln \theta) - \sin(\ln \theta) = 2 \cos(\ln \theta)$$

$$26. y = \ln(\sec \theta + \tan \theta) \Rightarrow \frac{dy}{d\theta} = \frac{\sec \theta \tan \theta + \sec^2 \theta}{\sec \theta + \tan \theta} = \frac{\sec \theta(\tan \theta + \sec \theta)}{\tan \theta + \sec \theta} = \sec \theta$$

$$27. y = \ln \frac{1}{x\sqrt{x+1}} = -\ln x - \frac{1}{2} \ln(x+1) \Rightarrow y' = -\frac{1}{x} - \frac{1}{2} \left(\frac{1}{x+1}\right) = -\frac{2(x+1)+x}{2x(x+1)} = -\frac{3x+2}{2x(x+1)}$$

$$28. y = \frac{1}{2} \ln \frac{1+x}{1-x} = \frac{1}{2} [\ln(1+x) - \ln(1-x)] \Rightarrow y' = \frac{1}{2} \left[\frac{1}{1+x} - \left(\frac{1}{1-x}\right)(-1)\right] = \frac{1}{2} \left[\frac{1-x+1+x}{(1+x)(1-x)}\right] = \frac{1}{1-x^2}$$

$$29. y = \frac{1 + \ln t}{1 - \ln t} \Rightarrow \frac{dy}{dt} = \frac{(1 - \ln t) \left(\frac{1}{t}\right) - (1 + \ln t) \left(\frac{-1}{t}\right)}{(1 - \ln t)^2} = \frac{\frac{1}{t} - \frac{\ln t}{t} + \frac{1}{t} + \frac{\ln t}{t}}{(1 - \ln t)^2} = \frac{2}{t(1 - \ln t)^2}$$

$$30. y = \sqrt{\ln \sqrt{t}} = (\ln t^{1/2})^{1/2} \Rightarrow \frac{dy}{dt} = \frac{1}{2} (\ln t^{1/2})^{-1/2} \cdot \frac{d}{dt}(\ln t^{1/2}) = \frac{1}{2} (\ln t^{1/2})^{-1/2} \cdot \frac{1}{t^{1/2}} \cdot \frac{d}{dt}(t^{1/2}) \\ = \frac{1}{2} (\ln t^{1/2})^{-1/2} \cdot \frac{1}{t^{1/2}} \cdot \frac{1}{2} t^{-1/2} = \frac{1}{4t\sqrt{\ln \sqrt{t}}}$$

$$31. y = \ln(\sec(\ln \theta)) \Rightarrow \frac{dy}{d\theta} = \frac{1}{\sec(\ln \theta)} \cdot \frac{d}{d\theta}(\sec(\ln \theta)) = \frac{\sec(\ln \theta) \tan(\ln \theta)}{\sec(\ln \theta)} \cdot \frac{d}{d\theta}(\ln \theta) = \frac{\tan(\ln \theta)}{\theta}$$

$$32. y = \ln \frac{\sqrt{\sin \theta \cos \theta}}{1 + 2 \ln \theta} = \frac{1}{2} (\ln \sin \theta + \ln \cos \theta) - \ln(1 + 2 \ln \theta) \Rightarrow \frac{dy}{d\theta} = \frac{1}{2} \left(\frac{\cos \theta}{\sin \theta} - \frac{\sin \theta}{\cos \theta}\right) - \frac{\frac{2}{\theta}}{1 + 2 \ln \theta} \\ = \frac{1}{2} \left[\cot \theta - \tan \theta - \frac{4}{\theta(1 + 2 \ln \theta)}\right]$$

$$33. y = \ln \left(\frac{(x^2+1)^5}{\sqrt{1-x}}\right) = 5 \ln(x^2+1) - \frac{1}{2} \ln(1-x) \Rightarrow y' = \frac{5 \cdot 2x}{x^2+1} - \frac{1}{2} \left(\frac{1}{1-x}\right)(-1) = \frac{10x}{x^2+1} + \frac{1}{2(1-x)}$$

$$34. y = \ln \sqrt{\frac{(x+1)^5}{(x+2)^{20}}} = \frac{1}{2} [5 \ln(x+1) - 20 \ln(x+2)] \Rightarrow y' = \frac{1}{2} \left(\frac{5}{x+1} - \frac{20}{x+2}\right) = \frac{5}{2} \left[\frac{(x+2) - 4(x+1)}{(x+1)(x+2)}\right] \\ = -\frac{5}{2} \left[\frac{3x+2}{(x+1)(x+2)}\right]$$

$$35. y = \int_{x^2/2}^{x^2} \ln \sqrt{t} dt \Rightarrow \frac{dy}{dx} = \left(\ln \sqrt{x^2}\right) \cdot \frac{d}{dx}(x^2) - \left(\ln \sqrt{\frac{x^2}{2}}\right) \cdot \frac{d}{dx}\left(\frac{x^2}{2}\right) = 2x \ln |x| - x \ln \frac{|x|}{\sqrt{2}}$$

$$36. y = \int_{\sqrt{x}}^{\sqrt[3]{x}} \ln t \, dt \Rightarrow \frac{dy}{dx} = (\ln \sqrt[3]{x}) \cdot \frac{d}{dx} (\sqrt[3]{x}) - (\ln \sqrt{x}) \cdot \frac{d}{dx} (\sqrt{x}) = (\ln \sqrt[3]{x}) \left(\frac{1}{3} x^{-2/3}\right) - (\ln \sqrt{x}) \left(\frac{1}{2} x^{-1/2}\right) \\ = \frac{\ln \sqrt[3]{x}}{3\sqrt[3]{x^2}} - \frac{\ln \sqrt{x}}{2\sqrt{x}}$$

$$37. \int_{-3}^{-2} \frac{1}{x} \, dx = [\ln |x|]_{-3}^{-2} = \ln 2 - \ln 3 = \ln \frac{2}{3} \qquad 38. \int_{-1}^0 \frac{3}{3x-2} \, dx = [\ln |3x-2|]_{-1}^0 = \ln 2 - \ln 5 = \ln \frac{2}{5}$$

$$39. \int \frac{2y}{y^2-25} \, dy = \ln |y^2-25| + C \qquad 40. \int \frac{8r}{4r^2-5} \, dr = \ln |4r^2-5| + C$$

$$41. \int_0^{\pi} \frac{\sin t}{2-\cos t} \, dt = [\ln |2-\cos t|]_0^{\pi} = \ln 3 - \ln 1 = \ln 3; \text{ or let } u = 2 - \cos t \Rightarrow du = \sin t \, dt \text{ with } t = 0 \\ \Rightarrow u = 1 \text{ and } t = \pi \Rightarrow u = 3 \Rightarrow \int_0^{\pi} \frac{\sin t}{2-\cos t} \, dt = \int_1^3 \frac{1}{u} \, du = [\ln |u|]_1^3 = \ln 3 - \ln 1 = \ln 3$$

$$42. \int_0^{\pi/3} \frac{4 \sin \theta}{1-4 \cos \theta} \, d\theta = [\ln |1-4 \cos \theta|]_0^{\pi/3} = \ln |1-2| = -\ln 3 = \ln \frac{1}{3}; \text{ or let } u = 1 - 4 \cos \theta \Rightarrow du = 4 \sin \theta \, d\theta \\ \text{with } \theta = 0 \Rightarrow u = -3 \text{ and } \theta = \frac{\pi}{3} \Rightarrow u = -1 \Rightarrow \int_0^{\pi/3} \frac{4 \sin \theta}{1-4 \cos \theta} \, d\theta = \int_{-3}^{-1} \frac{1}{u} \, du = [\ln |u|]_{-3}^{-1} = -\ln 3 = \ln \frac{1}{3}$$

$$43. \text{ Let } u = \ln x \Rightarrow du = \frac{1}{x} \, dx; x = 1 \Rightarrow u = 0 \text{ and } x = 2 \Rightarrow u = \ln 2; \\ \int_1^2 \frac{2 \ln x}{x} \, dx = \int_0^{\ln 2} 2u \, du = [u^2]_0^{\ln 2} = (\ln 2)^2$$

$$44. \text{ Let } u = \ln x \Rightarrow du = \frac{1}{x} \, dx; x = 2 \Rightarrow u = \ln 2 \text{ and } x = 4 \Rightarrow u = \ln 4; \\ \int_2^4 \frac{dx}{x \ln x} = \int_{\ln 2}^{\ln 4} \frac{1}{u} \, du = [\ln |u|]_{\ln 2}^{\ln 4} = \ln(\ln 4) - \ln(\ln 2) = \ln\left(\frac{\ln 4}{\ln 2}\right) = \ln\left(\frac{\ln 2^2}{\ln 2}\right) = \ln\left(\frac{2 \ln 2}{\ln 2}\right) = \ln 2$$

$$45. \text{ Let } u = \ln x \Rightarrow du = \frac{1}{x} \, dx; x = 2 \Rightarrow u = \ln 2 \text{ and } x = 4 \Rightarrow u = \ln 4; \\ \int_2^4 \frac{dx}{x(\ln x)^2} = \int_{\ln 2}^{\ln 4} u^{-2} \, du = \left[-\frac{1}{u}\right]_{\ln 2}^{\ln 4} = -\frac{1}{\ln 4} + \frac{1}{\ln 2} = -\frac{1}{2 \ln 2} + \frac{1}{\ln 2} = -\frac{1}{2 \ln 2} + \frac{1}{\ln 2} = \frac{1}{2 \ln 2} = \frac{1}{\ln 4}$$

$$46. \text{ Let } u = \ln x \Rightarrow du = \frac{1}{x} \, dx; x = 2 \Rightarrow u = \ln 2 \text{ and } x = 16 \Rightarrow u = \ln 16; \\ \int_2^{16} \frac{dx}{2x\sqrt{\ln x}} = \frac{1}{2} \int_{\ln 2}^{\ln 16} u^{-1/2} \, du = [u^{1/2}]_{\ln 2}^{\ln 16} = \sqrt{\ln 16} - \sqrt{\ln 2} = \sqrt{4 \ln 2} - \sqrt{\ln 2} = 2\sqrt{\ln 2} - \sqrt{\ln 2} = \sqrt{\ln 2}$$

$$47. \text{ Let } u = 6 + 3 \tan t \Rightarrow du = 3 \sec^2 t \, dt; \\ \int \frac{3 \sec^2 t}{6 + 3 \tan t} \, dt = \int \frac{du}{u} = \ln |u| + C = \ln |6 + 3 \tan t| + C$$

$$48. \text{ Let } u = 2 + \sec y \Rightarrow du = \sec y \tan y \, dy; \\ \int \frac{\sec y \tan y}{2 + \sec y} \, dy = \int \frac{du}{u} = \ln |u| + C = \ln |2 + \sec y| + C$$

$$49. \text{ Let } u = \cos \frac{x}{2} \Rightarrow du = -\frac{1}{2} \sin \frac{x}{2} \, dx \Rightarrow -2 \, du = \sin \frac{x}{2} \, dx; x = 0 \Rightarrow u = 1 \text{ and } x = \frac{\pi}{2} \Rightarrow u = \frac{1}{\sqrt{2}}; \\ \int_0^{\pi/2} \tan \frac{x}{2} \, dx = \int_0^{\pi/2} \frac{\sin \frac{x}{2}}{\cos \frac{x}{2}} \, dx = -2 \int_1^{1/\sqrt{2}} \frac{du}{u} = [-2 \ln |u|]_1^{1/\sqrt{2}} = -2 \ln \frac{1}{\sqrt{2}} = 2 \ln \sqrt{2} = \ln 2$$

$$50. \text{ Let } u = \sin t \Rightarrow du = \cos t \, dt; t = \frac{\pi}{4} \Rightarrow u = \frac{1}{\sqrt{2}} \text{ and } t = \frac{\pi}{2} \Rightarrow u = 1; \\ \int_{\pi/4}^{\pi/2} \cot t \, dt = \int_{\pi/4}^{\pi/2} \frac{\cos t}{\sin t} \, dt = \int_{1/\sqrt{2}}^1 \frac{du}{u} = [\ln |u|]_{1/\sqrt{2}}^1 = -\ln \frac{1}{\sqrt{2}} = \ln \sqrt{2}$$

$$51. \text{ Let } u = \sin \frac{\theta}{3} \Rightarrow du = \frac{1}{3} \cos \frac{\theta}{3} \, d\theta \Rightarrow 6 \, du = 2 \cos \frac{\theta}{3} \, d\theta; \theta = \frac{\pi}{2} \Rightarrow u = \frac{1}{2} \text{ and } \theta = \pi \Rightarrow u = \frac{\sqrt{3}}{2}; \\ \int_{\pi/2}^{\pi} 2 \cot \frac{\theta}{3} \, d\theta = \int_{\pi/2}^{\pi} \frac{2 \cos \frac{\theta}{3}}{\sin \frac{\theta}{3}} \, d\theta = 6 \int_{1/2}^{\sqrt{3}/2} \frac{du}{u} = 6 [\ln |u|]_{1/2}^{\sqrt{3}/2} = 6 \left(\ln \frac{\sqrt{3}}{2} - \ln \frac{1}{2}\right) = 6 \ln \sqrt{3} = \ln 27$$

$$52. \text{ Let } u = \cos 3x \Rightarrow du = -3 \sin 3x dx \Rightarrow -2 du = 6 \sin 3x dx; x = 0 \Rightarrow u = 1 \text{ and } x = \frac{\pi}{12} \Rightarrow u = \frac{1}{\sqrt{2}};$$

$$\int_0^{\pi/12} 6 \tan 3x dx = \int_0^{\pi/12} \frac{6 \sin 3x}{\cos 3x} dx = -2 \int_1^{1/\sqrt{2}} \frac{du}{u} = -2 [\ln |u|]_1^{1/\sqrt{2}} = -2 \ln \frac{1}{\sqrt{2}} - \ln 1 = 2 \ln \sqrt{2} = \ln 2$$

$$53. \int \frac{dx}{2\sqrt{x+2x}} = \int \frac{dx}{2\sqrt{x}(1+\sqrt{x})}; \text{ let } u = 1 + \sqrt{x} \Rightarrow du = \frac{1}{2\sqrt{x}} dx; \int \frac{dx}{2\sqrt{x}(1+\sqrt{x})} = \int \frac{du}{u} = \ln |u| + C \\ = \ln |1 + \sqrt{x}| + C = \ln (1 + \sqrt{x}) + C$$

$$54. \text{ Let } u = \sec x + \tan x \Rightarrow du = (\sec x \tan x + \sec^2 x) dx = (\sec x)(\tan x + \sec x) dx \Rightarrow \sec x dx = \frac{du}{u};$$

$$\int \frac{\sec x dx}{\sqrt{\ln(\sec x + \tan x)}} = \int \frac{du}{u\sqrt{\ln u}} = \int (\ln u)^{-1/2} \cdot \frac{1}{u} du = 2(\ln u)^{1/2} + C = 2\sqrt{\ln(\sec x + \tan x)} + C$$

$$55. y = \sqrt{x(x+1)} = (x(x+1))^{1/2} \Rightarrow \ln y = \frac{1}{2} \ln(x(x+1)) \Rightarrow 2 \ln y = \ln(x) + \ln(x+1) \Rightarrow \frac{2y'}{y} = \frac{1}{x} + \frac{1}{x+1}$$

$$\Rightarrow y' = \left(\frac{1}{2}\right) \sqrt{x(x+1)} \left(\frac{1}{x} + \frac{1}{x+1}\right) = \frac{\sqrt{x(x+1)}(2x+1)}{2x(x+1)} = \frac{2x+1}{2\sqrt{x(x+1)}}$$

$$56. y = \sqrt{(x^2+1)(x-1)^2} \Rightarrow \ln y = \frac{1}{2} [\ln(x^2+1) + 2 \ln(x-1)] \Rightarrow \frac{y'}{y} = \frac{1}{2} \left(\frac{2x}{x^2+1} + \frac{2}{x-1}\right)$$

$$\Rightarrow y' = \sqrt{(x^2+1)(x-1)^2} \left(\frac{x}{x^2+1} + \frac{1}{x-1}\right) = \sqrt{(x^2+1)(x-1)^2} \left[\frac{x^2-x+x^2+1}{(x^2+1)(x-1)}\right] = \frac{(2x^2-x+1)|x-1|}{\sqrt{x^2+1}(x-1)}$$

$$57. y = \sqrt{\frac{t}{t+1}} = \left(\frac{t}{t+1}\right)^{1/2} \Rightarrow \ln y = \frac{1}{2} [\ln t - \ln(t+1)] \Rightarrow \frac{1}{y} \frac{dy}{dt} = \frac{1}{2} \left(\frac{1}{t} - \frac{1}{t+1}\right)$$

$$\Rightarrow \frac{dy}{dt} = \frac{1}{2} \sqrt{\frac{t}{t+1}} \left(\frac{1}{t} - \frac{1}{t+1}\right) = \frac{1}{2} \sqrt{\frac{t}{t+1}} \left[\frac{1}{t(t+1)}\right] = \frac{1}{2\sqrt{t}(t+1)^{3/2}}$$

$$58. y = \sqrt{\frac{1}{t(t+1)}} = [t(t+1)]^{-1/2} \Rightarrow \ln y = \frac{1}{2} [\ln t + \ln(t+1)] \Rightarrow \frac{1}{y} \frac{dy}{dt} = -\frac{1}{2} \left(\frac{1}{t} + \frac{1}{t+1}\right)$$

$$\Rightarrow \frac{dy}{dt} = -\frac{1}{2} \sqrt{\frac{1}{t(t+1)}} \left[\frac{2t+1}{t(t+1)}\right] = -\frac{2t+1}{2(t^2+t)^{3/2}}$$

$$59. y = \sqrt{\theta+3}(\sin \theta) = (\theta+3)^{1/2} \sin \theta \Rightarrow \ln y = \frac{1}{2} \ln(\theta+3) + \ln(\sin \theta) \Rightarrow \frac{1}{y} \frac{dy}{d\theta} = \frac{1}{2(\theta+3)} + \frac{\cos \theta}{\sin \theta}$$

$$\Rightarrow \frac{dy}{d\theta} = \sqrt{\theta+3}(\sin \theta) \left[\frac{1}{2(\theta+3)} + \cot \theta\right]$$

$$60. y = (\tan \theta) \sqrt{2\theta+1} = (\tan \theta)(2\theta+1)^{1/2} \Rightarrow \ln y = \ln(\tan \theta) + \frac{1}{2} \ln(2\theta+1) \Rightarrow \frac{1}{y} \frac{dy}{d\theta} = \frac{\sec^2 \theta}{\tan \theta} + \left(\frac{1}{2}\right) \left(\frac{2}{2\theta+1}\right)$$

$$\Rightarrow \frac{dy}{d\theta} = (\tan \theta) \sqrt{2\theta+1} \left(\frac{\sec^2 \theta}{\tan \theta} + \frac{1}{2\theta+1}\right) = (\sec^2 \theta) \sqrt{2\theta+1} + \frac{\tan \theta}{\sqrt{2\theta+1}}$$

$$61. y = t(t+1)(t+2) \Rightarrow \ln y = \ln t + \ln(t+1) + \ln(t+2) \Rightarrow \frac{1}{y} \frac{dy}{dt} = \frac{1}{t} + \frac{1}{t+1} + \frac{1}{t+2}$$

$$\Rightarrow \frac{dy}{dt} = t(t+1)(t+2) \left(\frac{1}{t} + \frac{1}{t+1} + \frac{1}{t+2}\right) = t(t+1)(t+2) \left[\frac{(t+1)(t+2)+t(t+2)+t(t+1)}{t(t+1)(t+2)}\right] = 3t^2 + 6t + 2$$

$$62. y = \frac{1}{t(t+1)(t+2)} \Rightarrow \ln y = \ln 1 - \ln t - \ln(t+1) - \ln(t+2) \Rightarrow \frac{1}{y} \frac{dy}{dt} = -\frac{1}{t} - \frac{1}{t+1} - \frac{1}{t+2}$$

$$\Rightarrow \frac{dy}{dt} = \frac{1}{t(t+1)(t+2)} \left[-\frac{1}{t} - \frac{1}{t+1} - \frac{1}{t+2}\right] = \frac{-1}{t(t+1)(t+2)} \left[\frac{(t+1)(t+2)+t(t+2)+t(t+1)}{t(t+1)(t+2)}\right]$$

$$= -\frac{3t^2+6t+2}{(t^3+3t^2+2t)^2}$$

$$63. y = \frac{\theta+5}{\theta \cos \theta} \Rightarrow \ln y = \ln(\theta+5) - \ln \theta - \ln(\cos \theta) \Rightarrow \frac{1}{y} \frac{dy}{d\theta} = \frac{1}{\theta+5} - \frac{1}{\theta} + \frac{\sin \theta}{\cos \theta}$$

$$\Rightarrow \frac{dy}{d\theta} = \left(\frac{\theta+5}{\theta \cos \theta}\right) \left(\frac{1}{\theta+5} - \frac{1}{\theta} + \tan \theta\right)$$

$$64. y = \frac{\theta \sin \theta}{\sqrt{\sec \theta}} \Rightarrow \ln y = \ln \theta + \ln(\sin \theta) - \frac{1}{2} \ln(\sec \theta) \Rightarrow \frac{1}{y} \frac{dy}{d\theta} = \left[\frac{1}{\theta} + \frac{\cos \theta}{\sin \theta} - \frac{(\sec \theta)(\tan \theta)}{2 \sec \theta} \right]$$

$$\Rightarrow \frac{dy}{d\theta} = \frac{\theta \sin \theta}{\sqrt{\sec \theta}} \left(\frac{1}{\theta} + \cot \theta - \frac{1}{2} \tan \theta \right)$$

$$65. y = \frac{x\sqrt{x^2+1}}{(x+1)^{2/3}} \Rightarrow \ln y = \ln x + \frac{1}{2} \ln(x^2+1) - \frac{2}{3} \ln(x+1) \Rightarrow \frac{y'}{y} = \frac{1}{x} + \frac{x}{x^2+1} - \frac{2}{3(x+1)}$$

$$\Rightarrow y' = \frac{x\sqrt{x^2+1}}{(x+1)^{2/3}} \left[\frac{1}{x} + \frac{x}{x^2+1} - \frac{2}{3(x+1)} \right]$$

$$66. y = \sqrt{\frac{(x+1)^{10}}{(2x+1)^5}} \Rightarrow \ln y = \frac{1}{2} [10 \ln(x+1) - 5 \ln(2x+1)] \Rightarrow \frac{y'}{y} = \frac{5}{x+1} - \frac{5}{2x+1}$$

$$\Rightarrow y' = \sqrt{\frac{(x+1)^{10}}{(2x+1)^5}} \left(\frac{5}{x+1} - \frac{5}{2x+1} \right)$$

$$67. y = \sqrt[3]{\frac{x(x-2)}{x^2+1}} \Rightarrow \ln y = \frac{1}{3} [\ln x + \ln(x-2) - \ln(x^2+1)] \Rightarrow \frac{y'}{y} = \frac{1}{3} \left(\frac{1}{x} + \frac{1}{x-2} - \frac{2x}{x^2+1} \right)$$

$$\Rightarrow y' = \frac{1}{3} \sqrt[3]{\frac{x(x-2)}{x^2+1}} \left(\frac{1}{x} + \frac{1}{x-2} - \frac{2x}{x^2+1} \right)$$

$$68. y = \sqrt[3]{\frac{x(x+1)(x-2)}{(x^2+1)(2x+3)}} \Rightarrow \ln y = \frac{1}{3} [\ln x + \ln(x+1) + \ln(x-2) - \ln(x^2+1) - \ln(2x+3)]$$

$$\Rightarrow y' = \frac{1}{3} \sqrt[3]{\frac{x(x+1)(x-2)}{(x^2+1)(2x+3)}} \left(\frac{1}{x} + \frac{1}{x+1} + \frac{1}{x-2} - \frac{2x}{x^2+1} - \frac{2}{2x+3} \right)$$

69. (a) $f(x) = \ln(\cos x) \Rightarrow f'(x) = -\frac{\sin x}{\cos x} = -\tan x = 0 \Rightarrow x = 0$; $f'(x) > 0$ for $-\frac{\pi}{4} \leq x < 0$ and $f'(x) < 0$ for $0 < x \leq \frac{\pi}{3} \Rightarrow$ there is a relative maximum at $x = 0$ with $f(0) = \ln(\cos 0) = \ln 1 = 0$; $f(-\frac{\pi}{4}) = \ln(\cos(-\frac{\pi}{4})) = \ln(\frac{1}{\sqrt{2}}) = -\frac{1}{2} \ln 2$ and $f(\frac{\pi}{3}) = \ln(\cos(\frac{\pi}{3})) = \ln \frac{1}{2} = -\ln 2$. Therefore, the absolute minimum occurs at $x = \frac{\pi}{3}$ with $f(\frac{\pi}{3}) = -\ln 2$ and the absolute maximum occurs at $x = 0$ with $f(0) = 0$.

(b) $f(x) = \cos(\ln x) \Rightarrow f'(x) = \frac{-\sin(\ln x)}{x} = 0 \Rightarrow x = 1$; $f'(x) > 0$ for $\frac{1}{2} \leq x < 1$ and $f'(x) < 0$ for $1 < x \leq 2 \Rightarrow$ there is a relative maximum at $x = 1$ with $f(1) = \cos(\ln 1) = \cos 0 = 1$; $f(\frac{1}{2}) = \cos(\ln(\frac{1}{2})) = \cos(-\ln 2) = \cos(\ln 2)$ and $f(2) = \cos(\ln 2)$. Therefore, the absolute minimum occurs at $x = \frac{1}{2}$ and $x = 2$ with $f(\frac{1}{2}) = f(2) = \cos(\ln 2)$, and the absolute maximum occurs at $x = 1$ with $f(1) = 1$.

70. (a) $f(x) = x - \ln x \Rightarrow f'(x) = 1 - \frac{1}{x}$; if $x > 1$, then $f'(x) > 0$ which means that $f(x)$ is increasing

(b) $f(1) = 1 - \ln 1 = 1 \Rightarrow f(x) = x - \ln x > 0$, if $x > 1$ by part (a) $\Rightarrow x > \ln x$ if $x > 1$

$$71. \int_1^5 (\ln 2x - \ln x) dx = \int_1^5 (-\ln x + \ln 2 + \ln x) dx = (\ln 2) \int_1^5 dx = (\ln 2)(5 - 1) = \ln 2^4 = \ln 16$$

$$72. A = \int_{-\pi/4}^0 -\tan x dx + \int_0^{\pi/3} \tan x dx = \int_{-\pi/4}^0 \frac{-\sin x}{\cos x} dx - \int_0^{\pi/3} \frac{\sin x}{\cos x} dx = [\ln |\cos x|]_{-\pi/4}^0 - [\ln |\cos x|]_0^{\pi/3}$$

$$= \left(\ln 1 - \ln \frac{1}{\sqrt{2}} \right) - \left(\ln \frac{1}{2} - \ln 1 \right) = \ln \sqrt{2} + \ln 2 = \frac{3}{2} \ln 2$$

$$73. V = \pi \int_0^3 \left(\frac{2}{\sqrt{y+1}} \right)^2 dy = 4\pi \int_0^3 \frac{1}{y+1} dy = 4\pi [\ln |y+1|]_0^3 = 4\pi(\ln 4 - \ln 1) = 4\pi \ln 4$$

$$74. V = \pi \int_{\pi/6}^{\pi/2} \cot x dx = \pi \int_{\pi/6}^{\pi/2} \frac{\cos x}{\sin x} dx = \pi [\ln |\sin x|]_{\pi/6}^{\pi/2} = \pi (\ln 1 - \ln \frac{1}{2}) = \pi \ln 2$$

$$75. V = 2\pi \int_{1/2}^2 x \left(\frac{1}{x^2} \right) dx = 2\pi \int_{1/2}^2 \frac{1}{x} dx = 2\pi [\ln |x|]_{1/2}^2 = 2\pi (\ln 2 - \ln \frac{1}{2}) = 2\pi(2 \ln 2) = \pi \ln 2^4 = \pi \ln 16$$

$$76. V = \pi \int_0^3 \left(\frac{9x}{\sqrt{x^3+9}} \right)^2 dx = 27\pi \int_0^3 dx = 27\pi [\ln(x^3+9)]_0^3 = 27\pi(\ln 36 - \ln 9) \\ = 27\pi(\ln 4 + \ln 9 - \ln 9) = 27\pi \ln 4 = 54\pi \ln 2$$

$$77. (a) y = \frac{x^2}{8} - \ln x \Rightarrow 1 + (y')^2 = 1 + \left(\frac{x}{4} - \frac{1}{x} \right)^2 = 1 + \left(\frac{x^2-4}{4x} \right)^2 = \left(\frac{x^2+4}{4x} \right)^2 \Rightarrow L = \int_4^8 \sqrt{1 + (y')^2} dx \\ = \int_4^8 \frac{x^2+4}{4x} dx = \int_4^8 \left(\frac{x}{4} + \frac{1}{x} \right) dx = \left[\frac{x^2}{8} + \ln|x| \right]_4^8 = (8 + \ln 8) - (2 + \ln 4) = 6 + \ln 2$$

$$(b) x = \left(\frac{y}{4} \right)^2 - 2 \ln \left(\frac{y}{4} \right) \Rightarrow \frac{dx}{dy} = \frac{y}{8} - \frac{2}{y} \Rightarrow 1 + \left(\frac{dx}{dy} \right)^2 = 1 + \left(\frac{y}{8} - \frac{2}{y} \right)^2 = 1 + \left(\frac{y^2-16}{8y} \right)^2 = \left(\frac{y^2+16}{8y} \right)^2 \\ \Rightarrow L = \int_4^{12} \sqrt{1 + \left(\frac{dx}{dy} \right)^2} dy = \int_4^{12} \frac{y^2+16}{8y} dy = \int_4^{12} \left(\frac{y}{8} + \frac{2}{y} \right) dy = \left[\frac{y^2}{16} + 2 \ln y \right]_4^{12} = (9 + 2 \ln 12) - (1 + 2 \ln 4) \\ = 8 + 2 \ln 3 = 8 + \ln 9$$

$$78. L = \int_1^2 \sqrt{1 + \frac{1}{x^2}} dx \Rightarrow \frac{dy}{dx} = \frac{1}{x} \Rightarrow y = \ln|x| + C = \ln x + C \text{ since } x > 0 \Rightarrow 0 = \ln 1 + C \Rightarrow C = 0 \Rightarrow y = \ln x$$

$$79. (a) M_y = \int_1^2 x \left(\frac{1}{x} \right) dx = 1, M_x = \int_1^2 \left(\frac{1}{2x} \right) \left(\frac{1}{x} \right) dx = \frac{1}{2} \int_1^2 \frac{1}{x^2} dx = \left[-\frac{1}{2x} \right]_1^2 = \frac{1}{4}, M = \int_1^2 \frac{1}{x} dx = [\ln|x|]_1^2 = \ln 2 \\ \Rightarrow \bar{x} = \frac{M_y}{M} = \frac{1}{\ln 2} \approx 1.44 \text{ and } \bar{y} = \frac{M_x}{M} = \frac{(\frac{1}{4})}{\ln 2} \approx 0.36$$

(b)

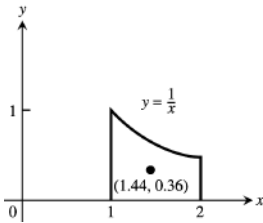

$$80. (a) M_y = \int_1^{16} x \left(\frac{1}{\sqrt{x}} \right) dx = \int_1^{16} x^{1/2} dx = \frac{2}{3} [x^{3/2}]_1^{16} = 42; M_x = \int_1^{16} \left(\frac{1}{2\sqrt{x}} \right) \left(\frac{1}{\sqrt{x}} \right) dx = \frac{1}{2} \int_1^{16} \frac{1}{x} dx \\ = \frac{1}{2} [\ln|x|]_1^{16} = \ln 4, M = \int_1^{16} \frac{1}{\sqrt{x}} dx = [2x^{1/2}]_1^{16} = 6 \Rightarrow \bar{x} = \frac{M_y}{M} = 7 \text{ and } \bar{y} = \frac{M_x}{M} = \frac{\ln 4}{6}$$

$$(b) M_y = \int_1^{16} x \left(\frac{1}{\sqrt{x}} \right) \left(\frac{4}{\sqrt{x}} \right) dx = 4 \int_1^{16} dx = 60, M_x = \int_1^{16} \left(\frac{1}{2\sqrt{x}} \right) \left(\frac{1}{\sqrt{x}} \right) \left(\frac{4}{\sqrt{x}} \right) dx = 2 \int_1^{16} x^{-3/2} dx \\ = -4 [x^{-1/2}]_1^{16} = 3, M = \int_1^{16} \left(\frac{1}{\sqrt{x}} \right) \left(\frac{4}{\sqrt{x}} \right) dx = 4 \int_1^{16} \frac{1}{x} dx = [4 \ln|x|]_1^{16} = 4 \ln 16 \Rightarrow \bar{x} = \frac{M_y}{M} = \frac{15}{\ln 16} \text{ and } \\ \bar{y} = \frac{M_x}{M} = \frac{3}{4 \ln 16}$$

$$81. \frac{dy}{dx} = 1 + \frac{1}{x} \text{ at } (1, 3) \Rightarrow y = x + \ln|x| + C; y = 3 \text{ at } x = 1 \Rightarrow C = 2 \Rightarrow y = x + \ln|x| + 2$$

$$82. \frac{d^2y}{dx^2} = \sec^2 x \Rightarrow \frac{dy}{dx} = \tan x + C \text{ and } 1 = \tan 0 + C \Rightarrow \frac{dy}{dx} = \tan x + 1 \Rightarrow y = \int (\tan x + 1) dx \\ = \ln|\sec x| + x + C_1 \text{ and } 0 = \ln|\sec 0| + 0 + C_1 \Rightarrow C_1 = 0 \Rightarrow y = \ln|\sec x| + x$$

$$83. (a) L(x) = f(0) + f'(0) \cdot x, \text{ and } f(x) = \ln(1+x) \Rightarrow f'(x)|_{x=0} = \frac{1}{1+x}|_{x=0} = 1 \Rightarrow L(x) = \ln 1 + 1 \cdot x \Rightarrow L(x) = x$$

(b) Let $f(x) = \ln(x+1)$. Since $f''(x) = -\frac{1}{(x+1)^2} < 0$ on $[0, 0.1]$, the graph of f is concave down on this interval and the largest error in the linear approximation will occur when $x = 0.1$. This error is $0.1 - \ln(1.1) \approx 0.00469$ to five decimal places.

(c) The approximation $y = x$ for $\ln(1 + x)$ is best for smaller positive values of x ; in particular for $0 \leq x \leq 0.1$ in the graph. As x increases, so does the error $x - \ln(1 + x)$. From the graph an upper bound for the error is $0.5 - \ln(1 + 0.5) \approx 0.095$; i.e., $|E(x)| \leq 0.095$ for $0 \leq x \leq 0.5$. Note from the graph that $0.1 - \ln(1 + 0.1) \approx 0.00469$ estimates the error in replacing $\ln(1 + x)$ by x over $0 \leq x \leq 0.1$. This is consistent with the estimate given in part (b) above.

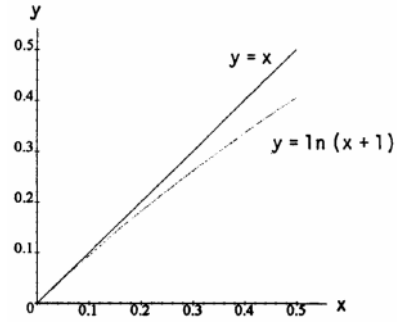

84. For all positive values of x , $\frac{d}{dx}[\ln \frac{a}{x}] = \frac{1}{\frac{a}{x}} \cdot -\frac{a}{x^2} = -\frac{1}{x}$ and $\frac{d}{dx}[\ln a - \ln x] = 0 - \frac{1}{x} = -\frac{1}{x}$. Since $\ln \frac{a}{x}$ and $\ln a - \ln x$ have the same derivative, then $\ln \frac{a}{x} = \ln a - \ln x + C$ for some constant C . Since this equation holds for all positive values of x , it must be true for $x = 1 \Rightarrow \ln \frac{a}{1} = \ln a - \ln 1 + C = 0 - \ln 1 + C \Rightarrow \ln \frac{a}{1} = -\ln 1 + C$. By part 3 we know that $\ln \frac{1}{a} = -\ln a \Rightarrow C = 0 \Rightarrow \ln \frac{a}{x} = \ln a - \ln x$.

85. $y = \ln kx \Rightarrow y = \ln x + \ln k$; thus the graph of $y = \ln kx$ is the graph of $y = \ln x$ shifted vertically by $\ln k$, $k > 0$.

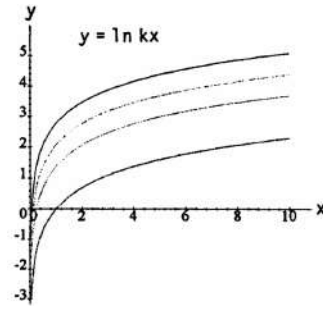

86. To turn the arches upside down we would use the formula $y = -\ln |\sin x| = \ln \frac{1}{|\sin x|}$.

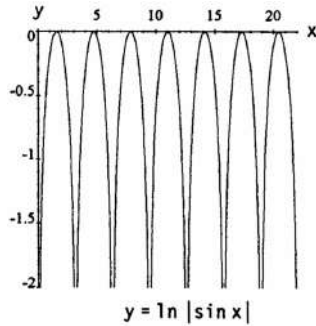

87. (a)

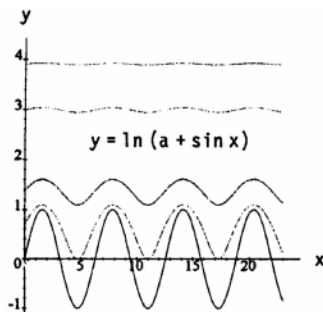

(b) $y' = \frac{\cos x}{a + \sin x}$. Since $|\sin x|$ and $|\cos x|$ are less than or equal to 1, we have for $a > 1$ $\frac{-1}{a-1} \leq y' \leq \frac{1}{a-1}$ for all x . Thus, $\lim_{a \rightarrow +\infty} y' = 0$ for all $x \Rightarrow$ the graph of y looks more and more horizontal as $a \rightarrow +\infty$.

88. (a) The graph of $y = \sqrt{x} - \ln x$ appears to be concave upward for all $x > 0$.

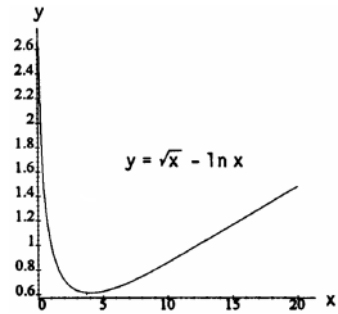

- (b) $y = \sqrt{x} - \ln x \Rightarrow y' = \frac{1}{2\sqrt{x}} - \frac{1}{x} \Rightarrow y'' = -\frac{1}{4x^{3/2}} + \frac{1}{x^2} = \frac{1}{x^2} \left(-\frac{\sqrt{x}}{4} + 1 \right) = 0 \Rightarrow \sqrt{x} = 4 \Rightarrow x = 16$.
Thus, $y'' > 0$ if $0 < x < 16$ and $y'' < 0$ if $x > 16$ so a point of inflection exists at $x = 16$. The graph of $y = \sqrt{x} - \ln x$ closely resembles a straight line for $x \geq 10$ and it is impossible to discuss the point of inflection visually from the graph.

7.3 THE EXPONENTIAL FUNCTION

1. (a) $e^{\ln 7.2} = 7.2$ (b) $e^{-\ln x^2} = \frac{1}{e^{\ln x^2}} = \frac{1}{x^2}$ (c) $e^{\ln x - \ln y} = e^{\ln(x/y)} = \frac{x}{y}$
2. (a) $e^{\ln(x^2+y^2)} = x^2 + y^2$ (b) $e^{-\ln 0.3} = \frac{1}{e^{\ln 0.3}} = \frac{1}{0.3}$ (c) $e^{\ln \pi x - \ln 2} = e^{\ln(\pi x/2)} = \frac{\pi x}{2}$
3. (a) $2 \ln \sqrt{e} = 2 \ln e^{1/2} = (2) \left(\frac{1}{2}\right) \ln e = 1$ (b) $\ln(\ln e^e) = \ln(e \ln e) = \ln e = 1$
(c) $\ln e^{(-x^2-y^2)} = (-x^2 - y^2) \ln e = -x^2 - y^2$
4. (a) $\ln(e^{\sec \theta}) = (\sec \theta)(\ln e) = \sec \theta$ (b) $\ln e^{(e^x)} = (e^x)(\ln e) = e^x$
(c) $\ln(e^{2 \ln x}) = \ln(e^{\ln x^2}) = \ln x^2 = 2 \ln x$
5. $\ln y = 2t + 4 \Rightarrow e^{\ln y} = e^{2t+4} \Rightarrow y = e^{2t+4}$ 6. $\ln y = -t + 5 \Rightarrow e^{\ln y} = e^{-t+5} \Rightarrow y = e^{-t+5}$
7. $\ln(y - 40) = 5t \Rightarrow e^{\ln(y-40)} = e^{5t} \Rightarrow y - 40 = e^{5t} \Rightarrow y = e^{5t} + 40$
8. $\ln(1 - 2y) = t \Rightarrow e^{\ln(1-2y)} = e^t \Rightarrow 1 - 2y = e^t \Rightarrow -2y = e^t - 1 \Rightarrow y = -\left(\frac{e^t - 1}{2}\right)$
9. $\ln(y - 1) - \ln 2 = x + \ln x \Rightarrow \ln(y - 1) - \ln 2 - \ln x = x \Rightarrow \ln\left(\frac{y-1}{2x}\right) = x \Rightarrow e^{\ln\left(\frac{y-1}{2x}\right)} = e^x \Rightarrow \frac{y-1}{2x} = e^x \Rightarrow y - 1 = 2xe^x \Rightarrow y = 2xe^x + 1$
10. $\ln(y^2 - 1) - \ln(y + 1) = \ln(\sin x) \Rightarrow \ln\left(\frac{y^2-1}{y+1}\right) = \ln(\sin x) \Rightarrow \ln(y - 1) = \ln(\sin x) \Rightarrow e^{\ln(y-1)} = e^{\ln(\sin x)} \Rightarrow y - 1 = \sin x \Rightarrow y = \sin x + 1$
11. (a) $e^{2k} = 4 \Rightarrow \ln e^{2k} = \ln 4 \Rightarrow 2k \ln e = \ln 2^2 \Rightarrow 2k = 2 \ln 2 \Rightarrow k = \ln 2$
(b) $100e^{10k} = 200 \Rightarrow e^{10k} = 2 \Rightarrow \ln e^{10k} = \ln 2 \Rightarrow 10k \ln e = \ln 2 \Rightarrow 10k = \ln 2 \Rightarrow k = \frac{\ln 2}{10}$
(c) $e^{k/1000} = a \Rightarrow \ln e^{k/1000} = \ln a \Rightarrow \frac{k}{1000} \ln e = \ln a \Rightarrow \frac{k}{1000} = \ln a \Rightarrow k = 1000 \ln a$
12. (a) $e^{5k} = \frac{1}{4} \Rightarrow \ln e^{5k} = \ln 4^{-1} \Rightarrow 5k \ln e = -\ln 4 \Rightarrow 5k = -\ln 4 \Rightarrow k = -\frac{\ln 4}{5}$
(b) $80e^k = 1 \Rightarrow e^k = 80^{-1} \Rightarrow \ln e^k = \ln 80^{-1} \Rightarrow k \ln e = -\ln 80 \Rightarrow k = -\ln 80$
(c) $e^{(\ln 0.8)k} = 0.8 \Rightarrow (e^{\ln 0.8})^k = 0.8 \Rightarrow (0.8)^k = 0.8 \Rightarrow k = 1$

440 Chapter 7 Transcendental Functions

13. (a) $e^{-0.3t} = 27 \Rightarrow \ln e^{-0.3t} = \ln 3^3 \Rightarrow (-0.3t) \ln e = 3 \ln 3 \Rightarrow -0.3t = 3 \ln 3 \Rightarrow t = -10 \ln 3$

(b) $e^{kt} = \frac{1}{2} \Rightarrow \ln e^{kt} = \ln 2^{-1} = kt \ln e = -\ln 2 \Rightarrow t = -\frac{\ln 2}{k}$

(c) $e^{(\ln 0.2)t} = 0.4 \Rightarrow (e^{\ln 0.2})^t = 0.4 \Rightarrow 0.2^t = 0.4 \Rightarrow \ln 0.2^t = \ln 0.4 \Rightarrow t \ln 0.2 = \ln 0.4 \Rightarrow t = \frac{\ln 0.4}{\ln 0.2}$

14. (a) $e^{-0.01t} = 1000 \Rightarrow \ln e^{-0.01t} = \ln 1000 \Rightarrow (-0.01t) \ln e = \ln 1000 \Rightarrow -0.01t = \ln 1000 \Rightarrow t = -100 \ln 1000$

(b) $e^{kt} = \frac{1}{10} \Rightarrow \ln e^{kt} = \ln 10^{-1} = kt \ln e = -\ln 10 \Rightarrow kt = -\ln 10 \Rightarrow t = -\frac{\ln 10}{k}$

(c) $e^{(\ln 2)t} = \frac{1}{2} \Rightarrow (e^{\ln 2})^t = 2^{-1} \Rightarrow 2^t = 2^{-1} \Rightarrow t = -1$

15. $e^{\sqrt{t}} = x^2 \Rightarrow \ln e^{\sqrt{t}} = \ln x^2 \Rightarrow \sqrt{t} = 2 \ln x \Rightarrow t = 4(\ln x)^2$

16. $e^{x^2} e^{2x+1} = e^t \Rightarrow e^{x^2+2x+1} = e^t \Rightarrow \ln e^{x^2+2x+1} = \ln e^t \Rightarrow t = x^2 + 2x + 1$

17. $y = e^{-5x} \Rightarrow y' = e^{-5x} \frac{d}{dx} (-5x) \Rightarrow y' = -5e^{-5x}$

18. $y = e^{2x/3} \Rightarrow y' = e^{2x/3} \frac{d}{dx} \left(\frac{2x}{3}\right) \Rightarrow y' = \frac{2}{3} e^{2x/3}$

19. $y = e^{5-7x} \Rightarrow y' = e^{5-7x} \frac{d}{dx} (5-7x) \Rightarrow y' = -7e^{5-7x}$

20. $y = e^{(4\sqrt{x}+x^2)} \Rightarrow y' = e^{(4\sqrt{x}+x^2)} \frac{d}{dx} (4\sqrt{x}+x^2) \Rightarrow y' = \left(\frac{2}{\sqrt{x}} + 2x\right) e^{(4\sqrt{x}+x^2)}$

21. $y = xe^x - e^x \Rightarrow y' = (e^x + xe^x) - e^x = xe^x$

22. $y = (1+2x)e^{-2x} \Rightarrow y' = 2e^{-2x} + (1+2x)e^{-2x} \frac{d}{dx} (-2x) \Rightarrow y' = 2e^{-2x} - 2(1+2x)e^{-2x} = -4xe^{-2x}$

23. $y = (x^2 - 2x + 2)e^x \Rightarrow y' = (2x - 2)e^x + (x^2 - 2x + 2)e^x = x^2e^x$

24. $y = (9x^2 - 6x + 2)e^{3x} \Rightarrow y' = (18x - 6)e^{3x} + (9x^2 - 6x + 2)e^{3x} \frac{d}{dx} (3x) \Rightarrow y' = (18x - 6)e^{3x} + 3(9x^2 - 6x + 2)e^{3x} = 27x^2e^{3x}$

25. $y = e^\theta(\sin \theta + \cos \theta) \Rightarrow y' = e^\theta(\sin \theta + \cos \theta) + e^\theta(\cos \theta - \sin \theta) = 2e^\theta \cos \theta$

26. $y = \ln(3\theta e^{-\theta}) = \ln 3 + \ln \theta + \ln e^{-\theta} = \ln 3 + \ln \theta - \theta \Rightarrow \frac{dy}{d\theta} = \frac{1}{\theta} - 1$

27. $y = \cos(e^{-\theta^2}) \Rightarrow \frac{dy}{d\theta} = -\sin(e^{-\theta^2}) \frac{d}{d\theta} (e^{-\theta^2}) = (-\sin(e^{-\theta^2})) (e^{-\theta^2}) \frac{d}{d\theta} (-\theta^2) = 2\theta e^{-\theta^2} \sin(e^{-\theta^2})$

28. $y = \theta^3 e^{-2\theta} \cos 5\theta \Rightarrow \frac{dy}{d\theta} = (3\theta^2)(e^{-2\theta} \cos 5\theta) + (\theta^3 \cos 5\theta) e^{-2\theta} \frac{d}{d\theta} (-2\theta) - 5(\sin 5\theta)(\theta^3 e^{-2\theta}) = \theta^2 e^{-2\theta} (3 \cos 5\theta - 2\theta \cos 5\theta - 5\theta \sin 5\theta)$

29. $y = \ln(3te^{-t}) = \ln 3 + \ln t + \ln e^{-t} = \ln 3 + \ln t - t \Rightarrow \frac{dy}{dt} = \frac{1}{t} - 1 = \frac{1-t}{t}$

30. $y = \ln(2e^{-t} \sin t) = \ln 2 + \ln e^{-t} + \ln \sin t = \ln 2 - t + \ln \sin t \Rightarrow \frac{dy}{dt} = -1 + \left(\frac{1}{\sin t}\right) \frac{d}{dt} (\sin t) = -1 + \frac{\cos t}{\sin t} = \frac{\cos t - \sin t}{\sin t}$

31. $y = \ln \frac{e^\theta}{1+e^\theta} = \ln e^\theta - \ln(1+e^\theta) = \theta - \ln(1+e^\theta) \Rightarrow \frac{dy}{d\theta} = 1 - \left(\frac{1}{1+e^\theta}\right) \frac{d}{d\theta} (1+e^\theta) = 1 - \frac{e^\theta}{1+e^\theta} = \frac{1}{1+e^\theta}$

$$32. y = \ln \frac{\sqrt{\theta}}{1+\sqrt{\theta}} = \ln \sqrt{\theta} - \ln(1+\sqrt{\theta}) \Rightarrow \frac{dy}{d\theta} = \left(\frac{1}{\sqrt{\theta}}\right) \frac{d}{d\theta}(\sqrt{\theta}) - \left(\frac{1}{1+\sqrt{\theta}}\right) \frac{d}{d\theta}(1+\sqrt{\theta})$$

$$= \left(\frac{1}{\sqrt{\theta}}\right) \left(\frac{1}{2\sqrt{\theta}}\right) - \left(\frac{1}{1+\sqrt{\theta}}\right) \left(\frac{1}{2\sqrt{\theta}}\right) = \frac{(1+\sqrt{\theta}) - \sqrt{\theta}}{2\theta(1+\sqrt{\theta})} = \frac{1}{2\theta(1+\sqrt{\theta})} = \frac{1}{2\theta(1+\theta^{1/2})}$$

$$33. y = e^{(\cos t + \ln t)} = e^{\cos t} e^{\ln t} = te^{\cos t} \Rightarrow \frac{dy}{dt} = e^{\cos t} + te^{\cos t} \frac{d}{dt}(\cos t) = (1 - t \sin t) e^{\cos t}$$

$$34. y = e^{\sin t} (\ln t^2 + 1) \Rightarrow \frac{dy}{dt} = e^{\sin t} (\cos t) (\ln t^2 + 1) + \frac{2}{t} e^{\sin t} = e^{\sin t} [(\ln t^2 + 1) (\cos t) + \frac{2}{t}]$$

$$35. \int_0^{\ln x} \sin e^t dt \Rightarrow y' = (\sin e^{\ln x}) \cdot \frac{d}{dx}(\ln x) = \frac{\sin x}{x}$$

$$36. y = \int_{e^{4\sqrt{x}}}^{e^{2x}} \ln t dt \Rightarrow y' = (\ln e^{2x}) \cdot \frac{d}{dx}(e^{2x}) - (\ln e^{4\sqrt{x}}) \cdot \frac{d}{dx}(e^{4\sqrt{x}}) = (2x)(2e^{2x}) - (4\sqrt{x})(e^{4\sqrt{x}}) \cdot \frac{d}{dx}(4\sqrt{x})$$

$$= 4xe^{2x} - 4\sqrt{x}e^{4\sqrt{x}} \left(\frac{2}{\sqrt{x}}\right) = 4xe^{2x} - 8e^{4\sqrt{x}}$$

$$37. \ln y = e^y \sin x \Rightarrow \left(\frac{1}{y}\right) y' = (y'e^y)(\sin x) + e^y \cos x \Rightarrow y' \left(\frac{1}{y} - e^y \sin x\right) = e^y \cos x$$

$$\Rightarrow y' \left(\frac{1 - ye^y \sin x}{y}\right) = e^y \cos x \Rightarrow y' = \frac{ye^y \cos x}{1 - ye^y \sin x}$$

$$38. \ln xy = e^{x+y} \Rightarrow \ln x + \ln y = e^{x+y} \Rightarrow \frac{1}{x} + \left(\frac{1}{y}\right) y' = (1 + y') e^{x+y} \Rightarrow y' \left(\frac{1}{y} - e^{x+y}\right) = e^{x+y} - \frac{1}{x}$$

$$\Rightarrow y' \left(\frac{1 - ye^{x+y}}{y}\right) = \frac{xe^{x+y} - 1}{x} \Rightarrow y' = \frac{y(xe^{x+y} - 1)}{x(1 - ye^{x+y})}$$

$$39. e^{2x} = \sin(x + 3y) \Rightarrow 2e^{2x} = (1 + 3y') \cos(x + 3y) \Rightarrow 1 + 3y' = \frac{2e^{2x}}{\cos(x + 3y)} \Rightarrow 3y' = \frac{2e^{2x}}{\cos(x + 3y)} - 1$$

$$\Rightarrow y' = \frac{2e^{2x} - \cos(x + 3y)}{3 \cos(x + 3y)}$$

$$40. \tan y = e^x + \ln x \Rightarrow (\sec^2 y) y' = e^x + \frac{1}{x} \Rightarrow y' = \frac{(xe^x + 1) \cos^2 y}{x}$$

$$41. \int (e^{3x} + 5e^{-x}) dx = \frac{e^{3x}}{3} - 5e^{-x} + C$$

$$42. \int (2e^x - 3e^{-2x}) dx = 2e^x + \frac{3}{2}e^{-2x} + C$$

$$43. \int_{\ln 2}^{\ln 3} e^x dx = [e^x]_{\ln 2}^{\ln 3} = e^{\ln 3} - e^{\ln 2} = 3 - 2 = 1$$

$$44. \int_{-\ln 2}^{\ln 3} e^{-x} dx = [-e^{-x}]_{-\ln 2}^{\ln 3} = -e^0 + e^{\ln 2} = -1 + 2 = 1$$

$$45. \int 8e^{(x+1)} dx = 8e^{(x+1)} + C$$

$$46. \int 2e^{(2x-1)} dx = e^{(2x-1)} + C$$

$$47. \int_{\ln 4}^{\ln 9} e^{x/2} dx = [2e^{x/2}]_{\ln 4}^{\ln 9} = 2[e^{(\ln 9)/2} - e^{(\ln 4)/2}] = 2(e^{\ln 3} - e^{\ln 2}) = 2(3 - 2) = 2$$

$$48. \int_0^{\ln 16} e^{x/4} dx = [4e^{x/4}]_0^{\ln 16} = 4(e^{(\ln 16)/4} - e^0) = 4(e^{\ln 2} - 1) = 4(2 - 1) = 4$$

$$49. \text{Let } u = r^{1/2} \Rightarrow du = \frac{1}{2} r^{-1/2} dr \Rightarrow 2 du = r^{-1/2} dr;$$

$$\int \frac{e^{\sqrt{r}}}{\sqrt{r}} dr = \int e^u \cdot r^{-1/2} dr = 2 \int e^u du = 2e^u + C = 2e^{r^{1/2}} + C = 2e^{\sqrt{r}} + C$$

$$50. \text{Let } u = -r^{1/2} \Rightarrow du = -\frac{1}{2} r^{-1/2} dr \Rightarrow -2 du = r^{-1/2} dr;$$

$$\int \frac{e^{-\sqrt{r}}}{\sqrt{r}} dr = \int e^{-u} \cdot r^{-1/2} dr = -2 \int e^u du = -2e^{-u} + C = -2e^{-\sqrt{r}} + C$$

51. Let $u = -t^2 \Rightarrow du = -2t dt \Rightarrow -du = 2t dt$;

$$\int 2te^{-t^2} dt = -\int e^u du = -e^u + C = -e^{-t^2} + C$$

52. Let $u = t^4 \Rightarrow du = 4t^3 dt \Rightarrow \frac{1}{4} du = t^3 dt$;

$$\int t^3 e^{t^4} dt = \frac{1}{4} \int e^u du = \frac{1}{4} e^u + C$$

53. Let $u = \frac{1}{x} \Rightarrow du = -\frac{1}{x^2} dx \Rightarrow -du = \frac{1}{x^2} dx$;

$$\int \frac{e^{1/x}}{x^2} dx = \int -e^u du = -e^u + C = -e^{1/x} + C$$

54. Let $u = -x^{-2} \Rightarrow du = 2x^{-3} dx \Rightarrow \frac{1}{2} du = x^{-3} dx$;

$$\int \frac{e^{-1/x^2}}{x^3} dx = \int e^{-x^{-2}} \cdot x^{-3} dx = \frac{1}{2} \int e^u du = \frac{1}{2} e^u + C = \frac{1}{2} e^{-x^{-2}} + C = \frac{1}{2} e^{-1/x^2} + C$$

55. Let $u = \tan \theta \Rightarrow du = \sec^2 \theta d\theta$; $\theta = 0 \Rightarrow u = 0$, $\theta = \frac{\pi}{4} \Rightarrow u = 1$;

$$\begin{aligned} \int_0^{\pi/4} (1 + e^{\tan \theta}) \sec^2 \theta d\theta &= \int_0^{\pi/4} \sec^2 \theta d\theta + \int_0^1 e^u du = [\tan \theta]_0^{\pi/4} + [e^u]_0^1 = [\tan(\frac{\pi}{4}) - \tan(0)] + (e^1 - e^0) \\ &= (1 - 0) + (e - 1) = e \end{aligned}$$

56. Let $u = \cot \theta \Rightarrow du = -\csc^2 \theta d\theta$; $\theta = \frac{\pi}{4} \Rightarrow u = 1$, $\theta = \frac{\pi}{2} \Rightarrow u = 0$;

$$\begin{aligned} \int_{\pi/4}^{\pi/2} (1 + e^{\cot \theta}) \csc^2 \theta d\theta &= \int_{\pi/4}^{\pi/2} \csc^2 \theta d\theta - \int_1^0 e^u du = [-\cot \theta]_{\pi/4}^{\pi/2} - [e^u]_1^0 = [-\cot(\frac{\pi}{2}) + \cot(\frac{\pi}{4})] - (e^0 - e^1) \\ &= (0 + 1) - (1 - e) = e \end{aligned}$$

57. Let $u = \sec \pi t \Rightarrow du = \pi \sec \pi t \tan \pi t dt \Rightarrow \frac{du}{\pi} = \sec \pi t \tan \pi t dt$;

$$\int e^{\sec(\pi t)} \sec(\pi t) \tan(\pi t) dt = \frac{1}{\pi} \int e^u du = \frac{e^u}{\pi} + C = \frac{e^{\sec(\pi t)}}{\pi} + C$$

58. Let $u = \csc(\pi + t) \Rightarrow du = -\csc(\pi + t) \cot(\pi + t) dt$;

$$\int e^{\csc(\pi+t)} \csc(\pi+t) \cot(\pi+t) dt = -\int e^u du = -e^u + C = -e^{\csc(\pi+t)} + C$$

59. Let $u = e^v \Rightarrow du = e^v dv \Rightarrow 2 du = 2e^v dv$; $v = \ln \frac{\pi}{6} \Rightarrow u = \frac{\pi}{6}$, $v = \ln \frac{\pi}{2} \Rightarrow u = \frac{\pi}{2}$;

$$\int_{\ln(\pi/6)}^{\ln(\pi/2)} 2e^v \cos e^v dv = 2 \int_{\pi/6}^{\pi/2} \cos u du = [2 \sin u]_{\pi/6}^{\pi/2} = 2 [\sin(\frac{\pi}{2}) - \sin(\frac{\pi}{6})] = 2(1 - \frac{1}{2}) = 1$$

60. Let $u = e^{x^2} \Rightarrow du = 2xe^{x^2} dx$; $x = 0 \Rightarrow u = 1$, $x = \sqrt{\ln \pi} \Rightarrow u = e^{\ln \pi} = \pi$;

$$\int_0^{\sqrt{\ln \pi}} 2xe^{x^2} \cos(e^{x^2}) dx = \int_1^{\pi} \cos u du = [\sin u]_1^{\pi} = \sin(\pi) - \sin(1) = -\sin(1) \approx -0.84147$$

61. Let $u = 1 + e^r \Rightarrow du = e^r dr$;

$$\int \frac{e^r}{1+e^r} dr = \int \frac{1}{u} du = \ln |u| + C = \ln(1 + e^r) + C$$

62. $\int \frac{1}{1+e^x} dx = \int \frac{e^{-x}}{e^{-x}+1} dx$;

let $u = e^{-x} + 1 \Rightarrow du = -e^{-x} dx \Rightarrow -du = e^{-x} dx$;

$$\int \frac{e^{-x}}{e^{-x}+1} dx = -\int \frac{1}{u} du = -\ln |u| + C = -\ln(e^{-x} + 1) + C$$

63. $\frac{dy}{dt} = e^t \sin(e^t - 2) \Rightarrow y = \int e^t \sin(e^t - 2) dt$;

let $u = e^t - 2 \Rightarrow du = e^t dt \Rightarrow y = \int \sin u du = -\cos u + C = -\cos(e^t - 2) + C$; $y(\ln 2) = 0$

$$\Rightarrow -\cos(e^{\ln 2} - 2) + C = 0 \Rightarrow -\cos(2 - 2) + C = 0 \Rightarrow C = \cos 0 = 1; \text{ thus, } y = 1 - \cos(e^t - 2)$$

64. $\frac{dy}{dt} = e^{-t} \sec^2(\pi e^{-t}) \Rightarrow y = \int e^{-t} \sec^2(\pi e^{-t}) dt;$

let $u = \pi e^{-t} \Rightarrow du = -\pi e^{-t} dt \Rightarrow -\frac{1}{\pi} du = e^{-t} dt \Rightarrow y = -\frac{1}{\pi} \int \sec^2 u du = -\frac{1}{\pi} \tan u + C$
 $= -\frac{1}{\pi} \tan(\pi e^{-t}) + C; y(\ln 4) = \frac{2}{\pi} \Rightarrow -\frac{1}{\pi} \tan(\pi e^{-\ln 4}) + C = \frac{2}{\pi} \Rightarrow -\frac{1}{\pi} \tan(\pi \cdot \frac{1}{4}) + C = \frac{2}{\pi}$
 $\Rightarrow -\frac{1}{\pi}(1) + C = \frac{2}{\pi} \Rightarrow C = \frac{3}{\pi}; \text{ thus, } y = \frac{3}{\pi} - \frac{1}{\pi} \tan(\pi e^{-t})$

65. $\frac{d^2y}{dx^2} = 2e^{-x} \Rightarrow \frac{dy}{dx} = -2e^{-x} + C; x = 0 \text{ and } \frac{dy}{dx} = 0 \Rightarrow 0 = -2e^0 + C \Rightarrow C = 2; \text{ thus } \frac{dy}{dx} = -2e^{-x} + 2$
 $\Rightarrow y = 2e^{-x} + 2x + C_1; x = 0 \text{ and } y = 1 \Rightarrow 1 = 2e^0 + C_1 \Rightarrow C_1 = -1 \Rightarrow y = 2e^{-x} + 2x - 1 = 2(e^{-x} + x) - 1$

66. $\frac{d^2y}{dt^2} = 1 - e^{2t} \Rightarrow \frac{dy}{dt} = t - \frac{1}{2} e^{2t} + C; t = 1 \text{ and } \frac{dy}{dt} = 0 \Rightarrow 0 = 1 - \frac{1}{2} e^2 + C \Rightarrow C = \frac{1}{2} e^2 - 1; \text{ thus}$
 $\frac{dy}{dt} = t - \frac{1}{2} e^{2t} + \frac{1}{2} e^2 - 1 \Rightarrow y = \frac{1}{2} t^2 - \frac{1}{4} e^{2t} + (\frac{1}{2} e^2 - 1)t + C_1; t = 1 \text{ and } y = -1 \Rightarrow -1 = \frac{1}{2} - \frac{1}{4} e^2 + \frac{1}{2} e^2 - 1 + C_1$
 $\Rightarrow C_1 = -\frac{1}{2} - \frac{1}{4} e^2 \Rightarrow y = \frac{1}{2} t^2 - \frac{1}{4} e^{2t} + (\frac{1}{2} e^2 - 1)t - (\frac{1}{2} + \frac{1}{4} e^2)$

67. $f(x) = e^x - 2x \Rightarrow f'(x) = e^x - 2; f'(x) = 0 \Rightarrow e^x = 2 \Rightarrow x = \ln 2; f(0) = 1, \text{ the absolute maximum;}$
 $f(\ln 2) = 2 - 2 \ln 2 \approx 0.613706, \text{ the absolute minimum; } f(1) = e - 2 \approx 0.71828, \text{ a relative or local maximum}$
 since $f''(x) = e^x$ is always positive.

68. The function $f(x) = 2e^{\sin(x/2)}$ has a maximum whenever $\sin \frac{x}{2} = 1$ and a minimum whenever $\sin \frac{x}{2} = -1$.
 Therefore the maximums occur at $x = \pi + 2k(2\pi)$ and the minimums occur at $x = 3\pi + 2k(2\pi)$, where k is any integer. The maximum is $2e \approx 5.43656$ and the minimum is $\frac{2}{e} \approx 0.73576$.

69. $f(x) = x^2 \ln \frac{1}{x} \Rightarrow f'(x) = 2x \ln \frac{1}{x} + x^2 \left(\frac{1}{x}\right) (-x^{-2}) = 2x \ln \frac{1}{x} - x = -x(2 \ln x + 1); f'(x) = 0 \Rightarrow x = 0 \text{ or}$
 $\ln x = -\frac{1}{2}$. Since $x = 0$ is not in the domain of f , $x = e^{-1/2} = \frac{1}{\sqrt{e}}$. Also, $f'(x) > 0$ for $0 < x < \frac{1}{\sqrt{e}}$ and
 $f'(x) < 0$ for $x > \frac{1}{\sqrt{e}}$. Therefore, $f\left(\frac{1}{\sqrt{e}}\right) = \frac{1}{e} \ln \sqrt{e} = \frac{1}{e} \ln e^{1/2} = \frac{1}{2e} \ln e = \frac{1}{2e}$ is the absolute maximum value
 of f assumed at $x = \frac{1}{\sqrt{e}}$.

70. $f(x) = (x-3)^2 e^x \Rightarrow f'(x) = 2(x-3)e^x + (x-3)^2 e^x$
 $= (x-3)e^x(2+x-3) = (x-1)(x-3)e^x; \text{ thus}$
 $f'(x) > 0$ for $x < 1$ or $x > 3$, and $f'(x) < 0$ for
 $1 < x < 3 \Rightarrow f(1) = 4e \approx 10.87$ is a local maximum and
 $f(3) = 0$ is a local minimum. Since $f(x) \geq 0$ for all x ,
 $f(3) = 0$ is also an absolute minimum.

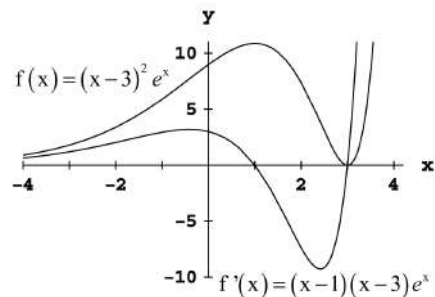

71. $\int_0^{\ln 3} (e^{2x} - e^x) dx = \left[\frac{e^{2x}}{2} - e^x\right]_0^{\ln 3} = \left(\frac{e^{2 \ln 3}}{2} - e^{\ln 3}\right) - \left(\frac{e^0}{2} - e^0\right) = \left(\frac{9}{2} - 3\right) - \left(\frac{1}{2} - 1\right) = \frac{8}{2} - 2 = 2$

72. $\int_0^{2 \ln 2} (e^{x/2} - e^{-x/2}) dx = \left[2e^{x/2} + 2e^{-x/2}\right]_0^{2 \ln 2} = (2e^{\ln 2} + 2e^{-\ln 2}) - (2e^0 + 2e^0) = (4 + 1) - (2 + 2) = 5 - 4 = 1$

73. $L = \int_0^1 \sqrt{1 + \frac{e^x}{4}} dx \Rightarrow \frac{dy}{dx} = \frac{e^{x/2}}{2} \Rightarrow y = e^{x/2} + C; y(0) = 0 \Rightarrow 0 = e^0 + C \Rightarrow C = -1 \Rightarrow y = e^{x/2} - 1$

$$\begin{aligned}
 74. S &= 2\pi \int_0^{\ln 2} \left(\frac{e^y + e^{-y}}{2}\right) \sqrt{1 + \left(\frac{e^y - e^{-y}}{2}\right)^2} dy = 2\pi \int_0^{\ln 2} \left(\frac{e^y + e^{-y}}{2}\right) \sqrt{1 + \frac{1}{4}(e^{2y} - 2 + e^{-2y})} dy \\
 &= 2\pi \int_0^{\ln 2} \left(\frac{e^y + e^{-y}}{2}\right) \sqrt{\left(\frac{e^y + e^{-y}}{2}\right)^2} dy = 2\pi \int_0^{\ln 2} \left(\frac{e^y + e^{-y}}{2}\right)^2 dy = \frac{\pi}{2} \int_0^{\ln 2} (e^{2y} + 2 + e^{-2y}) dy \\
 &= \frac{\pi}{2} \left[\frac{1}{2} e^{2y} + 2y - \frac{1}{2} e^{-2y} \right]_0^{\ln 2} = \frac{\pi}{2} \left[\left(\frac{1}{2} e^{2 \ln 2} + 2 \ln 2 - \frac{1}{2} e^{-2 \ln 2}\right) - \left(\frac{1}{2} + 0 - \frac{1}{2}\right) \right] \\
 &= \frac{\pi}{2} \left(\frac{1}{2} \cdot 4 + 2 \ln 2 - \frac{1}{2} \cdot \frac{1}{4} \right) = \frac{\pi}{2} \left(2 - \frac{1}{8} + 2 \ln 2 \right) = \pi \left(\frac{15}{16} + \ln 2 \right)
 \end{aligned}$$

75. (a) $\frac{d}{dx} (x \ln x - x + C) = x \cdot \frac{1}{x} + \ln x - 1 + 0 = \ln x$

(b) average value $= \frac{1}{e-1} \int_1^e \ln x \, dx = \frac{1}{e-1} [x \ln x - x]_1^e = \frac{1}{e-1} [(e \ln e - e) - (1 \ln 1 - 1)]$
 $= \frac{1}{e-1} (e - e + 1) = \frac{1}{e-1}$

76. average value $= \frac{1}{2-1} \int_1^2 \frac{1}{x} \, dx = [\ln |x|]_1^2 = \ln 2 - \ln 1 = \ln 2$

77. (a) $f(x) = e^x \Rightarrow f'(x) = e^x$; $L(x) = f(0) + f'(0)(x - 0) \Rightarrow L(x) = 1 + x$

(b) $f(0) = 1$ and $L(0) = 1 \Rightarrow$ error $= 0$; $f(0.2) = e^{0.2} \approx 1.22140$ and $L(0.2) = 1.2 \Rightarrow$ error ≈ 0.02140

(c) Since $y'' = e^x > 0$, the tangent line approximation always lies below the curve $y = e^x$.
 Thus $L(x) = x + 1$ never overestimates e^x .

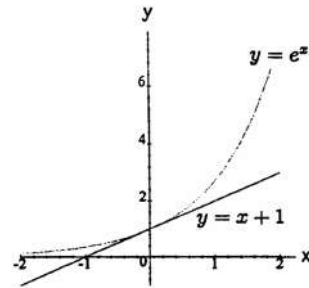

78. (a) $e^x e^{-x} = e^{(x-x)} = e^0 = 1 \Rightarrow e^{-x} = \frac{1}{e^x}$ for all x ; $\frac{e^{x_1}}{e^{x_2}} = e^{x_1} \left(\frac{1}{e^{x_2}}\right) = e^{x_1} e^{-x_2} = e^{x_1 - x_2}$

(b) $y = (e^{x_1})^{x_2} \Rightarrow \ln y = x_2 \ln e^{x_1} = x_2 x_1 = x_1 x_2 \Rightarrow e^{\ln y} = e^{x_1 x_2} \Rightarrow y = e^{x_1 x_2} \Rightarrow (e^{x_1})^{x_2} = e^{x_1 x_2}$

79. $f(x) = \ln(x) - 1 \Rightarrow f'(x) = \frac{1}{x} \Rightarrow x_{n+1} = x_n - \frac{\ln(x_n) - 1}{\left(\frac{1}{x_n}\right)} \Rightarrow x_{n+1} = x_n [2 - \ln(x_n)]$. Then $x_1 = 2$
 $\Rightarrow x_2 = 2.61370564, x_3 = 2.71624393$ and $x_5 = 2.71828183$, where we have used Newton's method.

80. $e^{\ln x} = x$ and $\ln(e^x) = x$ for all $x > 0$

81. Note that $y = \ln x$ and $e^y = x$ are the same curve; $\int_1^a \ln x \, dx =$ area under the curve between 1 and a ;

$\int_0^{\ln a} e^y \, dy =$ area to the left of the curve between 0 and $\ln a$. The sum of these areas is equal to the area of the rectangle
 $\Rightarrow \int_1^a \ln x \, dx + \int_0^{\ln a} e^y \, dy = a \ln a$.

82. (a) $y = e^x \Rightarrow y'' = e^x > 0$ for all $x \Rightarrow$ the graph of $y = e^x$ is always concave upward

(b) area of the trapezoid ABCD $< \int_{\ln a}^{\ln b} e^x \, dx <$ area of the trapezoid AEFD $\Rightarrow \frac{1}{2} (AB + CD)(\ln b - \ln a)$

$< \int_{\ln a}^{\ln b} e^x \, dx < \left(\frac{e^{\ln a} + e^{\ln b}}{2}\right) (\ln b - \ln a)$. Now $\frac{1}{2} (AB + CD)$ is the height of the midpoint

$M = e^{(\ln a + \ln b)/2}$ since the curve containing the points B and C is linear $\Rightarrow e^{(\ln a + \ln b)/2} (\ln b - \ln a)$

$< \int_{\ln a}^{\ln b} e^x \, dx < \left(\frac{e^{\ln a} + e^{\ln b}}{2}\right) (\ln b - \ln a)$

(c) $\int_{\ln a}^{\ln b} e^x \, dx = [e^x]_{\ln a}^{\ln b} = e^{\ln b} - e^{\ln a} = b - a$, so part (b) implies that

$e^{(\ln a + \ln b)/2} (\ln b - \ln a) < b - a < \left(\frac{e^{\ln a} + e^{\ln b}}{2}\right) (\ln b - \ln a) \Rightarrow e^{(\ln a + \ln b)/2} < \frac{b-a}{\ln b - \ln a} < \frac{a+b}{2}$

$\Rightarrow e^{\ln a/2} \cdot e^{\ln b/2} < \frac{b-a}{\ln b - \ln a} < \frac{a+b}{2} \Rightarrow \sqrt{e^{\ln a}} \sqrt{e^{\ln b}} < \frac{b-a}{\ln b - \ln a} < \frac{a+b}{2} \Rightarrow \sqrt{ab} < \frac{b-a}{\ln b - \ln a} < \frac{a+b}{2}$

7.4 a^x and $\log_a x$

1. (a) $5^{\log_5 7} = 7$ (b) $8^{\log_8 \sqrt{2}} = \sqrt{2}$ (c) $1.3^{\log_{1.3} 75} = 75$
 (d) $\log_4 16 = \log_4 4^2 = 2 \log_4 4 = 2 \cdot 1 = 2$ (e) $\log_3 \sqrt{3} = \log_3 3^{1/2} = \frac{1}{2} \log_3 3 = \frac{1}{2} \cdot 1 = \frac{1}{2} = 0.5$
 (f) $\log_4 \left(\frac{1}{4}\right) = \log_4 4^{-1} = -1 \log_4 4 = -1 \cdot 1 = -1$
2. (a) $2^{\log_2 3} = 3$ (b) $10^{\log_{10} (1/2)} = \frac{1}{2}$ (c) $\pi^{\log_\pi 7} = 7$
 (d) $\log_{11} 121 = \log_{11} 11^2 = 2 \log_{11} 11 = 2 \cdot 1 = 2$
 (e) $\log_{121} 11 = \log_{121} 121^{1/2} = \left(\frac{1}{2}\right) \log_{121} 121 = \left(\frac{1}{2}\right) \cdot 1 = \frac{1}{2}$
 (f) $\log_3 \left(\frac{1}{9}\right) = \log_3 3^{-2} = -2 \log_3 3 = -2 \cdot 1 = -2$
3. (a) Let $z = \log_4 x \Rightarrow 4^z = x \Rightarrow 2^{2z} = x \Rightarrow (2^z)^2 = x \Rightarrow 2^z = \sqrt{x}$
 (b) Let $z = \log_3 x \Rightarrow 3^z = x \Rightarrow (3^z)^2 = x^2 \Rightarrow 3^{2z} = x^2 \Rightarrow 9^z = x^2$
 (c) $\log_2 (e^{(\ln 2) \sin x}) = \log_2 2^{\sin x} = \sin x$
4. (a) Let $z = \log_5 (3x^2) \Rightarrow 5^z = 3x^2 \Rightarrow 25^z = 9x^4$
 (b) $\log_e (e^x) = x$
 (c) $\log_4 (2^{e^x \sin x}) = \log_4 4^{(e^x \sin x)/2} = \frac{e^x \sin x}{2}$
5. (a) $\frac{\log_2 x}{\log_3 x} = \frac{\ln x}{\ln 2} \div \frac{\ln x}{\ln 3} = \frac{\ln x}{\ln 2} \cdot \frac{\ln 3}{\ln x} = \frac{\ln 3}{\ln 2}$ (b) $\frac{\log_2 x}{\log_8 x} = \frac{\ln x}{\ln 2} \div \frac{\ln x}{\ln 8} = \frac{\ln x}{\ln 2} \cdot \frac{\ln 8}{\ln x} = \frac{3 \ln 2}{\ln 2} = 3$
 (c) $\frac{\log_x a}{\log_{x^2} a} = \frac{\ln a}{\ln x} \div \frac{\ln a}{\ln x^2} = \frac{\ln a}{\ln x} \cdot \frac{\ln x^2}{\ln a} = \frac{2 \ln x}{\ln x} = 2$
6. (a) $\frac{\log_9 x}{\log_3 x} = \frac{\ln x}{\ln 9} \div \frac{\ln x}{\ln 3} = \frac{\ln x}{2 \ln 3} \cdot \frac{\ln 3}{\ln x} = \frac{1}{2}$
 (b) $\frac{\log_{\sqrt{10}} x}{\log_{\sqrt{2}} x} = \frac{\ln x}{\ln \sqrt{10}} \div \frac{\ln x}{\ln \sqrt{2}} = \frac{\ln x}{(\frac{1}{2}) \ln 10} \cdot \frac{(\frac{1}{2}) \ln 2}{\ln x} = \frac{\ln 2}{\ln 10}$
 (c) $\frac{\log_a b}{\log_b a} = \frac{\ln b}{\ln a} \div \frac{\ln a}{\ln b} = \frac{\ln b}{\ln a} \cdot \frac{\ln b}{\ln a} = \left(\frac{\ln b}{\ln a}\right)^2$
7. $3^{\log_3 (7)} + 2^{\log_2 (5)} = 5^{\log_5 (x)} \Rightarrow 7 + 5 = x \Rightarrow x = 12$
8. $8^{\log_8 (3)} - e^{\ln 5} = x^2 - 7^{\log_7 (3x)} \Rightarrow 3 - 5 = x^2 - 3x \Rightarrow 0 = x^2 - 3x + 2 = (x - 1)(x - 2) \Rightarrow x = 1 \text{ or } x = 2$
9. $3^{\log_3 (x^2)} = 5e^{\ln x} - 3 \cdot 10^{\log_{10} (2)} \Rightarrow x^2 = 5x - 6 \Rightarrow x^2 - 5x + 6 = 0 \Rightarrow (x - 2)(x - 3) = 0 \Rightarrow x = 2 \text{ or } x = 3$
10. $\ln e + 4^{-2 \log_4 (x)} = \frac{1}{x} \log_{10} 100 \Rightarrow 1 + 4^{\log_4 (x^{-2})} = \frac{1}{x} \log_{10} 10^2 \Rightarrow 1 + x^{-2} = \left(\frac{1}{x}\right) (2) \Rightarrow 1 + \frac{1}{x^2} - \frac{2}{x} = 0$
 $\Rightarrow x^2 - 2x + 1 = 0 \Rightarrow (x - 1)^2 = 0 \Rightarrow x = 1$
11. $y = 2^x \Rightarrow y' = 2^x \ln 2$ 12. $y = 3^{-x} \Rightarrow y' = 3^{-x} (\ln 3)(-1) = -3^{-x} \ln 3$
13. $y = 5^{\sqrt{s}} \Rightarrow \frac{dy}{ds} = 5^{\sqrt{s}} (\ln 5) \left(\frac{1}{2} s^{-1/2}\right) = \left(\frac{\ln 5}{2\sqrt{s}}\right) 5^{\sqrt{s}}$
14. $y = 2^{s^2} \Rightarrow \frac{dy}{ds} = 2^{s^2} (\ln 2) 2s = (\ln 2^2) (s 2^{s^2}) = (\ln 4) s 2^{s^2}$
15. $y = x^\pi \Rightarrow y' = \pi x^{(\pi-1)}$ 16. $y = t^{1-e} \Rightarrow \frac{dy}{dt} = (1 - e) t^{-e}$
17. $y = (\cos \theta)^{\sqrt{2}} \Rightarrow \frac{dy}{d\theta} = -\sqrt{2} (\cos \theta)^{(\sqrt{2}-1)} (\sin \theta)$

$$18. y = (\ln \theta)^\pi \Rightarrow \frac{dy}{d\theta} = \pi(\ln \theta)^{(\pi-1)} \left(\frac{1}{\theta}\right) = \frac{\pi(\ln \theta)^{(\pi-1)}}{\theta}$$

$$19. y = 7^{\sec \theta} \ln 7 \Rightarrow \frac{dy}{d\theta} = (7^{\sec \theta} \ln 7)(\ln 7)(\sec \theta \tan \theta) = 7^{\sec \theta} (\ln 7)^2 (\sec \theta \tan \theta)$$

$$20. y = 3^{\tan \theta} \ln 3 \Rightarrow \frac{dy}{d\theta} = (3^{\tan \theta} \ln 3)(\ln 3) \sec^2 \theta = 3^{\tan \theta} (\ln 3)^2 \sec^2 \theta$$

$$21. y = 2^{\sin 3t} \Rightarrow \frac{dy}{dt} = (2^{\sin 3t} \ln 2)(\cos 3t)(3) = (3 \cos 3t) (2^{\sin 3t}) (\ln 2)$$

$$22. y = 5^{-\cos 2t} \Rightarrow \frac{dy}{dt} = (5^{-\cos 2t} \ln 5)(\sin 2t)(2) = (2 \sin 2t) (5^{-\cos 2t}) (\ln 5)$$

$$23. y = \log_2 5\theta = \frac{\ln 5\theta}{\ln 2} \Rightarrow \frac{dy}{d\theta} = \left(\frac{1}{\ln 2}\right) \left(\frac{1}{5\theta}\right) (5) = \frac{1}{\theta \ln 2}$$

$$24. y = \log_3 (1 + \theta \ln 3) = \frac{\ln(1 + \theta \ln 3)}{\ln 3} \Rightarrow \frac{dy}{d\theta} = \left(\frac{1}{\ln 3}\right) \left(\frac{1}{1 + \theta \ln 3}\right) (\ln 3) = \frac{1}{1 + \theta \ln 3}$$

$$25. y = \frac{\ln x}{\ln 4} + \frac{\ln x^2}{\ln 4} = \frac{\ln x}{\ln 4} + 2 \frac{\ln x}{\ln 4} = 3 \frac{\ln x}{\ln 4} \Rightarrow y' = \frac{3}{x \ln 4}$$

$$26. y = \frac{x \ln e}{\ln 25} - \frac{\ln x}{2 \ln 5} = \frac{x}{2 \ln 5} - \frac{\ln x}{2 \ln 5} = \left(\frac{1}{2 \ln 5}\right) (x - \ln x) \Rightarrow y' = \left(\frac{1}{2 \ln 5}\right) \left(1 - \frac{1}{x}\right) = \frac{x-1}{2x \ln 5}$$

$$27. y = \log_2 r \cdot \log_4 r = \left(\frac{\ln r}{\ln 2}\right) \left(\frac{\ln r}{\ln 4}\right) = \frac{\ln^2 r}{(\ln 2)(\ln 4)} \Rightarrow \frac{dy}{dr} = \left[\frac{1}{(\ln 2)(\ln 4)}\right] (2 \ln r) \left(\frac{1}{r}\right) = \frac{2 \ln r}{r(\ln 2)(\ln 4)}$$

$$28. y = \log_3 r \cdot \log_9 r = \left(\frac{\ln r}{\ln 3}\right) \left(\frac{\ln r}{\ln 9}\right) = \frac{\ln^2 r}{(\ln 3)(\ln 9)} \Rightarrow \frac{dy}{dr} = \left[\frac{1}{(\ln 3)(\ln 9)}\right] (2 \ln r) \left(\frac{1}{r}\right) = \frac{2 \ln r}{r(\ln 3)(\ln 9)}$$

$$29. y = \log_3 \left(\left(\frac{x+1}{x-1}\right)^{\ln 3} \right) = \frac{\ln \left(\frac{x+1}{x-1}\right)^{\ln 3}}{\ln 3} = \frac{(\ln 3) \ln \left(\frac{x+1}{x-1}\right)}{\ln 3} = \ln \left(\frac{x+1}{x-1}\right) = \ln(x+1) - \ln(x-1)$$

$$\Rightarrow \frac{dy}{dx} = \frac{1}{x+1} - \frac{1}{x-1} = \frac{-2}{(x+1)(x-1)}$$

$$30. y = \log_5 \sqrt{\left(\frac{7x}{3x+2}\right)^{\ln 5}} = \log_5 \left(\frac{7x}{3x+2}\right)^{(\ln 5)/2} = \frac{\ln \left(\frac{7x}{3x+2}\right)^{(\ln 5)/2}}{\ln 5} = \left(\frac{\ln 5}{2}\right) \left[\frac{\ln \left(\frac{7x}{3x+2}\right)}{\ln 5}\right] = \frac{1}{2} \ln \left(\frac{7x}{3x+2}\right)$$

$$= \frac{1}{2} \ln 7x - \frac{1}{2} \ln(3x+2) \Rightarrow \frac{dy}{dx} = \frac{7}{2 \cdot 7x} - \frac{3}{2 \cdot (3x+2)} = \frac{(3x+2) - 3x}{2x(3x+2)} = \frac{1}{x(3x+2)}$$

$$31. y = \theta \sin(\log_7 \theta) = \theta \sin\left(\frac{\ln \theta}{\ln 7}\right) \Rightarrow \frac{dy}{d\theta} = \sin\left(\frac{\ln \theta}{\ln 7}\right) + \theta \left[\cos\left(\frac{\ln \theta}{\ln 7}\right)\right] \left(\frac{1}{\theta \ln 7}\right) = \sin(\log_7 \theta) + \frac{1}{\ln 7} \cos(\log_7 \theta)$$

$$32. y = \log_7 \left(\frac{\sin \theta \cos \theta}{e^\theta 2^\theta}\right) = \frac{\ln(\sin \theta) + \ln(\cos \theta) - \ln e^\theta - \ln 2^\theta}{\ln 7} = \frac{\ln(\sin \theta) + \ln(\cos \theta) - \theta - \theta \ln 2}{\ln 7}$$

$$\Rightarrow \frac{dy}{d\theta} = \frac{\cos \theta}{(\sin \theta)(\ln 7)} - \frac{\sin \theta}{(\cos \theta)(\ln 7)} - \frac{1}{\ln 7} - \frac{\ln 2}{\ln 7} = \left(\frac{1}{\ln 7}\right) (\cot \theta - \tan \theta - 1 - \ln 2)$$

$$33. y = \log_5 e^x = \frac{\ln e^x}{\ln 5} = \frac{x}{\ln 5} \Rightarrow y' = \frac{1}{\ln 5}$$

$$34. y = \log_2 \left(\frac{x^2 e^2}{2\sqrt{x+1}}\right) = \frac{\ln x^2 + \ln e^2 - \ln 2 - \ln \sqrt{x+1}}{\ln 2} = \frac{2 \ln x + 2 - \ln 2 - \frac{1}{2} \ln(x+1)}{\ln 2}$$

$$\Rightarrow y' = \frac{2}{x \ln 2} - \frac{1}{2(\ln 2)(x+1)} = \frac{4(x+1) - x}{2x(x+1)(\ln 2)} = \frac{3x+4}{2x(x+1) \ln 2}$$

$$35. y = 3^{\log_2 t} = 3^{(\ln t)/(\ln 2)} \Rightarrow \frac{dy}{dt} = [3^{(\ln t)/(\ln 2)} (\ln 3)] \left(\frac{1}{t \ln 2}\right) = \frac{1}{t} (\log_2 3) 3^{\log_2 t}$$

$$36. y = 3 \log_8 (\log_2 t) = \frac{3 \ln(\log_2 t)}{\ln 8} = \frac{3 \ln \left(\frac{\ln t}{\ln 2}\right)}{\ln 8} \Rightarrow \frac{dy}{dt} = \left(\frac{3}{\ln 8}\right) \left[\frac{1}{(\ln t)(\ln 2)}\right] \left(\frac{1}{t \ln 2}\right) = \frac{3}{t(\ln t)(\ln 8)}$$

$$= \frac{1}{t(\ln t)(\ln 2)}$$

$$37. y = \log_2 (8t^{\ln 2}) = \frac{\ln 8 + \ln(t^{\ln 2})}{\ln 2} = \frac{3 \ln 2 + (\ln 2)(\ln t)}{\ln 2} = 3 + \ln t \Rightarrow \frac{dy}{dt} = \frac{1}{t}$$

$$38. y = \frac{t \ln((e^{\ln 3})^{\sin t})}{\ln 3} = \frac{t \ln(3^{\sin t})}{\ln 3} = \frac{t(\sin t)(\ln 3)}{\ln 3} = t \sin t \Rightarrow \frac{dy}{dt} = \sin t + t \cos t$$

$$39. y = (x+1)^x \Rightarrow \ln y = \ln(x+1)^x = x \ln(x+1) \Rightarrow \frac{y'}{y} = \ln(x+1) + x \cdot \frac{1}{(x+1)} \Rightarrow y' = (x+1)^x \left[\frac{x}{x+1} + \ln(x+1) \right]$$

$$40. y = x^{(x+1)} \Rightarrow \ln y = \ln x^{(x+1)} = (x+1) \ln x \Rightarrow \frac{y'}{y} = \ln x + (x+1) \left(\frac{1}{x} \right) = \ln x + 1 + \frac{1}{x} \\ \Rightarrow y' = x^{(x+1)} \left(1 + \frac{1}{x} + \ln x \right)$$

$$41. y = (\sqrt{t})^t = (t^{1/2})^t = t^{t/2} \Rightarrow \ln y = \ln t^{t/2} = \left(\frac{1}{2} \right) \ln t \Rightarrow \frac{1}{y} \frac{dy}{dt} = \left(\frac{1}{2} \right) (\ln t) + \left(\frac{1}{2} \right) \left(\frac{1}{t} \right) = \frac{\ln t}{2} + \frac{1}{2} \\ \Rightarrow \frac{dy}{dt} = (\sqrt{t})^t \left(\frac{\ln t}{2} + \frac{1}{2} \right)$$

$$42. y = t^{\sqrt{t}} = t^{(t^{1/2})} \Rightarrow \ln y = \ln t^{(t^{1/2})} = (t^{1/2}) (\ln t) \Rightarrow \frac{1}{y} \frac{dy}{dt} = \left(\frac{1}{2} t^{-1/2} \right) (\ln t) + t^{1/2} \left(\frac{1}{t} \right) = \frac{\ln t + 2}{2\sqrt{t}} \\ \Rightarrow \frac{dy}{dt} = \left(\frac{\ln t + 2}{2\sqrt{t}} \right) t^{\sqrt{t}}$$

$$43. y = (\sin x)^x \Rightarrow \ln y = \ln(\sin x)^x = x \ln(\sin x) \Rightarrow \frac{y'}{y} = \ln(\sin x) + x \left(\frac{\cos x}{\sin x} \right) \Rightarrow y' = (\sin x)^x [\ln(\sin x) + x \cot x]$$

$$44. y = x^{\sin x} \Rightarrow \ln y = \ln x^{\sin x} = (\sin x)(\ln x) \Rightarrow \frac{y'}{y} = (\cos x)(\ln x) + (\sin x) \left(\frac{1}{x} \right) = \frac{\sin x + x(\ln x)(\cos x)}{x} \\ \Rightarrow y' = x^{\sin x} \left[\frac{\sin x + x(\ln x)(\cos x)}{x} \right]$$

$$45. y = x^{\ln x}, x > 0 \Rightarrow \ln y = (\ln x)^2 \Rightarrow \frac{y'}{y} = 2(\ln x) \left(\frac{1}{x} \right) \Rightarrow y' = (x^{\ln x}) \left(\frac{\ln x^2}{x} \right)$$

$$46. y = (\ln x)^{\ln x} \Rightarrow \ln y = (\ln x) \ln(\ln x) \Rightarrow \frac{y'}{y} = \left(\frac{1}{x} \right) \ln(\ln x) + (\ln x) \left(\frac{1}{\ln x} \right) \frac{d}{dx} (\ln x) = \frac{\ln(\ln x)}{x} + \frac{1}{x} \\ \Rightarrow y' = \left(\frac{\ln(\ln x) + 1}{x} \right) (\ln x)^{\ln x}$$

$$47. \int 5^x dx = \frac{5^x}{\ln 5} + C$$

$$48. \int (1.3)^x dx = \frac{(1.3)^x}{\ln(1.3)} + C$$

$$49. \int_0^1 2^{-\theta} d\theta = \int_0^1 \left(\frac{1}{2} \right)^\theta d\theta = \left[\frac{\left(\frac{1}{2} \right)^\theta}{\ln \left(\frac{1}{2} \right)} \right]_0^1 = \frac{\frac{1}{2}}{\ln \left(\frac{1}{2} \right)} - \frac{1}{\ln \left(\frac{1}{2} \right)} = -\frac{\frac{1}{2}}{\ln \left(\frac{1}{2} \right)} = \frac{-1}{2(\ln 1 - \ln 2)} = \frac{1}{2 \ln 2}$$

$$50. \int_{-2}^0 5^{-\theta} d\theta = \int_{-2}^0 \left(\frac{1}{5} \right)^\theta d\theta = \left[\frac{\left(\frac{1}{5} \right)^\theta}{\ln \left(\frac{1}{5} \right)} \right]_{-2}^0 = \frac{1}{\ln \left(\frac{1}{5} \right)} - \frac{\left(\frac{1}{5} \right)^{-2}}{\ln \left(\frac{1}{5} \right)} = \frac{1}{\ln \left(\frac{1}{5} \right)} (1 - 25) = \frac{-24}{\ln 1 - \ln 5} = \frac{24}{\ln 5}$$

$$51. \text{Let } u = x^2 \Rightarrow du = 2x dx \Rightarrow \frac{1}{2} du = x dx; x = 1 \Rightarrow u = 1, x = \sqrt{2} \Rightarrow u = 2;$$

$$\int_1^{\sqrt{2}} x 2^{(x^2)} dx = \int_1^2 \left(\frac{1}{2} \right) 2^u du = \frac{1}{2} \left[\frac{2^u}{\ln 2} \right]_1^2 = \left(\frac{1}{2 \ln 2} \right) (2^2 - 2^1) = \frac{1}{\ln 2}$$

$$52. \text{Let } u = x^{1/2} \Rightarrow du = \frac{1}{2} x^{-1/2} dx \Rightarrow 2 du = \frac{dx}{\sqrt{x}}; x = 1 \Rightarrow u = 1, x = 4 \Rightarrow u = 2;$$

$$\int_1^4 \frac{2\sqrt{x}}{\sqrt{x}} dx = \int_1^4 2x^{1/2} \cdot x^{-1/2} dx = 2 \int_1^2 2^u du = \left[\frac{2^{(u+1)}}{\ln 2} \right]_1^2 = \left(\frac{1}{\ln 2} \right) (2^3 - 2^2) = \frac{4}{\ln 2}$$

53. Let $u = \cos t \Rightarrow du = -\sin t dt \Rightarrow -du = \sin t dt$; $t = 0 \Rightarrow u = 1$, $t = \frac{\pi}{2} \Rightarrow u = 0$;

$$\int_0^{\pi/2} 7^{\cos t} \sin t dt = -\int_1^0 7^u du = \left[-\frac{7^u}{\ln 7}\right]_1^0 = \left(\frac{-1}{\ln 7}\right)(7^0 - 7) = \frac{6}{\ln 7}$$

54. Let $u = \tan t \Rightarrow du = \sec^2 t dt$; $t = 0 \Rightarrow u = 0$, $t = \frac{\pi}{4} \Rightarrow u = 1$;

$$\int_0^{\pi/4} \left(\frac{1}{3}\right)^{\tan t} \sec^2 t dt = \int_0^1 \left(\frac{1}{3}\right)^u du = \left[\frac{\left(\frac{1}{3}\right)^u}{\ln\left(\frac{1}{3}\right)}\right]_0^1 = \left(-\frac{1}{\ln 3}\right)\left[\left(\frac{1}{3}\right)^1 - \left(\frac{1}{3}\right)^0\right] = \frac{2}{3 \ln 3}$$

55. Let $u = x^{2x} \Rightarrow \ln u = 2x \ln x \Rightarrow \frac{1}{u} \frac{du}{dx} = 2 \ln x + (2x) \left(\frac{1}{x}\right) \Rightarrow \frac{du}{dx} = 2u(\ln x + 1) \Rightarrow \frac{1}{2} du = x^{2x}(1 + \ln x) dx$;
 $x = 2 \Rightarrow u = 2^4 = 16$, $x = 4 \Rightarrow u = 4^8 = 65,536$;

$$\int_2^4 x^{2x}(1 + \ln x) dx = \frac{1}{2} \int_{16}^{65,536} du = \frac{1}{2} [u]_{16}^{65,536} = \frac{1}{2} (65,536 - 16) = \frac{65,520}{2} = 32,760$$

56. Let $u = \ln x \Rightarrow du = \frac{1}{x} dx$; $x = 1 \Rightarrow u = 0$, $x = 2 \Rightarrow u = \ln 2$;

$$\int_1^2 \frac{2^{\ln x}}{x} dx = \int_0^{\ln 2} 2^u du = \left[\frac{2^u}{\ln 2}\right]_0^{\ln 2} = \left(\frac{1}{\ln 2}\right)(2^{\ln 2} - 2^0) = \frac{2^{\ln 2} - 1}{\ln 2}$$

$$57. \int 3x^{\sqrt{3}+1} dx = \frac{3x^{(\sqrt{3}+2)}}{\sqrt{3}+2} + C$$

$$58. \int x^{(\sqrt{2}-1)} dx = \frac{x^{\sqrt{2}}}{\sqrt{2}} + C$$

$$59. \int_0^3 (\sqrt{2} + 1) x^{\sqrt{2}} dx = \left[x^{(\sqrt{2}+1)}\right]_0^3 = 3^{(\sqrt{2}+1)}$$

$$60. \int_1^e x^{(\ln 2)-1} dx = \left[\frac{x^{\ln 2}}{\ln 2}\right]_1^e = \frac{e^{\ln 2} - 1^{\ln 2}}{\ln 2} = \frac{2-1}{\ln 2} = \frac{1}{\ln 2}$$

$$61. \int \frac{\log_{10} x}{x} dx = \int \left(\frac{\ln x}{\ln 10}\right) \left(\frac{1}{x}\right) dx; [u = \ln x \Rightarrow du = \frac{1}{x} dx]$$

$$\rightarrow \int \left(\frac{\ln x}{\ln 10}\right) \left(\frac{1}{x}\right) dx = \frac{1}{\ln 10} \int u du = \left(\frac{1}{\ln 10}\right) \left(\frac{1}{2} u^2\right) + C = \frac{(\ln x)^2}{2 \ln 10} + C$$

$$62. \int_1^4 \frac{\log_2 x}{x} dx = \int_1^4 \left(\frac{\ln x}{\ln 2}\right) \left(\frac{1}{x}\right) dx; [u = \ln x \Rightarrow du = \frac{1}{x} dx; x = 1 \Rightarrow u = 0, x = 4 \Rightarrow u = \ln 4]$$

$$\rightarrow \int_1^4 \left(\frac{\ln x}{\ln 2}\right) \left(\frac{1}{x}\right) dx = \int_0^{\ln 4} \left(\frac{1}{\ln 2}\right) u du = \left(\frac{1}{\ln 2}\right) \left[\frac{1}{2} u^2\right]_0^{\ln 4} = \left(\frac{1}{\ln 2}\right) \left[\frac{1}{2} (\ln 4)^2\right] = \frac{(\ln 4)^2}{2 \ln 2} = \frac{(\ln 4)^2}{\ln 4} = \ln 4$$

$$63. \int_1^4 \frac{\ln 2 \log_2 x}{x} dx = \int_1^4 \left(\frac{\ln 2}{\ln 2}\right) \left(\frac{\ln x}{\ln 2}\right) dx = \int_1^4 \frac{\ln x}{x} dx = \left[\frac{1}{2} (\ln x)^2\right]_1^4 = \frac{1}{2} [(\ln 4)^2 - (\ln 1)^2] = \frac{1}{2} (\ln 4)^2 = \frac{1}{2} (2 \ln 2)^2 = 2(\ln 2)^2$$

$$64. \int_1^e \frac{2 \ln 10 (\log_{10} x)}{x} dx = \int_1^e \frac{(\ln 10)(2 \ln x)}{(\ln 10)} \left(\frac{1}{x}\right) dx = [(\ln x)^2]_1^e = (\ln e)^2 - (\ln 1)^2 = 1$$

$$65. \int_0^2 \frac{\log_2 (x+2)}{x+2} dx = \frac{1}{\ln 2} \int_0^2 [\ln (x+2)] \left(\frac{1}{x+2}\right) dx = \left(\frac{1}{\ln 2}\right) \left[\frac{(\ln (x+2))^2}{2}\right]_0^2 = \left(\frac{1}{\ln 2}\right) \left[\frac{(\ln 4)^2}{2} - \frac{(\ln 2)^2}{2}\right] = \left(\frac{1}{\ln 2}\right) \left[\frac{4(\ln 2)^2}{2} - \frac{(\ln 2)^2}{2}\right] = \frac{3}{2} \ln 2$$

$$66. \int_{1/10}^{10} \frac{\log_{10} (10x)}{x} dx = \frac{10}{\ln 10} \int_{1/10}^{10} [\ln (10x)] \left(\frac{1}{10x}\right) dx = \left(\frac{10}{\ln 10}\right) \left[\frac{(\ln (10x))^2}{20}\right]_{1/10}^{10} = \left(\frac{10}{\ln 10}\right) \left[\frac{(\ln 100)^2}{20} - \frac{(\ln 1)^2}{2}\right] = \left(\frac{10}{\ln 10}\right) \left[\frac{4(\ln 10)^2}{20}\right] = 2 \ln 10$$

$$67. \int_0^9 \frac{2 \log_{10} (x+1)}{x+1} dx = \frac{2}{\ln 10} \int_0^9 \ln (x+1) \left(\frac{1}{x+1}\right) dx = \left(\frac{2}{\ln 10}\right) \left[\frac{(\ln (x+1))^2}{2}\right]_0^9 = \left(\frac{2}{\ln 10}\right) \left[\frac{(\ln 10)^2}{2} - \frac{(\ln 1)^2}{2}\right] = \ln 10$$

$$68. \int_2^3 \frac{2 \log_2 (x-1)}{x-1} dx = \frac{2}{\ln 2} \int_2^3 \ln (x-1) \left(\frac{1}{x-1}\right) dx = \left(\frac{2}{\ln 2}\right) \left[\frac{(\ln (x-1))^2}{2}\right]_2^3 = \left(\frac{2}{\ln 2}\right) \left[\frac{(\ln 2)^2}{2} - \frac{(\ln 1)^2}{2}\right] = \ln 2$$

$$69. \int \frac{dx}{x \log_{10} x} = \int \left(\frac{\ln 10}{\ln x} \right) \left(\frac{1}{x} \right) dx = (\ln 10) \int \left(\frac{1}{\ln x} \right) \left(\frac{1}{x} \right) dx; [u = \ln x \Rightarrow du = \frac{1}{x} dx]$$

$$\rightarrow (\ln 10) \int \left(\frac{1}{\ln x} \right) \left(\frac{1}{x} \right) dx = (\ln 10) \int \frac{1}{u} du = (\ln 10) \ln |u| + C = (\ln 10) \ln |\ln x| + C$$

$$70. \int \frac{dx}{x(\log_8 x)^2} = \int \frac{dx}{x \left(\frac{\ln x}{\ln 8} \right)^2} = (\ln 8)^2 \int \frac{(\ln x)^{-2}}{x} dx = (\ln 8)^2 \frac{(\ln x)^{-1}}{-1} + C = -\frac{(\ln 8)^2}{\ln x} + C$$

$$71. \int_1^{\ln x} \frac{1}{t} dt = [\ln |t|]_1^{\ln x} = \ln |\ln x| - \ln 1 = \ln (\ln x), x > 1$$

$$72. \int_1^{e^x} \frac{1}{t} dt = [\ln |t|]_1^{e^x} = \ln e^x - \ln 1 = x \ln e = x$$

$$73. \int_1^{1/x} \frac{1}{t} dt = [\ln |t|]_1^{1/x} = \ln \left| \frac{1}{x} \right| - \ln 1 = (\ln 1 - \ln |x|) - \ln 1 = -\ln x, x > 0$$

$$74. \frac{1}{\ln a} \int_1^x \frac{1}{t} dt = \left[\frac{1}{\ln a} \ln |t| \right]_1^x = \frac{\ln x}{\ln a} - \frac{\ln 1}{\ln a} = \log_a x, x > 0$$

$$75. A = \int_{-2}^2 \frac{2x}{1+x^2} dx = 2 \int_0^2 \frac{2x}{1+x^2} dx; [u = 1+x^2 \Rightarrow du = 2x dx; x=0 \Rightarrow u=1, x=2 \Rightarrow u=5]$$

$$\rightarrow A = 2 \int_1^5 \frac{1}{u} du = 2 [\ln |u|]_1^5 = 2(\ln 5 - \ln 1) = 2 \ln 5$$

$$76. A = \int_{-1}^1 2^{(1-x)} dx = 2 \int_{-1}^1 \left(\frac{1}{2} \right)^x dx = 2 \left[\frac{\left(\frac{1}{2} \right)^x}{\ln \left(\frac{1}{2} \right)} \right]_{-1}^1 = -\frac{2}{\ln 2} \left(\frac{1}{2} - 2 \right) = \left(-\frac{2}{\ln 2} \right) \left(-\frac{3}{2} \right) = \frac{3}{\ln 2}$$

77. Let $[\text{H}_3\text{O}^+] = x$ and solve the equations $7.37 = -\log_{10} x$ and $7.44 = -\log_{10} x$. The solutions of these equations are $10^{-7.37}$ and $10^{-7.44}$. Consequently, the bounds for $[\text{H}_3\text{O}^+]$ are $[10^{-7.44}, 10^{-7.37}]$.

$$78. \text{pH} = -\log_{10} (4.8 \times 10^{-8}) = -(\log_{10} 4.8) + 8 = 7.32$$

79. Let O = original sound level = $10 \log_{10} (I \times 10^{12})$ db from Equation (6) in the text. Solving $O + 10 = 10 \log_{10} (kI \times 10^{12})$ for $k \Rightarrow 10 \log_{10} (I \times 10^{12}) + 10 = 10 \log_{10} (kI \times 10^{12}) \Rightarrow \log_{10} (I \times 10^{12}) + 1 = \log_{10} (kI \times 10^{12}) \Rightarrow \log_{10} (I \times 10^{12}) + 1 = \log_{10} k + \log_{10} (I \times 10^{12}) \Rightarrow 1 = \log_{10} k \Rightarrow 1 = \frac{\ln k}{\ln 10} \Rightarrow \ln k = \ln 10 \Rightarrow k = 10$

80. Sound level with $10I = 10 \log_{10} (10I \times 10^{12}) = 10 [\log_{10} 10 + \log_{10} (I \times 10^{12})] = 10 + 10 \log_{10} (I \times 10^{12})$
= original sound level + 10 \Rightarrow an increase of 10 db

81. (a) If $x = [\text{H}_3\text{O}^+]$ and $S - x = [\text{OH}^-]$, then $x(S - x) = 10^{-14} \Rightarrow S = x + \frac{10^{-14}}{x} \Rightarrow \frac{dS}{dx} = 1 - \frac{10^{-14}}{x^2}$
and $\frac{d^2S}{dx^2} = \frac{2 \cdot 10^{-14}}{x^3} > 0 \Rightarrow$ a minimum exists at $x = 10^{-7}$

(b) $\text{pH} = -\log_{10} (10^{-7}) = 7$

(c) $\frac{[\text{OH}^-]}{[\text{H}_3\text{O}^+]} = \frac{S-x}{x} = \frac{\left(x + \frac{10^{-14}}{x}\right) - x}{x} = \frac{10^{-14}}{x^2} \Rightarrow$ the ratio $\frac{[\text{OH}^-]}{[\text{H}_3\text{O}^+]}$ equals 1 at $x = 10^{-7}$

82. Yes, it's true for all positive values of a and b : $\log_a b = \frac{\ln b}{\ln a}$ and $\log_b a = \frac{\ln a}{\ln b} \Rightarrow \frac{1}{\log_b a} = \frac{\ln b}{\ln a} = \log_a b$

83. From zooming in on the graph at the right, we estimate the third root to be $x \approx -0.76666$

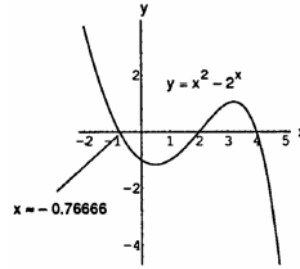

84. The functions $f(x) = x^{\ln 2}$ and $g(x) = 2^{\ln x}$ appear to have identical graphs for $x > 0$. This is no accident, because $x^{\ln 2} = e^{\ln 2 \cdot \ln x} = (e^{\ln 2})^{\ln x} = 2^{\ln x}$.

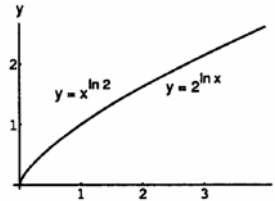

85. (a) $f(x) = 2^x \Rightarrow f'(x) = 2^x \ln 2$; $L(x) = (2^0 \ln 2)x + 2^0 = x \ln 2 + 1 \approx 0.69x + 1$
 (b)

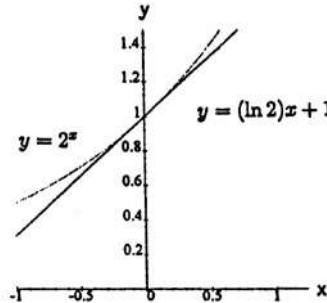
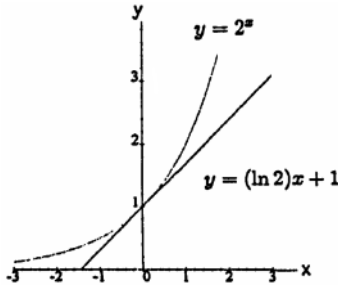

86. (a) $f(x) = \log_3 x \Rightarrow f'(x) = \frac{1}{x \ln 3}$, and $f(3) = \frac{\ln 3}{\ln 3} \Rightarrow L(x) = \frac{1}{3 \ln 3} (x - 3) + \frac{\ln 3}{\ln 3} = \frac{x}{3 \ln 3} - \frac{1}{\ln 3} + 1 \approx 0.30x + 0.09$
 (b)

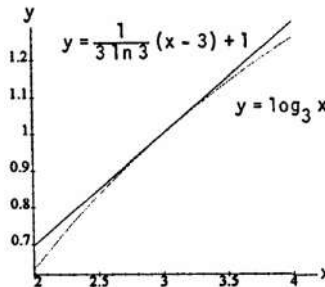
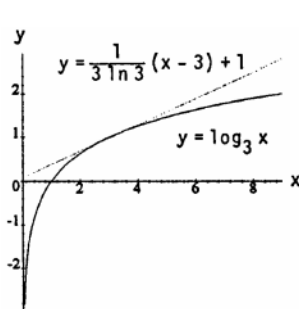

87. (a) $\log_3 8 = \frac{\ln 8}{\ln 3} \approx 1.89279$

(b) $\log_7 0.5 = \frac{\ln 0.5}{\ln 7} \approx -0.35621$

(c) $\log_{20} 17 = \frac{\ln 17}{\ln 20} \approx 0.94575$

(d) $\log_{0.5} 7 = \frac{\ln 7}{\ln 0.5} \approx -2.80735$

(e) $\ln x = (\log_{10} x)(\ln 10) = 2.3 \ln 10 \approx 5.29595$

(f) $\ln x = (\log_2 x)(\ln 2) = 1.4 \ln 2 \approx 0.97041$

(g) $\ln x = (\log_2 x)(\ln 2) = -1.5 \ln 2 \approx -1.03972$

(h) $\ln x = (\log_{10} x)(\ln 10) = -0.7 \ln 10 \approx -1.61181$

88. (a) $\frac{\ln 10}{\ln 2} \cdot \log_{10} x = \frac{\ln 10}{\ln 2} \cdot \frac{\ln x}{\ln 10} = \frac{\ln x}{\ln 2} = \log_2 x$

(b) $\frac{\ln a}{\ln b} \cdot \log_a x = \frac{\ln a}{\ln b} \cdot \frac{\ln x}{\ln a} = \frac{\ln x}{\ln b} = \log_b x$

89. $\frac{d}{dx} \left(-\frac{1}{2}x^2 + k \right) = -x$ and $\frac{d}{dx} (\ln x + c) = \frac{1}{x}$.

Since $-x \cdot \frac{1}{x} = -1$ for any $x \neq 0$, these two curves will have perpendicular tangent lines.

90. $e^{\ln x} = x$ for $x > 0$ and $\ln(e^x) = x$ for all x

91. Using Newton's Method: $f(x) = \ln(x) - 1 \Rightarrow f'(x) = \frac{1}{x} \Rightarrow x_{n+1} = x_n - \frac{\ln(x_n) - 1}{\frac{1}{x_n}} \Rightarrow x_{n+1} = x_n \left[2 - \ln(x_n) \right]$.
Then, $x_1 = 2$, $x_2 = 2.61370564$, $x_3 = 2.71624393$, and $x_5 = 2.71828183$. Many other methods may be used. For example, graph $y = \ln x - 1$ and determine the zero of y .
92. (a) The point of tangency is $(p, \ln p)$ and $m_{\text{tangent}} = \frac{1}{p}$ since $\frac{dy}{dx} = \frac{1}{x}$. The tangent line passes through $(0, 0) \Rightarrow$ the equation of the tangent line is $y = \frac{1}{p}x$. The tangent line also passes through $(p, \ln p) \Rightarrow \ln p = \frac{1}{p}p = 1 \Rightarrow p = e$, and the tangent line equation is $y = \frac{1}{e}x$.
- (b) $\frac{d^2y}{dx^2} = -\frac{1}{x^2}$ for $x \neq 0 \Rightarrow y = \ln x$ is concave downward over its domain. Therefore, $y = \ln x$ lies below the graph of $y = \frac{1}{e}x$ for all $x > 0$, $x \neq e$, and $\ln x < \frac{x}{e}$ for $x > 0$, $x \neq e$.
- (c) Multiplying by e , $e \ln x < x$ or $\ln x^e < x$.
- (d) Exponentiating both sides of $\ln x^e < x$, we have $e^{\ln x^e} < e^x$, or $x^e < e^x$ for all positive $x \neq e$.
- (e) Let $x = \pi$ to see that $\pi^e < e^\pi$. Therefore, e^π is bigger.

7.5 EXPONENTIAL GROWTH AND DECAY

1. (a) $y = y_0 e^{kt} \Rightarrow 0.99y_0 = y_0 e^{1000k} \Rightarrow k = \frac{\ln 0.99}{1000} \approx -0.00001$
 (b) $0.9 = e^{(-0.00001)t} \Rightarrow (-0.00001)t = \ln(0.9) \Rightarrow t = \frac{\ln(0.9)}{-0.00001} \approx 10,536$ years
 (c) $y = y_0 e^{(20,000)k} \approx y_0 e^{-0.2} = y_0(0.82) \Rightarrow 82\%$
2. (a) $\frac{dp}{dh} = kp \Rightarrow p = p_0 e^{kh}$ where $p_0 = 1013$; $90 = 1013e^{20k} \Rightarrow k = \frac{\ln(90) - \ln(1013)}{20} \approx -0.121$
 (b) $p = 1013e^{-6.05} \approx 2.389$ millibars
 (c) $900 = 1013e^{(-0.121)h} \Rightarrow -0.121h = \ln\left(\frac{900}{1013}\right) \Rightarrow h = \frac{\ln(1013) - \ln(900)}{0.121} \approx 0.977$ km
3. $\frac{dy}{dt} = -0.6y \Rightarrow y = y_0 e^{-0.6t}$; $y_0 = 100 \Rightarrow y = 100e^{-0.6t} \Rightarrow y = 100e^{-0.6} \approx 54.88$ grams when $t = 1$ hr
4. $A = A_0 e^{kt} \Rightarrow 800 = 1000e^{10k} \Rightarrow k = \frac{\ln(0.8)}{10} \Rightarrow A = 1000e^{(\ln(0.8)/10)t}$, where A represents the amount of sugar that remains after time t . Thus after another 14 hrs, $A = 1000e^{(\ln(0.8)/10)24} \approx 585.35$ kg
5. $L(x) = L_0 e^{-kx} \Rightarrow \frac{L_0}{2} = L_0 e^{-18k} \Rightarrow \ln \frac{1}{2} = -18k \Rightarrow k = \frac{\ln 2}{18} \approx 0.0385 \Rightarrow L(x) = L_0 e^{-0.0385x}$; when the intensity is one-tenth of the surface value, $\frac{L_0}{10} = L_0 e^{-0.0385x} \Rightarrow \ln 10 = 0.0385x \Rightarrow x \approx 59.8$ ft
6. $V(t) = V_0 e^{-t/40} \Rightarrow 0.1V_0 = V_0 e^{-t/40}$ when the voltage is 10% of its original value $\Rightarrow t = -40 \ln(0.1) \approx 92.1$ sec
7. $y = y_0 e^{kt}$ and $y_0 = 1 \Rightarrow y = e^{kt} \Rightarrow$ at $y = 2$ and $t = 0.5$ we have $2 = e^{0.5k} \Rightarrow \ln 2 = 0.5k \Rightarrow k = \frac{\ln 2}{0.5} = \ln 4$.
Therefore, $y = e^{(\ln 4)t} \Rightarrow y = e^{24 \ln 4} = 4^{24} = 2.81474978 \times 10^{14}$ at the end of 24 hrs
8. $y = y_0 e^{kt}$ and $y(3) = 10,000 \Rightarrow 10,000 = y_0 e^{3k}$; also $y(5) = 40,000 = y_0 e^{5k}$. Therefore $y_0 e^{5k} = 4y_0 e^{3k} \Rightarrow e^{5k} = 4e^{3k} \Rightarrow e^{2k} = 4 \Rightarrow k = \ln 2$. Thus, $y = y_0 e^{(\ln 2)t} \Rightarrow 10,000 = y_0 e^{3 \ln 2} = y_0 e^{\ln 8} \Rightarrow 10,000 = 8y_0 \Rightarrow y_0 = \frac{10,000}{8} = 1250$
9. (a) $10,000e^{k(1)} = 7500 \Rightarrow e^k = 0.75 \Rightarrow k = \ln 0.75$ and $y = 10,000e^{(\ln 0.75)t}$. Now $1000 = 10,000e^{(\ln 0.75)t} \Rightarrow \ln 0.1 = (\ln 0.75)t \Rightarrow t = \frac{\ln 0.1}{\ln 0.75} \approx 8.00$ years (to the nearest hundredth of a year)
 (b) $1 = 10,000e^{(\ln 0.75)t} \Rightarrow \ln 0.0001 = (\ln 0.75)t \Rightarrow t = \frac{\ln 0.0001}{\ln 0.75} \approx 32.02$ years (to the nearest hundredth of a year)

10. (a) There are $(60)(60)(24)(365) = 31,536,000$ seconds in a year. Thus, assuming exponential growth,

$$P = 257,313,431e^{kt} \text{ and } 257,313,432 = 257,313,431e^{(14k/31,536,000)} \Rightarrow \ln\left(\frac{257,313,432}{257,313,431}\right) = \frac{14k}{31,536,000}$$

$$\Rightarrow k \approx 0.0087542$$

- (b) $P = 257,313,431e^{(0.0087542)(15)} \approx 293,420,847$ (to the nearest integer). Answers will vary considerably with the number of decimal places retained.

11. $0.9P_0 = P_0e^k \Rightarrow k = \ln 0.9$; when the well's output falls to one-fifth of its present value $P = 0.2P_0$

$$\Rightarrow 0.2P_0 = P_0e^{(\ln 0.9)t} \Rightarrow 0.2 = e^{(\ln 0.9)t} \Rightarrow \ln(0.2) = (\ln 0.9)t \Rightarrow t = \frac{\ln 0.2}{\ln 0.9} \approx 15.28 \text{ yr}$$

12. (a) $\frac{dp}{dx} = -\frac{1}{100}p \Rightarrow \frac{dp}{p} = -\frac{1}{100}dx \Rightarrow \ln p = -\frac{1}{100}x + C \Rightarrow p = e^{(-0.01x+C)} = e^C e^{-0.01x} = C_1 e^{-0.01x}$;
 $p(100) = 20.09 \Rightarrow 20.09 = C_1 e^{(-0.01)(100)} \Rightarrow C_1 = 20.09e \approx 54.61 \Rightarrow p(x) = 54.61e^{-0.01x}$ (in dollars)

(b) $p(10) = 54.61e^{(-0.01)(10)} = \49.41 , and $p(90) = 54.61e^{(-0.01)(90)} = \22.20

- (c) $r(x) = xp(x) \Rightarrow r'(x) = p(x) + xp'(x)$;
 $p'(x) = -.5461e^{-0.01x} \Rightarrow r'(x) = (54.61 - .5461x)e^{-0.01x}$. Thus, $r'(x) = 0$
 $\Rightarrow 54.61 = .5461x \Rightarrow x = 100$. Since $r' > 0$
for any $x < 100$ and $r' < 0$ for $x > 100$, then
 $r(x)$ must be a maximum at $x = 100$.

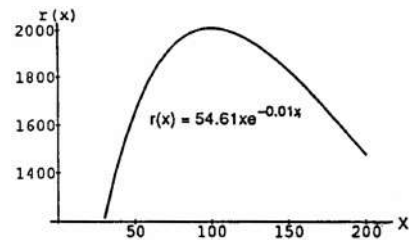

13. (a) $A_0e^{(0.04)5} = A_0e^{0.2}$

(b) $2A_0 = A_0e^{(0.04)t} \Rightarrow \ln 2 = (0.04)t \Rightarrow t = \frac{\ln 2}{0.04} \approx 17.33$ years; $3A_0 = A_0e^{(0.04)t} \Rightarrow \ln 3 = (0.04)t$
 $\Rightarrow t = \frac{\ln 3}{0.04} \approx 27.47$ years

14. (a) The amount of money invested A_0 after t years is $A(t) = A_0e^t$

(b) If $A(t) = 3A_0$, then $3A_0 = A_0e^t \Rightarrow \ln 3 = t$ or $t \approx 1.099$ years

- (c) At the beginning of a year the account balance is A_0e^t , while at the end of the year the balance is $A_0e^{(t+1)}$. The amount earned is $A_0e^{(t+1)} - A_0e^t = A_0e^t(e - 1) \approx 1.7$ times the beginning amount.

15. $A(100) = 90,000 \Rightarrow 90,000 = 1000e^{r(100)} \Rightarrow 90 = e^{100r} \Rightarrow \ln 90 = 100r \Rightarrow r = \frac{\ln 90}{100} \approx 0.0450$ or 4.50%

16. $A(100) = 131,000 \Rightarrow 131,000 = 1000e^{100r} \Rightarrow \ln 131 = 100r \Rightarrow r = \frac{\ln 131}{100} \approx 0.04875$ or 4.875%

17. $y = y_0e^{-0.18t}$ represents the decay equation; solving $(0.9)y_0 = y_0e^{-0.18t} \Rightarrow t = \frac{\ln(0.9)}{-0.18} \approx 0.585$ days

18. $A = A_0e^{kt}$ and $\frac{1}{2}A_0 = A_0e^{139k} \Rightarrow \frac{1}{2} = e^{139k} \Rightarrow k = \frac{\ln(0.5)}{139} \approx -0.00499$; then $0.05A_0 = A_0e^{-0.00499t}$
 $\Rightarrow t = \frac{\ln 0.05}{-0.00499} \approx 600$ days

19. $y = y_0e^{-kt} = y_0e^{-(k)(3/k)} = y_0e^{-3} = \frac{y_0}{e^3} < \frac{y_0}{20} = (0.05)(y_0) \Rightarrow$ after three mean lifetimes less than 5% remains

20. (a) $A = A_0e^{-kt} \Rightarrow \frac{1}{2} = e^{-2.645k} \Rightarrow k = \frac{\ln 2}{2.645} \approx 0.262$

(b) $\frac{1}{k} \approx 3.816$ years

(c) $(0.05)A = A \exp\left(-\frac{\ln 2}{2.645}t\right) \Rightarrow -\ln 20 = \left(-\frac{\ln 2}{2.645}\right)t \Rightarrow t = \frac{2.645 \ln 20}{\ln 2} \approx 11.431$ years

21. $T - T_s = (T_0 - T_s)e^{-kt}$, $T_0 = 90^\circ\text{C}$, $T_s = 20^\circ\text{C}$, $T = 60^\circ\text{C} \Rightarrow 60 - 20 = 70e^{-10k} \Rightarrow \frac{4}{7} = e^{-10k}$

$$\Rightarrow k = \frac{\ln\left(\frac{4}{7}\right)}{10} \approx 0.05596$$

- (a) $35 - 20 = 70e^{-0.05596t} \Rightarrow t \approx 27.5$ min is the total time \Rightarrow it will take $27.5 - 10 = 17.5$ minutes longer to reach 35°C
- (b) $T - T_s = (T_0 - T_s)e^{-kt}$, $T_0 = 90^\circ\text{C}$, $T_s = -15^\circ\text{C} \Rightarrow 35 + 15 = 105e^{-0.05596t} \Rightarrow t \approx 13.26$ min

22. $T - 65^\circ = (T_0 - 65^\circ)e^{-kt} \Rightarrow 35^\circ - 65^\circ = (T_0 - 65^\circ)e^{-10k}$ and $50^\circ - 65^\circ = (T_0 - 65^\circ)e^{-20k}$. Solving $-30^\circ = (T_0 - 65^\circ)e^{-10k}$ and $-15^\circ = (T_0 - 65^\circ)e^{-20k}$ simultaneously $\Rightarrow (T_0 - 65^\circ)e^{-10k} = 2(T_0 - 65^\circ)e^{-20k}$
 $\Rightarrow e^{10k} = 2 \Rightarrow k = \frac{\ln 2}{10}$ and $-30^\circ = \frac{T_0 - 65^\circ}{e^{10k}} \Rightarrow -30^\circ [e^{10(\frac{\ln 2}{10})}] = T_0 - 65^\circ \Rightarrow T_0 = 65^\circ - 30^\circ (e^{\ln 2}) = 65^\circ - 60^\circ = 5^\circ$

23. $T - T_s = (T_0 - T_s)e^{-kt} \Rightarrow 39 - T_s = (46 - T_s)e^{-10k}$ and $33 - T_s = (46 - T_s)e^{-20k} \Rightarrow \frac{39 - T_s}{46 - T_s} = e^{-10k}$ and $\frac{33 - T_s}{46 - T_s} = e^{-20k} = (e^{-10k})^2 \Rightarrow \frac{33 - T_s}{46 - T_s} = \left(\frac{39 - T_s}{46 - T_s}\right)^2 \Rightarrow (33 - T_s)(46 - T_s) = (39 - T_s)^2 \Rightarrow 1518 - 79T_s + T_s^2 = 1521 - 78T_s + T_s^2 \Rightarrow -T_s = 3 \Rightarrow T_s = -3^\circ\text{C}$

24. Let x represent how far above room temperature the silver will be 15 min from now, y how far above room temperature the silver will be 120 min from now, and t_0 the time the silver will be 10°C above room temperature. We then have the following time-temperature table:

time in min.	0	20 (Now)	35	140	t_0
temperature	$T_s + 70^\circ$	$T_s + 60^\circ$	$T_s + x$	$T_s + y$	$T_s + 10^\circ$

$T - T_s = (T_0 - T_s)e^{-kt} \Rightarrow (60 + T_s) - T_s = [(70 + T_s) - T_s]e^{-20k} \Rightarrow 60 = 70e^{-20k} \Rightarrow k = \left(-\frac{1}{20}\right) \ln\left(\frac{6}{7}\right) \approx 0.00771$

(a) $T - T_s = (T_0 - T_s)e^{-0.00771t} \Rightarrow (T_s + x) - T_s = [(70 + T_s) - T_s]e^{-(0.00771)(35)} \Rightarrow x = 70e^{-0.26985} \approx 53.44^\circ\text{C}$

(b) $T - T_s = (T_0 - T_s)e^{-0.00771t} \Rightarrow (T_s + y) - T_s = [(70 + T_s) - T_s]e^{-(0.00771)(140)} \Rightarrow y = 70e^{-1.0794} \approx 23.79^\circ\text{C}$

(c) $T - T_s = (T_0 - T_s)e^{-0.00771t} \Rightarrow (T_s + 10) - T_s = [(70 + T_s) - T_s]e^{-(0.00771)t_0} \Rightarrow 10 = 70e^{-0.00771t_0}$
 $\Rightarrow \ln\left(\frac{1}{7}\right) = -0.00771t_0 \Rightarrow t_0 = \left(-\frac{1}{0.00771}\right) \ln\left(\frac{1}{7}\right) = 252.39 \Rightarrow 252.39 - 20 \approx 232$ minutes from now the silver will be 10°C above room temperature

25. From Example 5, the half-life of carbon-14 is 5700 yr $\Rightarrow \frac{1}{2}c_0 = c_0e^{-k(5700)} \Rightarrow k = \frac{\ln 2}{5700} \approx 0.0001216$
 $\Rightarrow c = c_0e^{-0.0001216t} \Rightarrow (0.445)c_0 = c_0e^{-0.0001216t} \Rightarrow t = \frac{\ln(0.445)}{-0.0001216} \approx 6659$ years

26. From Exercise 25, $k \approx 0.0001216$ for carbon-14.

(a) $c = c_0e^{-0.0001216t} \Rightarrow (0.17)c_0 = c_0e^{-0.0001216t} \Rightarrow t \approx 14,571.44$ years $\Rightarrow 12,571$ BC

(b) $(0.18)c_0 = c_0e^{-0.0001216t} \Rightarrow t \approx 14,101.41$ years $\Rightarrow 12,101$ BC

(c) $(0.16)c_0 = c_0e^{-0.0001216t} \Rightarrow t \approx 15,069.98$ years $\Rightarrow 13,070$ BC

27. From Exercise 25, $k \approx 0.0001216$ for carbon-14. Thus, $c = c_0e^{-0.0001216t} \Rightarrow (0.995)c_0 = c_0e^{-0.0001216t}$
 $\Rightarrow t = \frac{\ln(0.995)}{-0.0001216} \approx 41$ years old

7.6 RELATIVE RATES OF GROWTH

1. (a) slower, $\lim_{x \rightarrow \infty} \frac{x+3}{e^x} = \lim_{x \rightarrow \infty} \frac{1}{e^x} = 0$

(b) slower, $\lim_{x \rightarrow \infty} \frac{x^3 + \sin^2 x}{e^x} = \lim_{x \rightarrow \infty} \frac{3x^2 + 2 \sin x \cos x}{e^x} = \lim_{x \rightarrow \infty} \frac{6x + 2 \cos 2x}{e^x} = \lim_{x \rightarrow \infty} \frac{6 - 4 \sin 2x}{e^x} = 0$ by the Sandwich Theorem because $\frac{2}{e^x} \leq \frac{6 - 4 \sin 2x}{e^x} \leq \frac{10}{e^x}$ for all reals and $\lim_{x \rightarrow \infty} \frac{2}{e^x} = 0 = \lim_{x \rightarrow \infty} \frac{10}{e^x}$

(c) slower, $\lim_{x \rightarrow \infty} \frac{\sqrt{x}}{e^x} = \lim_{x \rightarrow \infty} \frac{x^{1/2}}{e^x} = \lim_{x \rightarrow \infty} \frac{\left(\frac{1}{2}\right)x^{-1/2}}{e^x} = \lim_{x \rightarrow \infty} \frac{1}{2\sqrt{x}e^x} = 0$

(d) faster, $\lim_{x \rightarrow \infty} \frac{4^x}{e^x} = \lim_{x \rightarrow \infty} \left(\frac{4}{e}\right)^x = \infty$ since $\frac{4}{e} > 1$

(e) slower, $\lim_{x \rightarrow \infty} \frac{\left(\frac{3}{2}\right)^x}{e^x} = \lim_{x \rightarrow \infty} \left(\frac{3}{2e}\right)^x = 0$ since $\frac{3}{2e} < 1$

- (f) slower, $\lim_{x \rightarrow \infty} \frac{e^{x/2}}{e^x} = \lim_{x \rightarrow \infty} \frac{1}{e^{x/2}} = 0$
- (g) same, $\lim_{x \rightarrow \infty} \frac{\left(\frac{e^x}{2}\right)}{e^x} = \lim_{x \rightarrow \infty} \frac{1}{2} = \frac{1}{2}$
- (h) slower, $\lim_{x \rightarrow \infty} \frac{\log_{10} x}{e^x} = \lim_{x \rightarrow \infty} \frac{\ln x}{(\ln 10)e^x} = \lim_{x \rightarrow \infty} \frac{\frac{1}{x}}{(\ln 10)e^x} = \lim_{x \rightarrow \infty} \frac{1}{(\ln 10)xe^x} = 0$
2. (a) slower, $\lim_{x \rightarrow \infty} \frac{10x^4 + 30x + 1}{e^x} = \lim_{x \rightarrow \infty} \frac{40x^3 + 30}{e^x} = \lim_{x \rightarrow \infty} \frac{120x^2}{e^x} = \lim_{x \rightarrow \infty} \frac{240x}{e^x} = \lim_{x \rightarrow \infty} \frac{240}{e^x} = 0$
- (b) slower, $\lim_{x \rightarrow \infty} \frac{x \ln x - x}{e^x} = \lim_{x \rightarrow \infty} \frac{x(\ln x - 1)}{e^x} = \lim_{x \rightarrow \infty} \frac{\ln x - 1 + x\left(\frac{1}{x}\right)}{e^x} = \lim_{x \rightarrow \infty} \frac{\ln x - 1 + 1}{e^x} = \lim_{x \rightarrow \infty} \frac{\ln x}{e^x}$
 $= \lim_{x \rightarrow \infty} \frac{\left(\frac{1}{x}\right)}{e^x} = \lim_{x \rightarrow \infty} \frac{1}{xe^x} = 0$
- (c) slower, $\lim_{x \rightarrow \infty} \frac{\sqrt{1+x^4}}{e^x} = \sqrt{\lim_{x \rightarrow \infty} \frac{1+x^4}{e^{2x}}} = \sqrt{\lim_{x \rightarrow \infty} \frac{4x^3}{2e^{2x}}} = \sqrt{\lim_{x \rightarrow \infty} \frac{12x^2}{4e^{2x}}} = \sqrt{\lim_{x \rightarrow \infty} \frac{24x}{8e^{2x}}} = \sqrt{\lim_{x \rightarrow \infty} \frac{24}{16e^{2x}}}$
 $= \sqrt{0} = 0$
- (d) slower, $\lim_{x \rightarrow \infty} \frac{\left(\frac{5}{2}\right)^x}{e^x} = \lim_{x \rightarrow \infty} \left(\frac{5}{2e}\right)^x = 0$ since $\frac{5}{2e} < 1$
- (e) slower, $\lim_{x \rightarrow \infty} \frac{e^{-x}}{e^x} = \lim_{x \rightarrow \infty} \frac{1}{e^{2x}} = 0$
- (f) faster, $\lim_{x \rightarrow \infty} \frac{xe^x}{e^x} = \lim_{x \rightarrow \infty} x = \infty$
- (g) slower, since for all reals we have $-1 \leq \cos x \leq 1 \Rightarrow e^{-1} \leq e^{\cos x} \leq e^1 \Rightarrow \frac{e^{-1}}{e^x} \leq \frac{e^{\cos x}}{e^x} \leq \frac{e^1}{e^x}$ and also
 $\lim_{x \rightarrow \infty} \frac{e^{-1}}{e^x} = 0 = \lim_{x \rightarrow \infty} \frac{e^1}{e^x}$, so by the Sandwich Theorem we conclude that $\lim_{x \rightarrow \infty} \frac{e^{\cos x}}{e^x} = 0$
- (h) same, $\lim_{x \rightarrow \infty} \frac{e^{x-1}}{e^x} = \lim_{x \rightarrow \infty} \frac{1}{e^{(x-1)+1}} = \lim_{x \rightarrow \infty} \frac{1}{e} = \frac{1}{e}$
3. (a) same, $\lim_{x \rightarrow \infty} \frac{x^2 + 4x}{x^2} = \lim_{x \rightarrow \infty} \frac{2x + 4}{2x} = \lim_{x \rightarrow \infty} \frac{2}{2} = 1$
- (b) faster, $\lim_{x \rightarrow \infty} \frac{x^5 - x^2}{x^2} = \lim_{x \rightarrow \infty} (x^3 - 1) = \infty$
- (c) same, $\lim_{x \rightarrow \infty} \frac{\sqrt{x^4 + x^3}}{x^2} = \sqrt{\lim_{x \rightarrow \infty} \frac{x^4 + x^3}{x^4}} = \sqrt{\lim_{x \rightarrow \infty} \left(1 + \frac{1}{x}\right)} = \sqrt{1} = 1$
- (d) same, $\lim_{x \rightarrow \infty} \frac{(x+3)^2}{x^2} = \lim_{x \rightarrow \infty} \frac{2(x+3)}{2x} = \lim_{x \rightarrow \infty} \frac{2}{2} = 1$
- (e) slower, $\lim_{x \rightarrow \infty} \frac{x \ln x}{x^2} = \lim_{x \rightarrow \infty} \frac{\ln x}{x} = \lim_{x \rightarrow \infty} \frac{\left(\frac{1}{x}\right)}{1} = 0$
- (f) faster, $\lim_{x \rightarrow \infty} \frac{2^x}{x^2} = \lim_{x \rightarrow \infty} \frac{(\ln 2)2^x}{2x} = \lim_{x \rightarrow \infty} \frac{(\ln 2)^2 2^x}{2} = \infty$
- (g) slower, $\lim_{x \rightarrow \infty} \frac{x^3 e^{-x}}{x^2} = \lim_{x \rightarrow \infty} \frac{x}{e^x} = \lim_{x \rightarrow \infty} \frac{1}{e^x} = 0$
- (h) same, $\lim_{x \rightarrow \infty} \frac{8x^2}{x^2} = \lim_{x \rightarrow \infty} 8 = 8$
4. (a) same, $\lim_{x \rightarrow \infty} \frac{x^2 + \sqrt{x}}{x^2} = \lim_{x \rightarrow \infty} \left(1 + \frac{1}{x^{3/2}}\right) = 1$
- (b) same, $\lim_{x \rightarrow \infty} \frac{10x^2}{x^2} = \lim_{x \rightarrow \infty} 10 = 10$
- (c) slower, $\lim_{x \rightarrow \infty} \frac{x^2 e^{-x}}{x^2} = \lim_{x \rightarrow \infty} \frac{1}{e^x} = 0$
- (d) slower, $\lim_{x \rightarrow \infty} \frac{\log_{10} x^2}{x^2} = \lim_{x \rightarrow \infty} \frac{\left(\frac{\ln x^2}{\ln 10}\right)}{x^2} = \frac{1}{\ln 10} \lim_{x \rightarrow \infty} \frac{2 \ln x}{x^2} = \frac{2}{\ln 10} \lim_{x \rightarrow \infty} \frac{\left(\frac{1}{x}\right)}{2x} = \frac{1}{\ln 10} \lim_{x \rightarrow \infty} \frac{1}{x^2} = 0$
- (e) faster, $\lim_{x \rightarrow \infty} \frac{x^3 - x^2}{x^2} = \lim_{x \rightarrow \infty} (x - 1) = \infty$
- (f) slower, $\lim_{x \rightarrow \infty} \frac{\left(\frac{1}{10}\right)^x}{x^2} = \lim_{x \rightarrow \infty} \frac{1}{10^x x^2} = 0$
- (g) faster, $\lim_{x \rightarrow \infty} \frac{(1.1)^x}{x^2} = \lim_{x \rightarrow \infty} \frac{(\ln 1.1)(1.1)^x}{2x} = \lim_{x \rightarrow \infty} \frac{(\ln 1.1)^2 (1.1)^x}{2} = \infty$
- (h) same, $\lim_{x \rightarrow \infty} \frac{x^2 + 100x}{x^2} = \lim_{x \rightarrow \infty} \left(1 + \frac{100}{x}\right) = 1$

5. (a) same, $\lim_{x \rightarrow \infty} \frac{\log_3 x}{\ln x} = \lim_{x \rightarrow \infty} \frac{\frac{\ln x}{\ln 3}}{\ln x} = \lim_{x \rightarrow \infty} \frac{1}{\ln 3} = \frac{1}{\ln 3}$
- (b) same, $\lim_{x \rightarrow \infty} \frac{\ln 2x}{\ln x} = \lim_{x \rightarrow \infty} \frac{\left(\frac{2}{x}\right)}{\left(\frac{1}{x}\right)} = 1$
- (c) same, $\lim_{x \rightarrow \infty} \frac{\ln \sqrt{x}}{\ln x} = \lim_{x \rightarrow \infty} \frac{\left(\frac{1}{2}\right) \ln x}{\ln x} = \lim_{x \rightarrow \infty} \frac{1}{2} = \frac{1}{2}$
- (d) faster, $\lim_{x \rightarrow \infty} \frac{\sqrt{x}}{\ln x} = \lim_{x \rightarrow \infty} \frac{x^{1/2}}{\ln x} = \lim_{x \rightarrow \infty} \frac{\left(\frac{1}{2}\right)x^{-1/2}}{\left(\frac{1}{x}\right)} = \lim_{x \rightarrow \infty} \frac{x}{2\sqrt{x}} = \lim_{x \rightarrow \infty} \frac{\sqrt{x}}{2} = \infty$
- (e) faster, $\lim_{x \rightarrow \infty} \frac{x}{\ln x} = \lim_{x \rightarrow \infty} \frac{1}{\left(\frac{1}{x}\right)} = \lim_{x \rightarrow \infty} x = \infty$
- (f) same, $\lim_{x \rightarrow \infty} \frac{5 \ln x}{\ln x} = \lim_{x \rightarrow \infty} 5 = 5$
- (g) slower, $\lim_{x \rightarrow \infty} \frac{\left(\frac{1}{x}\right)}{\ln x} = \lim_{x \rightarrow \infty} \frac{1}{x \ln x} = 0$
- (h) faster, $\lim_{x \rightarrow \infty} \frac{e^x}{\ln x} = \lim_{x \rightarrow \infty} \frac{e^x}{\left(\frac{1}{x}\right)} = \lim_{x \rightarrow \infty} x e^x = \infty$
6. (a) same, $\lim_{x \rightarrow \infty} \frac{\log_2 x^2}{\ln x} = \lim_{x \rightarrow \infty} \frac{\frac{\ln x^2}{\ln 2}}{\ln x} = \frac{1}{\ln 2} \lim_{x \rightarrow \infty} \frac{\ln x^2}{\ln x} = \frac{1}{\ln 2} \lim_{x \rightarrow \infty} \frac{2 \ln x}{\ln x} = \frac{1}{\ln 2} \lim_{x \rightarrow \infty} 2 = \frac{2}{\ln 2}$
- (b) same, $\lim_{x \rightarrow \infty} \frac{\log_{10} 10x}{\ln x} = \lim_{x \rightarrow \infty} \frac{\frac{\ln 10x}{\ln 10}}{\ln x} = \frac{1}{\ln 10} \lim_{x \rightarrow \infty} \frac{\ln 10x}{\ln x} = \frac{1}{\ln 10} \lim_{x \rightarrow \infty} \frac{\left(\frac{10}{x}\right)}{\left(\frac{1}{x}\right)} = \frac{1}{\ln 10} \lim_{x \rightarrow \infty} 1 = \frac{1}{\ln 10}$
- (c) slower, $\lim_{x \rightarrow \infty} \frac{\left(\frac{1}{\sqrt{x}}\right)}{\ln x} = \lim_{x \rightarrow \infty} \frac{1}{(\sqrt{x})(\ln x)} = 0$
- (d) slower, $\lim_{x \rightarrow \infty} \frac{\left(\frac{1}{x^2}\right)}{\ln x} = \lim_{x \rightarrow \infty} \frac{1}{x^2 \ln x} = 0$
- (e) faster, $\lim_{x \rightarrow \infty} \frac{x-2 \ln x}{\ln x} = \lim_{x \rightarrow \infty} \left(\frac{x}{\ln x} - 2\right) = \left(\lim_{x \rightarrow \infty} \frac{x}{\ln x}\right) - 2 = \left(\lim_{x \rightarrow \infty} \frac{1}{\left(\frac{1}{x}\right)}\right) - 2 = \left(\lim_{x \rightarrow \infty} x\right) - 2 = \infty$
- (f) slower, $\lim_{x \rightarrow \infty} \frac{e^{-x}}{\ln x} = \lim_{x \rightarrow \infty} \frac{1}{e^x \ln x} = 0$
- (g) slower, $\lim_{x \rightarrow \infty} \frac{\ln(\ln x)}{\ln x} = \lim_{x \rightarrow \infty} \frac{\left(\frac{1/x}{\ln x}\right)}{\left(\frac{1}{x}\right)} = \lim_{x \rightarrow \infty} \frac{1}{\ln x} = 0$
- (h) same, $\lim_{x \rightarrow \infty} \frac{\ln(2x+5)}{\ln x} = \lim_{x \rightarrow \infty} \frac{\left(\frac{2}{2x+5}\right)}{\left(\frac{1}{x}\right)} = \lim_{x \rightarrow \infty} \frac{2x}{2x+5} = \lim_{x \rightarrow \infty} \frac{2}{2} = \lim_{x \rightarrow \infty} 1 = 1$
7. $\lim_{x \rightarrow \infty} \frac{e^x}{e^{x/2}} = \lim_{x \rightarrow \infty} e^{x/2} = \infty \Rightarrow e^x$ grows faster than $e^{x/2}$; since for $x > e$ we have $\ln x > e$ and $\lim_{x \rightarrow \infty} \frac{(\ln x)^x}{e^x} = \lim_{x \rightarrow \infty} \left(\frac{\ln x}{e}\right)^x = \infty \Rightarrow (\ln x)^x$ grows faster than e^x ; since $x > \ln x$ for all $x > 0$ and $\lim_{x \rightarrow \infty} \frac{x^x}{(\ln x)^x} = \lim_{x \rightarrow \infty} \left(\frac{x}{\ln x}\right)^x = \infty \Rightarrow x^x$ grows faster than $(\ln x)^x$. Therefore, slowest to fastest are: $e^{x/2}$, e^x , $(\ln x)^x$, x^x so the order is d, a, c, b
8. $\lim_{x \rightarrow \infty} \frac{(\ln 2)^x}{x^2} = \lim_{x \rightarrow \infty} \frac{(\ln(\ln 2))(\ln 2)^x}{2x} = \lim_{x \rightarrow \infty} \frac{(\ln(\ln 2))^2 (\ln 2)^x}{2} = \frac{(\ln(\ln 2))^2}{2} \lim_{x \rightarrow \infty} (\ln 2)^x = 0$
 $\Rightarrow (\ln 2)^x$ grows slower than x^2 ; $\lim_{x \rightarrow \infty} \frac{x^2}{2^x} = \lim_{x \rightarrow \infty} \frac{2x}{(\ln 2)2^x} = \lim_{x \rightarrow \infty} \frac{2}{(\ln 2)2^x} = 0 \Rightarrow x^2$ grows slower than 2^x ;
 $\lim_{x \rightarrow \infty} \frac{2^x}{e^x} = \lim_{x \rightarrow \infty} \left(\frac{2}{e}\right)^x = 0 \Rightarrow 2^x$ grows slower than e^x . Therefore, the slowest to the fastest is: $(\ln 2)^x$, x^2 , 2^x and e^x so the order is c, b, a, d
9. (a) false; $\lim_{x \rightarrow \infty} \frac{x}{x} = 1$
- (b) false; $\lim_{x \rightarrow \infty} \frac{x}{x+5} = \frac{1}{1} = 1$
- (c) true; $x < x+5 \Rightarrow \frac{x}{x+5} < 1$ if $x > 1$ (or sufficiently large)
- (d) true; $x < 2x \Rightarrow \frac{x}{2x} < 1$ if $x > 1$ (or sufficiently large)
- (e) true; $\lim_{x \rightarrow \infty} \frac{e^x}{e^{2x}} = \lim_{x \rightarrow \infty} \frac{1}{e^x} = 0$
- (f) true; $\frac{x+\ln x}{x} = 1 + \frac{\ln x}{x} < 1 + \frac{\sqrt{x}}{x} = 1 + \frac{1}{\sqrt{x}} < 2$ if $x > 1$ (or sufficiently large)

(g) false; $\lim_{x \rightarrow \infty} \frac{\ln x}{\ln 2x} = \lim_{x \rightarrow \infty} \frac{\left(\frac{1}{x}\right)}{\left(\frac{2}{2x}\right)} = \lim_{x \rightarrow \infty} 1 = 1$

(h) true; $\frac{\sqrt{x^2+5}}{x} < \frac{\sqrt{(x+5)^2}}{x} < \frac{x+5}{x} = 1 + \frac{5}{x} < 6$ if $x > 1$ (or sufficiently large)

10. (a) true; $\frac{\left(\frac{1}{x+3}\right)}{\left(\frac{1}{x}\right)} = \frac{x}{x+3} < 1$ if $x > 1$ (or sufficiently large)

(b) true; $\frac{\left(\frac{1}{x} + \frac{1}{x^2}\right)}{\left(\frac{1}{x}\right)} = 1 + \frac{1}{x} < 2$ if $x > 1$ (or sufficiently large)

(c) false; $\lim_{x \rightarrow \infty} \frac{\left(\frac{1}{x} - \frac{1}{x^2}\right)}{\left(\frac{1}{x}\right)} = \lim_{x \rightarrow \infty} \left(1 - \frac{1}{x}\right) = 1$

(d) true; $2 + \cos x \leq 3 \Rightarrow \frac{2 + \cos x}{2} \leq \frac{3}{2}$ if x is sufficiently large

(e) true; $\frac{e^x + x}{e^x} = 1 + \frac{x}{e^x}$ and $\frac{x}{e^x} \rightarrow 0$ as $x \rightarrow \infty \Rightarrow 1 + \frac{x}{e^x} < 2$ if x is sufficiently large

(f) true; $\lim_{x \rightarrow \infty} \frac{x \ln x}{x^2} = \lim_{x \rightarrow \infty} \frac{\ln x}{x} = \lim_{x \rightarrow \infty} \frac{\left(\frac{1}{x}\right)}{1} = 0$

(g) true; $\frac{\ln(\ln x)}{\ln x} < \frac{\ln x}{\ln x} = 1$ if x is sufficiently large

(h) false; $\lim_{x \rightarrow \infty} \frac{\ln x}{\ln(x^2+1)} = \lim_{x \rightarrow \infty} \frac{\left(\frac{1}{x}\right)}{\left(\frac{2}{x^2+1}\right)} = \lim_{x \rightarrow \infty} \frac{x^2+1}{2x^2} = \lim_{x \rightarrow \infty} \left(\frac{1}{2} + \frac{1}{2x^2}\right) = \frac{1}{2}$

11. If $f(x)$ and $g(x)$ grow at the same rate, then $\lim_{x \rightarrow \infty} \frac{f(x)}{g(x)} = L \neq 0 \Rightarrow \lim_{x \rightarrow \infty} \frac{g(x)}{f(x)} = \frac{1}{L} \neq 0$. Then

$$\left| \frac{f(x)}{g(x)} - L \right| < 1 \text{ if } x \text{ is sufficiently large} \Rightarrow L - 1 < \frac{f(x)}{g(x)} < L + 1 \Rightarrow \frac{f(x)}{g(x)} \leq |L| + 1 \text{ if } x \text{ is sufficiently large}$$

$$\Rightarrow f = O(g). \text{ Similarly, } \frac{g(x)}{f(x)} \leq \left| \frac{1}{L} \right| + 1 \Rightarrow g = O(f).$$

12. When the degree of f is less than the degree of g since in that case $\lim_{x \rightarrow \infty} \frac{f(x)}{g(x)} = 0$.

13. When the degree of f is less than or equal to the degree of g since $\lim_{x \rightarrow \infty} \frac{f(x)}{g(x)} = 0$ when the degree of f is smaller than the degree of g , and $\lim_{x \rightarrow \infty} \frac{f(x)}{g(x)} = \frac{a}{b}$ (the ratio of the leading coefficients) when the degrees are the same.

14. Polynomials of a greater degree grow at a greater rate than polynomials of a lesser degree. Polynomials of the same degree grow at the same rate.

15. $\lim_{x \rightarrow \infty} \frac{\ln(x+1)}{\ln x} = \lim_{x \rightarrow \infty} \frac{\left(\frac{1}{x+1}\right)}{\left(\frac{1}{x}\right)} = \lim_{x \rightarrow \infty} \frac{x}{x+1} = \lim_{x \rightarrow \infty} \frac{1}{1} = 1$ and $\lim_{x \rightarrow \infty} \frac{\ln(x+999)}{\ln x} = \lim_{x \rightarrow \infty} \frac{\left(\frac{1}{x+999}\right)}{\left(\frac{1}{x}\right)}$
 $= \lim_{x \rightarrow \infty} \frac{x}{x+999} = 1$

16. $\lim_{x \rightarrow \infty} \frac{\ln(x+a)}{\ln x} = \lim_{x \rightarrow \infty} \frac{\left(\frac{1}{x+a}\right)}{\left(\frac{1}{x}\right)} = \lim_{x \rightarrow \infty} \frac{x}{x+a} = \lim_{x \rightarrow \infty} \frac{1}{1} = 1$. Therefore, the relative rates are the same.

17. $\lim_{x \rightarrow \infty} \frac{\sqrt{10x+1}}{\sqrt{x}} = \sqrt{\lim_{x \rightarrow \infty} \frac{10x+1}{x}} = \sqrt{10}$ and $\lim_{x \rightarrow \infty} \frac{\sqrt{x+1}}{\sqrt{x}} = \sqrt{\lim_{x \rightarrow \infty} \frac{x+1}{x}} = \sqrt{1} = 1$. Since the growth rate is transitive, we conclude that $\sqrt{10x+1}$ and $\sqrt{x+1}$ have the same growth rate (that of \sqrt{x}).

18. $\lim_{x \rightarrow \infty} \frac{\sqrt{x^4+x}}{x^2} = \sqrt{\lim_{x \rightarrow \infty} \frac{x^4+x}{x^4}} = 1$ and $\lim_{x \rightarrow \infty} \frac{\sqrt{x^4-x^3}}{x^2} = \sqrt{\lim_{x \rightarrow \infty} \frac{x^4-x^3}{x^4}} = 1$. Since the growth rate is transitive, we conclude that $\sqrt{x^4+x}$ and $\sqrt{x^4-x^3}$ have the same growth rate (that of x^2).

19. $\lim_{x \rightarrow \infty} \frac{x^n}{e^x} = \lim_{x \rightarrow \infty} \frac{nx^{n-1}}{e^x} = \dots = \lim_{x \rightarrow \infty} \frac{n!}{e^x} = 0 \Rightarrow x^n = o(e^x)$ for any non-negative integer n

20. If $p(x) = a_n x^n + a_{n-1} x^{n-1} + \dots + a_1 x + a_0$, then $\lim_{x \rightarrow \infty} \frac{p(x)}{e^x} = a_n \lim_{x \rightarrow \infty} \frac{x^n}{e^x} + a_{n-1} \lim_{x \rightarrow \infty} \frac{x^{n-1}}{e^x} + \dots + a_1 \lim_{x \rightarrow \infty} \frac{x}{e^x} + a_0 \lim_{x \rightarrow \infty} \frac{1}{e^x}$ where each limit is zero (from Exercise 19). Therefore, $\lim_{x \rightarrow \infty} \frac{p(x)}{e^x} = 0 \Rightarrow e^x$ grows faster than any polynomial.

21. (a) $\lim_{x \rightarrow \infty} \frac{x^{1/n}}{\ln x} = \lim_{x \rightarrow \infty} \frac{x^{(1-n)/n}}{n(\frac{1}{x})} = (\frac{1}{n}) \lim_{x \rightarrow \infty} x^{1/n} = \infty \Rightarrow \ln x = o(x^{1/n})$ for any positive integer n
 (b) $\ln(e^{17,000,000}) = 17,000,000 < (e^{17 \times 10^6})^{1/10^6} = e^{17} \approx 24,154,952.75$
 (c) $x \approx 3.430631121 \times 10^{15}$
 (d) In the interval $[3.41 \times 10^{15}, 3.45 \times 10^{15}]$ we have $\ln x = 10 \ln(\ln x)$. The graphs cross at about 3.4306311×10^{15} .

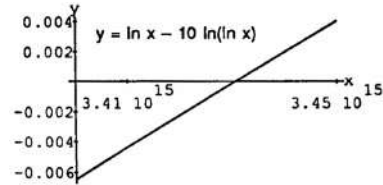

$$\lim_{x \rightarrow \infty} \frac{\ln x}{a_n x^n + a_{n-1} x^{n-1} + \dots + a_1 x + a_0} = \frac{\lim_{x \rightarrow \infty} \left(\frac{\ln x}{x^n} \right)}{\lim_{x \rightarrow \infty} \left(a_n + \frac{a_{n-1}}{x} + \dots + \frac{a_1}{x^{n-1}} + \frac{a_0}{x^n} \right)} = \frac{\lim_{x \rightarrow \infty} \left[\frac{(\frac{1}{x})}{nx^{n-1}} \right]}{a_n} = \lim_{x \rightarrow \infty} \frac{1}{(a_n)(nx^n)} = 0 \Rightarrow \ln x \text{ grows slower than any non-constant polynomial } (n \geq 1)$$

23. (a) $\lim_{n \rightarrow \infty} \frac{n \log_2 n}{n(\log_2 n)^2} = \lim_{n \rightarrow \infty} \frac{1}{\log_2 n} = 0 \Rightarrow n \log_2 n$ grows slower than $n(\log_2 n)^2$; $\lim_{n \rightarrow \infty} \frac{n \log_2 n}{n^{3/2}} = \lim_{n \rightarrow \infty} \frac{(\frac{\ln n}{\ln 2})}{n^{1/2}} = \frac{1}{\ln 2} \lim_{n \rightarrow \infty} \frac{(\frac{1}{n})}{(\frac{1}{2})n^{-1/2}} = \frac{2}{\ln 2} \lim_{n \rightarrow \infty} \frac{1}{n^{1/2}} = 0 \Rightarrow n \log_2 n$ grows slower than $n^{3/2}$. Therefore, $n \log_2 n$ grows at the slowest rate \Rightarrow the algorithm that takes $O(n \log_2 n)$ steps is the most efficient in the long run.

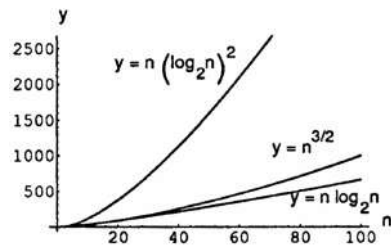

24. (a) $\lim_{n \rightarrow \infty} \frac{(\log_2 n)^2}{n} = \lim_{n \rightarrow \infty} \frac{(\frac{\ln n}{\ln 2})^2}{n} = \lim_{n \rightarrow \infty} \frac{(\ln n)^2}{n(\ln 2)^2} = \lim_{n \rightarrow \infty} \frac{2(\ln n)(\frac{1}{n})}{(\ln 2)^2} = \frac{2}{(\ln 2)^2} \lim_{n \rightarrow \infty} \frac{\ln n}{n} = \frac{2}{(\ln 2)^2} \lim_{n \rightarrow \infty} \frac{(\frac{1}{n})}{1} = 0 \Rightarrow (\log_2 n)^2$ grows slower than n ; $\lim_{n \rightarrow \infty} \frac{(\log_2 n)^2}{\sqrt{n} \log_2 n} = \lim_{n \rightarrow \infty} \frac{\log_2 n}{\sqrt{n}} = \lim_{n \rightarrow \infty} \frac{(\frac{\ln n}{\ln 2})}{n^{1/2}} = \frac{1}{\ln 2} \lim_{n \rightarrow \infty} \frac{\ln n}{n^{1/2}} = \frac{1}{\ln 2} \lim_{n \rightarrow \infty} \frac{(\frac{1}{n})}{(\frac{1}{2})n^{-1/2}} = \frac{2}{\ln 2} \lim_{n \rightarrow \infty} \frac{1}{n^{1/2}} = 0 \Rightarrow (\log_2 n)^2$ grows slower than $\sqrt{n} \log_2 n$. Therefore $(\log_2 n)^2$ grows at the slowest rate \Rightarrow the algorithm that takes $O((\log_2 n)^2)$ steps is the most efficient in the long run.

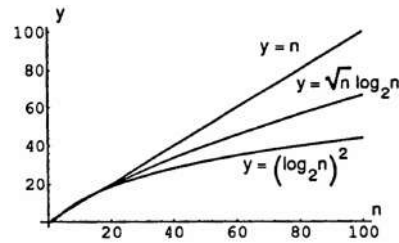

25. It could take one million steps for a sequential search, but at most 20 steps for a binary search because $2^{19} = 524,288 < 1,000,000 < 1,048,576 = 2^{20}$.

26. It could take 450,000 steps for a sequential search, but at most 19 steps for a binary search because $2^{18} = 262,144 < 450,000 < 524,288 = 2^{19}$.

7.7 INVERSE TRIGONOMETRIC FUNCTIONS

1. (a) $\frac{\pi}{4}$ (b) $-\frac{\pi}{3}$ (c) $\frac{\pi}{6}$ 2. (a) $-\frac{\pi}{4}$ (b) $\frac{\pi}{3}$ (c) $-\frac{\pi}{6}$
3. (a) $-\frac{\pi}{6}$ (b) $\frac{\pi}{4}$ (c) $-\frac{\pi}{3}$ 4. (a) $\frac{\pi}{6}$ (b) $-\frac{\pi}{4}$ (c) $\frac{\pi}{3}$
5. (a) $\frac{\pi}{3}$ (b) $\frac{3\pi}{4}$ (c) $\frac{\pi}{6}$ 6. (a) $\frac{2\pi}{3}$ (b) $\frac{\pi}{4}$ (c) $\frac{5\pi}{6}$
7. (a) $\frac{3\pi}{4}$ (b) $\frac{\pi}{6}$ (c) $\frac{2\pi}{3}$ 8. (a) $\frac{\pi}{4}$ (b) $\frac{5\pi}{6}$ (c) $\frac{\pi}{3}$
9. (a) $\frac{\pi}{4}$ (b) $-\frac{\pi}{3}$ (c) $\frac{\pi}{6}$ 10. (a) $-\frac{\pi}{4}$ (b) $\frac{\pi}{3}$ (c) $-\frac{\pi}{6}$
11. (a) $\frac{3\pi}{4}$ (b) $\frac{\pi}{6}$ (c) $\frac{2\pi}{3}$ 12. (a) $\frac{\pi}{4}$ (b) $\frac{5\pi}{6}$ (c) $\frac{\pi}{3}$
13. $\alpha = \sin^{-1}\left(\frac{5}{13}\right) \Rightarrow \cos \alpha = \frac{12}{13}, \tan \alpha = \frac{5}{12}, \sec \alpha = \frac{13}{12}, \csc \alpha = \frac{13}{5}, \text{ and } \cot \alpha = \frac{12}{5}$
14. $\alpha = \tan^{-1}\left(\frac{4}{3}\right) \Rightarrow \sin \alpha = \frac{4}{5}, \cos \alpha = \frac{3}{5}, \sec \alpha = \frac{5}{3}, \csc \alpha = \frac{5}{4}, \text{ and } \cot \alpha = \frac{3}{4}$
15. $\alpha = \sec^{-1}\left(-\sqrt{5}\right) \Rightarrow \sin \alpha = \frac{2}{\sqrt{5}}, \cos \alpha = -\frac{1}{\sqrt{5}}, \tan \alpha = -2, \csc \alpha = \frac{\sqrt{5}}{2}, \text{ and } \cot \alpha = -\frac{1}{2}$
16. $\alpha = \sec^{-1}\left(-\frac{\sqrt{13}}{2}\right) \Rightarrow \sin \alpha = \frac{3}{\sqrt{13}}, \cos \alpha = -\frac{2}{\sqrt{13}}, \tan \alpha = -\frac{3}{2}, \csc \alpha = \frac{\sqrt{13}}{3}, \text{ and } \cot \alpha = -\frac{2}{3}$
17. $\sin\left(\cos^{-1}\frac{\sqrt{2}}{2}\right) = \sin\left(\frac{\pi}{4}\right) = \frac{1}{\sqrt{2}}$ 18. $\sec\left(\cos^{-1}\frac{1}{2}\right) = \sec\left(\frac{\pi}{3}\right) = 2$
19. $\tan\left(\sin^{-1}\left(-\frac{1}{2}\right)\right) = \tan\left(-\frac{\pi}{6}\right) = -\frac{1}{\sqrt{3}}$ 20. $\cot\left(\sin^{-1}\left(-\frac{\sqrt{3}}{2}\right)\right) = \cot\left(-\frac{\pi}{3}\right) = -\frac{1}{\sqrt{3}}$
21. $\csc\left(\sec^{-1}2\right) + \cos\left(\tan^{-1}\left(-\sqrt{3}\right)\right) = \csc\left(\cos^{-1}\left(\frac{1}{2}\right)\right) + \cos\left(-\frac{\pi}{3}\right) = \csc\left(\frac{\pi}{3}\right) + \cos\left(-\frac{\pi}{3}\right) = \frac{2}{\sqrt{3}} + \frac{1}{2} = \frac{4+\sqrt{3}}{2\sqrt{3}}$
22. $\tan\left(\sec^{-1}1\right) + \sin\left(\csc^{-1}(-2)\right) = \tan\left(\cos^{-1}\frac{1}{1}\right) + \sin\left(\sin^{-1}\left(-\frac{1}{2}\right)\right) = \tan(0) + \sin\left(-\frac{\pi}{6}\right) = 0 + \left(-\frac{1}{2}\right) = -\frac{1}{2}$
23. $\sin\left(\sin^{-1}\left(-\frac{1}{2}\right) + \cos^{-1}\left(-\frac{1}{2}\right)\right) = \sin\left(-\frac{\pi}{6} + \frac{2\pi}{3}\right) = \sin\left(\frac{\pi}{2}\right) = 1$
24. $\cot\left(\sin^{-1}\left(-\frac{1}{2}\right) - \sec^{-1}2\right) = \cot\left(-\frac{\pi}{6} - \cos^{-1}\left(\frac{1}{2}\right)\right) = \cot\left(-\frac{\pi}{6} - \frac{\pi}{3}\right) = \cot\left(-\frac{\pi}{2}\right) = 0$
25. $\sec\left(\tan^{-1}1 + \csc^{-1}1\right) = \sec\left(\frac{\pi}{4} + \sin^{-1}\frac{1}{1}\right) = \sec\left(\frac{\pi}{4} + \frac{\pi}{2}\right) = \sec\left(\frac{3\pi}{4}\right) = -\sqrt{2}$
26. $\sec\left(\cot^{-1}\sqrt{3} + \csc^{-1}(-1)\right) = \sec\left(\frac{\pi}{6} + \sin^{-1}\left(\frac{1}{-1}\right)\right) = \sec\left(\frac{\pi}{6} - \frac{\pi}{3} - \frac{\pi}{2}\right) = \sec\left(-\frac{\pi}{3}\right) = 2$
27. $\sec^{-1}\left(\sec\left(-\frac{\pi}{6}\right)\right) = \sec^{-1}\left(\frac{2}{\sqrt{3}}\right) = \cos^{-1}\left(\frac{\sqrt{3}}{2}\right) = \frac{\pi}{6}$
28. $\cot^{-1}\left(\cot\left(-\frac{\pi}{4}\right)\right) = \cot^{-1}(-1) = \frac{3\pi}{4}$

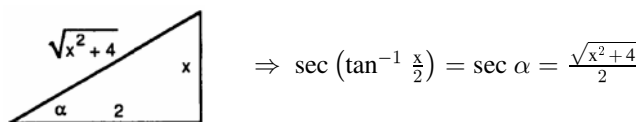
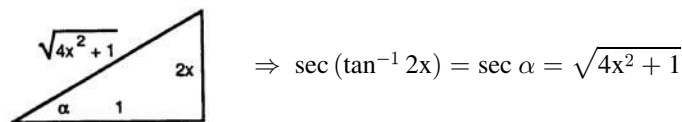
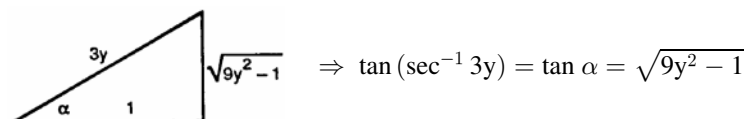
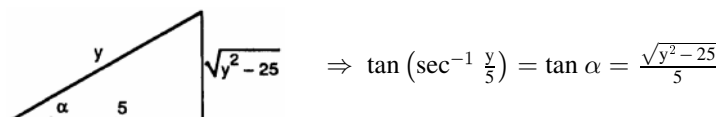
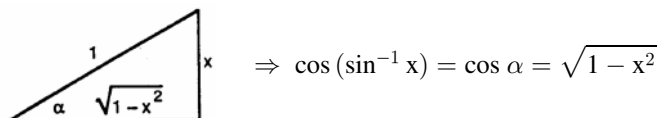
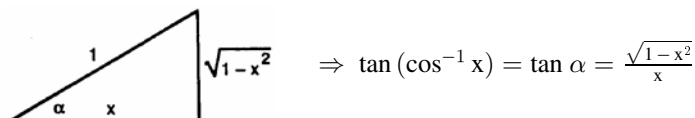
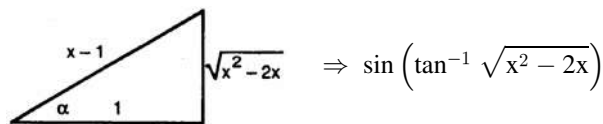
29. $\alpha = \tan^{-1} \frac{x}{2}$ indicates the diagram

 30. $\alpha = \tan^{-1} 2x$ indicates the diagram

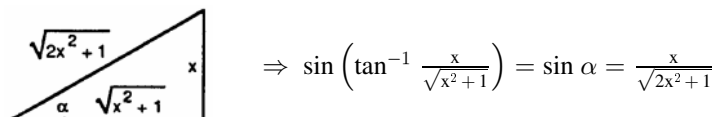
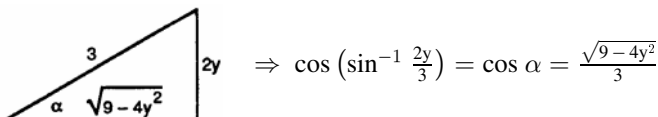
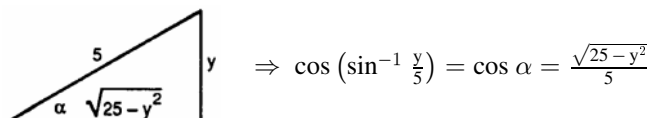
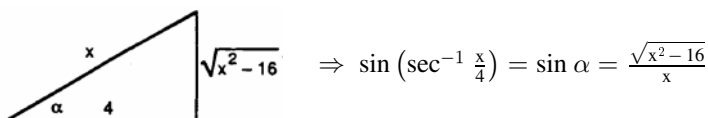
 31. $\alpha = \sec^{-1} 3y$ indicates the diagram

 32. $\alpha = \sec^{-1} \frac{y}{5}$ indicates the diagram

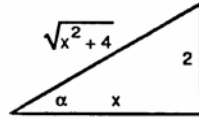
 33. $\alpha = \sin^{-1} x$ indicates the diagram

 34. $\alpha = \cos^{-1} x$ indicates the diagram

 35. $\alpha = \tan^{-1} \sqrt{x^2-2x}$ indicates the diagram

$$= \sin \alpha = \frac{\sqrt{x^2-2x}}{x-1}$$

 36. $\alpha = \tan^{-1} \frac{x}{\sqrt{x^2+1}}$ indicates the diagram

 37. $\alpha = \sin^{-1} \frac{2y}{3}$ indicates the diagram

 38. $\alpha = \sin^{-1} \frac{y}{5}$ indicates the diagram

 39. $\alpha = \sec^{-1} \frac{x}{4}$ indicates the diagram

40. $\alpha = \sec^{-1} \frac{\sqrt{x^2+4}}{x}$ indicates the diagram



$$\Rightarrow \sin \left(\sec^{-1} \frac{\sqrt{x^2+4}}{x} \right) = \sin \alpha = \frac{2}{\sqrt{x^2+4}}$$

41. $\lim_{x \rightarrow 1^-} \sin^{-1} x = \frac{\pi}{2}$

42. $\lim_{x \rightarrow -1^+} \cos^{-1} x = \pi$

43. $\lim_{x \rightarrow \infty} \tan^{-1} x = \frac{\pi}{2}$

44. $\lim_{x \rightarrow -\infty} \tan^{-1} x = -\frac{\pi}{2}$

45. $\lim_{x \rightarrow \infty} \sec^{-1} x = \frac{\pi}{2}$

46. $\lim_{x \rightarrow -\infty} \sec^{-1} x = \lim_{x \rightarrow -\infty} \cos^{-1} \left(\frac{1}{x} \right) = \frac{\pi}{2}$

47. $\lim_{x \rightarrow \infty} \csc^{-1} x = \lim_{x \rightarrow \infty} \sin^{-1} \left(\frac{1}{x} \right) = 0$

48. $\lim_{x \rightarrow -\infty} \csc^{-1} x = \lim_{x \rightarrow -\infty} \sin^{-1} \left(\frac{1}{x} \right) = 0$

49. $y = \cos^{-1}(x^2) \Rightarrow \frac{dy}{dx} = -\frac{2x}{\sqrt{1-(x^2)^2}} = \frac{-2x}{\sqrt{1-x^4}}$

50. $y = \cos^{-1} \left(\frac{1}{x} \right) = \sec^{-1} x \Rightarrow \frac{dy}{dx} = \frac{1}{|x| \sqrt{x^2-1}}$

51. $y = \sin^{-1} \sqrt{2t} \Rightarrow \frac{dy}{dt} = \frac{\sqrt{2}}{\sqrt{1-(\sqrt{2t})^2}} = \frac{\sqrt{2}}{\sqrt{1-2t}}$

52. $y = \sin^{-1}(1-t) \Rightarrow \frac{dy}{dt} = \frac{-1}{\sqrt{1-(1-t)^2}} = \frac{-1}{\sqrt{2t-t^2}}$

53. $y = \sec^{-1}(2s+1) \Rightarrow \frac{dy}{ds} = \frac{2}{|2s+1| \sqrt{(2s+1)^2-1}} = \frac{2}{|2s+1| \sqrt{4s^2+4s}} = \frac{1}{|2s+1| \sqrt{s^2+s}}$

54. $y = \sec^{-1} 5s \Rightarrow \frac{dy}{ds} = \frac{5}{|5s| \sqrt{(5s)^2-1}} = \frac{1}{|s| \sqrt{25s^2-1}}$

55. $y = \csc^{-1}(x^2+1) \Rightarrow \frac{dy}{dx} = -\frac{2x}{|x^2+1| \sqrt{(x^2+1)^2-1}} = \frac{-2x}{(x^2+1) \sqrt{x^4+2x^2}}$

56. $y = \csc^{-1} \left(\frac{x}{2} \right) \Rightarrow \frac{dy}{dx} = -\frac{\left(\frac{1}{2} \right)}{\left| \frac{x}{2} \right| \sqrt{\left(\frac{x}{2} \right)^2-1}} = \frac{-1}{|x| \sqrt{\frac{x^2-4}{4}}} = \frac{-2}{|x| \sqrt{x^2-4}}$

57. $y = \sec^{-1} \left(\frac{1}{t} \right) = \cos^{-1} t \Rightarrow \frac{dy}{dt} = \frac{-1}{\sqrt{1-t^2}}$

58. $y = \sin^{-1} \left(\frac{3}{t^2} \right) = \csc^{-1} \left(\frac{t^2}{3} \right) \Rightarrow \frac{dy}{dt} = -\frac{\left(\frac{2t}{3} \right)}{\left| \frac{t^2}{3} \right| \sqrt{\left(\frac{t^2}{3} \right)^2-1}} = \frac{-2t}{t^2 \sqrt{\frac{t^4-9}{9}}} = \frac{-6}{t \sqrt{t^4-9}}$

59. $y = \cot^{-1} \sqrt{t} = \cot^{-1} t^{1/2} \Rightarrow \frac{dy}{dt} = -\frac{\left(\frac{1}{2} \right) t^{-1/2}}{1+(t^{1/2})^2} = \frac{-1}{2\sqrt{t}(1+t)}$

60. $y = \cot^{-1} \sqrt{t-1} = \cot^{-1} (t-1)^{1/2} \Rightarrow \frac{dy}{dt} = -\frac{\left(\frac{1}{2} \right) (t-1)^{-1/2}}{1+[(t-1)^{1/2}]^2} = \frac{-1}{2\sqrt{t-1}(1+t-1)} = \frac{-1}{2t\sqrt{t-1}}$

61. $y = \ln(\tan^{-1} x) \Rightarrow \frac{dy}{dx} = \frac{\left(\frac{1}{1+x^2} \right)}{\tan^{-1} x} = \frac{1}{(\tan^{-1} x)(1+x^2)}$

62. $y = \tan^{-1}(\ln x) \Rightarrow \frac{dy}{dx} = \frac{\left(\frac{1}{x} \right)}{1+(\ln x)^2} = \frac{1}{x[1+(\ln x)^2]}$

63. $y = \csc^{-1}(e^t) \Rightarrow \frac{dy}{dt} = -\frac{e^t}{|e^t| \sqrt{(e^t)^2-1}} = \frac{-1}{\sqrt{e^{2t}-1}}$

$$64. y = \cos^{-1}(e^{-t}) \Rightarrow \frac{dy}{dt} = -\frac{-e^{-t}}{\sqrt{1-(e^{-t})^2}} = \frac{e^{-t}}{\sqrt{1-e^{-2t}}}$$

$$65. y = s\sqrt{1-s^2} + \cos^{-1}s = s(1-s^2)^{1/2} + \cos^{-1}s \Rightarrow \frac{dy}{ds} = (1-s^2)^{1/2} + s\left(\frac{1}{2}\right)(1-s^2)^{-1/2}(-2s) - \frac{1}{\sqrt{1-s^2}}$$

$$= \sqrt{1-s^2} - \frac{s^2}{\sqrt{1-s^2}} - \frac{1}{\sqrt{1-s^2}} = \sqrt{1-s^2} - \frac{s^2+1}{\sqrt{1-s^2}} = \frac{1-s^2-s^2-1}{\sqrt{1-s^2}} = \frac{-2s^2}{\sqrt{1-s^2}}$$

$$66. y = \sqrt{s^2-1} - \sec^{-1}s = (s^2-1)^{1/2} - \sec^{-1}s \Rightarrow \frac{dy}{dx} = \left(\frac{1}{2}\right)(s^2-1)^{-1/2}(2s) - \frac{1}{|s|\sqrt{s^2-1}} = \frac{s}{\sqrt{s^2-1}} - \frac{1}{|s|\sqrt{s^2-1}}$$

$$= \frac{s|s|-1}{|s|\sqrt{s^2-1}}$$

$$67. y = \tan^{-1}\sqrt{x^2-1} + \csc^{-1}x = \tan^{-1}(x^2-1)^{1/2} + \csc^{-1}x \Rightarrow \frac{dy}{dx} = \frac{\left(\frac{1}{2}\right)(x^2-1)^{-1/2}(2x)}{1+(x^2-1)^{1/2})^2} - \frac{1}{|x|\sqrt{x^2-1}}$$

$$= \frac{1}{x\sqrt{x^2-1}} - \frac{1}{|x|\sqrt{x^2-1}} = 0, \text{ for } x > 1$$

$$68. y = \cot^{-1}\left(\frac{1}{x}\right) - \tan^{-1}x = \frac{\pi}{2} - \tan^{-1}(x^{-1}) - \tan^{-1}x \Rightarrow \frac{dy}{dx} = 0 - \frac{-x^{-2}}{1+(x^{-1})^2} - \frac{1}{1+x^2} = \frac{1}{x^2+1} - \frac{1}{1+x^2} = 0$$

$$69. y = x \sin^{-1}x + \sqrt{1-x^2} = x \sin^{-1}x + (1-x^2)^{1/2} \Rightarrow \frac{dy}{dx} = \sin^{-1}x + x\left(\frac{1}{\sqrt{1-x^2}}\right) + \left(\frac{1}{2}\right)(1-x^2)^{-1/2}(-2x)$$

$$= \sin^{-1}x + \frac{x}{\sqrt{1-x^2}} - \frac{x}{\sqrt{1-x^2}} = \sin^{-1}x$$

$$70. y = \ln(x^2+4) - x \tan^{-1}\left(\frac{x}{2}\right) \Rightarrow \frac{dy}{dx} = \frac{2x}{x^2+4} - \tan^{-1}\left(\frac{x}{2}\right) - x \left[\frac{\left(\frac{1}{2}\right)}{1+\left(\frac{x}{2}\right)^2} \right] = \frac{2x}{x^2+4} - \tan^{-1}\left(\frac{x}{2}\right) - \frac{2x}{4+x^2}$$

$$= -\tan^{-1}\left(\frac{x}{2}\right)$$

$$71. \int \frac{1}{\sqrt{9-x^2}} dx = \sin^{-1}\left(\frac{x}{3}\right) + C$$

$$72. \int \frac{1}{\sqrt{1-4x^2}} dx = \frac{1}{2} \int \frac{2}{\sqrt{1-(2x)^2}} dx = \frac{1}{2} \int \frac{du}{\sqrt{1-u^2}}, \text{ where } u = 2x \text{ and } du = 2 dx$$

$$= \frac{1}{2} \sin^{-1}u + C = \frac{1}{2} \sin^{-1}(2x) + C$$

$$73. \int \frac{1}{17+x^2} dx = \int \frac{1}{(\sqrt{17})^2+x^2} dx = \frac{1}{\sqrt{17}} \tan^{-1} \frac{x}{\sqrt{17}} + C$$

$$74. \int \frac{1}{9+3x^2} dx = \frac{1}{3} \int \frac{1}{\left(\frac{\sqrt{3}}{3}\right)^2+x^2} dx = \frac{1}{3\sqrt{3}} \tan^{-1}\left(\frac{x}{\sqrt{3}}\right) + C = \frac{\sqrt{3}}{9} \tan^{-1}\left(\frac{x}{\sqrt{3}}\right) + C$$

$$75. \int \frac{dx}{x\sqrt{25x^2-2}} = \int \frac{du}{u\sqrt{u^2-2}}, \text{ where } u = 5x \text{ and } du = 5 dx$$

$$= \frac{1}{\sqrt{2}} \sec^{-1} \left| \frac{u}{\sqrt{2}} \right| + C = \frac{1}{\sqrt{2}} \sec^{-1} \left| \frac{5x}{\sqrt{2}} \right| + C$$

$$76. \int \frac{dx}{x\sqrt{5x^2-4}} = \int \frac{du}{u\sqrt{u^2-4}}, \text{ where } u = \sqrt{5}x \text{ and } du = \sqrt{5} dx$$

$$= \frac{1}{2} \sec^{-1} \left| \frac{u}{2} \right| + C = \frac{1}{2} \sec^{-1} \left| \frac{\sqrt{5}x}{2} \right| + C$$

$$77. \int_0^1 \frac{4 ds}{\sqrt{4-s^2}} = \left[4 \sin^{-1} \frac{s}{2} \right]_0^1 = 4 \left(\sin^{-1} \frac{1}{2} - \sin^{-1} 0 \right) = 4 \left(\frac{\pi}{6} - 0 \right) = \frac{2\pi}{3}$$

$$78. \int_0^{3\sqrt{2}/4} \frac{ds}{\sqrt{9-4s^2}} = \frac{1}{2} \int_0^{3\sqrt{2}/4} \frac{du}{\sqrt{9-u^2}}, \text{ where } u = 2s \text{ and } du = 2 ds; s = 0 \Rightarrow u = 0, s = \frac{3\sqrt{2}}{4} \Rightarrow u = \frac{3\sqrt{2}}{2}$$

$$= \left[\frac{1}{2} \sin^{-1} \frac{u}{3} \right]_0^{3\sqrt{2}/2} = \frac{1}{2} \left(\sin^{-1} \frac{\sqrt{2}}{2} - \sin^{-1} 0 \right) = \frac{1}{2} \left(\frac{\pi}{4} - 0 \right) = \frac{\pi}{8}$$

$$79. \int_0^2 \frac{dt}{8+2t^2} = \frac{1}{\sqrt{2}} \int_0^{2\sqrt{2}} \frac{du}{8+u^2}, \text{ where } u = \sqrt{2}t \text{ and } du = \sqrt{2} dt; t = 0 \Rightarrow u = 0, t = 2 \Rightarrow u = 2\sqrt{2}$$

$$= \left[\frac{1}{\sqrt{2}} \cdot \frac{1}{\sqrt{8}} \tan^{-1} \frac{u}{\sqrt{8}} \right]_0^{2\sqrt{2}} = \frac{1}{4} \left(\tan^{-1} \frac{2\sqrt{2}}{\sqrt{8}} - \tan^{-1} 0 \right) = \frac{1}{4} \left(\tan^{-1} 1 - \tan^{-1} 0 \right) = \frac{1}{4} \left(\frac{\pi}{4} - 0 \right) = \frac{\pi}{16}$$

$$80. \int_{-2}^2 \frac{dt}{4+3t^2} = \frac{1}{\sqrt{3}} \int_{-2\sqrt{3}}^{2\sqrt{3}} \frac{du}{4+u^2}, \text{ where } u = \sqrt{3}t \text{ and } du = \sqrt{3} dt; t = -2 \Rightarrow u = -2\sqrt{3}, t = 2 \Rightarrow u = 2\sqrt{3}$$

$$= \left[\frac{1}{\sqrt{3}} \cdot \frac{1}{2} \tan^{-1} \frac{u}{2} \right]_{-2\sqrt{3}}^{2\sqrt{3}} = \frac{1}{2\sqrt{3}} \left[\tan^{-1} \sqrt{3} - \tan^{-1} (-\sqrt{3}) \right] = \frac{1}{2\sqrt{3}} \left[\frac{\pi}{3} - \left(-\frac{\pi}{3} \right) \right] = \frac{\pi}{3\sqrt{3}}$$

$$81. \int_{-1}^{-\sqrt{2}/2} \frac{dy}{y\sqrt{4y^2-1}} = \int_{-2}^{-\sqrt{2}} \frac{du}{u\sqrt{u^2-1}}, \text{ where } u = 2y \text{ and } du = 2 dy; y = -1 \Rightarrow u = -2, y = -\frac{\sqrt{2}}{2} \Rightarrow u = -\sqrt{2}$$

$$= \left[\sec^{-1} |u| \right]_{-2}^{-\sqrt{2}} = \sec^{-1} |-\sqrt{2}| - \sec^{-1} |-2| = \frac{\pi}{4} - \frac{\pi}{3} = -\frac{\pi}{12}$$

$$82. \int_{-2/3}^{-\sqrt{2}/3} \frac{dy}{y\sqrt{9y^2-1}} = \int_{-2}^{-\sqrt{2}} \frac{du}{u\sqrt{u^2-1}}, \text{ where } u = 3y \text{ and } du = 3 dy; y = -\frac{2}{3} \Rightarrow u = -2, y = -\frac{\sqrt{2}}{3} \Rightarrow u = -\sqrt{2}$$

$$= \left[\sec^{-1} |u| \right]_{-2}^{-\sqrt{2}} = \sec^{-1} |-\sqrt{2}| - \sec^{-1} |-2| = \frac{\pi}{4} - \frac{\pi}{3} = -\frac{\pi}{12}$$

$$83. \int \frac{3 dr}{\sqrt{1-4(r-1)^2}} = \frac{3}{2} \int \frac{du}{\sqrt{1-u^2}}, \text{ where } u = 2(r-1) \text{ and } du = 2 dr$$

$$= \frac{3}{2} \sin^{-1} u + C = \frac{3}{2} \sin^{-1} 2(r-1) + C$$

$$84. \int \frac{6 dr}{\sqrt{4-(r+1)^2}} = 6 \int \frac{du}{\sqrt{4-u^2}}, \text{ where } u = r+1 \text{ and } du = dr$$

$$= 6 \sin^{-1} \frac{u}{2} + C = 6 \sin^{-1} \left(\frac{r+1}{2} \right) + C$$

$$85. \int \frac{dx}{2+(x-1)^2} = \int \frac{du}{2+u^2}, \text{ where } u = x-1 \text{ and } du = dx$$

$$= \frac{1}{\sqrt{2}} \tan^{-1} \frac{u}{\sqrt{2}} + C = \frac{1}{\sqrt{2}} \tan^{-1} \left(\frac{x-1}{\sqrt{2}} \right) + C$$

$$86. \int \frac{dx}{1+(3x+1)^2} = \frac{1}{3} \int \frac{du}{1+u^2}, \text{ where } u = 3x+1 \text{ and } du = 3 dx$$

$$= \frac{1}{3} \tan^{-1} u + C = \frac{1}{3} \tan^{-1} (3x+1) + C$$

$$87. \int \frac{dx}{(2x-1)\sqrt{(2x-1)^2-4}} = \frac{1}{2} \int \frac{du}{u\sqrt{u^2-4}}, \text{ where } u = 2x-1 \text{ and } du = 2 dx$$

$$= \frac{1}{2} \cdot \frac{1}{2} \sec^{-1} \left| \frac{u}{2} \right| + C = \frac{1}{4} \sec^{-1} \left| \frac{2x-1}{2} \right| + C$$

$$88. \int \frac{dx}{(x+3)\sqrt{(x+3)^2-25}} = \int \frac{du}{u\sqrt{u^2-25}}, \text{ where } u = x+3 \text{ and } du = dx$$

$$= \frac{1}{5} \sec^{-1} \left| \frac{u}{5} \right| + C = \frac{1}{5} \sec^{-1} \left| \frac{x+3}{5} \right| + C$$

$$89. \int_{-\pi/2}^{\pi/2} \frac{2 \cos \theta d\theta}{1+(\sin \theta)^2} = 2 \int_{-1}^1 \frac{du}{1+u^2}, \text{ where } u = \sin \theta \text{ and } du = \cos \theta d\theta; \theta = -\frac{\pi}{2} \Rightarrow u = -1, \theta = \frac{\pi}{2} \Rightarrow u = 1$$

$$= \left[2 \tan^{-1} u \right]_{-1}^1 = 2 \left(\tan^{-1} 1 - \tan^{-1} (-1) \right) = 2 \left[\frac{\pi}{4} - \left(-\frac{\pi}{4} \right) \right] = \pi$$

$$90. \int_{\pi/6}^{\pi/4} \frac{\csc^2 x \, dx}{1 + (\cot x)^2} = - \int_{\sqrt{3}}^1 \frac{du}{1+u^2}, \text{ where } u = \cot x \text{ and } du = -\csc^2 x \, dx; x = \frac{\pi}{6} \Rightarrow u = \sqrt{3}, x = \frac{\pi}{4} \Rightarrow u = 1$$

$$= [-\tan^{-1} u]_{\sqrt{3}}^1 = -\tan^{-1} 1 + \tan^{-1} \sqrt{3} = -\frac{\pi}{4} + \frac{\pi}{3} = \frac{\pi}{12}$$

$$91. \int_0^{\ln \sqrt{3}} \frac{e^x \, dx}{1+e^{2x}} = \int_1^{\sqrt{3}} \frac{du}{1+u^2}, \text{ where } u = e^x \text{ and } du = e^x \, dx; x = 0 \Rightarrow u = 1, x = \ln \sqrt{3} \Rightarrow u = \sqrt{3}$$

$$= [\tan^{-1} u]_1^{\sqrt{3}} = \tan^{-1} \sqrt{3} - \tan^{-1} 1 = \frac{\pi}{3} - \frac{\pi}{4} = \frac{\pi}{12}$$

$$92. \int_1^{e^{\pi/4}} \frac{4 \, dt}{t(1+\ln^2 t)} = 4 \int_0^{\pi/4} \frac{du}{1+u^2}, \text{ where } u = \ln t \text{ and } du = \frac{1}{t} \, dt; t = 1 \Rightarrow u = 0, t = e^{\pi/4} \Rightarrow u = \frac{\pi}{4}$$

$$= [4 \tan^{-1} u]_0^{\pi/4} = 4 (\tan^{-1} \frac{\pi}{4} - \tan^{-1} 0) = 4 \tan^{-1} \frac{\pi}{4}$$

$$93. \int \frac{y \, dy}{\sqrt{1-y^4}} = \frac{1}{2} \int \frac{du}{\sqrt{1-u^2}}, \text{ where } u = y^2 \text{ and } du = 2y \, dy$$

$$= \frac{1}{2} \sin^{-1} u + C = \frac{1}{2} \sin^{-1} y^2 + C$$

$$94. \int \frac{\sec^2 y \, dy}{\sqrt{1-\tan^2 y}} = \int \frac{du}{\sqrt{1-u^2}}, \text{ where } u = \tan y \text{ and } du = \sec^2 y \, dy$$

$$= \sin^{-1} u + C = \sin^{-1} (\tan y) + C$$

$$95. \int \frac{dx}{\sqrt{-x^2+4x-3}} = \int \frac{dx}{\sqrt{1-(x^2-4x+4)}} = \int \frac{dx}{\sqrt{1-(x-2)^2}} = \sin^{-1} (x-2) + C$$

$$96. \int \frac{dx}{\sqrt{2x-x^2}} = \int \frac{dx}{\sqrt{1-(x^2-2x+1)}} = \int \frac{dx}{\sqrt{1-(x-1)^2}} = \sin^{-1} (x-1) + C$$

$$97. \int_{-1}^0 \frac{6 \, dt}{\sqrt{3-2t-t^2}} = 6 \int_{-1}^0 \frac{dt}{\sqrt{4-(t^2+2t+1)}} = 6 \int_{-1}^0 \frac{dt}{\sqrt{2^2-(t+1)^2}} = 6 [\sin^{-1} (\frac{t+1}{2})]_{-1}^0$$

$$= 6 [\sin^{-1} (\frac{1}{2}) - \sin^{-1} 0] = 6 (\frac{\pi}{6} - 0) = \pi$$

$$98. \int_{1/2}^1 \frac{6 \, dt}{\sqrt{3+4t-4t^2}} = 3 \int_{1/2}^1 \frac{2 \, dt}{\sqrt{4-(4t^2-4t+1)}} = 3 \int_{1/2}^1 \frac{2 \, dt}{\sqrt{2^2-(2t-1)^2}} = 3 [\sin^{-1} (\frac{2t-1}{2})]_{1/2}^1$$

$$= 3 [\sin^{-1} (\frac{1}{2}) - \sin^{-1} 0] = 3 (\frac{\pi}{6} - 0) = \frac{\pi}{2}$$

$$99. \int \frac{dy}{y^2-2y+5} = \int \frac{dy}{4+y^2-2y+1} = \int \frac{dy}{2^2+(y-1)^2} = \frac{1}{2} \tan^{-1} (\frac{y-1}{2}) + C$$

$$100. \int \frac{dy}{y^2+6y+10} = \int \frac{dy}{1+(y^2+6y+9)} = \int \frac{dy}{1+(y+3)^2} = \tan^{-1} (y+3) + C$$

$$101. \int_1^2 \frac{8 \, dx}{x^2-2x+2} = 8 \int_1^2 \frac{dx}{1+(x^2-2x+1)} = 8 \int_1^2 \frac{dx}{1+(x-1)^2} = 8 [\tan^{-1} (x-1)]_1^2$$

$$= 8 (\tan^{-1} 1 - \tan^{-1} 0) = 8 (\frac{\pi}{4} - 0) = 2\pi$$

$$102. \int_2^4 \frac{2 \, dx}{x^2-6x+10} = 2 \int_2^4 \frac{dx}{1+(x^2-6x+9)} = 2 \int_2^4 \frac{dx}{1+(x-3)^2} = 2 [\tan^{-1} (x-3)]_2^4$$

$$= 2 [\tan^{-1} 1 - \tan^{-1} (-1)] = 2 [\frac{\pi}{4} - (-\frac{\pi}{4})] = \pi$$

$$103. \int \frac{dx}{(x+1)\sqrt{x^2+2x}} = \int \frac{dx}{(x+1)\sqrt{x^2+2x+1-1}} = \int \frac{dx}{(x+1)\sqrt{(x+1)^2-1}}$$

$$= \int \frac{du}{u\sqrt{u^2-1}}, \text{ where } u = x+1 \text{ and } du = dx$$

$$= \sec^{-1} |u| + C = \sec^{-1} |x+1| + C$$

$$\begin{aligned}
 104. \int \frac{dx}{(x-2)\sqrt{x^2-4x+3}} &= \int \frac{dx}{(x-2)\sqrt{x^2-4x+4-1}} = \int \frac{dx}{(x-2)\sqrt{(x-2)^2-1}} \\
 &= \int \frac{1}{u\sqrt{u^2-1}} du, \text{ where } u = x-2 \text{ and } du = dx \\
 &= \sec^{-1} |u| + C = \sec^{-1} |x-2| + C
 \end{aligned}$$

$$\begin{aligned}
 105. \int \frac{e^{\sin^{-1} x}}{\sqrt{1-x^2}} dx &= \int e^u du, \text{ where } u = \sin^{-1} x \text{ and } du = \frac{dx}{\sqrt{1-x^2}} \\
 &= e^u + C = e^{\sin^{-1} x} + C
 \end{aligned}$$

$$\begin{aligned}
 106. \int \frac{e^{\cos^{-1} x}}{\sqrt{1-x^2}} dx &= -\int e^u du, \text{ where } u = \cos^{-1} x \text{ and } du = \frac{-dx}{\sqrt{1-x^2}} \\
 &= -e^u + C = -e^{\cos^{-1} x} + C
 \end{aligned}$$

$$\begin{aligned}
 107. \int \frac{(\sin^{-1} x)^2}{\sqrt{1-x^2}} dx &= \int u^2 du, \text{ where } u = \sin^{-1} x \text{ and } du = \frac{dx}{\sqrt{1-x^2}} \\
 &= \frac{u^3}{3} + C = \frac{(\sin^{-1} x)^3}{3} + C
 \end{aligned}$$

$$\begin{aligned}
 108. \int \frac{\sqrt{\tan^{-1} x}}{1+x^2} dx &= \int u^{1/2} du, \text{ where } u = \tan^{-1} x \text{ and } du = \frac{dx}{1+x^2} \\
 &= \frac{2}{3} u^{3/2} + C = \frac{2}{3} (\tan^{-1} x)^{3/2} + C = \frac{2}{3} \sqrt{(\tan^{-1} x)^3} + C
 \end{aligned}$$

$$\begin{aligned}
 109. \int \frac{1}{(\tan^{-1} y)(1+y^2)} dy &= \int \frac{\left(\frac{1}{1+y^2}\right)}{\tan^{-1} y} dy = \int \frac{1}{u} du, \text{ where } u = \tan^{-1} y \text{ and } du = \frac{dy}{1+y^2} \\
 &= \ln |u| + C = \ln |\tan^{-1} y| + C
 \end{aligned}$$

$$\begin{aligned}
 110. \int \frac{1}{(\sin^{-1} y)\sqrt{1+y^2}} dy &= \int \frac{\left(\frac{1}{\sqrt{1+y^2}}\right)}{\sin^{-1} y} dy = \int \frac{1}{u} du, \text{ where } u = \sin^{-1} y \text{ and } du = \frac{dy}{\sqrt{1+y^2}} \\
 &= \ln |u| + C = \ln |\sin^{-1} y| + C
 \end{aligned}$$

$$\begin{aligned}
 111. \int_{\sqrt{2}}^2 \frac{\sec^2(\sec^{-1} x)}{x\sqrt{x^2-1}} dx &= \int_{\pi/4}^{\pi/3} \sec^2 u du, \text{ where } u = \sec^{-1} x \text{ and } du = \frac{dx}{x\sqrt{x^2-1}}; x = \sqrt{2} \Rightarrow u = \frac{\pi}{4}, x = 2 \Rightarrow u = \frac{\pi}{3} \\
 &= [\tan u]_{\pi/4}^{\pi/3} = \tan \frac{\pi}{3} - \tan \frac{\pi}{4} = \sqrt{3} - 1
 \end{aligned}$$

$$\begin{aligned}
 112. \int_{2/\sqrt{3}}^2 \frac{\cos(\sec^{-1} x)}{x\sqrt{x^2-1}} dx &= \int_{\pi/6}^{\pi/3} \cos u du, \text{ where } u = \sec^{-1} x \text{ and } du = \frac{dx}{x\sqrt{x^2-1}}; x = \frac{2}{\sqrt{3}} \Rightarrow u = \frac{\pi}{6}, x = 2 \Rightarrow u = \frac{\pi}{3} \\
 &= [\sin u]_{\pi/6}^{\pi/3} = \sin \frac{\pi}{3} - \sin \frac{\pi}{6} = \frac{\sqrt{3}-1}{2}
 \end{aligned}$$

$$113. \lim_{x \rightarrow 0} \frac{\sin^{-1} 5x}{x} = \lim_{x \rightarrow 0} \frac{\left(\frac{5}{\sqrt{1-25x^2}}\right)}{1} = 5$$

$$114. \lim_{x \rightarrow 1^+} \frac{\sqrt{x^2-1}}{\sec^{-1} x} = \lim_{x \rightarrow 1^+} \frac{(x^2-1)^{1/2}}{\sec^{-1} x} = \lim_{x \rightarrow 1^+} \frac{\left(\frac{1}{2}\right)(x^2-1)^{-1/2}(2x)}{\left(\frac{1}{|x|\sqrt{x^2-1}}\right)} = \lim_{x \rightarrow 1^+} x|x| = 1$$

$$115. \lim_{x \rightarrow \infty} x \tan^{-1} \left(\frac{2}{x}\right) = \lim_{x \rightarrow \infty} \frac{\tan^{-1}(2x^{-1})}{x^{-1}} = \lim_{x \rightarrow \infty} \frac{\left(\frac{-2x^{-2}}{1+4x^{-2}}\right)}{-x^{-2}} = \lim_{x \rightarrow \infty} \frac{2}{1+4x^{-2}} = 2$$

$$116. \lim_{x \rightarrow 0} \frac{2 \tan^{-1} 3x^2}{7x^2} = \lim_{x \rightarrow 0} \frac{\left(\frac{12x}{1+9x^4}\right)}{14x} = \lim_{x \rightarrow 0} \frac{6}{7(1+9x^4)} = \frac{6}{7}$$

$$117. \text{ If } y = \ln x - \frac{1}{2} \ln(1+x^2) - \frac{\tan^{-1} x}{x} + C, \text{ then } dy = \left[\frac{1}{x} - \frac{x}{1+x^2} - \frac{\left(\frac{x}{1+x^2}\right) - \tan^{-1} x}{x^2} \right] dx$$

$$= \left(\frac{1}{x} - \frac{x}{1+x^2} - \frac{1}{x(1+x^2)} + \frac{\tan^{-1} x}{x^2} \right) dx = \frac{x(1+x^2) - x^3 - x + (\tan^{-1} x)(1+x^2)}{x^2(1+x^2)} dx = \frac{\tan^{-1} x}{x^2} dx,$$

which verifies the formula

$$118. \text{ If } y = \frac{x^4}{4} \cos^{-1} 5x + \frac{5}{4} \int \frac{x^4}{\sqrt{1-25x^2}} dx, \text{ then } dy = \left[x^3 \cos^{-1} 5x + \left(\frac{x^4}{4}\right) \left(\frac{-5}{\sqrt{1-25x^2}}\right) + \frac{5}{4} \left(\frac{x^4}{\sqrt{1-25x^2}}\right) \right] dx$$

$$= (x^3 \cos^{-1} 5x) dx, \text{ which verifies the formula}$$

$$119. \text{ If } y = x(\sin^{-1} x)^2 - 2x + 2\sqrt{1-x^2} \sin^{-1} x + C, \text{ then}$$

$$dy = \left[(\sin^{-1} x)^2 + \frac{2x(\sin^{-1} x)}{\sqrt{1-x^2}} - 2 + \frac{-2x}{\sqrt{1-x^2}} \sin^{-1} x + 2\sqrt{1-x^2} \left(\frac{1}{\sqrt{1-x^2}}\right) \right] dx = (\sin^{-1} x)^2 dx, \text{ which verifies the formula}$$

$$120. \text{ If } y = x \ln(a^2 + x^2) - 2x + 2a \tan^{-1} \left(\frac{x}{a}\right) + C, \text{ then } dy = \left[\ln(a^2 + x^2) + \frac{2x^2}{a^2 + x^2} - 2 + \frac{2}{1 + \left(\frac{x}{a}\right)^2} \right] dx$$

$$= \left[\ln(a^2 + x^2) + 2 \left(\frac{a^2 + x^2}{a^2 + x^2}\right) - 2 \right] dx = \ln(a^2 + x^2) dx, \text{ which verifies the formula}$$

$$121. \frac{dy}{dx} = \frac{1}{\sqrt{1-x^2}} \Rightarrow dy = \frac{dx}{\sqrt{1-x^2}} \Rightarrow y = \sin^{-1} x + C; x = 0 \text{ and } y = 0 \Rightarrow 0 = \sin^{-1} 0 + C \Rightarrow C = 0 \Rightarrow y = \sin^{-1} x$$

$$122. \frac{dy}{dx} = \frac{1}{x^2+1} - 1 \Rightarrow dy = \left(\frac{1}{1+x^2} - 1\right) dx \Rightarrow y = \tan^{-1}(x) - x + C; x = 0 \text{ and } y = 1 \Rightarrow 1 = \tan^{-1} 0 - 0 + C$$

$$\Rightarrow C = 1 \Rightarrow y = \tan^{-1}(x) - x + 1$$

$$123. \frac{dy}{dx} = \frac{1}{x\sqrt{x^2-1}} \Rightarrow dy = \frac{dx}{x\sqrt{x^2-1}} \Rightarrow y = \sec^{-1} |x| + C; x = 2 \text{ and } y = \pi \Rightarrow \pi = \sec^{-1} 2 + C \Rightarrow C = \pi - \sec^{-1} 2$$

$$= \pi - \frac{\pi}{3} = \frac{2\pi}{3} \Rightarrow y = \sec^{-1}(x) + \frac{2\pi}{3}, x > 1$$

$$124. \frac{dy}{dx} = \frac{1}{1+x^2} - \frac{2}{\sqrt{1-x^2}} \Rightarrow dy = \left(\frac{1}{1+x^2} - \frac{2}{\sqrt{1-x^2}}\right) dx \Rightarrow y = \tan^{-1} x - 2 \sin^{-1} x + C; x = 0 \text{ and } y = 2$$

$$\Rightarrow 2 = \tan^{-1} 0 - 2 \sin^{-1} 0 + C \Rightarrow C = 2 \Rightarrow y = \tan^{-1} x - 2 \sin^{-1} x + 2$$

125. The angle α is the large angle between the wall and the right end of the blackboard minus the small angle between the left end of the blackboard and the wall $\Rightarrow \alpha = \cot^{-1} \left(\frac{x}{15}\right) - \cot^{-1} \left(\frac{x}{3}\right)$.

$$126. V = \pi \int_0^{\pi/3} [2^2 - (\sec y)^2] dy = \pi [4y - \tan y]_0^{\pi/3} = \pi \left(\frac{4\pi}{3} - \sqrt{3}\right)$$

127. $V = \left(\frac{1}{3}\right) \pi r^2 h = \left(\frac{1}{3}\right) \pi (3 \sin \theta)^2 (3 \cos \theta) = 9\pi (\cos \theta - \cos^3 \theta)$, where $0 \leq \theta \leq \frac{\pi}{2} \Rightarrow \frac{dV}{d\theta} = -9\pi (\sin \theta) (1 - 3 \cos^2 \theta)$
 $= 0 \Rightarrow \sin \theta = 0$ or $\cos \theta = \pm \frac{1}{\sqrt{3}} \Rightarrow$ the critical points are: $0, \cos^{-1} \left(\frac{1}{\sqrt{3}}\right)$, and $\cos^{-1} \left(-\frac{1}{\sqrt{3}}\right)$; but $\cos^{-1} \left(-\frac{1}{\sqrt{3}}\right)$ is not in the domain. When $\theta = 0$, we have a minimum and when $\theta = \cos^{-1} \left(\frac{1}{\sqrt{3}}\right) \approx 54.7^\circ$, we have a maximum volume.

$$128. 65^\circ + (90^\circ - \beta) + (90^\circ - \alpha) = 180^\circ \Rightarrow \alpha = 65^\circ - \beta = 65^\circ - \tan^{-1} \left(\frac{21}{50}\right) \approx 65^\circ - 22.78^\circ \approx 42.22^\circ$$

129. Take each square as a unit square. From the diagram we have the following: the smallest angle α has a tangent of 1 $\Rightarrow \alpha = \tan^{-1} 1$; the middle angle β has a tangent of 2 $\Rightarrow \beta = \tan^{-1} 2$; and the largest angle γ has a tangent of 3 $\Rightarrow \gamma = \tan^{-1} 3$. The sum of these three angles is $\pi \Rightarrow \alpha + \beta + \gamma = \pi$
 $\Rightarrow \tan^{-1} 1 + \tan^{-1} 2 + \tan^{-1} 3 = \pi$.

130. (a) From the symmetry of the diagram, we see that $\pi - \sec^{-1} x$ is the vertical distance from the graph of $y = \sec^{-1} x$ to the line $y = \pi$ and this distance is the same as the height of $y = \sec^{-1} x$ above the x -axis at $-x$; i.e., $\pi - \sec^{-1} x = \sec^{-1}(-x)$.
 (b) $\cos^{-1}(-x) = \pi - \cos^{-1} x$, where $-1 \leq x \leq 1 \Rightarrow \cos^{-1}(-\frac{1}{x}) = \pi - \cos^{-1}(\frac{1}{x})$, where $x \geq 1$ or $x \leq -1 \Rightarrow \sec^{-1}(-x) = \pi - \sec^{-1} x$
131. $\sin^{-1}(1) + \cos^{-1}(1) = \frac{\pi}{2} + 0 = \frac{\pi}{2}$; $\sin^{-1}(0) + \cos^{-1}(0) = 0 + \frac{\pi}{2} = \frac{\pi}{2}$; and $\sin^{-1}(-1) + \cos^{-1}(-1) = -\frac{\pi}{2} + \pi = \frac{\pi}{2}$.
 If $x \in (-1, 0)$ and $x = -a$, then $\sin^{-1}(x) + \cos^{-1}(x) = \sin^{-1}(-a) + \cos^{-1}(-a) = -\sin^{-1} a + (\pi - \cos^{-1} a) = \pi - (\sin^{-1} a + \cos^{-1} a) = \pi - \frac{\pi}{2} = \frac{\pi}{2}$ from Equations (3) and (4) in the text.

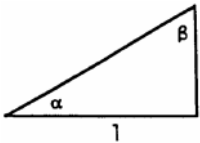
132.  $x \Rightarrow \tan \alpha = x$ and $\tan \beta = \frac{1}{x} \Rightarrow \frac{\pi}{2} = \alpha + \beta = \tan^{-1} x + \tan^{-1} \frac{1}{x}$.

133. (a) Defined; there is an angle whose tangent is 2.
 (b) Not defined; there is no angle whose cosine is 2.
134. (a) Not defined; there is no angle whose cosecant is $\frac{1}{2}$.
 (b) Defined; there is an angle whose cosecant is 2.
135. (a) Not defined; there is no angle whose secant is 0.
 (b) Not defined; there is no angle whose sine is $\sqrt{2}$.
136. (a) Defined; there is an angle whose cotangent is $-\frac{1}{2}$.
 (b) Not defined; there is no angle whose cosine is -5 .

137. $\alpha(x) = \cot^{-1}(\frac{x}{15}) - \cot^{-1}(\frac{x}{3})$, $x > 0 \Rightarrow \alpha'(x) = \frac{-15}{225+x^2} + \frac{3}{9+x^2} = \frac{-15(9+x^2) + 3(225+x^2)}{(225+x^2)(9+x^2)}$; solving $\alpha'(x) = 0 \Rightarrow -135 - 15x^2 + 675 + 3x^2 = 0 \Rightarrow x = 3\sqrt{5}$; $\alpha'(x) > 0$ when $0 < x < 3\sqrt{5}$ and $\alpha'(x) < 0$ for $x > 3\sqrt{5} \Rightarrow$ there is a maximum at $3\sqrt{5}$ ft from the front of the room

138. From the accompanying figure, $\alpha + \beta + \theta = \pi$, $\cot \alpha = \frac{x}{1}$ and $\cot \beta = \frac{2-x}{1} \Rightarrow \theta = \pi - \cot^{-1} x - \cot^{-1}(2-x)$
 $\Rightarrow \frac{d\theta}{dx} = \frac{1}{1+x^2} - \frac{1}{1+(2-x)^2} = \frac{1+(2-x)^2 - (1+x^2)}{(1+x^2)[1+(2-x)^2]}$

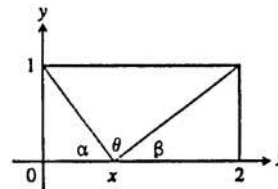

$= \frac{4-4x}{(1+x^2)[1+(2-x)^2]}$; solving $\frac{d\theta}{dx} = 0 \Rightarrow x = 1$; $\frac{d\theta}{dx} > 0$ for $0 < x < 1$ and $\frac{d\theta}{dx} < 0$ for $x > 1$
 \Rightarrow at $x = 1$ there is a maximum $\theta = \pi - \cot^{-1} 1 - \cot^{-1}(2-1) = \pi - \frac{\pi}{4} - \frac{\pi}{4} = \frac{\pi}{2}$

139. Yes, $\sin^{-1} x$ and $-\cos^{-1} x$ differ by the constant $\frac{\pi}{2}$
140. Yes, the derivatives of $y = -\cos^{-1} x + C$ and $y = \cos^{-1}(-x) + C$ are both $\frac{1}{\sqrt{1-x^2}}$
141. $\csc^{-1} u = \frac{\pi}{2} - \sec^{-1} u \Rightarrow \frac{d}{dx}(\csc^{-1} u) = \frac{d}{dx}(\frac{\pi}{2} - \sec^{-1} u) = 0 - \frac{\frac{du}{dx}}{|u|\sqrt{u^2-1}} = -\frac{\frac{du}{dx}}{|u|\sqrt{u^2-1}}$, $|u| > 1$

$$\begin{aligned}
 142. \quad y = \tan^{-1} x &\Rightarrow \tan y = x \Rightarrow \frac{d}{dx}(\tan y) = \frac{d}{dx}(x) \\
 &\Rightarrow (\sec^2 y) \frac{dy}{dx} = 1 \Rightarrow \frac{dy}{dx} = \frac{1}{\sec^2 y} = \frac{1}{(\sqrt{1+x^2})^2} \\
 &= \frac{1}{1+x^2}, \text{ as indicated by the triangle}
 \end{aligned}$$

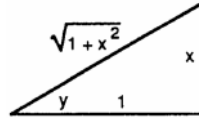

$$143. \quad f(x) = \sec x \Rightarrow f'(x) = \sec x \tan x \Rightarrow \left. \frac{df^{-1}}{dx} \right|_{x=b} = \frac{1}{\left. \frac{df}{dx} \right|_{x=f^{-1}(b)}} = \frac{1}{\sec(\sec^{-1} b) \tan(\sec^{-1} b)} = \frac{1}{b(\pm\sqrt{b^2-1})}.$$

Since the slope of $\sec^{-1} x$ is always positive, we the right sign by writing $\frac{d}{dx} \sec^{-1} x = \frac{1}{|x|\sqrt{x^2-1}}$.

$$144. \quad \cot^{-1} u = \frac{\pi}{2} - \tan^{-1} u \Rightarrow \frac{d}{dx}(\cot^{-1} u) = \frac{d}{dx}\left(\frac{\pi}{2} - \tan^{-1} u\right) = 0 - \frac{\frac{du}{dx}}{1+u^2} = -\frac{\frac{du}{dx}}{1+u^2}$$

145. The functions f and g have the same derivative (for $x \geq 0$), namely $\frac{1}{\sqrt{x(x+1)}}$. The functions therefore differ by a constant. To identify the constant we can set x equal to 0 in the equation $f(x) = g(x) + C$, obtaining $\sin^{-1}(-1) = 2 \tan^{-1}(0) + C \Rightarrow -\frac{\pi}{2} = 0 + C \Rightarrow C = -\frac{\pi}{2}$. For $x \geq 0$, we have $\sin^{-1}\left(\frac{x-1}{x+1}\right) = 2 \tan^{-1} \sqrt{x} - \frac{\pi}{2}$.

146. The functions f and g have the same derivative for $x > 0$, namely $\frac{-1}{1+x^2}$. The functions therefore differ by a constant for $x > 0$. To identify the constant we can set x equal to 1 in the equation $f(x) = g(x) + C$, obtaining $\sin^{-1}\left(\frac{1}{\sqrt{2}}\right) = \tan^{-1} 1 + C \Rightarrow \frac{\pi}{4} = \frac{\pi}{4} + C \Rightarrow C = 0$. For $x > 0$, we have $\sin^{-1} \frac{1}{\sqrt{x^2+1}} = \tan^{-1} \frac{1}{x}$.

$$\begin{aligned}
 147. \quad V &= \pi \int_{-\sqrt{3}/3}^{\sqrt{3}} \left(\frac{1}{\sqrt{1+x^2}}\right)^2 dx = \pi \int_{-\sqrt{3}/3}^{\sqrt{3}} \frac{1}{1+x^2} dx = \pi [\tan^{-1} x]_{-\sqrt{3}/3}^{\sqrt{3}} = \pi \left[\tan^{-1} \sqrt{3} - \tan^{-1}\left(-\frac{\sqrt{3}}{3}\right)\right] \\
 &= \pi \left[\frac{\pi}{3} - \left(-\frac{\pi}{6}\right)\right] = \frac{\pi^2}{2}
 \end{aligned}$$

$$\begin{aligned}
 148. \quad y = \sqrt{1-x^2} &= (1-x^2)^{1/2} \Rightarrow y' = \left(\frac{1}{2}\right)(1-x^2)^{-1/2}(-2x) \Rightarrow 1 + (y')^2 = \frac{1}{1-x^2}; L = \int_{-1/2}^{1/2} \sqrt{1+(y')^2} dx \\
 &= 2 \int_0^{1/2} \frac{1}{\sqrt{1-x^2}} dx = 2 [\sin^{-1} x]_0^{1/2} = 2\left(\frac{\pi}{6} - 0\right) = \frac{\pi}{3}
 \end{aligned}$$

$$\begin{aligned}
 149. \quad (a) \quad A(x) &= \frac{\pi}{4} (\text{diameter})^2 = \frac{\pi}{4} \left[\frac{1}{\sqrt{1+x^2}} - \left(-\frac{1}{\sqrt{1+x^2}}\right)\right]^2 = \frac{\pi}{1+x^2} \Rightarrow V = \int_a^b A(x) dx = \int_{-1}^1 \frac{\pi dx}{1+x^2} \\
 &= \pi [\tan^{-1} x]_{-1}^1 = (\pi)(2) \left(\frac{\pi}{4}\right) = \frac{\pi^2}{2}
 \end{aligned}$$

$$\begin{aligned}
 (b) \quad A(x) &= (\text{edge})^2 = \left[\frac{1}{\sqrt{1+x^2}} - \left(-\frac{1}{\sqrt{1+x^2}}\right)\right]^2 = \frac{4}{1+x^2} \Rightarrow V = \int_a^b A(x) dx = \int_{-1}^1 \frac{4 dx}{1+x^2} \\
 &= 4 [\tan^{-1} x]_{-1}^1 = 4 [\tan^{-1}(1) - \tan^{-1}(-1)] = 4 \left[\frac{\pi}{4} - \left(-\frac{\pi}{4}\right)\right] = 2\pi
 \end{aligned}$$

$$\begin{aligned}
 150. \quad (a) \quad A(x) &= \frac{\pi}{4} (\text{diameter})^2 = \frac{\pi}{4} \left(\frac{2}{\sqrt{1-x^2}} - 0\right)^2 = \frac{\pi}{4} \left(\frac{4}{\sqrt{1-x^2}}\right) = \frac{\pi}{\sqrt{1-x^2}} \Rightarrow V = \int_a^b A(x) dx \\
 &= \int_{-\sqrt{2}/2}^{\sqrt{2}/2} \frac{\pi}{\sqrt{1-x^2}} dx = \pi [\sin^{-1} x]_{-\sqrt{2}/2}^{\sqrt{2}/2} = \pi \left[\sin^{-1}\left(\frac{\sqrt{2}}{2}\right) - \sin^{-1}\left(-\frac{\sqrt{2}}{2}\right)\right] = \pi \left[\frac{\pi}{4} - \left(-\frac{\pi}{4}\right)\right] = \frac{\pi^2}{2}
 \end{aligned}$$

$$\begin{aligned}
 (b) \quad A(x) &= \frac{(\text{diagonal})^2}{2} = \frac{1}{2} \left(\frac{2}{\sqrt{1-x^2}} - 0\right)^2 = \frac{2}{\sqrt{1-x^2}} \Rightarrow V = \int_a^b A(x) dx = \int_{-\sqrt{2}/2}^{\sqrt{2}/2} \frac{2}{\sqrt{1-x^2}} dx \\
 &= 2 [\sin^{-1} x]_{-\sqrt{2}/2}^{\sqrt{2}/2} = 2 \left(\frac{\pi}{4} \cdot 2\right) = \pi
 \end{aligned}$$

$$151. \quad (a) \quad \sec^{-1} 1.5 = \cos^{-1} \frac{1}{1.5} \approx 0.84107$$

$$(b) \quad \csc^{-1}(-1.5) = \sin^{-1}\left(-\frac{1}{1.5}\right) \approx -0.72973$$

$$(c) \quad \cot^{-1} 2 = \frac{\pi}{2} - \tan^{-1} 2 \approx 0.46365$$

$$152. \quad (a) \quad \sec^{-1}(-3) = \cos^{-1}\left(-\frac{1}{3}\right) \approx 1.91063$$

$$(b) \quad \csc^{-1} 1.7 = \sin^{-1}\left(\frac{1}{1.7}\right) \approx 0.62887$$

$$(c) \quad \cot^{-1}(-2) = \frac{\pi}{2} - \tan^{-1}(-2) \approx 2.67795$$

153. (a) Domain: all real numbers except those having the form $\frac{\pi}{2} + k\pi$ where k is an integer.
 Range: $-\frac{\pi}{2} < y < \frac{\pi}{2}$

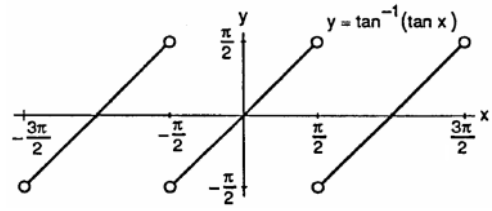

- (b) Domain: $-\infty < x < \infty$; Range: $-\infty < y < \infty$
 The graph of $y = \tan^{-1}(\tan x)$ is periodic; the graph of $y = \tan(\tan^{-1} x) = x$ for $-\infty \leq x < \infty$.

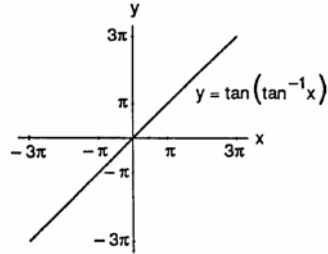

154. (a) Domain: $-\infty < x < \infty$; Range: $-\frac{\pi}{2} \leq y \leq \frac{\pi}{2}$

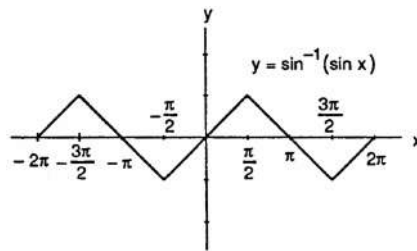

- (b) Domain: $-1 \leq x \leq 1$; Range: $-1 \leq y \leq 1$
 The graph of $y = \sin^{-1}(\sin x)$ is periodic; the graph of $y = \sin(\sin^{-1} x) = x$ for $-1 \leq x \leq 1$.

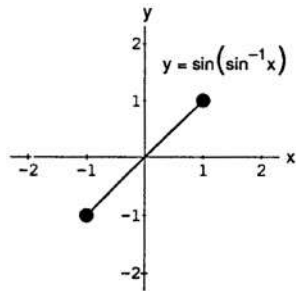

155. (a) Domain: $-\infty < x < \infty$; Range: $0 \leq y \leq \pi$

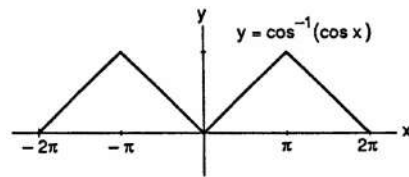

- (b) Domain: $-1 \leq x \leq 1$; Range: $-1 \leq y \leq 1$
 The graph of $y = \cos^{-1}(\cos x)$ is periodic; the graph of $y = \cos(\cos^{-1} x) = x$ for $-1 \leq x \leq 1$.

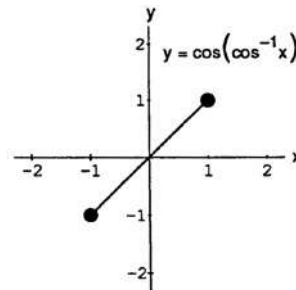

156. Since the domain of $\sec^{-1} x$ is $(-\infty, -1] \cup [1, \infty)$, we have $\sec(\sec^{-1} x) = x$ for $|x| \geq 1$. The graph of $y = \sec(\sec^{-1} x)$ is the line $y = x$ with the open line segment from $(-1, -1)$ to $(1, 1)$ removed.

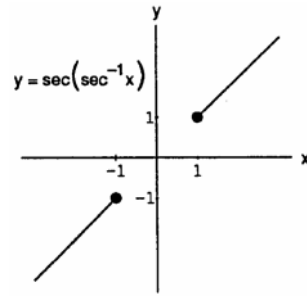

157. The graphs are identical for $y = 2 \sin(2 \tan^{-1} x)$
 $= 4 [\sin(\tan^{-1} x)] [\cos(\tan^{-1} x)] = 4 \left(\frac{x}{\sqrt{x^2+1}} \right) \left(\frac{1}{\sqrt{x^2+1}} \right)$
 $= \frac{4x}{x^2+1}$ from the triangle

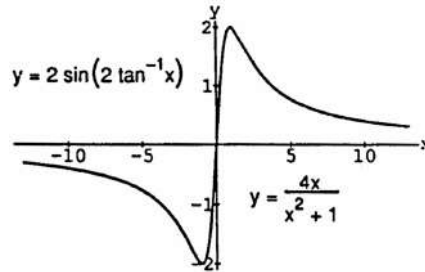
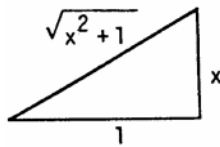

158. The graphs are identical for $y = \cos(2 \sec^{-1} x)$
 $= \cos^2(\sec^{-1} x) - \sin^2(\sec^{-1} x) = \frac{1}{x^2} - \frac{x^2-1}{x^2}$

$= \frac{2-x^2}{x^2}$ from the triangle

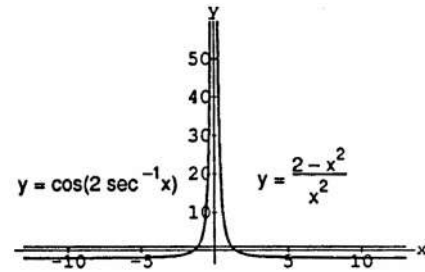
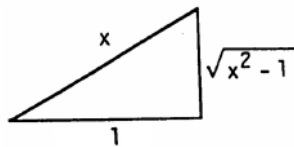

159. The values of f increase over the interval $[-1, 1]$ because $f' > 0$, and the graph of f steepens as the values of f' increase towards the ends of the interval. The graph of f is concave down to the left of the origin where $f'' < 0$, and concave up to the right of the origin where $f'' > 0$. There is an inflection point at $x = 0$ where $f'' = 0$ and f' has a local minimum value.

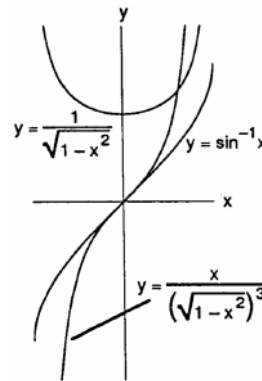

160. The values of f increase throughout the interval $(-\infty, \infty)$ because $f' > 0$, and they increase most rapidly near the origin where the values of f' are relatively large. The graph of f is concave up to the left of the origin where $f'' > 0$, and concave down to the right of the origin where $f'' < 0$. There is an inflection point at $x = 0$ where $f'' = 0$ and f' has a local maximum value.

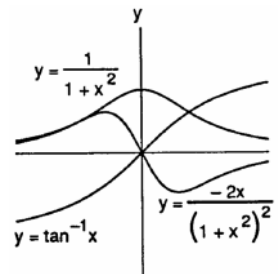

7.8 HYPERBOLIC FUNCTIONS

1. $\sinh x = -\frac{3}{4} \Rightarrow \cosh x = \sqrt{1 + \sinh^2 x} = \sqrt{1 + \left(-\frac{3}{4}\right)^2} = \sqrt{1 + \frac{9}{16}} = \sqrt{\frac{25}{16}} = \frac{5}{4}$, $\tanh x = \frac{\sinh x}{\cosh x} = \frac{\left(-\frac{3}{4}\right)}{\left(\frac{5}{4}\right)} = -\frac{3}{5}$,
 $\coth x = \frac{1}{\tanh x} = -\frac{5}{3}$, $\operatorname{sech} x = \frac{1}{\cosh x} = \frac{4}{5}$, and $\operatorname{csch} x = \frac{1}{\sinh x} = -\frac{4}{3}$
2. $\sinh x = \frac{4}{3} \Rightarrow \cosh x = \sqrt{1 + \sinh^2 x} = \sqrt{1 + \frac{16}{9}} = \sqrt{\frac{25}{9}} = \frac{5}{3}$, $\tanh x = \frac{\sinh x}{\cosh x} = \frac{\left(\frac{4}{3}\right)}{\left(\frac{5}{3}\right)} = \frac{4}{5}$, $\coth x = \frac{1}{\tanh x} = \frac{5}{4}$,
 $\operatorname{sech} x = \frac{1}{\cosh x} = \frac{3}{5}$, and $\operatorname{csch} x = \frac{1}{\sinh x} = \frac{3}{4}$
3. $\cosh x = \frac{17}{15}$, $x > 0 \Rightarrow \sinh x = \sqrt{\cosh^2 x - 1} = \sqrt{\left(\frac{17}{15}\right)^2 - 1} = \sqrt{\frac{289}{225} - 1} = \sqrt{\frac{64}{225}} = \frac{8}{15}$, $\tanh x = \frac{\sinh x}{\cosh x} = \frac{\left(\frac{8}{15}\right)}{\left(\frac{17}{15}\right)}$
 $= \frac{8}{17}$, $\coth x = \frac{1}{\tanh x} = \frac{17}{8}$, $\operatorname{sech} x = \frac{1}{\cosh x} = \frac{15}{17}$, and $\operatorname{csch} x = \frac{1}{\sinh x} = \frac{15}{8}$
4. $\cosh x = \frac{13}{5}$, $x > 0 \Rightarrow \sinh x = \sqrt{\cosh^2 x - 1} = \sqrt{\frac{169}{25} - 1} = \sqrt{\frac{144}{25}} = \frac{12}{5}$, $\tanh x = \frac{\sinh x}{\cosh x} = \frac{\left(\frac{12}{5}\right)}{\left(\frac{13}{5}\right)} = \frac{12}{13}$,
 $\coth x = \frac{1}{\tanh x} = \frac{13}{12}$, $\operatorname{sech} x = \frac{1}{\cosh x} = \frac{5}{13}$, and $\operatorname{csch} x = \frac{1}{\sinh x} = \frac{5}{12}$
5. $2 \cosh(\ln x) = 2 \left(\frac{e^{\ln x} + e^{-\ln x}}{2} \right) = e^{\ln x} + \frac{1}{e^{\ln x}} = x + \frac{1}{x}$
6. $\sinh(2 \ln x) = \frac{e^{2 \ln x} - e^{-2 \ln x}}{2} = \frac{e^{\ln x^2} - e^{-\ln x^2}}{2} = \frac{\left(x^2 - \frac{1}{x^2}\right)}{2} = \frac{x^4 - 1}{2x^2}$
7. $\cosh 5x + \sinh 5x = \frac{e^{5x} + e^{-5x}}{2} + \frac{e^{5x} - e^{-5x}}{2} = e^{5x}$
8. $\cosh 3x - \sinh 3x = \frac{e^{3x} + e^{-3x}}{2} - \frac{e^{3x} - e^{-3x}}{2} = e^{-3x}$
9. $(\sinh x + \cosh x)^4 = \left(\frac{e^x - e^{-x}}{2} + \frac{e^x + e^{-x}}{2} \right)^4 = (e^x)^4 = e^{4x}$
10. $\ln(\cosh x + \sinh x) + \ln(\cosh x - \sinh x) = \ln(\cosh^2 x - \sinh^2 x) = \ln 1 = 0$
11. (a) $\sinh 2x = \sinh(x + x) = \sinh x \cosh x + \cosh x \sinh x = 2 \sinh x \cosh x$
 (b) $\cosh 2x = \cosh(x + x) = \cosh x \cosh x + \sinh x \sinh x = \cosh^2 x + \sinh^2 x$
12. $\cosh^2 x - \sinh^2 x = \left(\frac{e^x + e^{-x}}{2} \right)^2 - \left(\frac{e^x - e^{-x}}{2} \right)^2 = \frac{1}{4} [(e^x + e^{-x}) + (e^x - e^{-x})] [(e^x + e^{-x}) - (e^x - e^{-x})]$
 $= \frac{1}{4} (2e^x) (2e^{-x}) = \frac{1}{4} (4e^0) = \frac{1}{4} (4) = 1$
13. $y = 6 \sinh \frac{x}{3} \Rightarrow \frac{dy}{dx} = 6 \left(\cosh \frac{x}{3} \right) \left(\frac{1}{3} \right) = 2 \cosh \frac{x}{3}$
14. $y = \frac{1}{2} \sinh(2x + 1) \Rightarrow \frac{dy}{dx} = \frac{1}{2} [\cosh(2x + 1)](2) = \cosh(2x + 1)$
15. $y = 2\sqrt{t} \tanh \sqrt{t} = 2t^{1/2} \tanh t^{1/2} \Rightarrow \frac{dy}{dt} = [\operatorname{sech}^2(t^{1/2})] \left(\frac{1}{2} t^{-1/2} \right) (2t^{1/2}) + (\tanh t^{1/2}) (t^{-1/2})$
 $= \operatorname{sech}^2 \sqrt{t} + \frac{\tanh \sqrt{t}}{\sqrt{t}}$
16. $y = t^2 \tanh \frac{1}{t} = t^2 \tanh t^{-1} \Rightarrow \frac{dy}{dt} = [\operatorname{sech}^2(t^{-1})] (-t^{-2}) (t^2) + (2t) (\tanh t^{-1}) = -\operatorname{sech}^2 \frac{1}{t} + 2t \tanh \frac{1}{t}$
17. $y = \ln(\sinh z) \Rightarrow \frac{dy}{dz} = \frac{\cosh z}{\sinh z} = \coth z$
18. $y = \ln(\cosh z) \Rightarrow \frac{dy}{dz} = \frac{\sinh z}{\cosh z} = \tanh z$

19. $y = (\operatorname{sech} \theta)(1 - \ln \operatorname{sech} \theta) \Rightarrow \frac{dy}{d\theta} = \left(-\frac{-\operatorname{sech} \theta \tanh \theta}{\operatorname{sech} \theta}\right) (\operatorname{sech} \theta) + (-\operatorname{sech} \theta \tanh \theta)(1 - \ln \operatorname{sech} \theta)$
 $= \operatorname{sech} \theta \tanh \theta - (\operatorname{sech} \theta \tanh \theta)(1 - \ln \operatorname{sech} \theta) = (\operatorname{sech} \theta \tanh \theta)[1 - (1 - \ln \operatorname{sech} \theta)]$
 $= (\operatorname{sech} \theta \tanh \theta)(\ln \operatorname{sech} \theta)$
20. $y = (\operatorname{csch} \theta)(1 - \ln \operatorname{csch} \theta) \Rightarrow \frac{dy}{d\theta} = (\operatorname{csch} \theta) \left(-\frac{-\operatorname{csch} \theta \coth \theta}{\operatorname{csch} \theta}\right) + (1 - \ln \operatorname{csch} \theta)(-\operatorname{csch} \theta \coth \theta)$
 $= \operatorname{csch} \theta \coth \theta - (1 - \ln \operatorname{csch} \theta)(\operatorname{csch} \theta \coth \theta) = (\operatorname{csch} \theta \coth \theta)(1 - 1 + \ln \operatorname{csch} \theta) = (\operatorname{csch} \theta \coth \theta)(\ln \operatorname{csch} \theta)$
21. $y = \ln \cosh v - \frac{1}{2} \tanh^2 v \Rightarrow \frac{dy}{dv} = \frac{\sinh v}{\cosh v} - \left(\frac{1}{2}\right) (2 \tanh v) (\operatorname{sech}^2 v) = \tanh v - (\tanh v) (\operatorname{sech}^2 v)$
 $= (\tanh v) (1 - \operatorname{sech}^2 v) = (\tanh v) (\tanh^2 v) = \tanh^3 v$
22. $y = \ln \sinh v - \frac{1}{2} \coth^2 v \Rightarrow \frac{dy}{dv} = \frac{\cosh v}{\sinh v} - \left(\frac{1}{2}\right) (2 \coth v) (-\operatorname{csch}^2 v) = \coth v + (\coth v) (\operatorname{csch}^2 v)$
 $= (\coth v) (1 + \operatorname{csch}^2 v) = (\coth v) (\coth^2 v) = \coth^3 v$
23. $y = (x^2 + 1) \operatorname{sech}(\ln x) = (x^2 + 1) \left(\frac{2}{e^{\ln x} + e^{-\ln x}}\right) = (x^2 + 1) \left(\frac{2}{x + x^{-1}}\right) = (x^2 + 1) \left(\frac{2x}{x^2 + 1}\right) = 2x \Rightarrow \frac{dy}{dx} = 2$
24. $y = (4x^2 - 1) \operatorname{csch}(\ln 2x) = (4x^2 - 1) \left(\frac{2}{e^{\ln 2x} + e^{-\ln 2x}}\right) = (4x^2 - 1) \left(\frac{2}{2x - (2x)^{-1}}\right) = (4x^2 - 1) \left(\frac{4x}{4x^2 - 1}\right)$
 $= 4x \Rightarrow \frac{dy}{dx} = 4$
25. $y = \sinh^{-1} \sqrt{x} = \sinh^{-1} (x^{1/2}) \Rightarrow \frac{dy}{dx} = \frac{\left(\frac{1}{2}\right)x^{-1/2}}{\sqrt{1 + (x^{1/2})^2}} = \frac{1}{2\sqrt{x}\sqrt{1+x}} = \frac{1}{2\sqrt{x(1+x)}}$
26. $y = \cosh^{-1} 2\sqrt{x+1} = \cosh^{-1} (2(x+1)^{1/2}) \Rightarrow \frac{dy}{dx} = \frac{(2)\left(\frac{1}{2}\right)(x+1)^{-1/2}}{\sqrt{[2(x+1)^{1/2}]^2 - 1}} = \frac{1}{\sqrt{x+1}\sqrt{4x+3}} = \frac{1}{\sqrt{4x^2+7x+3}}$
27. $y = (1 - \theta) \tanh^{-1} \theta \Rightarrow \frac{dy}{d\theta} = (1 - \theta) \left(\frac{1}{1 - \theta^2}\right) + (-1) \tanh^{-1} \theta = \frac{1}{1 + \theta} - \tanh^{-1} \theta$
28. $y = (\theta^2 + 2\theta) \tanh^{-1} (\theta + 1) \Rightarrow \frac{dy}{d\theta} = (\theta^2 + 2\theta) \left[\frac{1}{1 - (\theta + 1)^2}\right] + (2\theta + 2) \tanh^{-1} (\theta + 1)$
 $= \frac{\theta^2 + 2\theta}{-\theta^2 - 2\theta} + (2\theta + 2) \tanh^{-1} (\theta + 1) = (2\theta + 2) \tanh^{-1} (\theta + 1) - 1$
29. $y = (1 - t) \coth^{-1} \sqrt{t} = (1 - t) \coth^{-1} (t^{1/2}) \Rightarrow \frac{dy}{dt} = (1 - t) \left[\frac{\left(\frac{1}{2}\right)t^{-1/2}}{1 - (t^{1/2})^2}\right] + (-1) \coth^{-1} (t^{1/2}) = \frac{1}{2\sqrt{t}} - \coth^{-1} \sqrt{t}$
30. $y = (1 - t^2) \coth^{-1} t \Rightarrow \frac{dy}{dt} = (1 - t^2) \left(\frac{-1}{1 - t^2}\right) + (-2t) \coth^{-1} t = 1 - 2t \coth^{-1} t$
31. $y = \cos^{-1} x - x \operatorname{sech}^{-1} x \Rightarrow \frac{dy}{dx} = \frac{-1}{\sqrt{1-x^2}} - \left[x \left(\frac{-1}{x\sqrt{1-x^2}}\right) + (1) \operatorname{sech}^{-1} x\right] = \frac{-1}{\sqrt{1-x^2}} + \frac{1}{\sqrt{1-x^2}} - \operatorname{sech}^{-1} x$
 $= -\operatorname{sech}^{-1} x$
32. $y = \ln x + \sqrt{1-x^2} \operatorname{sech}^{-1} x = \ln x + (1-x^2)^{1/2} \operatorname{sech}^{-1} x \Rightarrow \frac{dy}{dx}$
 $= \frac{1}{x} + (1-x^2)^{1/2} \left(\frac{-1}{x\sqrt{1-x^2}}\right) + \left(\frac{1}{2}\right) (1-x^2)^{-1/2} (-2x) \operatorname{sech}^{-1} x = \frac{1}{x} - \frac{1}{x} - \frac{x}{\sqrt{1-x^2}} \operatorname{sech}^{-1} x = \frac{-x}{\sqrt{1-x^2}} \operatorname{sech}^{-1} x$
33. $y = \operatorname{csch}^{-1} \left(\frac{1}{2}\right)^\theta \Rightarrow \frac{dy}{d\theta} = -\frac{\left[\ln\left(\frac{1}{2}\right)\right] \left(\frac{1}{2}\right)^\theta}{\left(\frac{1}{2}\right)^\theta \sqrt{1 + \left[\left(\frac{1}{2}\right)^\theta\right]^2}} = -\frac{\ln(1) - \ln(2)}{\sqrt{1 + \left(\frac{1}{2}\right)^{2\theta}}} = \frac{\ln 2}{\sqrt{1 + \left(\frac{1}{2}\right)^{2\theta}}}$

$$34. y = \operatorname{csch}^{-1} 2^\theta \Rightarrow \frac{dy}{d\theta} = -\frac{(\ln 2) 2^\theta}{2^\theta \sqrt{1+(2^\theta)^2}} = \frac{-\ln 2}{\sqrt{1+2^{2\theta}}}$$

$$35. y = \sinh^{-1}(\tan x) \Rightarrow \frac{dy}{dx} = \frac{\sec^2 x}{\sqrt{1+(\tan x)^2}} = \frac{\sec^2 x}{\sqrt{\sec^2 x}} = \frac{\sec^2 x}{|\sec x|} = \frac{|\sec x| |\sec x|}{|\sec x|} = |\sec x|$$

$$36. y = \cosh^{-1}(\sec x) \Rightarrow \frac{dy}{dx} = \frac{(\sec x)(\tan x)}{\sqrt{\sec^2 x - 1}} = \frac{(\sec x)(\tan x)}{\sqrt{\tan^2 x}} = \frac{(\sec x)(\tan x)}{|\tan x|} = \sec x, 0 < x < \frac{\pi}{2}$$

$$37. (a) \text{ If } y = \tan^{-1}(\sinh x) + C, \text{ then } \frac{dy}{dx} = \frac{\cosh x}{1 + \sinh^2 x} = \frac{\cosh x}{\cosh^2 x} = \operatorname{sech} x, \text{ which verifies the formula}$$

$$(b) \text{ If } y = \sin^{-1}(\tanh x) + C, \text{ then } \frac{dy}{dx} = \frac{\operatorname{sech}^2 x}{\sqrt{1 - \tanh^2 x}} = \frac{\operatorname{sech}^2 x}{\operatorname{sech} x} = \operatorname{sech} x, \text{ which verifies the formula}$$

$$38. \text{ If } y = \frac{x^2}{2} \operatorname{sech}^{-1} x - \frac{1}{2} \sqrt{1-x^2} + C, \text{ then } \frac{dy}{dx} = x \operatorname{sech}^{-1} x + \frac{x^2}{2} \left(\frac{-1}{x\sqrt{1-x^2}} \right) + \frac{2x}{4\sqrt{1-x^2}} = x \operatorname{sech}^{-1} x, \text{ which verifies the formula}$$

$$39. \text{ If } y = \frac{x^2-1}{2} \coth^{-1} x + \frac{x}{2} + C, \text{ then } \frac{dy}{dx} = x \coth^{-1} x + \left(\frac{x^2-1}{2} \right) \left(\frac{1}{1-x^2} \right) + \frac{1}{2} = x \coth^{-1} x, \text{ which verifies the formula}$$

$$40. \text{ If } y = x \tanh^{-1} x + \frac{1}{2} \ln(1-x^2) + C, \text{ then } \frac{dy}{dx} = \tanh^{-1} x + x \left(\frac{1}{1-x^2} \right) + \frac{1}{2} \left(\frac{-2x}{1-x^2} \right) = \tanh^{-1} x, \text{ which verifies the formula}$$

$$41. \int \sinh 2x \, dx = \frac{1}{2} \int \sinh u \, du, \text{ where } u = 2x \text{ and } du = 2 \, dx \\ = \frac{\cosh u}{2} + C = \frac{\cosh 2x}{2} + C$$

$$42. \int \sinh \frac{x}{5} \, dx = 5 \int \sinh u \, du, \text{ where } u = \frac{x}{5} \text{ and } du = \frac{1}{5} \, dx \\ = 5 \cosh u + C = 5 \cosh \frac{x}{5} + C$$

$$43. \int 6 \cosh \left(\frac{x}{2} - \ln 3 \right) \, dx = 12 \int \cosh u \, du, \text{ where } u = \frac{x}{2} - \ln 3 \text{ and } du = \frac{1}{2} \, dx \\ = 12 \sinh u + C = 12 \sinh \left(\frac{x}{2} - \ln 3 \right) + C$$

$$44. \int 4 \cosh(3x - \ln 2) \, dx = \frac{4}{3} \int \cosh u \, du, \text{ where } u = 3x - \ln 2 \text{ and } du = 3 \, dx \\ = \frac{4}{3} \sinh u + C = \frac{4}{3} \sinh(3x - \ln 2) + C$$

$$45. \int \tanh \frac{x}{7} \, dx = 7 \int \frac{\sinh u}{\cosh u} \, du, \text{ where } u = \frac{x}{7} \text{ and } du = \frac{1}{7} \, dx \\ = 7 \ln |\cosh u| + C_1 = 7 \ln \left| \cosh \frac{x}{7} \right| + C_1 = 7 \ln \left| \frac{e^{x/7} + e^{-x/7}}{2} \right| + C_1 = 7 \ln |e^{x/7} + e^{-x/7}| - 7 \ln 2 + C_1 \\ = 7 \ln |e^{x/7} + e^{-x/7}| + C$$

$$46. \int \coth \frac{\theta}{\sqrt{3}} \, d\theta = \sqrt{3} \int \frac{\cosh u}{\sinh u} \, du, \text{ where } u = \frac{\theta}{\sqrt{3}} \text{ and } du = \frac{d\theta}{\sqrt{3}} \\ = \sqrt{3} \ln |\sinh u| + C_1 = \sqrt{3} \ln \left| \sinh \frac{\theta}{\sqrt{3}} \right| + C_1 = \sqrt{3} \ln \left| \frac{e^{\theta/\sqrt{3}} - e^{-\theta/\sqrt{3}}}{2} \right| + C_1 \\ = \sqrt{3} \ln |e^{\theta/\sqrt{3}} - e^{-\theta/\sqrt{3}}| - \sqrt{3} \ln 2 + C_1 = \sqrt{3} \ln |e^{\theta/\sqrt{3}} - e^{-\theta/\sqrt{3}}| + C$$

$$47. \int \operatorname{sech}^2 \left(x - \frac{1}{2} \right) \, dx = \int \operatorname{sech}^2 u \, du, \text{ where } u = \left(x - \frac{1}{2} \right) \text{ and } du = dx \\ = \tanh u + C = \tanh \left(x - \frac{1}{2} \right) + C$$

$$48. \int \operatorname{csch}^2(5-x) dx = - \int \operatorname{csch}^2 u du, \text{ where } u = (5-x) \text{ and } du = -dx \\ = -(-\operatorname{coth} u) + C = \operatorname{coth} u + C = \operatorname{coth}(5-x) + C$$

$$49. \int \frac{\operatorname{sech} \sqrt{t} \tanh \sqrt{t}}{\sqrt{t}} dt = 2 \int \operatorname{sech} u \tanh u du, \text{ where } u = \sqrt{t} = t^{1/2} \text{ and } du = \frac{dt}{2\sqrt{t}} \\ = 2(-\operatorname{sech} u) + C = -2 \operatorname{sech} \sqrt{t} + C$$

$$50. \int \frac{\operatorname{csch}(\ln t) \operatorname{coth}(\ln t)}{t} dt = \int \operatorname{csch} u \operatorname{coth} u du, \text{ where } u = \ln t \text{ and } du = \frac{dt}{t} \\ = -\operatorname{csch} u + C = -\operatorname{csch}(\ln t) + C$$

$$51. \int_{\ln 2}^{\ln 4} \operatorname{coth} x dx = \int_{\ln 2}^{\ln 4} \frac{\cosh x}{\sinh x} dx = \int_{3/4}^{15/8} \frac{1}{u} du = [\ln |u|]_{3/4}^{15/8} = \ln \left| \frac{15}{8} \right| - \ln \left| \frac{3}{4} \right| = \ln \left| \frac{15}{8} \cdot \frac{4}{3} \right| = \ln \frac{5}{2},$$

where $u = \sinh x$, $du = \cosh x dx$, the lower limit is $\sinh(\ln 2) = \frac{e^{\ln 2} - e^{-\ln 2}}{2} = \frac{2 - (\frac{1}{2})}{2} = \frac{3}{4}$ and the upper limit is $\sinh(\ln 4) = \frac{e^{\ln 4} - e^{-\ln 4}}{2} = \frac{4 - (\frac{1}{4})}{2} = \frac{15}{8}$

$$52. \int_0^{\ln 2} \tanh 2x dx = \int_0^{\ln 2} \frac{\sinh 2x}{\cosh 2x} dx = \frac{1}{2} \int_1^{17/8} \frac{1}{u} du = \frac{1}{2} [\ln |u|]_1^{17/8} = \frac{1}{2} [\ln \left(\frac{17}{8} \right) - \ln 1] = \frac{1}{2} \ln \frac{17}{8}, \text{ where} \\ u = \cosh 2x, du = 2 \sinh(2x) dx, \text{ the lower limit is } \cosh 0 = 1 \text{ and the upper limit is } \cosh(2 \ln 2) = \cosh(\ln 4) \\ = \frac{e^{\ln 4} + e^{-\ln 4}}{2} = \frac{4 + (\frac{1}{4})}{2} = \frac{17}{8}$$

$$53. \int_{-\ln 4}^{-\ln 2} 2e^\theta \cosh \theta d\theta = \int_{-\ln 4}^{-\ln 2} 2e^\theta \left(\frac{e^\theta + e^{-\theta}}{2} \right) d\theta = \int_{-\ln 4}^{-\ln 2} (e^{2\theta} + 1) d\theta = \left[\frac{e^{2\theta}}{2} + \theta \right]_{-\ln 4}^{-\ln 2} \\ = \left(\frac{e^{-2\ln 2}}{2} - \ln 2 \right) - \left(\frac{e^{-2\ln 4}}{2} - \ln 4 \right) = \left(\frac{1}{8} - \ln 2 \right) - \left(\frac{1}{32} - \ln 4 \right) = \frac{3}{32} - \ln 2 + 2 \ln 2 = \frac{3}{32} + \ln 2$$

$$54. \int_0^{\ln 2} 4e^{-\theta} \sinh \theta d\theta = \int_0^{\ln 2} 4e^{-\theta} \left(\frac{e^\theta - e^{-\theta}}{2} \right) d\theta = 2 \int_0^{\ln 2} (1 - e^{-2\theta}) d\theta = 2 \left[\theta + \frac{e^{-2\theta}}{2} \right]_0^{\ln 2} \\ = 2 \left[\left(\ln 2 + \frac{e^{-2\ln 2}}{2} \right) - \left(0 + \frac{e^0}{2} \right) \right] = 2 \left(\ln 2 + \frac{1}{8} - \frac{1}{2} \right) = 2 \ln 2 + \frac{1}{4} - 1 = \ln 4 - \frac{3}{4}$$

$$55. \int_{-\pi/4}^{\pi/4} \cosh(\tan \theta) \sec^2 \theta d\theta = \int_{-1}^1 \cosh u du = [\sinh u]_{-1}^1 = \sinh(1) - \sinh(-1) = \left(\frac{e^1 - e^{-1}}{2} \right) - \left(\frac{e^{-1} - e^1}{2} \right) \\ = \frac{e - e^{-1} - e^{-1} + e}{2} = e - e^{-1}, \text{ where } u = \tan \theta, du = \sec^2 \theta d\theta, \text{ the lower limit is } \tan \left(-\frac{\pi}{4} \right) = -1 \text{ and the upper} \\ \text{limit is } \tan \left(\frac{\pi}{4} \right) = 1$$

$$56. \int_0^{\pi/2} 2 \sinh(\sin \theta) \cos \theta d\theta = 2 \int_0^1 \sinh u du = 2 [\cosh u]_0^1 = 2(\cosh 1 - \cosh 0) = 2 \left(\frac{e + e^{-1}}{2} - 1 \right) \\ = e + e^{-1} - 2, \text{ where } u = \sin \theta, du = \cos \theta d\theta, \text{ the lower limit is } \sin 0 = 0 \text{ and the upper limit is } \sin \left(\frac{\pi}{2} \right) = 1$$

$$57. \int_1^2 \frac{\cosh(\ln t)}{t} dt = \int_0^{\ln 2} \cosh u du = [\sinh u]_0^{\ln 2} = \sinh(\ln 2) - \sinh(0) = \frac{e^{\ln 2} - e^{-\ln 2}}{2} - 0 = \frac{2 - \frac{1}{2}}{2} = \frac{3}{4}, \text{ where} \\ u = \ln t, du = \frac{1}{t} dt, \text{ the lower limit is } \ln 1 = 0 \text{ and the upper limit is } \ln 2$$

$$58. \int_1^4 \frac{8 \cosh \sqrt{x}}{\sqrt{x}} dx = 16 \int_1^2 \cosh u du = 16 [\sinh u]_1^2 = 16(\sinh 2 - \sinh 1) = 16 \left[\left(\frac{e^2 - e^{-2}}{2} \right) - \left(\frac{e - e^{-1}}{2} \right) \right] \\ = 8(e^2 - e^{-2} - e + e^{-1}), \text{ where } u = \sqrt{x} = x^{1/2}, du = \frac{1}{2} x^{-1/2} dx = \frac{dx}{2\sqrt{x}}, \text{ the lower limit is } \sqrt{1} = 1 \text{ and the upper} \\ \text{limit is } \sqrt{4} = 2$$

$$59. \int_{-\ln 2}^0 \cosh^2 \left(\frac{x}{2} \right) dx = \int_{-\ln 2}^0 \frac{\cosh x + 1}{2} dx = \frac{1}{2} \int_{-\ln 2}^0 (\cosh x + 1) dx = \frac{1}{2} [\sinh x + x]_{-\ln 2}^0$$

$$= \frac{1}{2} [(\sinh 0 + 0) - (\sinh(-\ln 2) - \ln 2)] = \frac{1}{2} \left[(0 + 0) - \left(\frac{e^{-\ln 2} - e^{\ln 2}}{2} - \ln 2 \right) \right] = \frac{1}{2} \left[-\frac{\left(\frac{1}{2}\right) - 2}{2} + \ln 2 \right]$$

$$= \frac{1}{2} \left(1 - \frac{1}{4} + \ln 2 \right) = \frac{3}{8} + \frac{1}{2} \ln 2 = \frac{3}{8} + \ln \sqrt{2}$$

60. $\int_0^{\ln 10} 4 \sinh^2 \left(\frac{x}{2} \right) dx = \int_0^{\ln 10} 4 \left(\frac{\cosh x - 1}{2} \right) dx = 2 \int_0^{\ln 10} (\cosh x - 1) dx = 2 [\sinh x - x]_0^{\ln 10}$
 $= 2[(\sinh(\ln 10) - \ln 10) - (\sinh 0 - 0)] = e^{\ln 10} - e^{-\ln 10} - 2 \ln 10 = 10 - \frac{1}{10} - 2 \ln 10 = 9.9 - 2 \ln 10$

61. $\sinh^{-1} \left(\frac{5}{12} \right) = \ln \left(-\frac{5}{12} + \sqrt{\frac{25}{144} + 1} \right) = \ln \left(\frac{2}{3} \right)$ 62. $\cosh^{-1} \left(\frac{5}{3} \right) = \ln \left(\frac{5}{3} + \sqrt{\frac{25}{9} - 1} \right) = \ln 3$

63. $\tanh^{-1} \left(-\frac{1}{2} \right) = \frac{1}{2} \ln \left(\frac{1 - (1/2)}{1 + (1/2)} \right) = -\frac{\ln 3}{2}$ 64. $\coth^{-1} \left(\frac{5}{4} \right) = \frac{1}{2} \ln \left(\frac{(9/4)}{(1/4)} \right) = \frac{1}{2} \ln 9 = \ln 3$

65. $\operatorname{sech}^{-1} \left(\frac{3}{5} \right) = \ln \left(\frac{1 + \sqrt{1 - (9/25)}}{(3/5)} \right) = \ln 3$ 66. $\operatorname{csch}^{-1} \left(-\frac{1}{\sqrt{3}} \right) = \ln \left(-\sqrt{3} + \frac{\sqrt{4/3}}{(1/\sqrt{3})} \right) = \ln(-\sqrt{3} + 2)$

67. (a) $\int_0^{2\sqrt{3}} \frac{dx}{\sqrt{4+x^2}} = [\sinh^{-1} \frac{x}{2}]_0^{2\sqrt{3}} = \sinh^{-1} \sqrt{3} - \sinh^{-1} 0 = \sinh^{-1} \sqrt{3}$

(b) $\sinh^{-1} \sqrt{3} = \ln(\sqrt{3} + \sqrt{3+1}) = \ln(\sqrt{3} + 2)$

68. (a) $\int_0^{1/3} \frac{6 dx}{\sqrt{1+9x^2}} = 2 \int_0^1 \frac{dx}{\sqrt{a^2+u^2}}$, where $u = 3x$, $du = 3 dx$, $a = 1$
 $= [2 \sinh^{-1} u]_0^1 = 2(\sinh^{-1} 1 - \sinh^{-1} 0) = 2 \sinh^{-1} 1$

(b) $2 \sinh^{-1} 1 = 2 \ln(1 + \sqrt{1^2 + 1}) = 2 \ln(1 + \sqrt{2})$

69. (a) $\int_{5/4}^2 \frac{1}{1-x^2} dx = [\coth^{-1} x]_{5/4}^2 = \coth^{-1} 2 - \coth^{-1} \frac{5}{4}$

(b) $\coth^{-1} 2 - \coth^{-1} \frac{5}{4} = \frac{1}{2} [\ln 3 - \ln \frac{9/4}{1/4}] = \frac{1}{2} \ln \frac{1}{3}$

70. (a) $\int_0^{1/2} \frac{1}{1-x^2} dx = [\tanh^{-1} x]_0^{1/2} = \tanh^{-1} \frac{1}{2} - \tanh^{-1} 0 = \tanh^{-1} \frac{1}{2}$

(b) $\tanh^{-1} \frac{1}{2} = \frac{1}{2} \ln \left(\frac{1 + (1/2)}{1 - (1/2)} \right) = \frac{1}{2} \ln 3$

71. (a) $\int_{1/5}^{3/13} \frac{dx}{x\sqrt{1-16x^2}} = \int_{4/5}^{12/13} \frac{du}{u\sqrt{a^2-u^2}}$, where $u = 4x$, $du = 4 dx$, $a = 1$
 $= [-\operatorname{sech}^{-1} u]_{4/5}^{12/13} = -\operatorname{sech}^{-1} \frac{12}{13} + \operatorname{sech}^{-1} \frac{4}{5}$

(b) $-\operatorname{sech}^{-1} \frac{12}{13} + \operatorname{sech}^{-1} \frac{4}{5} = -\ln \left(\frac{1 + \sqrt{1 - (12/13)^2}}{(12/13)} \right) + \ln \left(\frac{1 + \sqrt{1 - (4/5)^2}}{(4/5)} \right)$
 $= -\ln \left(\frac{13 + \sqrt{169 - 144}}{12} \right) + \ln \left(\frac{5 + \sqrt{25 - 16}}{4} \right) = \ln \left(\frac{5+3}{4} \right) - \ln \left(\frac{13+5}{12} \right) = \ln 2 - \ln \frac{3}{2}$
 $= \ln \left(2 \cdot \frac{2}{3} \right) = \ln \frac{4}{3}$

72. (a) $\int_1^2 \frac{dx}{x\sqrt{4+x^2}} = \left[-\frac{1}{2} \operatorname{csch}^{-1} \left| \frac{x}{2} \right| \right]_1^2 = -\frac{1}{2} (\operatorname{csch}^{-1} 1 - \operatorname{csch}^{-1} \frac{1}{2}) = \frac{1}{2} (\operatorname{csch}^{-1} \frac{1}{2} - \operatorname{csch}^{-1} 1)$

(b) $\frac{1}{2} (\operatorname{csch}^{-1} \frac{1}{2} - \operatorname{csch}^{-1} 1) = \frac{1}{2} \left[\ln \left(2 + \frac{\sqrt{5/4}}{(1/2)} \right) - \ln \left(1 + \sqrt{2} \right) \right] = \frac{1}{2} \ln \left(\frac{2 + \sqrt{5}}{1 + \sqrt{2}} \right)$

73. (a) $\int_0^\pi \frac{\cos x}{\sqrt{1 + \sin^2 x}} dx = \int_0^0 \frac{1}{\sqrt{1+u^2}} du = [\sinh^{-1} u]_0^0 = \sinh^{-1} 0 - \sinh^{-1} 0 = 0$, where $u = \sin x$, $du = \cos x dx$

(b) $\sinh^{-1} 0 - \sinh^{-1} 0 = \ln(0 + \sqrt{0+1}) - \ln(0 + \sqrt{0+1}) = 0$

$$74. (a) \int_1^e \frac{dx}{x\sqrt{1+(\ln x)^2}} = \int_0^1 \frac{du}{\sqrt{a^2+u^2}}, \text{ where } u = \ln x, du = \frac{1}{x} dx, a = 1$$

$$= [\sinh^{-1} u]_0^1 = \sinh^{-1} 1 - \sinh^{-1} 0 = \sinh^{-1} 1$$

$$(b) \sinh^{-1} 1 - \sinh^{-1} 0 = \ln(1 + \sqrt{1^2 + 1}) - \ln(0 + \sqrt{0^2 + 1}) = \ln(1 + \sqrt{2})$$

$$75. (a) \text{ Let } E(x) = \frac{f(x)+f(-x)}{2} \text{ and } O(x) = \frac{f(x)-f(-x)}{2}. \text{ Then } E(x) + O(x) = \frac{f(x)+f(-x)}{2} + \frac{f(x)-f(-x)}{2}$$

$$= \frac{2f(x)}{2} = f(x). \text{ Also, } E(-x) = \frac{f(-x)+f(-(-x))}{2} = \frac{f(-x)+f(x)}{2} = E(x) \Rightarrow E(x) \text{ is even, and}$$

$O(-x) = \frac{f(-x)-f(-(-x))}{2} = -\frac{f(x)-f(-x)}{2} = -O(x) \Rightarrow O(x) \text{ is odd. Consequently, } f(x) \text{ can be written as a sum of an even and an odd function.}$

$$(b) f(x) = \frac{f(x)+f(-x)}{2} \text{ because } \frac{f(x)-f(-x)}{2} = 0 \text{ if } f \text{ is even and } f(x) = \frac{f(x)-f(-x)}{2} \text{ because } \frac{f(x)+f(-x)}{2} = 0 \text{ if } f \text{ is odd.}$$

$$\text{Thus, if } f \text{ is even } f(x) = \frac{2f(x)}{2} + 0 \text{ and if } f \text{ is odd, } f(x) = 0 + \frac{2f(x)}{2}$$

$$76. y = \sinh^{-1} x \Rightarrow x = \sinh y \Rightarrow x = \frac{e^y - e^{-y}}{2} \Rightarrow 2x = e^y - \frac{1}{e^y} \Rightarrow 2xe^y = e^{2y} - 1 \Rightarrow e^{2y} - 2xe^y - 1 = 0$$

$$\Rightarrow e^y = \frac{2x \pm \sqrt{4x^2 + 4}}{2} \Rightarrow e^y = x + \sqrt{x^2 + 1} \Rightarrow \sinh^{-1} x = y = \ln(x + \sqrt{x^2 + 1}). \text{ Since } e^y > 0, \text{ we cannot}$$

$$\text{choose } e^y = x - \sqrt{x^2 + 1} \text{ because } x - \sqrt{x^2 + 1} < 0.$$

$$77. (a) v = \sqrt{\frac{mg}{k}} \tanh\left(\sqrt{\frac{gk}{m}} t\right) \Rightarrow \frac{dv}{dt} = \sqrt{\frac{mg}{k}} \left[\operatorname{sech}^2\left(\sqrt{\frac{gk}{m}} t\right) \right] \left(\sqrt{\frac{gk}{m}}\right) = g \operatorname{sech}^2\left(\sqrt{\frac{gk}{m}} t\right).$$

Thus $m \frac{dv}{dt} = mg \operatorname{sech}^2\left(\sqrt{\frac{gk}{m}} t\right) = mg\left(1 - \tanh^2\left(\sqrt{\frac{gk}{m}} t\right)\right) = mg - kv^2$. Also, since $\tanh x = 0$ when $x = 0$, $v = 0$ when $t = 0$.

$$(b) \lim_{t \rightarrow \infty} v = \lim_{t \rightarrow \infty} \sqrt{\frac{mg}{k}} \tanh\left(\sqrt{\frac{gk}{m}} t\right) = \sqrt{\frac{mg}{k}} \lim_{t \rightarrow \infty} \tanh\left(\sqrt{\frac{gk}{m}} t\right) = \sqrt{\frac{mg}{k}} (1) = \sqrt{\frac{mg}{k}}$$

$$(c) \sqrt{\frac{160}{0.005}} = \sqrt{\frac{160,000}{5}} = \frac{400}{\sqrt{5}} = 80\sqrt{5} \approx 178.89 \text{ ft/sec}$$

$$78. (a) s(t) = a \cos kt + b \sin kt \Rightarrow \frac{ds}{dt} = -ak \sin kt + bk \cos kt \Rightarrow \frac{d^2s}{dt^2} = -ak^2 \cos kt - bk^2 \sin kt$$

$$= -k^2(a \cos kt + b \sin kt) = -k^2 s(t) \Rightarrow \text{acceleration is proportional to } s. \text{ The negative constant } -k^2$$

$$\text{implies that the acceleration is directed toward the origin.}$$

$$(b) s(t) = a \cosh kt + b \sinh kt \Rightarrow \frac{ds}{dt} = ak \sinh kt + bk \cosh kt \Rightarrow \frac{d^2s}{dt^2} = ak^2 \cosh kt + bk^2 \sinh kt$$

$$= k^2(a \cosh kt + b \sinh kt) = k^2 s(t) \Rightarrow \text{acceleration is proportional to } s. \text{ The positive constant } k^2 \text{ implies}$$

$$\text{that the acceleration is directed away from the origin.}$$

$$79. \frac{dy}{dx} = \frac{-1}{x\sqrt{1-x^2}} + \frac{x}{\sqrt{1-x^2}} \Rightarrow y = \int \frac{-1}{x\sqrt{1-x^2}} dx + \int \frac{x}{\sqrt{1-x^2}} dx \Rightarrow y = \operatorname{sech}^{-1}(x) - \sqrt{1-x^2} + C; x = 1 \text{ and}$$

$$y = 0 \Rightarrow C = 0 \Rightarrow y = \operatorname{sech}^{-1}(x) - \sqrt{1-x^2}$$

$$80. \text{ To find the length of the curve: } y = \frac{1}{a} \cosh ax \Rightarrow y' = \sinh ax \Rightarrow L = \int_0^b \sqrt{1 + (\sinh ax)^2} dx$$

$$\Rightarrow L = \int_0^b \cosh ax dx = \left[\frac{1}{a} \sinh ax\right]_0^b = \frac{1}{a} \sinh ab. \text{ Then the area under the curve is } A = \int_0^b \frac{1}{a} \cosh ax dx$$

$$= \left[\frac{1}{a^2} \sinh ax\right]_0^b = \frac{1}{a^2} \sinh ab = \left(\frac{1}{a}\right) \left(\frac{1}{a} \sinh ab\right) \text{ which is the area of the rectangle of height } \frac{1}{a} \text{ and length } L$$

$$\text{as claimed.}$$

$$81. V = \pi \int_0^2 (\cosh^2 x - \sinh^2 x) dx = \pi \int_0^2 1 dx = 2\pi$$

$$82. V = 2\pi \int_0^{\ln \sqrt{3}} \operatorname{sech}^2 x dx = 2\pi [\tanh x]_0^{\ln \sqrt{3}} = 2\pi \left[\frac{\sqrt{3} - (1/\sqrt{3})}{\sqrt{3} + (1/\sqrt{3})} \right] = \pi$$

83. $y = \frac{1}{2} \cosh 2x \Rightarrow y' = \sinh 2x \Rightarrow L = \int_0^{\ln \sqrt{5}} \sqrt{1 + (\sinh 2x)^2} dx = \int_0^{\ln \sqrt{5}} \cosh 2x dx = \left[\frac{1}{2} \sinh 2x \right]_0^{\ln \sqrt{5}}$
 $= \left[\frac{1}{2} \left(\frac{e^{2x} - e^{-2x}}{2} \right) \right]_0^{\ln \sqrt{5}} = \frac{1}{4} \left(5 - \frac{1}{5} \right) = \frac{6}{5}$

84. (a) Let the point located at $(\cosh u, 0)$ be called T. Then $A(u) =$ area of the triangle ΔOTP minus the area under the curve $y = \sqrt{x^2 - 1}$ from A to T $\Rightarrow A(u) = \frac{1}{2} \cosh u \sinh u - \int_1^{\cosh u} \sqrt{x^2 - 1} dx$.

(b) $A(u) = \frac{1}{2} \cosh u \sinh u - \int_1^{\cosh u} \sqrt{x^2 - 1} dx \Rightarrow A'(u) = \frac{1}{2} (\cosh^2 u + \sinh^2 u) - \left(\sqrt{\cosh^2 u - 1} \right) (\sinh u)$
 $= \frac{1}{2} \cosh^2 u + \frac{1}{2} \sinh^2 u - \sinh^2 u = \frac{1}{2} (\cosh^2 u - \sinh^2 u) = \left(\frac{1}{2} \right) (1) = \frac{1}{2}$

(c) $A'(u) = \frac{1}{2} \Rightarrow A(u) = \frac{u}{2} + C$, and from part (a) we have $A(0) = 0 \Rightarrow C = 0 \Rightarrow A(u) = \frac{u}{2} \Rightarrow u = 2A$

85. $y = 4 \cosh \frac{x}{4} \Rightarrow 1 + \left(\frac{dy}{dx} \right)^2 = 1 + \sinh^2 \left(\frac{x}{4} \right) = \cosh^2 \left(\frac{x}{4} \right)$; the surface area is $S = \int_{-\ln 16}^{\ln 81} 2\pi y \sqrt{1 + \left(\frac{dy}{dx} \right)^2} dx$
 $= 8\pi \int_{-\ln 16}^{\ln 81} \cosh^2 \left(\frac{x}{4} \right) dx = 4\pi \int_{-\ln 16}^{\ln 81} (1 + \cosh \frac{x}{2}) dx = 4\pi \left[x + 2 \sinh \frac{x}{2} \right]_{-\ln 16}^{\ln 81}$
 $= 4\pi \left[(\ln 81 + 2 \sinh \left(\frac{\ln 81}{2} \right)) - (-\ln 16 + 2 \sinh \left(\frac{-\ln 16}{2} \right)) \right] = 4\pi \left[\ln(81 \cdot 16) + 2 \sinh(\ln 9) + 2 \sinh(\ln 4) \right]$
 $= 4\pi \left[\ln(9 \cdot 4)^2 + (e^{\ln 9} - e^{-\ln 9}) + (e^{\ln 4} - e^{-\ln 4}) \right] = 4\pi \left[2 \ln 36 + (9 - \frac{1}{9}) + (4 - \frac{1}{4}) \right] = 4\pi \left(4 \ln 6 + \frac{80}{9} + \frac{15}{4} \right)$
 $= 4\pi \left(4 \ln 6 + \frac{320 + 135}{36} \right) = 16\pi \ln 6 + \frac{455\pi}{9}$

86. (a) $y = \cosh x \Rightarrow ds = \sqrt{(dx)^2 + (dy)^2} = \sqrt{(dx)^2 + (\sinh^2 x)(dx)^2} = \cosh x dx$; $M_x = \int_{-\ln 2}^{\ln 2} y ds$
 $= \int_{-\ln 2}^{\ln 2} \cosh x ds = \int_{-\ln 2}^{\ln 2} \cosh^2 x dx = \int_0^{\ln 2} (\cosh 2x + 1) dx = \left[\frac{\sinh 2x}{2} + x \right]_0^{\ln 2} = \frac{1}{4} (e^{\ln 4} - e^{-\ln 4}) + \ln 2$
 $= \frac{15}{16} + \ln 2$; $M = 2 \int_0^{\ln 2} \sqrt{1 + \sinh^2 x} dx = 2 \int_0^{\ln 2} \cosh x dx = 2 [\sinh x]_0^{\ln 2} = e^{\ln 2} - e^{-\ln 2} = 2 - \frac{1}{2} = \frac{3}{2}$.

Therefore, $\bar{y} = \frac{M_x}{M} = \frac{(\frac{15}{16} + \ln 2)}{(\frac{3}{2})} = \frac{5}{8} + \frac{\ln 4}{3}$, and by symmetry $\bar{x} = 0$.

(b) $\bar{x} = 0, \bar{y} \approx 1.09$

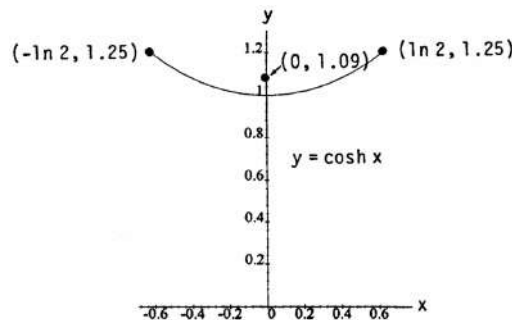

87. (a) $y = \frac{H}{w} \cosh \left(\frac{w}{H} x \right) \Rightarrow \tan \phi = \frac{dy}{dx} = \left(\frac{H}{w} \right) \left[\frac{w}{H} \sinh \left(\frac{w}{H} x \right) \right] = \sinh \left(\frac{w}{H} x \right)$

(b) The tension at P is given by $T \cos \phi = H \Rightarrow T = H \sec \phi = H \sqrt{1 + \tan^2 \phi} = H \sqrt{1 + \left(\sinh \frac{w}{H} x \right)^2}$
 $= H \cosh \left(\frac{w}{H} x \right) = w \left(\frac{H}{w} \right) \cosh \left(\frac{w}{H} x \right) = wy$

88. $s = \frac{1}{a} \sinh ax \Rightarrow \sinh ax = as \Rightarrow ax = \sinh^{-1} as \Rightarrow x = \frac{1}{a} \sinh^{-1} as$; $y = \frac{1}{a} \cosh ax = \frac{1}{a} \sqrt{\cosh^2 ax}$
 $= \frac{1}{a} \sqrt{\sinh^2 ax + 1} = \frac{1}{a} \sqrt{a^2 s^2 + 1} = \sqrt{s^2 + \frac{1}{a^2}}$

89. (a) Since the cable is 32 ft long, $s = 16$ and $x = 15$. From Exercise 88, $x = \frac{1}{a} \sinh^{-1} as \Rightarrow 15a = \sinh^{-1} 16a$
 $\Rightarrow \sinh 15a = 16a$.

(b) The intersection is near (0.042, 0.672).

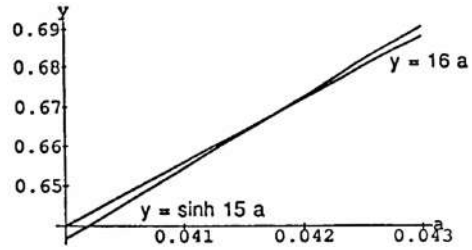

(c) Newton's method indicates that at $a \approx 0.0417525$ the curves $y = 16a$ and $y = \sinh 15a$ intersect.

(d) $T = wy \approx (2 \text{ lb}) \left(\frac{1}{0.0417525}\right) \approx 47.90 \text{ lb}$

(e) The sag is $\frac{1}{a} \cosh(15a) - \frac{1}{a} \approx 4.85 \text{ ft}$.

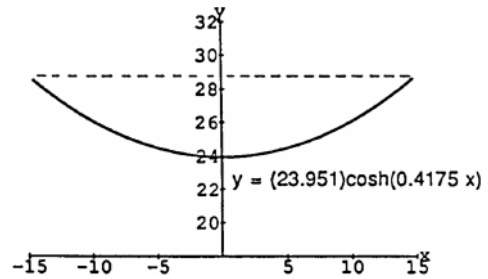

CHAPTER 7 PRACTICE EXERCISES

1. $y = 10e^{-x/5} \Rightarrow \frac{dy}{dx} = (10) \left(-\frac{1}{5}\right) e^{-x/5} = -2e^{-x/5}$

2. $y = \sqrt{2} e^{\sqrt{2}x} \Rightarrow \frac{dy}{dx} = (\sqrt{2}) (\sqrt{2}) e^{\sqrt{2}x} = 2e^{\sqrt{2}x}$

3. $y = \frac{1}{4} x e^{4x} - \frac{1}{16} e^{4x} \Rightarrow \frac{dy}{dx} = \frac{1}{4} [x (4e^{4x}) + e^{4x}(1)] - \frac{1}{16} (4e^{4x}) = x e^{4x} + \frac{1}{4} e^{4x} - \frac{1}{4} e^{4x} = x e^{4x}$

4. $y = x^2 e^{-2/x} = x^2 e^{-2x^{-1}} \Rightarrow \frac{dy}{dx} = x^2 [(2x^{-2}) e^{-2x^{-1}}] + e^{-2x^{-1}} (2x) = (2 + 2x) e^{-2x^{-1}} = 2e^{-2/x} (1 + x)$

5. $y = \ln(\sin^2 \theta) \Rightarrow \frac{dy}{d\theta} = \frac{2(\sin \theta)(\cos \theta)}{\sin^2 \theta} = \frac{2 \cos \theta}{\sin \theta} = 2 \cot \theta$

6. $y = \ln(\sec^2 \theta) \Rightarrow \frac{dy}{d\theta} = \frac{2(\sec \theta)(\sec \theta \tan \theta)}{\sec^2 \theta} = 2 \tan \theta$

7. $y = \log_2 \left(\frac{x^2}{2}\right) = \frac{\ln\left(\frac{x^2}{2}\right)}{\ln 2} \Rightarrow \frac{dy}{dx} = \frac{1}{\ln 2} \left(\frac{x}{\frac{x^2}{2}}\right) = \frac{2}{(\ln 2)x}$

8. $y = \log_5 (3x - 7) = \frac{\ln(3x-7)}{\ln 5} \Rightarrow \frac{dy}{dx} = \left(\frac{1}{\ln 5}\right) \left(\frac{3}{3x-7}\right) = \frac{3}{(\ln 5)(3x-7)}$

9. $y = 8^{-t} \Rightarrow \frac{dy}{dt} = 8^{-t}(\ln 8)(-1) = -8^{-t}(\ln 8)$

10. $y = 9^{2t} \Rightarrow \frac{dy}{dt} = 9^{2t}(\ln 9)(2) = 9^{2t}(2 \ln 9)$

11. $y = 5x^{3.6} \Rightarrow \frac{dy}{dx} = 5(3.6)x^{2.6} = 18x^{2.6}$

12. $y = \sqrt{2} x^{-\sqrt{2}} \Rightarrow \frac{dy}{dx} = (\sqrt{2}) (-\sqrt{2}) x^{(-\sqrt{2}-1)} = -2x^{(-\sqrt{2}-1)}$

$$13. y = (x+2)^{x+2} \Rightarrow \ln y = \ln (x+2)^{x+2} = (x+2) \ln (x+2) \Rightarrow \frac{y'}{y} = (x+2) \left(\frac{1}{x+2} \right) + (1) \ln (x+2) \\ \Rightarrow \frac{dy}{dx} = (x+2)^{x+2} [\ln (x+2) + 1]$$

$$14. y = 2(\ln x)^{x/2} \Rightarrow \ln y = \ln [2(\ln x)^{x/2}] = \ln (2) + \left(\frac{x}{2} \right) \ln (\ln x) \Rightarrow \frac{y'}{y} = 0 + \left(\frac{x}{2} \right) \left[\frac{\left(\frac{1}{\ln x} \right)}{\ln x} \right] + (\ln (\ln x)) \left(\frac{1}{2} \right) \\ \Rightarrow y' = \left[\frac{1}{2 \ln x} + \left(\frac{1}{2} \right) \ln (\ln x) \right] 2(\ln x)^{x/2} = (\ln x)^{x/2} \left[\ln (\ln x) + \frac{1}{\ln x} \right]$$

$$15. y = \sin^{-1} \sqrt{1-u^2} = \sin^{-1} (1-u^2)^{1/2} \Rightarrow \frac{dy}{du} = \frac{\frac{1}{2}(1-u^2)^{-1/2}(-2u)}{\sqrt{1-[(1-u^2)^{1/2}]^2}} = \frac{-u}{\sqrt{1-u^2}\sqrt{1-(1-u^2)}} = \frac{-u}{|u|\sqrt{1-u^2}} \\ = \frac{-u}{u\sqrt{1-u^2}} = \frac{-1}{\sqrt{1-u^2}}, 0 < u < 1$$

$$16. y = \sin^{-1} \left(\frac{1}{\sqrt{v}} \right) = \sin^{-1} v^{-1/2} \Rightarrow \frac{dy}{dv} = \frac{-\frac{1}{2}v^{-3/2}}{\sqrt{1-(v^{-1/2})^2}} = \frac{-1}{2v^{3/2}\sqrt{1-v^{-1}}} = \frac{-1}{2v^{3/2}\sqrt{\frac{v-1}{v}}} = \frac{-\sqrt{v}}{2v^{3/2}\sqrt{v-1}} \\ = \frac{-1}{2v\sqrt{v-1}}$$

$$17. y = \ln (\cos^{-1} x) \Rightarrow y' = \frac{\left(\frac{-1}{\sqrt{1-x^2}} \right)}{\cos^{-1} x} = \frac{-1}{\sqrt{1-x^2} \cos^{-1} x}$$

$$18. y = z \cos^{-1} z - \sqrt{1-z^2} = z \cos^{-1} z - (1-z^2)^{1/2} \Rightarrow \frac{dy}{dz} = \cos^{-1} z - \frac{z}{\sqrt{1-z^2}} - \left(\frac{1}{2} \right) (1-z^2)^{-1/2} (-2z) \\ = \cos^{-1} z - \frac{z}{\sqrt{1-z^2}} + \frac{z}{\sqrt{1-z^2}} = \cos^{-1} z$$

$$19. y = t \tan^{-1} t - \left(\frac{1}{2} \right) \ln t \Rightarrow \frac{dy}{dt} = \tan^{-1} t + t \left(\frac{1}{1+t^2} \right) - \left(\frac{1}{2} \right) \left(\frac{1}{t} \right) = \tan^{-1} t + \frac{t}{1+t^2} - \frac{1}{2t}$$

$$20. y = (1+t^2) \cot^{-1} 2t \Rightarrow \frac{dy}{dt} = 2t \cot^{-1} 2t + (1+t^2) \left(\frac{-2}{1+4t^2} \right)$$

$$21. y = z \sec^{-1} z - \sqrt{z^2-1} = z \sec^{-1} z - (z^2-1)^{1/2} \Rightarrow \frac{dy}{dz} = z \left(\frac{1}{|z|\sqrt{z^2-1}} \right) + (\sec^{-1} z) (1) - \frac{1}{2} (z^2-1)^{-1/2} (2z) \\ = \frac{z}{|z|\sqrt{z^2-1}} - \frac{z}{\sqrt{z^2-1}} + \sec^{-1} z = \frac{1-z}{\sqrt{z^2-1}} + \sec^{-1} z, z > 1$$

$$22. y = 2\sqrt{x-1} \sec^{-1} \sqrt{x} = 2(x-1)^{1/2} \sec^{-1} (x^{1/2}) \\ \Rightarrow \frac{dy}{dx} = 2 \left[\left(\frac{1}{2} \right) (x-1)^{-1/2} \sec^{-1} (x^{1/2}) + (x-1)^{1/2} \left(\frac{\left(\frac{1}{2} \right) x^{-1/2}}{\sqrt{x}\sqrt{x-1}} \right) \right] = 2 \left(\frac{\sec^{-1} \sqrt{x}}{2\sqrt{x-1}} + \frac{1}{2x} \right) = \frac{\sec^{-1} \sqrt{x}}{\sqrt{x-1}} + \frac{1}{x}$$

$$23. y = \csc^{-1} (\sec \theta) \Rightarrow \frac{dy}{d\theta} = \frac{-\sec \theta \tan \theta}{|\sec \theta| \sqrt{\sec^2 \theta - 1}} = -\frac{\tan \theta}{|\tan \theta|} = -1, 0 < \theta < \frac{\pi}{2}$$

$$24. y = (1+x^2) e^{\tan^{-1} x} \Rightarrow y' = 2xe^{\tan^{-1} x} + (1+x^2) \left(\frac{e^{\tan^{-1} x}}{1+x^2} \right) = 2xe^{\tan^{-1} x} + e^{\tan^{-1} x}$$

$$25. y = \frac{2(x^2+1)}{\sqrt{\cos 2x}} \Rightarrow \ln y = \ln \left(\frac{2(x^2+1)}{\sqrt{\cos 2x}} \right) = \ln (2) + \ln (x^2+1) - \frac{1}{2} \ln (\cos 2x) \Rightarrow \frac{y'}{y} = 0 + \frac{2x}{x^2+1} - \left(\frac{1}{2} \right) \frac{(-2 \sin 2x)}{\cos 2x} \\ \Rightarrow y' = \left(\frac{2x}{x^2+1} + \tan 2x \right) y = \frac{2(x^2+1)}{\sqrt{\cos 2x}} \left(\frac{2x}{x^2+1} + \tan 2x \right)$$

$$26. y = \sqrt[10]{\frac{3x+4}{2x-4}} \Rightarrow \ln y = \ln \sqrt[10]{\frac{3x+4}{2x-4}} = \frac{1}{10} [\ln (3x+4) - \ln (2x-4)] \Rightarrow \frac{y'}{y} = \frac{1}{10} \left(\frac{3}{3x+4} - \frac{2}{2x-4} \right) \\ \Rightarrow y' = \frac{1}{10} \left(\frac{3}{3x+4} - \frac{1}{x-2} \right) y = \sqrt[10]{\frac{3x+4}{2x-4}} \left(\frac{1}{10} \right) \left(\frac{3}{3x+4} - \frac{1}{x-2} \right)$$

$$27. y = \left[\frac{(t+1)(t-1)}{(t-2)(t+3)} \right]^5 \Rightarrow \ln y = 5 [\ln(t+1) + \ln(t-1) - \ln(t-2) - \ln(t+3)] \Rightarrow \left(\frac{1}{y} \right) \left(\frac{dy}{dt} \right) \\ = 5 \left(\frac{1}{t+1} + \frac{1}{t-1} - \frac{1}{t-2} - \frac{1}{t+3} \right) \Rightarrow \frac{dy}{dt} = 5 \left[\frac{(t+1)(t-1)}{(t-2)(t+3)} \right]^5 \left(\frac{1}{t+1} + \frac{1}{t-1} - \frac{1}{t-2} - \frac{1}{t+3} \right)$$

$$28. y = \frac{2u^2}{\sqrt{u^2+1}} \Rightarrow \ln y = \ln 2 + \ln u + u \ln 2 - \frac{1}{2} \ln(u^2+1) \Rightarrow \left(\frac{1}{y} \right) \left(\frac{dy}{du} \right) = \frac{1}{u} + \ln 2 - \frac{1}{2} \left(\frac{2u}{u^2+1} \right) \\ \Rightarrow \frac{dy}{du} = \frac{2u^2}{\sqrt{u^2+1}} \left(\frac{1}{u} + \ln 2 - \frac{u}{u^2+1} \right)$$

$$29. y = (\sin \theta)^{\sqrt{\theta}} \Rightarrow \ln y = \sqrt{\theta} \ln(\sin \theta) \Rightarrow \left(\frac{1}{y} \right) \left(\frac{dy}{d\theta} \right) = \sqrt{\theta} \left(\frac{\cos \theta}{\sin \theta} \right) + \frac{1}{2} \theta^{-1/2} \ln(\sin \theta) \\ \Rightarrow \frac{dy}{d\theta} = (\sin \theta)^{\sqrt{\theta}} \left(\sqrt{\theta} \cot \theta + \frac{\ln(\sin \theta)}{2\sqrt{\theta}} \right)$$

$$30. y = (\ln x)^{1/\ln x} \Rightarrow \ln y = \left(\frac{1}{\ln x} \right) \ln(\ln x) \Rightarrow \frac{y'}{y} = \left(\frac{1}{\ln x} \right) \left(\frac{1}{\ln x} \right) \left(\frac{1}{x} \right) + \ln(\ln x) \left[\frac{-1}{(\ln x)^2} \right] \left(\frac{1}{x} \right) \\ \Rightarrow y' = (\ln x)^{1/\ln x} \left[\frac{1 - \ln(\ln x)}{x(\ln x)^2} \right]$$

$$31. \int e^x \sin(e^x) dx = \int \sin u du, \text{ where } u = e^x \text{ and } du = e^x dx \\ = -\cos u + C = -\cos(e^x) + C$$

$$32. \int e^t \cos(3e^t - 2) dt = \frac{1}{3} \int \cos u du, \text{ where } u = 3e^t - 2 \text{ and } du = 3e^t dt \\ = \frac{1}{3} \sin u + C = \frac{1}{3} \sin(3e^t - 2) + C$$

$$33. \int e^x \sec^2(e^x - 7) dx = \int \sec^2 u du, \text{ where } u = e^x - 7 \text{ and } du = e^x dx \\ = \tan u + C = \tan(e^x - 7) + C$$

$$34. \int e^y \csc(e^y + 1) \cot(e^y + 1) dy = \int \csc u \cot u du, \text{ where } u = e^y + 1 \text{ and } du = e^y dy \\ = -\csc u + C = -\csc(e^y + 1) + C$$

$$35. \int (\sec^2 x) e^{\tan x} dx = \int e^u du, \text{ where } u = \tan x \text{ and } du = \sec^2 x dx \\ = e^u + C = e^{\tan x} + C$$

$$36. \int (\csc^2 x) e^{\cot x} dx = -\int e^u du, \text{ where } u = \cot x \text{ and } du = -\csc^2 x dx \\ = -e^u + C = -e^{\cot x} + C$$

$$37. \int_{-1}^1 \frac{1}{3x-4} dx = \frac{1}{3} \int_{-7}^{-1} \frac{1}{u} du, \text{ where } u = 3x-4, du = 3 dx; x = -1 \Rightarrow u = -7, x = 1 \Rightarrow u = -1 \\ = \frac{1}{3} [\ln |u|]_{-7}^{-1} = \frac{1}{3} [\ln |-1| - \ln |-7|] = \frac{1}{3} [0 - \ln 7] = -\frac{\ln 7}{3}$$

$$38. \int_1^e \frac{\sqrt{\ln x}}{x} dx = \int_0^1 u^{1/2} du, \text{ where } u = \ln x, du = \frac{1}{x} dx; x = 1 \Rightarrow u = 0, x = e \Rightarrow u = 1 \\ = \left[\frac{2}{3} u^{3/2} \right]_0^1 = \left[\frac{2}{3} 1^{3/2} - \frac{2}{3} 0^{3/2} \right] = \frac{2}{3}$$

$$39. \int_0^\pi \tan\left(\frac{x}{3}\right) dx = \int_0^\pi \frac{\sin(\frac{x}{3})}{\cos(\frac{x}{3})} dx = -3 \int_1^{1/2} \frac{1}{u} du, \text{ where } u = \cos\left(\frac{x}{3}\right), du = -\frac{1}{3} \sin\left(\frac{x}{3}\right) dx; x = 0 \Rightarrow u = 1, x = \pi \\ \Rightarrow u = \frac{1}{2} \\ = -3 [\ln |u|]_1^{1/2} = -3 [\ln |\frac{1}{2}| - \ln |1|] = -3 \ln \frac{1}{2} = \ln 2^3 = \ln 8$$

$$40. \int_{1/6}^{1/4} 2 \cot \pi x \, dx = 2 \int_{1/6}^{1/4} \frac{\cos \pi x}{\sin \pi x} \, dx = \frac{2}{\pi} \int_{1/2}^{1/\sqrt{2}} \frac{1}{u} \, du, \text{ where } u = \sin \pi x, \, du = \pi \cos \pi x \, dx; \, x = \frac{1}{6} \Rightarrow u = \frac{1}{2}, \, x = \frac{1}{4} \\ \Rightarrow u = \frac{1}{\sqrt{2}}$$

$$= \frac{2}{\pi} [\ln |u|]_{1/2}^{1/\sqrt{2}} = \frac{2}{\pi} \left[\ln \left| \frac{1}{\sqrt{2}} \right| - \ln \left| \frac{1}{2} \right| \right] = \frac{2}{\pi} \left[\ln 1 - \frac{1}{2} \ln 2 - \ln 1 + \ln 2 \right] = \frac{2}{\pi} \left[\frac{1}{2} \ln 2 \right] = \frac{\ln 2}{\pi}$$

$$41. \int_0^4 \frac{2t}{t^2-25} \, dt = \int_{-25}^{-9} \frac{1}{u} \, du, \text{ where } u = t^2 - 25, \, du = 2t \, dt; \, t = 0 \Rightarrow u = -25, \, t = 4 \Rightarrow u = -9 \\ = [\ln |u|]_{-25}^{-9} = \ln |-9| - \ln |-25| = \ln 9 - \ln 25 = \ln \frac{9}{25}$$

$$42. \int_{-\pi/2}^{\pi/6} \frac{\cos t}{1 - \sin t} \, dt = - \int_2^{1/2} \frac{1}{u} \, du, \text{ where } u = 1 - \sin t, \, du = -\cos t \, dt; \, t = -\frac{\pi}{2} \Rightarrow u = 2, \, t = \frac{\pi}{6} \Rightarrow u = \frac{1}{2} \\ = - [\ln |u|]_2^{1/2} = - \left[\ln \left| \frac{1}{2} \right| - \ln |2| \right] = - \ln 1 + \ln 2 + \ln 2 = 2 \ln 2 = \ln 4$$

$$43. \int \frac{\tan(\ln v)}{v} \, dv = \int \tan u \, du = \int \frac{\sin u}{\cos u} \, du, \text{ where } u = \ln v \text{ and } du = \frac{1}{v} \, dv \\ = - \ln |\cos u| + C = - \ln |\cos(\ln v)| + C$$

$$44. \int \frac{1}{v \ln v} \, dv = \int \frac{1}{u} \, du, \text{ where } u = \ln v \text{ and } du = \frac{1}{v} \, dv \\ = \ln |u| + C = \ln |\ln v| + C$$

$$45. \int \frac{(\ln x)^{-3}}{x} \, dx = \int u^{-3} \, du, \text{ where } u = \ln x \text{ and } du = \frac{1}{x} \, dx \\ = \frac{u^{-2}}{-2} + C = -\frac{1}{2} (\ln x)^{-2} + C$$

$$46. \int \frac{\ln(x-5)}{x-5} \, dx = \int u \, du, \text{ where } u = \ln(x-5) \text{ and } du = \frac{1}{x-5} \, dx \\ = \frac{u^2}{2} + C = \frac{[\ln(x-5)]^2}{2} + C$$

$$47. \int \frac{1}{r} \csc^2(1 + \ln r) \, dr = \int \csc^2 u \, du, \text{ where } u = 1 + \ln r \text{ and } du = \frac{1}{r} \, dr \\ = -\cot u + C = -\cot(1 + \ln r) + C$$

$$48. \int \frac{\cos(1 - \ln v)}{v} \, dv = - \int \cos u \, du, \text{ where } u = 1 - \ln v \text{ and } du = -\frac{1}{v} \, dv \\ = -\sin u + C = -\sin(1 - \ln v) + C$$

$$49. \int x 3^{x^2} \, dx = \frac{1}{2} \int 3^u \, du, \text{ where } u = x^2 \text{ and } du = 2x \, dx \\ = \frac{1}{2 \ln 3} (3^u) + C = \frac{1}{2 \ln 3} (3^{x^2}) + C$$

$$50. \int 2^{\tan x} \sec^2 x \, dx = \int 2^u \, du, \text{ where } u = \tan x \text{ and } du = \sec^2 x \, dx \\ = \frac{1}{\ln 2} (2^u) + C = \frac{2^{\tan x}}{\ln 2} + C$$

$$51. \int_1^7 \frac{3}{x} \, dx = 3 \int_1^7 \frac{1}{x} \, dx = 3 [\ln |x|]_1^7 = 3 (\ln 7 - \ln 1) = 3 \ln 7$$

$$52. \int_1^{32} \frac{1}{5x} \, dx = \frac{1}{5} \int_1^{32} \frac{1}{x} \, dx = \frac{1}{5} [\ln |x|]_1^{32} = \frac{1}{5} (\ln 32 - \ln 1) = \frac{1}{5} \ln 32 = \ln \left(\sqrt[5]{32} \right) = \ln 2$$

53. $\int_1^4 \left(\frac{x}{8} + \frac{1}{2x}\right) dx = \frac{1}{2} \int_1^4 \left(\frac{1}{4}x + \frac{1}{x}\right) dx = \frac{1}{2} \left[\frac{1}{8}x^2 + \ln|x|\right]_1^4 = \frac{1}{2} \left[\left(\frac{16}{8} + \ln 4\right) - \left(\frac{1}{8} + \ln 1\right)\right] = \frac{15}{16} + \frac{1}{2} \ln 4$
 $= \frac{15}{16} + \ln \sqrt{4} = \frac{15}{16} + \ln 2$
54. $\int_1^8 \left(\frac{2}{3x} - \frac{8}{x^2}\right) dx = \frac{2}{3} \int_1^8 \left(\frac{1}{x} - 12x^{-2}\right) dx = \frac{2}{3} \left[\ln|x| + 12x^{-1}\right]_1^8 = \frac{2}{3} \left[\left(\ln 8 + \frac{12}{8}\right) - \left(\ln 1 + 12\right)\right]$
 $= \frac{2}{3} \left(\ln 8 + \frac{3}{2} - 12\right) = \frac{2}{3} \left(\ln 8 - \frac{21}{2}\right) = \frac{2}{3} (\ln 8) - 7 = \ln(8^{2/3}) - 7 = \ln 4 - 7$
55. $\int_{-2}^{-1} e^{-(x+1)} dx = -\int_1^0 e^u du$, where $u = -(x+1)$, $du = -dx$; $x = -2 \Rightarrow u = 1$, $x = -1 \Rightarrow u = 0$
 $= -[e^u]_1^0 = -(e^0 - e^1) = e - 1$
56. $\int_{-\ln 2}^0 e^{2w} dw = \frac{1}{2} \int_{\ln(1/4)}^0 e^u du$, where $u = 2w$, $du = 2 dw$; $w = -\ln 2 \Rightarrow u = \ln \frac{1}{4}$, $w = 0 \Rightarrow u = 0$
 $= \frac{1}{2} [e^u]_{\ln(1/4)}^0 = \frac{1}{2} [e^0 - e^{\ln(1/4)}] = \frac{1}{2} \left(1 - \frac{1}{4}\right) = \frac{3}{8}$
57. $\int_1^{\ln 5} e^r (3e^r + 1)^{-3/2} dr = \frac{1}{3} \int_4^{16} u^{-3/2} du$, where $u = 3e^r + 1$, $du = 3e^r dr$; $r = 0 \Rightarrow u = 4$, $r = \ln 5 \Rightarrow u = 16$
 $= -\frac{2}{3} [u^{-1/2}]_4^{16} = -\frac{2}{3} (16^{-1/2} - 4^{-1/2}) = \left(-\frac{2}{3}\right) \left(\frac{1}{4} - \frac{1}{2}\right) = \left(-\frac{2}{3}\right) \left(-\frac{1}{4}\right) = \frac{1}{6}$
58. $\int_0^{\ln 9} e^\theta (e^\theta - 1)^{1/2} d\theta = \int_0^8 u^{1/2} du$, where $u = e^\theta - 1$, $du = e^\theta d\theta$; $\theta = 0 \Rightarrow u = 0$, $\theta = \ln 9 \Rightarrow u = 8$
 $= \frac{2}{3} [u^{3/2}]_0^8 = \frac{2}{3} (8^{3/2} - 0^{3/2}) = \frac{2}{3} (2^{9/2} - 0) = \frac{2}{3} (2^{9/2}) = \frac{32\sqrt{2}}{3}$
59. $\int_1^e \frac{1}{x} (1 + 7 \ln x)^{-1/3} dx = \frac{1}{7} \int_1^8 u^{-1/3} du$, where $u = 1 + 7 \ln x$, $du = \frac{7}{x} dx$, $x = 1 \Rightarrow u = 1$, $x = e \Rightarrow u = 8$
 $= \frac{3}{14} [u^{2/3}]_1^8 = \frac{3}{14} (8^{2/3} - 1^{2/3}) = \left(\frac{3}{14}\right) (4 - 1) = \frac{9}{14}$
60. $\int_e^{e^2} \frac{1}{x\sqrt{\ln x}} dx = \int_e^{e^2} (\ln x)^{-1/2} \frac{1}{x} dx = \int_1^2 u^{-1/2} du$, where $u = \ln x$, $du = \frac{1}{x} dx$; $x = e \Rightarrow u = 1$, $x = e^2 \Rightarrow u = 2$
 $= 2 [u^{1/2}]_1^2 = 2 (\sqrt{2} - 1) = 2\sqrt{2} - 2$
61. $\int_1^3 \frac{[\ln(v+1)]^2}{v+1} dv = \int_1^3 [\ln(v+1)]^2 \frac{1}{v+1} dv = \int_{\ln 2}^{\ln 4} u^2 du$, where $u = \ln(v+1)$, $du = \frac{1}{v+1} dv$;
 $v = 1 \Rightarrow u = \ln 2$, $v = 3 \Rightarrow u = \ln 4$;
 $= \frac{1}{3} [u^3]_{\ln 2}^{\ln 4} = \frac{1}{3} [(\ln 4)^3 - (\ln 2)^3] = \frac{1}{3} [(2 \ln 2)^3 - (\ln 2)^3] = \frac{(\ln 2)^3}{3} (8 - 1) = \frac{7}{3} (\ln 2)^3$
62. $\int_2^4 (1 + \ln t)(t \ln t) dt = \int_2^4 (t \ln t)(1 + \ln t) dt = \int_{2 \ln 2}^{4 \ln 4} u du$, where $u = t \ln t$, $du = \left(t \left(\frac{1}{t}\right) + (\ln t)(1)\right) dt$
 $= (1 + \ln t) dt$; $t = 2 \Rightarrow u = 2 \ln 2$, $t = 4$
 $\Rightarrow u = 4 \ln 4$
 $= \frac{1}{2} [u^2]_{2 \ln 2}^{4 \ln 4} = \frac{1}{2} [(4 \ln 4)^2 - (2 \ln 2)^2] = \frac{1}{2} [(8 \ln 2)^2 - (2 \ln 2)^2] = \frac{(2 \ln 2)^2}{2} (16 - 1) = 30 (\ln 2)^2$
63. $\int_1^8 \frac{\log_4 \theta}{\theta} d\theta = \frac{1}{\ln 4} \int_1^8 (\ln \theta) \left(\frac{1}{\theta}\right) d\theta = \frac{1}{\ln 4} \int_0^{\ln 8} u du$, where $u = \ln \theta$, $du = \frac{1}{\theta} d\theta$, $\theta = 1 \Rightarrow u = 0$, $\theta = 8 \Rightarrow u = \ln 8$
 $= \frac{1}{2 \ln 4} [u^2]_0^{\ln 8} = \frac{1}{\ln 16} [(\ln 8)^2 - 0^2] = \frac{(3 \ln 2)^2}{4 \ln 2} = \frac{9 \ln 2}{4}$
64. $\int_1^e \frac{8(\ln 3)(\log_3 \theta)}{\theta} d\theta = \int_1^e \frac{8(\ln 3)(\ln \theta)}{\theta(\ln 3)} d\theta = 8 \int_1^e (\ln \theta) \left(\frac{1}{\theta}\right) d\theta = 8 \int_0^1 u du$, where $u = \ln \theta$, $du = \frac{1}{\theta} d\theta$;
 $\theta = 1 \Rightarrow u = 0$, $\theta = e \Rightarrow u = 1$
 $= 4 [u^2]_0^1 = 4 (1^2 - 0^2) = 4$

$$65. \int_{-3/4}^{3/4} \frac{6}{\sqrt{9-4x^2}} dx = 3 \int_{-3/4}^{3/4} \frac{2}{\sqrt{3^2-(2x)^2}} dx = 3 \int_{-3/2}^{3/2} \frac{1}{\sqrt{3^2-u^2}} du, \text{ where } u = 2x, du = 2 dx;$$

$$x = -\frac{3}{4} \Rightarrow u = -\frac{3}{2}, x = \frac{3}{4} \Rightarrow u = \frac{3}{2}$$

$$= 3 \left[\sin^{-1} \left(\frac{u}{3} \right) \right]_{-3/2}^{3/2} = 3 \left[\sin^{-1} \left(\frac{1}{2} \right) - \sin^{-1} \left(-\frac{1}{2} \right) \right] = 3 \left[\frac{\pi}{6} - \left(-\frac{\pi}{6} \right) \right] = 3 \left(\frac{\pi}{3} \right) = \pi$$

$$66. \int_{-1/5}^{1/5} \frac{6}{\sqrt{4-25x^2}} dx = \frac{6}{5} \int_{-1/5}^{1/5} \frac{5}{\sqrt{2^2-(5x)^2}} dx = \frac{6}{5} \int_{-1}^1 \frac{1}{\sqrt{2^2-u^2}} du, \text{ where } u = 5x, du = 5 dx;$$

$$x = -\frac{1}{5} \Rightarrow u = -1, x = \frac{1}{5} \Rightarrow u = 1$$

$$= \frac{6}{5} \left[\sin^{-1} \left(\frac{u}{2} \right) \right]_{-1}^1 = \frac{6}{5} \left[\sin^{-1} \left(\frac{1}{2} \right) - \sin^{-1} \left(-\frac{1}{2} \right) \right] = \frac{6}{5} \left[\frac{\pi}{6} - \left(-\frac{\pi}{6} \right) \right] = \frac{6}{5} \left(\frac{\pi}{3} \right) = \frac{2\pi}{5}$$

$$67. \int_{-2}^2 \frac{3}{4+3t^2} dt = \sqrt{3} \int_{-2}^2 \frac{\sqrt{3}}{2^2+(\sqrt{3}t)^2} dt = \sqrt{3} \int_{-2\sqrt{3}}^{2\sqrt{3}} \frac{1}{2^2+u^2} du, \text{ where } u = \sqrt{3}t, du = \sqrt{3} dt;$$

$$t = -2 \Rightarrow u = -2\sqrt{3}, t = 2 \Rightarrow u = 2\sqrt{3}$$

$$= \sqrt{3} \left[\frac{1}{2} \tan^{-1} \left(\frac{u}{2} \right) \right]_{-2\sqrt{3}}^{2\sqrt{3}} = \frac{\sqrt{3}}{2} \left[\tan^{-1} \left(\sqrt{3} \right) - \tan^{-1} \left(-\sqrt{3} \right) \right] = \frac{\sqrt{3}}{2} \left[\frac{\pi}{3} - \left(-\frac{\pi}{3} \right) \right] = \frac{\pi}{\sqrt{3}}$$

$$68. \int_{\sqrt{3}}^3 \frac{1}{3+t^2} dt = \int_{\sqrt{3}}^3 \frac{1}{(\sqrt{3})^2+t^2} dt = \left[\frac{1}{\sqrt{3}} \tan^{-1} \left(\frac{t}{\sqrt{3}} \right) \right]_{\sqrt{3}}^3 = \frac{1}{\sqrt{3}} \left(\tan^{-1} \sqrt{3} - \tan^{-1} 1 \right) = \frac{1}{\sqrt{3}} \left(\frac{\pi}{3} - \frac{\pi}{4} \right) = \frac{\sqrt{3}\pi}{36}$$

$$69. \int \frac{1}{y\sqrt{4y^2-1}} dy = \int \frac{2}{(2y)\sqrt{(2y)^2-1}} dy = \int \frac{1}{u\sqrt{u^2-1}} du, \text{ where } u = 2y \text{ and } du = 2 dy$$

$$= \sec^{-1} |u| + C = \sec^{-1} |2y| + C$$

$$70. \int \frac{24}{y\sqrt{y^2-16}} dy = 24 \int \frac{1}{y\sqrt{y^2-4^2}} dy = 24 \left(\frac{1}{4} \sec^{-1} \left| \frac{y}{4} \right| \right) + C = 6 \sec^{-1} \left| \frac{y}{4} \right| + C$$

$$71. \int_{\sqrt{2/3}}^{2/3} \frac{1}{|y|\sqrt{9y^2-1}} dy = \int_{\sqrt{2/3}}^{2/3} \frac{3}{|3y|\sqrt{(3y)^2-1}} dy = \int_{\sqrt{2}}^2 \frac{1}{|u|\sqrt{u^2-1}} du, \text{ where } u = 3y, du = 3 dy;$$

$$y = \frac{\sqrt{2}}{3} \Rightarrow u = \sqrt{2}, y = \frac{2}{3} \Rightarrow u = 2$$

$$= \left[\sec^{-1} u \right]_{\sqrt{2}}^2 = \left[\sec^{-1} 2 - \sec^{-1} \sqrt{2} \right] = \frac{\pi}{3} - \frac{\pi}{4} = \frac{\pi}{12}$$

$$72. \int_{-2\sqrt{5}}^{-\sqrt{6}/\sqrt{5}} \frac{1}{|y|\sqrt{5y^2-3}} dy = \int_{-2\sqrt{5}}^{-\sqrt{6}/\sqrt{5}} \frac{\sqrt{5}}{-\sqrt{5}y\sqrt{(\sqrt{5}y)^2-(\sqrt{3})^2}} dy = \int_{-2}^{-\sqrt{6}} \frac{1}{-u\sqrt{u^2-(\sqrt{3})^2}} du,$$

$$\text{where } u = \sqrt{5}y, du = \sqrt{5} dy; y = -\frac{2}{\sqrt{5}} \Rightarrow u = -2, y = -\frac{\sqrt{6}}{\sqrt{5}} \Rightarrow u = -\sqrt{6}$$

$$= \left[-\frac{1}{\sqrt{3}} \sec^{-1} \left| \frac{u}{\sqrt{3}} \right| \right]_{-2}^{-\sqrt{6}} = \frac{-1}{\sqrt{3}} \left[\sec^{-1} \sqrt{2} - \sec^{-1} \frac{2}{\sqrt{3}} \right] = \frac{-1}{\sqrt{3}} \left(\frac{\pi}{4} - \frac{\pi}{6} \right) = \frac{-1}{\sqrt{3}} \left[\frac{3\pi}{12} - \frac{2\pi}{12} \right] = \frac{-\pi}{12\sqrt{3}} = \frac{-\sqrt{3}\pi}{36}$$

$$73. \int \frac{1}{\sqrt{-2x-x^2}} dx = \int \frac{1}{\sqrt{1-(x^2+2x+1)}} dx = \int \frac{1}{\sqrt{1-(x+1)^2}} dx = \int \frac{1}{\sqrt{1-u^2}} du, \text{ where } u = x+1 \text{ and}$$

$$du = dx$$

$$= \sin^{-1} u + C = \sin^{-1} (x+1) + C$$

$$74. \int \frac{1}{\sqrt{-x^2+4x-1}} dx = \int \frac{1}{\sqrt{3-(x^2-4x+4)}} dx = \int \frac{1}{\sqrt{(\sqrt{3})^2-(x-2)^2}} dx = \int \frac{1}{\sqrt{(\sqrt{3})^2-u^2}} du$$

$$\text{where } u = x-2 \text{ and } du = dx$$

$$= \sin^{-1} \left(\frac{u}{\sqrt{3}} \right) + C = \sin^{-1} \left(\frac{x-2}{\sqrt{3}} \right) + C$$

75. $\int_{-2}^{-1} \frac{2}{v^2+4v+5} dv = 2 \int_{-2}^{-1} \frac{1}{1+(v^2+4v+4)} dv = 2 \int_{-2}^{-1} \frac{1}{1+(v+2)^2} dv = 2 \int_0^1 \frac{1}{1+u^2} du,$
 where $u = v + 2, du = dv; v = -2 \Rightarrow u = 0, v = -1 \Rightarrow u = 1$
 $= 2 [\tan^{-1} u]_0^1 = 2 (\tan^{-1} 1 - \tan^{-1} 0) = 2 \left(\frac{\pi}{4} - 0\right) = \frac{\pi}{2}$
76. $\int_{-1}^1 \frac{3}{4v^2+4v+4} dv = \frac{3}{4} \int_{-1}^1 \frac{1}{\frac{3}{4} + (v^2+v+\frac{1}{4})} dv = \frac{3}{4} \int_{-1}^1 \frac{1}{\left(\frac{\sqrt{3}}{2}\right)^2 + (v+\frac{1}{2})^2} dv = \frac{3}{4} \int_{-1/2}^{3/2} \frac{1}{\left(\frac{\sqrt{3}}{2}\right)^2 + u^2} du$
 where $u = v + \frac{1}{2}, du = dv; v = -1 \Rightarrow u = -\frac{1}{2}, v = 1 \Rightarrow u = \frac{3}{2}$
 $= \frac{3}{4} \left[\frac{2}{\sqrt{3}} \tan^{-1} \left(\frac{2u}{\sqrt{3}} \right) \right]_{-1/2}^{3/2} = \frac{\sqrt{3}}{2} \left[\tan^{-1} \sqrt{3} - \tan^{-1} \left(-\frac{1}{\sqrt{3}} \right) \right] = \frac{\sqrt{3}}{2} \left[\frac{\pi}{3} - \left(-\frac{\pi}{6} \right) \right] = \frac{\sqrt{3}}{2} \left(\frac{2\pi}{6} + \frac{\pi}{6} \right) = \frac{\sqrt{3}}{2} \cdot \frac{\pi}{2}$
 $= \frac{\sqrt{3}\pi}{4}$
77. $\int \frac{1}{(t+1)\sqrt{t^2+2t-8}} dt = \int \frac{1}{(t+1)\sqrt{(t^2+2t+1)-9}} dt = \int \frac{1}{(t+1)\sqrt{(t+1)^2-3^2}} dt = \int \frac{1}{u\sqrt{u^2-3^2}} du$
 where $u = t + 1$ and $du = dt$
 $= \frac{1}{3} \sec^{-1} \left| \frac{u}{3} \right| + C = \frac{1}{3} \sec^{-1} \left| \frac{t+1}{3} \right| + C$
78. $\int \frac{1}{(3t+1)\sqrt{9t^2+6t}} dt = \int \frac{1}{(3t+1)\sqrt{(9t^2+6t+1)-1}} dt = \int \frac{1}{(3t+1)\sqrt{(3t+1)^2-1^2}} dt = \frac{1}{3} \int \frac{1}{u\sqrt{u^2-1}} du$
 where $u = 3t + 1$ and $du = 3 dt$
 $= \frac{1}{3} \sec^{-1} |u| + C = \frac{1}{3} \sec^{-1} |3t + 1| + C$
79. $3^y = 2^{y+1} \Rightarrow \ln 3^y = \ln 2^{y+1} \Rightarrow y(\ln 3) = (y+1) \ln 2 \Rightarrow (\ln 3 - \ln 2)y = \ln 2 \Rightarrow \left(\ln \frac{3}{2}\right)y = \ln 2 \Rightarrow y = \frac{\ln 2}{\ln \left(\frac{3}{2}\right)}$
80. $4^{-y} = 3^{y+2} \Rightarrow \ln 4^{-y} = \ln 3^{y+2} \Rightarrow -y \ln 4 = (y+2) \ln 3 \Rightarrow -2 \ln 3 = (\ln 3 + \ln 4)y \Rightarrow (\ln 12)y = -2 \ln 3$
 $\Rightarrow y = -\frac{\ln 9}{\ln 12}$
81. $9e^{2y} = x^2 \Rightarrow e^{2y} = \frac{x^2}{9} \Rightarrow \ln e^{2y} = \ln \left(\frac{x^2}{9}\right) \Rightarrow 2y(\ln e) = \ln \left(\frac{x^2}{9}\right) \Rightarrow y = \frac{1}{2} \ln \left(\frac{x^2}{9}\right) = \ln \sqrt{\frac{x^2}{9}} = \ln \left|\frac{x}{3}\right| = \ln |x| - \ln 3$
82. $3^y = 3 \ln x \Rightarrow \ln 3^y = \ln(3 \ln x) \Rightarrow y \ln 3 = \ln(3 \ln x) \Rightarrow y = \frac{\ln(3 \ln x)}{\ln 3} = \frac{\ln 3 + \ln(\ln x)}{\ln 3}$
83. $\ln(y-1) = x + \ln y \Rightarrow e^{\ln(y-1)} = e^{(x+\ln y)} = e^x e^{\ln y} \Rightarrow y-1 = ye^x \Rightarrow y - ye^x = 1 \Rightarrow y(1 - e^x) = 1$
 $\Rightarrow y = \frac{1}{1-e^x}$
84. $\ln(10 \ln y) = \ln 5x \Rightarrow e^{\ln(10 \ln y)} = e^{\ln 5x} \Rightarrow 10 \ln y = 5x \Rightarrow \ln y = \frac{x}{2} \Rightarrow e^{\ln y} = e^{x/2} \Rightarrow y = e^{x/2}$
85. The limit leads to the indeterminate form $\frac{0}{0}$: $\lim_{x \rightarrow 0} \frac{10^x - 1}{x} = \lim_{x \rightarrow 0} \frac{(\ln 10)10^x}{1} = \ln 10$
86. The limit leads to the indeterminate form $\frac{0}{0}$: $\lim_{\theta \rightarrow 0} \frac{3^\theta - 1}{\theta} = \lim_{\theta \rightarrow 0} \frac{(\ln 3)3^\theta}{1} = \ln 3$
87. The limit leads to the indeterminate form $\frac{0}{0}$: $\lim_{x \rightarrow 0} \frac{2^{\sin x} - 1}{e^x - 1} = \lim_{x \rightarrow 0} \frac{2^{\sin x}(\ln 2)(\cos x)}{e^x} = \ln 2$
88. The limit leads to the indeterminate form $\frac{0}{0}$: $\lim_{x \rightarrow 0} \frac{2^{-\sin x} - 1}{e^x - 1} = \lim_{x \rightarrow 0} \frac{2^{-\sin x}(\ln 2)(-\cos x)}{e^x} = -\ln 2$
89. The limit leads to the indeterminate form $\frac{0}{0}$: $\lim_{x \rightarrow 0} \frac{5 - 5 \cos x}{e^x - x - 1} = \lim_{x \rightarrow 0} \frac{5 \sin x}{e^x - 1} = \lim_{x \rightarrow 0} \frac{5 \cos x}{e^x} = 5$

90. The limit leads to the indeterminate form $\frac{0}{0}$: $\lim_{x \rightarrow 0} \frac{4-4e^x}{xe^x} = \lim_{x \rightarrow 0} \frac{-4e^x}{e^x + xe^x} = -4$

91. The limit leads to the indeterminate form $\frac{0}{0}$: $\lim_{t \rightarrow 0^+} \frac{t - \ln(1+2t)}{t^2} = \lim_{t \rightarrow 0^+} \frac{(1 - \frac{2}{1+2t})}{2t} = -\infty$

92. The limit leads to the indeterminate form $\frac{0}{0}$: $\lim_{x \rightarrow 4} \frac{\sin^2(\pi x)}{e^{x-4} + 3 - x} = \lim_{x \rightarrow 4} \frac{2\pi(\sin \pi x)(\cos \pi x)}{e^{x-4} - 1}$
 $= \lim_{x \rightarrow 4} \frac{\pi \sin(2\pi x)}{e^{x-4} - 1} = \lim_{x \rightarrow 4} \frac{2\pi^2 \cos(2\pi x)}{e^{x-4}} = 2\pi^2$

93. The limit leads to the indeterminate form $\frac{0}{0}$: $\lim_{t \rightarrow 0^+} \left(\frac{e^t}{t} - \frac{1}{t} \right) = \lim_{t \rightarrow 0^+} \left(\frac{e^t - 1}{t} \right) = \lim_{t \rightarrow 0^+} \frac{e^t}{1} = 1$

94. The limit leads to the indeterminate form $\frac{\infty}{\infty}$: $\lim_{y \rightarrow 0^+} e^{-1/y} \ln y = \lim_{y \rightarrow 0^+} \frac{\ln y}{e^{y^{-1}}} = \lim_{y \rightarrow 0^+} \frac{y^{-1}}{-e^{y^{-1}}(y^{-2})}$
 $= - \lim_{y \rightarrow 0^+} \frac{y}{e^{y^{-1}}} = 0$

95. Let $f(x) = \left(1 + \frac{3}{x}\right)^x \Rightarrow \ln f(x) = \frac{\ln(1+3x^{-1})}{x^{-1}} \Rightarrow \lim_{x \rightarrow \infty} \ln f(x) = \lim_{x \rightarrow \infty} \frac{\ln(1+3x^{-1})}{x^{-1}}$; the limit leads to the indeterminate form $\frac{0}{0}$: $\lim_{x \rightarrow \infty} \frac{\left(\frac{-3x^{-2}}{1+3x^{-1}}\right)}{-x^{-2}} = \lim_{x \rightarrow \infty} \frac{3}{1+\frac{3}{x}} = 3 \Rightarrow \lim_{x \rightarrow \infty} \left(1 + \frac{3}{x}\right)^x = \lim_{x \rightarrow \infty} e^{\ln f(x)} = e^3$

96. Let $f(x) = \left(1 + \frac{3}{x}\right)^x \Rightarrow \ln f(x) = x \ln \left(1 + \frac{3}{x}\right) \Rightarrow \lim_{x \rightarrow 0^+} \ln f(x) = \lim_{x \rightarrow 0^+} \frac{\ln(1+3x^{-1})}{x^{-1}}$; the limit leads to the indeterminate form $\frac{\infty}{\infty}$: $\lim_{x \rightarrow 0^+} \frac{\left(\frac{-3x^{-2}}{1+3x^{-1}}\right)}{-x^{-2}} = \lim_{x \rightarrow 0^+} \frac{3x}{x+3} = 0 \Rightarrow \lim_{x \rightarrow 0^+} \left(1 + \frac{3}{x}\right)^x = \lim_{x \rightarrow 0^+} e^{\ln f(x)} = e^0 = 1$

97. (a) $\lim_{x \rightarrow \infty} \frac{\log_2 x}{\log_3 x} = \lim_{x \rightarrow \infty} \frac{\left(\frac{\ln x}{\ln 2}\right)}{\left(\frac{\ln x}{\ln 3}\right)} = \lim_{x \rightarrow \infty} \frac{\ln 3}{\ln 2} = \frac{\ln 3}{\ln 2} \Rightarrow$ same rate

(b) $\lim_{x \rightarrow \infty} \frac{x}{x + \left(\frac{1}{x}\right)} = \lim_{x \rightarrow \infty} \frac{x^2}{x^2 + 1} = \lim_{x \rightarrow \infty} \frac{2x}{2x} = \lim_{x \rightarrow \infty} 1 = 1 \Rightarrow$ same rate

(c) $\lim_{x \rightarrow \infty} \frac{\left(\frac{x}{100}\right)}{xe^{-x}} = \lim_{x \rightarrow \infty} \frac{xe^x}{100x} = \lim_{x \rightarrow \infty} \frac{e^x}{100} = \infty \Rightarrow$ faster

(d) $\lim_{x \rightarrow \infty} \frac{x}{\tan^{-1} x} = \infty \Rightarrow$ faster

(e) $\lim_{x \rightarrow \infty} \frac{\csc^{-1} x}{\left(\frac{1}{x}\right)} = \lim_{x \rightarrow \infty} \frac{\sin^{-1}(x^{-1})}{x^{-1}} = \lim_{x \rightarrow \infty} \frac{\left(\frac{-x^{-2}}{\sqrt{1-(x^{-1})^2}}\right)}{-x^{-2}} = \lim_{x \rightarrow \infty} \frac{1}{\sqrt{1-\left(\frac{1}{x^2}\right)}} = 1 \Rightarrow$ same rate

(f) $\lim_{x \rightarrow \infty} \frac{\sinh x}{e^x} = \lim_{x \rightarrow \infty} \frac{(e^x - e^{-x})}{2e^x} = \lim_{x \rightarrow \infty} \frac{1 - e^{-2x}}{2} = \frac{1}{2} \Rightarrow$ same rate

98. (a) $\lim_{x \rightarrow \infty} \frac{3^{-x}}{2^{-x}} = \lim_{x \rightarrow \infty} \left(\frac{2}{3}\right)^x = 0 \Rightarrow$ slower

(b) $\lim_{x \rightarrow \infty} \frac{\ln 2x}{\ln x^2} = \lim_{x \rightarrow \infty} \frac{\ln 2 + \ln x}{2(\ln x)} = \lim_{x \rightarrow \infty} \left(\frac{\ln 2}{2 \ln x} + \frac{1}{2}\right) = \frac{1}{2} \Rightarrow$ same rate

(c) $\lim_{x \rightarrow \infty} \frac{10x^3 + 2x^2}{e^x} = \lim_{x \rightarrow \infty} \frac{30x^2 + 4x}{e^x} = \lim_{x \rightarrow \infty} \frac{60x + 4}{e^x} = \lim_{x \rightarrow \infty} \frac{60}{e^x} = 0 \Rightarrow$ slower

(d) $\lim_{x \rightarrow \infty} \frac{\tan^{-1}\left(\frac{1}{x}\right)}{\left(\frac{1}{x}\right)} = \lim_{x \rightarrow \infty} \frac{\tan^{-1}(x^{-1})}{x^{-1}} = \lim_{x \rightarrow \infty} \frac{\left(\frac{-x^{-2}}{1+x^{-2}}\right)}{-x^{-2}} = \lim_{x \rightarrow \infty} \frac{1}{1+\frac{1}{x^2}} = 1 \Rightarrow$ same rate

(e) $\lim_{x \rightarrow \infty} \frac{\sin^{-1}\left(\frac{1}{x}\right)}{\left(\frac{1}{x^2}\right)} = \lim_{x \rightarrow \infty} \frac{\sin^{-1}(x^{-1})}{x^{-2}} = \lim_{x \rightarrow \infty} \frac{\left(\frac{-x^{-2}}{\sqrt{1-(x^{-1})^2}}\right)}{-2x^{-3}} = \lim_{x \rightarrow \infty} \frac{x}{2\sqrt{1-\frac{1}{x^2}}} = \infty \Rightarrow$ faster

(f) $\lim_{x \rightarrow \infty} \frac{\operatorname{sech} x}{e^{-x}} = \lim_{x \rightarrow \infty} \frac{\left(\frac{2}{e^x + e^{-x}}\right)}{e^{-x}} = \lim_{x \rightarrow \infty} \frac{2}{e^{-x}(e^x + e^{-x})} = \lim_{x \rightarrow \infty} \left(\frac{2}{1+e^{-2x}}\right) = 2 \Rightarrow$ same rate

99. (a) $\frac{(\frac{1}{x^2} + \frac{1}{x^4})}{(\frac{1}{x^2})} = 1 + \frac{1}{x^2} \leq 2$ for x sufficiently large \Rightarrow true
 (b) $\frac{(\frac{1}{x^2} + \frac{1}{x^4})}{(\frac{1}{x^4})} = x^2 + 1 > M$ for any positive integer M whenever $x > \sqrt{M} \Rightarrow$ false
 (c) $\lim_{x \rightarrow \infty} \frac{x}{x + \ln x} = \lim_{x \rightarrow \infty} \frac{1}{1 + \frac{1}{x}} = 1 \Rightarrow$ the same growth rate \Rightarrow false
 (d) $\lim_{x \rightarrow \infty} \frac{\ln(\ln x)}{\ln x} = \lim_{x \rightarrow \infty} \frac{\left[\frac{(\frac{1}{x})}{\ln x}\right]}{\left(\frac{1}{x}\right)} = \lim_{x \rightarrow \infty} \frac{1}{\ln x} = 0 \Rightarrow$ grows slower \Rightarrow true
 (e) $\frac{\tan^{-1} x}{1} \leq \frac{\pi}{2}$ for all $x \Rightarrow$ true
 (f) $\frac{\cosh x}{e^x} = \frac{1}{2}(1 + e^{-2x}) \leq \frac{1}{2}(1 + 1) = 1$ if $x > 0 \Rightarrow$ true

100. (a) $\frac{(\frac{1}{x^4})}{(\frac{1}{x^2} + \frac{1}{x^4})} = \frac{1}{x^2 + 1} \leq 1$ if $x > 0 \Rightarrow$ true
 (b) $\lim_{x \rightarrow \infty} \frac{(\frac{1}{x^4})}{(\frac{1}{x^2} + \frac{1}{x^4})} = \lim_{x \rightarrow \infty} \left(\frac{1}{x^2 + 1}\right) = 0 \Rightarrow$ true
 (c) $\lim_{x \rightarrow \infty} \frac{\ln x}{x + 1} = \lim_{x \rightarrow \infty} \left(\frac{1}{x}\right) = 0 \Rightarrow$ true
 (d) $\frac{\ln 2x}{\ln x} = \frac{\ln 2}{\ln x} + 1 \leq 1 + 1 = 2$ if $x \geq 2 \Rightarrow$ true
 (e) $\frac{\sec^{-1} x}{1} = \frac{\cos^{-1}(\frac{1}{x})}{1} \leq \left(\frac{\pi}{2}\right) = \frac{\pi}{2}$ if $x > 1 \Rightarrow$ true
 (f) $\frac{\sinh x}{e^x} = \frac{1}{2}(1 - e^{-2x}) \leq \frac{1}{2}$ if $x > 0 \Rightarrow$ true

101. $\frac{df}{dx} = e^x + 1 \Rightarrow \left(\frac{df^{-1}}{dx}\right)_{x=f(\ln 2)} = \frac{1}{\left(\frac{df}{dx}\right)_{x=\ln 2}} \Rightarrow \left(\frac{df^{-1}}{dx}\right)_{x=f(\ln 2)} = \frac{1}{(e^x + 1)_{x=\ln 2}} = \frac{1}{2 + 1} = \frac{1}{3}$

102. $y = f(x) \Rightarrow y = 1 + \frac{1}{x} \Rightarrow \frac{1}{x} = y - 1 \Rightarrow x = \frac{1}{y-1} \Rightarrow f^{-1}(x) = \frac{1}{x-1}; f^{-1}(f(x)) = \frac{1}{(1 + \frac{1}{x}) - 1} = \frac{1}{(\frac{1}{x})} = x$ and
 $f(f^{-1}(x)) = 1 + \frac{1}{(\frac{1}{x-1})} = 1 + (x - 1) = x; \frac{df^{-1}}{dx} \Big|_{f(x)} = \frac{-1}{(x-1)^2} \Big|_{f(x)} = \frac{-1}{\left[\left(1 + \frac{1}{x}\right) - 1\right]^2} = -x^2;$
 $f'(x) = -\frac{1}{x^2} \Rightarrow \frac{df^{-1}}{dx} \Big|_{f(x)} = \frac{1}{f'(x)}$

103. $y = x \ln 2x - x \Rightarrow y' = x \left(\frac{2}{2x}\right) + \ln(2x) - 1 = \ln 2x;$
 solving $y' = 0 \Rightarrow x = \frac{1}{2}; y' > 0$ for $x > \frac{1}{2}$ and $y' < 0$ for $x < \frac{1}{2} \Rightarrow$ relative minimum of $-\frac{1}{2}$ at $x = \frac{1}{2}; f\left(\frac{1}{2e}\right) = -\frac{1}{e}$
 and $f\left(\frac{e}{2}\right) = 0 \Rightarrow$ absolute minimum is $-\frac{1}{2}$ at $x = \frac{1}{2}$ and the absolute maximum is 0 at $x = \frac{e}{2}$

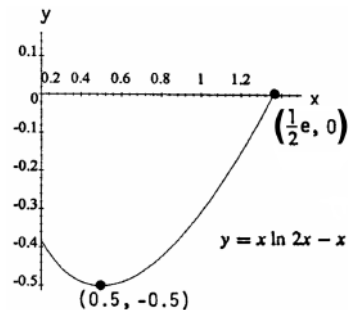

104. $y = 10x(2 - \ln x) \Rightarrow y' = 10(2 - \ln x) - 10x \left(\frac{1}{x}\right)$
 $= 20 - 10 \ln x - 10 = 10(1 - \ln x)$; solving $y' = 0$
 $\Rightarrow x = e$; $y' < 0$ for $x > e$ and $y' > 0$ for $x < e$
 \Rightarrow relative maximum at $x = e$ of $10e$; $y \geq 0$ on $(0, e^2]$ and
 $y(e^2) = 10e^2(2 - 2 \ln e) = 0 \Rightarrow$ absolute minimum is 0
 at $x = e^2$ and the absolute maximum is $10e$ at $x = e$

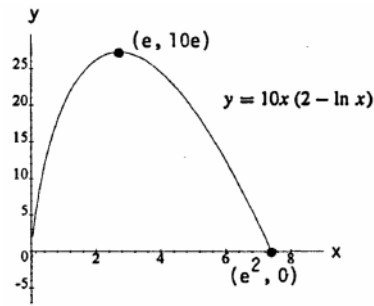

105. $A = \int_1^e \frac{2 \ln x}{x} dx = \int_0^1 2u du = [u^2]_0^1 = 1$, where
 $u = \ln x$ and $du = \frac{1}{x} dx$; $x = 1 \Rightarrow u = 0$, $x = e \Rightarrow u = 1$

106. (a) $A_1 = \int_{10}^{20} \frac{1}{x} dx = [\ln |x|]_{10}^{20} = \ln 20 - \ln 10 = \ln \frac{20}{10} = \ln 2$, and $A_2 = \int_1^2 \frac{1}{x} dx = [\ln |x|]_1^2 = \ln 2 - \ln 1 = \ln 2$
 (b) $A_1 = \int_{ka}^{kb} \frac{1}{x} dx = [\ln |x|]_{ka}^{kb} = \ln kb - \ln ka = \ln \frac{kb}{ka} = \ln \frac{b}{a} = \ln b - \ln a$, and $A_2 = \int_a^b \frac{1}{x} dx = [\ln |x|]_a^b = \ln b - \ln a$

107. $y = \ln x \Rightarrow \frac{dy}{dx} = \frac{1}{x}$; $\frac{dy}{dt} = \frac{dy}{dx} \frac{dx}{dt} \Rightarrow \frac{dy}{dt} = \left(\frac{1}{x}\right) \sqrt{x} = \frac{1}{\sqrt{x}} \Rightarrow \left. \frac{dy}{dt} \right|_{e^2} = \frac{1}{e}$ m/sec

108. $y = 9e^{-x/3} \Rightarrow \frac{dy}{dx} = -3e^{-x/3}$; $\frac{dx}{dt} = \frac{(dy/dt)}{(dy/dx)} \Rightarrow \frac{dx}{dt} = \frac{(-\frac{1}{4})\sqrt{9-y}}{-3e^{-x/3}}$; $x = 9 \Rightarrow y = 9e^{-3}$
 $\Rightarrow \left. \frac{dx}{dt} \right|_{x=9} = \frac{(-\frac{1}{4})\sqrt{9-\frac{9}{e^3}}}{(-\frac{3}{e^3})} = \frac{1}{4} \sqrt{e^3} \sqrt{e^3 - 1} \approx 5$ ft/sec

109. $A = xy = xe^{-x^2} \Rightarrow \frac{dA}{dx} = e^{-x^2} + (x)(-2x)e^{-x^2} = e^{-x^2}(1 - 2x^2)$. Solving $\frac{dA}{dx} = 0 \Rightarrow 1 - 2x^2 = 0$
 $\Rightarrow x = \frac{1}{\sqrt{2}}$; $\frac{dA}{dx} < 0$ for $x > \frac{1}{\sqrt{2}}$ and $\frac{dA}{dx} > 0$ for $0 < x < \frac{1}{\sqrt{2}}$ \Rightarrow absolute maximum of $\frac{1}{\sqrt{2}} e^{-1/2} = \frac{1}{\sqrt{2e}}$
 $x = \frac{1}{\sqrt{2}}$ units long by $y = e^{-1/2} = \frac{1}{\sqrt{e}}$ units high.

110. $A = xy = x \left(\frac{\ln x}{x^2}\right) = \frac{\ln x}{x} \Rightarrow \frac{dA}{dx} = \frac{1}{x^2} - \frac{\ln x}{x^2} = \frac{1 - \ln x}{x^2}$. Solving $\frac{dA}{dx} = 0 \Rightarrow 1 - \ln x = 0 \Rightarrow x = e$;
 $\frac{dA}{dx} < 0$ for $x > e$ and $\frac{dA}{dx} > 0$ for $x < e \Rightarrow$ absolute maximum of $\frac{\ln e}{e} = \frac{1}{e}$ at $x = e$ units long and $y = \frac{1}{e^2}$ units high.

111. $K = \ln(5x) - \ln(3x) = \ln 5 + \ln x - \ln 3 - \ln x = \ln 5 - \ln 3 = \ln \frac{5}{3}$

112. (a) No, there are two intersections: one at $x = 2$
 and the other at $x = 4$

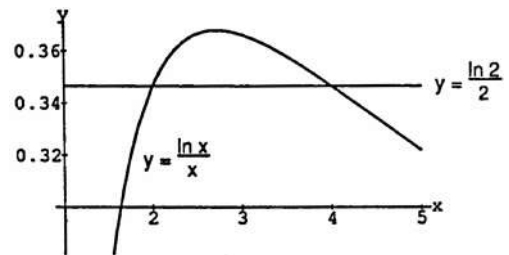

(b) Yes, because there is only one intersection

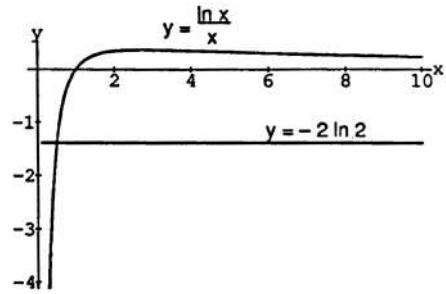

$$113. \frac{\log_4 x}{\log_2 x} = \frac{\left(\frac{\ln x}{\ln 4}\right)}{\left(\frac{\ln x}{\ln 2}\right)} = \frac{\ln x}{\ln 4} \cdot \frac{\ln 2}{\ln x} = \frac{\ln 2}{\ln 4} = \frac{\ln 2}{2 \ln 2} = \frac{1}{2}$$

114. (a) $f(x) = \frac{\ln 2}{\ln x}$, $g(x) = \frac{\ln x}{\ln 2}$
 (b) f is negative when g is negative, positive when g is positive, and undefined when $g = 0$; the values of f decrease as those of g increase

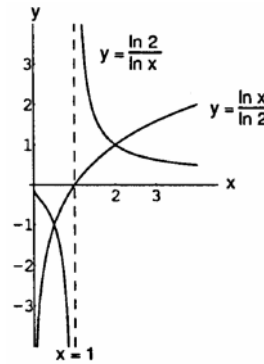

115. (a) $y = \frac{\ln x}{\sqrt{x}} \Rightarrow y' = \frac{1}{x\sqrt{x}} - \frac{\ln x}{2x^{3/2}} = \frac{2 - \ln x}{2x\sqrt{x}}$
 $\Rightarrow y'' = -\frac{3}{4}x^{-5/2}(2 - \ln x) - \frac{1}{2}x^{-5/2} = x^{-5/2}(\frac{3}{4}\ln x - 2)$;
 solving $y' = 0 \Rightarrow \ln x = 2 \Rightarrow x = e^2$; $y' < 0$ for $x > e^2$ and
 and $y' > 0$ for $x < e^2 \Rightarrow$ a maximum of $\frac{2}{e}$; $y'' = 0$
 $\Rightarrow \ln x = \frac{8}{3} \Rightarrow x = e^{8/3}$; the curve is concave down on
 $(0, e^{8/3})$ and concave up on $(e^{8/3}, \infty)$; so there is an
 inflection point at $(e^{8/3}, \frac{8}{3e^{1/3}})$.

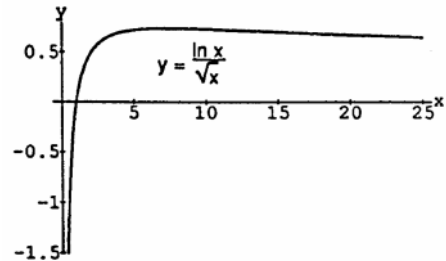

- (b) $y = e^{-x^2} \Rightarrow y' = -2xe^{-x^2} \Rightarrow y'' = -2e^{-x^2} + 4x^2e^{-x^2}$
 $= (4x^2 - 2)e^{-x^2}$; solving $y' = 0 \Rightarrow x = 0$; $y' < 0$ for
 $x > 0$ and $y' > 0$ for $x < 0 \Rightarrow$ a maximum at $x = 0$ of
 $e^0 = 1$; there are points of inflection at $x = \pm \frac{1}{\sqrt{2}}$; the
 curve is concave down for $-\frac{1}{\sqrt{2}} < x < \frac{1}{\sqrt{2}}$ and concave
 up otherwise.

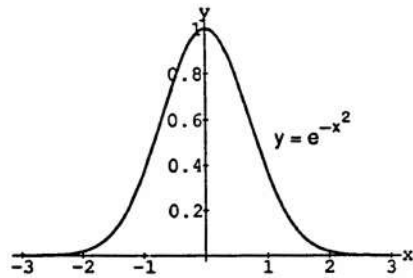

- (c) $y = (1 + x)e^{-x} \Rightarrow y' = e^{-x} - (1 + x)e^{-x} = -xe^{-x}$
 $\Rightarrow y'' = -e^{-x} + xe^{-x} = (x - 1)e^{-x}$; solving $y' = 0$
 $\Rightarrow -xe^{-x} = 0 \Rightarrow x = 0$; $y' < 0$ for $x > 0$ and $y' > 0$
 for $x < 0 \Rightarrow$ a maximum at $x = 0$ of $(1 + 0)e^0 = 1$;
 there is a point of inflection at $x = 1$ and the curve is
 concave up for $x > 1$ and concave down for $x < 1$.

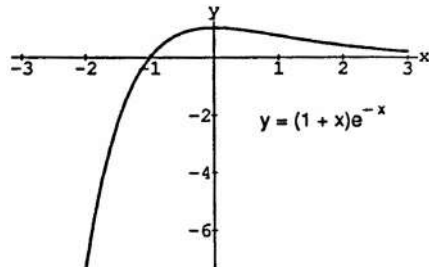

116. $y = x \ln x \Rightarrow y' = \ln x + x \left(\frac{1}{x}\right) = \ln x + 1$; solving $y' = 0$
 $\Rightarrow \ln x + 1 = 0 \Rightarrow \ln x = -1 \Rightarrow x = e^{-1}$; $y' > 0$ for
 $x > e^{-1}$ and $y' < 0$ for $x < e^{-1} \Rightarrow$ a minimum of $e^{-1} \ln e^{-1}$
 $= -\frac{1}{e}$ at $x = e^{-1}$. This minimum is an absolute minimum
 since $y'' = \frac{1}{x}$ is positive for all $x > 0$.

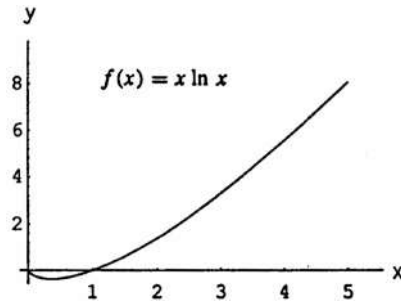

117. Since the half life is 5700 years and $A(t) = A_0 e^{kt}$ we have $\frac{A_0}{2} = A_0 e^{5700k} \Rightarrow \frac{1}{2} = e^{5700k} \Rightarrow \ln(0.5) = 5700k$
 $\Rightarrow k = \frac{\ln(0.5)}{5700}$. With 10% of the original carbon-14 remaining we have $0.1A_0 = A_0 e^{\frac{\ln(0.5)}{5700} t} \Rightarrow 0.1 = e^{\frac{\ln(0.5)}{5700} t}$
 $\Rightarrow \ln(0.1) = \frac{\ln(0.5)}{5700} t \Rightarrow t = \frac{(5700) \ln(0.1)}{\ln(0.5)} \approx 18,935$ years (rounded to the nearest year).
118. $T - T_s = (T_o - T_s) e^{-kt} \Rightarrow 180 - 40 = (220 - 40) e^{-k/4}$, time in hours, $\Rightarrow k = -4 \ln\left(\frac{7}{9}\right) = 4 \ln\left(\frac{9}{7}\right) \Rightarrow 70 - 40$
 $= (220 - 40) e^{-4 \ln(9/7) t} \Rightarrow t = \frac{\ln 6}{4 \ln(9/7)} \approx 1.78$ hr ≈ 107 min, the total time \Rightarrow the time it took to cool from
 180° F to 70° F was $107 - 15 = 92$ min
119. $\theta = \pi - \cot^{-1}\left(\frac{x}{60}\right) - \cot^{-1}\left(\frac{5}{3} - \frac{x}{30}\right)$, $0 < x < 50 \Rightarrow \frac{d\theta}{dx} = \frac{\left(\frac{1}{60}\right)}{1 + \left(\frac{x}{60}\right)^2} + \frac{\left(-\frac{1}{30}\right)}{1 + \left(\frac{50-x}{30}\right)^2}$
 $= 30 \left[\frac{2}{60^2 + x^2} - \frac{1}{30^2 + (50-x)^2} \right]$; solving $\frac{d\theta}{dx} = 0 \Rightarrow x^2 - 200x + 3200 = 0 \Rightarrow x = 100 \pm 20\sqrt{17}$, but
 $100 + 20\sqrt{17}$ is not in the domain; $\frac{d\theta}{dx} > 0$ for $x < 20(5 - \sqrt{17})$ and $\frac{d\theta}{dx} < 0$ for $20(5 - \sqrt{17}) < x < 50$
 $\Rightarrow x = 20(5 - \sqrt{17}) \approx 17.54$ m maximizes θ
120. $v = x^2 \ln\left(\frac{1}{x}\right) = x^2(\ln 1 - \ln x) = -x^2 \ln x \Rightarrow \frac{dv}{dx} = -2x \ln x - x^2\left(\frac{1}{x}\right) = -x(2 \ln x + 1)$; solving $\frac{dv}{dx} = 0$
 $\Rightarrow 2 \ln x + 1 = 0 \Rightarrow \ln x = -\frac{1}{2} \Rightarrow x = e^{-1/2}$; $\frac{dv}{dx} < 0$ for $x > e^{-1/2}$ and $\frac{dv}{dx} > 0$ for $x < e^{-1/2} \Rightarrow$ a relative
 maximum at $x = e^{-1/2}$; $\frac{r}{h} = x$ and $r = 1 \Rightarrow h = e^{1/2} = \sqrt{e} \approx 1.65$ cm

CHAPTER 7 ADDITIONAL AND ADVANCED EXERCISES

- $\lim_{b \rightarrow 1^-} \int_0^b \frac{1}{\sqrt{1-x^2}} dx = \lim_{b \rightarrow 1^-} [\sin^{-1} x]_0^b = \lim_{b \rightarrow 1^-} (\sin^{-1} b - \sin^{-1} 0) = \lim_{b \rightarrow 1^-} (\sin^{-1} b - 0) = \lim_{b \rightarrow 1^-} \sin^{-1} b = \frac{\pi}{2}$
- $\lim_{x \rightarrow \infty} \frac{1}{x} \int_0^x \tan^{-1} t dt = \lim_{x \rightarrow \infty} \frac{\int_0^x \tan^{-1} t dt}{x}$ ($\frac{\infty}{\infty}$ form)
 $= \lim_{x \rightarrow \infty} \frac{\tan^{-1} x}{1} = \frac{\pi}{2}$
- $y = (\cos \sqrt{x})^{1/x} \Rightarrow \ln y = \frac{1}{x} \ln(\cos \sqrt{x})$ and $\lim_{x \rightarrow 0^+} \frac{\ln(\cos \sqrt{x})}{x} = \lim_{x \rightarrow 0^+} \frac{-\sin \sqrt{x}}{2\sqrt{x} \cos \sqrt{x}} = \frac{-1}{2} \lim_{x \rightarrow 0^+} \frac{\tan \sqrt{x}}{\sqrt{x}}$
 $= -\frac{1}{2} \lim_{x \rightarrow 0^+} \frac{\frac{1}{2} x^{-1/2} \sec^2 \sqrt{x}}{\frac{1}{2} x^{-1/2}} = -\frac{1}{2} \Rightarrow \lim_{x \rightarrow 0^+} (\cos \sqrt{x})^{1/x} = e^{-1/2} = \frac{1}{\sqrt{e}}$
- $y = (x + e^x)^{2/x} \Rightarrow \ln y = \frac{2 \ln(x + e^x)}{x} \Rightarrow \lim_{x \rightarrow \infty} \ln y = \lim_{x \rightarrow \infty} \frac{2(1 + e^x)}{x + e^x} = \lim_{x \rightarrow \infty} \frac{2e^x}{1 + e^x} = \lim_{x \rightarrow \infty} \frac{2e^x}{e^x} = 2$
 $\Rightarrow \lim_{x \rightarrow \infty} (x + e^x)^{2/x} = \lim_{x \rightarrow \infty} e^y = e^2$
- $\lim_{x \rightarrow \infty} \left(\frac{1}{n+1} + \frac{1}{n+2} + \dots + \frac{1}{2n} \right) = \lim_{x \rightarrow \infty} \left(\binom{1}{n} \left[\frac{1}{1 + \left(\frac{1}{n}\right)} \right] + \binom{1}{n} \left[\frac{1}{1 + 2\left(\frac{1}{n}\right)} \right] + \dots + \binom{1}{n} \left[\frac{1}{1 + n\left(\frac{1}{n}\right)} \right] \right)$

which can be interpreted as a Riemann sum with partitioning $\Delta x = \frac{1}{n} \Rightarrow \lim_{x \rightarrow \infty} \left(\frac{1}{n+1} + \frac{1}{n+2} + \dots + \frac{1}{2n} \right)$
 $= \int_0^1 \frac{1}{1+x} dx = [\ln(1+x)]_0^1 = \ln 2$

6. $\lim_{x \rightarrow \infty} \frac{1}{n} [e^{1/n} + e^{2/n} + \dots + e] = \lim_{x \rightarrow \infty} \left[\left(\frac{1}{n}\right) e^{(1/n)} + \left(\frac{1}{n}\right) e^{2(1/n)} + \dots + \left(\frac{1}{n}\right) e^{n(1/n)} \right]$ which can be interpreted as a Riemann sum with partitioning $\Delta x = \frac{1}{n} \Rightarrow \lim_{x \rightarrow \infty} \frac{1}{n} [e^{1/n} + e^{2/n} + \dots + e] = \int_0^1 e^x dx = [e^x]_0^1 = e - 1$

7. $A(t) = \int_0^t e^{-x} dx = [-e^{-x}]_0^t = 1 - e^{-t}$, $V(t) = \pi \int_0^t e^{-2x} dx = [-\frac{\pi}{2} e^{-2x}]_0^t = \frac{\pi}{2} (1 - e^{-2t})$

(a) $\lim_{t \rightarrow \infty} A(t) = \lim_{t \rightarrow \infty} (1 - e^{-t}) = 1$

(b) $\lim_{t \rightarrow \infty} \frac{V(t)}{A(t)} = \lim_{t \rightarrow \infty} \frac{\frac{\pi}{2}(1 - e^{-2t})}{1 - e^{-t}} = \frac{\pi}{2}$

(c) $\lim_{t \rightarrow 0^+} \frac{V(t)}{A(t)} = \lim_{t \rightarrow 0^+} \frac{\frac{\pi}{2}(1 - e^{-2t})}{1 - e^{-t}} = \lim_{t \rightarrow 0^+} \frac{\frac{\pi}{2}(1 - e^{-t})(1 + e^{-t})}{(1 - e^{-t})} = \lim_{t \rightarrow 0^+} \frac{\pi}{2} (1 + e^{-t}) = \pi$

8. (a) $\lim_{a \rightarrow 0^+} \log_a 2 = \lim_{a \rightarrow 0^+} \frac{\ln 2}{\ln a} = 0$;
 $\lim_{a \rightarrow 1^-} \log_a 2 = \lim_{a \rightarrow 1^-} \frac{\ln 2}{\ln a} = -\infty$;
 $\lim_{a \rightarrow 1^+} \log_a 2 = \lim_{a \rightarrow 1^+} \frac{\ln 2}{\ln a} = \infty$;
 $\lim_{a \rightarrow \infty} \log_a 2 = \lim_{a \rightarrow \infty} \frac{\ln 2}{\ln a} = 0$

(b)

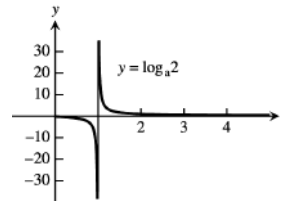

9. $A_1 = \int_1^e \frac{2 \log_2 x}{x} dx = \frac{2}{\ln 2} \int_1^e \frac{\ln x}{x} dx = \left[\frac{(\ln x)^2}{\ln 2} \right]_1^e = \frac{1}{\ln 2}$; $A_2 = \int_1^e \frac{2 \log_4 x}{4} dx = \frac{2}{\ln 4} \int_1^e \frac{\ln x}{x} dx$
 $= \left[\frac{(\ln x)^2}{2 \ln 2} \right]_1^e = \frac{1}{2 \ln 2} \Rightarrow A_1 : A_2 = 2 : 1$

10. $y = \tan^{-1} x + \tan^{-1} \left(\frac{1}{x}\right) \Rightarrow y' = \frac{1}{1+x^2} + \frac{\left(-\frac{1}{x^2}\right)}{\left(1+\frac{1}{x^2}\right)}$
 $= \frac{1}{1+x^2} - \frac{1}{1+x^2} = 0 \Rightarrow \tan^{-1} x + \tan^{-1} \left(\frac{1}{x}\right)$ is a constant
 and the constant is $\frac{\pi}{2}$ for $x > 0$; it is $-\frac{\pi}{2}$ for $x < 0$ since $\tan^{-1} x + \tan^{-1} \left(\frac{1}{x}\right)$ is odd. Next the

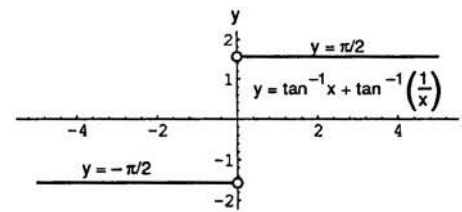

$\lim_{x \rightarrow 0^+} \left[\tan^{-1} x + \tan^{-1} \left(\frac{1}{x}\right) \right] = 0 + \frac{\pi}{2} = \frac{\pi}{2}$ and $\lim_{x \rightarrow 0^-} \left(\tan^{-1} x + \tan^{-1} \left(\frac{1}{x}\right) \right) = 0 + \left(-\frac{\pi}{2}\right) = -\frac{\pi}{2}$

11. $\ln x^{(x^x)} = x^x \ln x$ and $\ln (x^x)^x = x \ln x^x = x^2 \ln x$; then, $x^x \ln x = x^2 \ln x \Rightarrow (x^x - x^2) \ln x = 0 \Rightarrow x^x = x^2$ or $\ln x = 0$.
 $\ln x = 0 \Rightarrow x = 1$; $x^x = x^2 \Rightarrow x \ln x = 2 \ln x \Rightarrow x = 2$. Therefore, $x^{(x^x)} = (x^x)^x$ when $x = 2$ or $x = 1$.

12. In the interval $\pi < x < 2\pi$ the function $\sin x < 0$
 $\Rightarrow (\sin x)^{\sin x}$ is not defined for all values in that interval or its translation by 2π .

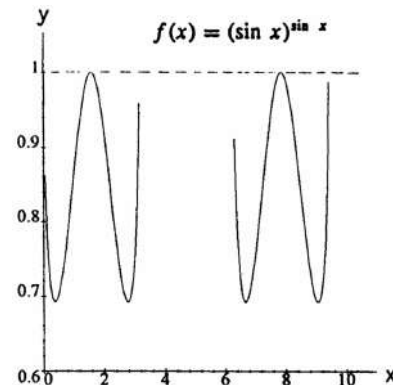

13. $f(x) = e^{g(x)} \Rightarrow f'(x) = e^{g(x)} g'(x)$, where $g'(x) = \frac{x}{1+x^4} \Rightarrow f'(2) = e^0 \left(\frac{2}{1+16} \right) = \frac{2}{17}$

14. (a) $\frac{df}{dx} = \frac{2 \ln e^x}{e^x} \cdot e^x = 2x$
 (b) $f(0) = \int_1^1 \frac{2 \ln t}{t} dt = 0$
 (c) $\frac{df}{dx} = 2x \Rightarrow f(x) = x^2 + C; f(0) = 0 \Rightarrow C = 0 \Rightarrow f(x) = x^2 \Rightarrow$ the graph of $f(x)$ is a parabola
15. Triangle ABD is an isosceles right triangle with its right angle at B and an angle of measure $\frac{\pi}{4}$ at A. We therefore have $\frac{\pi}{4} = \angle DAB = \angle DAE + \angle CAB = \tan^{-1} \frac{1}{3} + \tan^{-1} \frac{1}{2}$.
16. (a) The figure shows that $\frac{\ln e}{e} > \frac{\ln \pi}{\pi} \Rightarrow \pi \ln e > e \ln \pi \Rightarrow \ln e^\pi > \ln \pi^e \Rightarrow e^\pi > \pi^e$
 (b) $y = \frac{\ln x}{x} \Rightarrow y' = \left(\frac{1}{x}\right) \left(\frac{1}{x}\right) - \frac{\ln x}{x^2} \Rightarrow \frac{1 - \ln x}{x^2}$; solving $y' = 0 \Rightarrow \ln x = 1 \Rightarrow x = e$; $y' < 0$ for $x > e$ and $y' > 0$ for $0 < x < e \Rightarrow$ an absolute maximum occurs at $x = e$
17. The area of the shaded region is $\int_0^1 \sin^{-1} x dx = \int_0^1 \sin^{-1} y dy$, which is the same as the area of the region to the left of the curve $y = \sin x$ (and part of the rectangle formed by the coordinate axes and dashed lines $y = 1$, $x = \frac{\pi}{2}$). The area of the rectangle is $\frac{\pi}{2} = \int_0^1 \sin^{-1} y dy + \int_0^{\pi/2} \sin x dx$, so we have
 $\frac{\pi}{2} = \int_0^1 \sin^{-1} x dx + \int_0^{\pi/2} \sin x dx \Rightarrow \int_0^{\pi/2} \sin x dx = \frac{\pi}{2} - \int_0^1 \sin^{-1} x dx$.
18. (a) slope of $L_3 < \text{slope of } L_2 < \text{slope of } L_1 \Rightarrow \frac{1}{b} < \frac{\ln b - \ln a}{b-a} < \frac{1}{a}$
 (b) area of small (shaded) rectangle $<$ area under curve $<$ area of large rectangle
 $\Rightarrow \frac{1}{b}(b-a) < \int_a^b \frac{1}{x} dx < \frac{1}{a}(b-a) \Rightarrow \frac{1}{b} < \frac{\ln b - \ln a}{b-a} < \frac{1}{a}$
19. (a) $g(x) + h(x) = 0 \Rightarrow g(x) = -h(x)$; also $g(x) + h(x) = 0 \Rightarrow g(-x) + h(-x) = 0 \Rightarrow g(x) - h(x) = 0 \Rightarrow g(x) = h(x)$; therefore $-h(x) = h(x) \Rightarrow h(x) = 0 \Rightarrow g(x) = 0$
 (b) $\frac{f(x) + f(-x)}{2} = \frac{[f_E(x) + f_O(x)] + [f_E(-x) + f_O(-x)]}{2} = \frac{f_E(x) + f_O(x) + f_E(x) - f_O(x)}{2} = f_E(x)$;
 $\frac{f(x) - f(-x)}{2} = \frac{[f_E(x) + f_O(x)] - [f_E(-x) + f_O(-x)]}{2} = \frac{f_E(x) + f_O(x) - f_E(x) + f_O(x)}{2} = f_O(x)$
 (c) Part b \Rightarrow such a decomposition is unique.
20. (a) $g(0+0) = \frac{g(0)+g(0)}{1-g(0)g(0)} \Rightarrow [1-g^2(0)]g(0) = 2g(0) \Rightarrow g(0) - g^3(0) = 2g(0) \Rightarrow g^3(0) + g(0) = 0 \Rightarrow g(0)[g^2(0) + 1] = 0 \Rightarrow g(0) = 0$
 (b) $g'(x) = \lim_{h \rightarrow 0} \frac{g(x+h) - g(x)}{h} = \lim_{h \rightarrow 0} \frac{\frac{g(x)+g(h)}{1-g(x)g(h)} - g(x)}{h} = \lim_{h \rightarrow 0} \frac{g(x)+g(h) - g(x) + g^2(x)g(h)}{h[1-g(x)g(h)]}$
 $= \lim_{h \rightarrow 0} \left[\frac{g(h)}{h} \right] \left[\frac{1+g^2(x)}{1-g(x)g(h)} \right] = 1 \cdot [1+g^2(x)] = 1+g^2(x) = 1+[g(x)]^2$
 (c) $\frac{dy}{dx} = 1 + y^2 \Rightarrow \frac{dy}{1+y^2} = dx \Rightarrow \tan^{-1} y = x + C \Rightarrow \tan^{-1}(g(x)) = x + C; g(0) = 0 \Rightarrow \tan^{-1} 0 = 0 + C \Rightarrow C = 0 \Rightarrow \tan^{-1}(g(x)) = x \Rightarrow g(x) = \tan x$
21. $M = \int_0^1 \frac{2}{1+x^2} dx = 2[\tan^{-1} x]_0^1 = \frac{\pi}{2}$ and $M_y = \int_0^1 \frac{2x}{1+x^2} dx = [\ln(1+x^2)]_0^1 = \ln 2 \Rightarrow \bar{x} = \frac{M_y}{M} = \frac{\ln 2}{\frac{\pi}{2}} = \frac{\ln 4}{\pi}$; $\bar{y} = 0$ by symmetry
22. (a) $V = \pi \int_{1/4}^4 \left(\frac{1}{2\sqrt{x}}\right)^2 dx = \frac{\pi}{4} \int_{1/4}^4 \frac{1}{x} dx = \frac{\pi}{4} [\ln |x|]_{1/4}^4 = \frac{\pi}{4} (\ln 4 - \ln \frac{1}{4}) = \frac{\pi}{4} \ln 16 = \frac{\pi}{4} \ln (2^4) = \pi \ln 2$
 (b) $M_y = \int_{1/4}^4 x \left(\frac{1}{2\sqrt{x}}\right) dx = \frac{1}{2} \int_{1/4}^4 x^{1/2} dx = \left[\frac{2}{3} x^{3/2}\right]_{1/4}^4 = \left(\frac{8}{3} - \frac{1}{4}\right) = \frac{64-1}{24} = \frac{63}{24}$;
 $M_x = \int_{1/4}^4 \frac{1}{2} \left(\frac{1}{2\sqrt{x}}\right) \left(\frac{1}{2\sqrt{x}}\right) dx = \frac{1}{8} \int_{1/4}^4 \frac{1}{x} dx = \left[\frac{1}{8} \ln |x|\right]_{1/4}^4 = \frac{1}{8} \ln 16 = \frac{1}{2} \ln 2$;

$$M = \int_{1/4}^4 \frac{1}{2\sqrt{x}} dx = \int_{1/4}^4 \frac{1}{2} x^{-1/2} dx = [x^{1/2}]_{1/4}^4 = 2 - \frac{1}{2} = \frac{3}{2}; \text{ therefore, } \bar{x} = \frac{M_y}{M} = \left(\frac{63}{24}\right) \left(\frac{2}{3}\right) = \frac{21}{12} = \frac{7}{4} \text{ and}$$

$$\bar{y} = \frac{M_x}{M} = \left(\frac{1}{2} \ln 2\right) \left(\frac{2}{3}\right) = \frac{\ln 2}{3}$$

23. $A(t) = A_0 e^{rt}$; $A(t) = 2A_0 \Rightarrow 2A_0 = A_0 e^{rt} \Rightarrow e^{rt} = 2 \Rightarrow rt = \ln 2 \Rightarrow t = \frac{\ln 2}{r} \Rightarrow t \approx \frac{.7}{r} = \frac{70}{100r} = \frac{70}{(r\%)}$

24. $\frac{ds}{dt} = ks \Rightarrow \frac{ds}{s} = k dt \Rightarrow \ln s = kt + C \Rightarrow s = s_0 e^{kt}$
 \Rightarrow the 14th century model of free fall was exponential;
 note that the motion starts too slowly at first and then becomes too fast after about 7 seconds

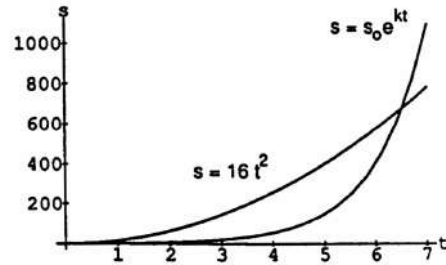

25. (a) $L = k \left(\frac{a - b \cot \theta}{R^4} + \frac{b \csc \theta}{r^4} \right) \Rightarrow \frac{dL}{d\theta} = k \left(\frac{b \csc^2 \theta}{R^4} - \frac{b \csc \theta \cot \theta}{r^4} \right)$; solving $\frac{dL}{d\theta} = 0$
 $\Rightarrow r^4 b \csc^2 \theta - b R^4 \csc \theta \cot \theta = 0 \Rightarrow (b \csc \theta) (r^4 \csc \theta - R^4 \cot \theta) = 0$; but $b \csc \theta \neq 0$ since $\theta \neq \frac{\pi}{2} \Rightarrow r^4 \csc \theta - R^4 \cot \theta = 0 \Rightarrow \cos \theta = \frac{r^4}{R^4} \Rightarrow \theta = \cos^{-1} \left(\frac{r^4}{R^4} \right)$, the critical value of θ
 (b) $\theta = \cos^{-1} \left(\frac{5}{6} \right)^4 \approx \cos^{-1} (0.48225) \approx 61^\circ$

26. Two views of the graph of $y = 1000 \left[1 - (.99)^x + \frac{1}{x} \right]$ are shown below.

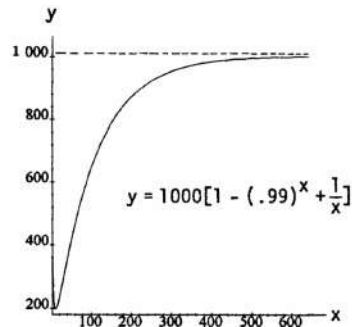
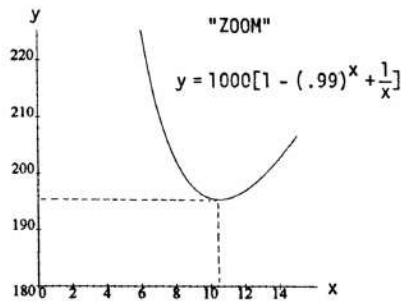

- (a) At about $x = 11$ there is a minimum
- (b) There is no maximum; however, the curve is asymptotic to $y = 1000$. The curve is near 1000 when $x \geq 643$.

NOTES:

CHAPTER 8 TECHNIQUES OF INTEGRATION

8.1 BASIC INTEGRATION FORMULAS

- $$\int \frac{16x \, dx}{\sqrt{8x^2+1}}; \left[\begin{array}{l} u = 8x^2 + 1 \\ du = 16x \, dx \end{array} \right] \rightarrow \int \frac{du}{\sqrt{u}} = 2\sqrt{u} + C = 2\sqrt{8x^2+1} + C$$
- $$\int \frac{3 \cos x \, dx}{\sqrt{1+3 \sin x}}; \left[\begin{array}{l} u = 1 + 3 \sin x \\ du = 3 \cos x \, dx \end{array} \right] \rightarrow \int \frac{du}{\sqrt{u}} = 2\sqrt{u} + C = 2\sqrt{1+3 \sin x} + C$$
- $$\int 3\sqrt{\sin v} \cos v \, dv; \left[\begin{array}{l} u = \sin v \\ du = \cos v \, dv \end{array} \right] \rightarrow \int 3\sqrt{u} \, du = 3 \cdot \frac{2}{3} u^{3/2} + C = 2(\sin v)^{3/2} + C$$
- $$\int \cot^3 y \csc^2 y \, dy; \left[\begin{array}{l} u = \cot y \\ du = -\csc^2 y \, dy \end{array} \right] \rightarrow \int u^3(-du) = -\frac{u^4}{4} + C = \frac{-\cot^4 y}{4} + C$$
- $$\int_0^1 \frac{16x \, dx}{8x^2+2}; \left[\begin{array}{l} u = 8x^2 + 2 \\ du = 16x \, dx \\ x = 0 \Rightarrow u = 2, \quad x = 1 \Rightarrow u = 10 \end{array} \right] \rightarrow \int_2^{10} \frac{du}{u} = [\ln |u|]_2^{10} = \ln 10 - \ln 2 = \ln 5$$
- $$\int_{\pi/4}^{\pi/3} \frac{\sec^2 z \, dz}{\tan z}; \left[\begin{array}{l} u = \tan z \\ du = \sec^2 z \, dz \\ z = \frac{\pi}{4} \Rightarrow u = 1, \quad z = \frac{\pi}{3} \Rightarrow u = \sqrt{3} \end{array} \right] \rightarrow \int_1^{\sqrt{3}} \frac{1}{u} \, du = [\ln |u|]_1^{\sqrt{3}} = \ln \sqrt{3} - \ln 1 = \ln \sqrt{3}$$
- $$\int \frac{dx}{\sqrt{x}(\sqrt{x}+1)}; \left[\begin{array}{l} u = \sqrt{x} + 1 \\ du = \frac{1}{2\sqrt{x}} \, dx \\ 2 \, du = \frac{dx}{\sqrt{x}} \end{array} \right] \rightarrow \int \frac{2 \, du}{u} = 2 \ln |u| + C = 2 \ln(\sqrt{x} + 1) + C$$
- $$\int \frac{dx}{x-\sqrt{x}} = \int \frac{dx}{\sqrt{x}(\sqrt{x}-1)}; \left[\begin{array}{l} u = \sqrt{x} - 1 \\ du = \frac{1}{2\sqrt{x}} \, dx \\ 2 \, du = \frac{dx}{\sqrt{x}} \end{array} \right] \rightarrow \int \frac{2 \, du}{u} = 2 \ln |u| + C = 2 \ln |\sqrt{x} - 1| + C$$
- $$\int \cot(3-7x) \, dx; \left[\begin{array}{l} u = 3-7x \\ du = -7 \, dx \end{array} \right] \rightarrow -\frac{1}{7} \int \cot u \, du = -\frac{1}{7} \ln |\sin u| + C = -\frac{1}{7} \ln |\sin(3-7x)| + C$$
- $$\int \csc(\pi x - 1) \, dx; \left[\begin{array}{l} u = \pi x - 1 \\ du = \pi \, dx \end{array} \right] \rightarrow \int \csc u \cdot \frac{du}{\pi} = \frac{-1}{\pi} \ln |\csc u + \cot u| + C \\ = -\frac{1}{\pi} \ln |\csc(\pi x - 1) + \cot(\pi x - 1)| + C$$
- $$\int e^\theta \csc(e^\theta + 1) \, d\theta; \left[\begin{array}{l} u = e^\theta + 1 \\ du = e^\theta \, d\theta \end{array} \right] \rightarrow \int \csc u \, du = -\ln |\csc u + \cot u| + C = -\ln |\csc(e^\theta + 1) + \cot(e^\theta + 1)| + C$$
- $$\int \frac{\cot(3 + \ln x)}{x} \, dx; \left[\begin{array}{l} u = 3 + \ln x \\ du = \frac{dx}{x} \end{array} \right] \rightarrow \int \cot u \, du = \ln |\sin u| + C = \ln |\sin(3 + \ln x)| + C$$

$$13. \int \sec \frac{t}{3} dt; \left[\begin{array}{l} u = \frac{t}{3} \\ du = \frac{dt}{3} \end{array} \right] \rightarrow \int 3 \sec u du = 3 \ln |\sec u + \tan u| + C = 3 \ln \left| \sec \frac{t}{3} + \tan \frac{t}{3} \right| + C$$

$$14. \int x \sec(x^2 - 5) dx; \left[\begin{array}{l} u = x^2 - 5 \\ du = 2x dx \end{array} \right] \rightarrow \int \frac{1}{2} \sec u du = \frac{1}{2} \ln |\sec u + \tan u| + C \\ = \frac{1}{2} \ln |\sec(x^2 - 5) + \tan(x^2 - 5)| + C$$

$$15. \int \csc(s - \pi) ds; \left[\begin{array}{l} u = s - \pi \\ du = ds \end{array} \right] \rightarrow \int \csc u du = -\ln |\csc u + \cot u| + C = -\ln |\csc(s - \pi) + \cot(s - \pi)| + C$$

$$16. \int \frac{1}{\theta^2} \csc \frac{1}{\theta} d\theta; \left[\begin{array}{l} u = \frac{1}{\theta} \\ du = -\frac{d\theta}{\theta^2} \end{array} \right] \rightarrow \int -\csc u du = \ln |\csc u + \cot u| + C = \ln \left| \csc \frac{1}{\theta} + \cot \frac{1}{\theta} \right| + C$$

$$17. \int_0^{\sqrt{\ln 2}} 2xe^{x^2} dx; \left[\begin{array}{l} u = x^2 \\ du = 2x dx \\ x = 0 \Rightarrow u = 0, x = \sqrt{\ln 2} \Rightarrow u = \ln 2 \end{array} \right] \rightarrow \int_0^{\ln 2} e^u du = [e^u]_0^{\ln 2} = e^{\ln 2} - e^0 = 2 - 1 = 1$$

$$18. \int_{\pi/2}^{\pi} \sin(y) e^{\cos y} dy; \left[\begin{array}{l} u = \cos y \\ du = -\sin y dy \\ y = \frac{\pi}{2} \Rightarrow u = 0, y = \pi \Rightarrow u = -1 \end{array} \right] \rightarrow \int_0^{-1} -e^u du = \int_{-1}^0 e^u du = [e^u]_{-1}^0 = 1 - e^{-1} = \frac{e-1}{e}$$

$$19. \int e^{\tan v} \sec^2 v dv; \left[\begin{array}{l} u = \tan v \\ du = \sec^2 v dv \end{array} \right] \rightarrow \int e^u du = e^u + C = e^{\tan v} + C$$

$$20. \int \frac{e^{\sqrt{t}} dt}{\sqrt{t}}; \left[\begin{array}{l} u = \sqrt{t} \\ du = \frac{dt}{2\sqrt{t}} \end{array} \right] \rightarrow \int 2e^u du = 2e^u + C = 2e^{\sqrt{t}} + C$$

$$21. \int 3^{x+1} dx; \left[\begin{array}{l} u = x + 1 \\ du = dx \end{array} \right] \rightarrow \int 3^u du = \left(\frac{1}{\ln 3}\right) 3^u + C = \frac{3^{x+1}}{\ln 3} + C$$

$$22. \int \frac{2^{\ln x}}{x} dx; \left[\begin{array}{l} u = \ln x \\ du = \frac{dx}{x} \end{array} \right] \rightarrow \int 2^u du = \frac{2^u}{\ln 2} + C = \frac{2^{\ln x}}{\ln 2} + C$$

$$23. \int \frac{2^{\sqrt{w}} dw}{2\sqrt{w}}; \left[\begin{array}{l} u = \sqrt{w} \\ du = \frac{dw}{2\sqrt{w}} \end{array} \right] \rightarrow \int 2^u du = \frac{2^u}{\ln 2} + C = \frac{2^{\sqrt{w}}}{\ln 2} + C$$

$$24. \int 10^{2\theta} d\theta; \left[\begin{array}{l} u = 2\theta \\ du = 2 d\theta \end{array} \right] \rightarrow \int \frac{1}{2} 10^u du = \frac{10^u}{2 \ln 10} + C = \frac{1}{2} \left(\frac{10^{2\theta}}{\ln 10} \right) + C$$

$$25. \int \frac{9 du}{1+9u^2}; \left[\begin{array}{l} x = 3u \\ dx = 3 du \end{array} \right] \rightarrow \int \frac{3 dx}{1+x^2} = 3 \tan^{-1} x + C = 3 \tan^{-1} 3u + C$$

$$26. \int \frac{4 dx}{1+(2x+1)^2}; \left[\begin{array}{l} u = 2x+1 \\ du = 2 dx \end{array} \right] \rightarrow \int \frac{2 du}{1+u^2} = 2 \tan^{-1} u + C = 2 \tan^{-1} (2x+1) + C$$

$$27. \int_0^{1/6} \frac{dx}{\sqrt{1-9x^2}}; \left[\begin{array}{l} u = 3x \\ du = 3 dx \\ x = 0 \Rightarrow u = 0, x = \frac{1}{6} \Rightarrow u = \frac{1}{2} \end{array} \right] \rightarrow \int_0^{1/2} \frac{1}{3} \frac{du}{\sqrt{1-u^2}} = \left[\frac{1}{3} \sin^{-1} u \right]_0^{1/2} = \frac{1}{3} \left(\frac{\pi}{6} - 0 \right) = \frac{\pi}{18}$$

$$28. \int_0^1 \frac{dt}{\sqrt{4-t^2}} = \left[\sin^{-1} \frac{t}{2} \right]_0^1 = \sin^{-1} \left(\frac{1}{2} \right) - 0 = \frac{\pi}{6}$$

$$29. \int \frac{2s \, ds}{\sqrt{1-s^4}}; \left[\begin{array}{l} u = s^2 \\ du = 2s \, ds \end{array} \right] \rightarrow \int \frac{du}{\sqrt{1-u^2}} = \sin^{-1} u + C = \sin^{-1} s^2 + C$$

$$30. \int \frac{2 \, dx}{x\sqrt{1-4 \ln^2 x}}; \left[\begin{array}{l} u = 2 \ln x \\ du = \frac{2 \, dx}{x} \end{array} \right] \rightarrow \int \frac{du}{\sqrt{1-u^2}} = \sin^{-1} u + C = \sin^{-1} (2 \ln x) + C$$

$$31. \int \frac{6 \, dx}{x\sqrt{25x^2-1}} = \int \frac{6 \, dx}{5x\sqrt{x^2-\frac{1}{25}}} = \frac{6}{5} \cdot 5 \sec^{-1} |5x| + C = 6 \sec^{-1} |5x| + C$$

$$32. \int \frac{dr}{r\sqrt{r^2-9}} = \frac{1}{3} \sec^{-1} \left| \frac{r}{3} \right| + C$$

$$33. \int \frac{dx}{e^x+e^{-x}} = \int \frac{e^x \, dx}{e^{2x}+1}; \left[\begin{array}{l} u = e^x \\ du = e^x \, dx \end{array} \right] \rightarrow \int \frac{du}{u^2+1} = \tan^{-1} u + C = \tan^{-1} e^x + C$$

$$34. \int \frac{dy}{\sqrt{e^{2y}-1}} = \int \frac{e^y \, dy}{e^y \sqrt{(e^y)^2-1}}; \left[\begin{array}{l} u = e^y \\ du = e^y \, dy \end{array} \right] \rightarrow \int \frac{du}{u\sqrt{u^2-1}} = \sec^{-1} |u| + C = \sec^{-1} e^y + C$$

$$35. \int_1^{e^{\pi/3}} \frac{dx}{x \cos(\ln x)}; \left[\begin{array}{l} u = \ln x \\ du = \frac{dx}{x} \\ x = 1 \Rightarrow u = 0, x = e^{\pi/3} \Rightarrow u = \frac{\pi}{3} \end{array} \right] \rightarrow \int_0^{\pi/3} \frac{du}{\cos u} = \int_0^{\pi/3} \sec u \, du = [\ln |\sec u + \tan u|]_0^{\pi/3}$$

$$= \ln \left| \sec \frac{\pi}{3} + \tan \frac{\pi}{3} \right| - \ln |\sec 0 + \tan 0| = \ln (2 + \sqrt{3}) - \ln(1) = \ln (2 + \sqrt{3})$$

$$36. \int \frac{\ln x \, dx}{x+4x \ln^2 x} = \int \frac{\ln x \, dx}{x(1+4 \ln^2 x)}; \left[\begin{array}{l} u = \ln^2 x \\ du = \frac{2}{x} \ln x \, dx \end{array} \right] \rightarrow \int \frac{1}{2} \frac{du}{1+4u} = \frac{1}{8} \ln |1+4u| + C = \frac{1}{8} \ln (1+4 \ln^2 x) + C$$

$$37. \int_1^2 \frac{8 \, dx}{x^2-2x+2} = 8 \int_1^2 \frac{dx}{1+(x-1)^2}; \left[\begin{array}{l} u = x-1 \\ du = dx \\ x = 1 \Rightarrow u = 0, x = 2 \Rightarrow u = 1 \end{array} \right] \rightarrow 8 \int_0^1 \frac{du}{1+u^2} = 8 [\tan^{-1} u]_0^1$$

$$= 8 (\tan^{-1} 1 - \tan^{-1} 0) = 8 \left(\frac{\pi}{4} - 0 \right) = 2\pi$$

$$38. \int_2^4 \frac{2 \, dx}{x^2-6x+10} = 2 \int_2^4 \frac{dx}{(x-3)^2+1}; \left[\begin{array}{l} u = x-3 \\ du = dx \\ x = 2 \Rightarrow u = -1, x = 4 \Rightarrow u = 1 \end{array} \right] \rightarrow 2 \int_{-1}^1 \frac{du}{u^2+1} = 2 [\tan^{-1} u]_{-1}^1$$

$$= 2 [\tan^{-1} 1 - \tan^{-1} (-1)] = 2 \left[\frac{\pi}{4} - \left(-\frac{\pi}{4} \right) \right] = \pi$$

$$39. \int \frac{dt}{\sqrt{-t^2+4t-3}} = \int \frac{dt}{\sqrt{1-(t-2)^2}}; \left[\begin{array}{l} u = t-2 \\ du = dt \end{array} \right] \rightarrow \int \frac{du}{\sqrt{1-u^2}} = \sin^{-1} u + C = \sin^{-1} (t-2) + C$$

$$40. \int \frac{d\theta}{\sqrt{2\theta-\theta^2}} = \int \frac{d\theta}{\sqrt{1-(\theta-1)^2}}; \left[\begin{array}{l} u = \theta-1 \\ du = d\theta \end{array} \right] \rightarrow \int \frac{du}{\sqrt{1-u^2}} = \sin^{-1} u + C = \sin^{-1} (\theta-1) + C$$

$$41. \int \frac{dx}{(x+1)\sqrt{x^2+2x}} = \int \frac{dx}{(x+1)\sqrt{(x+1)^2-1}}; \left[\begin{array}{l} u = x+1 \\ du = dx \end{array} \right] \rightarrow \int \frac{du}{u\sqrt{u^2-1}} = \sec^{-1} |u| + C = \sec^{-1} |x+1| + C,$$

$$|u| = |x+1| > 1$$

42. $\int \frac{dx}{(x-2)\sqrt{x^2-4x+3}} = \int \frac{dx}{(x-2)\sqrt{(x-2)^2-1}}; \left[\begin{array}{l} u = x-2 \\ du = dx \end{array} \right] \rightarrow \int \frac{du}{u\sqrt{u^2-1}} = \sec^{-1}|u| + C$
 $= \sec^{-1}|x-2| + C, |u| = |x-2| > 1$
43. $\int (\sec x + \cot x)^2 dx = \int (\sec^2 x + 2 \sec x \cot x + \cot^2 x) dx = \int \sec^2 x dx + \int 2 \csc x dx + \int (\csc^2 x - 1) dx$
 $= \tan x - 2 \ln |\csc x + \cot x| - \cot x - x + C$
44. $\int (\csc x - \tan x)^2 dx = \int (\csc^2 x - 2 \csc x \tan x + \tan^2 x) dx = \int \csc^2 x dx - \int 2 \sec x dx + \int (\sec^2 x - 1) dx$
 $= -\cot x - 2 \ln |\sec x + \tan x| + \tan x - x + C$
45. $\int \csc x \sin 3x dx = \int (\csc x)(\sin 2x \cos x + \sin x \cos 2x) dx = \int (\csc x)(2 \sin x \cos^2 x + \sin x \cos 2x) dx$
 $= \int (2 \cos^2 x + \cos 2x) dx = \int [(1 + \cos 2x) + \cos 2x] dx = \int (1 + 2 \cos 2x) dx = x + \sin 2x + C$
46. $\int (\sin 3x \cos 2x - \cos 3x \sin 2x) dx = \int \sin(3x - 2x) dx = \int \sin x dx = -\cos x + C$
47. $\int \frac{x}{x+1} dx = \int (1 - \frac{1}{x+1}) dx = x - \ln|x+1| + C$
48. $\int \frac{x^2}{x^2+1} dx = \int (1 - \frac{1}{x^2+1}) dx = x - \tan^{-1} x + C$
49. $\int_{\sqrt{2}}^3 \frac{2x^3}{x^2-1} dx = \int_{\sqrt{2}}^3 (2x + \frac{2x}{x^2-1}) dx = [x^2 + \ln|x^2-1|]_{\sqrt{2}}^3 = (9 + \ln 8) - (2 + \ln 1) = 7 + \ln 8$
50. $\int_{-1}^3 \frac{4x^2-7}{2x+3} dx = \int_{-1}^3 [(2x-3) + \frac{2}{2x+3}] dx = [x^2 - 3x + \ln|2x+3|]_{-1}^3 = (9 - 9 + \ln 9) - (1 + 3 + \ln 1) = \ln 9 - 4$
51. $\int \frac{4t^3-t^2+16t}{t^2+4} dt = \int [(4t-1) + \frac{4}{t^2+4}] dt = 2t^2 - t + 2 \tan^{-1}(\frac{t}{2}) + C$
52. $\int \frac{2\theta^3-7\theta^2+7\theta}{2\theta-5} d\theta = \int [(\theta^2 - \theta + 1) + \frac{5}{2\theta-5}] d\theta = \frac{\theta^3}{3} - \frac{\theta^2}{2} + \theta + \frac{5}{2} \ln|2\theta-5| + C$
53. $\int \frac{1-x}{\sqrt{1-x^2}} dx = \int \frac{dx}{\sqrt{1-x^2}} - \int \frac{x dx}{\sqrt{1-x^2}} = \sin^{-1} x + \sqrt{1-x^2} + C$
54. $\int \frac{x+2\sqrt{x-1}}{2x\sqrt{x-1}} dx = \int \frac{dx}{2\sqrt{x-1}} + \int \frac{dx}{x} = (x-1)^{1/2} + \ln|x| + C$
55. $\int_0^{\pi/4} \frac{1+\sin x}{\cos^2 x} dx = \int_0^{\pi/4} (\sec^2 x + \sec x \tan x) dx = [\tan x + \sec x]_0^{\pi/4} = (1 + \sqrt{2}) - (0 + 1) = \sqrt{2}$
56. $\int_0^{1/2} \frac{2-8x}{1+4x^2} dx = \int_0^{1/2} (\frac{2}{1+4x^2} - \frac{8x}{1+4x^2}) dx = [\tan^{-1}(2x) - \ln|1+4x^2|]_0^{1/2}$
 $= (\tan^{-1} 1 - \ln 2) - (\tan^{-1} 0 - \ln 1) = \frac{\pi}{4} - \ln 2$
57. $\int \frac{dx}{1+\sin x} = \int \frac{(1-\sin x)}{(1-\sin^2 x)} dx = \int \frac{(1-\sin x)}{\cos^2 x} dx = \int (\sec^2 x - \sec x \tan x) dx = \tan x - \sec x + C$
58. $1 + \cos x = 1 + \cos(2 \cdot \frac{x}{2}) = 2 \cos^2 \frac{x}{2} \Rightarrow \int \frac{dx}{1+\cos x} = \int \frac{dx}{2 \cos^2(\frac{x}{2})} = \frac{1}{2} \int \sec^2(\frac{x}{2}) dx = \tan \frac{x}{2} + C$
59. $\int \frac{1}{\sec \theta + \tan \theta} d\theta = \int d\theta; \left[\begin{array}{l} u = 1 + \sin \theta \\ du = \cos \theta d\theta \end{array} \right] \rightarrow \int \frac{du}{u} = \ln|u| + C = \ln|1 + \sin \theta| + C$

$$60. \int \frac{1}{\csc \theta + \cot \theta} d\theta = \int \frac{\sin \theta}{1 + \cos \theta} d\theta; \left[\begin{array}{l} u = 1 + \cos \theta \\ du = -\sin \theta d\theta \end{array} \right] \rightarrow \int \frac{-du}{u} = -\ln |u| + C = -\ln |1 + \cos \theta| + C$$

$$61. \int \frac{1}{1 - \sec x} dx = \int \frac{\cos x}{\cos x - 1} dx = \int \left(1 + \frac{1}{\cos x - 1}\right) dx = \int \left(1 - \frac{1 + \cos x}{\sin^2 x}\right) dx = \int \left(1 - \csc^2 x - \frac{\cos x}{\sin^2 x}\right) dx \\ = \int (1 - \csc^2 x - \csc x \cot x) dx = x + \cot x + \csc x + C$$

$$62. \int \frac{1}{1 - \csc x} dx = \int \frac{\sin x}{\sin x - 1} dx = \int \left(1 + \frac{1}{\sin x - 1}\right) dx = \int \left(1 + \frac{\sin x + 1}{(\sin x - 1)(\sin x + 1)}\right) dx \\ = \int \left(1 - \frac{1 + \sin x}{\cos^2 x}\right) dx = \int (1 - \sec^2 x - \frac{\sin x}{\cos^2 x}) dx = \int (1 - \sec^2 x - \sec x \tan x) dx = x - \tan x - \sec x + C$$

$$63. \int_0^{2\pi} \sqrt{\frac{1 - \cos x}{2}} dx = \int_0^{2\pi} \left|\sin \frac{x}{2}\right| dx; \left[\begin{array}{l} \sin \frac{x}{2} \geq 0 \\ \text{for } 0 \leq \frac{x}{2} \leq 2\pi \end{array} \right] \rightarrow \int_0^{2\pi} \sin \left(\frac{x}{2}\right) dx = \left[-2 \cos \frac{x}{2}\right]_0^{2\pi} = -2(\cos \pi - \cos 0) \\ = (-2)(-2) = 4$$

$$64. \int_0^{\pi} \sqrt{1 - \cos 2x} dx = \int_0^{\pi} \sqrt{2} |\sin x| dx; \left[\begin{array}{l} \sin x \geq 0 \\ \text{for } 0 \leq x \leq \pi \end{array} \right] \rightarrow \sqrt{2} \int_0^{\pi} \sin x dx = \left[-\sqrt{2} \cos x\right]_0^{\pi} \\ = -\sqrt{2}(\cos \pi - \cos 0) = 2\sqrt{2}$$

$$65. \int_{\pi/2}^{\pi} \sqrt{1 + \cos 2t} dt = \int_{\pi/2}^{\pi} \sqrt{2} |\cos t| dt; \left[\begin{array}{l} \cos t \leq 0 \\ \text{for } \frac{\pi}{2} \leq t \leq \pi \end{array} \right] \rightarrow \int_{\pi/2}^{\pi} -\sqrt{2} \cos t dt = \left[-\sqrt{2} \sin t\right]_{\pi/2}^{\pi} \\ = -\sqrt{2}(\sin \pi - \sin \frac{\pi}{2}) = \sqrt{2}$$

$$66. \int_{-\pi}^0 \sqrt{1 + \cos t} dt = \int_{-\pi}^0 \sqrt{2} |\cos \frac{t}{2}| dt; \left[\begin{array}{l} \cos \frac{t}{2} \geq 0 \\ \text{for } -\pi \leq t \leq 0 \end{array} \right] \rightarrow \int_{-\pi}^0 \sqrt{2} \cos \frac{t}{2} dt = \left[2\sqrt{2} \sin \frac{t}{2}\right]_{-\pi}^0 \\ = 2\sqrt{2} [\sin 0 - \sin(-\frac{\pi}{2})] = 2\sqrt{2}$$

$$67. \int_{-\pi}^0 \sqrt{1 - \cos^2 \theta} d\theta = \int_{-\pi}^0 |\sin \theta| d\theta; \left[\begin{array}{l} \sin \theta \leq 0 \\ \text{for } -\pi \leq \theta \leq 0 \end{array} \right] \rightarrow \int_{-\pi}^0 -\sin \theta d\theta = [\cos \theta]_{-\pi}^0 = \cos 0 - \cos(-\pi) \\ = 1 - (-1) = 2$$

$$68. \int_{\pi/2}^{\pi} \sqrt{1 - \sin^2 \theta} d\theta = \int_{\pi/2}^{\pi} |\cos \theta| d\theta; \left[\begin{array}{l} \cos \theta \leq 0 \\ \text{for } \frac{\pi}{2} \leq \theta \leq \pi \end{array} \right] \rightarrow \int_{\pi/2}^{\pi} -\cos \theta d\theta = [-\sin \theta]_{\pi/2}^{\pi} = -\sin \pi + \sin \frac{\pi}{2} = 1$$

$$69. \int_{-\pi/4}^{\pi/4} \sqrt{\tan^2 y + 1} dy = \int_{-\pi/4}^{\pi/4} |\sec y| dy; \left[\begin{array}{l} \sec y \geq 0 \\ \text{for } -\frac{\pi}{4} \leq y \leq \frac{\pi}{4} \end{array} \right] \rightarrow \int_{-\pi/4}^{\pi/4} \sec y dy = [\ln |\sec y + \tan y|]_{-\pi/4}^{\pi/4} \\ = \ln |\sqrt{2} + 1| - \ln |\sqrt{2} - 1|$$

$$70. \int_{-\pi/4}^0 \sqrt{\sec^2 y - 1} dy = \int_{-\pi/4}^0 |\tan y| dy; \left[\begin{array}{l} \tan y \leq 0 \\ \text{for } -\frac{\pi}{4} \leq y \leq 0 \end{array} \right] \rightarrow \int_{-\pi/4}^0 -\tan y dy = [\ln |\cos y|]_{-\pi/4}^0 = -\ln \left(\frac{1}{\sqrt{2}}\right) \\ = \ln \sqrt{2}$$

$$71. \int_{\pi/4}^{3\pi/4} (\csc x - \cot x)^2 dx = \int_{\pi/4}^{3\pi/4} (\csc^2 x - 2 \csc x \cot x + \cot^2 x) dx = \int_{\pi/4}^{3\pi/4} (2 \csc^2 x - 1 - 2 \csc x \cot x) dx \\ = [-2 \cot x - x + 2 \csc x]_{\pi/4}^{3\pi/4} = \left(-2 \cot \frac{3\pi}{4} - \frac{3\pi}{4} + 2 \csc \frac{3\pi}{4}\right) - \left(-2 \cot \frac{\pi}{4} - \frac{\pi}{4} + 2 \csc \frac{\pi}{4}\right) \\ = \left[-2(-1) - \frac{3\pi}{4} + 2(\sqrt{2})\right] - \left[-2(1) - \frac{\pi}{4} + 2(\sqrt{2})\right] = 4 - \frac{\pi}{2}$$

$$72. \int_0^{\pi/4} (\sec x + 4 \cos x)^2 dx = \int_0^{\pi/4} [\sec^2 x + 8 + 16 \left(\frac{1+\cos 2x}{2}\right)] dx = [\tan x + 16x - 4 \sin 2x]_0^{\pi/4}$$

$$= \left(\tan \frac{\pi}{4} + 4\pi - 4 \sin \frac{\pi}{2}\right) - (\tan 0 + 0 - 4 \sin 0) = 5 + 4\pi$$

$$73. \int \cos \theta \csc(\sin \theta) d\theta; \left[\begin{array}{l} u = \sin \theta \\ du = \cos \theta d\theta \end{array} \right] \rightarrow \int \csc u du = -\ln |\csc u + \cot u| + C$$

$$= -\ln |\csc(\sin \theta) + \cot(\sin \theta)| + C$$

$$74. \int \left(1 + \frac{1}{x}\right) \cot(x + \ln x) dx; \left[\begin{array}{l} u = x + \ln x \\ du = \left(1 + \frac{1}{x}\right) dx \end{array} \right] \rightarrow \int \cot u du = \ln |\sin u| + C = \ln |\sin(x + \ln x)| + C$$

$$75. \int (\csc x - \sec x)(\sin x + \cos x) dx = \int (1 + \cot x - \tan x - 1) dx = \int \cot x dx - \int \tan x dx$$

$$= \ln |\sin x| + \ln |\cos x| + C$$

$$76. \int 3 \sinh\left(\frac{x}{2} + \ln 5\right) dx = \left[\begin{array}{l} u = \frac{x}{2} + \ln 5 \\ 2 du = dx \end{array} \right] = 6 \int \sinh u du = 6 \cosh u + C = 6 \cosh\left(\frac{x}{2} + \ln 5\right) + C$$

$$77. \int \frac{6 dy}{\sqrt{y}(1+y)}; \left[\begin{array}{l} u = \sqrt{y} \\ du = \frac{1}{2\sqrt{y}} dy \end{array} \right] \rightarrow \int \frac{12 du}{1+u^2} = 12 \tan^{-1} u + C = 12 \tan^{-1} \sqrt{y} + C$$

$$78. \int \frac{dx}{x\sqrt{4x^2-1}} = \int \frac{2 dx}{2x\sqrt{(2x)^2-1}}; \left[\begin{array}{l} u = 2x \\ du = 2 dx \end{array} \right] \rightarrow \int \frac{du}{u\sqrt{u^2-1}} = \sec^{-1} |u| + C = \sec^{-1} |2x| + C$$

$$79. \int \frac{7 dx}{(x-1)\sqrt{x^2-2x-48}} = \int \frac{7 dx}{(x-1)\sqrt{(x-1)^2-49}}; \left[\begin{array}{l} u = x-1 \\ du = dx \end{array} \right] \rightarrow \int \frac{7 du}{u\sqrt{u^2-49}} = 7 \cdot \frac{1}{7} \sec^{-1} \left|\frac{u}{7}\right| + C$$

$$= \sec^{-1} \left|\frac{x-1}{7}\right| + C$$

$$80. \int \frac{dx}{(2x+1)\sqrt{4x^2+4x}} = \int \frac{dx}{(2x+1)\sqrt{(2x+1)^2-1}}; \left[\begin{array}{l} u = 2x+1 \\ du = 2 dx \end{array} \right] \rightarrow \int \frac{du}{2u\sqrt{u^2-1}} = \frac{1}{2} \sec^{-1} |u| + C$$

$$= \frac{1}{2} \sec^{-1} |2x+1| + C$$

$$81. \int \sec^2 t \tan(\tan t) dt; \left[\begin{array}{l} u = \tan t \\ du = \sec^2 t dt \end{array} \right] \rightarrow \int \tan u du = -\ln |\cos u| + C = \ln |\sec u| + C = \ln |\sec(\tan t)| + C$$

$$82. \int \frac{dx}{x\sqrt{3+x^2}} = -\frac{1}{3} \operatorname{csch}^{-1} \left| \frac{x}{\sqrt{3}} \right| + C$$

$$83. (a) \int \cos^3 \theta d\theta = \int (\cos \theta)(1 - \sin^2 \theta) d\theta; \left[\begin{array}{l} u = \sin \theta \\ du = \cos \theta d\theta \end{array} \right] \rightarrow \int (1 - u^2) du = u - \frac{u^3}{3} + C = \sin \theta - \frac{1}{3} \sin^3 \theta + C$$

$$(b) \int \cos^5 \theta d\theta = \int (\cos \theta)(1 - \sin^2 \theta)^2 d\theta = \int (1 - u^2)^2 du = \int (1 - 2u^2 + u^4) du = u - \frac{2}{3} u^3 + \frac{u^5}{5} + C$$

$$= \sin \theta - \frac{2}{3} \sin^3 \theta + \frac{1}{5} \sin^5 \theta + C$$

$$(c) \int \cos^9 \theta d\theta = \int (\cos^8 \theta)(\cos \theta) d\theta = \int (1 - \sin^2 \theta)^4 (\cos \theta) d\theta$$

$$84. (a) \int \sin^3 \theta d\theta = \int (1 - \cos^2 \theta)(\sin \theta) d\theta; \left[\begin{array}{l} u = \cos \theta \\ du = -\sin \theta d\theta \end{array} \right] \rightarrow \int (1 - u^2)(-du) = \frac{u^3}{3} - u + C$$

$$= -\cos \theta + \frac{1}{3} \cos^3 \theta + C$$

$$(b) \int \sin^5 \theta d\theta = \int (1 - \cos^2 \theta)^2 (\sin \theta) d\theta = \int (1 - u^2)^2 (-du) = \int (-1 + 2u^2 - u^4) du$$

$$= -\cos \theta + \frac{2}{3} \cos^3 \theta - \frac{1}{5} \cos^5 \theta + C$$

$$(c) \int \sin^7 \theta \, d\theta = \int (1 - u^2)^3 (-du) = \int (-1 + 3u^2 - 3u^4 + u^6) \, du = -\cos \theta + \cos^3 \theta - \frac{3}{5} \cos^5 \theta + \frac{\cos^7 \theta}{7} + C$$

$$(d) \int \sin^{13} \theta \, d\theta = \int (\sin^{12} \theta) (\sin \theta) \, d\theta = \int (1 - \cos^2 \theta)^6 (\sin \theta) \, d\theta$$

$$85. (a) \int \tan^3 \theta \, d\theta = \int (\sec^2 \theta - 1) (\tan \theta) \, d\theta = \int \sec^2 \theta \tan \theta \, d\theta - \int \tan \theta \, d\theta = \frac{1}{2} \tan^2 \theta - \int \tan \theta \, d\theta \\ = \frac{1}{2} \tan^2 \theta + \ln |\cos \theta| + C$$

$$(b) \int \tan^5 \theta \, d\theta = \int (\sec^2 \theta - 1) (\tan^3 \theta) \, d\theta = \int \tan^3 \theta \sec^2 \theta \, d\theta - \int \tan^3 \theta \, d\theta = \frac{1}{4} \tan^4 \theta - \int \tan^3 \theta \, d\theta$$

$$(c) \int \tan^7 \theta \, d\theta = \int (\sec^2 \theta - 1) (\tan^5 \theta) \, d\theta = \int \tan^5 \theta \sec^2 \theta \, d\theta - \int \tan^5 \theta \, d\theta = \frac{1}{6} \tan^6 \theta - \int \tan^5 \theta \, d\theta$$

$$(d) \int \tan^{2k+1} \theta \, d\theta = \int (\sec^2 \theta - 1) (\tan^{2k} \theta) \, d\theta = \int \tan^{2k} \theta \sec^2 \theta \, d\theta - \int \tan^{2k} \theta \, d\theta;$$

$$\left[\begin{array}{l} u = \tan \theta \\ du = \sec^2 \theta \, d\theta \end{array} \right] \rightarrow \int u^{2k} \, du - \int \tan^{2k} \theta \, d\theta = \frac{1}{2k} u^{2k} - \int \tan^{2k} \theta \, d\theta = \frac{1}{2k} \tan^{2k} \theta - \int \tan^{2k} \theta \, d\theta$$

$$86. (a) \int \cot^3 \theta \, d\theta = \int (\csc^2 \theta - 1) (\cot \theta) \, d\theta = \int \cot \theta \csc^2 \theta \, d\theta - \int \cot \theta \, d\theta = -\frac{1}{2} \cot^2 \theta - \int \cot \theta \, d\theta \\ = -\frac{1}{2} \cot^2 \theta - \ln |\sin \theta| + C$$

$$(b) \int \cot^5 \theta \, d\theta = \int (\csc^2 \theta - 1) (\cot^3 \theta) \, d\theta = \int \cot^3 \theta \csc^2 \theta \, d\theta - \int \cot^3 \theta \, d\theta = -\frac{1}{4} \cot^4 \theta - \int \cot^3 \theta \, d\theta$$

$$(c) \int \cot^7 \theta \, d\theta = \int (\csc^2 \theta - 1) (\cot^5 \theta) \, d\theta = \int \cot^5 \theta \csc^2 \theta \, d\theta - \int \cot^5 \theta \, d\theta = -\frac{1}{6} \cot^6 \theta - \int \cot^5 \theta \, d\theta$$

$$(d) \int \cot^{2k+1} \theta \, d\theta = \int (\csc^2 \theta - 1) (\cot^{2k} \theta) \, d\theta = \int \cot^{2k} \theta \csc^2 \theta \, d\theta - \int \cot^{2k} \theta \, d\theta;$$

$$\left[\begin{array}{l} u = \cot \theta \\ du = -\csc^2 \theta \, d\theta \end{array} \right] \rightarrow -\int u^{2k} \, du - \int \cot^{2k} \theta \, d\theta = -\frac{1}{2k} u^{2k} - \int \cot^{2k} \theta \, d\theta \\ = -\frac{1}{2k} \cot^{2k} \theta - \int \cot^{2k} \theta \, d\theta$$

$$87. A = \int_{-\pi/4}^{\pi/4} (2 \cos x - \sec x) \, dx = [2 \sin x - \ln |\sec x + \tan x|]_{-\pi/4}^{\pi/4} \\ = \left[\sqrt{2} - \ln(\sqrt{2} + 1) \right] - \left[-\sqrt{2} - \ln(\sqrt{2} - 1) \right] \\ = 2\sqrt{2} - \ln\left(\frac{\sqrt{2}+1}{\sqrt{2}-1}\right) = 2\sqrt{2} - \ln\left(\frac{(\sqrt{2}+1)^2}{2-1}\right) \\ = 2\sqrt{2} - \ln(3 + 2\sqrt{2})$$

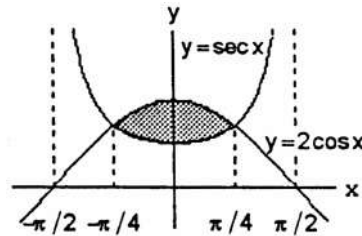

$$88. A = \int_{\pi/6}^{\pi/2} (\csc x - \sin x) \, dx = [-\ln |\csc x + \cot x| + \cos x]_{\pi/6}^{\pi/2} \\ = -\ln |1 + 0| + \ln |2 + \sqrt{3}| - \frac{\sqrt{3}}{2} = \ln(2 + \sqrt{3}) - \frac{\sqrt{3}}{2}$$

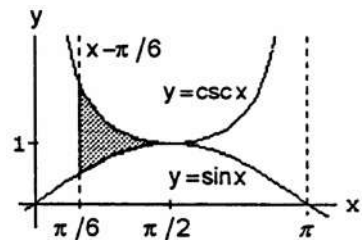

$$89. V = \int_{-\pi/4}^{\pi/4} \pi(2 \cos x)^2 \, dx - \int_{-\pi/4}^{\pi/4} \pi \sec^2 x \, dx = 4\pi \int_{-\pi/4}^{\pi/4} \cos^2 x \, dx - \pi \int_{-\pi/4}^{\pi/4} \sec^2 x \, dx \\ = 2\pi \int_{-\pi/4}^{\pi/4} (1 + \cos 2x) \, dx - \pi [\tan x]_{-\pi/4}^{\pi/4} = 2\pi \left[x + \frac{1}{2} \sin 2x \right]_{-\pi/4}^{\pi/4} - \pi [1 - (-1)] \\ = 2\pi \left[\left(\frac{\pi}{4} + \frac{1}{2} \right) - \left(-\frac{\pi}{4} - \frac{1}{2} \right) \right] - 2\pi = 2\pi \left(\frac{\pi}{2} + 1 \right) - 2\pi = \pi^2$$

$$90. V = \int_{\pi/6}^{\pi/2} \pi \csc^2 x \, dx - \int_{\pi/6}^{\pi/2} \pi \sin^2 x \, dx = \pi \int_{\pi/6}^{\pi/2} \csc^2 x \, dx - \frac{\pi}{2} \int_{\pi/6}^{\pi/2} (1 - \cos 2x) \, dx \\ = \pi [-\cot x]_{\pi/6}^{\pi/2} - \frac{\pi}{2} \left[x - \frac{1}{2} \sin 2x \right]_{\pi/6}^{\pi/2} = \pi \left[0 - \left(-\sqrt{3} \right) \right] - \frac{\pi}{2} \left[\left(\frac{\pi}{2} - 0 \right) - \left(\frac{\pi}{6} - \frac{1}{2} \cdot \frac{\sqrt{3}}{2} \right) \right] \\ = \pi\sqrt{3} - \frac{\pi}{2} \left(\frac{2\pi}{6} + \frac{\sqrt{3}}{4} \right) = \pi \left(\frac{7\sqrt{3}}{8} - \frac{\pi}{6} \right)$$

$$91. y = \ln(\cos x) \Rightarrow \frac{dy}{dx} = -\frac{\sin x}{\cos x} \Rightarrow \left(\frac{dy}{dx}\right)^2 = \tan^2 x = \sec^2 x - 1; L = \int_a^b \sqrt{1 + \left(\frac{dy}{dx}\right)^2} dx$$

$$= \int_0^{\pi/3} \sqrt{1 + (\sec^2 x - 1)} dx = \int_0^{\pi/3} \sec x dx = [\ln |\sec x + \tan x|]_0^{\pi/3} = \ln |2 + \sqrt{3}| - \ln |1 + 0| = \ln(2 + \sqrt{3})$$

$$92. y = \ln(\sec x) \Rightarrow \frac{dy}{dx} = \frac{\sec x \tan x}{\sec x} \Rightarrow \left(\frac{dy}{dx}\right)^2 = \tan^2 x = \sec^2 x - 1; L = \int_a^b \sqrt{1 + \left(\frac{dy}{dx}\right)^2} dx$$

$$= \int_0^{\pi/4} \sec x dx = [\ln |\sec x + \tan x|]_0^{\pi/4} = \ln |\sqrt{2} + 1| - \ln |1 + 0| = \ln(\sqrt{2} + 1)$$

$$93. M_x = \int_{-\pi/4}^{\pi/4} \left(\frac{1}{2} \sec x\right) (\sec x) dx = \frac{1}{2} \int_{-\pi/4}^{\pi/4} \sec^2 x dx$$

$$= \frac{1}{2} [\tan x]_{-\pi/4}^{\pi/4} = \frac{1}{2} [1 - (-1)] = 1;$$

$$M = \int_{-\pi/4}^{\pi/4} \sec x dx = [\ln |\sec x + \tan x|]_{-\pi/4}^{\pi/4}$$

$$= \ln |\sqrt{2} + 1| - \ln |\sqrt{2} - 1| = \ln \left(\frac{\sqrt{2}+1}{\sqrt{2}-1}\right)$$

$$= \ln \left(\frac{(\sqrt{2}+1)^2}{2-1}\right) = \ln(3 + 2\sqrt{2}); \bar{x} = 0 \text{ by}$$

symmetry of the region, and $\bar{y} = \frac{M_x}{M} = \frac{1}{\ln(3 + 2\sqrt{2})}$

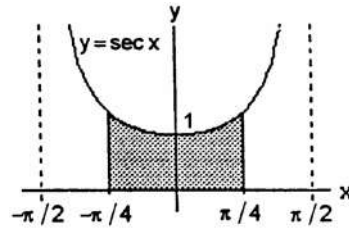

$$94. M_x = \int_{\pi/6}^{5\pi/6} \left(\frac{1}{2} \csc x\right) (\csc x) dx = \frac{1}{2} \int_{\pi/6}^{5\pi/6} \csc^2 x dx$$

$$= \frac{1}{2} [-\cot x]_{\pi/6}^{5\pi/6} = \frac{1}{2} [-(-\sqrt{3}) - (-\sqrt{3})] = \sqrt{3};$$

$$M = \int_{\pi/6}^{5\pi/6} \csc x dx = [-\ln |\csc x + \cot x|]_{\pi/6}^{5\pi/6}$$

$$= -\ln |2 - \sqrt{3}| - (-\ln |2 + \sqrt{3}|) = \ln \left|\frac{2+\sqrt{3}}{2-\sqrt{3}}\right|$$

$$= \ln \left(\frac{(2+\sqrt{3})^2}{4-3}\right) = 2 \ln(2 + \sqrt{3}); \bar{x} = \frac{\pi}{2} \text{ by symmetry}$$

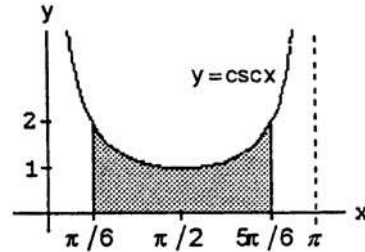

of the region, and $\bar{y} = \frac{M_x}{M} = \frac{\sqrt{3}}{2 \ln(2 + \sqrt{3})}$

$$95. \int \csc x dx = \int (\csc x)(1) dx = \int (\csc x) \left(\frac{\csc x + \cot x}{\csc x + \cot x}\right) dx = \int \frac{\csc^2 x + \csc x \cot x}{\csc x + \cot x} dx;$$

$$\left[\begin{array}{l} u = \csc x + \cot x \\ du = (-\csc x \cot x - \csc^2 x) dx \end{array} \right] \rightarrow \int \frac{-du}{u} = -\ln |u| + C = -\ln |\csc x + \cot x| + C$$

$$96. [(x^2 - 1)(x + 1)]^{-2/3} = [(x - 1)(x + 1)^2]^{-2/3} = (x - 1)^{-2/3}(x + 1)^{-4/3} = (x + 1)^{-2} [(x - 1)^{-2/3}(x + 1)^{2/3}]$$

$$= (x + 1)^{-2} \left(\frac{x-1}{x+1}\right)^{-2/3} = (x + 1)^{-2} \left(1 - \frac{2}{x+1}\right)^{-2/3}$$

$$(a) \int [(x^2 - 1)(x + 1)]^{-2/3} dx = \int (x + 1)^{-2} \left(1 - \frac{2}{x+1}\right)^{-2/3} dx; \left[\begin{array}{l} u = \frac{1}{x+1} \\ du = -\frac{1}{(x+1)^2} dx \end{array} \right]$$

$$\rightarrow \int -(1 - 2u)^{-2/3} du = \frac{3}{2} (1 - 2u)^{1/3} + C = \frac{3}{2} \left(1 - \frac{2}{x+1}\right)^{1/3} + C = \frac{3}{2} \left(\frac{x-1}{x+1}\right)^{1/3} + C$$

$$(b) \int [(x^2 - 1)(x + 1)]^{-2/3} dx = \int (x + 1)^{-2} \left(\frac{x-1}{x+1}\right)^{-2/3} dx; u = \left(\frac{x-1}{x+1}\right)^k$$

$$\Rightarrow du = k \left(\frac{x-1}{x+1}\right)^{k-1} \frac{[(x+1) - (x-1)]}{(x+1)^2} dx = 2k \frac{(x-1)^{k-1}}{(x+1)^{k+1}} dx; dx = \frac{(x+1)^2}{2k} \left(\frac{x-1}{x+1}\right)^{k-1} du$$

$$= \frac{(x+1)^2}{2k} \left(\frac{x-1}{x+1}\right)^{1-k} du; \text{ then, } \int \left(\frac{x-1}{x+1}\right)^{-2/3} \frac{1}{2k} \left(\frac{x-1}{x+1}\right)^{1-k} du = \frac{1}{2k} \int \left(\frac{x-1}{x+1}\right)^{(1/3-k)} du$$

$$= \frac{1}{2k} \int \left(\frac{x-1}{x+1}\right)^{k(1/3k-1)} du = \frac{1}{2k} \int u^{(1/3k-1)} du = \frac{1}{2k} (3k) u^{1/3k} + C = \frac{3}{2} u^{1/3k} + C = \frac{3}{2} \left(\frac{x-1}{x+1}\right)^{1/3} + C$$

(c) $\int [(x^2 - 1)(x + 1)]^{-2/3} dx = \int (x + 1)^{-2} \left(\frac{x-1}{x+1}\right)^{-2/3} dx;$

$$\begin{aligned} \left[\begin{array}{l} u = \tan^{-1} x \\ x = \tan u \\ dx = \frac{du}{\cos^2 u} \end{array} \right] &\rightarrow \int \frac{1}{(\tan u + 1)^2} \left(\frac{\tan u - 1}{\tan u + 1}\right)^{-2/3} \left(\frac{du}{\cos^2 u}\right) = \int \frac{1}{(\sin u + \cos u)^2} \left(\frac{\sin u - \cos u}{\sin u + \cos u}\right)^{-2/3} du; \\ \left[\begin{array}{l} \sin u + \cos u = \sin u + \sin\left(\frac{\pi}{2} - u\right) = 2 \sin \frac{\pi}{4} \cos\left(u - \frac{\pi}{4}\right) \\ \sin u - \cos u = \sin u - \sin\left(\frac{\pi}{2} - u\right) = 2 \cos \frac{\pi}{4} \sin\left(u - \frac{\pi}{4}\right) \end{array} \right] &\rightarrow \int \frac{1}{2 \cos^2\left(u - \frac{\pi}{4}\right)} \left[\frac{\sin\left(u - \frac{\pi}{4}\right)}{\cos\left(u - \frac{\pi}{4}\right)}\right]^{-2/3} du \\ &= \frac{1}{2} \int \tan^{-2/3}\left(u - \frac{\pi}{4}\right) \sec^2\left(u - \frac{\pi}{4}\right) du = \frac{3}{2} \tan^{1/3}\left(u - \frac{\pi}{4}\right) + C = \frac{3}{2} \left[\frac{\tan u - \tan \frac{\pi}{4}}{1 + \tan u \tan \frac{\pi}{4}}\right]^{1/3} + C \\ &= \frac{3}{2} \left(\frac{x-1}{x+1}\right)^{1/3} + C \end{aligned}$$

(d) $u = \tan^{-1} \sqrt{x} \Rightarrow \tan u = \sqrt{x} \Rightarrow \tan^2 u = x \Rightarrow dx = 2 \tan u \left(\frac{1}{\cos^2 u}\right) du = \frac{2 \sin u}{\cos^3 u} du = -\frac{2d(\cos u)}{\cos^3 u};$

$$\begin{aligned} x - 1 = \tan^2 u - 1 = \frac{\sin^2 u - \cos^2 u}{\cos^2 u} = \frac{1 - 2 \cos^2 u}{\cos^2 u}; \quad x + 1 = \tan^2 u + 1 = \frac{\cos^2 u + \sin^2 u}{\cos^2 u} = \frac{1}{\cos^2 u}; \\ \int (x - 1)^{-2/3} (x + 1)^{-4/3} dx = \int \frac{(1 - 2 \cos^2 u)^{-2/3}}{(\cos^2 u)^{-2/3}} \cdot \frac{1}{(\cos^2 u)^{-4/3}} \cdot \frac{-2d(\cos u)}{\cos^3 u} \\ = \int (1 - 2 \cos^2 u)^{-2/3} \cdot (-2) \cdot \cos u \cdot d(\cos u) = \frac{1}{2} \int (1 - 2 \cos^2 u)^{-2/3} \cdot d(1 - 2 \cos^2 u) \\ = \frac{3}{2} (1 - 2 \cos^2 u)^{1/3} + C = \frac{3}{2} \left[\frac{(1 - 2 \cos^2 u)}{\left(\frac{1}{\cos^2 u}\right)}\right]^{1/3} + C = \frac{3}{2} \left(\frac{x-1}{x+1}\right)^{1/3} + C \end{aligned}$$

(e) $u = \tan^{-1} \left(\frac{x-1}{x+1}\right) \Rightarrow \frac{x-1}{x+1} = \tan u \Rightarrow x + 1 = 2(\tan u + 1) \Rightarrow dx = \frac{2 du}{\cos^2 u} = 2d(\tan u);$

$$\begin{aligned} \int (x - 1)^{-2/3} (x + 1)^{-4/3} dx = \int (\tan u)^{-2/3} (\tan u + 1)^{-4/3} \cdot 2^{-2} \cdot 2 \cdot d(\tan u) \\ = \frac{1}{2} \int \left(1 - \frac{1}{\tan u + 1}\right)^{-2/3} d\left(1 - \frac{1}{\tan u + 1}\right) = \frac{3}{2} \left(1 - \frac{1}{\tan u + 1}\right)^{1/3} + C = \frac{3}{2} \left(1 - \frac{2}{x+1}\right)^{1/3} + C \\ = \frac{3}{2} \left(\frac{x-1}{x+1}\right)^{1/3} + C \end{aligned}$$

(f) $\left[\begin{array}{l} u = \cos^{-1} x \\ x = \cos u \\ dx = -\sin u du \end{array} \right] \rightarrow -\int \frac{\sin u du}{\sqrt{(\cos^2 u - 1)^2 (\cos u + 1)^2}} = -\int \frac{\sin u du}{(\sin^{4/3} u) (2^{2/3} \cos \frac{u}{2})^{4/3}}$

$$\begin{aligned} &= -\int \frac{du}{(\sin u)^{1/3} (2^{2/3} \cos \frac{u}{2})^{4/3}} = -\int \frac{du}{2 (\sin \frac{u}{2})^{1/3} (\cos \frac{u}{2})^{5/3}} = -\frac{1}{2} \int \left(\frac{\cos \frac{u}{2}}{\sin \frac{u}{2}}\right)^{1/3} \frac{du}{(\cos^2 \frac{u}{2})} \\ &= -\int \tan^{-1/3}\left(\frac{u}{2}\right) d\left(\tan \frac{u}{2}\right) = -\frac{3}{2} \tan^{2/3} \frac{u}{2} + C = \frac{3}{2} \left(-\tan^2 \frac{u}{2}\right)^{1/3} + C = \frac{3}{2} \left(\frac{\cos u - 1}{\cos u + 1}\right)^{1/3} + C \\ &= \frac{3}{2} \left(\frac{x-1}{x+1}\right)^{1/3} + C \end{aligned}$$

(g) $\int [(x^2 - 1)(x + 1)]^{-2/3} dx; \left[\begin{array}{l} u = \cosh^{-1} x \\ x = \cosh u \\ dx = \sinh u \end{array} \right] \rightarrow \int \frac{\sinh u du}{\sqrt{(\cosh^2 u - 1)^2 (\cosh u + 1)^2}}$

$$\begin{aligned} &= \int \frac{\sinh u du}{\sqrt{(\sinh^4 u) (\cosh u + 1)^2}} = \int \frac{du}{\sqrt{(\sinh u) (4 \cosh^4 \frac{u}{2})}} = \frac{1}{2} \int \frac{du}{\sqrt{\sinh\left(\frac{u}{2}\right) \cosh^5\left(\frac{u}{2}\right)}} \\ &= \int (\tanh \frac{u}{2})^{-1/3} d(\tanh \frac{u}{2}) = \frac{3}{2} (\tanh \frac{u}{2})^{2/3} + C = \frac{3}{2} \left(\frac{\cosh u - 1}{\cosh u + 1}\right)^{1/3} + C = \frac{3}{2} \left(\frac{x-1}{x+1}\right)^{1/3} + C \end{aligned}$$

8.2 INTEGRATION BY PARTS

1. $u = x, du = dx; dv = \sin \frac{x}{2} dx, v = -2 \cos \frac{x}{2};$

$$\int x \sin \frac{x}{2} dx = -2x \cos \frac{x}{2} - \int (-2 \cos \frac{x}{2}) dx = -2x \cos \left(\frac{x}{2}\right) + 4 \sin \left(\frac{x}{2}\right) + C$$

2. $u = \theta, du = d\theta; dv = \cos \pi\theta d\theta, v = \frac{1}{\pi} \sin \pi\theta;$

$$\int \theta \cos \pi\theta d\theta = \frac{\theta}{\pi} \sin \pi\theta - \int \frac{1}{\pi} \sin \pi\theta d\theta = \frac{\theta}{\pi} \sin \pi\theta + \frac{1}{\pi^2} \cos \pi\theta + C$$

3. $\cos t$

$$t^2 \xrightarrow{(+)} \sin t$$

$$2t \xrightarrow{(-)} -\cos t$$

$$2 \xrightarrow{(+)} -\sin t$$

0

$$\int t^2 \cos t \, dt = t^2 \sin t + 2t \cos t - 2 \sin t + C$$

4. $\sin x$

$$x^2 \xrightarrow{(+)} -\cos x$$

$$2x \xrightarrow{(-)} -\sin x$$

$$2 \xrightarrow{(+)} \cos x$$

0

$$\int x^2 \sin x \, dx = -x^2 \cos x + 2x \sin x + 2 \cos x + C$$

5. $u = \ln x, du = \frac{dx}{x}; dv = x \, dx, v = \frac{x^2}{2};$

$$\int_1^2 x \ln x \, dx = \left[\frac{x^2}{2} \ln x \right]_1^2 - \int_1^2 \frac{x^2}{2} \frac{dx}{x} = 2 \ln 2 - \left[\frac{x^2}{4} \right]_1^2 = 2 \ln 2 - \frac{3}{4} = \ln 4 - \frac{3}{4}$$

6. $u = \ln x, du = \frac{dx}{x}; dv = x^3 \, dx, v = \frac{x^4}{4};$

$$\int_1^e x^3 \ln x \, dx = \left[\frac{x^4}{4} \ln x \right]_1^e - \int_1^e \frac{x^4}{4} \frac{dx}{x} = \frac{e^4}{4} - \left[\frac{x^4}{16} \right]_1^e = \frac{3e^4 + 1}{16}$$

7. $u = \tan^{-1} y, du = \frac{dy}{1+y^2}; dv = dy, v = y;$

$$\int \tan^{-1} y \, dy = y \tan^{-1} y - \int \frac{y \, dy}{(1+y^2)} = y \tan^{-1} y - \frac{1}{2} \ln(1+y^2) + C = y \tan^{-1} y - \ln \sqrt{1+y^2} + C$$

8. $u = \sin^{-1} y, du = \frac{dy}{\sqrt{1-y^2}}; dv = dy, v = y;$

$$\int \sin^{-1} y \, dy = y \sin^{-1} y - \int \frac{y \, dy}{\sqrt{1-y^2}} = y \sin^{-1} y + \sqrt{1-y^2} + C$$

9. $u = x, du = dx; dv = \sec^2 x \, dx, v = \tan x;$

$$\int x \sec^2 x \, dx = x \tan x - \int \tan x \, dx = x \tan x + \ln |\cos x| + C$$

10. $\int 4x \sec^2 2x \, dx; [y = 2x] \rightarrow \int y \sec^2 y \, dy = y \tan y - \int \tan y \, dy = y \tan y - \ln |\sec y| + C$
 $= 2x \tan 2x - \ln |\sec 2x| + C$

11. e^x

$$x^3 \xrightarrow{(+)} e^x$$

$$3x^2 \xrightarrow{(-)} e^x$$

$$6x \xrightarrow{(+)} e^x$$

$$6 \xrightarrow{(-)} e^x$$

0

$$\int x^3 e^x \, dx = x^3 e^x - 3x^2 e^x + 6x e^x - 6e^x + C = (x^3 - 3x^2 + 6x - 6) e^x + C$$

$$\begin{array}{r}
 12. \qquad e^{-p} \\
 p^4 \xrightarrow{(+)} -e^{-p} \\
 4p^3 \xrightarrow{(-)} e^{-p} \\
 12p^2 \xrightarrow{(+)} -e^{-p} \\
 24p \xrightarrow{(-)} e^{-p} \\
 24 \xrightarrow{(+)} -e^{-p} \\
 0
 \end{array}$$

$$\begin{aligned}
 \int p^4 e^{-p} dp &= -p^4 e^{-p} - 4p^3 e^{-p} - 12p^2 e^{-p} - 24p e^{-p} - 24e^{-p} + C \\
 &= (-p^4 - 4p^3 - 12p^2 - 24p - 24) e^{-p} + C
 \end{aligned}$$

$$\begin{array}{r}
 13. \qquad e^x \\
 x^2 - 5x \xrightarrow{(+)} e^x \\
 2x - 5 \xrightarrow{(-)} e^x \\
 2 \xrightarrow{(+)} e^x \\
 0
 \end{array}$$

$$\begin{aligned}
 \int (x^2 - 5x) e^x dx &= (x^2 - 5x) e^x - (2x - 5) e^x + 2e^x + C = x^2 e^x - 7x e^x + 7e^x + C \\
 &= (x^2 - 7x + 7) e^x + C
 \end{aligned}$$

$$\begin{array}{r}
 14. \qquad e^r \\
 r^2 + r + 1 \xrightarrow{(+)} e^r \\
 2r + 1 \xrightarrow{(-)} e^r \\
 2 \xrightarrow{(+)} e^r \\
 0
 \end{array}$$

$$\begin{aligned}
 \int (r^2 + r + 1) e^r dr &= (r^2 + r + 1) e^r - (2r + 1) e^r + 2e^r + C \\
 &= [(r^2 + r + 1) - (2r + 1) + 2] e^r + C = (r^2 - r + 2) e^r + C
 \end{aligned}$$

$$\begin{array}{r}
 15. \qquad e^x \\
 x^5 \xrightarrow{(+)} e^x \\
 5x^4 \xrightarrow{(-)} e^x \\
 20x^3 \xrightarrow{(+)} e^x \\
 60x^2 \xrightarrow{(-)} e^x \\
 120x \xrightarrow{(+)} e^x \\
 120 \xrightarrow{(-)} e^x \\
 0
 \end{array}$$

$$\begin{aligned}
 \int x^5 e^x dx &= x^5 e^x - 5x^4 e^x + 20x^3 e^x - 60x^2 e^x + 120x e^x - 120e^x + C \\
 &= (x^5 - 5x^4 + 20x^3 - 60x^2 + 120x - 120) e^x + C
 \end{aligned}$$

$$\begin{array}{rcl}
 16. & & e^{4t} \\
 t^2 & \xrightarrow{(+)} & \frac{1}{4} e^{4t} \\
 2t & \xrightarrow{(-)} & \frac{1}{16} e^{4t} \\
 2 & \xrightarrow{(+)} & \frac{1}{64} e^{4t} \\
 0 & &
 \end{array}$$

$$\begin{aligned}
 \int t^2 e^{4t} dt &= \frac{t^2}{4} e^{4t} - \frac{2t}{16} e^{4t} + \frac{2}{64} e^{4t} + C = \frac{t^2}{4} e^{4t} - \frac{1}{8} e^{4t} + \frac{1}{32} e^{4t} + C \\
 &= \left(\frac{t^2}{4} - \frac{1}{8} + \frac{1}{32} \right) e^{4t} + C
 \end{aligned}$$

$$\begin{array}{rcl}
 17. & & \sin 2\theta \\
 \theta^2 & \xrightarrow{(+)} & -\frac{1}{2} \cos 2\theta \\
 2\theta & \xrightarrow{(-)} & -\frac{1}{4} \sin 2\theta \\
 2 & \xrightarrow{(+)} & \frac{1}{8} \cos 2\theta \\
 0 & &
 \end{array}$$

$$\begin{aligned}
 \int_0^{\pi/2} \theta^2 \sin 2\theta d\theta &= \left[-\frac{\theta^2}{2} \cos 2\theta + \frac{\theta}{2} \sin 2\theta + \frac{1}{4} \cos 2\theta \right]_0^{\pi/2} \\
 &= \left[-\frac{\pi^2}{8} \cdot (-1) + \frac{\pi}{4} \cdot 0 + \frac{1}{4} \cdot (-1) \right] - [0 + 0 + \frac{1}{4} \cdot 1] = \frac{\pi^2}{8} - \frac{1}{2} = \frac{\pi^2 - 4}{8}
 \end{aligned}$$

$$\begin{array}{rcl}
 18. & & \cos 2x \\
 x^3 & \xrightarrow{(+)} & \frac{1}{2} \sin 2x \\
 3x^2 & \xrightarrow{(-)} & -\frac{1}{4} \cos 2x \\
 6x & \xrightarrow{(+)} & -\frac{1}{8} \sin 2x \\
 6 & \xrightarrow{(-)} & \frac{1}{16} \cos 2x \\
 0 & &
 \end{array}$$

$$\begin{aligned}
 \int_0^{\pi/2} x^3 \cos 2x dx &= \left[\frac{x^3}{2} \sin 2x + \frac{3x^2}{4} \cos 2x - \frac{3x}{4} \sin 2x - \frac{3}{8} \cos 2x \right]_0^{\pi/2} \\
 &= \left[\frac{\pi^3}{16} \cdot 0 + \frac{3\pi^2}{16} \cdot (-1) - \frac{3\pi}{8} \cdot 0 - \frac{3}{8} \cdot (-1) \right] - [0 + 0 - 0 - \frac{3}{8} \cdot 1] = -\frac{3\pi^2}{16} + \frac{3}{4} = \frac{3(4 - \pi^2)}{16}
 \end{aligned}$$

$$19. u = \sec^{-1} t, du = \frac{dt}{t\sqrt{t^2-1}}; dv = t dt, v = \frac{t^2}{2};$$

$$\begin{aligned}
 \int_{2/\sqrt{3}}^2 t \sec^{-1} t dt &= \left[\frac{t^2}{2} \sec^{-1} t \right]_{2/\sqrt{3}}^2 - \int_{2/\sqrt{3}}^2 \left(\frac{t^2}{2} \right) \frac{dt}{t\sqrt{t^2-1}} = \left(2 \cdot \frac{\pi}{3} - \frac{2}{3} \cdot \frac{\pi}{6} \right) - \int_{2/\sqrt{3}}^2 \frac{t dt}{2\sqrt{t^2-1}} \\
 &= \frac{5\pi}{9} - \left[\frac{1}{2} \sqrt{t^2-1} \right]_{2/\sqrt{3}}^2 = \frac{5\pi}{9} - \frac{1}{2} \left(\sqrt{3} - \sqrt{\frac{4}{3}-1} \right) = \frac{5\pi}{9} - \frac{1}{2} \left(\sqrt{3} - \frac{\sqrt{3}}{3} \right) = \frac{5\pi}{9} - \frac{\sqrt{3}}{3} = \frac{5\pi - 3\sqrt{3}}{9}
 \end{aligned}$$

$$20. u = \sin^{-1}(x^2), du = \frac{2x dx}{\sqrt{1-x^4}}; dv = 2x dx, v = x^2;$$

$$\begin{aligned}
 \int_0^{1/\sqrt{2}} 2x \sin^{-1}(x^2) dx &= [x^2 \sin^{-1}(x^2)]_0^{1/\sqrt{2}} - \int_0^{1/\sqrt{2}} x^2 \cdot \frac{2x dx}{\sqrt{1-x^4}} = \left(\frac{1}{2} \right) \left(\frac{\pi}{6} \right) + \int_0^{1/\sqrt{2}} \frac{d(1-x^4)}{2\sqrt{1-x^4}} \\
 &= \frac{\pi}{12} + \left[\sqrt{1-x^4} \right]_0^{1/\sqrt{2}} = \frac{\pi}{12} + \sqrt{\frac{3}{4}} - 1 = \frac{\pi + 6\sqrt{3} - 12}{12}
 \end{aligned}$$

$$21. I = \int e^\theta \sin \theta d\theta; [u = \sin \theta, du = \cos \theta d\theta; dv = e^\theta d\theta, v = e^\theta] \Rightarrow I = e^\theta \sin \theta - \int e^\theta \cos \theta d\theta;$$

$$[u = \cos \theta, du = -\sin \theta d\theta; dv = e^\theta d\theta, v = e^\theta] \Rightarrow I = e^\theta \sin \theta - \left(e^\theta \cos \theta + \int e^\theta \sin \theta d\theta \right)$$

$$= e^\theta \sin \theta - e^\theta \cos \theta - I + C' \Rightarrow 2I = (e^\theta \sin \theta - e^\theta \cos \theta) + C' \Rightarrow I = \frac{1}{2} (e^\theta \sin \theta - e^\theta \cos \theta) + C, \text{ where } C = \frac{C'}{2} \text{ is another arbitrary constant}$$

$$\begin{aligned}
22. \quad I &= \int e^{-y} \cos y \, dy; [u = \cos y, du = -\sin y \, dy; dv = e^{-y} \, dy, v = -e^{-y}] \\
&\Rightarrow I = -e^{-y} \cos y - \int (-e^{-y})(-\sin y) \, dy = -e^{-y} \cos y - \int e^{-y} \sin y \, dy; [u = \sin y, du = \cos y \, dy; \\
dv &= e^{-y} \, dy, v = -e^{-y}] \Rightarrow I = -e^{-y} \cos y - \left(-e^{-y} \sin y - \int (-e^{-y}) \cos y \, dy \right) = -e^{-y} \cos y + e^{-y} \sin y - I + C' \\
&\Rightarrow 2I = e^{-y}(\sin y - \cos y) + C' \Rightarrow I = \frac{1}{2}(e^{-y} \sin y - e^{-y} \cos y) + C, \text{ where } C = \frac{C'}{2} \text{ is another arbitrary constant}
\end{aligned}$$

$$\begin{aligned}
23. \quad I &= \int e^{2x} \cos 3x \, dx; [u = \cos 3x; du = -3 \sin 3x \, dx, dv = e^{2x} \, dx; v = \frac{1}{2} e^{2x}] \\
&\Rightarrow I = \frac{1}{2} e^{2x} \cos 3x + \frac{3}{2} \int e^{2x} \sin 3x \, dx; [u = \sin 3x, du = 3 \cos 3x \, dx, dv = e^{2x} \, dx; v = \frac{1}{2} e^{2x}] \\
&\Rightarrow I = \frac{1}{2} e^{2x} \cos 3x + \frac{3}{2} \left(\frac{1}{2} e^{2x} \sin 3x - \frac{3}{2} \int e^{2x} \cos 3x \, dx \right) = \frac{1}{2} e^{2x} \cos 3x + \frac{3}{4} e^{2x} \sin 3x - \frac{9}{4} I + C' \\
&\Rightarrow \frac{13}{4} I = \frac{1}{2} e^{2x} \cos 3x + \frac{3}{4} e^{2x} \sin 3x + C' \Rightarrow \frac{e^{2x}}{13} (3 \sin 3x + 2 \cos 3x) + C, \text{ where } C = \frac{4}{13} C'
\end{aligned}$$

$$\begin{aligned}
24. \quad \int e^{-2x} \sin 2x \, dx; [y = 2x] \rightarrow \frac{1}{2} \int e^{-y} \sin y \, dy = I; [u = \sin y, du = \cos y \, dy; dv = e^{-y} \, dy, v = -e^{-y}] \\
&\Rightarrow I = \frac{1}{2} \left(-e^{-y} \sin y + \int e^{-y} \cos y \, dy \right) [u = \cos y, du = -\sin y \, dy; dv = e^{-y} \, dy, v = -e^{-y}] \\
&\Rightarrow I = -\frac{1}{2} e^{-y} \sin y + \frac{1}{2} \left(-e^{-y} \cos y - \int (-e^{-y})(-\sin y) \, dy \right) = -\frac{1}{2} e^{-y}(\sin y + \cos y) - I + C' \\
&\Rightarrow 2I = -\frac{1}{2} e^{-y}(\sin y + \cos y) + C' \Rightarrow I = -\frac{1}{4} e^{-y}(\sin y + \cos y) + C = -\frac{e^{-2x}}{4} (\sin 2x + \cos 2x) + C, \text{ where } \\
C &= \frac{C'}{2}
\end{aligned}$$

$$\begin{aligned}
25. \quad \int e^{\sqrt{3s+9}} \, ds; \left[\frac{3s+9}{ds} = \frac{2}{3} x \, dx \right] \rightarrow \int e^x \cdot \frac{2}{3} x \, dx = \frac{2}{3} \int x e^x \, dx; [u = x, du = dx; dv = e^x \, dx, v = e^x]; \\
\frac{2}{3} \int x e^x \, dx = \frac{2}{3} \left(x e^x - \int e^x \, dx \right) = \frac{2}{3} (x e^x - e^x) + C = \frac{2}{3} \left(\sqrt{3s+9} e^{\sqrt{3s+9}} - e^{\sqrt{3s+9}} \right) + C
\end{aligned}$$

$$\begin{aligned}
26. \quad u = x, du = dx; dv = \sqrt{1-x} \, dx, v = -\frac{2}{3} \sqrt{(1-x)^3}; \\
\int_0^1 x \sqrt{1-x} \, dx = \left[-\frac{2}{3} \sqrt{(1-x)^3} x \right]_0^1 + \frac{2}{3} \int_0^1 \sqrt{(1-x)^3} \, dx = \frac{2}{3} \left[-\frac{2}{5} (1-x)^{5/2} \right]_0^1 = \frac{4}{15}
\end{aligned}$$

$$\begin{aligned}
27. \quad u = x, du = dx; dv = \tan^2 x \, dx, v = \int \tan^2 x \, dx = \int \frac{\sin^2 x}{\cos^2 x} \, dx = \int \frac{1-\cos^2 x}{\cos^2 x} \, dx = \int \frac{dx}{\cos^2 x} - \int dx \\
= \tan x - x; \int_0^{\pi/3} x \tan^2 x \, dx = [x(\tan x - x)]_0^{\pi/3} - \int_0^{\pi/3} (\tan x - x) \, dx = \frac{\pi}{3} \left(\sqrt{3} - \frac{\pi}{3} \right) + \left[\ln |\cos x| + \frac{x^2}{2} \right]_0^{\pi/3} \\
= \frac{\pi}{3} \left(\sqrt{3} - \frac{\pi}{3} \right) + \ln \frac{1}{2} + \frac{\pi^2}{18} = \frac{\pi\sqrt{3}}{3} - \ln 2 - \frac{\pi^2}{18}
\end{aligned}$$

$$\begin{aligned}
28. \quad u = \ln(x+x^2), du = \frac{(2x+1)dx}{x+x^2}; dv = dx, v = x; \int \ln(x+x^2) \, dx = x \ln(x+x^2) - \int \frac{2x+1}{x(x+1)} \cdot x \, dx \\
= x \ln(x+x^2) - \int \frac{(2x+1)dx}{x+1} = x \ln(x+x^2) - \int \frac{2(x+1)-1}{x+1} \, dx = x \ln(x+x^2) - 2x + \ln|x+1| + C
\end{aligned}$$

$$\begin{aligned}
29. \quad \int \sin(\ln x) \, dx; \left[\begin{array}{l} u = \ln x \\ du = \frac{1}{x} \, dx \\ dx = e^u \, du \end{array} \right] \rightarrow \int (\sin u) e^u \, du. \text{ From Exercise 21, } \int (\sin u) e^u \, du = e^u \left(\frac{\sin u - \cos u}{2} \right) + C \\
= \frac{1}{2} [-x \cos(\ln x) + x \sin(\ln x)] + C
\end{aligned}$$

$$30. \int z(\ln z)^2 dz; \left[\begin{array}{l} u = \ln z \\ du = \frac{1}{z} dz \\ dz = e^u du \\ e^{2u} \end{array} \right] \rightarrow \int e^u \cdot u^2 \cdot e^u du = \int e^{2u} \cdot u^2 du;$$

$$u^2 \xrightarrow{(+)} \frac{1}{2} e^{2u}$$

$$2u \xrightarrow{(-)} \frac{1}{4} e^{2u}$$

$$2 \xrightarrow{(+)} \frac{1}{8} e^{2u}$$

0

$$\int u^2 e^{2u} du = \frac{u^2}{2} e^{2u} - \frac{u}{2} e^{2u} + \frac{1}{4} e^{2u} + C = \frac{e^{2u}}{4} [2u^2 - 2u + 1] + C$$

$$= \frac{z^2}{4} [2(\ln z)^2 - 2 \ln z + 1] + C$$

31. (a) $u = x, du = dx; dv = \sin x dx, v = -\cos x;$

$$S_1 = \int_0^\pi x \sin x dx = [-x \cos x]_0^\pi + \int_0^\pi \cos x dx = \pi + [\sin x]_0^\pi = \pi$$

(b) $S_2 = -\int_\pi^{2\pi} x \sin x dx = -[-x \cos x]_\pi^{2\pi} + \int_\pi^{2\pi} \cos x dx = -[-3\pi + [\sin x]_\pi^{2\pi}] = 3\pi$

(c) $S_3 = \int_{2\pi}^{3\pi} x \sin x dx = [-x \cos x]_{2\pi}^{3\pi} + \int_{2\pi}^{3\pi} \cos x dx = 5\pi + [\sin x]_{2\pi}^{3\pi} = 5\pi$

(d) $S_{n+1} = (-1)^{n+1} \int_{n\pi}^{(n+1)\pi} x \sin x dx = (-1)^{n+1} [-x \cos x]_{n\pi}^{(n+1)\pi} + [\sin x]_{n\pi}^{(n+1)\pi}$
 $= (-1)^{n+1} [-(n+1)\pi(-1)^n + n\pi(-1)^{n+1}] + 0 = (2n+1)\pi$

32. (a) $u = x, du = dx; dv = \cos x dx, v = \sin x;$

$$S_1 = -\int_{\pi/2}^{3\pi/2} x \cos x dx = -[x \sin x]_{\pi/2}^{3\pi/2} - \int_{\pi/2}^{3\pi/2} \sin x dx = -(-\frac{3\pi}{2} - \frac{\pi}{2}) - [\cos x]_{\pi/2}^{3\pi/2} = 2\pi$$

(b) $S_2 = \int_{3\pi/2}^{5\pi/2} x \cos x dx = [x \sin x]_{3\pi/2}^{5\pi/2} - \int_{3\pi/2}^{5\pi/2} \sin x dx = [\frac{5\pi}{2} - (-\frac{3\pi}{2})] - [\cos x]_{3\pi/2}^{5\pi/2} = 4\pi$

(c) $S_3 = -\int_{5\pi/2}^{7\pi/2} x \cos x dx = -[x \sin x]_{5\pi/2}^{7\pi/2} - \int_{5\pi/2}^{7\pi/2} \sin x dx = -(-\frac{7\pi}{2} - \frac{5\pi}{2}) - [\cos x]_{5\pi/2}^{7\pi/2} = 6\pi$

(d) $S_n = (-1)^n \int_{(2n-1)\pi/2}^{(2n+1)\pi/2} x \cos x dx = (-1)^n [x \sin x]_{(2n-1)\pi/2}^{(2n+1)\pi/2} - \int_{(2n-1)\pi/2}^{(2n+1)\pi/2} \sin x dx$
 $= (-1)^n \left[\frac{(2n+1)\pi}{2} (-1)^n - \frac{(2n-1)\pi}{2} (-1)^{n-1} \right] - [\cos x]_{(2n-1)\pi/2}^{(2n+1)\pi/2} = \frac{1}{2} (2n\pi + \pi + 2n\pi - \pi) = 2n\pi$

33. $V = \int_0^{\ln 2} 2\pi(\ln 2 - x) e^x dx = 2\pi \ln 2 \int_0^{\ln 2} e^x dx - 2\pi \int_0^{\ln 2} x e^x dx$
 $= (2\pi \ln 2) [e^x]_0^{\ln 2} - 2\pi \left([x e^x]_0^{\ln 2} - \int_0^{\ln 2} e^x dx \right)$
 $= 2\pi \ln 2 - 2\pi (2 \ln 2 - [e^x]_0^{\ln 2}) = -2\pi \ln 2 + 2\pi = 2\pi(1 - \ln 2)$

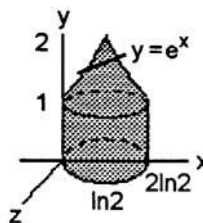

34. (a) $V = \int_0^1 2\pi x e^{-x} dx = 2\pi \left([-x e^{-x}]_0^1 + \int_0^1 e^{-x} dx \right)$
 $= 2\pi \left(-\frac{1}{e} + [-e^{-x}]_0^1 \right) = 2\pi \left(-\frac{1}{e} - \frac{1}{e} + 1 \right)$
 $= 2\pi - \frac{4\pi}{e}$

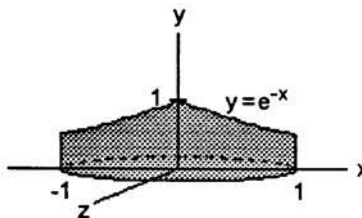

(b) $V = \int_0^1 2\pi(1-x)e^{-x} dx$; $u = 1-x$, $du = -dx$; $dv = e^{-x} dx$,
 $v = -e^{-x}$; $V = 2\pi \left[[(1-x)(-e^{-x})]_0^1 - \int_0^1 e^{-x} dx \right]$
 $= 2\pi \left[[0 - 1(-1)] + [e^{-x}]_0^1 \right] = 2\pi \left(1 + \frac{1}{e} - 1 \right) = \frac{2\pi}{e}$

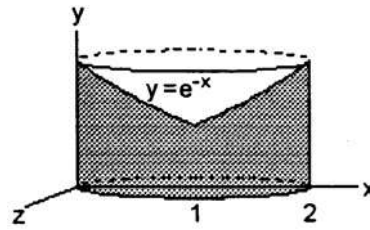

35. (a) $V = \int_0^{\pi/2} 2\pi x \cos x dx = 2\pi \left([x \sin x]_0^{\pi/2} - \int_0^{\pi/2} \sin x dx \right)$
 $= 2\pi \left(\frac{\pi}{2} + [\cos x]_0^{\pi/2} \right) = 2\pi \left(\frac{\pi}{2} + 0 - 1 \right) = \pi(\pi - 2)$

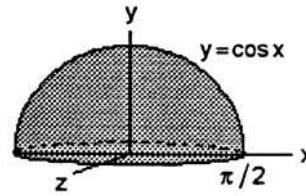

(b) $V = \int_0^{\pi/2} 2\pi \left(\frac{\pi}{2} - x \right) \cos x dx$; $u = \frac{\pi}{2} - x$, $du = -dx$; $dv = \cos x dx$, $v = \sin x$;
 $V = 2\pi \left[\left(\frac{\pi}{2} - x \right) \sin x \right]_0^{\pi/2} + 2\pi \int_0^{\pi/2} \sin x dx = 0 + 2\pi [-\cos x]_0^{\pi/2} = 2\pi(0 + 1) = 2\pi$

36. (a) $V = \int_0^{\pi} 2\pi x(x \sin x) dx$;
 $\sin x$

$x^2 \xrightarrow{(+)} -\cos x$

$2x \xrightarrow{(-)} -\sin x$

$2 \xrightarrow{(+)} \cos x$

$0 \Rightarrow V = 2\pi \int_0^{\pi} x^2 \sin x dx = 2\pi [-x^2 \cos x + 2x \sin x + 2 \cos x]_0^{\pi} = 2\pi (\pi^2 - 4)$

(b) $V = \int_0^{\pi} 2\pi(\pi - x)x \sin x dx = 2\pi^2 \int_0^{\pi} x \sin x dx - 2\pi \int_0^{\pi} x^2 \sin x dx = 2\pi^2 [-x \cos x + \sin x]_0^{\pi} - (2\pi^3 - 8\pi)$
 $= 8\pi$

37. $av(y) = \frac{1}{2\pi} \int_0^{2\pi} 2e^{-t} \cos t dt$
 $= \frac{1}{\pi} \left[e^{-t} \left(\frac{\sin t - \cos t}{2} \right) \right]_0^{2\pi}$
 (see Exercise 22) $\Rightarrow av(y) = \frac{1}{2\pi} (1 - e^{-2\pi})$

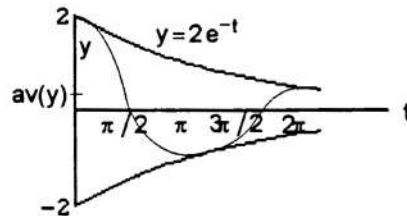

38. $av(y) = \frac{1}{2\pi} \int_0^{2\pi} 4e^{-t} (\sin t - \cos t) dt$
 $= \frac{2}{\pi} \int_0^{2\pi} e^{-t} \sin t dt - \frac{2}{\pi} \int_0^{2\pi} e^{-t} \cos t dt$
 $= \frac{2}{\pi} \left[e^{-t} \left(\frac{-\sin t - \cos t}{2} \right) - e^{-t} \left(\frac{\sin t - \cos t}{2} \right) \right]_0^{2\pi}$
 $= \frac{2}{\pi} [-e^{-t} \sin t]_0^{2\pi} = 0$

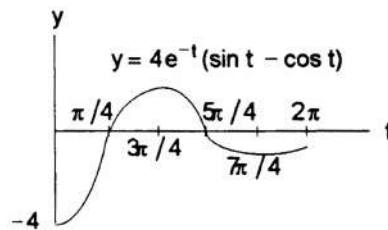

39. $I = \int x^n \cos x dx$; $[u = x^n, du = nx^{n-1} dx; dv = \cos x dx, v = \sin x]$
 $\Rightarrow I = x^n \sin x - \int nx^{n-1} \sin x dx$

$$40. I = \int x^n \sin x \, dx; [u = x^n, du = nx^{n-1} \, dx; dv = \sin x \, dx, v = -\cos x]$$

$$\Rightarrow I = -x^n \cos x + \int nx^{n-1} \cos x \, dx$$

$$41. I = \int x^n e^{ax} \, dx; [u = x^n, du = nx^{n-1} \, dx; dv = e^{ax} \, dx, v = \frac{1}{a} e^{ax}]$$

$$\Rightarrow I = \frac{x^n e^{ax}}{a} - \frac{n}{a} \int x^{n-1} e^{ax} \, dx, a \neq 0$$

$$42. I = \int (\ln x)^n \, dx; [u = (\ln x)^n, du = \frac{n(\ln x)^{n-1}}{x} \, dx; dv = 1 \, dx, v = x]$$

$$\Rightarrow I = x(\ln x)^n - \int n(\ln x)^{n-1} \, dx$$

$$43. \int \sin^{-1} x \, dx = x \sin^{-1} x - \int \sin y \, dy = x \sin^{-1} x + \cos y + C = x \sin^{-1} x + \cos(\sin^{-1} x) + C$$

$$44. \int \tan^{-1} x \, dx = x \tan^{-1} x - \int \tan y \, dy = x \tan^{-1} x + \ln |\cos y| + C = x \tan^{-1} x + \ln |\cos(\tan^{-1} x)| + C$$

$$45. \int \sec^{-1} x \, dx = x \sec^{-1} x - \int \sec y \, dy = x \sec^{-1} x - \ln |\sec y + \tan y| + C$$

$$= x \sec^{-1} x - \ln |\sec(\sec^{-1} x) + \tan(\sec^{-1} x)| + C = x \sec^{-1} x - \ln \left| x + \sqrt{x^2 - 1} \right| + C$$

$$46. \int \log_2 x \, dx = x \log_2 x - \int 2^y \, dy = x \log_2 x - \frac{2^y}{\ln 2} + C = x \log_2 x - \frac{x}{\ln 2} + C$$

$$47. \text{Yes, } \cos^{-1} x \text{ is the angle whose cosine is } x \text{ which implies } \sin(\cos^{-1} x) = \sqrt{1 - x^2}.$$

$$48. \text{Yes, } \tan^{-1} x \text{ is the angle whose tangent is } x \text{ which implies } \sec(\tan^{-1} x) = \sqrt{1 + x^2}.$$

$$49. (a) \int \sinh^{-1} x \, dx = x \sinh^{-1} x - \int \sinh y \, dy = x \sinh^{-1} x - \cosh y + C = x \sinh^{-1} x - \cosh(\sinh^{-1} x) + C;$$

$$\text{check: } d[x \sinh^{-1} x - \cosh(\sinh^{-1} x) + C] = \left[\sinh^{-1} x + \frac{x}{\sqrt{1+x^2}} - \sinh(\sinh^{-1} x) \frac{1}{\sqrt{1+x^2}} \right] dx$$

$$= \sinh^{-1} x \, dx$$

$$(b) \int \sinh^{-1} x \, dx = x \sinh^{-1} x - \int x \left(\frac{1}{\sqrt{1+x^2}} \right) dx = x \sinh^{-1} x - \frac{1}{2} \int (1+x^2)^{-1/2} 2x \, dx$$

$$= x \sinh^{-1} x - (1+x^2)^{1/2} + C$$

$$\text{check: } d[x \sinh^{-1} x - (1+x^2)^{1/2} + C] = \left[\sinh^{-1} x + \frac{x}{\sqrt{1+x^2}} - \frac{x}{\sqrt{1+x^2}} \right] dx = \sinh^{-1} x \, dx$$

$$50. (a) \int \tanh^{-1} x \, dx = x \tanh^{-1} x - \int \tanh y \, dy = x \tanh^{-1} x - \ln |\cosh y| + C$$

$$= x \tanh^{-1} x - \ln |\cosh(\tanh^{-1} x)| + C;$$

$$\text{check: } d[x \tanh^{-1} x - \ln |\cosh(\tanh^{-1} x)| + C] = \left[\tanh^{-1} x + \frac{x}{1-x^2} - \frac{\sinh(\tanh^{-1} x)}{\cosh(\tanh^{-1} x)} \frac{1}{1-x^2} \right] dx$$

$$= \left[\tanh^{-1} x + \frac{x}{1-x^2} - \frac{x}{1-x^2} \right] dx = \tanh^{-1} x \, dx$$

$$(b) \int \tanh^{-1} x \, dx = x \tanh^{-1} x - \int \frac{x}{1-x^2} \, dx = x \tanh^{-1} x - \frac{1}{2} \int \frac{2x}{1-x^2} \, dx = x \tanh^{-1} x + \frac{1}{2} \ln |1-x^2| + C$$

$$\text{check: } d[x \tanh^{-1} x + \frac{1}{2} \ln |1-x^2| + C] = \left[\tanh^{-1} x + \frac{x}{1-x^2} - \frac{x}{1-x^2} \right] dx = \tanh^{-1} x \, dx$$

8.3 INTEGRATION OF RATIONAL FUNCTIONS BY PARTIAL FRACTIONS

$$1. \frac{5x-13}{(x-3)(x-2)} = \frac{A}{x-3} + \frac{B}{x-2} \Rightarrow 5x-13 = A(x-2) + B(x-3) = (A+B)x - (2A+3B)$$

$$\Rightarrow \left. \begin{aligned} A+B &= 5 \\ 2A+3B &= 13 \end{aligned} \right\} \Rightarrow -B = (10-13) \Rightarrow B=3 \Rightarrow A=2; \text{ thus, } \frac{5x-13}{(x-3)(x-2)} = \frac{2}{x-3} + \frac{3}{x-2}$$

2. $\frac{5x-7}{x^2-3x+2} = \frac{5x-7}{(x-2)(x-1)} = \frac{A}{x-2} + \frac{B}{x-1} \Rightarrow 5x-7 = A(x-1) + B(x-2) = (A+B)x - (A+2B)$
 $\Rightarrow \left. \begin{aligned} A+B &= 5 \\ A+2B &= 7 \end{aligned} \right\} \Rightarrow B=2 \Rightarrow A=3; \text{ thus, } \frac{5x-7}{x^2-3x+2} = \frac{3}{x-2} + \frac{2}{x-1}$
3. $\frac{x+4}{(x+1)^2} = \frac{A}{x+1} + \frac{B}{(x+1)^2} \Rightarrow x+4 = A(x+1) + B = Ax + (A+B) \Rightarrow \left. \begin{aligned} A &= 1 \\ A+B &= 4 \end{aligned} \right\} \Rightarrow A=1 \text{ and } B=3;$
 thus, $\frac{x+4}{(x+1)^2} = \frac{1}{x+1} + \frac{3}{(x+1)^2}$
4. $\frac{2x+2}{x^2-2x+1} = \frac{2x+2}{(x-1)^2} = \frac{A}{x-1} + \frac{B}{(x-1)^2} \Rightarrow 2x+2 = A(x-1) + B = Ax + (-A+B) \Rightarrow \left. \begin{aligned} A &= 2 \\ -A+B &= 2 \end{aligned} \right\}$
 $\Rightarrow A=2 \text{ and } B=4; \text{ thus, } \frac{2x+2}{x^2-2x+1} = \frac{2}{x-1} + \frac{4}{(x-1)^2}$
5. $\frac{z+1}{z^2(z-1)} = \frac{A}{z} + \frac{B}{z-1} + \frac{C}{z^2} \Rightarrow z+1 = Az(z-1) + B(z-1) + Cz^2 \Rightarrow z+1 = (A+C)z^2 + (-A+B)z - B$
 $\left. \begin{aligned} A+C &= 0 \\ -A+B &= 1 \\ -B &= 1 \end{aligned} \right\} \Rightarrow B=-1 \Rightarrow A=-2 \Rightarrow C=2; \text{ thus, } \frac{z+1}{z^2(z-1)} = \frac{-2}{z} + \frac{-1}{z-1} + \frac{2}{z^2}$
6. $\frac{z}{z^3-z^2-6z} = \frac{1}{z^2-z-6} = \frac{1}{(z-3)(z+2)} = \frac{A}{z-3} + \frac{B}{z+2} \Rightarrow 1 = A(z+2) + B(z-3) = (A+B)z + (2A-3B)$
 $\Rightarrow \left. \begin{aligned} A+B &= 0 \\ 2A-3B &= 1 \end{aligned} \right\} \Rightarrow -5B=1 \Rightarrow B=-\frac{1}{5} \Rightarrow A=\frac{1}{5}; \text{ thus, } \frac{z}{z^3-z^2-6z} = \frac{\frac{1}{5}}{z-3} + \frac{-\frac{1}{5}}{z+2}$
7. $\frac{t^2+8}{t^2-5t+6} = 1 + \frac{5t+2}{t^2-5t+6}$ (after long division); $\frac{5t+2}{t^2-5t+6} = \frac{5t+2}{(t-3)(t-2)} = \frac{A}{t-3} + \frac{B}{t-2}$
 $\Rightarrow 5t+2 = A(t-2) + B(t-3) = (A+B)t + (-2A-3B) \Rightarrow \left. \begin{aligned} A+B &= 5 \\ -2A-3B &= 2 \end{aligned} \right\} \Rightarrow -B=(10+2)=12$
 $\Rightarrow B=-12 \Rightarrow A=17; \text{ thus, } \frac{t^2+8}{t^2-5t+6} = 1 + \frac{17}{t-3} + \frac{-12}{t-2}$
8. $\frac{t^4+9}{t^4+9t^2} = 1 + \frac{-9t^2+9}{t^4+9t^2} = 1 + \frac{-9t^2+9}{t^2(t^2+9)}$ (after long division); $\frac{-9t^2+9}{t^2(t^2+9)} = \frac{A}{t} + \frac{B}{t^2} + \frac{Ct+D}{t^2+9}$
 $\Rightarrow -9t^2+9 = At(t^2+9) + B(t^2+9) + (Ct+D)t^2 = (A+C)t^3 + (B+D)t^2 + 9At + 9B$
 $\left. \begin{aligned} A+C &= 0 \\ B+D &= -9 \\ 9A &= 0 \\ 9B &= 9 \end{aligned} \right\} \Rightarrow A=0 \Rightarrow C=0; B=1 \Rightarrow D=-10; \text{ thus, } \frac{t^4+9}{t^4+9t^2} = 1 + \frac{1}{t^2} + \frac{-10}{t^2+9}$
9. $\frac{1}{1-x^2} = \frac{A}{1-x} + \frac{B}{1+x} \Rightarrow 1 = A(1+x) + B(1-x); x=1 \Rightarrow A=\frac{1}{2}; x=-1 \Rightarrow B=\frac{1}{2};$
 $\int \frac{dx}{1-x^2} = \frac{1}{2} \int \frac{dx}{1-x} + \frac{1}{2} \int \frac{dx}{1+x} = \frac{1}{2} [\ln|1+x| - \ln|1-x|] + C$
10. $\frac{1}{x^2+2x} = \frac{A}{x} + \frac{B}{x+2} \Rightarrow 1 = A(x+2) + Bx; x=0 \Rightarrow A=\frac{1}{2}; x=-2 \Rightarrow B=-\frac{1}{2};$
 $\int \frac{dx}{x^2+2x} = \frac{1}{2} \int \frac{dx}{x} - \frac{1}{2} \int \frac{dx}{x+2} = \frac{1}{2} [\ln|x| - \ln|x+2|] + C$
11. $\frac{x+4}{x^2+5x-6} = \frac{A}{x+6} + \frac{B}{x-1} \Rightarrow x+4 = A(x-1) + B(x+6); x=1 \Rightarrow B=\frac{5}{7}; x=-6 \Rightarrow A=\frac{-2}{7} = \frac{2}{7};$
 $\int \frac{x+4}{x^2+5x-6} dx = \frac{2}{7} \int \frac{dx}{x+6} + \frac{5}{7} \int \frac{dx}{x-1} = \frac{2}{7} \ln|x+6| + \frac{5}{7} \ln|x-1| + C = \frac{1}{7} \ln|(x+6)^2(x-1)^5| + C$
12. $\frac{2x+1}{x^2-7x+12} = \frac{A}{x-4} + \frac{B}{x-3} \Rightarrow 2x+1 = A(x-3) + B(x-4); x=3 \Rightarrow B=\frac{7}{-1} = -7; x=4 \Rightarrow A=\frac{9}{1} = 9;$
 $\int \frac{2x+1}{x^2-7x+12} dx = 9 \int \frac{dx}{x-4} - 7 \int \frac{dx}{x-3} = 9 \ln|x-4| - 7 \ln|x-3| + C = \ln \left| \frac{(x-4)^9}{(x-3)^7} \right| + C$

510 Chapter 8 Techniques of Integration

13. $\frac{y}{y^2-2y-3} = \frac{A}{y-3} + \frac{B}{y+1} \Rightarrow y = A(y+1) + B(y-3); y = -1 \Rightarrow B = \frac{-1}{-4} = \frac{1}{4}; y = 3 \Rightarrow A = \frac{3}{4};$
 $\int_4^8 \frac{y \, dy}{y^2-2y-3} = \frac{3}{4} \int_4^8 \frac{dy}{y-3} + \frac{1}{4} \int_4^8 \frac{dy}{y+1} = \left[\frac{3}{4} \ln |y-3| + \frac{1}{4} \ln |y+1| \right]_4^8 = \left(\frac{3}{4} \ln 5 + \frac{1}{4} \ln 9 \right) - \left(\frac{3}{4} \ln 1 + \frac{1}{4} \ln 5 \right)$
 $= \frac{1}{2} \ln 5 + \frac{1}{2} \ln 3 = \frac{\ln 15}{2}$
14. $\frac{y+4}{y^2+y} = \frac{A}{y} + \frac{B}{y+1} \Rightarrow y+4 = A(y+1) + By; y = 0 \Rightarrow A = 4; y = -1 \Rightarrow B = \frac{3}{-1} = -3;$
 $\int_{1/2}^1 \frac{y+4}{y^2+y} \, dy = 4 \int_{1/2}^1 \frac{dy}{y} - 3 \int_{1/2}^1 \frac{dy}{y+1} = [4 \ln |y| - 3 \ln |y+1|]_{1/2}^1 = (4 \ln 1 - 3 \ln 2) - (4 \ln \frac{1}{2} - 3 \ln \frac{3}{2})$
 $= \ln \frac{1}{8} - \ln \frac{1}{16} + \ln \frac{27}{8} = \ln \left(\frac{27}{8} \cdot \frac{1}{8} \cdot 16 \right) = \ln \frac{27}{4}$
15. $\frac{1}{t^3+t^2-2t} = \frac{A}{t} + \frac{B}{t+2} + \frac{C}{t-1} \Rightarrow 1 = A(t+2)(t-1) + Bt(t-1) + Ct(t+2); t = 0 \Rightarrow A = -\frac{1}{2}; t = -2$
 $\Rightarrow B = \frac{1}{6}; t = 1 \Rightarrow C = \frac{1}{3}; \int \frac{dt}{t^3+t^2-2t} = -\frac{1}{2} \int \frac{dt}{t} + \frac{1}{6} \int \frac{dt}{t+2} + \frac{1}{3} \int \frac{dt}{t-1}$
 $= -\frac{1}{2} \ln |t| + \frac{1}{6} \ln |t+2| + \frac{1}{3} \ln |t-1| + C$
16. $\frac{x+3}{2x^3-8x} = \frac{A}{x} + \frac{B}{x+2} + \frac{C}{x-2} \Rightarrow \frac{1}{2}(x+3) = A(x+2)(x-2) + Bx(x-2) + Cx(x+2); x = 0 \Rightarrow A = \frac{3}{-8}; x = -2$
 $\Rightarrow B = \frac{1}{16}; x = 2 \Rightarrow C = \frac{5}{16}; \int \frac{x+3}{2x^3-8x} \, dx = -\frac{3}{8} \int \frac{dx}{x} + \frac{1}{16} \int \frac{dx}{x+2} + \frac{5}{16} \int \frac{dx}{x-2}$
 $= -\frac{3}{8} \ln |x| + \frac{1}{16} \ln |x+2| + \frac{5}{16} \ln |x-2| + C = \frac{1}{16} \ln \left| \frac{(x-2)^5(x+2)}{x^6} \right| + C$
17. $\frac{x^3}{x^2+2x+1} = (x-2) + \frac{3x+2}{(x+1)^2}$ (after long division); $\frac{3x+2}{(x+1)^2} = \frac{A}{x+1} + \frac{B}{(x+1)^2} \Rightarrow 3x+2 = A(x+1) + B$
 $= Ax + (A+B) \Rightarrow A = 3, A+B = 2 \Rightarrow A = 3, B = -1; \int_0^1 \frac{x^3 \, dx}{x^2+2x+1}$
 $= \int_0^1 (x-2) \, dx + 3 \int_0^1 \frac{dx}{x+1} - \int_0^1 \frac{dx}{(x+1)^2} = \left[\frac{x^2}{2} - 2x + 3 \ln |x+1| + \frac{1}{x+1} \right]_0^1$
 $= \left(\frac{1}{2} - 2 + 3 \ln 2 + \frac{1}{2} \right) - (1) = 3 \ln 2 - 2$
18. $\frac{x^3}{x^2-2x+1} = (x+2) + \frac{3x-2}{(x-1)^2}$ (after long division); $\frac{3x-2}{(x-1)^2} = \frac{A}{x-1} + \frac{B}{(x-1)^2} \Rightarrow 3x-2 = A(x-1) + B$
 $= Ax + (-A+B) \Rightarrow A = 3, -A+B = -2 \Rightarrow A = 3, B = 1; \int_{-1}^0 \frac{x^3 \, dx}{x^2-2x+1}$
 $= \int_{-1}^0 (x+2) \, dx + 3 \int_{-1}^0 \frac{dx}{x-1} + \int_{-1}^0 \frac{dx}{(x-1)^2} = \left[\frac{x^2}{2} + 2x + 3 \ln |x-1| - \frac{1}{x-1} \right]_{-1}^0$
 $= \left(0 + 0 + 3 \ln 1 - \frac{1}{(-1)} \right) - \left(\frac{1}{2} - 2 + 3 \ln 2 - \frac{1}{(-2)} \right) = 2 - 3 \ln 2$
19. $\frac{1}{(x^2-1)^2} = \frac{A}{x+1} + \frac{B}{x-1} + \frac{C}{(x+1)^2} + \frac{D}{(x-1)^2} \Rightarrow 1 = A(x+1)(x-1)^2 + B(x-1)(x+1)^2 + C(x-1)^2 + D(x+1)^2;$
 $x = -1 \Rightarrow C = \frac{1}{4}; x = 1 \Rightarrow D = \frac{1}{4};$ coefficient of $x^3 = A + B \Rightarrow A + B = 0;$ constant $= A - B + C + D$
 $\Rightarrow A - B + C + D = 1 \Rightarrow A - B = \frac{1}{2};$ thus, $A = \frac{1}{4} \Rightarrow B = -\frac{1}{4}; \int \frac{dx}{(x^2-1)^2}$
 $= \frac{1}{4} \int \frac{dx}{x+1} - \frac{1}{4} \int \frac{dx}{x-1} + \frac{1}{4} \int \frac{dx}{(x+1)^2} + \frac{1}{4} \int \frac{dx}{(x-1)^2} = \frac{1}{4} \ln \left| \frac{x+1}{x-1} \right| - \frac{x}{2(x^2-1)} + C$
20. $\frac{x^2}{(x-1)(x^2+2x+1)} = \frac{A}{x-1} + \frac{B}{x+1} + \frac{C}{(x+1)^2} \Rightarrow x^2 = A(x+1)^2 + B(x-1)(x+1) + C(x-1); x = -1$
 $\Rightarrow C = -\frac{1}{2}; x = 1 \Rightarrow A = \frac{1}{4};$ coefficient of $x^2 = A + B \Rightarrow A + B = 1 \Rightarrow B = \frac{3}{4}; \int \frac{x^2 \, dx}{(x-1)(x^2+2x+1)}$
 $= \frac{1}{4} \int \frac{dx}{x-1} + \frac{3}{4} \int \frac{dx}{x+1} - \frac{1}{2} \int \frac{dx}{(x+1)^2} = \frac{1}{4} \ln |x-1| + \frac{3}{4} \ln |x+1| + \frac{1}{2(x+1)} + C$
 $= \frac{\ln |(x-1)(x+1)^3|}{4} + \frac{1}{2(x+1)} + C$
21. $\frac{1}{(x+1)(x^2+1)} = \frac{A}{x+1} + \frac{Bx+C}{x^2+1} \Rightarrow 1 = A(x^2+1) + (Bx+C)(x+1); x = -1 \Rightarrow A = \frac{1}{2};$ coefficient of x^2
 $= A + B \Rightarrow A + B = 0 \Rightarrow B = -\frac{1}{2};$ constant $= A + C \Rightarrow A + C = 1 \Rightarrow C = \frac{1}{2}; \int_0^1 \frac{dx}{(x+1)(x^2+1)}$

$$\begin{aligned}
 &= \frac{1}{2} \int_0^1 \frac{dx}{x+1} + \frac{1}{2} \int_0^1 \frac{(-x+1)}{x^2+1} dx = \left[\frac{1}{2} \ln|x+1| - \frac{1}{4} \ln(x^2+1) + \frac{1}{2} \tan^{-1} x \right]_0^1 \\
 &= \left(\frac{1}{2} \ln 2 - \frac{1}{4} \ln 2 + \frac{1}{2} \tan^{-1} 1 \right) - \left(\frac{1}{2} \ln 1 - \frac{1}{4} \ln 1 + \frac{1}{2} \tan^{-1} 0 \right) = \frac{1}{4} \ln 2 + \frac{1}{2} \left(\frac{\pi}{4} \right) = \frac{(\pi + 2 \ln 2)}{8}
 \end{aligned}$$

22. $\frac{3t^2+t+4}{t^3+t} = \frac{A}{t} + \frac{Bt+C}{t^2+1} \Rightarrow 3t^2+t+4 = A(t^2+1) + (Bt+C)t; t=0 \Rightarrow A=4$; coefficient of t^2
 $= A+B \Rightarrow A+B=3 \Rightarrow B=-1$; coefficient of $t=C \Rightarrow C=1$; $\int_1^{\sqrt{3}} \frac{3t^2+t+4}{t^3+t} dt$
 $= 4 \int_1^{\sqrt{3}} \frac{dt}{t} + \int_1^{\sqrt{3}} \frac{(-t+1)}{t^2+1} dt = \left[4 \ln|t| - \frac{1}{2} \ln(t^2+1) + \tan^{-1} t \right]_1^{\sqrt{3}}$
 $= \left(4 \ln \sqrt{3} - \frac{1}{2} \ln 4 + \tan^{-1} \sqrt{3} \right) - \left(4 \ln 1 - \frac{1}{2} \ln 2 + \tan^{-1} 1 \right) = 2 \ln 3 - \ln 2 + \frac{\pi}{3} + \frac{1}{2} \ln 2 - \frac{\pi}{4}$
 $= 2 \ln 3 - \frac{1}{2} \ln 2 + \frac{\pi}{12} = \ln \left(\frac{9}{\sqrt{2}} \right) + \frac{\pi}{12}$

23. $\frac{y^2+2y+1}{(y^2+1)^2} = \frac{Ay+B}{y^2+1} + \frac{Cy+D}{(y^2+1)^2} \Rightarrow y^2+2y+1 = (Ay+B)(y^2+1) + Cy+D$
 $= Ay^3 + By^2 + (A+C)y + (B+D) \Rightarrow A=0, B=1; A+C=2 \Rightarrow C=2; B+D=1 \Rightarrow D=0$;
 $\int \frac{y^2+2y+1}{(y^2+1)^2} dy = \int \frac{1}{y^2+1} dy + 2 \int \frac{y}{(y^2+1)^2} dy = \tan^{-1} y - \frac{1}{y^2+1} + C$

24. $\frac{8x^2+8x+2}{(4x^2+1)^2} = \frac{Ax+B}{4x^2+1} + \frac{Cx+D}{(4x^2+1)^2} \Rightarrow 8x^2+8x+2 = (Ax+B)(4x^2+1) + Cx+D$
 $= 4Ax^3 + 4Bx^2 + (A+C)x + (B+D); A=0, B=2; A+C=8 \Rightarrow C=8; B+D=2 \Rightarrow D=0$;
 $\int \frac{8x^2+8x+2}{(4x^2+1)^2} dx = 2 \int \frac{dx}{4x^2+1} + 8 \int \frac{x dx}{(4x^2+1)^2} = \tan^{-1} 2x - \frac{1}{4x^2+1} + C$

25. $\frac{2s+2}{(s^2+1)(s-1)^3} = \frac{As+B}{s^2+1} + \frac{C}{s-1} + \frac{D}{(s-1)^2} + \frac{E}{(s-1)^3} \Rightarrow 2s+2$
 $= (As+B)(s-1)^3 + C(s^2+1)(s-1)^2 + D(s^2+1)(s-1) + E(s^2+1)$
 $= [As^4 + (-3A+B)s^3 + (3A-3B)s^2 + (-A+3B)s - B] + C(s^4 - 2s^3 + 2s^2 - 2s + 1) + D(s^3 - s^2 + s - 1)$
 $+ E(s^2 + 1)$
 $= (A+C)s^4 + (-3A+B-2C+D)s^3 + (3A-3B+2C-D+E)s^2 + (-A+3B-2C+D)s + (-B+C-D+E)$
 $\Rightarrow \left. \begin{array}{l} A + C = 0 \\ -3A + B - 2C + D = 0 \\ 3A - 3B + 2C - D + E = 0 \\ -A + 3B - 2C + D = 2 \\ -B + C - D + E = 2 \end{array} \right\} \text{summing all equations} \Rightarrow 2E = 4 \Rightarrow E = 2$;

summing eqs (2) and (3) $\Rightarrow -2B + 2 = 0 \Rightarrow B = 1$; summing eqs (3) and (4) $\Rightarrow 2A + 2 = 2 \Rightarrow A = 0; C = 0$
 from eq (1); then $-1 + 0 - D + 2 = 2$ from eq (5) $\Rightarrow D = -1$;

$$\int \frac{2s+2}{(s^2+1)(s-1)^3} ds = \int \frac{ds}{s^2+1} - \int \frac{ds}{(s-1)^2} + 2 \int \frac{ds}{(s-1)^3} = -(s-1)^{-2} + (s-1)^{-1} + \tan^{-1} s + C$$

26. $\frac{s^4+81}{s(s^2+9)^2} = \frac{A}{s} + \frac{Bs+C}{s^2+9} + \frac{Ds+E}{(s^2+9)^2} \Rightarrow s^4+81 = A(s^2+9)^2 + (Bs+C)s(s^2+9) + (Ds+E)s$
 $= A(s^4+18s^2+81) + (Bs^4+Cs^3+9Bs^2+9Cs) + Ds^2+Es$
 $= (A+B)s^4 + Cs^3 + (18A+9B+D)s^2 + (9C+E)s + 81A \Rightarrow 81A = 81 \text{ or } A = 1; A+B = 1 \Rightarrow B = 0$;
 $C = 0; 9C+E = 0 \Rightarrow E = 0; 18A+9B+D = 0 \Rightarrow D = -18$; $\int \frac{s^4+81}{s(s^2+9)^2} ds = \int \frac{ds}{s} - 18 \int \frac{s ds}{(s^2+9)^2}$
 $= \ln|s| + \frac{9}{(s^2+9)} + C$

27. $\frac{2\theta^3+5\theta^2+8\theta+4}{(\theta^2+2\theta+2)^2} = \frac{A\theta+B}{\theta^2+2\theta+2} + \frac{C\theta+D}{(\theta^2+2\theta+2)^2} \Rightarrow 2\theta^3+5\theta^2+8\theta+4 = (A\theta+B)(\theta^2+2\theta+2) + C\theta+D$
 $= A\theta^3 + (2A+B)\theta^2 + (2A+2B+C)\theta + (2B+D) \Rightarrow A=2; 2A+B=5 \Rightarrow B=1; 2A+2B+C=8 \Rightarrow C=2$;
 $2B+D=4 \Rightarrow D=2$; $\int \frac{2\theta^3+5\theta^2+8\theta+4}{(\theta^2+2\theta+2)^2} d\theta = \int \frac{2\theta+1}{(\theta^2+2\theta+2)} d\theta + \int \frac{2\theta+2}{(\theta^2+2\theta+2)^2} d\theta$
 $= \int \frac{2\theta+2}{\theta^2+2\theta+2} d\theta - \int \frac{d\theta}{\theta^2+2\theta+2} + \int \frac{d(\theta^2+2\theta+2)}{(\theta^2+2\theta+2)^2} = \int \frac{d(\theta^2+2\theta+2)}{\theta^2+2\theta+2} - \int \frac{d\theta}{(\theta+1)^2+1} - \frac{1}{\theta^2+2\theta+2}$

$$= \frac{-1}{\theta^2 + 2\theta + 2} + \ln(\theta^2 + 2\theta + 2) - \tan^{-1}(\theta + 1) + C$$

$$\begin{aligned} 28. \frac{\theta^4 - 4\theta^3 + 2\theta^2 - 3\theta + 1}{(\theta^2 + 1)^3} &= \frac{A\theta + B}{\theta^2 + 1} + \frac{C\theta + D}{(\theta^2 + 1)^2} + \frac{E\theta + F}{(\theta^2 + 1)^3} \Rightarrow \theta^4 - 4\theta^3 + 2\theta^2 - 3\theta + 1 \\ &= (A\theta + B)(\theta^2 + 1)^2 + (C\theta + D)(\theta^2 + 1) + E\theta + F = (A\theta + B)(\theta^4 + 2\theta^2 + 1) + (C\theta^3 + D\theta^2 + C\theta + D) + E\theta + F \\ &= (A\theta^5 + B\theta^4 + 2A\theta^3 + 2B\theta^2 + A\theta + B) + (C\theta^3 + D\theta^2 + C\theta + D) + E\theta + F \\ &= A\theta^5 + B\theta^4 + (2A + C)\theta^3 + (2B + D)\theta^2 + (A + C + E)\theta + (B + D + F) \Rightarrow A = 0; B = 1; 2A + C = -4 \\ &\Rightarrow C = -4; 2B + D = 2 \Rightarrow D = 0; A + C + E = -3 \Rightarrow E = 1; B + D + F = 1 \Rightarrow F = 0; \\ \int \frac{\theta^4 - 4\theta^3 + 2\theta^2 - 3\theta + 1}{(\theta^2 + 1)^3} d\theta &= \int \frac{d\theta}{\theta^2 + 1} - 4 \int \frac{\theta d\theta}{(\theta^2 + 1)^2} + \int \frac{\theta d\theta}{(\theta^2 + 1)^3} = \tan^{-1} \theta + 2(\theta^2 + 1)^{-1} - \frac{1}{4}(\theta^2 + 1)^{-2} + C \end{aligned}$$

$$\begin{aligned} 29. \frac{2x^3 - 2x^2 + 1}{x^2 - x} &= 2x + \frac{1}{x^2 - x} = 2x + \frac{1}{x(x-1)}; \frac{1}{x(x-1)} = \frac{A}{x} + \frac{B}{x-1} \Rightarrow 1 = A(x-1) + Bx; x = 0 \Rightarrow A = -1; \\ x = 1 &\Rightarrow B = 1; \int \frac{2x^3 - 2x^2 + 1}{x^2 - x} = \int 2x dx - \int \frac{dx}{x} + \int \frac{dx}{x-1} = x^2 - \ln|x| + \ln|x-1| + C = x^2 + \ln\left|\frac{x-1}{x}\right| + C \end{aligned}$$

$$\begin{aligned} 30. \frac{x^4}{x^2 - 1} &= (x^2 + 1) + \frac{1}{x^2 - 1} = (x^2 + 1) + \frac{1}{(x+1)(x-1)}; \frac{1}{(x+1)(x-1)} = \frac{A}{x+1} + \frac{B}{x-1} \Rightarrow 1 = A(x-1) + B(x+1); \\ x = -1 &\Rightarrow A = -\frac{1}{2}; x = 1 \Rightarrow B = \frac{1}{2}; \int \frac{x^4}{x^2 - 1} dx = \int (x^2 + 1) dx - \frac{1}{2} \int \frac{dx}{x+1} + \frac{1}{2} \int \frac{dx}{x-1} \\ &= \frac{1}{3}x^3 + x - \frac{1}{2} \ln|x+1| + \frac{1}{2} \ln|x-1| + C = \frac{x^3}{3} + x + \frac{1}{2} \ln\left|\frac{x-1}{x+1}\right| + C \end{aligned}$$

$$\begin{aligned} 31. \frac{9x^3 - 3x + 1}{x^3 - x^2} &= 9 + \frac{9x^2 - 3x + 1}{x^2(x-1)} \text{ (after long division); } \frac{9x^2 - 3x + 1}{x^2(x-1)} = \frac{A}{x} + \frac{B}{x^2} + \frac{C}{x-1} \\ &\Rightarrow 9x^2 - 3x + 1 = Ax(x-1) + B(x-1) + Cx^2; x = 1 \Rightarrow C = 7; x = 0 \Rightarrow B = -1; A + C = 9 \Rightarrow A = 2; \\ \int \frac{9x^3 - 3x + 1}{x^3 - x^2} dx &= \int 9 dx + 2 \int \frac{dx}{x} - \int \frac{dx}{x^2} + 7 \int \frac{dx}{x-1} = 9x + 2 \ln|x| + \frac{1}{x} + 7 \ln|x-1| + C \end{aligned}$$

$$\begin{aligned} 32. \frac{16x^3}{4x^2 - 4x + 1} &= (4x + 4) + \frac{12x - 4}{4x^2 - 4x + 1}; \frac{12x - 4}{(2x-1)^2} = \frac{A}{2x-1} + \frac{B}{(2x-1)^2} \Rightarrow 12x - 4 = A(2x-1) + B \\ &\Rightarrow A = 6; -A + B = -4 \Rightarrow B = 2; \int \frac{16x^3}{4x^2 - 4x + 1} dx = 4 \int (x+1) dx + 6 \int \frac{dx}{2x-1} + 2 \int \frac{dx}{(2x-1)^2} \\ &= 2(x+1)^2 + 3 \ln|2x-1| - \frac{1}{2x-1} + C_1 = 2x^2 + 4x + 3 \ln|2x-1| - (2x-1)^{-1} + C, \text{ where } C = 2 + C_1 \end{aligned}$$

$$\begin{aligned} 33. \frac{y^4 + y^2 - 1}{y^3 + y} &= y - \frac{1}{y(y^2 + 1)}; \frac{1}{y(y^2 + 1)} = \frac{A}{y} + \frac{By + C}{y^2 + 1} \Rightarrow 1 = A(y^2 + 1) + (By + C)y = (A + B)y^2 + Cy + A \\ &\Rightarrow A = 1; A + B = 0 \Rightarrow B = -1; C = 0; \int \frac{y^4 + y^2 - 1}{y^3 + y} dy = \int y dy - \int \frac{dy}{y} + \int \frac{y dy}{y^2 + 1} \\ &= \frac{y^2}{2} - \ln|y| + \frac{1}{2} \ln(1 + y^2) + C \end{aligned}$$

$$\begin{aligned} 34. \frac{2y^4}{y^3 - y^2 + y - 1} &= 2y + 2 + \frac{2}{y^3 - y^2 + y - 1}; \frac{2}{y^3 - y^2 + y - 1} = \frac{2}{(y^2 + 1)(y - 1)} = \frac{A}{y-1} + \frac{By + C}{y^2 + 1} \\ &\Rightarrow 2 = A(y^2 + 1) + (By + C)(y - 1) = (Ay^2 + A) + (By^2 + Cy - By - C) = (A + B)y^2 + (-B + C)y + (A - C) \\ &\Rightarrow A + B = 0, -B + C = 0 \text{ or } C = B, A - C = A - B = 2 \Rightarrow A = 1, B = -1, C = -1; \\ \int \frac{2y^4}{y^3 - y^2 + y - 1} dy &= 2 \int (y + 1) dy + \int \frac{dy}{y-1} - \int \frac{y}{y^2 + 1} dy - \int \frac{dy}{y^2 + 1} \\ &= (y + 1)^2 + \ln|y - 1| - \frac{1}{2} \ln(y^2 + 1) - \tan^{-1} y + C_1 = y^2 + 2y + \ln|y - 1| - \frac{1}{2} \ln(y^2 + 1) - \tan^{-1} y + C, \\ &\text{where } C = C_1 + 1 \end{aligned}$$

$$35. \int \frac{e^t dt}{e^{2t} + 3e^t + 2} = [e^t = y] \int \frac{dy}{y^2 + 3y + 2} = \int \frac{dy}{y+1} - \int \frac{dy}{y+2} = \ln\left|\frac{y+1}{y+2}\right| + C = \ln\left(\frac{e^t + 1}{e^t + 2}\right) + C$$

$$\begin{aligned} 36. \int \frac{e^{4t} + 2e^{2t} - e^t}{e^{2t} + 1} dt &= \int \frac{e^{3t} + 2e^t - 1}{e^{2t} + 1} e^t dt; \left[\begin{array}{l} y = e^t \\ dy = e^t dt \end{array} \right] \rightarrow \int \frac{y^3 + 2y - 1}{y^2 + 1} dy = \int \left(y + \frac{y-1}{y^2 + 1} \right) dy = \frac{y^2}{2} + \int \frac{y}{y^2 + 1} dy - \int \frac{dy}{y^2 + 1} \\ &= \frac{y^2}{2} + \frac{1}{2} \ln(y^2 + 1) - \tan^{-1} y + C = \frac{1}{2} e^{2t} + \frac{1}{2} \ln(e^{2t} + 1) - \tan^{-1}(e^t) + C \end{aligned}$$

$$37. \int \frac{\cos y \, dy}{\sin^2 y + \sin y - 6}; [\sin y = t, \cos y \, dy = dt] \rightarrow \int \frac{dy}{t^2 + t - 6} = \frac{1}{5} \int \left(\frac{1}{t-2} - \frac{1}{t+3} \right) dt = \frac{1}{5} \ln \left| \frac{t-2}{t+3} \right| + C$$

$$= \frac{1}{5} \ln \left| \frac{\sin y - 2}{\sin y + 3} \right| + C$$

$$38. \int \frac{\sin \theta \, d\theta}{\cos^2 \theta + \cos \theta - 2}; [\cos \theta = y] \rightarrow -\int \frac{dy}{y^2 + y - 2} = \frac{1}{3} \int \frac{dy}{y+2} - \frac{1}{3} \int \frac{dy}{y-1} = \frac{1}{3} \ln \left| \frac{y+2}{y-1} \right| + C = \frac{1}{3} \ln \left| \frac{\cos \theta + 2}{\cos \theta - 1} \right| + C$$

$$= \frac{1}{3} \ln \left| \frac{2 + \cos \theta}{1 - \cos \theta} \right| + C = -\frac{1}{3} \ln \left| \frac{\cos \theta - 1}{\cos \theta + 2} \right| + C$$

$$39. \int \frac{(x-2)^2 \tan^{-1}(2x) - 12x^3 - 3x}{(4x^2+1)(x-2)^2} dx = \int \frac{\tan^{-1}(2x)}{4x^2+1} dx - 3 \int \frac{x}{(x-2)^2} dx$$

$$= \frac{1}{2} \int \tan^{-1}(2x) d(\tan^{-1}(2x)) - 3 \int \frac{dx}{x-2} - 6 \int \frac{dx}{(x-2)^2} = \frac{(\tan^{-1} 2x)^2}{4} - 3 \ln |x-2| + \frac{6}{x-2} + C$$

$$40. \int \frac{(x+1)^2 \tan^{-1}(3x) + 9x^3 + x}{(9x^2+1)(x+1)^2} dx = \int \frac{\tan^{-1}(3x)}{9x^2+1} dx + \int \frac{x}{(x+1)^2} dx$$

$$= \frac{1}{3} \int \tan^{-1}(3x) d(\tan^{-1}(3x)) + \int \frac{dx}{x+1} - \int \frac{dx}{(x+1)^2} = \frac{(\tan^{-1} 3x)^2}{6} + \ln |x+1| + \frac{1}{x+1} + C$$

$$41. (t^2 - 3t + 2) \frac{dx}{dt} = 1; x = \int \frac{dt}{t^2 - 3t + 2} = \int \frac{dt}{t-2} - \int \frac{dt}{t-1} = \ln \left| \frac{t-2}{t-1} \right| + C; \frac{t-2}{t-1} = Ce^x; t = 3 \text{ and } x = 0$$

$$\Rightarrow \frac{1}{2} = C \Rightarrow \frac{t-2}{t-1} = \frac{1}{2} e^x \Rightarrow x = \ln \left| 2 \left(\frac{t-2}{t-1} \right) \right| = \ln |t-2| - \ln |t-1| + \ln 2$$

$$42. (3t^4 + 4t^2 + 1) \frac{dx}{dt} = 2\sqrt{3}; x = 2\sqrt{3} \int \frac{dt}{3t^4 + 4t^2 + 1} = \sqrt{3} \int \frac{dt}{t^2 + \frac{1}{3}} - \sqrt{3} \int \frac{dt}{t^2 + 1}$$

$$= 3 \tan^{-1}(\sqrt{3}t) - \sqrt{3} \tan^{-1} t + C; t = 1 \text{ and } x = \frac{-\pi\sqrt{3}}{4} \Rightarrow -\frac{\sqrt{3}\pi}{4} = \pi - \frac{\sqrt{3}}{4}\pi + C \Rightarrow C = -\pi$$

$$\Rightarrow x = 3 \tan^{-1}(\sqrt{3}t) - \sqrt{3} \tan^{-1} t - \pi$$

$$43. (t^2 + 2t) \frac{dx}{dt} = 2x + 2; \frac{1}{2} \int \frac{dx}{x+1} = \int \frac{dt}{t^2 + 2t} \Rightarrow \frac{1}{2} \ln |x+1| = \frac{1}{2} \int \frac{dt}{t} - \frac{1}{2} \int \frac{dt}{t+2} \Rightarrow \ln |x+1| = \ln \left| \frac{t}{t+2} \right| + C;$$

$$t = 1 \text{ and } x = 1 \Rightarrow \ln 2 = \ln \frac{1}{3} + C \Rightarrow C = \ln 2 + \ln 3 = \ln 6 \Rightarrow \ln |x+1| = \ln 6 \left| \frac{t}{t+2} \right| \Rightarrow x+1 = \frac{6t}{t+2}$$

$$\Rightarrow x = \frac{6t}{t+2} - 1, t > 0$$

$$44. (t+1) \frac{dx}{dt} = x^2 + 1 \Rightarrow \int \frac{dx}{x^2+1} = \int \frac{dt}{t+1} \Rightarrow \tan^{-1} x = \ln |t+1| + C; t = 0 \text{ and } x = \frac{\pi}{4} \Rightarrow \tan^{-1} \frac{\pi}{4} = \ln |1| + C$$

$$\Rightarrow C = \tan^{-1} \frac{\pi}{4} = 1 \Rightarrow \tan^{-1} x = \ln |t+1| + 1 \Rightarrow x = \tan(\ln(t+1) + 1), t > -1$$

$$45. V = \pi \int_{0.5}^{2.5} y^2 dx = \pi \int_{0.5}^{2.5} \frac{9}{3x-x^2} dx = 3\pi \left(\int_{0.5}^{2.5} \left(-\frac{1}{x-3} + \frac{1}{x} \right) dx \right) = [3\pi \ln \left| \frac{x}{x-3} \right|]_{0.5}^{2.5} = 3\pi \ln 25$$

$$46. V = 2\pi \int_0^1 xy \, dx = 2\pi \int_0^1 \frac{2x}{(x+1)(2-x)} dx = 4\pi \int_0^1 \left(-\frac{1}{3} \left(\frac{1}{x+1} \right) + \frac{2}{3} \left(\frac{1}{2-x} \right) \right) dx$$

$$= \left[-\frac{4\pi}{3} (\ln |x+1| + 2 \ln |2-x|) \right]_0^1 = \frac{4\pi}{3} (\ln 2)$$

$$47. A = \int_0^{\sqrt{3}} \tan^{-1} x \, dx = [x \tan^{-1} x]_0^{\sqrt{3}} - \int_0^{\sqrt{3}} \frac{x}{1+x^2} dx$$

$$= \frac{\pi\sqrt{3}}{3} - \left[\frac{1}{2} \ln(x^2+1) \right]_0^{\sqrt{3}} = \frac{\pi\sqrt{3}}{3} - \ln 2;$$

$$\bar{x} = \frac{1}{A} \int_0^{\sqrt{3}} x \tan^{-1} x \, dx$$

$$= \frac{1}{A} \left(\left[\frac{1}{2} x^2 \tan^{-1} x \right]_0^{\sqrt{3}} - \frac{1}{2} \int_0^{\sqrt{3}} \frac{x^2}{1+x^2} dx \right)$$

$$= \frac{1}{A} \left[\frac{\pi}{2} - \left[\frac{1}{2} (x - \tan^{-1} x) \right]_0^{\sqrt{3}} \right]$$

$$= \frac{1}{A} \left(\frac{\pi}{2} - \frac{\sqrt{3}}{2} + \frac{\pi}{6} \right) = \frac{1}{A} \left(\frac{2\pi}{3} - \frac{\sqrt{3}}{2} \right) \cong 1.10$$

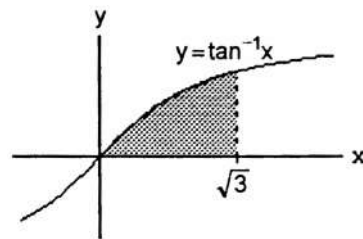

48. $A = \int_3^5 \frac{4x^2 + 13x - 9}{x^3 + 2x^2 - 3x} dx = 3 \int_3^5 \frac{dx}{x} - \int_3^5 \frac{dx}{x+3} + 2 \int_3^5 \frac{dx}{x-1} = [3 \ln |x| - \ln |x+3| + 2 \ln |x-1|]_3^5 = \ln \frac{125}{9};$
 $\bar{x} = \frac{1}{A} \int_3^5 \frac{x(4x^2 + 13x - 9)}{x^3 + 2x^2 - 3x} dx = \frac{1}{A} \left([4x]_3^5 + 3 \int_3^5 \frac{dx}{x+3} + 2 \int_3^5 \frac{dx}{x-1} \right) = \frac{1}{A} (8 + 11 \ln 2 - 3 \ln 6) \cong 3.90$

49. (a) $\frac{dx}{dt} = kx(N-x) \Rightarrow \int \frac{dx}{x(N-x)} = \int k dt \Rightarrow \frac{1}{N} \int \frac{dx}{x} + \frac{1}{N} \int \frac{dx}{N-x} = \int k dt \Rightarrow \frac{1}{N} \ln \left| \frac{x}{N-x} \right| = kt + C;$
 $k = \frac{1}{250}, N = 1000, t = 0 \text{ and } x = 2 \Rightarrow \frac{1}{1000} \ln \left| \frac{2}{998} \right| = C \Rightarrow \frac{1}{1000} \ln \left| \frac{x}{1000-x} \right| = \frac{t}{250} + \frac{1}{1000} \ln \left(\frac{1}{499} \right)$
 $\Rightarrow \ln \left| \frac{499x}{1000-x} \right| = 4t \Rightarrow \frac{499x}{1000-x} = e^{4t} \Rightarrow 499x = e^{4t}(1000-x) \Rightarrow (499 + e^{4t})x = 1000e^{4t} \Rightarrow x = \frac{1000e^{4t}}{499 + e^{4t}}$
 (b) $x = \frac{1}{2}N = 500 \Rightarrow 500 = \frac{1000e^{4t}}{499 + e^{4t}} \Rightarrow 500 \cdot 499 + 500e^{4t} = 1000e^{4t} \Rightarrow e^{4t} = 499 \Rightarrow t = \frac{1}{4} \ln 499 \approx 1.55 \text{ days}$

50. $\frac{dx}{dt} = k(a-x)(b-x) \Rightarrow \frac{dx}{(a-x)(b-x)} = k dt$

(a) $a = b: \int \frac{dx}{(a-x)^2} = \int k dt \Rightarrow \frac{1}{a-x} = kt + C; t = 0 \text{ and } x = 0 \Rightarrow \frac{1}{a} = C \Rightarrow \frac{1}{a-x} = kt + \frac{1}{a}$
 $\Rightarrow \frac{1}{a-x} = \frac{akt+1}{a} \Rightarrow a-x = \frac{a}{akt+1} \Rightarrow x = a - \frac{a}{akt+1} = \frac{a^2kt}{akt+1}$

(b) $a \neq b: \int \frac{dx}{(a-x)(b-x)} = \int k dt \Rightarrow \frac{1}{b-a} \int \frac{dx}{a-x} - \frac{1}{b-a} \int \frac{dx}{b-x} = \int k dt \Rightarrow \frac{1}{b-a} \ln \left| \frac{b-x}{a-x} \right| = kt + C;$
 $t = 0 \text{ and } x = 0 \Rightarrow \frac{1}{b-a} \ln \frac{b}{a} = C \Rightarrow \ln \left| \frac{b-x}{a-x} \right| = (b-a)kt + \ln \left(\frac{b}{a} \right) \Rightarrow \frac{b-x}{a-x} = \frac{b}{a} e^{(b-a)kt}$
 $\Rightarrow x = \frac{ab[1 - e^{(b-a)kt}]}{a - be^{(b-a)kt}}$

51. (a) $\int_0^1 \frac{x^4(x-1)^4}{x^2+1} dx = \int_0^1 (x^6 - 4x^5 + 5x^4 - 4x^2 + 4 - \frac{4}{x^2+1}) dx = \frac{22}{7} - \pi$

(b) $\frac{22}{7} - \pi \cdot 100\% \cong 0.04\%$

(c) The area is less than 0.003

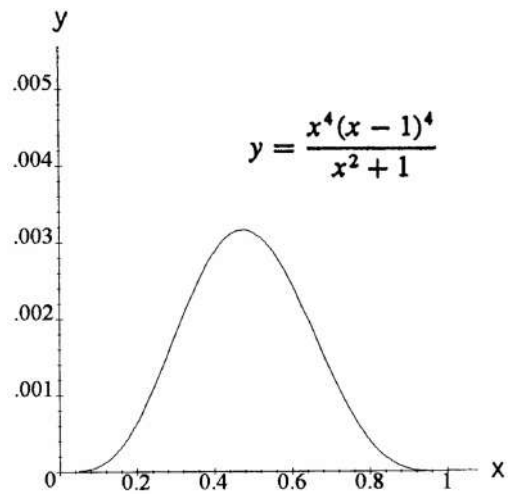
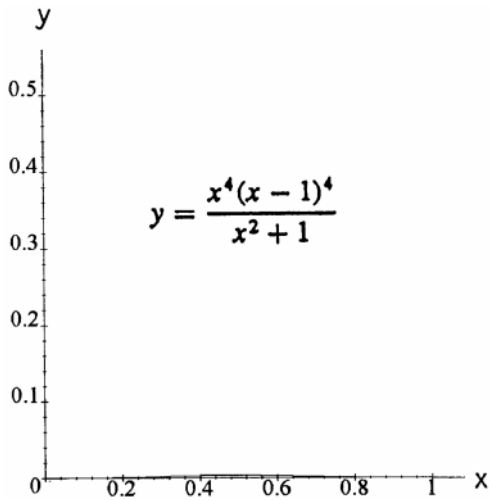

52. $P(x) = ax^2 + bx + c, P(0) = c = 1 \text{ and } P'(0) = 0 \Rightarrow b = 0 \Rightarrow P(x) = ax^2 + 1.$ Next,

$\frac{ax^2+1}{x^3(x-1)^2} = \frac{A}{x} + \frac{B}{x^2} + \frac{C}{x-1} + \frac{D}{x-1} + \frac{E}{(x-1)^2};$ for the integral to be a rational function, we must have $A = 0$ and

$D = 0.$ Thus, $ax^2 + 1 = Bx(x-1)^2 + C(x-1)^2 + Ex^3 = (B+E)x^3 + (C-2B)x^2 + (B-2C)x + C$

$\left. \begin{aligned} B + E &= 0 \\ C - 2B &= a \\ C &= 1 \end{aligned} \right\} \Rightarrow E = -B; x = 1 \Rightarrow a + 1 = E; \text{ therefore, } 1 - 2B = a \Rightarrow 1 + 2E = a \Rightarrow 1 + 2(a + 1) = a$

$\Rightarrow a = -3$

8.4 TRIGONOMETRIC INTEGRALS

- $$\begin{aligned} \int_0^{\pi/2} \sin^5 x \, dx &= \int_0^{\pi/2} (\sin^2 x)^2 \sin x \, dx = \int_0^{\pi/2} (1 - \cos^2 x)^2 \sin x \, dx = \int_0^{\pi/2} (1 - 2\cos^2 x + \cos^4 x) \sin x \, dx \\ &= \int_0^{\pi/2} \sin x \, dx - \int_0^{\pi/2} 2\cos^2 x \sin x \, dx + \int_0^{\pi/2} \cos^4 x \sin x \, dx = \left[-\cos x + 2\frac{\cos^3 x}{3} - \frac{\cos^5 x}{5} \right]_0^{\pi/2} \\ &= (0) - \left(-1 + \frac{2}{3} - \frac{1}{5} \right) = \frac{8}{15} \end{aligned}$$
- $$\begin{aligned} \int_0^{\pi} \sin^5 \left(\frac{x}{2} \right) dx \text{ (using Exercise 1)} &= \int_0^{\pi} \sin \left(\frac{x}{2} \right) dx - \int_0^{\pi} 2\cos^2 \left(\frac{x}{2} \right) \sin \left(\frac{x}{2} \right) dx + \int_0^{\pi} \cos^4 \left(\frac{x}{2} \right) \sin \left(\frac{x}{2} \right) dx \\ &= \left[-2\cos \left(\frac{x}{2} \right) + \frac{4}{3} \cos^3 \left(\frac{x}{2} \right) - \frac{2}{5} \cos^5 \left(\frac{x}{2} \right) \right]_0^{\pi} = (0) - \left(-2 + \frac{4}{3} - \frac{2}{5} \right) = \frac{16}{15} \end{aligned}$$
- $$\begin{aligned} \int_{-\pi/2}^{\pi/2} \cos^3 x \, dx &= \int_{-\pi/2}^{\pi/2} (\cos^2 x) \cos x \, dx = \int_{-\pi/2}^{\pi/2} (1 - \sin^2 x) \cos x \, dx = \int_{-\pi/2}^{\pi/2} \cos x \, dx - \int_{-\pi/2}^{\pi/2} \sin^2 x \cos x \, dx \\ &= \left[\sin x - \frac{\sin^3 x}{3} \right]_{-\pi/2}^{\pi/2} = \left(1 - \frac{1}{3} \right) - \left(-1 + \frac{1}{3} \right) = \frac{4}{3} \end{aligned}$$
- $$\begin{aligned} \int_0^{\pi/6} 3\cos^5 3x \, dx &= \int_0^{\pi/6} (\cos^2 3x)^2 \cos 3x \cdot 3 \, dx = \int_0^{\pi/6} (1 - \sin^2 3x)^2 \cos 3x \cdot 3 \, dx = \int_0^{\pi/6} (1 - 2\sin^2 3x + \sin^4 3x) \cos 3x \cdot 3 \, dx \\ &= \int_0^{\pi/6} \cos 3x \cdot 3 \, dx - 2 \int_0^{\pi/6} \sin^2 3x \cos 3x \cdot 3 \, dx + \int_0^{\pi/6} \sin^4 3x \cos 3x \cdot 3 \, dx = \left[\sin 3x - 2\frac{\sin^3 3x}{3} + \frac{\sin^5 3x}{5} \right]_0^{\pi/6} \\ &= \left(1 - \frac{2}{3} + \frac{1}{5} \right) - (0) = \frac{8}{15} \end{aligned}$$
- $$\begin{aligned} \int_0^{\pi/2} \sin^7 y \, dy &= \int_0^{\pi/2} \sin^6 y \sin y \, dy = \int_0^{\pi/2} (1 - \cos^2 y)^3 \sin y \, dy = \int_0^{\pi/2} \sin y \, dy - 3 \int_0^{\pi/2} \cos^2 y \sin y \, dy \\ &\quad + 3 \int_0^{\pi/2} \cos^4 y \sin y \, dy - \int_0^{\pi/2} \cos^6 y \sin y \, dy = \left[-\cos y + 3\frac{\cos^3 y}{3} - 3\frac{\cos^5 y}{5} + \frac{\cos^7 y}{7} \right]_0^{\pi/2} = (0) - \left(-1 + 1 - \frac{3}{5} + \frac{1}{7} \right) = \frac{16}{35} \end{aligned}$$
- $$\begin{aligned} \int_0^{\pi/2} 7\cos^7 t \, dt \text{ (using Exercise 5)} &= 7 \left[\int_0^{\pi/2} \cos t \, dt - 3 \int_0^{\pi/2} \sin^2 t \cos t \, dt + 3 \int_0^{\pi/2} \sin^4 t \cos t \, dt - \int_0^{\pi/2} \sin^6 t \cos t \, dt \right] \\ &= 7 \left[\sin t - 3\frac{\sin^3 t}{3} + 3\frac{\sin^5 t}{5} - \frac{\sin^7 t}{7} \right]_0^{\pi/2} = 7 \left(1 - 1 + \frac{3}{5} - \frac{1}{7} \right) - 7(0) = \frac{16}{5} \end{aligned}$$
- $$\begin{aligned} \int_0^{\pi} 8\sin^4 x \, dx &= 8 \int_0^{\pi} \left(\frac{1 - \cos 2x}{2} \right)^2 dx = 2 \int_0^{\pi} (1 - 2\cos 2x + \cos^2 2x) dx = 2 \int_0^{\pi} dx - 2 \int_0^{\pi} \cos 2x \cdot 2 \, dx + 2 \int_0^{\pi} \frac{1 + \cos 4x}{2} dx \\ &= [2x - 2\sin 2x]_0^{\pi} + \int_0^{\pi} dx + \int_0^{\pi} \cos 4x \, dx = 2\pi + [x + \frac{1}{2}\sin 4x]_0^{\pi} = 2\pi + \pi = 3\pi \end{aligned}$$
- $$\begin{aligned} \int_0^1 8\cos^4 2\pi x \, dx &= 8 \int_0^1 \left(\frac{1 + \cos 4\pi x}{2} \right)^2 dx = 2 \int_0^1 (1 + 2\cos 4\pi x + \cos^2 4\pi x) dx = 2 \int_0^1 dx + 4 \int_0^1 \cos 4\pi x \, dx + 2 \int_0^1 \frac{1 + \cos 8\pi x}{2} dx \\ &= [2x + \frac{1}{\pi}\sin 4\pi x]_0^1 + \int_0^1 dx + \int_0^1 \cos 8\pi x \, dx = 2 + [x + \frac{1}{8\pi}\sin 8\pi x]_0^1 = 2 + 1 = 3 \end{aligned}$$
- $$\begin{aligned} \int_{-\pi/4}^{\pi/4} 16 \sin^2 x \cos^2 x \, dx &= 16 \int_{-\pi/4}^{\pi/4} \left(\frac{1 - \cos 2x}{2} \right) \left(\frac{1 + \cos 2x}{2} \right) dx = 4 \int_{-\pi/4}^{\pi/4} (1 - \cos^2 2x) dx = 4 \int_{-\pi/4}^{\pi/4} dx - 4 \int_{-\pi/4}^{\pi/4} \left(\frac{1 + \cos 4x}{2} \right) dx \\ &= [4x]_{-\pi/4}^{\pi/4} - 2 \int_{-\pi/4}^{\pi/4} dx - 2 \int_{-\pi/4}^{\pi/4} \cos 4x \, dx = \pi + \pi - [2x + \frac{\sin 4x}{2}]_{-\pi/4}^{\pi/4} = 2\pi - \left(\frac{\pi}{2} - \left(-\frac{\pi}{2} \right) \right) = \pi \end{aligned}$$
- $$\begin{aligned} \int_0^{\pi} 8 \sin^4 y \cos^2 y \, dy &= 8 \int_0^{\pi} \left(\frac{1 - \cos 2y}{2} \right)^2 \left(\frac{1 + \cos 2y}{2} \right) dy = \int_0^{\pi} dy - \int_0^{\pi} \cos 2y \, dy - \int_0^{\pi} \cos^2 2y \, dy + \int_0^{\pi} \cos^3 2y \, dy \\ &= [y - \frac{1}{2}\sin 2y]_0^{\pi} - \int_0^{\pi} \left(\frac{1 + \cos 4y}{2} \right) dy + \int_0^{\pi} (1 - \sin^2 2y) \cos 2y \, dy = \pi - \frac{1}{2} \int_0^{\pi} dy - \frac{1}{2} \int_0^{\pi} \cos 4y \, dy + \int_0^{\pi} \cos 2y \, dy \\ &\quad - \int_0^{\pi} \sin^2 2y \cos 2y \, dy = \pi + \left[-\frac{1}{2}y - \frac{1}{8}\sin 4y + \frac{1}{2}\sin 2y - \frac{1}{2} \cdot \frac{\sin^3 2y}{3} \right]_0^{\pi} = \pi - \frac{\pi}{2} = \frac{\pi}{2} \end{aligned}$$

$$11. \int_0^{\pi/2} 35 \sin^4 x \cos^3 x \, dx = \int_0^{\pi/2} 35 \sin^4 x (1 - \sin^2 x) \cos x \, dx = 35 \int_0^{\pi/2} \sin^4 x \cos x \, dx - 35 \int_0^{\pi/2} \sin^6 x \cos x \, dx$$

$$= \left[35 \frac{\sin^5 x}{5} - 35 \frac{\sin^7 x}{7} \right]_0^{\pi/2} = (7 - 5) - (0) = 2$$

$$12. \int_0^{\pi} \cos^2 2x \sin 2x \, dx = \left[-\frac{1}{2} \frac{\cos^3 2x}{3} \right]_0^{\pi} = -\frac{1}{6} + \frac{1}{6} = 0$$

$$13. \int_0^{\pi/4} 8 \cos^3 2\theta \sin 2\theta \, d\theta = \left[8 \left(-\frac{1}{2} \right) \frac{\cos^4 2\theta}{4} \right]_0^{\pi/4} = [-\cos^4 2\theta]_0^{\pi/4} = (0) - (-1) = 1$$

$$14. \int_0^{\pi/2} \sin^2 2\theta \cos^3 2\theta \, d\theta = \int_0^{\pi/2} \sin^2 2\theta (1 - \sin^2 2\theta) \cos 2\theta \, d\theta = \int_0^{\pi/2} \sin^2 2\theta \cos 2\theta \, d\theta - \int_0^{\pi/2} \sin^4 2\theta \cos 2\theta \, d\theta$$

$$= \left[\frac{1}{2} \cdot \frac{\sin^3 2\theta}{3} - \frac{1}{2} \cdot \frac{\sin^5 2\theta}{5} \right]_0^{\pi/2} = 0$$

$$15. \int_0^{2\pi} \sqrt{\frac{1 - \cos x}{2}} \, dx = \int_0^{2\pi} \left| \sin \frac{x}{2} \right| \, dx = \int_0^{2\pi} \sin \frac{x}{2} \, dx = [-2 \cos \frac{x}{2}]_0^{2\pi} = 2 + 2 = 4$$

$$16. \int_0^{\pi} \sqrt{1 - \cos 2x} \, dx = \int_0^{\pi} \sqrt{2} |\sin x| \, dx = \int_0^{\pi} \sqrt{2} \sin x \, dx = [-\sqrt{2} \cos 2x]_0^{\pi} = \sqrt{2} + \sqrt{2} = 2\sqrt{2}$$

$$17. \int_0^{\pi} \sqrt{1 - \sin^2 t} \, dt = \int_0^{\pi} |\cos t| \, dt = \int_0^{\pi/2} \cos t \, dt - \int_{\pi/2}^{\pi} \cos t \, dt = [\sin t]_0^{\pi/2} - [\sin t]_{\pi/2}^{\pi} = 1 - 0 - 0 + 1 = 2$$

$$18. \int_0^{\pi} \sqrt{1 - \cos^2 \theta} \, d\theta = \int_0^{\pi} |\sin \theta| \, d\theta = \int_0^{\pi} \sin \theta \, d\theta = [-\cos \theta]_0^{\pi} = 1 + 1 = 2$$

$$19. \int_{-\pi/4}^{\pi/4} \sqrt{1 + \tan^2 x} \, dx = \int_{-\pi/4}^{\pi/4} |\sec x| \, dx = \int_{-\pi/4}^{\pi/4} \sec x \, dx = [\ln |\sec x + \tan x|]_{-\pi/4}^{\pi/4} = \ln(\sqrt{2} + 1) - \ln(\sqrt{2} - 1)$$

$$= \ln\left(\frac{\sqrt{2} + 1}{\sqrt{2} - 1}\right) = 2 \ln(1 + \sqrt{2})$$

$$20. \int_{-\pi/4}^{\pi/4} \sqrt{\sec^2 x - 1} \, dx = \int_{-\pi/4}^{\pi/4} |\tan x| \, dx = -\int_{-\pi/4}^0 \tan x \, dx + \int_0^{\pi/4} \tan x \, dx = [-\ln |\sec x|]_{-\pi/4}^0 + [-\ln |\sec x|]_0^{\pi/4}$$

$$= -\ln(1) + \ln\sqrt{2} + \ln\sqrt{2} - \ln(1) = 2 \ln\sqrt{2} = \ln 2$$

$$21. \int_0^{\pi/2} \theta \sqrt{1 - \cos 2\theta} \, d\theta = \int_0^{\pi/2} \theta \sqrt{2} |\sin \theta| \, d\theta = \sqrt{2} \int_0^{\pi/2} \theta \sin \theta \, d\theta = \sqrt{2} [-\theta \cos \theta + \sin \theta]_0^{\pi/2} = \sqrt{2}(1) = \sqrt{2}$$

$$22. \int_{-\pi}^{\pi} (1 - \cos^2 t)^{3/2} \, dt = \int_{-\pi}^{\pi} (\sin^2 t)^{3/2} \, dt = \int_{-\pi}^{\pi} |\sin^3 t| \, dt = -\int_{-\pi}^0 \sin^3 t \, dt + \int_0^{\pi} \sin^3 t \, dt = -\int_{-\pi}^0 (1 - \cos^2 t) \sin t \, dt$$

$$+ \int_0^{\pi} (1 - \cos^2 t) \sin t \, dt = -\int_{-\pi}^0 \sin t \, dt + \int_{-\pi}^0 \cos^2 t \sin t \, dt + \int_0^{\pi} \sin t \, dt - \int_0^{\pi} \cos^2 t \sin t \, dt = \left[\cos t - \frac{\cos^3 t}{3} \right]_{-\pi}^0$$

$$+ \left[-\cos t + \frac{\cos^3 t}{3} \right]_0^{\pi} = \left(1 - \frac{1}{3} + 1 - \frac{1}{3}\right) + \left(1 - \frac{1}{3} + 1 - \frac{1}{3}\right) = \frac{8}{3}$$

$$23. \int_{-\pi/3}^0 2 \sec^3 x \, dx; u = \sec x, du = \sec x \tan x \, dx, dv = \sec^2 x \, dx, v = \tan x;$$

$$\int_{-\pi/3}^0 2 \sec^3 x \, dx = [2 \sec x \tan x]_{-\pi/3}^0 - 2 \int_{-\pi/3}^0 \sec x \tan^2 x \, dx = 2 \cdot 1 \cdot 0 - 2 \cdot 2 \cdot \sqrt{3} - 2 \int_{-\pi/3}^0 \sec x (\sec^2 x - 1) \, dx$$

$$= 4\sqrt{3} - 2 \int_{-\pi/3}^0 \sec^3 x \, dx + 2 \int_{-\pi/3}^0 \sec x \, dx; 2 \int_{-\pi/3}^0 2 \sec^3 x \, dx = 4\sqrt{3} + [2 \ln |\sec x + \tan x|]_{-\pi/3}^0$$

$$2 \int_{-\pi/3}^0 2 \sec^3 x \, dx = 4\sqrt{3} + 2 \ln |1 + 0| - 2 \ln |2 - \sqrt{3}| = 4\sqrt{3} - 2 \ln(2 - \sqrt{3})$$

$$\int_{-\pi/3}^0 2 \sec^3 x \, dx = 2\sqrt{3} - \ln(2 - \sqrt{3})$$

$$24. \int e^x \sec^3(e^x) dx; u = \sec(e^x), du = \sec(e^x)\tan(e^x)e^x dx, dv = \sec^2(e^x)e^x dx, v = \tan(e^x).$$

$$\begin{aligned} \int e^x \sec^3(e^x) dx &= \sec(e^x)\tan(e^x) - \int \sec(e^x)\tan^2(e^x)e^x dx \\ &= \sec(e^x)\tan(e^x) - \int \sec(e^x)(\sec^2(e^x) - 1)e^x dx \\ &= \sec(e^x)\tan(e^x) - \int \sec^3(e^x)e^x dx + \int \sec(e^x)e^x dx \end{aligned}$$

$$2 \int e^x \sec^3(e^x) dx = \sec(e^x)\tan(e^x) + \ln|\sec(e^x) + \tan(e^x)| + C$$

$$\int e^x \sec^3(e^x) dx = \frac{1}{2}(\sec(e^x)\tan(e^x) + \ln|\sec(e^x) + \tan(e^x)|) + C$$

$$25. \int_0^{\pi/4} \sec^4 \theta d\theta = \int_0^{\pi/4} (1 + \tan^2 \theta)\sec^2 \theta d\theta = \int_0^{\pi/4} \sec^2 \theta d\theta + \int_0^{\pi/4} \tan^2 \theta \sec^2 \theta d\theta = \left[\tan \theta + \frac{\tan^3 \theta}{3} \right]_0^{\pi/4} \\ = \left(1 + \frac{1}{3}\right) - (0) = \frac{4}{3}$$

$$26. \int_0^{\pi/12} 3\sec^4(3x) dx = \int_0^{\pi/12} (1 + \tan^2(3x))\sec^2(3x)3dx = \int_0^{\pi/12} \sec^2(3x)3dx + \int_0^{\pi/12} \tan^2(3x)\sec^2(3x)3dx \\ = \left[\tan(3x) + \frac{\tan^3(3x)}{3} \right]_0^{\pi/12} = \left(1 + \frac{1}{3}\right) - (0) = \frac{4}{3}$$

$$27. \int_{\pi/4}^{\pi/2} \csc^4 \theta d\theta = \int_{\pi/4}^{\pi/2} (1 + \cot^2 \theta)\csc^2 \theta d\theta = \int_{\pi/4}^{\pi/2} \csc^2 \theta d\theta + \int_{\pi/4}^{\pi/2} \cot^2 \theta \csc^2 \theta d\theta = \left[-\cot \theta - \frac{\cot^3 \theta}{3} \right]_{\pi/4}^{\pi/2} \\ = (0) - \left(-1 - \frac{1}{3}\right) = \frac{4}{3}$$

$$28. \int_{\pi/2}^{\pi} 3\csc^4 \frac{\theta}{2} d\theta = 3 \int_{\pi/2}^{\pi} (1 + \cot^2 \frac{\theta}{2})\csc^2 \frac{\theta}{2} d\theta = 3 \int_{\pi/2}^{\pi} \csc^2 \frac{\theta}{2} d\theta + 3 \int_{\pi/2}^{\pi} \cot^2 \frac{\theta}{2} \csc^2 \frac{\theta}{2} d\theta = \left[-6\cot \frac{\theta}{2} - 6\frac{\cot^3 \frac{\theta}{2}}{3} \right]_{\pi/2}^{\pi} \\ = (-6 \cdot 0 - 2 \cdot 0) - (-6 \cdot 1 - 2 \cdot 1) = 8$$

$$29. \int_0^{\pi/4} 4 \tan^3 x dx = 4 \int_0^{\pi/4} (\sec^2 x - 1)\tan x dx = 4 \int_0^{\pi/4} \sec^2 x \tan x dx - 4 \int_0^{\pi/4} \tan x dx = \left[4\frac{\tan^2 x}{2} - 4 \ln|\sec x| \right]_0^{\pi/4} \\ = 2(1) - 4\ln\sqrt{2} - 2 \cdot 0 + 4\ln 1 = 2 - 2\ln 2$$

$$30. \int_{-\pi/4}^{\pi/4} 6 \tan^4 x dx = 6 \int_{-\pi/4}^{\pi/4} (\sec^2 x - 1)\tan^2 x dx = 6 \int_{-\pi/4}^{\pi/4} \sec^2 x \tan^2 x dx - 6 \int_{-\pi/4}^{\pi/4} \tan^2 x dx \\ = 6 \int_{-\pi/4}^{\pi/4} \sec^2 x \tan^2 x dx - 6 \int_{-\pi/4}^{\pi/4} (\sec^2 x - 1)dx = \left[6\frac{\tan^3 x}{3} \right]_{-\pi/4}^{\pi/4} - 6 \int_{-\pi/4}^{\pi/4} \sec^2 x dx + 6 \int_{-\pi/4}^{\pi/4} dx \\ = 2(1 - (-1)) - [6\tan x]_{-\pi/4}^{\pi/4} + [6x]_{-\pi/4}^{\pi/4} = 4 - 6(1 - (-1)) + \frac{3\pi}{2} + \frac{3\pi}{2} = 3\pi - 8$$

$$31. \int_{\pi/6}^{\pi/3} \cot^3 x dx = \int_{\pi/6}^{\pi/3} (\csc^2 x - 1)\cot x dx = \int_{\pi/6}^{\pi/3} \csc^2 x \cot x dx - \int_{\pi/6}^{\pi/3} \cot x dx = \left[-\frac{\cot^2 x}{2} + \ln|\csc x| \right]_{\pi/6}^{\pi/3} \\ = -\frac{1}{2}\left(\frac{1}{3} - 3\right) + \left(\ln\frac{2}{\sqrt{3}} - \ln 2\right) = \frac{4}{3} - \ln\sqrt{3}$$

$$32. \int_{\pi/4}^{\pi/2} 8 \cot^4 t dt = 8 \int_{\pi/4}^{\pi/2} (\csc^2 t - 1)\cot^2 t dt = 8 \int_{\pi/4}^{\pi/2} \csc^2 t \cot^2 t dt - 8 \int_{\pi/4}^{\pi/2} \cot^2 t dt \\ = -8 \left[-\frac{\cot^3 t}{3} \right]_{\pi/4}^{\pi/2} - 8 \int_{\pi/4}^{\pi/2} (\csc^2 t - 1)dt = -\frac{8}{3}(0 - 1) + [8\cot t]_{\pi/4}^{\pi/2} + [8t]_{\pi/4}^{\pi/2} = \frac{8}{3} + 8(0 - 1) + 4\pi - 2\pi = 2\pi - \frac{16}{3}$$

$$33. \int_{-\pi}^0 \sin 3x \cos 2x dx = \frac{1}{2} \int_{-\pi}^0 (\sin x + \sin 5x) dx = \frac{1}{2}[-\cos x - \frac{1}{5}\cos 5x]_{-\pi}^0 = \frac{1}{2}\left(-1 - \frac{1}{5} - 1 - \frac{1}{5}\right) = -\frac{6}{5}$$

$$34. \int_0^{\pi/2} \sin 2x \cos 3x dx = \frac{1}{2} \int_0^{\pi/2} (\sin(-x) + \sin 5x) dx = \frac{1}{2}[\cos(-x) - \frac{1}{5}\cos 5x]_0^{\pi/2} = \frac{1}{2}(0) - \frac{1}{2}\left(1 - \frac{1}{5}\right) = -\frac{2}{5}$$

$$35. \int_{-\pi}^{\pi} \sin 3x \sin 3x \, dx = \frac{1}{2} \int_{-\pi}^{\pi} (\cos 0 - \cos 6x) \, dx = \frac{1}{2} \int_{-\pi}^{\pi} dx - \frac{1}{2} \int_{-\pi}^{\pi} \cos 6x \, dx = \frac{1}{2} [x - \frac{1}{12} \sin 6x]_{-\pi}^{\pi} = \frac{\pi}{2} + \frac{\pi}{2} - 0 = \pi$$

$$36. \int_0^{\pi/2} \sin x \cos x \, dx = \frac{1}{2} \int_0^{\pi/2} (\sin 0 + \sin 2x) \, dx = \frac{1}{2} \int_0^{\pi/2} \sin 2x \, dx = -\frac{1}{4} [\cos 2x]_0^{\pi/2} = -\frac{1}{4} (-1 - 1) = \frac{1}{2}$$

$$37. \int_0^{\pi} \cos 3x \cos 4x \, dx = \frac{1}{2} \int_0^{\pi} (\cos(-x) + \cos 7x) \, dx = \frac{1}{2} [-\sin(-x) + \frac{1}{7} \sin 7x]_0^{\pi} = \frac{1}{2} (0) = 0$$

$$38. \int_{-\pi/2}^{\pi/2} \cos 7x \cos x \, dx = \frac{1}{2} \int_{-\pi/2}^{\pi/2} (\cos 6x + \cos 8x) \, dx = \frac{1}{2} [\frac{1}{6} \sin 6x + \frac{1}{8} \sin 8x]_{-\pi/2}^{\pi/2} = 0$$

$$39. x = t^{2/3} \Rightarrow t^2 = x^3; y = \frac{t^2}{2} \Rightarrow y = \frac{x^3}{2}; 0 \leq t \leq 2 \Rightarrow 0 \leq x \leq 2^{2/3};$$

$$A = \int_0^{2^{2/3}} 2\pi \left(\frac{x^3}{2}\right) \sqrt{1 + \frac{9}{4}x^4} \, dx; \left[\begin{array}{l} u = \frac{9}{4}x^4 \\ du = 9x^3 dx \end{array} \right] \rightarrow \frac{\pi}{9} \int_0^{9(2^{2/3})^4} \sqrt{1+u} \, du = \left[\frac{\pi}{9} \cdot \frac{2}{3} (1+u)^{3/2} \right]_0^{9(2^{2/3})^4}$$

$$= \frac{2\pi}{27} \left[(1 + 9(2^{2/3})^4)^{3/2} - 1 \right]$$

$$40. y = \ln(\cos x); y' = \frac{-\sin x}{\cos x} = -\tan x; (y')^2 = \tan^2 x; \int_0^{\pi/3} \sqrt{1 + \tan^2 x} \, dx = \int_0^{\pi/3} |\sec x| \, dx = [\ln|\sec x + \tan x|]_0^{\pi/3}$$

$$= \ln(2 + \sqrt{3}) - \ln(1 + 0) = \ln(2 + \sqrt{3})$$

$$41. y = \ln(\sec x); y' = \frac{\sec x \tan x}{\sec x} = \tan x; (y')^2 = \tan^2 x; \int_0^{\pi/4} \sqrt{1 + \tan^2 x} \, dx = \int_0^{\pi/4} |\sec x| \, dx = [\ln|\sec x + \tan x|]_0^{\pi/4}$$

$$= \ln(\sqrt{2} + 1) - \ln(0 + 1) = \ln(\sqrt{2} + 1)$$

$$42. M = \int_{-\pi/4}^{\pi/4} \sec x \, dx = [\ln|\sec x + \tan x|]_{-\pi/4}^{\pi/4} = \ln(\sqrt{2} + 1) - \ln|\sqrt{2} - 1| = \ln \frac{\sqrt{2} + 1}{\sqrt{2} - 1}$$

$$\bar{y} = \frac{1}{\ln \frac{\sqrt{2} + 1}{\sqrt{2} - 1}} \int_{-\pi/4}^{\pi/4} \frac{\sec^2 x}{2} \, dx = \frac{1}{2 \ln \frac{\sqrt{2} + 1}{\sqrt{2} - 1}} [\tan x]_{-\pi/4}^{\pi/4} = \frac{1}{2 \ln \frac{\sqrt{2} + 1}{\sqrt{2} - 1}} (1 - (-1)) = \frac{1}{\ln \frac{\sqrt{2} + 1}{\sqrt{2} - 1}}$$

$$\Rightarrow (\bar{x}, \bar{y}) = \left(0, \left(\ln \frac{\sqrt{2} + 1}{\sqrt{2} - 1} \right)^{-1} \right)$$

$$43. V = \pi \int_0^{\pi} \sin^2 x \, dx = \pi \int_0^{\pi} \frac{1 - \cos 2x}{2} \, dx = \frac{\pi}{2} \int_0^{\pi} dx - \frac{\pi}{2} \int_0^{\pi} \cos 2x \, dx = \frac{\pi}{2} [x]_0^{\pi} - \frac{\pi}{4} [\sin 2x]_0^{\pi} = \frac{\pi}{2} (\pi - 0) - \frac{\pi}{4} (0 - 0) = \frac{\pi^2}{2}$$

$$44. A = \int_0^{\pi} \sqrt{1 + \cos 4x} \, dx = \int_0^{\pi} \sqrt{2} |\cos 2x| \, dx = \sqrt{2} \int_0^{\pi/4} \cos 2x \, dx - \sqrt{2} \int_{\pi/4}^{3\pi/4} \cos 2x \, dx + \sqrt{2} \int_{3\pi/4}^{\pi} \cos 2x \, dx$$

$$= \frac{\sqrt{2}}{2} [\sin 2x]_0^{\pi/4} - \frac{\sqrt{2}}{2} [\sin 2x]_{\pi/4}^{3\pi/4} + \frac{\sqrt{2}}{2} [\sin 2x]_{3\pi/4}^{\pi} = \frac{\sqrt{2}}{2} (1 - 0) - \frac{\sqrt{2}}{2} (-1 - 1) + \frac{\sqrt{2}}{2} (0 + 1) = \sqrt{2} + \sqrt{2} = 2\sqrt{2}$$

$$45. (a) m^2 \neq n^2 \Rightarrow m + n \neq 0 \text{ and } m - n \neq 0 \Rightarrow \int_k^{k+2\pi} \sin mx \sin nx \, dx = \frac{1}{2} \int_k^{k+2\pi} [\cos(m-n)x - \cos(m+n)x] \, dx$$

$$= \frac{1}{2} \left[\frac{1}{m-n} \sin(m-n)x - \frac{1}{m+n} \sin(m+n)x \right]_k^{k+2\pi}$$

$$= \frac{1}{2} \left(\frac{1}{m-n} \sin((m-n)(k+2\pi)) - \frac{1}{m+n} \sin((m+n)(k+2\pi)) \right) - \frac{1}{2} \left(\frac{1}{m-n} \sin((m-n)k) - \frac{1}{m+n} \sin((m+n)k) \right)$$

$$= \frac{1}{2(m-n)} \sin((m-n)k) - \frac{1}{2(m+n)} \sin((m+n)k) - \frac{1}{2(m-n)} \sin((m-n)k) + \frac{1}{2(m+n)} \sin((m+n)k) = 0$$

$$\Rightarrow \sin mx \text{ and } \sin nx \text{ are orthogonal.}$$

$$(b) \text{ Same as part since } \frac{1}{2} \int_k^{k+2\pi} \cos 0 \, dx = \pi. m^2 \neq n^2 \Rightarrow m + n \neq 0 \text{ and } m - n \neq 0 \Rightarrow \int_k^{k+2\pi} \cos mx \cos nx \, dx$$

$$= \frac{1}{2} \int_k^{k+2\pi} [\cos(m-n)x + \cos(m+n)x] \, dx = \frac{1}{2} \left[\frac{1}{m-n} \sin(m-n)x + \frac{1}{m+n} \sin(m+n)x \right]_k^{k+2\pi}$$

$$= \frac{1}{2(m-n)} \sin((m-n)(k+2\pi)) + \frac{1}{2(m+n)} \sin((m+n)(k+2\pi)) - \frac{1}{2(m-n)} \sin((m-n)k) - \frac{1}{2(m+n)} \sin((m+n)k)$$

$$= \frac{1}{2(m-n)} \sin((m-n)k) + \frac{1}{2(m+n)} \sin((m+n)k) - \frac{1}{2(m-n)} \sin((m-n)k) - \frac{1}{2(m+n)} \sin((m+n)k) = 0$$

$\Rightarrow \cos mx$ and $\cos nx$ are orthogonal.

- (c) Let $m = n \Rightarrow \sin mx \cos nx = \frac{1}{2}(\sin 0 + \sin((m+n)x))$ and $\frac{1}{2} \int_k^{k+2\pi} \sin 0 \, dx = 0$ and $\frac{1}{2} \int_k^{k+2\pi} \sin((m+n)x) \, dx = 0$
 $\Rightarrow \sin mx$ and $\cos nx$ are orthogonal if $m = n$.

Let $m \neq n$.

$$\begin{aligned} \int_k^{k+2\pi} \sin mx \cos nx \, dx &= \frac{1}{2} \int_k^{k+2\pi} [\sin(m-n)x + \sin(m+n)x] \, dx = \frac{1}{2} \left[-\frac{1}{m-n} \cos(m-n)x - \frac{1}{m+n} \cos(m+n)x \right]_k^{k+2\pi} \\ &= -\frac{1}{2(m-n)} \cos((m-n)(k+2\pi)) - \frac{1}{2(m+n)} \cos((m+n)(k+2\pi)) + \frac{1}{2(m-n)} \cos((m-n)k) + \frac{1}{2(m+n)} \cos((m+n)k) \\ &= -\frac{1}{2(m-n)} \cos((m-n)k) - \frac{1}{2(m+n)} \cos((m+n)k) + \frac{1}{2(m-n)} \cos((m-n)k) + \frac{1}{2(m+n)} \cos((m+n)k) = 0 \\ &\Rightarrow \sin mx \text{ and } \cos nx \text{ are orthogonal.} \end{aligned}$$

46. $\frac{1}{\pi} \int_{-\pi}^{\pi} f(x) \sin mx \, dx = \sum_{n=1}^N \frac{a_n}{\pi} \int_{-\pi}^{\pi} \sin nx \sin mx \, dx$. Since $\frac{1}{\pi} \int_{-\pi}^{\pi} \sin nx \sin mx \, dx = \begin{cases} 0 & \text{for } m \neq n \\ 1 & \text{for } m = n \end{cases}$,

the sum on the right has only one nonzero term, namely $\frac{a_m}{\pi} \int_{-\pi}^{\pi} \sin mx \sin mx \, dx = a_m$.

8.5 TRIGONOMETRIC SUBSTITUTIONS

1. $y = 3 \tan \theta$, $-\frac{\pi}{2} < \theta < \frac{\pi}{2}$, $dy = \frac{3 \, d\theta}{\cos^2 \theta}$, $9 + y^2 = 9(1 + \tan^2 \theta) = \frac{9}{\cos^2 \theta} \Rightarrow \frac{1}{\sqrt{9+y^2}} = \frac{|\cos \theta|}{3} = \frac{\cos \theta}{3}$

(because $\cos \theta > 0$ when $-\frac{\pi}{2} < \theta < \frac{\pi}{2}$);

$$\int \frac{dy}{\sqrt{9+y^2}} = 3 \int \frac{\cos \theta \, d\theta}{3 \cos^2 \theta} = \int \frac{d\theta}{\cos \theta} = \ln |\sec \theta + \tan \theta| + C' = \ln \left| \frac{\sqrt{9+y^2}}{3} + \frac{y}{3} \right| + C' = \ln |\sqrt{9+y^2} + y| + C$$

2. $\int \frac{3 \, dy}{\sqrt{1+9y^2}}$; $[3y = x] \rightarrow \int \frac{dx}{\sqrt{1+x^2}}$; $x = \tan t$, $-\frac{\pi}{2} < t < \frac{\pi}{2}$, $dx = \frac{dt}{\cos^2 t}$, $\sqrt{1+x^2} = \frac{1}{\cos t}$;

$$\int \frac{dx}{\sqrt{1+x^2}} = \int \frac{dt}{\cos^2 t \left(\frac{1}{\cos t}\right)} = \ln |\sec t + \tan t| + C = \ln \left| \sqrt{x^2+1} + x \right| + C = \ln |\sqrt{1+9y^2} + 3y| + C$$

3. $\int_{-2}^2 \frac{dx}{4+x^2} = \left[\frac{1}{2} \tan^{-1} \frac{x}{2} \right]_{-2}^2 = \frac{1}{2} \tan^{-1} 1 - \frac{1}{2} \tan^{-1} (-1) = \left(\frac{1}{2}\right) \left(\frac{\pi}{4}\right) - \left(\frac{1}{2}\right) \left(-\frac{\pi}{4}\right) = \frac{\pi}{4}$

4. $\int_0^2 \frac{dx}{8+2x^2} = \frac{1}{2} \int_0^2 \frac{dx}{4+x^2} = \frac{1}{2} \left[\frac{1}{2} \tan^{-1} \frac{x}{2} \right]_0^2 = \frac{1}{2} \left(\frac{1}{2} \tan^{-1} 1 - \frac{1}{2} \tan^{-1} 0 \right) = \left(\frac{1}{2}\right) \left(\frac{1}{2}\right) \left(\frac{\pi}{4}\right) - 0 = \frac{\pi}{16}$

5. $\int_0^{3/2} \frac{dx}{\sqrt{9-x^2}} = \left[\sin^{-1} \frac{x}{3} \right]_0^{3/2} = \sin^{-1} \frac{1}{2} - \sin^{-1} 0 = \frac{\pi}{6} - 0 = \frac{\pi}{6}$

6. $\int_0^{1/\sqrt{2}} \frac{2 \, dx}{\sqrt{1-4x^2}}$; $[t = 2x] \rightarrow \int_0^{1/\sqrt{2}} \frac{dt}{\sqrt{1-t^2}} = \left[\sin^{-1} t \right]_0^{1/\sqrt{2}} = \sin^{-1} \frac{1}{\sqrt{2}} - \sin^{-1} 0 = \frac{\pi}{4} - 0 = \frac{\pi}{4}$

7. $t = 5 \sin \theta$, $-\frac{\pi}{2} < \theta < \frac{\pi}{2}$, $dt = 5 \cos \theta \, d\theta$, $\sqrt{25-t^2} = 5 \cos \theta$;

$$\begin{aligned} \int \sqrt{25-t^2} \, dt &= \int (5 \cos \theta)(5 \cos \theta) \, d\theta = 25 \int \cos^2 \theta \, d\theta = 25 \int \frac{1+\cos 2\theta}{2} \, d\theta = 25 \left(\frac{\theta}{2} + \frac{\sin 2\theta}{4} \right) + C \\ &= \frac{25}{2} (\theta + \sin \theta \cos \theta) + C = \frac{25}{2} \left[\sin^{-1} \left(\frac{t}{5} \right) + \left(\frac{t}{5} \right) \left(\frac{\sqrt{25-t^2}}{5} \right) \right] + C = \frac{25}{2} \sin^{-1} \left(\frac{t}{5} \right) + \frac{t\sqrt{25-t^2}}{2} + C \end{aligned}$$

8. $t = \frac{1}{3} \sin \theta$, $-\frac{\pi}{2} < \theta < \frac{\pi}{2}$, $dt = \frac{1}{3} \cos \theta \, d\theta$, $\sqrt{1-9t^2} = \cos \theta$;

$$\int \sqrt{1-9t^2} \, dt = \frac{1}{3} \int (\cos \theta)(\cos \theta) \, d\theta = \frac{1}{3} \int \cos^2 \theta \, d\theta = \frac{1}{6} (\theta + \sin \theta \cos \theta) + C = \frac{1}{6} \left[\sin^{-1} (3t) + 3t\sqrt{1-9t^2} \right] + C$$

9. $x = \frac{7}{2} \sec \theta$, $0 < \theta < \frac{\pi}{2}$, $dx = \frac{7}{2} \sec \theta \tan \theta \, d\theta$, $\sqrt{4x^2-49} = \sqrt{49 \sec^2 \theta - 49} = 7 \tan \theta$;

$$\int \frac{dx}{\sqrt{4x^2-49}} = \int \frac{\left(\frac{7}{2} \sec \theta \tan \theta\right) d\theta}{7 \tan \theta} = \frac{1}{2} \int \sec \theta \, d\theta = \frac{1}{2} \ln |\sec \theta + \tan \theta| + C = \frac{1}{2} \ln \left| \frac{2x}{7} + \frac{\sqrt{4x^2-49}}{7} \right| + C$$

10. $x = \frac{3}{5} \sec \theta$, $0 < \theta < \frac{\pi}{2}$, $dx = \frac{3}{5} \sec \theta \tan \theta d\theta$, $\sqrt{25x^2 - 9} = \sqrt{9 \sec^2 \theta - 9} = 3 \tan \theta$;

$$\int \frac{5 dx}{\sqrt{25x^2 - 9}} = \int \frac{5 \left(\frac{3}{5} \sec \theta \tan \theta\right) d\theta}{3 \tan \theta} = \int \sec \theta d\theta = \ln |\sec \theta + \tan \theta| + C = \ln \left| \frac{5x}{3} + \frac{\sqrt{25x^2 - 9}}{3} \right| + C$$

11. $y = 7 \sec \theta$, $0 < \theta < \frac{\pi}{2}$, $dy = 7 \sec \theta \tan \theta d\theta$, $\sqrt{y^2 - 49} = 7 \tan \theta$;

$$\int \frac{\sqrt{y^2 - 49}}{y} dy = \int \frac{(7 \tan \theta)(7 \sec \theta \tan \theta) d\theta}{7 \sec \theta} = 7 \int \tan^2 \theta d\theta = 7 \int (\sec^2 \theta - 1) d\theta = 7(\tan \theta - \theta) + C$$

$$= 7 \left[\frac{\sqrt{y^2 - 49}}{7} - \sec^{-1} \left(\frac{y}{7} \right) \right] + C$$

12. $y = 5 \sec \theta$, $0 < \theta < \frac{\pi}{2}$, $dy = 5 \sec \theta \tan \theta d\theta$, $\sqrt{y^2 - 25} = 5 \tan \theta$;

$$\int \frac{\sqrt{y^2 - 25}}{y^3} dy = \int \frac{(5 \tan \theta)(5 \sec \theta \tan \theta) d\theta}{125 \sec^3 \theta} = \frac{1}{5} \int \tan^2 \theta \cos^2 \theta d\theta = \frac{1}{5} \int \sin^2 \theta d\theta = \frac{1}{10} \int (1 - \cos 2\theta) d\theta$$

$$= \frac{1}{10} (\theta - \sin \theta \cos \theta) + C = \frac{1}{10} \left[\sec^{-1} \left(\frac{y}{5} \right) - \left(\frac{\sqrt{y^2 - 25}}{y} \right) \left(\frac{5}{y} \right) \right] + C = \left[\frac{\sec^{-1} \left(\frac{y}{5} \right)}{10} - \frac{\sqrt{y^2 - 25}}{2y^2} \right] + C$$

13. $x = \sec \theta$, $0 < \theta < \frac{\pi}{2}$, $dx = \sec \theta \tan \theta d\theta$, $\sqrt{x^2 - 1} = \tan \theta$;

$$\int \frac{dx}{x^2 \sqrt{x^2 - 1}} = \int \frac{\sec \theta \tan \theta d\theta}{\sec^2 \theta \tan \theta} = \int \frac{d\theta}{\sec \theta} = \sin \theta + C = \frac{\sqrt{x^2 - 1}}{x} + C$$

14. $x = \sec \theta$, $0 < \theta < \frac{\pi}{2}$, $dx = \sec \theta \tan \theta d\theta$, $\sqrt{x^2 - 1} = \tan \theta$;

$$\int \frac{2 dx}{x^3 \sqrt{x^2 - 1}} = \int \frac{2 \tan \theta \sec \theta d\theta}{\sec^3 \theta \tan \theta} = 2 \int \cos^2 \theta d\theta = 2 \int \left(\frac{1 + \cos 2\theta}{2} \right) d\theta = \theta + \sin \theta \cos \theta + C$$

$$= \theta + \tan \theta \cos^2 \theta + C = \sec^{-1} x + \sqrt{x^2 - 1} \left(\frac{1}{x} \right)^2 + C = \sec^{-1} x + \frac{\sqrt{x^2 - 1}}{x^2} + C$$

15. $x = 2 \tan \theta$, $-\frac{\pi}{2} < \theta < \frac{\pi}{2}$, $dx = \frac{2 d\theta}{\cos^2 \theta}$, $\sqrt{x^2 + 4} = \frac{2}{\cos \theta}$;

$$\int \frac{x^3 dx}{\sqrt{x^2 + 4}} = \int \frac{(8 \tan^3 \theta) (\cos \theta) d\theta}{\cos^2 \theta} = 8 \int \frac{\sin^3 \theta d\theta}{\cos^4 \theta} = 8 \int \frac{(\cos^2 \theta - 1)(-\sin \theta) d\theta}{\cos^4 \theta}$$

$$[t = \cos \theta] \rightarrow 8 \int \frac{t^2 - 1}{t^4} dt = 8 \int \left(\frac{1}{t^2} - \frac{1}{t^4} \right) dt = 8 \left(-\frac{1}{t} + \frac{1}{3t^3} \right) + C = 8 \left(-\sec \theta + \frac{\sec^3 \theta}{3} \right) + C$$

$$= 8 \left(-\frac{\sqrt{x^2 + 4}}{2} + \frac{(x^2 + 4)^{3/2}}{8 \cdot 3} \right) + C = \frac{1}{3} (x^2 + 4)^{3/2} - 4\sqrt{x^2 + 4} + C$$

16. $x = \tan \theta$, $-\frac{\pi}{2} < \theta < \frac{\pi}{2}$, $dx = \sec^2 \theta d\theta$, $\sqrt{x^2 + 1} = \sec \theta$;

$$\int \frac{dx}{x^2 \sqrt{x^2 + 1}} = \int \frac{\sec^2 \theta d\theta}{\tan^2 \theta \sec \theta} = \int \frac{\cos \theta d\theta}{\sin^2 \theta} = -\frac{1}{\sin \theta} + C = \frac{-\sqrt{x^2 + 1}}{x} + C$$

17. $w = 2 \sin \theta$, $-\frac{\pi}{2} < \theta < \frac{\pi}{2}$, $dw = 2 \cos \theta d\theta$, $\sqrt{4 - w^2} = 2 \cos \theta$;

$$\int \frac{8 dw}{w^2 \sqrt{4 - w^2}} = \int \frac{8 \cdot 2 \cos \theta d\theta}{4 \sin^2 \theta \cdot 2 \cos \theta} = 2 \int \frac{d\theta}{\sin^2 \theta} = -2 \cot \theta + C = \frac{-2\sqrt{4 - w^2}}{w} + C$$

18. $w = 3 \sin \theta$, $-\frac{\pi}{2} < \theta < \frac{\pi}{2}$, $dw = 3 \cos \theta d\theta$, $\sqrt{9 - w^2} = 3 \cos \theta$;

$$\int \frac{\sqrt{9 - w^2}}{w^2} dw = \int \frac{3 \cos \theta \cdot 3 \cos \theta d\theta}{9 \sin^2 \theta} = \int \cot^2 \theta d\theta = \int \left(\frac{1 - \sin^2 \theta}{\sin^2 \theta} \right) d\theta = \int (\csc^2 \theta - 1) d\theta$$

$$= -\cot \theta - \theta + C = -\frac{\sqrt{9 - w^2}}{w} - \sin^{-1} \left(\frac{w}{3} \right) + C$$

19. $x = \sin \theta$, $0 \leq \theta \leq \frac{\pi}{3}$, $dx = \cos \theta d\theta$, $(1 - x^2)^{3/2} = \cos^3 \theta$;

$$\int_0^{\sqrt{3}/2} \frac{4x^2 dx}{(1 - x^2)^{3/2}} = \int_0^{\pi/3} \frac{4 \sin^2 \theta \cos \theta d\theta}{\cos^3 \theta} = 4 \int_0^{\pi/3} \left(\frac{1 - \cos^2 \theta}{\cos^2 \theta} \right) d\theta = 4 \int_0^{\pi/3} (\sec^2 \theta - 1) d\theta$$

$$= 4 [\tan \theta - \theta]_0^{\pi/3} = 4\sqrt{3} - \frac{4\pi}{3}$$

20. $x = 2 \sin \theta$, $0 \leq \theta \leq \frac{\pi}{6}$, $dx = 2 \cos \theta d\theta$, $(4 - x^2)^{3/2} = 8 \cos^3 \theta$;

$$\int_0^1 \frac{dx}{(4-x^2)^{3/2}} = \int_0^{\pi/6} \frac{2 \cos \theta d\theta}{8 \cos^3 \theta} = \frac{1}{4} \int_0^{\pi/6} \frac{d\theta}{\cos^2 \theta} = \frac{1}{4} [\tan \theta]_0^{\pi/6} = \frac{\sqrt{3}}{12} = \frac{1}{4\sqrt{3}}$$

21. $x = \sec \theta$, $0 < \theta < \frac{\pi}{2}$, $dx = \sec \theta \tan \theta d\theta$, $(x^2 - 1)^{3/2} = \tan^3 \theta$;

$$\int \frac{dx}{(x^2-1)^{3/2}} = \int \frac{\sec \theta \tan \theta d\theta}{\tan^3 \theta} = \int \frac{\cos \theta d\theta}{\sin^2 \theta} = -\frac{1}{\sin \theta} + C = -\frac{x}{\sqrt{x^2-1}} + C$$

22. $x = \sec \theta$, $0 < \theta < \frac{\pi}{2}$, $dx = \sec \theta \tan \theta d\theta$, $(x^2 - 1)^{5/2} = \tan^5 \theta$;

$$\int \frac{x^2 dx}{(x^2-1)^{5/2}} = \int \frac{\sec^2 \theta \sec \theta \tan \theta d\theta}{\tan^5 \theta} = \int \frac{\cos \theta}{\sin^4 \theta} d\theta = -\frac{1}{3 \sin^3 \theta} + C = -\frac{x^3}{3(x^2-1)^{3/2}} + C$$

23. $x = \sin \theta$, $-\frac{\pi}{2} < \theta < \frac{\pi}{2}$, $dx = \cos \theta d\theta$, $(1 - x^2)^{3/2} = \cos^3 \theta$;

$$\int \frac{(1-x^2)^{3/2} dx}{x^6} = \int \frac{\cos^3 \theta \cos \theta d\theta}{\sin^6 \theta} = \int \cot^4 \theta \csc^2 \theta d\theta = -\frac{\cot^5 \theta}{5} + C = -\frac{1}{5} \left(\frac{\sqrt{1-x^2}}{x} \right)^5 + C$$

24. $x = \sin \theta$, $-\frac{\pi}{2} < \theta < \frac{\pi}{2}$, $dx = \cos \theta d\theta$, $(1 - x^2)^{1/2} = \cos \theta$;

$$\int \frac{(1-x^2)^{1/2} dx}{x^4} = \int \frac{\cos \theta \cos \theta d\theta}{\sin^4 \theta} = \int \cot^2 \theta \csc^2 \theta d\theta = -\frac{\cot^3 \theta}{3} + C = -\frac{1}{3} \left(\frac{\sqrt{1-x^2}}{x} \right)^3 + C$$

25. $x = \frac{1}{2} \tan \theta$, $-\frac{\pi}{2} < \theta < \frac{\pi}{2}$, $dx = \frac{1}{2} \sec^2 \theta d\theta$, $(4x^2 + 1)^2 = \sec^4 \theta$;

$$\int \frac{8 dx}{(4x^2+1)^2} = \int \frac{8 \left(\frac{1}{2} \sec^2 \theta\right) d\theta}{\sec^4 \theta} = 4 \int \cos^2 \theta d\theta = 2(\theta + \sin \theta \cos \theta) + C = 2 \tan^{-1} 2x + \frac{4x}{(4x^2+1)} + C$$

26. $t = \frac{1}{3} \tan \theta$, $-\frac{\pi}{2} < \theta < \frac{\pi}{2}$, $dt = \frac{1}{3} \sec^2 \theta d\theta$, $9t^2 + 1 = \sec^2 \theta$;

$$\int \frac{6 dt}{(9t^2+1)^2} = \int \frac{6 \left(\frac{1}{3} \sec^2 \theta\right) d\theta}{\sec^4 \theta} = 2 \int \cos^2 \theta d\theta = \theta + \sin \theta \cos \theta + C = \tan^{-1} 3t + \frac{3t}{(9t^2+1)} + C$$

27. $v = \sin \theta$, $-\frac{\pi}{2} < \theta < \frac{\pi}{2}$, $dv = \cos \theta d\theta$, $(1 - v^2)^{5/2} = \cos^5 \theta$;

$$\int \frac{v^2 dv}{(1-v^2)^{5/2}} = \int \frac{\sin^2 \theta \cos \theta d\theta}{\cos^5 \theta} = \int \tan^2 \theta \sec^2 \theta d\theta = \frac{\tan^3 \theta}{3} + C = \frac{1}{3} \left(\frac{v}{\sqrt{1-v^2}} \right)^3 + C$$

28. $r = \sin \theta$, $-\frac{\pi}{2} < \theta < \frac{\pi}{2}$;

$$\int \frac{(1-r^2)^{5/2} dr}{r^8} = \int \frac{\cos^5 \theta \cos \theta d\theta}{\sin^8 \theta} = \int \cot^6 \theta \csc^2 \theta d\theta = -\frac{\cot^7 \theta}{7} + C = -\frac{1}{7} \left[\frac{\sqrt{1-r^2}}{r} \right]^7 + C$$

29. Let $e^t = 3 \tan \theta$, $t = \ln(3 \tan \theta)$, $\tan^{-1}(\frac{1}{3}) \leq \theta \leq \tan^{-1}(\frac{4}{3})$, $dt = \frac{\sec^2 \theta}{\tan \theta} d\theta$, $\sqrt{e^{2t} + 9} = \sqrt{9 \tan^2 \theta + 9} = 3 \sec \theta$;

$$\begin{aligned} \int_0^{\ln 4} \frac{e^t dt}{\sqrt{e^{2t} + 9}} &= \int_{\tan^{-1}(1/3)}^{\tan^{-1}(4/3)} \frac{3 \tan \theta \sec^2 \theta d\theta}{\tan \theta \cdot 3 \sec \theta} = \int_{\tan^{-1}(1/3)}^{\tan^{-1}(4/3)} \sec \theta d\theta = [\ln |\sec \theta + \tan \theta|]_{\tan^{-1}(1/3)}^{\tan^{-1}(4/3)} \\ &= \ln \left(\frac{5}{3} + \frac{4}{3} \right) - \ln \left(\frac{\sqrt{10}}{3} + \frac{1}{3} \right) = \ln 9 - \ln \left(1 + \sqrt{10} \right) \end{aligned}$$

30. Let $e^t = \tan \theta$, $t = \ln(\tan \theta)$, $\tan^{-1}(\frac{3}{4}) \leq \theta \leq \tan^{-1}(\frac{4}{3})$, $dt = \frac{\sec^2 \theta}{\tan \theta} d\theta$, $1 + e^{2t} = 1 + \tan^2 \theta = \sec^2 \theta$;

$$\int_{\ln(3/4)}^{\ln(4/3)} \frac{e^t dt}{(1+e^{2t})^{3/2}} = \int_{\tan^{-1}(3/4)}^{\tan^{-1}(4/3)} \frac{(\tan \theta) \left(\frac{\sec^2 \theta}{\tan \theta} \right) d\theta}{\sec^3 \theta} = \int_{\tan^{-1}(3/4)}^{\tan^{-1}(4/3)} \cos \theta d\theta = [\sin \theta]_{\tan^{-1}(3/4)}^{\tan^{-1}(4/3)} = \frac{4}{5} - \frac{3}{5} = \frac{1}{5}$$

31. $\int_{1/\sqrt{3}}^{1/4} \frac{2 dt}{\sqrt{t+4t\sqrt{t}}}$; $[u = 2\sqrt{t}, du = \frac{1}{\sqrt{t}} dt] \rightarrow \int_{1/\sqrt{3}}^1 \frac{2 du}{1+u^2}$; $u = \tan \theta$, $\frac{\pi}{6} \leq \theta \leq \frac{\pi}{4}$, $du = \sec^2 \theta d\theta$, $1 + u^2 = \sec^2 \theta$;

$$\int_{1/\sqrt{3}}^1 \frac{2 du}{1+u^2} = \int_{\pi/6}^{\pi/4} \frac{2 \sec^2 \theta d\theta}{\sec^2 \theta} = [2\theta]_{\pi/6}^{\pi/4} = 2 \left(\frac{\pi}{4} - \frac{\pi}{6} \right) = \frac{\pi}{6}$$

32. $y = e^{\tan \theta}$, $0 \leq \theta \leq \frac{\pi}{4}$, $dy = e^{\tan \theta} \sec^2 \theta d\theta$, $\sqrt{1 + (\ln y)^2} = \sqrt{1 + \tan^2 \theta} = \sec \theta$;

$$\int_1^e \frac{dy}{y\sqrt{1+(\ln y)^2}} = \int_0^{\pi/4} \frac{e^{\tan \theta} \sec^2 \theta}{e^{\tan \theta} \sec \theta} d\theta = \int_0^{\pi/4} \sec \theta d\theta = [\ln |\sec \theta + \tan \theta|]_0^{\pi/4} = \ln(1 + \sqrt{2})$$

33. $x = \sec \theta$, $0 < \theta < \frac{\pi}{2}$, $dx = \sec \theta \tan \theta d\theta$, $\sqrt{x^2 - 1} = \sqrt{\sec^2 \theta - 1} = \tan \theta$;

$$\int \frac{dx}{x\sqrt{x^2-1}} = \int \frac{\sec \theta \tan \theta d\theta}{\sec \theta \tan \theta} = \theta + C = \sec^{-1} x + C$$

34. $x = \tan \theta$, $dx = \sec^2 \theta d\theta$, $1 + x^2 = \sec^2 \theta$;

$$\int \frac{dx}{x^2+1} = \int \frac{\sec^2 \theta d\theta}{\sec^2 \theta} = \theta + C = \tan^{-1} x + C$$

35. $x = \sec \theta$, $dx = \sec \theta \tan \theta d\theta$, $\sqrt{x^2 - 1} = \sqrt{\sec^2 \theta - 1} = \tan \theta$;

$$\int \frac{x dx}{\sqrt{x^2-1}} = \int \frac{\sec \theta \sec \theta \tan \theta d\theta}{\tan \theta} = \int \sec^2 \theta d\theta = \tan \theta + C = \sqrt{x^2 - 1} + C$$

36. $x = \sin \theta$, $dx = \cos \theta d\theta$, $-\frac{\pi}{2} < \theta < \frac{\pi}{2}$;

$$\int \frac{dx}{\sqrt{1-x^2}} = \int \frac{\cos \theta d\theta}{\cos \theta} = \theta + C = \sin^{-1} x + C$$

37. $x \frac{dy}{dx} = \sqrt{x^2 - 4}$; $dy = \sqrt{x^2 - 4} \frac{dx}{x}$; $y = \int \frac{\sqrt{x^2 - 4}}{x} dx$; $\left[\begin{array}{l} x = 2 \sec \theta, 0 < \theta < \frac{\pi}{2} \\ dx = 2 \sec \theta \tan \theta d\theta \\ \sqrt{x^2 - 4} = 2 \tan \theta \end{array} \right]$

$$\rightarrow y = \int \frac{(2 \tan \theta)(2 \sec \theta \tan \theta d\theta)}{2 \sec \theta} = 2 \int \tan^2 \theta d\theta = 2 \int (\sec^2 \theta - 1) d\theta = 2(\tan \theta - \theta) + C$$

$$= 2 \left[\frac{\sqrt{x^2-4}}{2} - \sec^{-1} \left(\frac{x}{2} \right) \right] + C; x = 2 \text{ and } y = 0 \Rightarrow 0 = 0 + C \Rightarrow C = 0 \Rightarrow y = 2 \left[\frac{\sqrt{x^2-4}}{2} - \sec^{-1} \frac{x}{2} \right]$$

38. $\sqrt{x^2 - 9} \frac{dy}{dx} = 1$, $dy = \frac{dx}{\sqrt{x^2 - 9}}$; $y = \int \frac{dx}{\sqrt{x^2 - 9}}$; $\left[\begin{array}{l} x = 3 \sec \theta, 0 < \theta < \frac{\pi}{2} \\ dx = 3 \sec \theta \tan \theta d\theta \\ \sqrt{x^2 - 9} = 3 \tan \theta \end{array} \right] \rightarrow y = \int \frac{3 \sec \theta \tan \theta d\theta}{3 \tan \theta}$

$$= \int \sec \theta d\theta = \ln |\sec \theta + \tan \theta| + C = \ln \left| \frac{x}{3} + \frac{\sqrt{x^2-9}}{3} \right| + C; x = 5 \text{ and } y = \ln 3 \Rightarrow \ln 3 = \ln 3 + C \Rightarrow C = 0$$

$$\Rightarrow y = \ln \left| \frac{x}{3} + \frac{\sqrt{x^2-9}}{3} \right|$$

39. $(x^2 + 4) \frac{dy}{dx} = 3$, $dy = \frac{3 dx}{x^2 + 4}$; $y = 3 \int \frac{dx}{x^2 + 4} = \frac{3}{2} \tan^{-1} \frac{x}{2} + C$; $x = 2$ and $y = 0 \Rightarrow 0 = \frac{3}{2} \tan^{-1} 1 + C$

$$\Rightarrow C = -\frac{3\pi}{8} \Rightarrow y = \frac{3}{2} \tan^{-1} \left(\frac{x}{2} \right) - \frac{3\pi}{8}$$

40. $(x^2 + 1)^2 \frac{dy}{dx} = \sqrt{x^2 + 1}$, $dy = \frac{dx}{(x^2 + 1)^{3/2}}$; $x = \tan \theta$, $dx = \sec^2 \theta d\theta$, $(x^2 + 1)^{3/2} = \sec^3 \theta$;

$$y = \int \frac{\sec^2 \theta d\theta}{\sec^3 \theta} = \int \cos \theta d\theta = \sin \theta + C = \tan \theta \cos \theta + C = \frac{\tan \theta}{\sec \theta} + C = \frac{x}{\sqrt{x^2+1}} + C; x = 0 \text{ and } y = 1$$

$$\Rightarrow 1 = 0 + C \Rightarrow y = \frac{x}{\sqrt{x^2+1}} + 1$$

41. $A = \int_0^3 \frac{\sqrt{9-x^2}}{3} dx$; $x = 3 \sin \theta$, $0 \leq \theta \leq \frac{\pi}{2}$, $dx = 3 \cos \theta d\theta$, $\sqrt{9-x^2} = \sqrt{9-9\sin^2 \theta} = 3 \cos \theta$;

$$A = \int_0^{\pi/2} \frac{3 \cos \theta \cdot 3 \cos \theta d\theta}{3} = 3 \int_0^{\pi/2} \cos^2 \theta d\theta = \frac{3}{2} [\theta + \sin \theta \cos \theta]_0^{\pi/2} = \frac{3\pi}{4}$$

$$\begin{aligned}
 42. \quad V &= \int_0^1 \pi \left(\frac{2}{1+x^2} \right)^2 dx = 4\pi \int_0^1 \frac{dx}{(x^2+1)^2}; \\
 x &= \tan \theta, dx = \sec^2 \theta d\theta, x^2 + 1 = \sec^2 \theta; \\
 V &= 4\pi \int_0^{\pi/4} \frac{\sec^2 \theta d\theta}{\sec^4 \theta} = 4\pi \int_0^{\pi/4} \cos^2 \theta d\theta \\
 &= 2\pi \int_0^{\pi/4} (1 + \cos 2\theta) d\theta = 2\pi \left[\theta + \frac{\sin 2\theta}{2} \right]_0^{\pi/4} = \pi \left(\frac{\pi}{2} + 1 \right)
 \end{aligned}$$

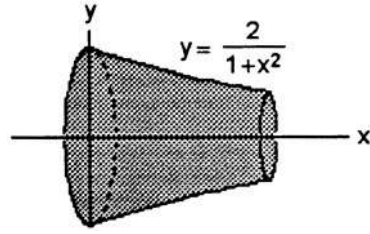

$$43. \quad \int \frac{dx}{1 - \sin x} = \int \frac{\left(\frac{2 dz}{1+z^2} \right)}{1 - \left(\frac{2z}{1+z^2} \right)} = \int \frac{2 dz}{(1-z)^2} = \frac{2}{1-z} + C = \frac{2}{1 - \tan\left(\frac{x}{2}\right)} + C$$

$$\begin{aligned}
 44. \quad \int \frac{dx}{1 + \sin x + \cos x} &= \int \frac{\left(\frac{2 dz}{1+z^2} \right)}{1 + \left(\frac{2z}{1+z^2} + \frac{1-z^2}{1+z^2} \right)} = \int \frac{2 dz}{1+z^2+2z+1-z^2} = \int \frac{dz}{1+z} = \ln |1+z| + C \\
 &= \ln \left| \tan\left(\frac{x}{2}\right) + 1 \right| + C
 \end{aligned}$$

$$45. \quad \int_0^{\pi/2} \frac{dx}{1 + \sin x} = \int_0^1 \frac{\left(\frac{2 dz}{1+z^2} \right)}{1 + \left(\frac{2z}{1+z^2} \right)} = \int_0^1 \frac{2 dz}{(1+z)^2} = - \left[\frac{2}{1+z} \right]_0^1 = -(1-2) = 1$$

$$46. \quad \int_{\pi/3}^{\pi/2} \frac{dx}{1 - \cos x} = \int_{1/\sqrt{3}}^1 \frac{\left(\frac{2 dz}{1+z^2} \right)}{1 - \left(\frac{1-z^2}{1+z^2} \right)} = \int_{1/\sqrt{3}}^1 \frac{dz}{z^2} = \left[-\frac{1}{z} \right]_{1/\sqrt{3}}^1 = \sqrt{3} - 1$$

$$\begin{aligned}
 47. \quad \int_0^{\pi/2} \frac{d\theta}{2 + \cos \theta} &= \int_0^1 \frac{\left(\frac{2 dz}{1+z^2} \right)}{2 + \left(\frac{1-z^2}{1+z^2} \right)} = \int_0^1 \frac{2 dz}{2+2z^2+1-z^2} = \int_0^1 \frac{2 dz}{z^2+3} = \frac{2}{\sqrt{3}} \left[\tan^{-1} \frac{z}{\sqrt{3}} \right]_0^1 = \frac{2}{\sqrt{3}} \tan^{-1} \frac{1}{\sqrt{3}} \\
 &= \frac{\pi}{3\sqrt{3}} = \frac{\sqrt{3}\pi}{9}
 \end{aligned}$$

$$\begin{aligned}
 48. \quad \int_{\pi/2}^{2\pi/3} \frac{\cos \theta d\theta}{\sin \theta \cos \theta + \sin \theta} &= \int_1^{\sqrt{3}} \frac{\left(\frac{1-z^2}{1+z^2} \right) \left(\frac{2 dz}{1+z^2} \right)}{\left[\frac{2z(1-z^2)}{(1+z^2)^2} + \left(\frac{2z}{1+z^2} \right) \right]} = \int_1^{\sqrt{3}} \frac{2(1-z^2) dz}{2z - 2z^3 + 2z + 2z^3} = \int_1^{\sqrt{3}} \frac{1-z^2}{2z} dz \\
 &= \left[\frac{1}{2} \ln z - \frac{z^2}{4} \right]_1^{\sqrt{3}} = \left(\frac{1}{2} \ln \sqrt{3} - \frac{3}{4} \right) - \left(0 - \frac{1}{4} \right) = \frac{\ln 3}{4} - \frac{1}{2} = \frac{1}{4} (\ln 3 - 2) = \frac{1}{2} (\ln \sqrt{3} - 1)
 \end{aligned}$$

$$\begin{aligned}
 49. \quad \int \frac{dt}{\sin t - \cos t} &= \int \frac{\left(\frac{2 dz}{1+z^2} \right)}{\left(\frac{2z}{1+z^2} - \frac{1-z^2}{1+z^2} \right)} = \int \frac{2 dz}{2z-1+z^2} = \int \frac{2 dz}{(z+1)^2-2} = \frac{1}{\sqrt{2}} \ln \left| \frac{z+1-\sqrt{2}}{z+1+\sqrt{2}} \right| + C \\
 &= \frac{1}{\sqrt{2}} \ln \left| \frac{\tan\left(\frac{t}{2}\right) + 1 - \sqrt{2}}{\tan\left(\frac{t}{2}\right) + 1 + \sqrt{2}} \right| + C
 \end{aligned}$$

$$\begin{aligned}
 50. \quad \int \frac{\cos t dt}{1 - \cos t} &= \int \frac{\left(\frac{1-z^2}{1+z^2} \right) \left(\frac{2 dz}{1+z^2} \right)}{1 - \left(\frac{1-z^2}{1+z^2} \right)} = \int \frac{2(1-z^2) dz}{(1+z^2)^2 - (1+z^2)(1-z^2)} = \int \frac{2(1-z^2) dz}{(1+z^2)(1+z^2-1+z^2)} \\
 &= \int \frac{(1-z^2) dz}{(1+z^2)z^2} = \int \frac{dz}{z^2(1+z^2)} - \int \frac{dz}{1+z^2} = \int \frac{dz}{z^2} - 2 \int \frac{dz}{z^2+1} = -\frac{1}{z} - 2 \tan^{-1} z + C = -\cot\left(\frac{t}{2}\right) - t + C
 \end{aligned}$$

$$\begin{aligned}
 51. \quad \int \sec \theta d\theta &= \int \frac{d\theta}{\cos \theta} = \int \frac{\left(\frac{2 dz}{1+z^2} \right)}{\left(\frac{1-z^2}{1+z^2} \right)} = \int \frac{2 dz}{1-z^2} = \int \frac{2 dz}{(1+z)(1-z)} = \int \frac{dz}{1+z} + \int \frac{dz}{1-z} \\
 &= \ln |1+z| - \ln |1-z| + C = \ln \left| \frac{1 + \tan\left(\frac{\theta}{2}\right)}{1 - \tan\left(\frac{\theta}{2}\right)} \right| + C
 \end{aligned}$$

$$52. \quad \int \csc \theta d\theta = \int \frac{d\theta}{\sin \theta} = \int \frac{\left(\frac{2 dz}{1+z^2} \right)}{\left(\frac{2z}{1+z^2} \right)} = \int \frac{dz}{z} = \ln |z| + C = \ln \left| \tan \frac{\theta}{2} \right| + C$$

8.6 INTEGRAL TABLES AND COMPUTER ALGEBRA SYSTEMS

$$1. \int \frac{dx}{x\sqrt{x-3}} = \frac{2}{\sqrt{3}} \tan^{-1} \sqrt{\frac{x-3}{3}} + C$$

(We used FORMULA 13(a) with $a = 1$, $b = 3$)

$$2. \int \frac{dx}{x\sqrt{x+4}} = \frac{1}{\sqrt{4}} \ln \left| \frac{\sqrt{x+4}-\sqrt{4}}{\sqrt{x+4}+\sqrt{4}} \right| + C = \frac{1}{2} \ln \left| \frac{\sqrt{x+4}-2}{\sqrt{x+4}+2} \right| + C$$

(We used FORMULA 13(b) with $a = 1$, $b = 4$)

$$3. \int \frac{x dx}{\sqrt{x-2}} = \int \frac{(x-2) dx}{\sqrt{x-2}} + 2 \int \frac{dx}{\sqrt{x-2}} = \int (\sqrt{x-2})^1 dx + 2 \int (\sqrt{x-2})^{-1} dx$$

$$= \left(\frac{2}{1}\right) \frac{(\sqrt{x-2})^3}{3} + 2 \left(\frac{2}{1}\right) \frac{(\sqrt{x-2})^1}{1} = \sqrt{x-2} \left[\frac{2(x-2)}{3} + 4 \right] + C$$

(We used FORMULA 11 with $a = 1$, $b = -2$, $n = 1$ and $a = 1$, $b = -2$, $n = -1$)

$$4. \int \frac{x dx}{(2x+3)^{3/2}} = \frac{1}{2} \int \frac{(2x+3) dx}{(2x+3)^{3/2}} - \frac{3}{2} \int \frac{dx}{(2x+3)^{3/2}} = \frac{1}{2} \int \frac{dx}{\sqrt{2x+3}} - \frac{3}{2} \int \frac{dx}{(\sqrt{2x+3})^3}$$

$$= \frac{1}{2} \int (\sqrt{2x+3})^{-1} dx - \frac{3}{2} \int (\sqrt{2x+3})^{-3} dx = \left(\frac{1}{2}\right) \left(\frac{2}{2}\right) \frac{(\sqrt{2x+3})^1}{1} - \left(\frac{3}{2}\right) \left(\frac{2}{2}\right) \frac{(\sqrt{2x+3})^{-1}}{(-1)} + C$$

$$= \frac{1}{2\sqrt{2x+3}} (2x+3+3) + C = \frac{(x+3)}{\sqrt{2x+3}} + C$$

(We used FORMULA 11 with $a = 2$, $b = 3$, $n = -1$ and $a = 2$, $b = 3$, $n = -3$)

$$5. \int x\sqrt{2x-3} dx = \frac{1}{2} \int (2x-3)\sqrt{2x-3} dx + \frac{3}{2} \int \sqrt{2x-3} dx = \frac{1}{2} \int (\sqrt{2x-3})^3 dx + \frac{3}{2} \int (\sqrt{2x-3})^1 dx$$

$$= \left(\frac{1}{2}\right) \left(\frac{2}{2}\right) \frac{(\sqrt{2x-3})^5}{5} + \left(\frac{3}{2}\right) \left(\frac{2}{2}\right) \frac{(\sqrt{2x-3})^3}{3} + C = \frac{(2x-3)^{3/2}}{2} \left[\frac{2x-3}{5} + 1 \right] + C = \frac{(2x-3)^{3/2}(x+1)}{5} + C$$

(We used FORMULA 11 with $a = 2$, $b = -3$, $n = 3$ and $a = 2$, $b = -3$, $n = 1$)

$$6. \int x(7x+5)^{3/2} dx = \frac{1}{7} \int (7x+5)(7x+5)^{3/2} dx - \frac{5}{7} \int (7x+5)^{3/2} dx = \frac{1}{7} \int (\sqrt{7x+5})^5 dx - \frac{5}{7} \int (\sqrt{7x+5})^3 dx$$

$$= \left(\frac{1}{7}\right) \left(\frac{2}{7}\right) \frac{(\sqrt{7x+5})^7}{7} - \left(\frac{5}{7}\right) \left(\frac{2}{7}\right) \frac{(\sqrt{7x+5})^5}{5} + C = \left[\frac{(7x+5)^{5/2}}{49} \right] \left[\frac{2(7x+5)}{7} - 2 \right] + C$$

$$= \left[\frac{(7x+5)^{5/2}}{49} \right] \left(\frac{14x-4}{7} \right) + C$$

(We used FORMULA 11 with $a = 7$, $b = 5$, $n = 5$ and $a = 7$, $b = 5$, $n = 3$)

$$7. \int \frac{\sqrt{9-4x}}{x^2} dx = -\frac{\sqrt{9-4x}}{x} + \frac{(-4)}{2} \int \frac{dx}{x\sqrt{9-4x}} + C$$

(We used FORMULA 14 with $a = -4$, $b = 9$)

$$= -\frac{\sqrt{9-4x}}{x} - 2 \left(\frac{1}{\sqrt{9}} \right) \ln \left| \frac{\sqrt{9-4x}-\sqrt{9}}{\sqrt{9-4x}+\sqrt{9}} \right| + C$$

(We used FORMULA 13(b) with $a = -4$, $b = 9$)

$$= -\frac{\sqrt{9-4x}}{x} - \frac{2}{3} \ln \left| \frac{\sqrt{9-4x}-3}{\sqrt{9-4x}+3} \right| + C$$

$$8. \int \frac{dx}{x^2\sqrt{4x-9}} = -\frac{\sqrt{4x-9}}{(-9)x} + \frac{4}{18} \int \frac{dx}{x\sqrt{4x-9}} + C$$

(We used FORMULA 15 with $a = 4$, $b = -9$)

$$= \frac{\sqrt{4x-9}}{9x} + \left(\frac{2}{9}\right) \left(\frac{2}{\sqrt{9}}\right) \tan^{-1} \sqrt{\frac{4x-9}{9}} + C$$

(We used FORMULA 13(a) with $a = 4$, $b = 9$)

$$= \frac{\sqrt{4x-9}}{9x} + \frac{4}{27} \tan^{-1} \sqrt{\frac{4x-9}{9}} + C$$

$$\begin{aligned}
 9. \int x\sqrt{4x-x^2} dx &= \int x\sqrt{2\cdot 2x-x^2} dx = \frac{(x+2)(2x-3\cdot 2)\sqrt{2\cdot 2x-x^2}}{6} + \frac{2^3}{2} \sin^{-1}\left(\frac{x-2}{2}\right) + C \\
 &= \frac{(x+2)(2x-6)\sqrt{4x-x^2}}{6} + 4 \sin^{-1}\left(\frac{x-2}{2}\right) + C = \frac{(x+2)(x-3)\sqrt{4x-x^2}}{3} + 4 \sin^{-1}\left(\frac{x-2}{2}\right) + C \\
 &\text{(We used FORMULA 51 with } a = 2\text{)}
 \end{aligned}$$

$$\begin{aligned}
 10. \int \frac{\sqrt{x-x^2}}{x} dx &= \int \frac{\sqrt{2\cdot \frac{1}{2}x-x^2}}{x} dx = \sqrt{2\cdot \frac{1}{2}x-x^2} + \frac{1}{2} \sin^{-1}\left(\frac{x-\frac{1}{2}}{\frac{1}{2}}\right) + C = \sqrt{x-x^2} + \frac{1}{2} \sin^{-1}(2x-1) + C \\
 &\text{(We used FORMULA 52 with } a = \frac{1}{2}\text{)}
 \end{aligned}$$

$$\begin{aligned}
 11. \int \frac{dx}{x\sqrt{7+x^2}} &= \int \frac{dx}{x\sqrt{(\sqrt{7})^2+x^2}} = -\frac{1}{\sqrt{7}} \ln \left| \frac{\sqrt{7} + \sqrt{(\sqrt{7})^2+x^2}}{x} \right| + C = -\frac{1}{\sqrt{7}} \ln \left| \frac{\sqrt{7} + \sqrt{7+x^2}}{x} \right| + C \\
 &\text{(We used FORMULA 26 with } a = \sqrt{7}\text{)}
 \end{aligned}$$

$$\begin{aligned}
 12. \int \frac{dx}{x\sqrt{7-x^2}} &= \int \frac{dx}{x\sqrt{(\sqrt{7})^2-x^2}} = -\frac{1}{\sqrt{7}} \ln \left| \frac{\sqrt{7} + \sqrt{(\sqrt{7})^2-x^2}}{x} \right| + C = -\frac{1}{\sqrt{7}} \ln \left| \frac{\sqrt{7} + \sqrt{7-x^2}}{x} \right| + C \\
 &\text{(We used FORMULA 34 with } a = \sqrt{7}\text{)}
 \end{aligned}$$

$$\begin{aligned}
 13. \int \frac{\sqrt{4-x^2}}{x} dx &= \int \frac{\sqrt{2^2-x^2}}{x} dx = \sqrt{2^2-x^2} - 2 \ln \left| \frac{2 + \sqrt{2^2-x^2}}{x} \right| + C = \sqrt{4-x^2} - 2 \ln \left| \frac{2 + \sqrt{4-x^2}}{x} \right| + C \\
 &\text{(We used FORMULA 31 with } a = 2\text{)}
 \end{aligned}$$

$$\begin{aligned}
 14. \int \frac{\sqrt{x^2-4}}{x} dx &= \int \frac{\sqrt{x^2-2^2}}{x} dx = \sqrt{x^2-2^2} - 2 \sec^{-1} \left| \frac{x}{2} \right| + C = \sqrt{x^2-4} - 2 \sec^{-1} \left| \frac{x}{2} \right| + C \\
 &\text{(We used FORMULA 42 with } a = 2\text{)}
 \end{aligned}$$

$$\begin{aligned}
 15. \int \sqrt{25-p^2} dp &= \int \sqrt{5^2-p^2} dp = \frac{p}{2} \sqrt{5^2-p^2} + \frac{5^2}{2} \sin^{-1} \frac{p}{5} + C = \frac{p}{2} \sqrt{25-p^2} + \frac{25}{2} \sin^{-1} \frac{p}{5} + C \\
 &\text{(We used FORMULA 29 with } a = 5\text{)}
 \end{aligned}$$

$$\begin{aligned}
 16. \int q^2 \sqrt{25-q^2} dq &= \int q^2 \sqrt{5^2-q^2} dq = \frac{5^4}{8} \sin^{-1} \left(\frac{q}{5} \right) - \frac{1}{8} q \sqrt{5^2-q^2} (5^2-2q^2) + C \\
 &= \frac{625}{8} \sin^{-1} \left(\frac{q}{5} \right) - \frac{1}{8} q \sqrt{25-q^2} (25-2q^2) + C \\
 &\text{(We used FORMULA 30 with } a = 5\text{)}
 \end{aligned}$$

$$\begin{aligned}
 17. \int \frac{r^2}{\sqrt{4-r^2}} dr &= \int \frac{r^2}{\sqrt{2^2-r^2}} dr = \frac{2^2}{2} \sin^{-1} \left(\frac{r}{2} \right) - \frac{1}{2} r \sqrt{2^2-r^2} + C = 2 \sin^{-1} \left(\frac{r}{2} \right) - \frac{1}{2} r \sqrt{4-r^2} + C \\
 &\text{(We used FORMULA 33 with } a = 2\text{)}
 \end{aligned}$$

$$\begin{aligned}
 18. \int \frac{ds}{\sqrt{s^2-2}} &= \int \frac{ds}{\sqrt{s^2-(\sqrt{2})^2}} = \cosh^{-1} \frac{s}{\sqrt{2}} + C = \ln \left| s + \sqrt{s^2 - (\sqrt{2})^2} \right| + C = \ln \left| s + \sqrt{s^2-2} \right| + C \\
 &\text{(We used FORMULA 36 with } a = \sqrt{2}\text{)}
 \end{aligned}$$

$$\begin{aligned}
 19. \int \frac{d\theta}{5+4 \sin 2\theta} &= \frac{-2}{2\sqrt{25-16}} \tan^{-1} \left[\sqrt{\frac{5-4}{5+4}} \tan \left(\frac{\pi}{4} - \frac{2\theta}{2} \right) \right] + C = -\frac{1}{3} \tan^{-1} \left[\frac{1}{3} \tan \left(\frac{\pi}{4} - \theta \right) \right] + C \\
 &\text{(We used FORMULA 70 with } b = 5, c = 4, a = 2\text{)}
 \end{aligned}$$

$$\begin{aligned}
 20. \int \frac{d\theta}{4+5 \sin 2\theta} &= \frac{-1}{2\sqrt{25-16}} \ln \left| \frac{5+4 \sin 2\theta + \sqrt{25-16} \cos 2\theta}{4+5 \sin 2\theta} \right| + C = -\frac{1}{6} \ln \left| \frac{5+4 \sin 2\theta + 3 \cos 2\theta}{4+5 \sin 2\theta} \right| + C \\
 &\text{(We used FORMULA 71 with } a = 2, b = 4, c = 5\text{)}
 \end{aligned}$$

$$21. \int e^{2t} \cos 3t \, dt = \frac{e^{2t}}{2^2+3^2} (2 \cos 3t + 3 \sin 3t) + C = \frac{e^{2t}}{13} (2 \cos 3t + 3 \sin 3t) + C$$

(We used FORMULA 108 with $a = 2$, $b = 3$)

$$22. \int e^{-3t} \sin 4t \, dt = \frac{e^{-3t}}{(-3)^2+4^2} (-3 \sin 4t - 4 \cos 4t) + C = \frac{e^{-3t}}{25} (-3 \sin 4t - 4 \cos 4t) + C$$

(We used FORMULA 107 with $a = -3$, $b = 4$)

$$23. \int x \cos^{-1} x \, dx = \int x^1 \cos^{-1} x \, dx = \frac{x^{1+1}}{1+1} \cos^{-1} x + \frac{1}{1+1} \int \frac{x^{1+1} dx}{\sqrt{1-x^2}} = \frac{x^2}{2} \cos^{-1} x + \frac{1}{2} \int \frac{x^2 dx}{\sqrt{1-x^2}}$$

(We used FORMULA 100 with $a = 1$, $n = 1$)

$$= \frac{x^2}{2} \cos^{-1} x + \frac{1}{2} \left(\frac{1}{2} \sin^{-1} x \right) - \frac{1}{2} \left(\frac{1}{2} x \sqrt{1-x^2} \right) + C = \frac{x^2}{2} \cos^{-1} x + \frac{1}{4} \sin^{-1} x - \frac{1}{4} x \sqrt{1-x^2} + C$$

(We used FORMULA 33 with $a = 1$)

$$24. \int x \tan^{-1} x \, dx = \int x^1 \tan^{-1}(1x) \, dx = \frac{x^{1+1}}{1+1} \tan^{-1}(1x) - \frac{1}{1+1} \int \frac{x^{1+1} dx}{1+(1)^2 x^2} = \frac{x^2}{2} \tan^{-1} x - \frac{1}{2} \int \frac{x^2 dx}{1+x^2}$$

(We used FORMULA 101 with $a = 1$, $n = 1$)

$$= \frac{x^2}{2} \tan^{-1} x - \frac{1}{2} \int \left(1 - \frac{1}{1+x^2} \right) dx \text{ (after long division)}$$

$$= \frac{x^2}{2} \tan^{-1} x - \frac{1}{2} \int dx + \frac{1}{2} \int \frac{1}{1+x^2} dx = \frac{x^2}{2} \tan^{-1} x - \frac{1}{2} x + \frac{1}{2} \tan^{-1} x + C = \frac{1}{2} ((x^2 + 1) \tan^{-1} x - x) + C$$

$$25. \int \frac{ds}{(9-s^2)^2} = \int \frac{ds}{(3^2-s^2)^2} = \frac{s}{2 \cdot 3^2 \cdot (3^2-s^2)} + \frac{1}{4 \cdot 3^3} \ln \left| \frac{s+3}{s-3} \right| + C$$

(We used FORMULA 19 with $a = 3$)

$$= \frac{s}{18(9-s^2)} + \frac{1}{108} \ln \left| \frac{s+3}{s-3} \right| + C$$

$$26. \int \frac{d\theta}{(2-\theta^2)^2} = \int \frac{d\theta}{\left[(\sqrt{2})^2 - \theta^2 \right]^2} = \frac{\theta}{2(\sqrt{2})^2 \left[(\sqrt{2})^2 - \theta^2 \right]} + \frac{1}{4(\sqrt{2})^3} \ln \left| \frac{\theta + \sqrt{2}}{\theta - \sqrt{2}} \right| + C$$

(We used FORMULA 19 with $a = \sqrt{2}$)

$$= \frac{\theta}{4(2-\theta^2)} + \frac{1}{8\sqrt{2}} \ln \left| \frac{\theta + \sqrt{2}}{\theta - \sqrt{2}} \right| + C$$

$$27. \int \frac{\sqrt{4x+9}}{x^2} dx = -\frac{\sqrt{4x+9}}{x} + \frac{4}{2} \int \frac{dx}{x\sqrt{4x+9}}$$

(We used FORMULA 14 with $a = 4$, $b = 9$)

$$= -\frac{\sqrt{4x+9}}{x} + 2 \left(\frac{1}{\sqrt{9}} \ln \left| \frac{\sqrt{4x+9} - \sqrt{9}}{\sqrt{4x+9} + \sqrt{9}} \right| \right) + C = -\frac{\sqrt{4x+9}}{x} + \frac{2}{3} \ln \left| \frac{\sqrt{4x+9} - 3}{\sqrt{4x+9} + 3} \right| + C$$

(We used FORMULA 13(b) with $a = 4$, $b = 9$)

$$28. \int \frac{\sqrt{9x-4}}{x^2} dx = -\frac{\sqrt{9x-4}}{x} + \frac{9}{2} \int \frac{dx}{x\sqrt{9x-4}} + C$$

(We used FORMULA 14 with $a = 9$, $b = -4$)

$$= -\frac{\sqrt{9x-4}}{x} + \frac{9}{2} \left(\frac{2}{\sqrt{4}} \tan^{-1} \sqrt{\frac{9x-4}{4}} \right) + C = -\frac{\sqrt{9x-4}}{x} + \frac{9}{2} \tan^{-1} \frac{\sqrt{9x-4}}{2} + C$$

(We used FORMULA 13(a) with $a = 9$, $b = 4$)

$$29. \int \frac{\sqrt{3t-4}}{t} dt = 2\sqrt{3t-4} + (-4) \int \frac{dt}{t\sqrt{3t-4}}$$

(We used FORMULA 12 with $a = 3$, $b = -4$)

$$= 2\sqrt{3t-4} - 4 \left(\frac{2}{\sqrt{4}} \tan^{-1} \sqrt{\frac{3t-4}{4}} \right) + C = 2\sqrt{3t-4} - 4 \tan^{-1} \frac{\sqrt{3t-4}}{2} + C$$

(We used FORMULA 13(a) with $a = 3$, $b = 4$)

$$30. \int \frac{\sqrt{3t+9}}{t} dt = 2\sqrt{3t+9} + 9 \int \frac{dt}{t\sqrt{3t+9}}$$

(We used FORMULA 12 with $a = 3$, $b = 9$)

$$= 2\sqrt{3t+9} + 9 \left(\frac{1}{\sqrt{9}} \ln \left| \frac{\sqrt{3t+9} - \sqrt{9}}{\sqrt{3t+9} + \sqrt{9}} \right| \right) + C = 2\sqrt{3t+9} + 3 \ln \left| \frac{\sqrt{3t+9} - 3}{\sqrt{3t+9} + 3} \right| + C$$

(We used FORMULA 13(b) with $a = 3$, $b = 9$)

$$31. \int x^2 \tan^{-1} x dx = \frac{x^{2+1}}{2+1} \tan^{-1} x - \frac{1}{2+1} \int \frac{x^{2+1}}{1+x^2} dx = \frac{x^3}{3} \tan^{-1} x - \frac{1}{3} \int \frac{x^3}{1+x^2} dx$$

(We used FORMULA 101 with $a = 1$, $n = 2$);

$$\int \frac{x^3}{1+x^2} dx = \int x dx - \int \frac{x dx}{1+x^2} = \frac{x^2}{2} - \frac{1}{2} \ln(1+x^2) + C \Rightarrow \int x^2 \tan^{-1} x dx$$

$$= \frac{x^3}{3} \tan^{-1} x - \frac{x^2}{6} + \frac{1}{6} \ln(1+x^2) + C$$

$$32. \int \frac{\tan^{-1} x}{x^2} dx = \int x^{-2} \tan^{-1} x dx = \frac{x^{(-2+1)}}{(-2+1)} \tan^{-1} x - \frac{1}{(-2+1)} \int \frac{x^{(-2+1)}}{1+x^2} dx = \frac{x^{-1}}{(-1)} \tan^{-1} x + \int \frac{x^{-1}}{(1+x^2)} dx$$

(We used FORMULA 101 with $a = 1$, $n = -2$);

$$\int \frac{x^{-1} dx}{1+x^2} = \int \frac{dx}{x(1+x^2)} = \int \frac{dx}{x} - \int \frac{x dx}{1+x^2} = \ln|x| - \frac{1}{2} \ln(1+x^2) + C$$

$$\Rightarrow \int \frac{\tan^{-1} x}{x^2} dx = -\frac{1}{x} \tan^{-1} x + \ln|x| - \frac{1}{2} \ln(1+x^2) + C$$

$$33. \int \sin 3x \cos 2x dx = -\frac{\cos 5x}{10} - \frac{\cos x}{2} + C$$

(We used FORMULA 62(a) with $a = 3$, $b = 2$)

$$34. \int \sin 2x \cos 3x dx = -\frac{\cos 5x}{10} + \frac{\cos x}{2} + C$$

(We used FORMULA 62(a) with $a = 2$, $b = 3$)

$$35. \int 8 \sin 4t \sin \frac{1}{2} dt = \frac{8}{7} \sin \left(\frac{7t}{2} \right) - \frac{8}{9} \sin \left(\frac{9t}{2} \right) + C = 8 \left[\frac{\sin \left(\frac{7t}{2} \right)}{7} - \frac{\sin \left(\frac{9t}{2} \right)}{9} \right] + C$$

(We used FORMULA 62(b) with $a = 4$, $b = \frac{1}{2}$)

$$36. \int \sin \frac{1}{3} \sin \frac{1}{6} dt = 3 \sin \left(\frac{1}{6} \right) - \sin \left(\frac{1}{2} \right) + C$$

(We used FORMULA 62(b) with $a = \frac{1}{3}$, $b = \frac{1}{6}$)

$$37. \int \cos \frac{\theta}{3} \cos \frac{\theta}{4} d\theta = 6 \sin \left(\frac{\theta}{12} \right) + \frac{6}{7} \sin \left(\frac{7\theta}{12} \right) + C$$

(We used FORMULA 62(c) with $a = \frac{1}{3}$, $b = \frac{1}{4}$)

$$38. \int \cos \frac{\theta}{2} \cos 7\theta d\theta = \frac{1}{13} \sin \left(\frac{13\theta}{2} \right) + \frac{1}{15} \sin \left(\frac{15\theta}{2} \right) + C = \frac{\sin \left(\frac{13\theta}{2} \right)}{13} + \frac{\sin \left(\frac{15\theta}{2} \right)}{15} + C$$

(We used FORMULA 62(c) with $a = \frac{1}{2}$, $b = 7$)

$$39. \int \frac{x^3 + x + 1}{(x^2 + 1)^2} dx = \int \frac{x dx}{x^2 + 1} + \int \frac{dx}{(x^2 + 1)^2} = \frac{1}{2} \int \frac{d(x^2 + 1)}{x^2 + 1} + \int \frac{dx}{(x^2 + 1)^2}$$

$$= \frac{1}{2} \ln(x^2 + 1) + \frac{x}{2(1+x^2)} + \frac{1}{2} \tan^{-1} x + C$$

(For the second integral we used FORMULA 17 with $a = 1$)

$$40. \int \frac{x^2 + 6x}{(x^2 + 3)^2} dx = \int \frac{dx}{x^2 + 3} + \int \frac{6x dx}{(x^2 + 3)^2} - \int \frac{3 dx}{(x^2 + 3)^2} = \int \frac{dx}{x^2 + (\sqrt{3})^2} + 3 \int \frac{d(x^2 + 3)}{(x^2 + 3)^2} - 3 \int \frac{dx}{[x^2 + (\sqrt{3})^2]^2}$$

$$= \frac{1}{\sqrt{3}} \tan^{-1} \left(\frac{x}{\sqrt{3}} \right) - \frac{3}{(x^2+3)} - 3 \left(\frac{\frac{x}{\sqrt{3}}}{2(\sqrt{3})^2((\sqrt{3})^2+x^2)} + \frac{1}{2(\sqrt{3})^3} \tan^{-1} \left(\frac{x}{\sqrt{3}} \right) \right) + C$$

(For the first integral we used FORMULA 16 with $a = \sqrt{3}$; for the third integral we used FORMULA 17 with $a = \sqrt{3}$)

$$= \frac{1}{2\sqrt{3}} \tan^{-1} \left(\frac{x}{\sqrt{3}} \right) - \frac{3}{x^2+3} - \frac{x}{2(x^2+3)} + C$$

$$41. \int \sin^{-1} \sqrt{x} \, dx; \left[\begin{array}{l} u = \sqrt{x} \\ x = u^2 \\ dx = 2u \, du \end{array} \right] \rightarrow 2 \int u^1 \sin^{-1} u \, du = 2 \left(\frac{u^{1+1}}{1+1} \sin^{-1} u - \frac{1}{1+1} \int \frac{u^{1+1}}{\sqrt{1-u^2}} \, du \right)$$

$$= u^2 \sin^{-1} u - \int \frac{u^2 \, du}{\sqrt{1-u^2}}$$

(We used FORMULA 99 with $a = 1$, $n = 1$)

$$= u^2 \sin^{-1} u - \left(\frac{1}{2} \sin^{-1} u - \frac{1}{2} u \sqrt{1-u^2} \right) + C = \left(u^2 - \frac{1}{2} \right) \sin^{-1} u + \frac{1}{2} u \sqrt{1-u^2} + C$$

(We used FORMULA 33 with $a = 1$)

$$= \left(x - \frac{1}{2} \right) \sin^{-1} \sqrt{x} + \frac{1}{2} \sqrt{x-x^2} + C$$

$$42. \int \frac{\cos^{-1} \sqrt{x}}{\sqrt{x}} \, dx; \left[\begin{array}{l} u = \sqrt{x} \\ x = u^2 \\ dx = 2u \, du \end{array} \right] \rightarrow \int \frac{\cos^{-1} u}{u} \cdot 2u \, du = 2 \int \cos^{-1} u \, du = 2 \left(u \cos^{-1} u - \frac{1}{1} \sqrt{1-u^2} \right) + C$$

(We used FORMULA 97 with $a = 1$)

$$= 2 \left(\sqrt{x} \cos^{-1} \sqrt{x} - \sqrt{1-x} \right) + C$$

$$43. \int \frac{\sqrt{x}}{\sqrt{1-x}} \, dx; \left[\begin{array}{l} u = \sqrt{x} \\ x = u^2 \\ dx = 2u \, du \end{array} \right] \rightarrow \int \frac{u \cdot 2u}{\sqrt{1-u^2}} \, du = 2 \int \frac{u^2}{\sqrt{1-u^2}} \, du = 2 \left(\frac{1}{2} \sin^{-1} u - \frac{1}{2} u \sqrt{1-u^2} \right) + C$$

$$= \sin^{-1} u - u \sqrt{1-u^2} + C$$

(We used FORMULA 33 with $a = 1$)

$$= \sin^{-1} \sqrt{x} - \sqrt{x} \sqrt{1-x} + C = \sin^{-1} \sqrt{x} - \sqrt{x-x^2} + C$$

$$44. \int \frac{\sqrt{2-x}}{\sqrt{x}} \, dx; \left[\begin{array}{l} u = \sqrt{x} \\ x = u^2 \\ dx = 2u \, du \end{array} \right] \rightarrow \int \frac{\sqrt{2-u^2}}{u} \cdot 2u \, du = 2 \int \sqrt{(\sqrt{2})^2 - u^2} \, du$$

$$= 2 \left[\frac{u}{2} \sqrt{(\sqrt{2})^2 - u^2} + \frac{(\sqrt{2})^2}{2} \sin^{-1} \left(\frac{u}{\sqrt{2}} \right) \right] + C = u \sqrt{2-u^2} + 2 \sin^{-1} \left(\frac{u}{\sqrt{2}} \right) + C$$

(We used FORMULA 29 with $a = \sqrt{2}$)

$$= \sqrt{2x-x^2} + 2 \sin^{-1} \sqrt{\frac{x}{2}} + C$$

$$45. \int (\cot t) \sqrt{1-\sin^2 t} \, dt = \int \frac{\sqrt{1-\sin^2 t} (\cos t) \, dt}{\sin t}; \left[\begin{array}{l} u = \sin t \\ du = \cos t \, dt \end{array} \right] \rightarrow \int \frac{\sqrt{1-u^2}}{u} \, du$$

$$= \sqrt{1-u^2} - \ln \left| \frac{1+\sqrt{1-u^2}}{u} \right| + C$$

(We used FORMULA 31 with $a = 1$)

$$= \sqrt{1-\sin^2 t} - \ln \left| \frac{1+\sqrt{1-\sin^2 t}}{\sin t} \right| + C$$

$$46. \int \frac{dt}{(\tan t)\sqrt{4-\sin^2 t}} = \int \frac{\cos t dt}{(\sin t)\sqrt{4-\sin^2 t}}; \left[\begin{array}{l} u = \sin t \\ du = \cos t dt \end{array} \right] \rightarrow \int \frac{du}{u\sqrt{4-u^2}} = -\frac{1}{2} \ln \left| \frac{2+\sqrt{4-u^2}}{u} \right| + C$$

(We used FORMULA 34 with $a = 2$)

$$= -\frac{1}{2} \ln \left| \frac{2+\sqrt{4-\sin^2 t}}{\sin t} \right| + C$$

$$47. \int \frac{dy}{y\sqrt{3+(\ln y)^2}}; \left[\begin{array}{l} u = \ln y \\ y = e^u \\ dy = e^u du \end{array} \right] \rightarrow \int \frac{e^u du}{e^u\sqrt{3+u^2}} = \int \frac{du}{\sqrt{3+u^2}} = \ln \left| u + \sqrt{3+u^2} \right| + C$$

$$= \ln \left| \ln y + \sqrt{3+(\ln y)^2} \right| + C$$

(We used FORMULA 20 with $a = \sqrt{3}$)

$$48. \int \frac{\cos \theta d\theta}{\sqrt{5+\sin^2 \theta}}; \left[\begin{array}{l} u = \sin \theta \\ du = \cos \theta d\theta \end{array} \right] \rightarrow \int \frac{du}{\sqrt{5+u^2}} = \ln \left| u + \sqrt{5+u^2} \right| + C = \ln \left| \sin \theta + \sqrt{5+\sin^2 \theta} \right| + C$$

(We used FORMULA 20 with $a = \sqrt{5}$)

$$49. \int \frac{3 dr}{\sqrt{9r^2-1}}; \left[\begin{array}{l} u = 3r \\ du = 3 dr \end{array} \right] \rightarrow \int \frac{du}{\sqrt{u^2-1}} = \ln \left| u + \sqrt{u^2-1} \right| + C = \ln \left| 3r + \sqrt{9r^2-1} \right| + C$$

(We used FORMULA 36 with $a = 1$)

$$50. \int \frac{3 dy}{\sqrt{1+9y^2}}; \left[\begin{array}{l} u = 3y \\ du = 3 dy \end{array} \right] \rightarrow \int \frac{du}{\sqrt{1+u^2}} = \ln \left| u + \sqrt{1+u^2} \right| + C = \ln \left| 3y + \sqrt{1+9y^2} \right| + C$$

(We used FORMULA 20 with $a = 1$)

$$51. \int \cos^{-1} \sqrt{x} dx; \left[\begin{array}{l} t = \sqrt{x} \\ x = t^2 \\ dx = 2t dt \end{array} \right] \rightarrow 2 \int t \cos^{-1} t dt = 2 \left(\frac{t^2}{2} \cos^{-1} t + \frac{1}{2} \int \frac{t^2}{\sqrt{1-t^2}} dt \right) = t^2 \cos^{-1} t + \int \frac{t^2}{\sqrt{1-t^2}} dt$$

(We used FORMULA 100 with $a = 1, n = 1$)

$$= t^2 \cos^{-1} t + \frac{1}{2} \sin^{-1} t - \frac{1}{2} t \sqrt{1-t^2} + C$$

(We used FORMULA 33 with $a = 1$)

$$= x \cos^{-1} \sqrt{x} + \frac{1}{2} \sin^{-1} \sqrt{x} - \frac{1}{2} \sqrt{x} \sqrt{1-x} + C = x \cos^{-1} \sqrt{x} + \frac{1}{2} \sin^{-1} \sqrt{x} - \frac{1}{2} \sqrt{x-x^2} + C$$

$$52. \int \tan^{-1} \sqrt{y} dy; \left[\begin{array}{l} t = \sqrt{y} \\ y = t^2 \\ dy = 2t dt \end{array} \right] \rightarrow 2 \int t \tan^{-1} t dt = 2 \left[\frac{t^2}{2} \tan^{-1} t - \frac{1}{2} \int \frac{t^2}{1+t^2} dt \right] = t^2 \tan^{-1} t - \int \frac{t^2}{1+t^2} dt$$

(We used FORMULA 101 with $n = 1, a = 1$)

$$= t^2 \tan^{-1} t - \int \frac{t^2+1}{t^2+1} dt + \int \frac{dt}{1+t^2} = t^2 \tan^{-1} t - t + \tan^{-1} t + C = y \tan^{-1} \sqrt{y} + \tan^{-1} \sqrt{y} - \sqrt{y} + C$$

$$53. \int \sin^5 2x dx = -\frac{\sin^4 2x \cos 2x}{5 \cdot 2} + \frac{5-1}{5} \int \sin^3 2x dx = -\frac{\sin^4 2x \cos 2x}{10} + \frac{4}{5} \left[-\frac{\sin^2 2x \cos 2x}{3 \cdot 2} + \frac{3-1}{3} \int \sin 2x dx \right]$$

(We used FORMULA 60 with $a = 2, n = 5$ and $a = 2, n = 3$)

$$= -\frac{\sin^4 2x \cos 2x}{10} - \frac{2}{15} \sin^2 2x \cos 2x + \frac{8}{15} \left(-\frac{1}{2} \right) \cos 2x + C = -\frac{\sin^4 2x \cos 2x}{10} - \frac{2 \sin^2 2x \cos 2x}{15} - \frac{4 \cos 2x}{15} + C$$

$$54. \int \sin^5 \frac{\theta}{2} d\theta = -\frac{\sin^4 \frac{\theta}{2} \cos \frac{\theta}{2}}{5 \cdot \frac{1}{2}} + \frac{5-1}{5} \int \sin^3 \frac{\theta}{2} d\theta = -\frac{2}{5} \sin^4 \frac{\theta}{2} \cos \frac{\theta}{2} + \frac{4}{5} \left[-\frac{\sin^2 \frac{\theta}{2} \cos \frac{\theta}{2}}{3 \cdot \frac{1}{2}} + \frac{3-1}{3} \int \sin \frac{\theta}{2} d\theta \right]$$

(We used FORMULA 60 with $a = \frac{1}{2}, n = 5$ and $a = \frac{1}{2}, n = 3$)

$$= -\frac{2}{5} \sin^4 \frac{\theta}{2} \cos \frac{\theta}{2} - \frac{8}{15} \sin^2 \frac{\theta}{2} \cos \frac{\theta}{2} + \frac{8}{15} \left(-2 \cos \frac{\theta}{2} \right) + C = -\frac{2}{5} \sin^4 \frac{\theta}{2} \cos \frac{\theta}{2} - \frac{8}{15} \sin^2 \frac{\theta}{2} \cos \frac{\theta}{2} - \frac{16}{15} \cos \frac{\theta}{2} + C$$

$$55. \int 8 \cos^4 2\pi t \, dt = 8 \left(\frac{\cos^3 2\pi t \sin 2\pi t}{4 \cdot 2\pi} + \frac{4-1}{4} \int \cos^2 2\pi t \, dt \right)$$

(We used FORMULA 61 with $a = 2\pi$, $n = 4$)

$$= \frac{\cos^3 2\pi t \sin 2\pi t}{\pi} + 6 \left[\frac{t}{2} + \frac{\sin(2 \cdot 2\pi \cdot t)}{4 \cdot 2\pi} \right] + C$$

(We used FORMULA 59 with $a = 2\pi$)

$$= \frac{\cos^3 2\pi t \sin 2\pi t}{\pi} + 3t + \frac{3 \sin 4\pi t}{4\pi} + C = \frac{\cos^3 2\pi t \sin 2\pi t}{\pi} + \frac{3 \cos 2\pi t \sin 2\pi t}{2\pi} + 3t + C$$

$$56. \int 3 \cos^5 3y \, dy = 3 \left(\frac{\cos^4 3y \sin 3y}{5 \cdot 3} + \frac{5-1}{5} \int \cos^3 3y \, dy \right)$$

$$= \frac{\cos^4 3y \sin 3y}{5} + \frac{12}{5} \left(\frac{\cos^2 3y \sin 3y}{3 \cdot 3} + \frac{3-1}{3} \int \cos 3y \, dy \right)$$

(We used FORMULA 61 with $a = 3$, $n = 5$ and $a = 3$, $n = 3$)

$$= \frac{1}{5} \cos^4 3y \sin 3y + \frac{4}{15} \cos^2 3y \sin 3y + \frac{8}{15} \sin 3y + C$$

$$57. \int \sin^2 2\theta \cos^3 2\theta \, d\theta = \frac{\sin^3 2\theta \cos^2 2\theta}{2(2+3)} + \frac{3-1}{3+2} \int \sin^2 2\theta \cos 2\theta \, d\theta$$

(We used FORMULA 69 with $a = 2$, $m = 3$, $n = 2$)

$$= \frac{\sin^3 2\theta \cos^2 2\theta}{10} + \frac{2}{5} \int \sin^2 2\theta \cos 2\theta \, d\theta = \frac{\sin^3 2\theta \cos^2 2\theta}{10} + \frac{2}{5} \left[\frac{1}{2} \int \sin^2 2\theta \, d(\sin 2\theta) \right] = \frac{\sin^3 2\theta \cos^2 2\theta}{10} + \frac{\sin^3 2\theta}{15} + C$$

$$58. \int 9 \sin^3 \theta \cos^{3/2} \theta \, d\theta = 9 \left[-\frac{\sin^2 \theta \cos^{5/2} \theta}{3 + (\frac{3}{2})} + \frac{3-1}{3 + (\frac{3}{2})} \int \sin \theta \cos^{3/2} \theta \, d\theta \right]$$

$$= -2 \sin^2 \theta \cos^{5/2} \theta + 4 \int \cos^{3/2} \theta \sin \theta \, d\theta$$

(We used FORMULA 68 with $a = 1$, $n = 3$, $m = \frac{3}{2}$)

$$= -2 \sin^2 \theta \cos^{5/2} \theta - 4 \int \cos^{3/2} \theta \, d(\cos \theta) = -2 \sin^2 \theta \cos^{5/2} \theta - 4 \left(\frac{2}{5} \cos^{5/2} \theta \right) + C$$

$$= (-2 \cos^{5/2} \theta) \left(\sin^2 \theta + \frac{4}{5} \right) + C$$

$$59. \int 2 \sin^2 t \sec^4 t \, dt = \int 2 \sin^2 t \cos^{-4} t \, dt = 2 \left(-\frac{\sin t \cos^{-3} t}{2-4} + \frac{2-1}{2-4} \int \cos^{-4} t \, dt \right)$$

(We used FORMULA 68 with $a = 1$, $n = 2$, $m = -4$)

$$= \sin t \cos^{-3} t - \int \cos^{-4} t \, dt = \sin t \cos^{-3} t - \int \sec^4 t \, dt = \sin t \cos^{-3} t - \left(\frac{\sec^2 t \tan t}{4-1} + \frac{4-2}{4-1} \int \sec^2 t \, dt \right)$$

(We used FORMULA 92 with $a = 1$, $n = 4$)

$$= \sin t \cos^{-3} t - \left(\frac{\sec^2 t \tan t}{3} \right) - \frac{2}{3} \tan t + C = \frac{2}{3} \sec^2 t \tan t - \frac{2}{3} \tan t + C = \frac{2}{3} \tan t (\sec^2 t - 1) + C$$

$$= \frac{2}{3} \tan^3 t + C$$

An easy way to find the integral using substitution:

$$\int 2 \sin^2 t \cos^{-4} t \, dt = \int 2 \tan^2 t \sec^2 t \, dt = \int 2 \tan^2 t \, d(\tan t) = \frac{2}{3} \tan^3 t + C$$

$$60. \int \csc^2 y \cos^5 y \, dy = \int \sin^{-2} y \cos^5 y \, dy = \frac{\left(\frac{1}{\sin y}\right) \cos^4 y}{5-2} + \frac{5-1}{5-2} \int \sin^{-2} y \cos^3 y \, dy$$

$$= \frac{\left(\frac{1}{\sin y}\right) \cos^4 y}{3} + \frac{4}{3} \left(\frac{\left(\frac{1}{\sin y}\right) \cos^2 y}{3-2} + \frac{3-1}{3-2} \int \sin^{-2} y \cos y \, dy \right)$$

(We used FORMULA 69 with $n = -2$, $m = 5$, $a = 1$ and $n = -2$, $m = 3$, $a = 1$)

$$= \frac{\left(\frac{1}{\sin y}\right) \cos^4 y}{3} + \frac{4}{3} \left(\frac{1}{\sin y} \right) \cos^2 y + \frac{8}{3} \int \sin^{-2} y \, d(\sin y) = \frac{\cos^4 y}{3 \sin y} + \frac{4 \cos^2 y}{3 \sin y} - \frac{8}{3 \sin y} + C$$

$$61. \int 4 \tan^3 2x \, dx = 4 \left(\frac{\tan^2 2x}{2 \cdot 2} - \int \tan 2x \, dx \right) = \tan^2 2x - 4 \int \tan 2x \, dx$$

(We used FORMULA 86 with $n = 3$, $a = 2$)

$$= \tan^2 2x - \frac{4}{2} \ln |\sec 2x| + C = \tan^2 2x - 2 \ln |\sec 2x| + C$$

$$62. \int \tan^4\left(\frac{x}{2}\right) dx = \frac{\tan^3\left(\frac{x}{2}\right)}{\frac{1}{2}(4-1)} - \int \tan^2\left(\frac{x}{2}\right) dx = \frac{2}{3} \tan^3\left(\frac{x}{2}\right) - \int \tan^2\left(\frac{x}{2}\right) dx$$

(We used FORMULA 86 with $n = 4$, $a = \frac{1}{2}$)

$$= \frac{2}{3} \tan^3 \frac{x}{2} - 2 \tan \frac{x}{2} + x + C$$

(We used FORMULA 84 with $a = \frac{1}{2}$)

$$63. \int 8 \cot^4 t dt = 8 \left(-\frac{\cot^3 t}{3} - \int \cot^2 t dt \right)$$

(We used FORMULA 87 with $a = 1$, $n = 4$)

$$= 8 \left(-\frac{1}{3} \cot^3 t + \cot t + t \right) + C$$

(We used FORMULA 85 with $a = 1$)

$$64. \int 4 \cot^3 2t dt = 4 \left[-\frac{\cot^2 2t}{2(3-1)} - \int \cot 2t dt \right] = -\cot^2 2t - 4 \int \cot 2t dt$$

(We used FORMULA 87 with $a = 2$, $n = 3$)

$$= -\cot^2 2t - \frac{4}{2} \ln |\sin 2t| + C = -\cot^2 2t - 2 \ln |\sin 2t| + C$$

(We used FORMULA 83 with $a = 2$)

$$65. \int 2 \sec^3 \pi x dx = 2 \left[\frac{\sec \pi x \tan \pi x}{\pi(3-1)} + \frac{3-2}{3-1} \int \sec \pi x dx \right]$$

(We used FORMULA 92 with $n = 3$, $a = \pi$)

$$= \frac{1}{\pi} \sec \pi x \tan \pi x + \frac{1}{\pi} \ln |\sec \pi x + \tan \pi x| + C$$

(We used FORMULA 88 with $a = \pi$)

$$66. \int \frac{1}{2} \csc^3 \frac{x}{2} dx = \frac{1}{2} \left(-\frac{\csc \frac{x}{2} \cot \frac{x}{2}}{\frac{1}{2}(3-1)} + \frac{3-2}{3-1} \int \csc \frac{x}{2} dx \right)$$

(We used FORMULA 93 with $a = \frac{1}{2}$, $n = 3$)

$$= \frac{1}{2} \left[-\csc \frac{x}{2} \cot \frac{x}{2} - \ln \left| \csc \frac{x}{2} + \cot \frac{x}{2} \right| \right] + C = -\frac{1}{2} \csc \frac{x}{2} \cot \frac{x}{2} - \frac{1}{2} \ln \left| \csc \frac{x}{2} + \cot \frac{x}{2} \right| + C$$

(We used FORMULA 89 with $a = \frac{1}{2}$)

$$67. \int 3 \sec^4 3x dx = 3 \left[\frac{\sec^2 3x \tan 3x}{3(4-1)} + \frac{4-2}{4-1} \int \sec^2 3x dx \right]$$

(We used FORMULA 92 with $n = 4$, $a = 3$)

$$= \frac{\sec^2 3x \tan 3x}{3} + \frac{2}{3} \tan 3x + C$$

(We used FORMULA 90 with $a = 3$)

$$68. \int \csc^4 \frac{\theta}{3} d\theta = -\frac{\csc^2 \frac{\theta}{3} \cot \frac{\theta}{3}}{\frac{1}{3}(4-1)} + \frac{4-2}{4-1} \int \csc^2 \frac{\theta}{3} d\theta$$

(We used FORMULA 93 with $n = 4$, $a = \frac{1}{3}$)

$$= -\csc^2 \frac{\theta}{3} \cot \frac{\theta}{3} - \frac{2}{3} \cdot 3 \cot \frac{\theta}{3} + C = -\csc^2 \frac{\theta}{3} \cot \frac{\theta}{3} - 2 \cot \frac{\theta}{3} + C$$

(We used FORMULA 91 with $a = \frac{1}{3}$)

$$69. \int \csc^5 x dx = -\frac{\csc^3 x \cot x}{5-1} + \frac{5-2}{5-1} \int \csc^3 x dx = -\frac{\csc^3 x \cot x}{4} + \frac{3}{4} \left(-\frac{\csc x \cot x}{3-1} + \frac{3-2}{3-1} \int \csc x dx \right)$$

(We used FORMULA 93 with $n = 5$, $a = 1$ and $n = 3$, $a = 1$)

$$= -\frac{1}{4} \csc^3 x \cot x - \frac{3}{8} \csc x \cot x - \frac{3}{8} \ln |\csc x + \cot x| + C$$

(We used FORMULA 89 with $a = 1$)

$$70. \int \sec^5 x dx = \frac{\sec^3 x \tan x}{5-1} + \frac{5-2}{5-1} \int \sec^3 x dx = \frac{\sec^3 x \tan x}{4} + \frac{3}{4} \left(\frac{\sec x \tan x}{3-1} + \frac{3-2}{3-1} \int \sec x dx \right)$$

(We used FORMULA 92 with $a = 1$, $n = 5$ and $a = 1$, $n = 3$)

$$= \frac{1}{4} \sec^3 x \tan x + \frac{3}{8} \sec x \tan x + \frac{3}{8} \ln |\sec x + \tan x| + C$$

(We used FORMULA 88 with $a = 1$)

$$71. \int 16x^3(\ln x)^2 dx = 16 \left[\frac{x^4(\ln x)^2}{4} - \frac{2}{4} \int x^3 \ln x dx \right] = 16 \left[\frac{x^4(\ln x)^2}{4} - \frac{1}{2} \left[\frac{x^4(\ln x)}{4} - \frac{1}{4} \int x^3 dx \right] \right]$$

(We used FORMULA 110 with $a = 1, n = 3, m = 2$ and $a = 1, n = 3, m = 1$)

$$= 16 \left(\frac{x^4(\ln x)^2}{4} - \frac{x^4(\ln x)}{8} + \frac{x^4}{32} \right) + C = 4x^4(\ln x)^2 - 2x^4 \ln x + \frac{x^4}{2} + C$$

$$72. \int (\ln x)^3 dx = \frac{x(\ln x)^3}{1} - \frac{3}{1} \int (\ln x)^2 dx = x(\ln x)^3 - 3 \left[\frac{x(\ln x)^2}{1} - \frac{2}{1} \int \ln x dx \right] = x(\ln x)^3 - 3x(\ln x)^2 + 6 \left(\frac{x \ln x}{1} - \frac{1}{1} \int dx \right)$$

$$= x(\ln x)^3 - 3x(\ln x)^2 + 6x \ln x - 6x + C$$

(We used FORMULA 110 with $n = 0, a = 1$ and $m = 3, 2, 1$)

$$73. \int xe^{3x} dx = \frac{e^{3x}}{3^2} (3x - 1) + C = \frac{e^{3x}}{9} (3x - 1) + C$$

(We used FORMULA 104 with $a = 3$)

$$74. \int xe^{-2x} dx = \frac{e^{-2x}}{(-2)^2} (-2x - 1) + C = -\frac{e^{-2x}}{4} (2x + 1) + C$$

(We used FORMULA 104 with $a = -2$)

$$75. \int x^3 e^{x/2} dx = 2x^3 e^{x/2} - 3 \cdot 2 \int x^2 e^{x/2} dx = 2x^3 e^{x/2} - 6 \left(2x^2 e^{x/2} - 2 \cdot 2 \int x e^{x/2} dx \right)$$

$$= 2x^3 e^{x/2} - 12x^2 e^{x/2} + 24 \cdot 4e^{x/2} \left(\frac{x}{2} - 1 \right) + C = 2x^3 e^{x/2} - 12x^2 e^{x/2} + 96e^{x/2} \left(\frac{x}{2} - 1 \right) + C$$

(We used FORMULA 105 with $a = \frac{1}{2}$ twice and FORMULA 104 with $a = \frac{1}{2}$)

$$76. \int x^2 e^{\pi x} dx = \frac{1}{\pi} x^2 e^{\pi x} - \frac{2}{\pi} \int x e^{\pi x} dx$$

(We used FORMULA 105 with $n = 2, a = \pi$)

$$= \frac{1}{\pi} x^2 e^{\pi x} - \frac{2}{\pi \cdot \pi^2} \cdot e^{\pi x} (\pi x - 1) + C = \frac{1}{\pi} x^2 e^{\pi x} - \left(\frac{2e^{\pi x}}{\pi^3} \right) (\pi x - 1) + C$$

(We used FORMULA 104 with $a = \pi$)

$$77. \int x^2 2^x dx = \frac{x^2 2^x}{\ln 2} - \frac{2}{\ln 2} \int x 2^x dx = \frac{x^2 2^x}{\ln 2} - \frac{2}{\ln 2} \left(\frac{x 2^x}{\ln 2} - \frac{1}{\ln 2} \int 2^x dx \right) = \frac{x^2 2^x}{\ln 2} - \frac{2}{\ln 2} \left[\frac{x 2^x}{\ln 2} - \frac{2^x}{(\ln 2)^2} \right] + C$$

(We used FORMULA 106 with $a = 1, b = 2, n = 2, n = 1$)

$$78. \int x^2 2^{-x} dx = \frac{x^2 2^{-x}}{-\ln 2} + \frac{2}{\ln 2} \int x 2^{-x} dx = \frac{-x^2 2^{-x}}{\ln 2} + \frac{2}{\ln 2} \left(-\frac{x 2^{-x}}{\ln 2} + \frac{1}{\ln 2} \int 2^{-x} dx \right)$$

$$= -\frac{x^2 2^{-x}}{\ln 2} + \frac{2}{\ln 2} \left[\frac{x 2^{-x}}{-\ln 2} - \frac{2^{-x}}{(\ln 2)^2} \right] + C$$

(We used FORMULA 106 with $a = -1, b = 2, n = 2, n = 1$)

$$79. \int x \pi^x dx = \frac{x \pi^x}{\ln \pi} - \frac{1}{\ln \pi} \int \pi^x dx = \frac{x \pi^x}{\ln \pi} - \frac{1}{\ln \pi} \left(\frac{\pi^x}{\ln \pi} \right) + C = \frac{x \pi^x}{\ln \pi} - \frac{\pi^x}{(\ln \pi)^2} + C$$

(We used FORMULA 106 with $n = 1, b = \pi, a = 1$)

$$80. \int x 2^{\sqrt{2}x} dx = \frac{x 2^{\sqrt{2}x}}{\sqrt{2} \ln 2} - \frac{1}{\sqrt{2} \ln 2} \int 2^{\sqrt{2}x} dx = \frac{x 2^{\sqrt{2}x}}{\sqrt{2} \ln 2} - \frac{2^{\sqrt{2}x}}{2(\ln 2)^2} + C$$

(We used FORMULA 106 with $a = \sqrt{2}, b = 2, n = 1$)

$$81. \int e^t \sec^3(e^t - 1) dt; \left[\begin{array}{l} x = e^t - 1 \\ dx = e^t dt \end{array} \right] \rightarrow \int \sec^3 x dx = \frac{\sec x \tan x}{3-1} + \frac{3-2}{3-1} \int \sec x dx$$

(We used FORMULA 92 with $a = 1, n = 3$)

$$= \frac{\sec x \tan x}{2} + \frac{1}{2} \ln |\sec x + \tan x| + C = \frac{1}{2} [\sec(e^t - 1) \tan(e^t - 1) + \ln |\sec(e^t - 1) + \tan(e^t - 1)|] + C$$

$$82. \int \frac{\csc^3 \sqrt{\theta}}{\sqrt{\theta}} d\theta; \left[\begin{array}{l} t = \sqrt{\theta} \\ \theta = t^2 \\ d\theta = 2t dt \end{array} \right] \rightarrow 2 \int \csc^3 t dt = 2 \left[-\frac{\csc t \cot t}{3-1} + \frac{3-2}{3-1} \int \csc t dt \right]$$

(We used FORMULA 93 with $a = 1$, $n = 3$)

$$= 2 \left[-\frac{\csc t \cot t}{2} - \frac{1}{2} \ln |\csc t + \cot t| \right] + C = -\csc \sqrt{\theta} \cot \sqrt{\theta} - \ln |\csc \sqrt{\theta} + \cot \sqrt{\theta}| + C$$

$$83. \int_0^1 2\sqrt{x^2+1} dx; [x = \tan t] \rightarrow 2 \int_0^{\pi/4} \sec t \cdot \sec^2 t dt = 2 \int_0^{\pi/4} \sec^3 t dt = 2 \left[\frac{\sec t \tan t}{3-1} \Big|_0^{\pi/4} + \frac{3-2}{3-1} \int_0^{\pi/4} \sec t dt \right]$$

(We used FORMULA 92 with $n = 3$, $a = 1$)

$$= [\sec t \cdot \tan t + \ln |\sec t + \tan t|]_0^{\pi/4} = \sqrt{2} + \ln(\sqrt{2} + 1)$$

$$84. \int_0^{\sqrt{3}/2} \frac{dy}{(1-y^2)^{5/2}}; [y = \sin x] \rightarrow \int_0^{\pi/3} \frac{\cos x dx}{\cos^5 x} = \int_0^{\pi/3} \sec^4 x dx = \left[\frac{\sec^2 x \tan x}{4-1} \right]_0^{\pi/3} + \frac{4-2}{4-1} \int_0^{\pi/3} \sec^2 x dx$$

(We used FORMULA 92 with $a = 1$, $n = 4$)

$$= \left[\frac{\sec^2 x \tan x}{3} + \frac{2}{3} \tan x \right]_0^{\pi/3} = \left(\frac{4}{3}\right) \sqrt{3} + \left(\frac{2}{3}\right) \sqrt{3} = 2\sqrt{3}$$

$$85. \int_1^2 \frac{(r^2-1)^{3/2}}{r} dr; [r = \sec \theta] \rightarrow \int_0^{\pi/3} \frac{\tan^3 \theta}{\sec \theta} (\sec \theta \tan \theta) d\theta = \int_0^{\pi/3} \tan^4 \theta d\theta = \left[\frac{\tan^3 \theta}{4-1} \right]_0^{\pi/3} - \int_0^{\pi/3} \tan^2 \theta d\theta$$

$$= \left[\frac{\tan^3 \theta}{3} - \tan \theta + \theta \right]_0^{\pi/3} = \frac{3\sqrt{3}}{3} - \sqrt{3} + \frac{\pi}{3} = \frac{\pi}{3}$$

(We used FORMULA 86 with $a = 1$, $n = 4$ and FORMULA 84 with $a = 1$)

$$86. \int_0^{1/\sqrt{3}} \frac{dt}{(t^2+1)^{7/2}}; [t = \tan \theta] \rightarrow \int_0^{\pi/6} \frac{\sec^2 \theta d\theta}{\sec^7 \theta} = \int_0^{\pi/6} \cos^5 \theta d\theta = \left[\frac{\cos^4 \theta \sin \theta}{5} \right]_0^{\pi/6} + \left(\frac{5-1}{5}\right) \int_0^{\pi/6} \cos^3 \theta d\theta$$

$$= \left[\frac{\cos^4 \theta \sin \theta}{5} \right]_0^{\pi/6} + \frac{4}{5} \left[\frac{\cos^2 \theta \sin \theta}{3} \right]_0^{\pi/6} + \left(\frac{3-1}{3}\right) \int_0^{\pi/6} \cos \theta d\theta$$

$$= \left[\frac{\cos^4 \theta \sin \theta}{5} + \frac{4}{15} \cos^2 \theta \sin \theta + \frac{8}{15} \sin \theta \right]_0^{\pi/6}$$

(We used FORMULA 61 with $a = 1$, $n = 5$ and $a = 1$, $n = 3$)

$$= \frac{\left(\frac{\sqrt{3}}{2}\right)^4 \left(\frac{1}{2}\right)}{5} + \left(\frac{4}{15}\right) \left(\frac{\sqrt{3}}{2}\right)^2 \left(\frac{1}{2}\right) + \left(\frac{8}{15}\right) \left(\frac{1}{2}\right) = \frac{9}{160} + \frac{1}{10} + \frac{4}{15} = \frac{3 \cdot 9 + 48 + 32 \cdot 4}{480} = \frac{203}{480}$$

$$87. \int \frac{1}{8} \sinh^5 3x dx = \frac{1}{8} \left(\frac{\sinh^4 3x \cosh 3x}{5 \cdot 3} - \frac{5-1}{5} \int \sinh^3 3x dx \right)$$

$$= \frac{\sinh^4 3x \cosh 3x}{120} - \frac{1}{10} \left(\frac{\sinh 3x \cosh 3x}{3 \cdot 3} - \frac{3-1}{3} \int \sinh 3x dx \right)$$

(We used FORMULA 117 with $a = 3$, $n = 5$ and $a = 3$, $n = 3$)

$$= \frac{\sinh^4 3x \cosh 3x}{120} - \frac{\sinh 3x \cosh 3x}{90} + \frac{2}{30} \left(\frac{1}{3} \cosh 3x \right) + C$$

$$= \frac{1}{120} \sinh^4 3x \cosh 3x - \frac{1}{90} \sinh 3x \cosh 3x + \frac{1}{45} \cosh 3x + C$$

$$88. \int \frac{\cosh^4 \sqrt{x}}{\sqrt{x}} dx; \left[\begin{array}{l} u = \sqrt{x} \\ du = \frac{dx}{2\sqrt{x}} \end{array} \right] \rightarrow 2 \int \cosh^4 u du = 2 \left(\frac{\cosh^3 u \sinh u}{4} + \frac{4-1}{4} \int \cosh^2 u du \right)$$

$$= \frac{\cosh^3 u \sinh u}{2} + \frac{3}{2} \left(\frac{\sinh 2u}{4} + \frac{u}{2} \right) + C$$

(We used FORMULA 118 with $a = 1$, $n = 4$ and FORMULA 116 with $a = 1$)

$$= \frac{1}{2} \cosh^3 \sqrt{x} \sinh \sqrt{x} + \frac{3}{8} \sinh 2\sqrt{x} + \frac{3}{4} \sqrt{x} + C$$

$$89. \int x^2 \cosh 3x dx = \frac{x^2}{3} \sinh 3x - \frac{2}{3} \int x \sinh 3x dx = \frac{x^2}{3} \sinh 3x - \frac{2}{3} \left(\frac{x}{3} \cosh 3x - \frac{1}{3} \int \cosh 3x dx \right)$$

(We used FORMULA 122 with $a = 3$, $n = 2$ and FORMULA 121 with $a = 3$, $n = 1$)

$$= \frac{x^2}{3} \sinh 3x - \frac{2x}{9} \cosh 3x + \frac{2}{27} \sinh 3x + C$$

$$90. \int x \sinh 5x \, dx = \frac{x}{5} \cosh 5x - \frac{1}{25} \sinh 5x + C$$

(We used FORMULA 119 with $a = 5$)

$$91. \int \operatorname{sech}^7 x \tanh x \, dx = -\frac{\operatorname{sech}^6 x}{6} + C$$

(We used FORMULA 135 with $a = 1, n = 7$)

$$92. \int \operatorname{csch}^3 2x \coth 2x \, dx = -\frac{\operatorname{csch}^2 2x}{3 \cdot 2} + C = -\frac{\operatorname{csch}^2 2x}{6} + C$$

(We used FORMULA 136 with $a = 2, n = 3$)

$$93. u = ax + b \Rightarrow x = \frac{u-b}{a} \Rightarrow dx = \frac{du}{a};$$

$$\int \frac{x \, dx}{(ax+b)^2} = \int \frac{(u-b) \, du}{a u^2} = \frac{1}{a^2} \int \left(\frac{1}{u} - \frac{b}{u^2} \right) du = \frac{1}{a^2} \left[\ln |u| + \frac{b}{u} \right] + C = \frac{1}{a^2} \left[\ln |ax+b| + \frac{b}{ax+b} \right] + C$$

$$94. x = a \tan \theta \Rightarrow a^2 + x^2 = a^2 \sec^2 \theta \Rightarrow 2x \, dx = 2a^2 \sec^2 \theta \tan \theta \, d\theta \Rightarrow dx = a \sec^2 \theta \, d\theta;$$

$$\int \frac{dx}{(a^2 + x^2)^2} = \int \frac{a \sec^2 \theta}{(a^2 \sec^2 \theta)^2} d\theta = \frac{1}{a^3} \int \frac{d\theta}{\sec^2 \theta} = \frac{1}{2a^3} \int (1 + \cos 2\theta) \, d\theta = \frac{1}{2a^3} \left(\theta + \frac{1}{2} \sin 2\theta \right) + C$$

$$= \frac{1}{2a^3} \left(\theta + \sin \theta \cos \theta \right) + C = \frac{1}{2a^3} \left[\theta + \left(\frac{\sin \theta}{\cos \theta} \right) \cos^2 \theta \right] + C = \frac{1}{2a^3} \left(\theta + \frac{\tan \theta}{1 + \tan^2 \theta} \right) + C$$

$$= \frac{1}{2a^3} \left[\tan^{-1} \frac{x}{a} + \frac{x}{a(1 + \frac{x^2}{a^2})} \right] + C = \frac{1}{2a^3} \frac{x}{(a^2 + x^2)} + \frac{1}{2a^3} \tan^{-1} \frac{x}{a} + C$$

$$95. x = a \sin \theta \Rightarrow a^2 - x^2 = a^2 \cos^2 \theta \Rightarrow -2x \, dx = -2a^2 \cos \theta \sin \theta \, d\theta \Rightarrow dx = a \cos \theta \, d\theta;$$

$$\int \sqrt{a^2 - x^2} \, dx = \int a \cos \theta (a \cos \theta) \, d\theta = a^2 \int \cos^2 \theta \, d\theta = \frac{a^2}{2} \int (1 + \cos 2\theta) \, d\theta = \frac{a^2}{2} \left(\theta + \frac{\sin 2\theta}{2} \right) + C$$

$$= \frac{a^2}{2} \left(\theta + \cos \theta \sin \theta \right) + C = \frac{a^2}{2} \left(\theta + \sqrt{1 - \sin^2 \theta} \cdot \sin \theta \right) + C = \frac{a^2}{2} \left(\sin^{-1} \frac{x}{a} + \frac{\sqrt{a^2 - x^2}}{a} \cdot \frac{x}{a} \right) + C$$

$$= \frac{a^2}{2} \sin^{-1} \frac{x}{a} + \frac{x}{2} \sqrt{a^2 - x^2} + C$$

$$96. x = a \sec \theta \Rightarrow x^2 - a^2 = a^2 \tan^2 \theta \Rightarrow 2x \, dx = 2a^2 \tan \theta \sec^2 \theta \, d\theta \Rightarrow dx = a \sec \theta \tan \theta \, d\theta;$$

$$\int \frac{dx}{x^2 \sqrt{x^2 - a^2}} = \int \frac{a \tan \theta \sec \theta \, d\theta}{(a^2 \sec^2 \theta) a \tan \theta} = \int \frac{d\theta}{a^2 \sec \theta} = \frac{1}{a^2} \int \cos \theta \, d\theta = \frac{1}{a^2} \sin \theta + C = \frac{1}{a^2} \sqrt{1 - \cos^2 \theta} + C$$

$$= \left(\frac{1}{a^2} \right) \frac{\sqrt{\frac{1}{\cos^2 \theta} - 1}}{\left(\frac{1}{\cos \theta} \right)} + C = \left(\frac{1}{a^2} \right) \frac{\sqrt{\sec^2 \theta - 1}}{\sec \theta} + C = \left(\frac{1}{a^2} \right) \frac{\sqrt{\frac{x^2}{a^2} - 1}}{\left(\frac{x}{a} \right)} + C = \frac{\sqrt{x^2 - a^2}}{a^2 x} + C$$

$$97. \int x^n \sin ax \, dx = -\int x^n \left(\frac{1}{a} \right) d(\cos ax) = (\cos ax) x^n \left(-\frac{1}{a} \right) + \frac{1}{a} \int \cos ax \cdot nx^{n-1} \, dx$$

$$= -\frac{x^n}{a} \cos ax + \frac{n}{a} \int x^{n-1} \cos ax \, dx$$

(We used integration by parts $\int u \, dv = uv - \int v \, du$ with $u = x^n, v = -\frac{1}{a} \cos ax$)

$$98. \int x^n (\ln ax)^m \, dx = \int (\ln ax)^m d \left(\frac{x^{n+1}}{n+1} \right) = \frac{x^{n+1} (\ln ax)^m}{n+1} - \int \left(\frac{x^{n+1}}{n+1} \right) m (\ln ax)^{m-1} \left(\frac{1}{x} \right) dx$$

$$= \frac{x^{n+1} (\ln ax)^m}{n+1} - \frac{m}{n+1} \int x^n (\ln ax)^{m-1} \, dx, n \neq -1$$

(We used integration by parts $\int u \, dv = uv - \int v \, du$ with $u = (\ln ax)^m, v = \frac{x^{n+1}}{n+1}$)

$$99. \int x^n \sin^{-1} ax \, dx = \int \sin^{-1} ax d \left(\frac{x^{n+1}}{n+1} \right) = \frac{x^{n+1}}{n+1} \sin^{-1} ax - \int \left(\frac{x^{n+1}}{n+1} \right) \frac{a}{\sqrt{1 - (ax)^2}} dx$$

$$= \frac{x^{n+1}}{n+1} \sin^{-1} ax - \frac{a}{n+1} \int \frac{x^{n+1} dx}{\sqrt{1 - a^2 x^2}}, n \neq -1$$

(We used integration by parts $\int u dv = uv - \int v du$ with $u = \sin^{-1} ax$, $v = \frac{x^{n+1}}{n+1}$)

$$100. \int x^n \tan^{-1} ax \, dx = \int \tan^{-1} ax \, d\left(\frac{x^{n+1}}{n+1}\right) = \frac{x^{n+1}}{n+1} \tan^{-1} ax - \int \left(\frac{x^{n+1}}{n+1}\right) \frac{a}{1+(ax)^2} \, dx$$

$$= \frac{x^{n+1}}{n+1} \tan^{-1} ax - \frac{a}{n+1} \int \frac{x^{n+1} dx}{1+a^2x^2}, n \neq -1$$

(We used integration by parts $\int u dv = uv - \int v du$ with $u = \tan^{-1} ax$, $v = \frac{x^{n+1}}{n+1}$)

$$101. S = \int_0^{\sqrt{2}} 2\pi y \sqrt{1+(y')^2} \, dx$$

$$= 2\pi \int_0^{\sqrt{2}} \sqrt{x^2+2} \sqrt{1+\frac{x^2}{x^2+2}} \, dx$$

$$= 2\sqrt{2}\pi \int_0^{\sqrt{2}} \sqrt{x^2+1} \, dx$$

$$= 2\sqrt{2}\pi \left[\frac{x\sqrt{x^2+1}}{2} + \frac{1}{2} \ln \left| x + \sqrt{x^2+1} \right| \right]_0^{\sqrt{2}}$$

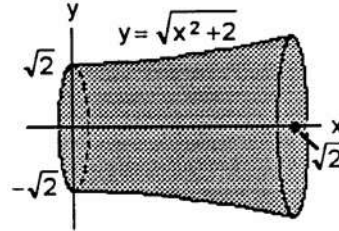

(We used FORMULA 21 with $a = 1$)

$$= \sqrt{2}\pi \left[\sqrt{6} + \ln(\sqrt{2} + \sqrt{3}) \right] = 2\pi\sqrt{3} + \pi\sqrt{2} \ln(\sqrt{2} + \sqrt{3})$$

$$102. L = \int_0^{\sqrt{3}/2} \sqrt{1+(2x)^2} \, dx = 2 \int_0^{\sqrt{3}/2} \sqrt{\frac{1}{4} + x^2} \, dx = 2 \left[\frac{x}{2} \sqrt{\frac{1}{4} + x^2} + \left(\frac{1}{4}\right) \left(\frac{1}{2}\right) \ln \left(x + \sqrt{\frac{1}{4} + x^2} \right) \right]_0^{\sqrt{3}/2}$$

(We used FORMULA 2 with $a = \frac{1}{2}$)

$$= \left[\frac{x}{2} \sqrt{1+4x^2} + \frac{1}{4} \ln \left(x + \frac{1}{2} \sqrt{1+4x^2} \right) \right]_0^{\sqrt{3}/2} = \frac{\sqrt{3}}{4} \sqrt{1+4\left(\frac{3}{4}\right)} + \frac{1}{4} \ln \left(\frac{\sqrt{3}}{2} + \frac{1}{2} \sqrt{1+4\left(\frac{3}{4}\right)} \right) - \frac{1}{4} \ln \frac{1}{2}$$

$$= \frac{\sqrt{3}}{4} (2) + \frac{1}{4} \ln \left(\frac{\sqrt{3}}{2} + 1 \right) + \frac{1}{4} \ln 2 = \frac{\sqrt{3}}{2} + \frac{1}{4} \ln(\sqrt{3} + 2)$$

$$103. A = \int_0^3 \frac{dx}{\sqrt{x+1}} = \left[2\sqrt{x+1} \right]_0^3 = 2; \bar{x} = \frac{1}{A} \int_0^3 \frac{x \, dx}{\sqrt{x+1}}$$

$$= \frac{1}{A} \int_0^3 \sqrt{x+1} \, dx - \frac{1}{A} \int_0^3 \frac{dx}{\sqrt{x+1}}$$

$$= \frac{1}{2} \cdot \frac{2}{3} \left[(x+1)^{3/2} \right]_0^3 - 1 = \frac{4}{3};$$

(We used FORMULA 11 with $a = 1$, $b = 1$, $n = 1$ and $a = 1$, $b = 1$, $n = -1$)

$$\bar{y} = \frac{1}{2A} \int_0^3 \frac{dx}{\sqrt{x+1}} = \frac{1}{4} \left[\ln(x+1) \right]_0^3 = \frac{1}{4} \ln 4 = \frac{1}{2} \ln 2 = \ln \sqrt{2}$$

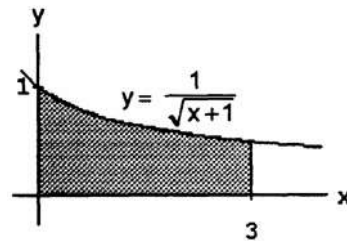

$$104. M_y = \int_0^3 x \left(\frac{36}{2x+3} \right) dx = 18 \int_0^3 \frac{2x+3}{2x+3} dx - 54 \int_0^3 \frac{dx}{2x+3} = [18x - 27 \ln |2x+3|]_0^3$$

$$= 18 \cdot 3 - 27 \ln 9 - (-27 \ln 3) = 54 - 27 \cdot 2 \ln 3 + 27 \ln 3 = 54 - 27 \ln 3$$

$$105. S = 2\pi \int_{-1}^1 x^2 \sqrt{1+4x^2} \, dx;$$

$$\left[\begin{array}{l} u = 2x \\ du = 2 \, dx \end{array} \right] \rightarrow \frac{\pi}{4} \int_{-2}^2 u^2 \sqrt{1+u^2} \, du$$

$$= \frac{\pi}{4} \left[\frac{u}{8} (1+2u^2) \sqrt{1+u^2} - \frac{1}{8} \ln(u + \sqrt{1+u^2}) \right]_{-2}^2$$

(We used FORMULA 22 with $a = 1$)

$$= \frac{\pi}{4} \left[\frac{2}{8} (1+2 \cdot 4) \sqrt{1+4} - \frac{1}{8} \ln(2 + \sqrt{1+4}) \right]$$

$$+ \frac{2}{8} (1+2 \cdot 4) \sqrt{1+4} + \frac{1}{8} \ln(-2 + \sqrt{1+4}) \Big]$$

$$= \frac{\pi}{4} \left[\frac{9}{2} \sqrt{5} - \frac{1}{8} \ln \left(\frac{2+\sqrt{5}}{-2+\sqrt{5}} \right) \right] \approx 7.62$$

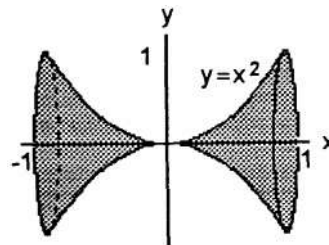

106. (a) The volume of the filled part equals the length of the tank times the area of the shaded region shown in the accompanying figure. Consider a layer of gasoline of thickness dy located at height y where $-r < y < -r + d$. The width of this layer is

$$2\sqrt{r^2 - y^2}. \text{ Therefore, } A = 2 \int_{-r}^{-r+d} \sqrt{r^2 - y^2} dy$$

$$\text{and } V = L \cdot A = 2L \int_{-r}^{-r+d} \sqrt{r^2 - y^2} dy$$

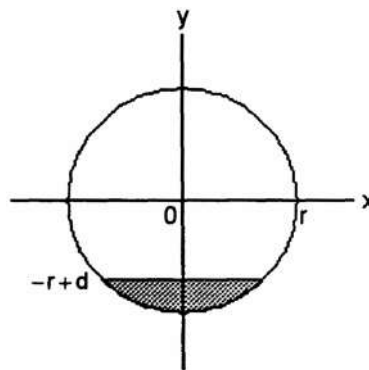

$$(b) \quad 2L \int_{-r}^{-r+d} \sqrt{r^2 - y^2} dy = 2L \left[\frac{y\sqrt{r^2 - y^2}}{2} + \frac{r^2}{2} \sin^{-1} \frac{y}{r} \right]_{-r}^{-r+d}$$

(We used FORMULA 29 with $a = r$)

$$= 2L \left[\frac{(d-r)}{2} \sqrt{2rd - d^2} + \frac{r^2}{2} \sin^{-1} \left(\frac{d-r}{r} \right) + \frac{r^2}{2} \left(\frac{\pi}{2} \right) \right] = 2L \left[\left(\frac{d-r}{2} \right) \sqrt{2rd - d^2} + \left(\frac{r^2}{2} \right) \left(\sin^{-1} \left(\frac{d-r}{r} \right) + \frac{\pi}{2} \right) \right]$$

107. The integrand $f(x) = \sqrt{x - x^2}$ is nonnegative, so the integral is maximized by integrating over the function's entire domain, which runs from $x = 0$ to $x = 1$

$$\Rightarrow \int_0^1 \sqrt{x - x^2} dx = \int_0^1 \sqrt{2 \cdot \frac{1}{2} x - x^2} dx = \left[\frac{(x - \frac{1}{2})}{2} \sqrt{2 \cdot \frac{1}{2} x - x^2} + \frac{(\frac{1}{2})^2}{2} \sin^{-1} \left(\frac{x - \frac{1}{2}}{\frac{1}{2}} \right) \right]_0^1$$

(We used FORMULA 48 with $a = \frac{1}{2}$)

$$= \left[\frac{(x - \frac{1}{2})}{2} \sqrt{x - x^2} + \frac{1}{8} \sin^{-1} (2x - 1) \right]_0^1 = \frac{1}{8} \cdot \frac{\pi}{2} - \frac{1}{8} \left(-\frac{\pi}{2} \right) = \frac{\pi}{8}$$

108. The integrand is maximized by integrating $g(x) = x\sqrt{2x - x^2}$ over the largest domain on which g is nonnegative, namely $[0, 2]$

$$\Rightarrow \int_0^2 x\sqrt{2x - x^2} dx = \left[\frac{(x+1)(2x-3)\sqrt{2x-x^2}}{6} + \frac{1}{2} \sin^{-1} (x-1) \right]_0^2$$

(We used FORMULA 51 with $a = 1$)

$$= \frac{1}{2} \cdot \frac{\pi}{2} - \frac{1}{2} \left(-\frac{\pi}{2} \right) = \frac{\pi}{2}$$

CAS EXPLORATIONS

109. Example CAS commands:

Maple:

$$q1 := \text{Int}(x \cdot \ln(x), x); \quad \# (a)$$

$$q1 = \text{value}(q1);$$

$$q2 := \text{Int}(x^2 \cdot \ln(x), x); \quad \# (b)$$

$$q2 = \text{value}(q2);$$

$$q3 := \text{Int}(x^3 \cdot \ln(x), x); \quad \# (c)$$

$$q3 = \text{value}(q3);$$

$$q4 := \text{Int}(x^4 \cdot \ln(x), x); \quad \# (d)$$

$$q4 = \text{value}(q4);$$

$$q5 := \text{Int}(x^n \cdot \ln(x), x); \quad \# (e)$$

$$q6 := \text{value}(q5);$$

$$q7 := \text{simplify}(q6) \text{ assuming } n::\text{integer};$$

$$q5 = \text{collect}(\text{factor}(q7), \ln(x));$$

110. Example CAS commands:

Maple:

```

q1 := Int( ln(x)/x, x );           # (a)
q1 = value( q1 );
q2 := Int( ln(x)/x^2, x );       # (b)
q2 = value( q2 );
q3 := Int( ln(x)/x^3, x );       # (c)
q3 = value( q3 );
q4 := Int( ln(x)/x^4, x );       # (d)
q4 = value( q4 );
q5 := Int( ln(x)/x^n, x );       # (e)
q6 := value( q5 );
q7 := simplify(q6) assuming n::integer;
q5 = collect( factor(q7), ln(x) );

```

111. Example CAS commands:

Maple:

```

q := Int( sin(x)^n/(sin(x)^n+cos(x)^n), x=0..Pi/2 ); # (a)
q = value( q );
q1 := eval( q, n=1 );           # (b)
q1 = value( q1 );
for N in [1,2,3,5,7] do
  q1 := eval( q, n=N );
  print( q1 = evalf(q1) );
end do;
qq1 := PDEtools[dchange]( x=Pi/2-u, q, [u] );         # (c)
qq2 := subs( u=x, qq1 );
qq3 := q + q = q + qq2;
qq4 := combine( qq3 );
qq5 := value( qq4 );
simplify( qq5/2 );

```

109-111.Example CAS commands:

Mathematica: (functions may vary)

In Mathematica, the natural log is denoted by Log rather than Ln, Log base 10 is Log[x,10]

Mathematica does not include an arbitrary constant when computing an indefinite integral,

```

Clear[x, f, n]
f[x_]:=Log[x] / x^n
Integrate[f[x], x]

```

For exercise 111, Mathematica cannot evaluate the integral with arbitrary n. It does evaluate the integral (value is $\pi/4$ in each case) for small values of n, but for large values of n, it identifies this integral as Indeterminate

$$109. (e) \int x^n \ln x \, dx = \frac{x^{n+1} \ln x}{n+1} - \frac{1}{n+1} \int x^n \, dx, n \neq -1$$

(We used FORMULA 110 with $a = 1, m = 1$)

$$= \frac{x^{n+1} \ln x}{n+1} - \frac{x^{n+1}}{(n+1)^2} + C = \frac{x^{n+1}}{n+1} \left(\ln x - \frac{1}{n+1} \right) + C$$

$$110. (e) \int x^{-n} \ln x \, dx = \frac{x^{-n+1} \ln x}{-n+1} - \frac{1}{(-n+1)} \int x^{-n} \, dx, n \neq 1$$

(We used FORMULA 110 with $a = 1, m = 1, n = -n$)

$$= \frac{x^{1-n} \ln x}{1-n} - \frac{1}{1-n} \left(\frac{x^{1-n}}{1-n} \right) + C = \frac{x^{1-n}}{1-n} \left(\ln x - \frac{1}{1-n} \right) + C$$

111. (a) Neither MAPLE nor MATHEMATICA can find this integral for arbitrary n.

(b) MAPLE and MATHEMATICA get stuck at about n = 5.

(c) Let $x = \frac{\pi}{2} - u \Rightarrow dx = -du$; $x = 0 \Rightarrow u = \frac{\pi}{2}$, $x = \frac{\pi}{2} \Rightarrow u = 0$;

$$I = \int_0^{\pi/2} \frac{\sin^n x \, dx}{\sin^n x + \cos^n x} = \int_{\pi/2}^0 \frac{-\sin^n(\frac{\pi}{2} - u) \, du}{\sin^n(\frac{\pi}{2} - u) + \cos^n(\frac{\pi}{2} - u)} = \int_0^{\pi/2} \frac{\cos^n u \, du}{\cos^n u + \sin^n u} = \int_0^{\pi/2} \frac{\cos^n x \, dx}{\cos^n x + \sin^n x}$$

$$\Rightarrow I + I = \int_0^{\pi/2} \left(\frac{\sin^n x + \cos^n x}{\sin^n x + \cos^n x} \right) dx = \int_0^{\pi/2} dx = \frac{\pi}{2} \Rightarrow I = \frac{\pi}{4}$$

8.7 NUMERICAL INTEGRATION

1. $\int_1^2 x \, dx$

I. (a) For n = 4, $\Delta x = \frac{b-a}{n} = \frac{2-1}{4} = \frac{1}{4} \Rightarrow \frac{\Delta x}{2} = \frac{1}{8}$;

$$\sum mf(x_i) = 12 \Rightarrow T = \frac{1}{8} (12) = \frac{3}{2}$$

$$f(x) = x \Rightarrow f'(x) = 1 \Rightarrow f'' = 0 \Rightarrow M = 0$$

$$\Rightarrow |E_T| = 0$$

	x_i	$f(x_i)$	m	$mf(x_i)$
x_0	1	1	1	1
x_1	5/4	5/4	2	5/2
x_2	3/2	3/2	2	3
x_3	7/4	7/4	2	7/2
x_4	2	2	1	2

(b) $\int_1^2 x \, dx = \left[\frac{x^2}{2} \right]_1^2 = 2 - \frac{1}{2} = \frac{3}{2} \Rightarrow |E_T| = \int_1^2 x \, dx - T = 0$

(c) $\frac{|E_T|}{\text{True Value}} \times 100 = 0\%$

II. (a) For n = 4, $\Delta x = \frac{b-a}{n} = \frac{2-1}{4} = \frac{1}{4} \Rightarrow \frac{\Delta x}{3} = \frac{1}{12}$;

$$\sum mf(x_i) = 18 \Rightarrow S = \frac{1}{12} (18) = \frac{3}{2}$$

$$f^{(4)}(x) = 0 \Rightarrow M = 0 \Rightarrow |E_S| = 0$$

(b) $\int_1^2 x \, dx = \frac{3}{2} \Rightarrow |E_S| = \int_1^2 x \, dx - S = \frac{3}{2} - \frac{3}{2} = 0$

(c) $\frac{|E_S|}{\text{True Value}} \times 100 = 0\%$

	x_i	$f(x_i)$	m	$mf(x_i)$
x_0	1	1	1	1
x_1	5/4	5/4	4	5
x_2	3/2	3/2	2	3
x_3	7/4	7/4	4	7
x_4	2	2	1	2

2. $\int_1^3 (2x - 1) \, dx$

I. (a) For n = 4, $\Delta x = \frac{b-a}{n} = \frac{3-1}{4} = \frac{2}{4} = \frac{1}{2} \Rightarrow \frac{\Delta x}{2} = \frac{1}{4}$;

$$\sum mf(x_i) = 24 \Rightarrow T = \frac{1}{4} (24) = 6$$

$$f(x) = 2x - 1 \Rightarrow f'(x) = 2 \Rightarrow f'' = 0 \Rightarrow M = 0$$

$$\Rightarrow |E_T| = 0$$

(b) $\int_1^3 (2x - 1) \, dx = [x^2 - x]_1^3 = (9 - 3) - (1 - 1) = 6 \Rightarrow |E_T| = \int_1^3 (2x - 1) \, dx - T = 6 - 6 = 0$

(c) $\frac{|E_T|}{\text{True Value}} \times 100 = 0\%$

	x_i	$f(x_i)$	m	$mf(x_i)$
x_0	1	1	1	1
x_1	3/2	2	2	4
x_2	2	3	2	6
x_3	5/2	4	2	8
x_4	3	5	1	5

II. (a) For n = 4, $\Delta x = \frac{b-a}{n} = \frac{3-1}{4} = \frac{2}{4} = \frac{1}{2} \Rightarrow \frac{\Delta x}{3} = \frac{1}{6}$;

$$\sum mf(x_i) = 36 \Rightarrow S = \frac{1}{6} (36) = 6$$

$$f^{(4)}(x) = 0 \Rightarrow M = 0 \Rightarrow |E_S| = 0$$

(b) $\int_1^3 (2x - 1) \, dx = 6 \Rightarrow |E_S| = \int_1^3 (2x - 1) \, dx - S = 6 - 6 = 0$

(c) $\frac{|E_S|}{\text{True Value}} \times 100 = 0\%$

	x_i	$f(x_i)$	m	$mf(x_i)$
x_0	1	1	1	1
x_1	3/2	2	4	8
x_2	2	3	2	6
x_3	5/2	4	4	16
x_4	3	5	1	5

3. $\int_{-1}^1 (x^2 + 1) \, dx$

I. (a) For n = 4, $\Delta x = \frac{b-a}{n} = \frac{1-(-1)}{4} = \frac{2}{4} = \frac{1}{2} \Rightarrow \frac{\Delta x}{2} = \frac{1}{4}$;

$$\sum mf(x_i) = 11 \Rightarrow T = \frac{1}{4} (11) = 2.75$$

$$f(x) = x^2 + 1 \Rightarrow f'(x) = 2x \Rightarrow f''(x) = 2 \Rightarrow M = 2$$

$$\Rightarrow |E_T| \leq \frac{1-(-1)}{12} \left(\frac{1}{2} \right)^2 (2) = \frac{1}{12} \text{ or } 0.08333$$

	x_i	$f(x_i)$	m	$mf(x_i)$
x_0	-1	2	1	2
x_1	-1/2	5/4	2	5/2
x_2	0	1	2	2
x_3	1/2	5/4	2	5/2
x_4	1	2	1	2

(b) $\int_{-1}^1 (x^2 + 1) dx = \left[\frac{x^3}{3} + x \right]_{-1}^1 = \left(\frac{1}{3} + 1 \right) - \left(-\frac{1}{3} - 1 \right) = \frac{8}{3} \Rightarrow E_T = \int_{-1}^1 (x^2 + 1) dx - T = \frac{8}{3} - \frac{11}{4} = -\frac{1}{12}$
 $\Rightarrow |E_T| = \left| -\frac{1}{12} \right| \approx 0.08333$

(c) $\frac{|E_T|}{\text{True Value}} \times 100 = \left(\frac{\frac{1}{12}}{\frac{8}{3}} \right) \times 100 \approx 3\%$

II. (a) For $n = 4$, $\Delta x = \frac{b-a}{n} = \frac{1-(-1)}{4} = \frac{2}{4} = \frac{1}{2} \Rightarrow \frac{\Delta x}{3} = \frac{1}{6}$;
 $\sum mf(x_i) = 16 \Rightarrow S = \frac{1}{6}(16) = \frac{8}{3} = 2.66667$;
 $f^{(3)}(x) = 0 \Rightarrow f^{(4)}(x) = 0 \Rightarrow M = 0 \Rightarrow |E_S| = 0$

	x_i	$f(x_i)$	m	$mf(x_i)$
x_0	-1	2	1	2
x_1	-1/2	5/4	4	5
x_2	0	1	2	2
x_3	1/2	5/4	4	5
x_4	1	2	1	2

(b) $\int_{-1}^1 (x^2 + 1) dx = \left[\frac{x^3}{3} + x \right]_{-1}^1 = \frac{8}{3}$
 $\Rightarrow |E_S| = \int_{-1}^1 (x^2 + 1) dx - S = \frac{8}{3} - \frac{8}{3} = 0$

(c) $\frac{|E_S|}{\text{True Value}} \times 100 = 0\%$

4. $\int_{-2}^0 (x^2 - 1) dx$

I. (a) For $n = 4$, $\Delta x = \frac{b-a}{n} = \frac{0-(-2)}{4} = \frac{2}{4} = \frac{1}{2} \Rightarrow \frac{\Delta x}{2} = \frac{1}{4}$
 $\sum mf(x_i) = 3 \Rightarrow T = \frac{1}{4}(3) = \frac{3}{4}$;
 $f(x) = x^2 - 1 \Rightarrow f'(x) = 2x \Rightarrow f''(x) = 2$
 $\Rightarrow M = 2 \Rightarrow |E_T| \leq \frac{0-(-2)}{12} \left(\frac{1}{2} \right)^2 (2) = \frac{1}{12} = 0.08333$

	x_i	$f(x_i)$	m	$mf(x_i)$
x_0	-2	3	1	3
x_1	-3/2	5/4	2	5/2
x_2	-1	0	2	0
x_3	-1/2	-3/4	2	-3/2
x_4	0	-1	1	-1

(b) $\int_{-2}^0 (x^2 - 1) dx = \left[\frac{x^3}{3} - x \right]_{-2}^0 = 0 - \left(-\frac{8}{3} + 2 \right) = \frac{2}{3} \Rightarrow E_T = \int_{-2}^0 (x^2 - 1) dx - T = \frac{2}{3} - \frac{3}{4} = -\frac{1}{12}$
 $\Rightarrow |E_T| = \frac{1}{12}$

(c) $\frac{|E_T|}{\text{True Value}} \times 100 = \left(\frac{\frac{1}{12}}{\frac{2}{3}} \right) \times 100 \approx 13\%$

II. (a) For $n = 4$, $\Delta x = \frac{b-a}{n} = \frac{0-(-2)}{4} = \frac{2}{4} = \frac{1}{2}$
 $\Rightarrow \frac{\Delta x}{3} = \frac{1}{6}$; $\sum mf(x_i) = 4 \Rightarrow S = \frac{1}{6}(4) = \frac{2}{3}$;
 $f^{(3)}(x) = 0 \Rightarrow f^{(4)}(x) = 0 \Rightarrow M = 0 \Rightarrow |E_S| = 0$

	x_i	$f(x_i)$	m	$mf(x_i)$
x_0	-2	3	1	3
x_1	-3/2	5/4	4	5
x_2	-1	0	2	0
x_3	-1/2	-3/4	4	-3
x_4	0	-1	1	-1

(b) $\int_{-2}^0 (x^2 - 1) dx = \frac{2}{3} \Rightarrow |E_S| = \int_{-2}^0 (x^2 - 1) dx - S = \frac{2}{3} - \frac{2}{3} = 0$

(c) $\frac{|E_S|}{\text{True Value}} \times 100 = 0\%$

5. $\int_0^2 (t^3 + t) dt$

I. (a) For $n = 4$, $\Delta x = \frac{b-a}{n} = \frac{2-0}{4} = \frac{2}{4} = \frac{1}{2}$
 $\Rightarrow \frac{\Delta x}{2} = \frac{1}{4}$; $\sum mf(t_i) = 25 \Rightarrow T = \frac{1}{4}(25) = \frac{25}{4}$;
 $f(t) = t^3 + t \Rightarrow f'(t) = 3t^2 + 1 \Rightarrow f''(t) = 6t$
 $\Rightarrow M = 12 = f''(2) \Rightarrow |E_T| \leq \frac{2-0}{12} \left(\frac{1}{2} \right)^2 (12) = \frac{1}{2}$

	t_i	$f(t_i)$	m	$mf(t_i)$
t_0	0	0	1	0
t_1	1/2	5/8	2	5/4
t_2	1	2	2	4
t_3	3/2	39/8	2	39/4
t_4	2	10	1	10

(b) $\int_0^2 (t^3 + t) dt = \left[\frac{t^4}{4} + \frac{t^2}{2} \right]_0^2 = \left(\frac{2^4}{4} + \frac{2^2}{2} \right) - 0 = 6 \Rightarrow |E_T| = \int_0^2 (t^3 + t) dt - T = 6 - \frac{25}{4} = -\frac{1}{4} \Rightarrow |E_T| = \frac{1}{4}$

(c) $\frac{|E_T|}{\text{True Value}} \times 100 = \frac{\frac{1}{4}}{6} \times 100 \approx 4\%$

II. (a) For $n = 4$, $\Delta x = \frac{b-a}{n} = \frac{2-0}{4} = \frac{2}{4} = \frac{1}{2} \Rightarrow \frac{\Delta x}{3} = \frac{1}{6}$;
 $\sum mf(t_i) = 36 \Rightarrow S = \frac{1}{6}(36) = 6$;
 $f^{(3)}(t) = 6 \Rightarrow f^{(4)}(t) = 0 \Rightarrow M = 0 \Rightarrow |E_S| = 0$

	t_i	$f(t_i)$	m	$mf(t_i)$
t_0	0	0	1	0
t_1	1/2	5/8	4	5/2
t_2	1	2	2	4
t_3	3/2	39/8	4	39/2
t_4	2	10	1	10

(b) $\int_0^2 (t^3 + t) dt = 6 \Rightarrow |E_S| = \int_0^2 (t^3 + t) dt - S = 6 - 6 = 0$

(c) $\frac{|E_S|}{\text{True Value}} \times 100 = 0\%$

6. $\int_{-1}^1 (t^3 + 1) dt$

I. (a) For $n = 4$, $\Delta x = \frac{b-a}{n} = \frac{1-(-1)}{4} = \frac{2}{4} = \frac{1}{2}$
 $\Rightarrow \frac{\Delta x}{2} = \frac{1}{4}$; $\sum mf(t_i) = 8 \Rightarrow T = \frac{1}{4}(8) = 2$;
 $f(t) = t^3 + 1 \Rightarrow f'(t) = 3t^2 \Rightarrow f''(t) = 6t$
 $\Rightarrow M = 6 = f''(1) \Rightarrow |E_T| \leq \frac{1-(-1)}{12} \left(\frac{1}{2}\right)^2(6) = \frac{1}{4}$

	t_i	$f(t_i)$	m	$mf(t_i)$
t_0	-1	0	1	0
t_1	-1/2	7/8	2	7/4
t_2	0	1	2	2
t_3	1/2	9/8	2	9/4
t_4	1	2	1	2

(b) $\int_{-1}^1 (t^3 + 1) dt = \left[\frac{t^4}{4} + t\right]_{-1}^1 = \left(\frac{1}{4} + 1\right) - \left(\frac{(-1)^4}{4} + (-1)\right) = 2 \Rightarrow |E_T| = \int_{-1}^1 (t^3 + 1) dt - T = 2 - 2 = 0$

(c) $\frac{|E_T|}{\text{True Value}} \times 100 = 0\%$

II. (a) For $n = 4$, $\Delta x = \frac{b-a}{n} = \frac{1-(-1)}{4} = \frac{2}{4} = \frac{1}{2}$
 $\Rightarrow \frac{\Delta x}{3} = \frac{1}{6}$; $\sum mf(t_i) = 12 \Rightarrow S = \frac{1}{6}(12) = 2$;
 $f^{(3)}(t) = 6 \Rightarrow f^{(4)}(t) = 0 \Rightarrow M = 0 \Rightarrow |E_S| = 0$

	t_i	$f(t_i)$	m	$mf(t_i)$
t_0	-1	0	1	0
t_1	-1/2	7/8	4	7/2
t_2	0	1	2	2
t_3	1/2	9/8	4	9/2
t_4	1	2	1	2

(b) $\int_{-1}^1 (t^3 + 1) dt = 2 \Rightarrow |E_S| = \int_{-1}^1 (t^3 + 1) dt - S = 2 - 2 = 0$

(c) $\frac{|E_S|}{\text{True Value}} \times 100 = 0\%$

7. $\int_1^2 \frac{1}{s^2} ds$

I. (a) For $n = 4$, $\Delta x = \frac{b-a}{n} = \frac{2-1}{4} = \frac{1}{4} \Rightarrow \frac{\Delta x}{2} = \frac{1}{8}$;
 $\sum mf(s_i) = \frac{179,573}{44,100} \Rightarrow T = \frac{1}{8} \left(\frac{179,573}{44,100}\right) = \frac{179,573}{352,800}$
 ≈ 0.50899 ; $f(s) = \frac{1}{s^2} \Rightarrow f'(s) = -\frac{2}{s^3}$
 $\Rightarrow f''(s) = \frac{6}{s^4} \Rightarrow M = 6 = f''(1)$
 $\Rightarrow |E_T| \leq \frac{2-1}{12} \left(\frac{1}{4}\right)^2(6) = \frac{1}{32} = 0.03125$

	s_i	$f(s_i)$	m	$mf(s_i)$
s_0	1	1	1	1
s_1	5/4	16/25	2	32/25
s_2	3/2	4/9	2	8/9
s_3	7/4	16/49	2	32/49
s_4	2	1/4	1	1/4

(b) $\int_1^2 \frac{1}{s^2} ds = \int_1^2 s^{-2} ds = \left[-\frac{1}{s}\right]_1^2 = -\frac{1}{2} - \left(-\frac{1}{1}\right) = \frac{1}{2} \Rightarrow E_T = \int_1^2 \frac{1}{s^2} ds - T = \frac{1}{2} - 0.50899 = -0.00899$
 $\Rightarrow |E_T| = 0.00899$

(c) $\frac{|E_T|}{\text{True Value}} \times 100 = \frac{0.00899}{0.5} \times 100 \approx 2\%$

II. (a) For $n = 4$, $\Delta x = \frac{b-a}{n} = \frac{2-1}{4} = \frac{1}{4} \Rightarrow \frac{\Delta x}{3} = \frac{1}{12}$;
 $\sum mf(s_i) = \frac{264,821}{44,100} \Rightarrow S = \frac{1}{12} \left(\frac{264,821}{44,100}\right) = \frac{264,821}{529,200}$
 ≈ 0.50042 ; $f^{(3)}(s) = -\frac{24}{s^5} \Rightarrow f^{(4)}(s) = \frac{120}{s^6}$
 $\Rightarrow M = 120 \Rightarrow |E_S| \leq \left|\frac{2-1}{180}\right| \left(\frac{1}{4}\right)^4(120)$
 $= \frac{1}{384} \approx 0.00260$

	s_i	$f(s_i)$	m	$mf(s_i)$
s_0	1	1	1	1
s_1	5/4	16/25	4	64/25
s_2	3/2	4/9	2	8/9
s_3	7/4	16/49	4	64/49
s_4	2	1/4	1	1/4

(b) $\int_1^2 \frac{1}{s^2} ds = \frac{1}{2} \Rightarrow E_S = \int_1^2 \frac{1}{s^2} ds - S = \frac{1}{2} - 0.50042 = -0.00042 \Rightarrow |E_S| = 0.00042$

(c) $\frac{|E_S|}{\text{True Value}} \times 100 = \frac{0.0004}{0.5} \times 100 \approx 0.08\%$

8. $\int_2^4 \frac{1}{(s-1)^2} ds$

I. (a) For $n = 4$, $\Delta x = \frac{b-a}{n} = \frac{4-2}{4} = \frac{1}{2} \Rightarrow \frac{\Delta x}{2} = \frac{1}{4}$;
 $\sum mf(s_i) = \frac{1269}{450}$
 $\Rightarrow T = \frac{1}{4} \left(\frac{1269}{450}\right) = \frac{1269}{1800} = 0.70500$;
 $f(s) = (s-1)^{-2} \Rightarrow f'(s) = -\frac{2}{(s-1)^3}$
 $\Rightarrow f''(s) = \frac{6}{(s-1)^4} \Rightarrow M = 6$

	s_i	$f(s_i)$	m	$mf(s_i)$
s_0	2	1	1	1
s_1	5/2	4/9	2	8/9
s_2	3	1/4	2	1/2
s_3	7/2	4/25	2	8/25
s_4	4	1/9	1	1/9

$\Rightarrow |E_T| \leq \frac{4-2}{12} \left(\frac{1}{2}\right)^2(6) = \frac{1}{4} = 0.25$

(b) $\int_2^4 \frac{1}{(s-1)^2} ds = \left[\frac{-1}{s-1}\right]_2^4 = \left(\frac{-1}{4-1}\right) - \left(\frac{-1}{2-1}\right) = \frac{2}{3} \Rightarrow E_T = \int_2^4 \frac{1}{(s-1)^2} ds - T = \frac{2}{3} - 0.705 \approx -0.03833$
 $\Rightarrow |E_T| \approx 0.03833$

(c) $\frac{|E_T|}{\text{True Value}} \times 100 = \frac{0.03833}{(\frac{2}{3})} \times 100 \approx 6\%$

II. (a) For $n = 4$, $\Delta x = \frac{b-a}{n} = \frac{4-2}{4} = \frac{1}{2} \Rightarrow \frac{\Delta x}{3} = \frac{1}{6}$;

$\sum mf(s_i) = \frac{1813}{450}$

$\Rightarrow S = \frac{1}{6} \left(\frac{1813}{450} \right) = \frac{1813}{2700} \approx 0.67148$;

$f^{(3)}(s) = \frac{-24}{(s-1)^3} \Rightarrow f^{(4)}(s) = \frac{120}{(s-1)^4} \Rightarrow M = 120$

$\Rightarrow |E_S| \leq \frac{4-2}{180} \left(\frac{1}{2} \right)^4 (120) = \frac{1}{12} \approx 0.08333$

(b) $\int_2^4 \frac{1}{(s-1)^2} ds = \frac{2}{3} \Rightarrow E_S = \int_2^4 \frac{1}{(s-1)^2} ds - S \approx \frac{2}{3} - 0.67148 = -0.00481 \Rightarrow |E_S| \approx 0.00481$

(c) $\frac{|E_S|}{\text{True Value}} \times 100 = \frac{0.00481}{(\frac{2}{3})} \times 100 \approx 1\%$

	s_i	$f(s_i)$	m	$mf(s_i)$
s_0	2	1	1	1
s_1	5/2	4/9	4	16/9
s_2	3	1/4	2	1/2
s_3	7/2	4/25	4	16/25
s_4	4	1/9	1	1/9

9. $\int_0^\pi \sin t dt$

I. (a) For $n = 4$, $\Delta x = \frac{b-a}{n} = \frac{\pi-0}{4} = \frac{\pi}{4} \Rightarrow \frac{\Delta x}{2} = \frac{\pi}{8}$;

$\sum mf(t_i) = 2 + 2\sqrt{2} \approx 4.8284$

$\Rightarrow T = \frac{\pi}{8} (2 + 2\sqrt{2}) \approx 1.89612$;

$f(t) = \sin t \Rightarrow f'(t) = \cos t \Rightarrow f''(t) = -\sin t$

$\Rightarrow M = 1 \Rightarrow |E_T| \leq \frac{\pi-0}{12} \left(\frac{\pi}{4} \right)^2 (1) = \frac{\pi^3}{192}$

≈ 0.16149

(b) $\int_0^\pi \sin t dt = [-\cos t]_0^\pi = (-\cos \pi) - (-\cos 0) = 2 \Rightarrow |E_T| = \int_0^\pi \sin t dt - T \approx 2 - 1.89612 = 0.10388$

(c) $\frac{|E_T|}{\text{True Value}} \times 100 = \frac{0.10388}{2} \times 100 \approx 5\%$

II. (a) For $n = 4$, $\Delta x = \frac{b-a}{n} = \frac{\pi-0}{4} = \frac{\pi}{4} \Rightarrow \frac{\Delta x}{3} = \frac{\pi}{12}$;

$\sum mf(t_i) = 2 + 4\sqrt{2} \approx 7.6569$

$\Rightarrow S = \frac{\pi}{12} (2 + 4\sqrt{2}) \approx 2.00456$;

$f^{(3)}(t) = -\cos t \Rightarrow f^{(4)}(t) = \sin t$

$\Rightarrow M = 1 \Rightarrow |E_S| \leq \frac{\pi-0}{180} \left(\frac{\pi}{4} \right)^4 (1) \approx 0.00664$

(b) $\int_0^\pi \sin t dt = 2 \Rightarrow E_S = \int_0^\pi \sin t dt - S \approx 2 - 2.00456 = -0.00456 \Rightarrow |E_S| \approx 0.00456$

(c) $\frac{|E_S|}{\text{True Value}} \times 100 = \frac{0.00456}{2} \times 100 \approx 0\%$

	t_i	$f(t_i)$	m	$mf(t_i)$
t_0	0	0	1	0
t_1	$\pi/4$	$\sqrt{2}/2$	2	$\sqrt{2}$
t_2	$\pi/2$	1	2	2
t_3	$3\pi/4$	$\sqrt{2}/2$	2	$\sqrt{2}$
t_4	π	0	1	0

	t_i	$f(t_i)$	m	$mf(t_i)$
t_0	0	0	1	0
t_1	$\pi/4$	$\sqrt{2}/2$	4	$2\sqrt{2}$
t_2	$\pi/2$	1	2	2
t_3	$3\pi/4$	$\sqrt{2}/2$	4	$2\sqrt{2}$
t_4	π	0	1	0

10. $\int_0^1 \sin \pi t dt$

I. (a) For $n = 4$, $\Delta x = \frac{b-a}{n} = \frac{1-0}{4} = \frac{1}{4} \Rightarrow \frac{\Delta x}{2} = \frac{1}{8}$;

$\sum mf(t_i) = 2 + 2\sqrt{2} \approx 4.828$

$\Rightarrow T = \frac{1}{8} (2 + 2\sqrt{2}) \approx 0.60355$; $f(t) = \sin \pi t$

$\Rightarrow f'(t) = \pi \cos \pi t$

$\Rightarrow f''(t) = -\pi^2 \sin \pi t \Rightarrow M = \pi^2$

$\Rightarrow |E_T| \leq \frac{1-0}{12} \left(\frac{1}{4} \right)^2 (\pi^2) \approx 0.05140$

(b) $\int_0^1 \sin \pi t dt = [-\frac{1}{\pi} \cos \pi t]_0^1 = (-\frac{1}{\pi} \cos \pi) - (-\frac{1}{\pi} \cos 0) = \frac{2}{\pi} \approx 0.63662 \Rightarrow |E_T| = \int_0^1 \sin \pi t dt - T \approx \frac{2}{\pi} - 0.60355 = 0.03307$

(c) $\frac{|E_T|}{\text{True Value}} \times 100 = \frac{0.03307}{(\frac{2}{\pi})} \times 100 \approx 5\%$

	t_i	$f(t_i)$	m	$mf(t_i)$
t_0	0	0	1	0
t_1	1/4	$\sqrt{2}/2$	2	$\sqrt{2}$
t_2	1/2	1	2	2
t_3	3/4	$\sqrt{2}/2$	2	$\sqrt{2}$
t_4	1	0	1	0

II. (a) For $n = 4$, $\Delta x = \frac{b-a}{n} = \frac{1-0}{4} = \frac{1}{4} \Rightarrow \frac{\Delta x}{3} = \frac{1}{12}$;

$$\sum mf(t_i) = 2 + 4\sqrt{2} \approx 7.65685$$

$$\Rightarrow S = \frac{1}{12} (2 + 4\sqrt{2}) \approx 0.63807;$$

$$f^{(3)}(t) = -\pi^3 \cos \pi t \Rightarrow f^{(4)}(t) = \pi^4 \sin \pi t$$

$$\Rightarrow M = \pi^4 \Rightarrow |E_S| \leq \frac{1-0}{180} \left(\frac{1}{4}\right)^4 (\pi^4) \approx 0.00211$$

	t_i	$f(t_i)$	m	$mf(t_i)$
t_0	0	0	1	0
t_1	1/4	$\sqrt{2}/2$	4	$2\sqrt{2}$
t_2	1/2	1	2	2
t_3	3/4	$\sqrt{2}/2$	4	$2\sqrt{2}$
t_4	1	0	1	0

(b) $\int_0^1 \sin \pi t \, dt = \frac{2}{\pi} \approx 0.63662 \Rightarrow E_S = \int_0^1 \sin \pi t \, dt - S \approx \frac{2}{\pi} - 0.63807 = -0.00145 \Rightarrow |E_S| \approx 0.00145$

(c) $\frac{|E_S|}{\text{True Value}} \times 100 = \frac{0.00145}{(\frac{2}{\pi})} \times 100 \approx 0\%$

11. (a) $n = 8 \Rightarrow \Delta x = \frac{1}{8} \Rightarrow \frac{\Delta x}{2} = \frac{1}{16}$;

$$\sum mf(x_i) = 1(0.0) + 2(0.12402) + 2(0.24206) + 2(0.34763) + 2(0.43301) + 2(0.48789) + 2(0.49608) + 2(0.42361) + 1(0) = 5.1086 \Rightarrow T = \frac{1}{16} (5.1086) = 0.31929$$

(b) $n = 8 \Rightarrow \Delta x = \frac{1}{8} \Rightarrow \frac{\Delta x}{3} = \frac{1}{24}$;

$$\sum mf(x_i) = 1(0.0) + 4(0.12402) + 2(0.24206) + 4(0.34763) + 2(0.43301) + 4(0.48789) + 2(0.49608) + 4(0.42361) + 1(0) = 7.8749 \Rightarrow S = \frac{1}{24} (7.8749) = 0.32812$$

(c) Let $u = 1 - x^2 \Rightarrow du = -2x \, dx \Rightarrow -\frac{1}{2} du = x \, dx$; $x = 0 \Rightarrow u = 1$, $x = 1 \Rightarrow u = 0$

$$\int_0^1 x\sqrt{1-x^2} \, dx = \int_1^0 \sqrt{u} \left(-\frac{1}{2} du\right) = \frac{1}{2} \int_0^1 u^{1/2} \, du = \left[\frac{2}{3} \left(\frac{u^{3/2}}{3}\right)\right]_0^1 = \left[\frac{2}{9} u^{3/2}\right]_0^1 = \frac{2}{9} (1)^{3/2} - \frac{2}{9} (0)^{3/2} = \frac{2}{9};$$

$$E_T = \int_0^1 x\sqrt{1-x^2} \, dx - T \approx \frac{2}{9} - 0.31929 = 0.01404; E_S = \int_0^1 x\sqrt{1-x^2} \, dx - S \approx \frac{2}{9} - 0.32812 = 0.00521$$

12. (a) $n = 8 \Rightarrow \Delta x = \frac{3}{8} \Rightarrow \frac{\Delta x}{2} = \frac{3}{16}$;

$$\sum mf(\theta_i) = 1(0) + 2(0.09334) + 2(0.18429) + 2(0.27075) + 2(0.35112) + 2(0.42443) + 2(0.49026) + 2(0.58466) + 1(0.6) = 5.3977 \Rightarrow T = \frac{3}{16} (5.3977) = 1.01207$$

(b) $n = 8 \Rightarrow \Delta x = \frac{3}{8} \Rightarrow \frac{\Delta x}{3} = \frac{1}{8}$;

$$\sum mf(\theta_i) = 1(0) + 4(0.09334) + 2(0.18429) + 4(0.27075) + 2(0.35112) + 4(0.42443) + 2(0.49026) + 4(0.58466) + 1(0.6) = 8.14406 \Rightarrow S = \frac{1}{8} (8.14406) = 1.01801$$

(c) Let $u = 16 + \theta^2 \Rightarrow du = 2\theta \, d\theta \Rightarrow \frac{1}{2} du = \theta \, d\theta$; $\theta = 0 \Rightarrow u = 16$, $\theta = 3 \Rightarrow u = 16 + 3^2 = 25$

$$\int_0^3 \frac{\theta}{\sqrt{16+\theta^2}} \, d\theta = \int_{16}^{25} \frac{1}{\sqrt{u}} \left(\frac{1}{2} du\right) = \frac{1}{2} \int_{16}^{25} u^{-1/2} \, du = \left[\frac{2}{1} \left(\frac{u^{1/2}}{2}\right)\right]_{16}^{25} = \sqrt{25} - \sqrt{16} = 1;$$

$$E_T = \int_0^3 \frac{\theta}{\sqrt{16+\theta^2}} \, d\theta - T \approx 1 - 1.01207 = -0.01207; E_S = \int_0^3 \frac{\theta}{\sqrt{16+\theta^2}} \, d\theta - S \approx 1 - 1.01801 = -0.01801$$

13. (a) $n = 8 \Rightarrow \Delta x = \frac{\pi}{8} \Rightarrow \frac{\Delta x}{2} = \frac{\pi}{16}$;

$$\sum mf(t_i) = 1(0.0) + 2(0.99138) + 2(1.26906) + 2(1.05961) + 2(0.75) + 2(0.48821) + 2(0.28946) + 2(0.13429) + 1(0) = 9.96402 \Rightarrow T = \frac{\pi}{16} (9.96402) \approx 1.95643$$

(b) $n = 8 \Rightarrow \Delta x = \frac{\pi}{8} \Rightarrow \frac{\Delta x}{3} = \frac{\pi}{24}$;

$$\sum mf(t_i) = 1(0.0) + 4(0.99138) + 2(1.26906) + 4(1.05961) + 2(0.75) + 4(0.48821) + 2(0.28946) + 4(0.13429) + 1(0) = 15.311 \Rightarrow S \approx \frac{\pi}{24} (15.311) \approx 2.00421$$

(c) Let $u = 2 + \sin t \Rightarrow du = \cos t \, dt$; $t = -\frac{\pi}{2} \Rightarrow u = 2 + \sin\left(-\frac{\pi}{2}\right) = 1$, $t = \frac{\pi}{2} \Rightarrow u = 2 + \sin\frac{\pi}{2} = 3$

$$\int_{-\pi/2}^{\pi/2} \frac{3 \cos t}{(2 + \sin t)^2} \, dt = \int_1^3 \frac{3}{u^2} \, du = 3 \int_1^3 u^{-2} \, du = \left[3 \left(\frac{u^{-1}}{-1}\right)\right]_1^3 = 3 \left(-\frac{1}{3}\right) - 3 \left(-\frac{1}{1}\right) = 2;$$

$$E_T = \int_{-\pi/2}^{\pi/2} \frac{3 \cos t}{(2 + \sin t)^2} \, dt - T \approx 2 - 1.95643 = 0.04357; E_S = \int_{-\pi/2}^{\pi/2} \frac{3 \cos t}{(2 + \sin t)^2} \, dt - S$$

$$\approx 2 - 2.00421 = -0.00421$$

14. (a) $n = 8 \Rightarrow \Delta x = \frac{\pi}{32} \Rightarrow \frac{\Delta x}{2} = \frac{\pi}{64}$;
 $\sum mf(y_i) = 1(2.0) + 2(1.51606) + 2(1.18237) + 2(0.93998) + 2(0.75402) + 2(0.60145) + 2(0.46364)$
 $+ 2(0.31688) + 1(0) = 13.5488 \Rightarrow T \approx \frac{\pi}{64} (13.5488) = 0.66508$
- (b) $n = 8 \Rightarrow \Delta x = \frac{\pi}{32} \Rightarrow \frac{\Delta x}{3} = \frac{\pi}{96}$;
 $\sum mf(y_i) = 1(2.0) + 4(1.51606) + 2(1.18237) + 4(0.93988) + 2(0.75402) + 4(0.60145) + 2(0.46364)$
 $+ 4(0.31688) + 1(0) = 20.29734 \Rightarrow S \approx \frac{\pi}{96} (20.29734) = 0.66423$
- (c) Let $u = \cot y \Rightarrow du = -\csc^2 y dy$; $y = \frac{\pi}{4} \Rightarrow u = 1$, $y = \frac{\pi}{2} \Rightarrow u = 0$
 $\int_{\pi/4}^{\pi/2} (\csc^2 y) \sqrt{\cot y} dy = \int_1^0 \sqrt{u} (-du) = \int_0^1 u^{1/2} du = \left[\frac{u^{3/2}}{3/2} \right]_0^1 = \frac{2}{3} \left(\sqrt{1} \right)^3 - \frac{2}{3} \left(\sqrt{0} \right)^3 = \frac{2}{3}$;
 $E_T = \int_{\pi/4}^{\pi/2} (\csc^2 y) \sqrt{\cot y} dy - T \approx \frac{2}{3} - 0.66508 = 0.00159$; $E_S = \int_{\pi/4}^{\pi/2} (\csc^2 y) \sqrt{\cot y} dy - S$
 $\approx \frac{2}{3} - 0.66423 = 0.00244$
15. (a) $M = 0$ (see Exercise 1): Then $n = 1 \Rightarrow \Delta x = 1 \Rightarrow |E_T| = \frac{1}{12} (1)^2(0) = 0 < 10^{-4}$
- (b) $M = 0$ (see Exercise 1): Then $n = 2$ (n must be even) $\Rightarrow \Delta x = \frac{1}{2} \Rightarrow |E_S| = \frac{1}{180} \left(\frac{1}{2}\right)^4(0) = 0 < 10^{-4}$
16. (a) $M = 0$ (see Exercise 2): Then $n = 1 \Rightarrow \Delta x = 2 \Rightarrow |E_T| = \frac{2}{12} (2)^2(0) = 0 < 10^{-4}$
- (b) $M = 0$ (see Exercise 2): Then $n = 2$ (n must be even) $\Rightarrow \Delta x = 1 \Rightarrow |E_S| = \frac{2}{180} (1)^4(0) = 0 < 10^{-4}$
17. (a) $M = 2$ (see Exercise 3): Then $\Delta x = \frac{2}{n} \Rightarrow |E_T| \leq \frac{2}{12} \left(\frac{2}{n}\right)^2(2) = \frac{4}{3n^2} < 10^{-4} \Rightarrow n^2 > \frac{4}{3}(10^4) \Rightarrow n > \sqrt{\frac{4}{3}(10^4)}$
 $\Rightarrow n > 115.4$, so let $n = 116$
- (b) $M = 0$ (see Exercise 3): Then $n = 2$ (n must be even) $\Rightarrow \Delta x = 1 \Rightarrow |E_S| = \frac{2}{180} (1)^4(0) = 0 < 10^{-4}$
18. (a) $M = 2$ (see Exercise 4): Then $\Delta x = \frac{2}{n} \Rightarrow |E_T| \leq \frac{2}{12} \left(\frac{2}{n}\right)^2(2) = \frac{4}{3n^2} < 10^{-4} \Rightarrow n^2 > \frac{4}{3}(10^4) \Rightarrow n > \sqrt{\frac{4}{3}(10^4)}$
 $\Rightarrow n > 115.4$, so let $n = 116$
- (b) $M = 0$ (see Exercise 4): Then $n = 2$ (n must be even) $\Rightarrow \Delta x = 1 \Rightarrow |E_S| = \frac{2}{180} (1)^4(0) = 0 < 10^{-4}$
19. (a) $M = 12$ (see Exercise 5): Then $\Delta x = \frac{2}{n} \Rightarrow |E_T| \leq \frac{2}{12} \left(\frac{2}{n}\right)^2(12) = \frac{8}{n^2} < 10^{-4} \Rightarrow n^2 > 8(10^4) \Rightarrow n > \sqrt{8(10^4)}$
 $\Rightarrow n > 282.8$, so let $n = 283$
- (b) $M = 0$ (see Exercise 5): Then $n = 2$ (n must be even) $\Rightarrow \Delta x = 1 \Rightarrow |E_S| = \frac{2}{180} (1)^4(0) = 0 < 10^{-4}$
20. (a) $M = 6$ (see Exercise 6): Then $\Delta x = \frac{2}{n} \Rightarrow |E_T| \leq \frac{2}{12} \left(\frac{2}{n}\right)^2(6) = \frac{4}{n^2} < 10^{-4} \Rightarrow n^2 > 4(10^4) \Rightarrow n > \sqrt{4(10^4)}$
 $= 200$, so let $n = 201$
- (b) $M = 0$ (see Exercise 6): Then $n = 2$ (n must be even) $\Rightarrow \Delta x = 1 \Rightarrow |E_S| = \frac{2}{180} (1)^4(0) = 0 < 10^{-4}$
21. (a) $M = 6$ (see Exercise 7): Then $\Delta x = \frac{1}{n} \Rightarrow |E_T| \leq \frac{1}{12} \left(\frac{1}{n}\right)^2(6) = \frac{1}{2n^2} < 10^{-4} \Rightarrow n^2 > \frac{1}{2}(10^4) \Rightarrow n > \sqrt{\frac{1}{2}(10^4)}$
 $\Rightarrow n > 70.7$, so let $n = 71$
- (b) $M = 120$ (see Exercise 7): Then $\Delta x = \frac{1}{n} \Rightarrow |E_S| = \frac{1}{180} \left(\frac{1}{n}\right)^4(120) = \frac{2}{3n^4} < 10^{-4} \Rightarrow n^4 > \frac{2}{3}(10^4)$
 $\Rightarrow n > \sqrt[4]{\frac{2}{3}(10^4)} \Rightarrow n > 9.04$, so let $n = 10$ (n must be even)
22. (a) $M = 6$ (see Exercise 8): Then $\Delta x = \frac{2}{n} \Rightarrow |E_T| \leq \frac{2}{12} \left(\frac{2}{n}\right)^2(6) = \frac{4}{n^2} < 10^{-4} \Rightarrow n^2 > 4(10^4) \Rightarrow n > \sqrt{4(10^4)}$
 $\Rightarrow n > 200$, so let $n = 201$
- (b) $M = 120$ (see Exercise 8): Then $\Delta x = \frac{2}{n} \Rightarrow |E_S| \leq \frac{2}{180} \left(\frac{2}{n}\right)^4(120) = \frac{64}{3n^4} < 10^{-4} \Rightarrow n^4 > \frac{64}{3}(10^4)$
 $\Rightarrow n > \sqrt[4]{\frac{64}{3}(10^4)} \Rightarrow n > 21.5$, so let $n = 22$ (n must be even)

23. (a) $f(x) = \sqrt{x+1} \Rightarrow f'(x) = \frac{1}{2}(x+1)^{-1/2} \Rightarrow f''(x) = -\frac{1}{4}(x+1)^{-3/2} = -\frac{1}{4(\sqrt{x+1})^3} \Rightarrow M = \frac{1}{4(\sqrt{1})^3} = \frac{1}{4}$.

Then $\Delta x = \frac{3}{n} \Rightarrow |E_T| \leq \frac{3}{12} \left(\frac{3}{n}\right)^2 \left(\frac{1}{4}\right) = \frac{9}{16n^2} < 10^{-4} \Rightarrow n^2 > \frac{9}{16}(10^4) \Rightarrow n > \sqrt{\frac{9}{16}(10^4)} \Rightarrow n > 75$,
so let $n = 76$

(b) $f^{(3)}(x) = \frac{3}{8}(x+1)^{-5/2} \Rightarrow f^{(4)}(x) = -\frac{15}{16}(x+1)^{-7/2} = -\frac{15}{16(\sqrt{x+1})^7} \Rightarrow M = \frac{15}{16(\sqrt{1})^7} = \frac{15}{16}$. Then $\Delta x = \frac{3}{n}$

$\Rightarrow |E_S| \leq \frac{3}{180} \left(\frac{3}{n}\right)^4 \left(\frac{15}{16}\right) = \frac{3^5(15)}{16(180)n^4} < 10^{-4} \Rightarrow n^4 > \frac{3^5(15)(10^4)}{16(180)} \Rightarrow n > \sqrt[4]{\frac{3^5(15)(10^4)}{16(180)}} \Rightarrow n > 10.6$, so let
 $n = 12$ (n must be even)

24. (a) $f(x) = \frac{1}{\sqrt{x+1}} \Rightarrow f'(x) = -\frac{1}{2}(x+1)^{-3/2} \Rightarrow f''(x) = \frac{3}{4}(x+1)^{-5/2} = \frac{3}{4(\sqrt{x+1})^5} \Rightarrow M = \frac{3}{4(\sqrt{1})^5} = \frac{3}{4}$.

Then $\Delta x = \frac{3}{n} \Rightarrow |E_T| \leq \frac{3}{12} \left(\frac{3}{n}\right)^2 \left(\frac{3}{4}\right) = \frac{3^4}{48n^2} < 10^{-4} \Rightarrow n^2 > \frac{3^4(10^4)}{48} \Rightarrow n > \sqrt{\frac{3^4(10^4)}{48}} \Rightarrow n > 129.9$, so let
 $n = 130$

(b) $f^{(3)}(x) = -\frac{15}{8}(x+1)^{-7/2} \Rightarrow f^{(4)}(x) = \frac{105}{16}(x+1)^{-9/2} = \frac{105}{16(\sqrt{x+1})^9} \Rightarrow M = \frac{105}{16(\sqrt{1})^9} = \frac{105}{16}$. Then $\Delta x = \frac{3}{n}$

$\Rightarrow |E_S| \leq \frac{3}{180} \left(\frac{3}{n}\right)^4 \left(\frac{105}{16}\right) = \frac{3^5(105)}{16(180)n^4} < 10^{-4} \Rightarrow n^4 > \frac{3^5(105)(10^4)}{16(180)} \Rightarrow n > \sqrt[4]{\frac{3^5(105)(10^4)}{16(180)}} \Rightarrow n > 17.25$, so
let $n = 18$ (n must be even)

25. (a) $f(x) = \sin(x+1) \Rightarrow f'(x) = \cos(x+1) \Rightarrow f''(x) = -\sin(x+1) \Rightarrow M = 1$. Then $\Delta x = \frac{2}{n} \Rightarrow |E_T| \leq \frac{2}{12} \left(\frac{2}{n}\right)^2 (1) = \frac{8}{12n^2} < 10^{-4} \Rightarrow n^2 > \frac{8(10^4)}{12} \Rightarrow n > \sqrt{\frac{8(10^4)}{12}} \Rightarrow n > 81.6$, so let $n = 82$

(b) $f^{(3)}(x) = -\cos(x+1) \Rightarrow f^{(4)}(x) = \sin(x+1) \Rightarrow M = 1$. Then $\Delta x = \frac{2}{n} \Rightarrow |E_S| \leq \frac{2}{180} \left(\frac{2}{n}\right)^4 (1) = \frac{32}{180n^4} < 10^{-4} \Rightarrow n^4 > \frac{32(10^4)}{180} \Rightarrow n > \sqrt[4]{\frac{32(10^4)}{180}} \Rightarrow n > 6.49$, so let $n = 8$ (n must be even)

26. (a) $f(x) = \cos(x+\pi) \Rightarrow f'(x) = -\sin(x+\pi) \Rightarrow f''(x) = -\cos(x+\pi) \Rightarrow M = 1$. Then $\Delta x = \frac{2}{n} \Rightarrow |E_T| \leq \frac{2}{12} \left(\frac{2}{n}\right)^2 (1) = \frac{8}{12n^2} < 10^{-4} \Rightarrow n^2 > \frac{8(10^4)}{12} \Rightarrow n > \sqrt{\frac{8(10^4)}{12}} \Rightarrow n > 81.6$, so let $n = 82$

(b) $f^{(3)}(x) = \sin(x+\pi) \Rightarrow f^{(4)}(x) = \cos(x+\pi) \Rightarrow M = 1$. Then $\Delta x = \frac{2}{n} \Rightarrow |E_S| \leq \frac{2}{180} \left(\frac{2}{n}\right)^4 (1) = \frac{32}{180n^4} < 10^{-4} \Rightarrow n^4 > \frac{32(10^4)}{180} \Rightarrow n > \sqrt[4]{\frac{32(10^4)}{180}} \Rightarrow n > 6.49$, so let $n = 8$ (n must be even)

27. $\frac{5}{2}(6.0 + 2(8.2) + 2(9.1) \dots + 2(12.7) + 13.0)(30) = 15,990 \text{ ft}^3$.

28. (a) Using Trapezoid Rule, $\Delta x = 200 \Rightarrow \frac{\Delta x}{2} = \frac{200}{2} = 100$;

$\sum mf(x_i) = 13,180 \Rightarrow \text{Area} \approx 100(13,180) = 1,318,000 \text{ ft}^2$. Since the average depth = 20 ft we obtain Volume $\approx 20(\text{Area}) \approx 26,360,000 \text{ ft}^3$.

(b) Now, Number of fish = $\frac{\text{Volume}}{1000} = 26,360$ (to the nearest fish) \Rightarrow Maximum to be caught = 75% of 26,360 = 19,770 \Rightarrow Number of licenses = $\frac{19,770}{20} = 988$

	x_i	$f(x_i)$	m	$mf(x_i)$
x_0	0	0	1	0
x_1	200	520	2	1040
x_2	400	800	2	1600
x_3	600	1000	2	2000
x_4	800	1140	2	2280
x_5	1000	1160	2	2320
x_6	1200	1110	2	2220
x_7	1400	860	2	1720
x_8	1600	0	1	0

29. Use the conversion 30 mph = 44 fps (ft per sec) since time is measured in seconds. The distance traveled as the car accelerates from, say, 40 mph = 58.67 fps to 50 mph = 73.33 fps in $(4.5 - 3.2) = 1.3$ sec is the area of the trapezoid (see figure) associated with that time interval: $\frac{1}{2}(58.67 + 73.33)(1.3) = 85.8$ ft. The total distance traveled by the Ford Mustang Cobra is the sum of all these eleven trapezoids (using $\frac{\Delta t}{2}$ and the table below):

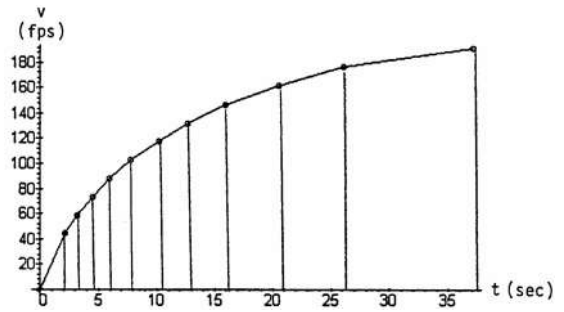

$$s = (44)(1.1) + (102.67)(0.5) + (132)(0.65) + (161.33)(0.7) + (190.67)(0.95) + (220)(1.2) + (249.33)(1.25) + (278.67)(1.65) + (308)(2.3) + (337.33)(2.8) + (366.67)(5.45) = 5166.346 \text{ ft} \approx 0.9785 \text{ mi}$$

v (mph)	0	30	40	50	60	70	80	90	100	110	120	130
v (fps)	0	44	58.67	73.33	88	102.67	117.33	132	146.67	161.33	176	190.67
t (sec)	0	2.2	3.2	4.5	5.9	7.8	10.2	12.7	16	20.6	26.2	37.1
$\Delta t/2$	0	1.1	0.5	0.65	0.7	0.95	1.2	1.25	1.65	2.3	2.8	5.45

30. Using Simpson's Rule, $\Delta x = \frac{b-a}{n} = \frac{24-0}{6} = \frac{24}{6} = 4$;
 $\sum my_i = 350 \Rightarrow S = \frac{4}{3}(350) = \frac{1400}{3} \approx 466.7 \text{ in.}^2$

	x_i	y_i	m	my_i
x_0	0	0	1	0
x_1	4	18.75	4	75
x_2	8	24	2	48
x_3	12	26	4	104
x_4	16	24	2	48
x_5	20	18.75	4	75
x_6	24	0	1	0

31. Using Simpson's Rule, $\Delta x = 1 \Rightarrow \frac{\Delta x}{3} = \frac{1}{3}$;
 $\sum my_i = 33.6 \Rightarrow$ Cross Section Area $\approx \frac{1}{3}(33.6) = 11.2 \text{ ft}^2$. Let x be the length of the tank. Then the Volume $V = (\text{Cross Sectional Area})x = 11.2x$.
 Now 5000 lb of gasoline at 42 lb/ft³
 $\Rightarrow V = \frac{5000}{42} = 119.05 \text{ ft}^3$
 $\Rightarrow 119.05 = 11.2x \Rightarrow x \approx 10.63 \text{ ft}$

	x_i	y_i	m	my_i
x_0	0	1.5	1	1.5
x_1	1	1.6	4	6.4
x_2	2	1.8	2	3.6
x_3	3	1.9	4	7.6
x_4	4	2.0	2	4.0
x_5	5	2.1	4	8.4
x_6	6	2.1	1	2.1

32. $\frac{24}{2}[0.019 + 2(0.020) + 2(0.021) + \dots + 2(0.031) + 0.035] = 4.2 \text{ L}$

33. (a) $|E_s| \leq \frac{b-a}{180} (\Delta x^4) M$; $n = 4 \Rightarrow \Delta x = \frac{\frac{\pi}{2}-0}{4} = \frac{\pi}{8}$; $|f^{(4)}| \leq 1 \Rightarrow M = 1 \Rightarrow |E_s| \leq \frac{(\frac{\pi}{2}-0)}{180} (\frac{\pi}{8})^4 (1) \approx 0.00021$

(b) $\Delta x = \frac{\pi}{8} \Rightarrow \frac{\Delta x}{3} = \frac{\pi}{24}$;
 $\sum mf(x_i) = 10.47208705$
 $\Rightarrow S = \frac{\pi}{24}(10.47208705) \approx 1.37079$

	x_i	$f(x_i)$	m	$mf(x_i)$
x_0	0	1	1	1
x_1	$\pi/8$	0.974495358	4	3.897981432
x_2	$\pi/4$	0.900316316	2	1.800632632
x_3	$3\pi/8$	0.784213303	4	3.136853212
x_4	$\pi/2$	0.636619772	1	0.636619772

(c) $\approx (\frac{0.00021}{1.37079}) \times 100 \approx 0.015\%$

34. (a) $\Delta x = \frac{b-a}{n} = \frac{1-0}{10} = 0.1 \Rightarrow \text{erf}(1) = \frac{2}{\sqrt{\pi}} (\frac{0.1}{3})(y_0 + 4y_1 + 2y_2 + 4y_3 + \dots + 4y_9 + y_{10})$
 $\frac{2}{30\sqrt{\pi}}(e^0 + 4e^{-0.01} + 2e^{-0.04} + 4e^{-0.09} + \dots + 4e^{-0.81} + e^{-1}) \approx 0.843$

(b) $|E_s| \leq \frac{1-0}{180} (0.1)^4 (12) \approx 6.7 \times 10^{-6}$

35. (a) $n = 10 \Rightarrow \Delta x = \frac{\pi-0}{10} = \frac{\pi}{10} \Rightarrow \frac{\Delta x}{2} = \frac{\pi}{20}$;
 $\sum mf(x_i) = 1(0) + 2(0.09708) + 2(0.36932) + 2(0.76248) + 2(1.19513) + 2(1.57080) + 2(1.79270)$
 $+ 2(1.77912) + 2(1.47727) + 2(0.87372) + 1(0) = 19.83524 \Rightarrow T = \frac{\pi}{20} (19.83524) = 3.11571$
 (b) $\pi - 3.11571 \approx 0.02588$
 (c) With $M = 3.11$, we get $|E_T| \leq \frac{\pi}{12} \left(\frac{\pi}{10}\right)^2 (3.11) = \frac{\pi^3}{1200} (3.11) < 0.08036$

36. (a) $f''(x) = 2 \cos x - x \sin x \Rightarrow f^{(3)}(x) = -3 \sin x - x \cos x \Rightarrow f^{(4)}(x) = -4 \cos x + x \sin x$. From the graphs shown below, $|-4 \cos x + x \sin x| < 4.8$ for $0 \leq x \leq \pi$.

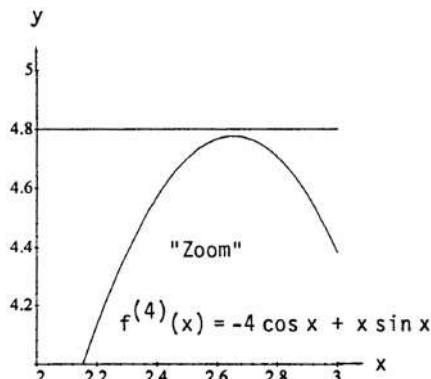
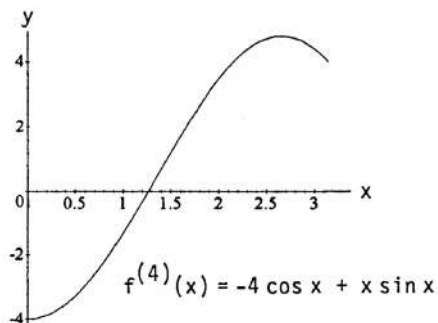

- (b) $n = 10 \Rightarrow \Delta x = \frac{\pi}{10} \Rightarrow |E_S| \leq \frac{\pi}{180} \left(\frac{\pi}{10}\right)^4 (4.8) \approx 0.00082$
 (c) $\sum mf(x_i) = 1(0) + 4(0.09708) + 2(0.36932) + 4(0.76248) + 2(1.19513) + 4(1.57080) + 2(1.79270)$
 $+ 4(1.77912) + 2(1.47727) + 4(0.87372) + 1(0) = 30.0016 \Rightarrow S = \frac{\pi}{30} (30.0016) = 3.14176$
 (d) $|\pi - 3.14176| \approx 0.00017$

37. $T = \frac{\Delta x}{2}(y_0 + 2y_1 + 2y_2 + 2y_3 + \dots + 2y_{n-1} + y_n)$ where $\Delta x = \frac{b-a}{n}$ and f is continuous on $[a, b]$. So
 $T = \frac{b-a}{n} \frac{(y_0 + y_1 + y_1 + y_2 + y_2 + \dots + y_{n-1} + y_{n-1} + y_n)}{2} = \frac{b-a}{n} \left(\frac{f(x_0) + f(x_1)}{2} + \frac{f(x_1) + f(x_2)}{2} + \dots + \frac{f(x_{n-1}) + f(x_n)}{2} \right)$.
 Since f is continuous on each interval $[x_{k-1}, x_k]$, and $\frac{f(x_{k-1}) + f(x_k)}{2}$ is always between $f(x_{k-1})$ and $f(x_k)$, there is a point c_k in $[x_{k-1}, x_k]$ with $f(c_k) = \frac{f(x_{k-1}) + f(x_k)}{2}$; this is a consequence of the Intermediate Value Theorem. Thus our sum is
 $\sum_{k=1}^n \left(\frac{b-a}{n}\right) f(c_k)$ which has the form $\sum_{k=1}^n \Delta x_k f(c_k)$ with $\Delta x_k = \frac{b-a}{n}$ for all k . This is a Riemann Sum for f on $[a, b]$.

38. $S = \frac{\Delta x}{3}(y_0 + 4y_1 + 2y_2 + 4y_3 + \dots + 2y_{n-2} + 4y_{n-1} + y_n)$ where n is even, $\Delta x = \frac{b-a}{n}$ and f is continuous on $[a, b]$. So
 $S = \frac{b-a}{n} \left(\frac{y_0 + 4y_1 + y_2}{3} + \frac{y_2 + 4y_3 + y_4}{3} + \frac{y_4 + 4y_5 + y_6}{3} + \dots + \frac{y_{n-2} + 4y_{n-1} + y_n}{3} \right)$
 $= \frac{b-a}{\frac{n}{2}} \left(\frac{f(x_0) + 4f(x_1) + f(x_2)}{6} + \frac{f(x_2) + 4f(x_3) + f(x_4)}{6} + \frac{f(x_4) + 4f(x_5) + f(x_6)}{6} + \dots + \frac{f(x_{n-2}) + 4f(x_{n-1}) + f(x_n)}{6} \right)$
 $\frac{f(x_{2k}) + 4f(x_{2k+1}) + f(x_{2k+2})}{6}$ is the average of the six values of the continuous function on the interval $[x_{2k}, x_{2k+2}]$, so it is between the minimum and maximum of f on this interval. By the Extreme Value Theorem for continuous functions, f takes on its maximum and minimum in this interval, so there are x_a and x_b with $x_{2k} \leq x_a, x_b \leq x_{2k+2}$ and
 $f(x_a) \leq \frac{f(x_{2k}) + 4f(x_{2k+1}) + f(x_{2k+2})}{6} \leq f(x_b)$. By the Intermediate Value Theorem, there is c_k in $[x_{2k}, x_{2k+2}]$ with
 $f(c_k) = \frac{f(x_{2k}) + 4f(x_{2k+1}) + f(x_{2k+2})}{6}$. So our sum has the form $\sum_{k=1}^{n/2} \Delta x_k f(c_k)$ with $\Delta x_k = \frac{b-a}{(n/2)}$, a Riemann sum for f on $[a, b]$.

Exercises 39-42 were done using a graphing calculator with $n = 50$

39. 1.08943 40. 1.37076 41. 0.82812 42. 51.05400

43. (a) $T_{10} \approx 1.983523538$
 $T_{100} \approx 1.999835504$
 $T_{1000} \approx 1.99998355$

(b)

n	$ E_T = 2 - T_n$
10	$0.016476462 = 1.6476462 \times 10^{-2}$
100	1.64496×10^{-4}
1000	1.646×10^{-6}

(c) $|E_{T_{10n}}| \approx 10^{-2} |E_{T_n}|$
 (d) $b - a = \pi, (\Delta x)^2 = \frac{\pi^2}{n^2}, M = 1$
 $|E_{T_n}| \leq \frac{\pi}{12} \left(\frac{\pi^2}{n^2}\right) = \frac{\pi^3}{12n^2}$
 $|E_{T_{10n}}| \leq \frac{\pi^3}{12(10n)^2} \leq 10^{-2} |E_{T_n}|$

44. (a) $S_{10} \approx 2.000109517$
 $S_{100} \approx 2.000000011$
 $S_{1000} \approx 2.000000000$

(b)

n	$ E_S = 2 - S_n$
10	1.09517×10^{-4}
100	1.1×10^{-8}
1000	0

(c) $|E_{S_{10n}}| \approx 10^{-4} |E_{S_n}|$
 (d) $b - a = \pi, (\Delta x)^4 = \frac{\pi^4}{n^4}, M = 1$
 $|E_{S_n}| \leq \frac{\pi}{180} \left(\frac{\pi^4}{n^4}\right) = \frac{\pi^5}{180n^4}$
 $|E_{S_{10n}}| \leq \frac{\pi^5}{180(10n)^4} \leq 10^{-4} |E_{S_n}|$

45. (a) $f'(x) = 2x \cos(x^2), f''(x) = 2x \cdot (-2x) \sin(x^2) + 2 \cos(x^2) = -4x^2 \sin(x^2) + 2 \cos(x^2)$

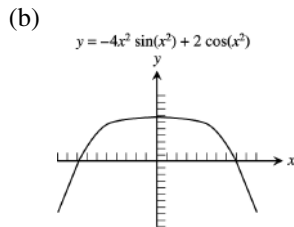

(c) The graph shows that $3 \leq f''(x) \leq 2$ so $|f''(x)| \leq 3$ for $-1 \leq x \leq 1$.

(d) $|E_T| \leq \frac{1-(-1)}{12} (\Delta x)^2 (3) = \frac{(\Delta x)^2}{2}$

(e) For $0 < \Delta x < 0.1, |E_T| \leq \frac{(\Delta x)^2}{2} \leq \frac{0.1^2}{2} = 0.005 < 0.01$

(f) $n \geq \frac{1-(-1)}{\Delta x} \geq \frac{2}{0.1} = 20$

46. (a) $f'''(x) = -4x^2 \cdot 2x \cos(x^2) - 8x \sin(x^2) - 4x \sin(x^2) = -8x^3 \cos(x^2) - 12x \sin(x^2)$

$f^{(4)}(x) = -8x^3 \cdot 2x \sin(x^2) - 24x^2 \cos(x^2) - 12x \cdot 2x \cos(x^2) - 12 \sin(x^2) = (16x^4 - 12) \sin(x^2) - 48x^2 \cos(x^2)$

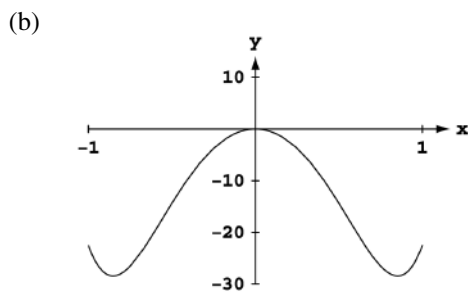

(c) The graph shows that $-30 \leq f^{(4)}(x) \leq 0$ so $|f^{(4)}(x)| \leq 30$ for $-1 \leq x \leq 1$.

(d) $|E_S| \leq \frac{1-(-1)}{180} (\Delta x)^4 (30) = \frac{(\Delta x)^4}{3}$

(e) For $0 < \Delta x < 0.4, |E_S| \leq \frac{(\Delta x)^4}{3} \leq \frac{0.4^4}{3} \approx 0.00853 < 0.01$

(f) $n \geq \frac{1-(-1)}{\Delta x} \geq \frac{2}{0.4} = 5$

47. (a) Using $d = \frac{C}{\pi}$, and $A = \pi \left(\frac{d}{2}\right)^2 = \frac{C^2}{4\pi}$ yields the following areas (in square inches, rounded to the nearest tenth):

2.3, 1.6, 1.5, 2.1, 3.2, 4.8, 7.0, 9.3, 10.7, 10.7, 9.3, 6.4, 3.2

(b) If $C(y)$ is the circumference as a function of y , then the area of a cross section is

$A(y) = \pi \left(\frac{C(y)/\pi}{2}\right)^2 = \frac{C^2(y)}{4\pi}$, and the volume is $\frac{1}{4\pi} \int_0^6 C^2(y) dy$.

(c) $\int_0^6 A(y) dy = \frac{1}{4\pi} \int_0^6 C^2(y) dy$
 $\approx \frac{1}{4\pi} \left(\frac{6-0}{24}\right) [5.4^2 + 2(4.5^2 + 4.4^2 + 5.1^2 + 6.3^2 + 7.8^2 + 9.4^2 + 10.8^2 + 11.6^2 + 11.6^2 + 10.8^2 + 9.0^2) + 6.3^2]$
 $\approx 34.7 \text{ in}^3$

(d) $V = \frac{1}{4\pi} \int_0^6 C^2(y) dy \approx \frac{1}{4\pi} \left(\frac{6-0}{36}\right) [5.4^2 + 4(4.5^2) + 2(4.4^2) + 4(5.1^2) + 2(6.3^2) + 4(7.8^2) + 2(9.4^2) + 4(10.8^2)$
 $+ 2(11.6^2) + 4(11.6^2) + 2(10.8^2) + 4(9.0^2) + 6.3^2] = 34.792 \text{ in}^3$

by Simpson's Rule. The Simpson's Rule estimate should be more accurate than the trapezoid estimate. The error in the Simpson's estimate is proportional to $(\Delta y)^4 = 0.0625$ whereas the error in the trapezoid estimate is proportional to $(\Delta y)^2 = 0.25$, a larger number when $\Delta y = 0.5 \text{ in}$.

48. (a) Displacement Volume $V \approx \frac{\Delta x}{3} (y_0 + 4y_1 + 2y_2 + 4y_3 + \dots + 2y_{n-2} + 4y_{n-1} + y_n)$, $x_0 = 0$, $x_n = 10 - \Delta x$,
 $\Delta x = 2.54$, $n = 10 \Rightarrow \int_{x_0}^{x_n} A(x) dx \approx \frac{2.54}{3} [0 + 4(1.07) + 2(3.84) + 4(7.82) + 2(12.20) + 4(15.18) + 2(16.14)$
 $+ 4(14.00) + 2(9.21) + 4(3.24) + 0] = \frac{2.54}{3} (248.02) = 209.99 \approx 210 \text{ ft}^3$.
- (b) The weight of water displaced is approximately $64 \cdot 120 = 13,440 \text{ lb}$.
- (c) The volume of a prism = $(2.54)(16.14) = 409.96 \approx 410 \text{ ft}^3$. Thus, the prismatic coefficient is $\frac{210 \text{ ft}^3}{410 \text{ ft}^3} \approx 0.51$.

49. (a) $a = 1$, $e = \frac{1}{2} \Rightarrow \text{Length} = 4 \int_0^{\pi/2} \sqrt{1 - \frac{1}{4} \cos^2 t} dt$
 $= 2 \int_0^{\pi/2} \sqrt{4 - \cos^2 t} dt = \int_0^{\pi/2} f(t) dt$; use the
 Trapezoid Rule with $n = 10 \Rightarrow \Delta t = \frac{b-a}{n} = \frac{(\frac{\pi}{2}) - 0}{10}$
 $= \frac{\pi}{20}$. $\int_0^{\pi/2} \sqrt{4 - \cos^2 t} dt \approx \sum_{n=0}^{10} mf(x_n) = 37.3686183$
 $\Rightarrow T = \frac{\Delta t}{2} (37.3686183) = \frac{\pi}{40} (37.3686183)$
 $= 2.934924419 \Rightarrow \text{Length} = 2(2.934924419)$
 ≈ 5.870

	x_i	$f(x_i)$	m	$mf(x_i)$
x_0	0	1.732050808	1	1.732050808
x_1	$\pi/20$	1.739100843	2	3.478201686
x_2	$\pi/10$	1.759400893	2	3.518801786
x_3	$3\pi/20$	1.790560631	2	3.581121262
x_4	$\pi/5$	1.82906848	1	3.658136959
x_5	$\pi/4$	1.870828693	1	3.741657387
x_6	$3\pi/10$	1.911676881	2	3.823353762
x_7	$7\pi/20$	1.947791731	2	3.895583461
x_8	$2\pi/5$	1.975982919	2	3.951965839
x_9	$9\pi/20$	1.993872679	2	3.987745357
x_{10}	$\pi/2$	2	1	2

(b) $|f''(t)| < 1 \Rightarrow M = 1$
 $\Rightarrow |E_T| \leq \frac{b-a}{12} (\Delta t^2 M) \leq \frac{(\frac{\pi}{2}) - 0}{12} \left(\frac{\pi}{20}\right)^2 1 \leq 0.0032$

50. $\Delta x = \frac{\pi-0}{8} = \frac{\pi}{8} \Rightarrow \frac{\Delta x}{3} = \frac{\pi}{24}$; $\sum mf(x_i) = 29.184807792$
 $\Rightarrow S = \frac{\pi}{24} (29.18480779) \approx 3.82028$

	x_i	$f(x_i)$	m	$mf(x_i)$
x_0	0	1.414213562	1	1.414213562
x_1	$\pi/8$	1.361452677	4	5.445810706
x_2	$\pi/4$	1.224744871	2	2.449489743
x_3	$3\pi/8$	1.070722471	4	4.282889883
x_4	$\pi/2$	1	2	2
x_5	$5\pi/8$	1.070722471	4	4.282889883
x_6	$3\pi/4$	1.224744871	2	2.449489743
x_7	$7\pi/8$	1.361452677	4	5.445810706
x_8	π	1.414213562	1	1.414213562

51. The length of the curve $y = \sin\left(\frac{3\pi}{20}x\right)$ from 0 to 20 is: $L = \int_0^{20} \sqrt{1 + \left(\frac{dy}{dx}\right)^2} dx$; $\frac{dy}{dx} = \frac{3\pi}{20} \cos\left(\frac{3\pi}{20}x\right) \Rightarrow \left(\frac{dy}{dx}\right)^2$
 $= \frac{9\pi^2}{400} \cos^2\left(\frac{3\pi}{20}x\right) \Rightarrow L = \int_0^{20} \sqrt{1 + \frac{9\pi^2}{400} \cos^2\left(\frac{3\pi}{20}x\right)} dx$. Using numerical integration we find $L \approx 21.07 \text{ in}$

52. First, we'll find the length of the cosine curve: $L = \int_{-25}^{25} \sqrt{1 + \left(\frac{dy}{dx}\right)^2} dx$; $\frac{dy}{dx} = -\frac{25\pi}{50} \sin\left(\frac{\pi x}{50}\right)$
 $\Rightarrow \left(\frac{dy}{dx}\right)^2 = \frac{\pi^2}{4} \sin^2\left(\frac{\pi x}{50}\right) \Rightarrow L = \int_{-25}^{25} \sqrt{1 + \frac{\pi^2}{4} \sin^2\left(\frac{\pi x}{50}\right)} dx$. Using a numerical integrator we find

$L \approx 73.1848$ ft. Surface area is: $A = \text{length} \cdot \text{width} \approx (73.1848)(300) = 21,955.44$ ft.

$\text{Cost} = 1.75A = (1.75)(21,955.44) = \$38,422.02$. Answers may vary slightly, depending on the numerical integration used.

$$53. y = \sin x \Rightarrow \frac{dy}{dx} = \cos x \Rightarrow \left(\frac{dy}{dx}\right)^2 = \cos^2 x \Rightarrow S = \int_0^\pi 2\pi(\sin x) \sqrt{1 + \cos^2 x} dx; \text{ a numerical integration gives } S \approx 14.4$$

$$54. y = \frac{x^2}{4} \Rightarrow \frac{dy}{dx} = \frac{x}{2} \Rightarrow \left(\frac{dy}{dx}\right)^2 = \frac{x^2}{4} \Rightarrow S = \int_0^2 2\pi \left(\frac{x^2}{4}\right) \sqrt{1 + \frac{x^2}{4}} dx; \text{ a numerical integration gives } S \approx 5.28$$

$$55. y = x + \sin 2x \Rightarrow \frac{dy}{dx} = 1 + 2 \cos 2x \Rightarrow \left(\frac{dy}{dx}\right)^2 = (1 + 2 \cos 2x)^2; \text{ by symmetry of the graph we have that } S = 2 \int_0^{2\pi/3} 2\pi(x + \sin 2x) \sqrt{1 + (1 + 2 \cos 2x)^2} dx; \text{ a numerical integration gives } S \approx 54.9$$

$$56. y = \frac{x}{12} \sqrt{36 - x^2} \Rightarrow \frac{dy}{dx} = \frac{\sqrt{36 - x^2}}{12} + \frac{x}{12} \cdot \frac{1}{2} \frac{(-2x)}{\sqrt{36 - x^2}} = \frac{\sqrt{36 - x^2}}{12} - \frac{x^2}{12\sqrt{36 - x^2}} = \frac{1}{12} \frac{(36 - x^2 - x^2)}{\sqrt{36 - x^2}} \\ = \frac{1}{12} \frac{(36 - 2x^2)}{\sqrt{36 - x^2}} = \frac{(18 - x^2)}{6\sqrt{36 - x^2}} \Rightarrow \left(\frac{dy}{dx}\right)^2 = \frac{(18 - x^2)^2}{36(36 - x^2)} \Rightarrow S = \int_0^6 \frac{2\pi \cdot x}{12} \sqrt{36 - x^2} \sqrt{1 + \frac{(18 - x^2)^2}{36(36 - x^2)}} dx \\ = \int_0^6 \frac{\pi x}{6} \sqrt{(36 - x^2) + \left(\frac{18 - x^2}{6}\right)^2} dx; \text{ using numerical integration we get } S \approx 41.8$$

57. A calculator or computer numerical integrator yields $\sin^{-1} 0.6 \approx 0.643501109$.

58. A calculator or computer numerical integrator yields $\pi \approx 3.1415929$.

8.8 IMPROPER INTEGRALS

$$1. \int_0^\infty \frac{dx}{x^2 + 1} = \lim_{b \rightarrow \infty} \int_0^b \frac{dx}{x^2 + 1} = \lim_{b \rightarrow \infty} [\tan^{-1} x]_0^b = \lim_{b \rightarrow \infty} (\tan^{-1} b - \tan^{-1} 0) = \frac{\pi}{2} - 0 = \frac{\pi}{2}$$

$$2. \int_1^\infty \frac{dx}{x^{1.001}} = \lim_{b \rightarrow \infty} \int_1^b \frac{dx}{x^{1.001}} = \lim_{b \rightarrow \infty} [-1000x^{-0.001}]_1^b = \lim_{b \rightarrow \infty} \left(\frac{-1000}{b^{0.001}} + 1000\right) = 1000$$

$$3. \int_0^1 \frac{dx}{\sqrt{x}} = \lim_{b \rightarrow 0^+} \int_b^1 x^{-1/2} dx = \lim_{b \rightarrow 0^+} [2x^{1/2}]_b^1 = \lim_{b \rightarrow 0^+} (2 - 2\sqrt{b}) = 2 - 0 = 2$$

$$4. \int_0^4 \frac{dx}{\sqrt{4-x}} = \lim_{b \rightarrow 4^-} \int_0^b (4-x)^{-1/2} dx = \lim_{b \rightarrow 4^-} \left[-2\sqrt{4-b} - (-2\sqrt{4})\right] = 0 + 4 = 4$$

$$5. \int_{-1}^1 \frac{dx}{x^{2/3}} = \int_{-1}^0 \frac{dx}{x^{2/3}} + \int_0^1 \frac{dx}{x^{2/3}} = \lim_{b \rightarrow 0^-} [3x^{1/3}]_{-1}^b + \lim_{c \rightarrow 0^+} [3x^{1/3}]_c^1 \\ = \lim_{b \rightarrow 0^-} [3b^{1/3} - 3(-1)^{1/3}] + \lim_{c \rightarrow 0^+} [3(1)^{1/3} - 3c^{1/3}] = (0 + 3) + (3 - 0) = 6$$

$$6. \int_{-8}^1 \frac{dx}{x^{1/3}} = \int_{-8}^0 \frac{dx}{x^{1/3}} + \int_0^1 \frac{dx}{x^{1/3}} = \lim_{b \rightarrow 0^-} \left[\frac{3}{2} x^{2/3}\right]_{-8}^b + \lim_{c \rightarrow 0^+} \left[\frac{3}{2} x^{2/3}\right]_c^1 \\ = \lim_{b \rightarrow 0^-} \left[\frac{3}{2} b^{2/3} - \frac{3}{2} (-8)^{2/3}\right] + \lim_{c \rightarrow 0^+} \left[\frac{3}{2} (1)^{2/3} - \frac{3}{2} c^{2/3}\right] = \left[0 - \frac{3}{2} (4)\right] + \left(\frac{3}{2} - 0\right) = -\frac{9}{2}$$

$$7. \int_0^1 \frac{dx}{\sqrt{1-x^2}} = \lim_{b \rightarrow 1^-} [\sin^{-1} x]_0^b = \lim_{b \rightarrow 1^-} (\sin^{-1} b - \sin^{-1} 0) = \frac{\pi}{2} - 0 = \frac{\pi}{2}$$

$$8. \int_0^1 \frac{dr}{r^{0.999}} = \lim_{b \rightarrow 0^+} [1000r^{0.001}]_b^1 = \lim_{b \rightarrow 0^+} (1000 - 1000b^{0.001}) = 1000 - 0 = 1000$$

9. $\int_{-\infty}^{-2} \frac{2 dx}{x^2-1} = \int_{-\infty}^{-2} \frac{dx}{x-1} - \int_{-\infty}^{-2} \frac{dx}{x+1} = \lim_{b \rightarrow -\infty} [\ln|x-1|]_b^{-2} - \lim_{b \rightarrow -\infty} [\ln|x+1|]_b^{-2} = \lim_{b \rightarrow -\infty} \left[\ln \left| \frac{x-1}{x+1} \right| \right]_b^{-2}$
 $= \lim_{b \rightarrow -\infty} (\ln \left| \frac{-3}{-1} \right| - \ln \left| \frac{b-1}{b+1} \right|) = \ln 3 - \ln \left(\lim_{b \rightarrow -\infty} \frac{b-1}{b+1} \right) = \ln 3 - \ln 1 = \ln 3$
10. $\int_{-\infty}^2 \frac{2 dx}{x^2+4} = \lim_{b \rightarrow -\infty} \left[\tan^{-1} \frac{x}{2} \right]_b^2 = \lim_{b \rightarrow -\infty} (\tan^{-1} 1 - \tan^{-1} \frac{b}{2}) = \frac{\pi}{4} - \left(-\frac{\pi}{2} \right) = \frac{3\pi}{4}$
11. $\int_2^{\infty} \frac{2 dv}{v^2-v} = \lim_{b \rightarrow \infty} \left[2 \ln \left| \frac{v-1}{v} \right| \right]_2^b = \lim_{b \rightarrow \infty} (2 \ln \left| \frac{b-1}{b} \right| - 2 \ln \left| \frac{2-1}{2} \right|) = 2 \ln(1) - 2 \ln \left(\frac{1}{2} \right) = 0 + 2 \ln 2 = \ln 4$
12. $\int_2^{\infty} \frac{2 dt}{t^2-1} = \lim_{b \rightarrow \infty} \left[\ln \left| \frac{t-1}{t+1} \right| \right]_2^b = \lim_{b \rightarrow \infty} (\ln \left| \frac{b-1}{b+1} \right| - \ln \left| \frac{2-1}{2+1} \right|) = \ln(1) - \ln \left(\frac{1}{3} \right) = 0 + \ln 3 = \ln 3$
13. $\int_{-\infty}^{\infty} \frac{2x dx}{(x^2+1)^2} = \int_{-\infty}^0 \frac{2x dx}{(x^2+1)^2} + \int_0^{\infty} \frac{2x dx}{(x^2+1)^2}; \left[\begin{array}{l} u = x^2 + 1 \\ du = 2x dx \end{array} \right] \rightarrow \int_{\infty}^1 \frac{du}{u^2} + \int_1^{\infty} \frac{du}{u^2} = \lim_{b \rightarrow \infty} \left[-\frac{1}{u} \right]_b^1 + \lim_{c \rightarrow \infty} \left[-\frac{1}{u} \right]_1^c$
 $= \lim_{b \rightarrow \infty} \left(-1 + \frac{1}{b} \right) + \lim_{c \rightarrow \infty} \left[-\frac{1}{c} - (-1) \right] = (-1 + 0) + (0 + 1) = 0$
14. $\int_{-\infty}^{\infty} \frac{x dx}{(x^2+4)^{3/2}} = \int_{-\infty}^0 \frac{x dx}{(x^2+4)^{3/2}} + \int_0^{\infty} \frac{x dx}{(x^2+4)^{3/2}}; \left[\begin{array}{l} u = x^2 + 4 \\ du = 2x dx \end{array} \right] \rightarrow \int_{\infty}^4 \frac{du}{2u^{3/2}} + \int_4^{\infty} \frac{du}{2u^{3/2}}$
 $= \lim_{b \rightarrow \infty} \left[-\frac{1}{\sqrt{u}} \right]_b^4 + \lim_{c \rightarrow \infty} \left[-\frac{1}{\sqrt{u}} \right]_4^c = \lim_{b \rightarrow \infty} \left(-\frac{1}{2} + \frac{1}{\sqrt{b}} \right) + \lim_{c \rightarrow \infty} \left(-\frac{1}{\sqrt{c}} + \frac{1}{2} \right) = \left(-\frac{1}{2} + 0 \right) + \left(0 + \frac{1}{2} \right) = 0$
15. $\int_0^1 \frac{\theta+1}{\sqrt{\theta^2+2\theta}} d\theta; \left[\begin{array}{l} u = \theta^2 + 2\theta \\ du = 2(\theta+1) d\theta \end{array} \right] \rightarrow \int_0^3 \frac{du}{2\sqrt{u}} = \lim_{b \rightarrow 0^+} \int_b^3 \frac{du}{2\sqrt{u}} = \lim_{b \rightarrow 0^+} \left[\sqrt{u} \right]_b^3 = \lim_{b \rightarrow 0^+} (\sqrt{3} - \sqrt{b})$
 $= \sqrt{3} - 0 = \sqrt{3}$
16. $\int_0^2 \frac{s+1}{\sqrt{4-s^2}} ds = \frac{1}{2} \int_0^2 \frac{2s ds}{\sqrt{4-s^2}} + \int_0^2 \frac{ds}{\sqrt{4-s^2}}; \left[\begin{array}{l} u = 4 - s^2 \\ du = -2s ds \end{array} \right] \rightarrow -\frac{1}{2} \int_4^0 \frac{du}{\sqrt{u}} + \lim_{c \rightarrow 2^-} \int_0^c \frac{ds}{\sqrt{4-s^2}}$
 $= \lim_{b \rightarrow 0^+} \int_b^4 \frac{du}{2\sqrt{u}} + \lim_{c \rightarrow 2^-} \int_0^c \frac{ds}{\sqrt{4-s^2}} = \lim_{b \rightarrow 0^+} \left[\sqrt{u} \right]_b^4 + \lim_{c \rightarrow 2^-} \left[\sin^{-1} \frac{s}{2} \right]_0^c$
 $= \lim_{b \rightarrow 0^+} (2 - \sqrt{b}) + \lim_{c \rightarrow 2^-} (\sin^{-1} \frac{c}{2} - \sin^{-1} 0) = (2 - 0) + \left(\frac{\pi}{2} - 0 \right) = \frac{4+\pi}{2}$
17. $\int_0^{\infty} \frac{dx}{(1+x)\sqrt{x}}; \left[\begin{array}{l} u = \sqrt{x} \\ du = \frac{dx}{2\sqrt{x}} \end{array} \right] \rightarrow \int_0^{\infty} \frac{2 du}{u^2+1} = \lim_{b \rightarrow \infty} \int_0^b \frac{2 du}{u^2+1} = \lim_{b \rightarrow \infty} [2 \tan^{-1} u]_0^b$
 $= \lim_{b \rightarrow \infty} (2 \tan^{-1} b - 2 \tan^{-1} 0) = 2 \left(\frac{\pi}{2} \right) - 2(0) = \pi$
18. $\int_1^{\infty} \frac{dx}{x\sqrt{x^2-1}} = \int_1^2 \frac{dx}{x\sqrt{x^2-1}} + \int_2^{\infty} \frac{dx}{x\sqrt{x^2-1}} = \lim_{b \rightarrow 1^+} \int_b^2 \frac{dx}{x\sqrt{x^2-1}} + \lim_{c \rightarrow \infty} \int_2^c \frac{dx}{x\sqrt{x^2-1}}$
 $= \lim_{b \rightarrow 1^+} [\sec^{-1} |x|]_b^2 + \lim_{c \rightarrow \infty} [\sec^{-1} |x|]_2^c = \lim_{b \rightarrow 1^+} (\sec^{-1} 2 - \sec^{-1} b) + \lim_{c \rightarrow \infty} (\sec^{-1} c - \sec^{-1} 2)$
 $= \left(\frac{\pi}{3} - 0 \right) + \left(\frac{\pi}{2} - \frac{\pi}{3} \right) = \frac{\pi}{2}$
19. $\int_0^{\infty} \frac{dv}{(1+v^2)(1+\tan^{-1}v)} = \lim_{b \rightarrow \infty} [\ln |1 + \tan^{-1} v|]_0^b = \lim_{b \rightarrow \infty} [\ln |1 + \tan^{-1} b|] - \ln |1 + \tan^{-1} 0|$
 $= \ln \left(1 + \frac{\pi}{2} \right) - \ln(1 + 0) = \ln \left(1 + \frac{\pi}{2} \right)$
20. $\int_0^{\infty} \frac{16 \tan^{-1} x}{1+x^2} dx = \lim_{b \rightarrow \infty} \left[8 (\tan^{-1} x)^2 \right]_0^b = \lim_{b \rightarrow \infty} \left[8 (\tan^{-1} b)^2 \right] - 8 (\tan^{-1} 0)^2 = 8 \left(\frac{\pi}{2} \right)^2 - 8(0) = 2\pi^2$

$$\begin{aligned}
21. \int_{-\infty}^0 \theta e^{\theta} d\theta &= \lim_{b \rightarrow -\infty} [\theta e^{\theta} - e^{\theta}]_b^0 = (0 \cdot e^0 - e^0) - \lim_{b \rightarrow -\infty} [be^b - e^b] = -1 - \lim_{b \rightarrow -\infty} \left(\frac{b-1}{e^{-b}}\right) \\
&= -1 - \lim_{b \rightarrow -\infty} \left(\frac{1}{-e^{-b}}\right) \quad (\text{L'Hôpital's rule for } \frac{\infty}{\infty} \text{ form}) \\
&= -1 - 0 = -1
\end{aligned}$$

$$\begin{aligned}
22. \int_0^{\infty} 2e^{-\theta} \sin \theta d\theta &= \lim_{b \rightarrow \infty} \int_0^b 2e^{-\theta} \sin \theta d\theta \\
&= \lim_{b \rightarrow \infty} 2 \left[\frac{e^{-\theta}}{1+1} (-\sin \theta - \cos \theta) \right]_0^b \quad (\text{FORMULA 107 with } a = -1, b = 1) \\
&= \lim_{b \rightarrow \infty} \frac{-2(\sin b + \cos b)}{2e^b} + \frac{2(\sin 0 + \cos 0)}{2e^0} = 0 + \frac{2(0+1)}{2} = 1
\end{aligned}$$

$$23. \int_{-\infty}^0 e^{-|x|} dx = \int_{-\infty}^0 e^x dx = \lim_{b \rightarrow -\infty} [e^x]_b^0 = \lim_{b \rightarrow -\infty} (1 - e^b) = (1 - 0) = 1$$

$$\begin{aligned}
24. \int_{-\infty}^{\infty} 2xe^{-x^2} dx &= \int_{-\infty}^0 2xe^{-x^2} dx + \int_0^{\infty} 2xe^{-x^2} dx = \lim_{b \rightarrow -\infty} [-e^{-x^2}]_b^0 + \lim_{c \rightarrow \infty} [-e^{-x^2}]_0^c \\
&= \lim_{b \rightarrow -\infty} [-1 - (-e^{-b^2})] + \lim_{c \rightarrow \infty} [-e^{-c^2} - (-1)] = (-1 - 0) + (0 + 1) = 0
\end{aligned}$$

$$\begin{aligned}
25. \int_0^1 x \ln x dx &= \lim_{b \rightarrow 0^+} \left[\frac{x^2}{2} \ln x - \frac{x^2}{4} \right]_b^1 = \left(\frac{1}{2} \ln 1 - \frac{1}{4} \right) - \lim_{b \rightarrow 0^+} \left(\frac{b^2}{2} \ln b - \frac{b^2}{4} \right) = -\frac{1}{4} - \lim_{b \rightarrow 0^+} \frac{\ln b}{\left(\frac{2}{b^2}\right)} + 0 \\
&= -\frac{1}{4} - \lim_{b \rightarrow 0^+} \frac{\left(\frac{1}{b}\right)}{\left(-\frac{4}{b^3}\right)} = -\frac{1}{4} + \lim_{b \rightarrow 0^+} \left(\frac{b^2}{4}\right) = -\frac{1}{4} + 0 = -\frac{1}{4}
\end{aligned}$$

$$\begin{aligned}
26. \int_0^1 (-\ln x) dx &= \lim_{b \rightarrow 0^+} [x - x \ln x]_b^1 = [1 - 1 \ln 1] - \lim_{b \rightarrow 0^+} [b - b \ln b] = 1 - 0 + \lim_{b \rightarrow 0^+} \frac{\ln b}{\left(\frac{1}{b}\right)} = 1 + \lim_{b \rightarrow 0^+} \frac{\left(\frac{1}{b}\right)}{\left(-\frac{1}{b^2}\right)} \\
&= 1 - \lim_{b \rightarrow 0^+} b = 1 - 0 = 1
\end{aligned}$$

$$27. \int_0^2 \frac{ds}{\sqrt{4-s^2}} = \lim_{b \rightarrow 2^-} \left[\sin^{-1} \frac{s}{2} \right]_0^b = \lim_{b \rightarrow 2^-} \left(\sin^{-1} \frac{b}{2} \right) - \sin^{-1} 0 = \frac{\pi}{2} - 0 = \frac{\pi}{2}$$

$$28. \int_0^1 \frac{4r dr}{\sqrt{1-r^4}} = \lim_{b \rightarrow 1^-} [2 \sin^{-1}(r^2)]_0^b = \lim_{b \rightarrow 1^-} [2 \sin^{-1}(b^2)] - 2 \sin^{-1} 0 = 2 \cdot \frac{\pi}{2} - 0 = \pi$$

$$29. \int_1^2 \frac{ds}{s\sqrt{s^2-1}} = \lim_{b \rightarrow 1^+} [\sec^{-1} s]_b^2 = \sec^{-1} 2 - \lim_{b \rightarrow 1^+} \sec^{-1} b = \frac{\pi}{3} - 0 = \frac{\pi}{3}$$

$$30. \int_2^4 \frac{dt}{t\sqrt{t^2-4}} = \lim_{b \rightarrow 2^+} \left[\frac{1}{2} \sec^{-1} \frac{t}{2} \right]_b^4 = \lim_{b \rightarrow 2^+} \left[\left(\frac{1}{2} \sec^{-1} \frac{4}{2} \right) - \frac{1}{2} \sec^{-1} \left(\frac{b}{2} \right) \right] = \frac{1}{2} \left(\frac{\pi}{3} \right) - \frac{1}{2} \cdot 0 = \frac{\pi}{6}$$

$$\begin{aligned}
31. \int_{-1}^4 \frac{dx}{\sqrt{|x|}} &= \lim_{b \rightarrow 0^-} \int_{-1}^b \frac{dx}{\sqrt{-x}} + \lim_{c \rightarrow 0^+} \int_c^4 \frac{dx}{\sqrt{x}} = \lim_{b \rightarrow 0^-} [-2\sqrt{-x}]_{-1}^b + \lim_{c \rightarrow 0^+} [2\sqrt{x}]_c^4 \\
&= \lim_{b \rightarrow 0^-} \left(-2\sqrt{-b} \right) - \left(-2\sqrt{-(-1)} \right) + 2\sqrt{4} - \lim_{c \rightarrow 0^+} 2\sqrt{c} = 0 + 2 + 2 \cdot 2 - 0 = 6
\end{aligned}$$

$$\begin{aligned}
32. \int_0^2 \frac{dx}{\sqrt{|x-1|}} &= \int_0^1 \frac{dx}{\sqrt{1-x}} + \int_1^2 \frac{dx}{\sqrt{x-1}} = \lim_{b \rightarrow 1^-} [-2\sqrt{1-x}]_0^b + \lim_{c \rightarrow 1^+} [2\sqrt{x-1}]_c^2 \\
&= \lim_{b \rightarrow 1^-} \left(-2\sqrt{1-b} \right) - \left(-2\sqrt{1-0} \right) + 2\sqrt{2-1} - \lim_{c \rightarrow 1^+} \left(2\sqrt{c-1} \right) = 0 + 2 + 2 - 0 = 4
\end{aligned}$$

$$33. \int_{-1}^{\infty} \frac{d\theta}{\theta^2 + 5\theta + 6} = \lim_{b \rightarrow \infty} \left[\ln \left| \frac{\theta+2}{\theta+3} \right| \right]_{-1}^b = \lim_{b \rightarrow \infty} \left[\ln \left| \frac{b+2}{b+3} \right| \right] - \ln \left| \frac{-1+2}{-1+3} \right| = 0 - \ln \left(\frac{1}{2} \right) = \ln 2$$

$$34. \int_0^{\infty} \frac{dx}{(x+1)(x^2+1)} = \lim_{b \rightarrow \infty} \left[\frac{1}{2} \ln |x+1| - \frac{1}{4} \ln(x^2+1) + \frac{1}{2} \tan^{-1} x \right]_0^b = \lim_{b \rightarrow \infty} \left[\frac{1}{2} \ln \left(\frac{x+1}{\sqrt{x^2+1}} \right) + \frac{1}{2} \tan^{-1} x \right]_0^b$$

$$= \lim_{b \rightarrow \infty} \left[\frac{1}{2} \ln \left(\frac{b+1}{\sqrt{b^2+1}} \right) + \frac{1}{2} \tan^{-1} b \right] - \left[\frac{1}{2} \ln \frac{1}{\sqrt{1}} + \frac{1}{2} \tan^{-1} 0 \right] = \frac{1}{2} \ln 1 + \frac{1}{2} \cdot \frac{\pi}{2} - \frac{1}{2} \ln 1 - \frac{1}{2} \cdot 0 = \frac{\pi}{4}$$

$$35. \int_0^{\pi/2} \tan \theta \, d\theta = \lim_{b \rightarrow \frac{\pi}{2}^-} [-\ln |\cos \theta|]_0^b = \lim_{b \rightarrow \frac{\pi}{2}^-} [-\ln |\cos b|] + \ln 1 = \lim_{b \rightarrow \frac{\pi}{2}^-} [-\ln |\cos b|] = +\infty,$$

the integral diverges

$$36. \int_0^{\pi/2} \cot \theta \, d\theta = \lim_{b \rightarrow 0^+} [\ln |\sin \theta|]_b^{\pi/2} = \ln 1 - \lim_{b \rightarrow 0^+} [\ln |\sin b|] = - \lim_{b \rightarrow 0^+} [\ln |\sin b|] = +\infty,$$

the integral diverges

$$37. \int_0^{\pi} \frac{\sin \theta \, d\theta}{\sqrt{\pi - \theta}}; [\pi - \theta = x] \rightarrow -\int_{\pi}^0 \frac{\sin x \, dx}{\sqrt{x}} = \int_0^{\pi} \frac{\sin x \, dx}{\sqrt{x}}. \text{ Since } 0 \leq \frac{\sin x}{\sqrt{x}} \leq \frac{1}{\sqrt{x}} \text{ for all } 0 \leq x \leq \pi \text{ and } \int_0^{\pi} \frac{dx}{\sqrt{x}}$$

converges, then $\int_0^{\pi} \frac{\sin x}{\sqrt{x}} \, dx$ converges by the Direct Comparison Test.

$$38. \int_{-\pi/2}^{\pi/2} \frac{\cos \theta \, d\theta}{(\pi - 2\theta)^{1/3}}; \begin{cases} x = \pi - 2\theta \\ \theta = \frac{\pi}{2} - \frac{x}{2} \\ d\theta = -\frac{dx}{2} \end{cases} \rightarrow \int_{2\pi}^0 \frac{-\cos(\frac{\pi}{2} - \frac{x}{2}) \, dx}{2x^{1/3}} = \int_0^{2\pi} \frac{\sin(\frac{x}{2}) \, dx}{2x^{1/3}}. \text{ Since } 0 \leq \frac{\sin \frac{x}{2}}{2x^{1/3}} \leq \frac{1}{2x^{1/3}} \text{ for all}$$

$$0 \leq x \leq 2\pi \text{ and } \int_0^{2\pi} \frac{dx}{2x^{1/3}} \text{ converges, then } \int_0^{2\pi} \frac{\sin \frac{x}{2}}{2x^{1/3}} \, dx \text{ converges by the Direct Comparison Test.}$$

$$39. \int_0^{\ln 2} x^{-2} e^{-1/x} \, dx; [\frac{1}{x} = y] \rightarrow \int_{\infty}^{1/\ln 2} \frac{y^2 e^{-y} \, dy}{-y^2} = \int_{1/\ln 2}^{\infty} e^{-y} \, dy = \lim_{b \rightarrow \infty} [-e^{-y}]_{1/\ln 2}^b = \lim_{b \rightarrow \infty} [-e^{-b}] - [-e^{-1/\ln 2}]$$

$$= 0 + e^{-1/\ln 2} = e^{-1/\ln 2}, \text{ so the integral converges.}$$

$$40. \int_0^1 \frac{e^{-\sqrt{x}}}{\sqrt{x}} \, dx; [y = \sqrt{x}] \rightarrow 2 \int_0^1 e^{-y} \, dy = 2 - \frac{2}{e}, \text{ so the integral converges.}$$

$$41. \int_0^{\pi} \frac{dt}{\sqrt{t + \sin t}}. \text{ Since for } 0 \leq t \leq \pi, 0 \leq \frac{1}{\sqrt{t + \sin t}} \leq \frac{1}{\sqrt{t}} \text{ and } \int_0^{\pi} \frac{dt}{\sqrt{t}} \text{ converges, then the original integral}$$

converges as well by the Direct Comparison Test.

$$42. \int_0^1 \frac{dt}{t - \sin t}; \text{ let } f(t) = \frac{1}{t - \sin t} \text{ and } g(t) = \frac{1}{t^3}, \text{ then } \lim_{t \rightarrow 0} \frac{f(t)}{g(t)} = \lim_{t \rightarrow 0} \frac{t^3}{t - \sin t} = \lim_{t \rightarrow 0} \frac{3t^2}{1 - \cos t} = \lim_{t \rightarrow 0} \frac{6t}{\sin t}$$

$$= \lim_{t \rightarrow 0} \frac{6}{\cos t} = 6. \text{ Now, } \int_0^1 \frac{dt}{t^3} = \lim_{b \rightarrow 0^+} \left[-\frac{1}{2t^2} \right]_b^1 = -\frac{1}{2} - \lim_{b \rightarrow 0^+} \left[-\frac{1}{2b^2} \right] = +\infty, \text{ which diverges } \Rightarrow \int_0^1 \frac{dt}{t - \sin t}$$

diverges by the Limit Comparison Test.

$$43. \int_0^2 \frac{dx}{1-x^2} = \int_0^1 \frac{dx}{1-x^2} + \int_1^2 \frac{dx}{1-x^2} \text{ and } \int_0^1 \frac{dx}{1-x^2} = \lim_{b \rightarrow 1^-} \left[\frac{1}{2} \ln \left| \frac{1+x}{1-x} \right| \right]_0^b = \lim_{b \rightarrow 1^-} \left[\frac{1}{2} \ln \left| \frac{1+b}{1-b} \right| \right] - 0 = \infty, \text{ which}$$

diverges $\Rightarrow \int_0^2 \frac{dx}{1-x^2}$ diverges as well.

$$44. \int_0^2 \frac{dx}{1-x} = \int_0^1 \frac{dx}{1-x} + \int_1^2 \frac{dx}{1-x} \text{ and } \int_0^1 \frac{dx}{1-x} = \lim_{b \rightarrow 1^-} [-\ln(1-x)]_0^b = \lim_{b \rightarrow 1^-} [-\ln(1-b)] - 0 = \infty, \text{ which}$$

diverges $\Rightarrow \int_0^2 \frac{dx}{1-x}$ diverges as well.

$$45. \int_{-1}^1 \ln |x| \, dx = \int_{-1}^0 \ln(-x) \, dx + \int_0^1 \ln x \, dx; \int_0^1 \ln x \, dx = \lim_{b \rightarrow 0^+} [x \ln x - x]_b^1 = [1 \cdot 0 - 1] - \lim_{b \rightarrow 0^+} [b \ln b - b]$$

$$= -1 - 0 = -1; \int_{-1}^0 \ln(-x) \, dx = -1 \Rightarrow \int_{-1}^1 \ln |x| \, dx = -2 \text{ converges.}$$

$$46. \int_{-1}^1 (-x \ln |x|) dx = \int_{-1}^0 [-x \ln(-x)] dx + \int_0^1 (-x \ln x) dx = \lim_{b \rightarrow 0^+} \left[\frac{x^2}{2} \ln x - \frac{x^2}{4} \right]_b^1 - \lim_{c \rightarrow 0^+} \left[\frac{x^2}{2} \ln x - \frac{x^2}{4} \right]_c^1$$

$$= \left[\frac{1}{2} \ln 1 - \frac{1}{4} \right] - \lim_{b \rightarrow 0^+} \left[\frac{b^2}{2} \ln b - \frac{b^2}{4} \right] - \left[\frac{1}{2} \ln 1 - \frac{1}{4} \right] + \lim_{c \rightarrow 0^+} \left[\frac{c^2}{2} \ln c - \frac{c^2}{4} \right] = -\frac{1}{4} - 0 + \frac{1}{4} + 0 = 0 \Rightarrow \text{the integral converges (see Exercise 25 for the limit calculations).}$$

$$47. \int_1^\infty \frac{dx}{1+x^3}; 0 \leq \frac{1}{x^3+1} \leq \frac{1}{x^3} \text{ for } 1 \leq x < \infty \text{ and } \int_1^\infty \frac{dx}{x^3} \text{ converges } \Rightarrow \int_1^\infty \frac{dx}{1+x^3} \text{ converges by the Direct Comparison Test.}$$

$$48. \int_4^\infty \frac{dx}{\sqrt{x-1}}; \lim_{x \rightarrow \infty} \frac{\left(\frac{1}{\sqrt{x-1}}\right)}{\left(\frac{1}{\sqrt{x}}\right)} = \lim_{x \rightarrow \infty} \frac{\sqrt{x}}{\sqrt{x-1}} = \lim_{x \rightarrow \infty} \frac{1}{1-\frac{1}{\sqrt{x}}} = \frac{1}{1-0} = 1 \text{ and } \int_4^\infty \frac{dx}{\sqrt{x}} = \lim_{b \rightarrow \infty} [2\sqrt{x}]_4^b = \infty,$$

which diverges $\Rightarrow \int_4^\infty \frac{dx}{\sqrt{x-1}}$ diverges by the Limit Comparison Test.

$$49. \int_2^\infty \frac{dv}{\sqrt{v-1}}; \lim_{v \rightarrow \infty} \frac{\left(\frac{1}{\sqrt{v-1}}\right)}{\left(\frac{1}{\sqrt{v}}\right)} = \lim_{v \rightarrow \infty} \frac{\sqrt{v}}{\sqrt{v-1}} = \lim_{v \rightarrow \infty} \frac{1}{\sqrt{1-\frac{1}{v}}} = \frac{1}{\sqrt{1-0}} = 1 \text{ and } \int_2^\infty \frac{dv}{\sqrt{v}} = \lim_{b \rightarrow \infty} [2\sqrt{v}]_2^b = \infty,$$

which diverges $\Rightarrow \int_2^\infty \frac{dv}{\sqrt{v-1}}$ diverges by the Limit Comparison Test.

$$50. \int_0^\infty \frac{d\theta}{1+e^\theta}; 0 \leq \frac{1}{1+e^\theta} \leq \frac{1}{e^\theta} \text{ for } 0 \leq \theta < \infty \text{ and } \int_0^\infty \frac{d\theta}{e^\theta} = \lim_{b \rightarrow \infty} [-e^{-\theta}]_0^b = \lim_{b \rightarrow \infty} (-e^{-b} + 1) = 1$$

$\Rightarrow \int_0^\infty \frac{d\theta}{1+e^\theta}$ converges $\Rightarrow \int_0^\infty \frac{d\theta}{1+e^\theta}$ converges by the Direct Comparison Test.

$$51. \int_0^\infty \frac{dx}{\sqrt{x^6+1}} = \int_0^1 \frac{dx}{\sqrt{x^6+1}} + \int_1^\infty \frac{dx}{\sqrt{x^6+1}} < \int_0^1 \frac{dx}{\sqrt{x^6+1}} + \int_1^\infty \frac{dx}{x^3} \text{ and } \int_1^\infty \frac{dx}{x^3} = \lim_{b \rightarrow \infty} \left[-\frac{1}{2x^2}\right]_1^b$$

$$= \lim_{b \rightarrow \infty} \left(-\frac{1}{2b^2} + \frac{1}{2}\right) = \frac{1}{2} \Rightarrow \int_0^\infty \frac{dx}{\sqrt{x^6+1}} \text{ converges by the Direct Comparison Test.}$$

$$52. \int_2^\infty \frac{dx}{\sqrt{x^2-1}}; \lim_{x \rightarrow \infty} \frac{\left(\frac{1}{\sqrt{x^2-1}}\right)}{\left(\frac{1}{x}\right)} = \lim_{x \rightarrow \infty} \frac{x}{\sqrt{x^2-1}} = \lim_{x \rightarrow \infty} \frac{1}{\sqrt{1-\frac{1}{x^2}}} = 1; \int_2^\infty \frac{1}{x} dx = \lim_{b \rightarrow \infty} [\ln b]_2^b = \infty,$$

which diverges $\Rightarrow \int_2^\infty \frac{dx}{\sqrt{x^2-1}}$ diverges by the Limit Comparison Test.

$$53. \int_1^\infty \frac{\sqrt{x+1}}{x^2} dx; \lim_{x \rightarrow \infty} \frac{\left(\frac{\sqrt{x}}{x^2}\right)}{\left(\frac{\sqrt{x}}{x^2}\right)} = \lim_{x \rightarrow \infty} \frac{\sqrt{x}}{\sqrt{x+1}} = \lim_{x \rightarrow \infty} \frac{1}{\sqrt{1+\frac{1}{x}}} = 1; \int_1^\infty \frac{\sqrt{x}}{x^2} dx = \int_1^\infty \frac{dx}{x^{3/2}}$$

$$= \lim_{b \rightarrow \infty} [-2x^{-1/2}]_1^b = \lim_{b \rightarrow \infty} \left(\frac{-2}{\sqrt{b}} + 2\right) = 2 \Rightarrow \int_1^\infty \frac{\sqrt{x+1}}{x^2} dx \text{ converges by the Limit Comparison Test.}$$

$$54. \int_2^\infty \frac{x dx}{\sqrt{x^4-1}}; \lim_{x \rightarrow \infty} \frac{\left(\frac{x}{\sqrt{x^4-1}}\right)}{\left(\frac{x}{\sqrt{x^4}}\right)} = \lim_{x \rightarrow \infty} \frac{\sqrt{x^4}}{\sqrt{x^4-1}} = \lim_{x \rightarrow \infty} \frac{1}{\sqrt{1-\frac{1}{x^4}}} = 1; \int_2^\infty \frac{x dx}{\sqrt{x^4}} = \int_2^\infty \frac{dx}{x} = \lim_{b \rightarrow \infty} [\ln x]_2^b = \infty,$$

which diverges $\Rightarrow \int_2^\infty \frac{x dx}{\sqrt{x^4-1}}$ diverges by the Limit Comparison Test.

$$55. \int_\pi^\infty \frac{2+\cos x}{x} dx; 0 < \frac{1}{x} \leq \frac{2+\cos x}{x} \text{ for } x \geq \pi \text{ and } \int_\pi^\infty \frac{dx}{x} = \lim_{b \rightarrow \infty} [\ln x]_\pi^b = \infty, \text{ which diverges}$$

$\Rightarrow \int_\pi^\infty \frac{2+\cos x}{x} dx$ diverges by the Direct Comparison Test.

$$56. \int_\pi^\infty \frac{1+\sin x}{x^2} dx; 0 \leq \frac{1+\sin x}{x^2} \leq \frac{2}{x^2} \text{ for } x \geq \pi \text{ and } \int_\pi^\infty \frac{2}{x^2} dx = \lim_{b \rightarrow \infty} \left[-\frac{2}{x}\right]_\pi^b = \lim_{b \rightarrow \infty} \left(-\frac{2}{b} + \frac{2}{\pi}\right) = \frac{2}{\pi}$$

$\Rightarrow \int_\pi^\infty \frac{2}{x^2} dx$ converges $\Rightarrow \int_\pi^\infty \frac{1+\sin x}{x^2} dx$ converges by the Direct Comparison Test.

$$57. \int_4^{\infty} \frac{2 \, dt}{t^{3/2}-1}; \lim_{t \rightarrow \infty} \frac{t^{3/2}}{t^{3/2}-1} = 1 \text{ and } \int_4^{\infty} \frac{2 \, dt}{t^{3/2}} = \lim_{b \rightarrow \infty} [-4t^{-1/2}]_4^b = \lim_{b \rightarrow \infty} \left(\frac{-4}{\sqrt{b}} + 2 \right) = 2 \Rightarrow \int_4^{\infty} \frac{2 \, dt}{t^{3/2}} \text{ converges} \\ \Rightarrow \int_4^{\infty} \frac{2 \, dt}{t^{3/2}-1} \text{ converges by the Limit Comparison Test.}$$

$$58. \int_2^{\infty} \frac{dx}{\ln x}; 0 < \frac{1}{x} < \frac{1}{\ln x} \text{ for } x > 2 \text{ and } \int_2^{\infty} \frac{dx}{x} \text{ diverges} \Rightarrow \int_2^{\infty} \frac{dx}{\ln x} \text{ diverges by the Direct Comparison Test.}$$

$$59. \int_1^{\infty} \frac{e^x}{x} \, dx; 0 < \frac{1}{x} < \frac{e^x}{x} \text{ for } x > 1 \text{ and } \int_1^{\infty} \frac{dx}{x} \text{ diverges} \Rightarrow \int_1^{\infty} \frac{e^x}{x} \, dx \text{ diverges by the Direct Comparison Test.}$$

$$60. \int_e^{\infty} \ln(\ln x) \, dx; [x = e^y] \rightarrow \int_e^{\infty} (\ln y) e^y \, dy; 0 < \ln y < (\ln y) e^y \text{ for } y \geq e \text{ and } \int_e^{\infty} \ln y \, dy = \lim_{b \rightarrow \infty} [y \ln y - y]_e^b \\ = \infty, \text{ which diverges} \Rightarrow \int_e^{\infty} \ln e^y \, dy \text{ diverges} \Rightarrow \int_e^{\infty} \ln(\ln x) \, dx \text{ diverges by the Direct Comparison Test.}$$

$$61. \int_1^{\infty} \frac{dx}{\sqrt{e^x-x}}; x \lim_{x \rightarrow \infty} \frac{\left(\frac{1}{\sqrt{e^x-x}} \right)}{\left(\frac{1}{\sqrt{e^x}} \right)} = x \lim_{x \rightarrow \infty} \frac{\sqrt{e^x}}{\sqrt{e^x-x}} = x \lim_{x \rightarrow \infty} \frac{1}{\sqrt{1-\frac{x}{e^x}}} = \frac{1}{\sqrt{1-0}} = 1; \int_1^{\infty} \frac{dx}{\sqrt{e^x}} = \int_1^{\infty} e^{-x/2} \, dx \\ = \lim_{b \rightarrow \infty} [-2e^{-x/2}]_1^b = \lim_{b \rightarrow \infty} (-2e^{-b/2} + 2e^{-1/2}) = \frac{2}{\sqrt{e}} \Rightarrow \int_1^{\infty} e^{-x/2} \, dx \text{ converges} \Rightarrow \int_1^{\infty} \frac{dx}{\sqrt{e^x-x}} \text{ converges} \\ \text{by the Limit Comparison Test.}$$

$$62. \int_1^{\infty} \frac{dx}{e^x-2^x}; x \lim_{x \rightarrow \infty} \frac{\left(\frac{1}{e^x-2^x} \right)}{\left(\frac{1}{e^x} \right)} = x \lim_{x \rightarrow \infty} \frac{e^x}{e^x-2^x} = x \lim_{x \rightarrow \infty} \frac{1}{1-\left(\frac{2}{e}\right)^x} = \frac{1}{1-0} = 1 \text{ and } \int_1^{\infty} \frac{dx}{e^x} = \lim_{b \rightarrow \infty} [-e^{-x}]_1^b \\ = \lim_{b \rightarrow \infty} (-e^{-b} + e^{-1}) = \frac{1}{e} \Rightarrow \int_1^{\infty} \frac{dx}{e^x} \text{ converges} \Rightarrow \int_1^{\infty} \frac{dx}{e^x-2^x} \text{ converges by the Limit Comparison Test.}$$

$$63. \int_{-\infty}^{\infty} \frac{dx}{\sqrt{x^2+1}} = 2 \int_0^{\infty} \frac{dx}{\sqrt{x^2+1}}; \int_0^{\infty} \frac{dx}{\sqrt{x^2+1}} = \int_0^1 \frac{dx}{\sqrt{x^2+1}} + \int_1^{\infty} \frac{dx}{\sqrt{x^2+1}} < \int_0^1 \frac{dx}{\sqrt{x^2+1}} + \int_1^{\infty} \frac{dx}{x^2} \text{ and} \\ \int_1^{\infty} \frac{dx}{x^2} = \lim_{b \rightarrow \infty} \left[-\frac{1}{x} \right]_1^b = \lim_{b \rightarrow \infty} \left(-\frac{1}{b} + 1 \right) = 1 \Rightarrow \int_{-\infty}^{\infty} \frac{dx}{\sqrt{x^2+1}} \text{ converges by the Direct Comparison Test.}$$

$$64. \int_{-\infty}^{\infty} \frac{dx}{e^x+e^{-x}} = 2 \int_0^{\infty} \frac{dx}{e^x+e^{-x}}; 0 < \frac{1}{e^x+e^{-x}} < \frac{1}{e^x} \text{ for } x > 0; \int_0^{\infty} \frac{dx}{e^x} \text{ converges} \Rightarrow 2 \int_0^{\infty} \frac{dx}{e^x+e^{-x}} \text{ converges by the} \\ \text{Direct Comparison Test.}$$

$$65. \text{(a) } \int_1^2 \frac{dx}{x(\ln x)^p}; [t = \ln x] \rightarrow \int_0^{\ln 2} \frac{dt}{t^p} = \lim_{b \rightarrow 0^+} \left[\frac{1}{-p+1} t^{1-p} \right]_b^{\ln 2} = \lim_{b \rightarrow 0^+} \frac{b^{1-p}}{p-1} + \frac{1}{1-p} (\ln 2)^{1-p} \\ \Rightarrow \text{the integral converges for } p < 1 \text{ and diverges for } p \geq 1$$

$$\text{(b) } \int_2^{\infty} \frac{dx}{x(\ln x)^p}; [t = \ln x] \rightarrow \int_{\ln 2}^{\infty} \frac{dt}{t^p} \text{ and this integral is essentially the same as in Exercise 65(a): it converges} \\ \text{for } p > 1 \text{ and diverges for } p \leq 1$$

$$66. \int_0^{\infty} \frac{2x \, dx}{x^2+1} = \lim_{b \rightarrow \infty} [\ln(x^2+1)]_0^b = \lim_{b \rightarrow \infty} [\ln(b^2+1)] - 0 = \lim_{b \rightarrow \infty} \ln(b^2+1) = \infty \Rightarrow \text{the integral } \int_{-\infty}^{\infty} \frac{2x}{x^2+1} \, dx \\ \text{diverges. But } \lim_{b \rightarrow \infty} \int_{-b}^b \frac{2x \, dx}{x^2+1} = \lim_{b \rightarrow \infty} [\ln(x^2+1)]_{-b}^b = \lim_{b \rightarrow \infty} [\ln(b^2+1) - \ln(b^2+1)] = \lim_{b \rightarrow \infty} \ln \left(\frac{b^2+1}{b^2+1} \right) \\ = \lim_{b \rightarrow \infty} (\ln 1) = 0$$

$$67. A = \int_0^{\infty} e^{-x} \, dx = \lim_{b \rightarrow \infty} [-e^{-x}]_0^b = \lim_{b \rightarrow \infty} (-e^{-b}) - (-e^{-0}) \\ = 0 + 1 = 1$$

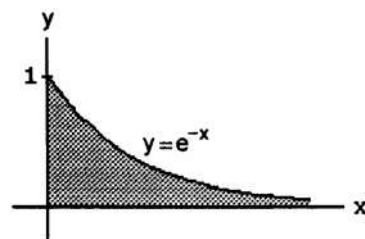

$$68. \bar{x} = \frac{1}{A} \int_0^{\infty} x e^{-x} dx = \lim_b \lim_{b \rightarrow \infty} [-x e^{-x} - e^{-x}]_0^b = \lim_b \lim_{b \rightarrow \infty} (-b e^{-b} - e^{-b}) - (-0 \cdot e^{-0} - e^{-0}) = 0 + 1 = 1;$$

$$\bar{y} = \frac{1}{2A} \int_0^{\infty} (e^{-x})^2 dx = \frac{1}{2} \int_0^{\infty} e^{-2x} dx = \lim_b \lim_{b \rightarrow \infty} \frac{1}{2} [-\frac{1}{2} e^{-2x}]_0^b = \lim_b \lim_{b \rightarrow \infty} \frac{1}{2} (-\frac{1}{2} e^{-2b}) - \frac{1}{2} (-\frac{1}{2} e^{-2 \cdot 0}) = 0 + \frac{1}{4} = \frac{1}{4}$$

$$69. V = \int_0^{\infty} 2\pi x e^{-x} dx = 2\pi \int_0^{\infty} x e^{-x} dx = 2\pi \lim_b \lim_{b \rightarrow \infty} [-x e^{-x} - e^{-x}]_0^b = 2\pi \left[\lim_b \lim_{b \rightarrow \infty} (-b e^{-b} - e^{-b}) - 1 \right] = 2\pi$$

$$70. V = \int_0^{\infty} \pi (e^{-x})^2 dx = \pi \int_0^{\infty} e^{-2x} dx = \pi \lim_b \lim_{b \rightarrow \infty} [-\frac{1}{2} e^{-2x}]_0^b = \pi \lim_b \lim_{b \rightarrow \infty} (-\frac{1}{2} e^{-2b} + \frac{1}{2}) = \frac{\pi}{2}$$

$$71. A = \int_0^{\pi/2} (\sec x - \tan x) dx = \lim_b \lim_{b \rightarrow \frac{\pi}{2}^-} [\ln |\sec x + \tan x| - \ln |\sec x|]_0^b = \lim_b \lim_{b \rightarrow \frac{\pi}{2}^-} (\ln |1 + \frac{\tan b}{\sec b}| - \ln |1 + 0|)$$

$$= \lim_b \lim_{b \rightarrow \frac{\pi}{2}^-} \ln |1 + \sin b| = \ln 2$$

$$72. (a) V = \int_0^{\pi/2} \pi \sec^2 x dx - \int_0^{\pi/2} \pi \tan^2 x dx = \pi \int_0^{\pi/2} (\sec^2 x - \tan^2 x) dx = \int_0^{\pi/2} \pi [\sec^2 x - (\sec^2 x - 1)] dx$$

$$= \pi \int_0^{\pi/2} dx = \frac{\pi^2}{2}$$

$$(b) S_{\text{outer}} = \int_0^{\pi/2} 2\pi \sec x \sqrt{1 + \sec^2 x \tan^2 x} dx \geq \int_0^{\pi/2} 2\pi \sec x (\sec x \tan x) dx = \pi \lim_b \lim_{b \rightarrow \frac{\pi}{2}^-} [\tan^2 x]_0^b$$

$$= \pi \left[\lim_b \lim_{b \rightarrow \frac{\pi}{2}^-} [\tan^2 b] - 0 \right] = \pi \lim_b \lim_{b \rightarrow \frac{\pi}{2}^-} (\tan^2 b) = \infty \Rightarrow S_{\text{outer}} \text{ diverges}; S_{\text{inner}} = \int_0^{\pi/2} 2\pi \tan x \sqrt{1 + \sec^4 x} dx$$

$$\geq \int_0^{\pi/2} 2\pi \tan x \sec^2 x dx = \pi \lim_b \lim_{b \rightarrow \frac{\pi}{2}^-} [\tan^2 x]_0^b = \pi \left[\lim_b \lim_{b \rightarrow \frac{\pi}{2}^-} [\tan^2 b] - 0 \right] = \pi \lim_b \lim_{b \rightarrow \frac{\pi}{2}^-} (\tan^2 b) = \infty$$

$$\Rightarrow S_{\text{inner}} \text{ diverges}$$

$$73. (a) \int_3^{\infty} e^{-3x} dx = \lim_b \lim_{b \rightarrow \infty} [-\frac{1}{3} e^{-3x}]_3^b = \lim_b \lim_{b \rightarrow \infty} (-\frac{1}{3} e^{-3b}) - (-\frac{1}{3} e^{-3 \cdot 3}) = 0 + \frac{1}{3} \cdot e^{-9} = \frac{1}{3} e^{-9}$$

$$\approx 0.0000411 < 0.000042. \text{ Since } e^{-x^2} \leq e^{-3x} \text{ for } x > 3, \text{ then } \int_3^{\infty} e^{-x^2} dx < 0.000042 \text{ and therefore}$$

$$\int_0^{\infty} e^{-x^2} dx \text{ can be replaced by } \int_0^3 e^{-x^2} dx \text{ without introducing an error greater than } 0.000042.$$

$$(b) \int_0^3 e^{-x^2} dx \approx 0.88621$$

$$74. (a) V = \int_1^{\infty} \pi \left(\frac{1}{x}\right)^2 dx = \pi \lim_b \lim_{b \rightarrow \infty} [-\frac{1}{x}]_1^b = \pi \left[\lim_b \lim_{b \rightarrow \infty} (-\frac{1}{b}) - (-\frac{1}{1}) \right] = \pi(0 + 1) = \pi$$

(b) When you take the limit to ∞ , you are no longer modeling the real world which is finite. The comparison step in the modeling process discussed in Section 4.2 relating the mathematical world to the real world fails to hold.

75. (a)

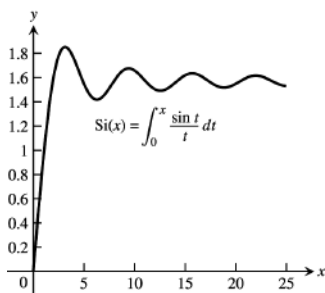

(b) `> int((sin(t))/t, t=0..infinity);` (answer is $\frac{\pi}{2}$)

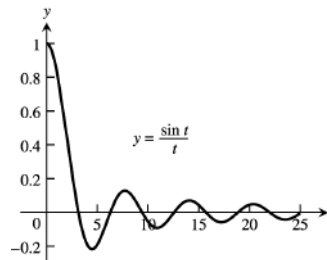

76. (a)

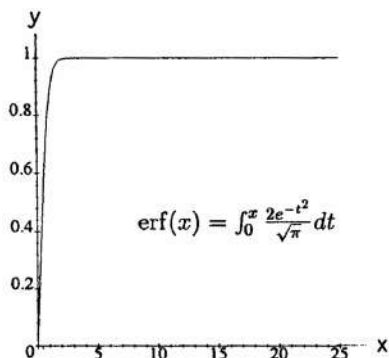

(b) `> f:= 2*exp(-t^2)/sqrt(Pi);`
`> int(f, t=0..infinity);` (answer is 1)

77. (a) $f(x) = \frac{1}{\sqrt{2\pi}} e^{-x^2/2}$

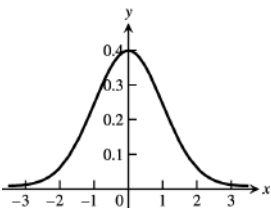

f is increasing on $(-\infty, 0]$. f is decreasing on $[0, \infty)$. f has a local maximum at $(0, f(0)) = \left(0, \frac{1}{\sqrt{2\pi}}\right)$

(b) Maple commands:

`> f:= exp(-x^2/2)/(sqrt(2*pi));`
`> int(f, x = -1..1);` ≈ 0.683
`> int(f, x = -2..2);` ≈ 0.954
`> int(f, x = -3..3);` ≈ 0.997

(c) Part (b) suggests that as n increases, the integral approaches 1. We can take $\int_{-n}^n f(x) dx$ as close to 1 as we want by choosing $n > 1$ large enough. Also, we can make $\int_n^\infty f(x) dx$ and $\int_{-\infty}^{-n} f(x) dx$ as small as we want by choosing n large enough. This is because $0 < f(x) < e^{-x^2/2}$ for $x > 1$. (Likewise, $0 < f(x) < e^{x^2/2}$ for $x < -1$.)

Thus, $\int_n^\infty f(x) dx < \int_n^\infty e^{-x^2/2} dx$.

$$\int_n^\infty e^{-x^2/2} dx = \lim_{c \rightarrow \infty} \int_n^c e^{-x^2/2} dx = \lim_{c \rightarrow \infty} [-2e^{-x^2/2}]_n^c = \lim_{c \rightarrow \infty} [-2e^{-c^2/2} + 2e^{-n^2/2}] = 2e^{-n^2/2}$$

As $n \rightarrow \infty$, $2e^{-n^2/2} \rightarrow 0$, for large enough n , $\int_n^\infty f(x) dx$ is as small as we want. Likewise for large enough n ,

$\int_{-\infty}^{-n} f(x) dx$ is as small as we want.

78. $\int_3^\infty \left(\frac{1}{x-2} - \frac{1}{x}\right) dx \neq \int_3^\infty \frac{dx}{x-2} - \int_3^\infty \frac{dx}{x}$, since the left hand integral converges but both of the right hand integrals diverge.

79. (a) The statement is true since $\int_{-\infty}^b f(x) dx = \int_{-\infty}^a f(x) dx + \int_a^b f(x) dx$, $\int_b^{\infty} f(x) dx = \int_a^{\infty} f(x) dx - \int_a^b f(x) dx$ and $\int_a^b f(x) dx$ exists since $f(x)$ is integrable on every interval $[a, b]$.

$$(b) \int_{-\infty}^a f(x) dx + \int_a^{\infty} f(x) dx = \int_{-\infty}^a f(x) dx + \int_a^b f(x) dx - \int_a^b f(x) dx + \int_b^{\infty} f(x) dx \\ = \int_{-\infty}^b f(x) dx + \int_b^{\infty} f(x) dx + \int_a^{\infty} f(x) dx = \int_{-\infty}^b f(x) dx + \int_b^{\infty} f(x) dx$$

$$80. (a) \int_{-\infty}^{\infty} f(x) dx = \int_{-\infty}^0 f(x) dx + \int_0^{\infty} f(x) dx = -\int_0^{\infty} f(-u) du + \int_0^{\infty} f(x) dx \\ = \int_0^{\infty} f(-u) du + \int_0^{\infty} f(x) dx = 2 \int_0^{\infty} f(x) dx, \text{ where } u = -x$$

$$(b) \int_{-\infty}^{\infty} f(x) dx = \int_{-\infty}^0 f(x) dx + \int_0^{\infty} f(x) dx = -\int_0^{\infty} f(-u) du + \int_0^{\infty} f(x) dx \\ = \int_0^{\infty} -f(u) du + \int_0^{\infty} f(x) dx = -\int_0^{\infty} f(x) dx + \int_0^{\infty} f(x) dx = 0, \text{ where } u = -x$$

$$81. \int_{-\infty}^{\infty} \frac{dx}{\sqrt{x^2+1}} = \int_{-\infty}^{-1} \frac{dx}{\sqrt{x^2+1}} + \int_{-1}^{\infty} \frac{dx}{\sqrt{x^2+1}}; \int_{-1}^{\infty} \frac{dx}{\sqrt{x^2+1}} \text{ diverges because } \lim_{x \rightarrow \infty} \left(\frac{1}{\sqrt{x^2+1}} \right) \\ = \lim_{x \rightarrow \infty} \frac{\sqrt{x^2+1}}{x} = \lim_{x \rightarrow \infty} \sqrt{1 + \frac{1}{x^2}} = 1 \text{ and } \int_{-1}^{\infty} \frac{dx}{x} \text{ diverges; therefore, } \int_{-\infty}^{\infty} \frac{dx}{\sqrt{x^2+1}} \text{ diverges}$$

82. $\int_{-\infty}^{\infty} \frac{1}{\sqrt{1+x^6}} dx$ converges, since $\int_{-\infty}^{\infty} \frac{1}{\sqrt{1+x^6}} dx = 2 \int_0^{\infty} \frac{1}{\sqrt{1+x^6}} dx$ which was shown to converge in Exercise 51

$$83. \int_{-\infty}^{\infty} \frac{dx}{e^x + e^{-x}} = \int_{-\infty}^{\infty} \frac{e^x dx}{e^{2x} + 1}; \frac{e^x}{e^{2x} + 1} = \frac{1}{e^x + e^{-x}} < \frac{1}{e^x} \text{ and } \int_0^{\infty} \frac{dx}{e^x} = \lim_{c \rightarrow \infty} [-e^{-x}]_0^c = \lim_{c \rightarrow \infty} (-e^{-c} + 1) = 1 \\ \Rightarrow \int_{-\infty}^{\infty} \frac{e^x dx}{e^{2x} + 1} = 2 \int_0^{\infty} \frac{dx}{e^x + e^{-x}} \text{ converges}$$

$$84. \int_{-\infty}^{\infty} \frac{e^{-x} dx}{x^2+1} = \int_{-\infty}^{-1} \frac{e^{-x} dx}{x^2+1} + \int_{-1}^{\infty} \frac{e^{-x} dx}{x^2+1}; \int_{-1}^{\infty} \frac{e^{-x} dx}{x^2+1} = \int_1^{\infty} \frac{e^u du}{1+u^2}, \text{ where } u = -x, \text{ and since } \frac{e^u}{1+u^2} > \frac{1}{u} \text{ (} u > 1 \text{) and } \\ \int_1^{\infty} \frac{du}{u} \text{ diverges, the integral } \int_1^{\infty} \frac{e^u du}{1+u^2} \text{ diverges } \Rightarrow \int_{-\infty}^{\infty} \frac{e^{-x} dx}{x^2+1} \text{ diverges}$$

$$85. \int_{-\infty}^{\infty} e^{-|x|} dx = 2 \int_0^{\infty} e^{-x} dx = 2 \lim_{b \rightarrow \infty} \int_0^b e^{-x} dx = -2 \lim_{b \rightarrow \infty} [e^{-x}]_0^b = 2, \text{ so the integral converges.}$$

$$86. \int_{-\infty}^{\infty} \frac{dx}{(x+1)^2} = \int_{-\infty}^{-2} \frac{dx}{(x+1)^2} + \int_{-2}^{-1} \frac{dx}{(x+1)^2} + \int_{-1}^2 \frac{dx}{(x+1)^2} + \int_2^{\infty} \frac{dx}{(x+1)^2}; \\ \lim_{b \rightarrow -1^-} \int_{-2}^b \frac{dx}{(x+1)^2} = -\lim_{b \rightarrow -1^-} \left[\frac{1}{x+1} \right]_{-2}^b = \infty, \text{ which diverges } \Rightarrow \int_{-\infty}^{\infty} \frac{dx}{(x+1)^2} \text{ diverges}$$

$$87. \int_{-\infty}^{\infty} \frac{|\sin x| + |\cos x|}{|x|+1} dx = 2 \int_0^{\infty} \frac{|\sin x| + |\cos x|}{x+1} dx \geq 2 \int_0^{\infty} \frac{\sin^2 x + \cos^2 x}{x+1} dx = 2 \lim_{b \rightarrow \infty} \int_0^b \frac{dx}{x+1} dx \\ = 2 \lim_{b \rightarrow \infty} [\ln|x+1|]_0^b = \infty, \text{ which diverges } \Rightarrow \int_{-\infty}^{\infty} \frac{|\sin x| + |\cos x|}{|x|+1} dx \text{ diverges}$$

$$88. \int_{-\infty}^{\infty} \frac{x}{(x^2+1)(x^2+2)} dx = 0 \text{ by Exercise 80(b) because the integrand is odd and the integral} \\ \int_0^{\infty} \frac{x dx}{(x^2+1)(x^2+2)} \leq \int_0^{\infty} \frac{dx}{x^2} \text{ converges}$$

89. Example CAS commands:

Maple:

```
f := (x,p) -> x^p*ln(x);
domain := 0..exp(1);
fn_list := [seq(f(x,p), p=-2..2)];
```

```

plot( fn_list, x=domain, y=-50..10, color=[red,blue,green,cyan,pink], linestyle=[1,3,4,7,9], thickness=[3,4,1,2,0],
      legend=["p = -2", "p = -1", "p = 0", "p = 1", "p = 2"], title="#89 (Section 8.8)");
q1 := Int( f(x,p), x=domain );
q2 := value( q1 );
q3 := simplify( q2 ) assuming p>-1;
q4 := simplify( q2 ) assuming p<-1;
q5 := value( eval( q1, p=-1 ) );
i1 := q1 = piecewise( p<-1, q4, p=-1, q5, p>-1, q3 );

```

90. Example CAS commands:

Maple:

```

f := (x,p) -> x^p*ln(x);
domain := exp(1)..infinity;
fn_list := [seq( f(x,p), p=-2..2)];
plot( fn_list, x=exp(1)..10, y=0..100, color=[red,blue,green,cyan,pink], linestyle=[1,3,4,7,9], thickness=[3,4,1,2,0],
      legend=["p = -2", "p = -1", "p = 0", "p = 1", "p = 2"], title="#90 (Section 8.8)");
q6 := Int( f(x,p), x=domain );
q7 := value( q6 );
q8 := simplify( q7 ) assuming p>-1;
q9 := simplify( q7 ) assuming p<-1;
q10 := value( eval( q6, p=-1 ) );
i2 := q6 = piecewise( p<-1, q9, p=-1, q10, p>-1, q8 );

```

91. Example CAS commands:

Maple:

```

f := (x,p) -> x^p*ln(x);
domain := 0..infinity;
fn_list := [seq( f(x,p), p=-2..2)];
plot( fn_list, x=0..10, y=-50..50, color=[red,blue,green,cyan,pink], linestyle=[1,3,4,7,9], thickness=[3,4,1,2,0],
      legend=["p = -2", "p = -1", "p = 0", "p = 1", "p = 2"], title="#91 (Section 8.8)");
q11 := Int( f(x,p), x=domain );
q11 = lhs(i1+i2);
`` = rhs(i1+i2);
`` = piecewise( p<-1, q4+q9, p=-1, q5+q10, p>-1, q3+q8 );
`` = piecewise( p<-1, -infinity, p=-1, undefined, p>-1, infinity );

```

92. Example CAS commands:

Maple:

```

f := (x,p) -> x^p*ln(abs(x));
domain := -infinity..infinity;
fn_list := [seq( f(x,p), p=-2..2)];
plot( fn_list, x=-4..4, y=-20..10, color=[red,blue,green,cyan,pink], linestyle=[1,3,4,7,9],
      legend=["p = -2", "p = -1", "p = 0", "p = 1", "p = 2"], title="#92 (Section 8.8)");
q12 := Int( f(x,p), x=domain );
q12p := Int( f(x,p), x=0..infinity );
q12n := Int( f(x,p), x=-infinity..0 );
q12 = q12p + q12n;
`` = simplify( q12p+q12n );

```

89-92. Example CAS commands:

Mathematica: (functions and domains may vary)

Clear[x, f, p]

f[x_]:= x^p Log[Abs[x]]

int = Integrate[f[x], {x, e, 100}]

int /. p → 2.5

In order to plot the function, a value for p must be selected.

p = 3;

Plot[f[x], {x, 2.72, 10}]

CHAPTER 8 PRACTICE EXERCISES

$$1. \int x\sqrt{4x^2 - 9} \, dx; \left[\begin{array}{l} u = 4x^2 - 9 \\ du = 8x \, dx \end{array} \right] \rightarrow \frac{1}{8} \int \sqrt{u} \, du = \frac{1}{8} \cdot \frac{2}{3} u^{3/2} + C = \frac{1}{12} (4x^2 - 9)^{3/2} + C$$

$$2. \int 6x\sqrt{3x^2 + 5} \, dx; \left[\begin{array}{l} u = 3x^2 + 5 \\ du = 6x \, dx \end{array} \right] \rightarrow \int \sqrt{u} \, du = \frac{2}{3} u^{3/2} + C = \frac{2}{3} (3x^2 + 5)^{3/2} + C$$

$$3. \int x(2x + 1)^{1/2} \, dx; \left[\begin{array}{l} u = 2x + 1 \\ du = 2 \, dx \end{array} \right] \rightarrow \frac{1}{2} \int \left(\frac{u-1}{2}\right) \sqrt{u} \, du = \frac{1}{4} \left(\int u^{3/2} \, du - \int u^{1/2} \, du \right) = \frac{1}{4} \left(\frac{2}{5} u^{5/2} - \frac{2}{3} u^{3/2} \right) + C \\ = \frac{(2x+1)^{5/2}}{10} - \frac{(2x+1)^{3/2}}{6} + C$$

$$4. \int \frac{x}{\sqrt{1-x}} \, dx; \left[\begin{array}{l} u = 1-x \\ du = -dx \end{array} \right] \rightarrow - \int \frac{(1-u)}{\sqrt{u}} \, du = \int \left(\sqrt{u} - \frac{1}{\sqrt{u}} \right) \, du = \frac{2}{3} u^{3/2} - 2u^{1/2} + C \\ = \frac{2}{3} (1-x)^{3/2} - 2(1-x)^{1/2} + C$$

$$5. \int \frac{x \, dx}{\sqrt{8x^2 + 1}}; \left[\begin{array}{l} u = 8x^2 + 1 \\ du = 16x \, dx \end{array} \right] \rightarrow \frac{1}{16} \int \frac{du}{\sqrt{u}} = \frac{1}{16} \cdot 2u^{1/2} + C = \frac{\sqrt{8x^2 + 1}}{8} + C$$

$$6. \int \frac{x \, dx}{\sqrt{9-4x^2}}; \left[\begin{array}{l} u = 9-4x^2 \\ du = -8x \, dx \end{array} \right] \rightarrow -\frac{1}{8} \int \frac{du}{\sqrt{u}} = -\frac{1}{8} \cdot 2u^{1/2} + C = -\frac{\sqrt{9-4x^2}}{4} + C$$

$$7. \int \frac{y \, dy}{25+y^2}; \left[\begin{array}{l} u = 25+y^2 \\ du = 2y \, dy \end{array} \right] \rightarrow \frac{1}{2} \int \frac{du}{u} = \frac{1}{2} \ln |u| + C = \frac{1}{2} \ln (25+y^2) + C$$

$$8. \int \frac{y^3 \, dy}{4+y^4}; \left[\begin{array}{l} u = 4+y^4 \\ du = 4y^3 \, dy \end{array} \right] \rightarrow \frac{1}{4} \int \frac{du}{u} = \frac{1}{4} \ln |u| + C = \frac{1}{4} \ln (4+y^4) + C$$

$$9. \int \frac{t^3 \, dt}{\sqrt{9-4t^4}}; \left[\begin{array}{l} u = 9-4t^4 \\ du = -16t^3 \, dt \end{array} \right] \rightarrow -\frac{1}{16} \int \frac{du}{\sqrt{u}} = -\frac{1}{16} \cdot 2u^{1/2} + C = -\frac{\sqrt{9-4t^4}}{8} + C$$

$$10. \int \frac{2t \, dt}{t^4+1}; \left[\begin{array}{l} u = t^2 \\ du = 2t \, dt \end{array} \right] \rightarrow \int \frac{du}{u^2+1} = \tan^{-1} u + C = \tan^{-1} t^2 + C$$

$$11. \int z^{2/3} (z^{5/3} + 1)^{2/3} \, dz; \left[\begin{array}{l} u = z^{5/3} + 1 \\ du = \frac{5}{3} z^{2/3} \, dz \end{array} \right] \rightarrow \frac{3}{5} \int u^{2/3} \, du = \frac{3}{5} \cdot \frac{3}{5} u^{5/3} + C = \frac{9}{25} (z^{5/3} + 1)^{5/3} + C$$

$$12. \int z^{-1/5} (1 + z^{4/5})^{-1/2} dz; \left[\begin{array}{l} u = 1 + z^{4/5} \\ du = \frac{4}{5} z^{-1/5} dz \end{array} \right] \rightarrow \frac{5}{4} \int u^{-1/2} du = \frac{5}{4} \cdot 2\sqrt{u} + C = \frac{5}{2} (1 + z^{4/5})^{1/2} + C$$

$$13. \int \frac{\sin 2\theta d\theta}{(1 - \cos 2\theta)^2}; \left[\begin{array}{l} u = 1 - \cos 2\theta \\ du = 2 \sin 2\theta d\theta \end{array} \right] \rightarrow \frac{1}{2} \int \frac{du}{u^2} = -\frac{1}{2u} + C = -\frac{1}{2(1 - \cos 2\theta)} + C$$

$$14. \int \frac{\cos \theta d\theta}{(1 + \sin \theta)^{1/2}}; \left[\begin{array}{l} u = 1 + \sin \theta \\ du = \cos \theta d\theta \end{array} \right] \rightarrow \int \frac{du}{u^{1/2}} = 2u^{1/2} + C = 2\sqrt{1 + \sin \theta} + C$$

$$15. \int \frac{\sin t dt}{3 + 4 \cos t}; \left[\begin{array}{l} u = 3 + 4 \cos t \\ du = -4 \sin t dt \end{array} \right] \rightarrow -\frac{1}{4} \int \frac{du}{u} = -\frac{1}{4} \ln |u| + C = -\frac{1}{4} \ln |3 + 4 \cos t| + C$$

$$16. \int \frac{\cos 2t dt}{1 + \sin 2t}; \left[\begin{array}{l} u = 1 + \sin 2t \\ du = 2 \cos 2t dt \end{array} \right] \rightarrow \frac{1}{2} \int \frac{du}{u} = \frac{1}{2} \ln |u| + C = \frac{1}{2} \ln |1 + \sin 2t| + C$$

$$17. \int (\sin 2x) e^{\cos 2x} dx; \left[\begin{array}{l} u = \cos 2x \\ du = -2 \sin 2x dx \end{array} \right] \rightarrow -\frac{1}{2} \int e^u du = -\frac{1}{2} e^u + C = -\frac{1}{2} e^{\cos 2x} + C$$

$$18. \int (\sec x \tan x) e^{\sec x} dx; \left[\begin{array}{l} u = \sec x \\ du = \sec x \tan x dx \end{array} \right] \rightarrow \int e^u du = e^u + C = e^{\sec x} + C$$

$$19. \int e^\theta \sin(e^\theta) \cos^2(e^\theta) d\theta; \left[\begin{array}{l} u = \cos(e^\theta) \\ du = -\sin(e^\theta) \cdot e^\theta d\theta \end{array} \right] \rightarrow \int -u^2 du = -\frac{1}{3} u^3 + C = -\frac{1}{3} \cos^3(e^\theta) + C$$

$$20. \int e^\theta \sec^2(e^\theta) d\theta; \left[\begin{array}{l} u = e^\theta \\ du = e^\theta d\theta \end{array} \right] \rightarrow \int \sec^2 u du = \tan u + C = \tan(e^\theta) + C$$

$$21. \int 2^{x-1} dx = \frac{2^{x-1}}{\ln 2} + C$$

$$22. \int 5^{x\sqrt{2}} dx = \frac{1}{\sqrt{2}} \left(\frac{5^{x\sqrt{2}}}{\ln 5} \right) + C$$

$$23. \int \frac{dv}{v \ln v}; \left[\begin{array}{l} u = \ln v \\ du = \frac{1}{v} dv \end{array} \right] \rightarrow \int \frac{du}{u} = \ln |u| + C = \ln |\ln v| + C$$

$$24. \int \frac{dv}{v(2 + \ln v)}; \left[\begin{array}{l} u = 2 + \ln v \\ du = \frac{1}{v} dv \end{array} \right] \rightarrow \int \frac{du}{u} = \ln |u| + C = \ln |2 + \ln v| + C$$

$$25. \int \frac{dx}{(x^2+1)(2+\tan^{-1} x)}; \left[\begin{array}{l} u = 2 + \tan^{-1} x \\ du = \frac{dx}{x^2+1} \end{array} \right] \rightarrow \int \frac{du}{u} = \ln |u| + C = \ln |2 + \tan^{-1} x| + C$$

$$26. \int \frac{\sin^{-1} x dx}{\sqrt{1-x^2}}; \left[\begin{array}{l} u = \sin^{-1} x \\ du = \frac{dx}{\sqrt{1-x^2}} \end{array} \right] \rightarrow \int u du = \frac{1}{2} u^2 + C = \frac{1}{2} (\sin^{-1} x)^2 + C$$

$$27. \int \frac{2 dx}{\sqrt{1-4x^2}}; \left[\begin{array}{l} u = 2x \\ du = 2 dx \end{array} \right] \rightarrow \int \frac{du}{\sqrt{1-u^2}} = \sin^{-1} u + C = \sin^{-1} (2x) + C$$

$$28. \int \frac{dx}{\sqrt{49-x^2}} = \frac{1}{7} \int \frac{dx}{\sqrt{1-(\frac{x}{7})^2}}; \left[\begin{array}{l} u = \frac{x}{7} \\ du = \frac{1}{7} dx \end{array} \right] \rightarrow \int \frac{du}{\sqrt{1-u^2}} = \sin^{-1} u + C = \sin^{-1} \left(\frac{x}{7} \right) + C$$

$$29. \int \frac{dt}{\sqrt{16-9t^2}} = \frac{1}{4} \int \frac{dt}{\sqrt{1-\left(\frac{3t}{4}\right)^2}}; \left[\begin{array}{l} u = \frac{3}{4}t \\ du = \frac{3}{4}dt \end{array} \right] \rightarrow \frac{1}{3} \int \frac{du}{\sqrt{1-u^2}} = \frac{1}{3} \sin^{-1} u + C = \frac{1}{3} \sin^{-1} \left(\frac{3t}{4} \right) + C$$

$$30. \int \frac{dt}{\sqrt{9-4t^2}} = \frac{1}{3} \int \frac{dt}{\sqrt{1-\left(\frac{2t}{3}\right)^2}}; \left[\begin{array}{l} u = \frac{2}{3}t \\ du = \frac{2}{3}dt \end{array} \right] \rightarrow \frac{1}{2} \int \frac{du}{\sqrt{1-u^2}} = \frac{1}{2} \sin^{-1} u + C = \frac{1}{2} \sin^{-1} \left(\frac{2t}{3} \right) + C$$

$$31. \int \frac{dt}{9+t^2} = \frac{1}{9} \int \frac{dt}{1+\left(\frac{t}{3}\right)^2}; \left[\begin{array}{l} u = \frac{1}{3}t \\ du = \frac{1}{3}dt \end{array} \right] \rightarrow \frac{1}{3} \int \frac{du}{1+u^2} = \frac{1}{3} \tan^{-1} u + C = \frac{1}{3} \tan^{-1} \left(\frac{t}{3} \right) + C$$

$$32. \int \frac{dt}{1+25t^2}; \left[\begin{array}{l} u = 5t \\ du = 5dt \end{array} \right] \rightarrow \frac{1}{5} \int \frac{du}{1+u^2} = \frac{1}{5} \tan^{-1} u + C = \frac{1}{5} \tan^{-1} (5t) + C$$

$$33. \int \frac{4dx}{5x\sqrt{25x^2-16}} = \frac{4}{25} \int \frac{dx}{x\sqrt{x^2-\frac{16}{25}}} = \frac{1}{5} \sec^{-1} \left| \frac{5x}{4} \right| + C$$

$$34. \int \frac{6dx}{x\sqrt{4x^2-9}} = 3 \int \frac{dx}{x\sqrt{x^2-\frac{9}{4}}} = 2 \sec^{-1} \left| \frac{2x}{3} \right| + C$$

$$35. \int \frac{dx}{\sqrt{4x-x^2}} = \int \frac{d(x-2)}{\sqrt{4-(x-2)^2}} = \sin^{-1} \left(\frac{x-2}{2} \right) + C$$

$$36. \int \frac{dx}{\sqrt{4x-x^2-3}} = \int \frac{d(x-2)}{\sqrt{1-(x-2)^2}} = \sin^{-1} (x-2) + C$$

$$37. \int \frac{dy}{y^2-4y+8} = \int \frac{d(y-2)}{(y-2)^2+4} = \frac{1}{2} \tan^{-1} \left(\frac{y-2}{2} \right) + C$$

$$38. \int \frac{dt}{t^2+4t+5} = \int \frac{d(t+2)}{(t+2)^2+1} = \tan^{-1} (t+2) + C$$

$$39. \int \frac{dx}{(x-1)\sqrt{x^2-2x}} = \int \frac{d(x-1)}{(x-1)\sqrt{(x-1)^2-1}} = \sec^{-1} |x-1| + C$$

$$40. \int \frac{dv}{(v+1)\sqrt{v^2+2v}} = \int \frac{d(v+1)}{(v+1)\sqrt{(v+1)^2-1}} = \sec^{-1} |v+1| + C$$

$$41. \int \sin^2 x dx = \int \frac{1-\cos 2x}{2} dx = \frac{x}{2} - \frac{\sin 2x}{4} + C$$

$$42. \int \cos^2 3x dx = \int \frac{1+\cos 6x}{2} dx = \frac{x}{2} + \frac{\sin 6x}{12} + C$$

$$43. \int \sin^3 \frac{\theta}{2} d\theta = \int (1 - \cos^2 \frac{\theta}{2}) (\sin \frac{\theta}{2}) d\theta; \left[\begin{array}{l} u = \cos \frac{\theta}{2} \\ du = -\frac{1}{2} \sin \frac{\theta}{2} d\theta \end{array} \right] \rightarrow -2 \int (1-u^2) du = \frac{2u^3}{3} - 2u + C \\ = \frac{2}{3} \cos^3 \frac{\theta}{2} - 2 \cos \frac{\theta}{2} + C$$

$$44. \int \sin^3 \theta \cos^2 \theta d\theta = \int (1 - \cos^2 \theta) (\sin \theta) (\cos^2 \theta) d\theta; \left[\begin{array}{l} u = \cos \theta \\ du = -\sin \theta d\theta \end{array} \right] \rightarrow - \int (1-u^2) u^2 du = \int (u^4 - u^2) du \\ = \frac{u^5}{5} - \frac{u^3}{3} + C = \frac{\cos^5 \theta}{5} - \frac{\cos^3 \theta}{3} + C$$

45. $\int \tan^3 2t \, dt = \int (\tan 2t)(\sec^2 2t - 1) \, dt = \int \tan 2t \sec^2 2t \, dt - \int \tan 2t \, dt; \left[\begin{array}{l} u = 2t \\ du = 2 \, dt \end{array} \right]$
 $\rightarrow \frac{1}{2} \int \tan u \sec^2 u \, du - \frac{1}{2} \int \tan u \, du = \frac{1}{4} \tan^2 u + \frac{1}{2} \ln |\cos u| + C = \frac{1}{4} \tan^2 2t + \frac{1}{2} \ln |\cos 2t| + C$
 $= \frac{1}{4} \tan^2 2t - \frac{1}{2} \ln |\sec 2t| + C$
46. $\int 6 \sec^4 t \, dt = 6 \int (\tan^2 t + 1)(\sec^2 t) \, dt; \left[\begin{array}{l} u = \tan t \\ du = \sec^2 t \, dt \end{array} \right] \rightarrow 6 \int (u^2 + 1) \, du = 2u^3 + 6u + C$
 $= 2 \tan^3 t + 6 \tan t + C$
47. $\int \frac{dx}{2 \sin x \cos x} = \int \frac{dx}{\sin 2x} = \int \csc 2x \, dx = -\frac{1}{2} \ln |\csc 2x + \cot 2x| + C$
48. $\int \frac{2 \, dx}{\cos^2 x - \sin^2 x} = \int \frac{2 \, dx}{\cos 2x}; \left[\begin{array}{l} u = 2x \\ du = 2 \, dx \end{array} \right] \rightarrow \int \frac{du}{\cos u} = \int \sec u \, du = \ln |\sec u + \tan u| + C$
 $= \ln |\sec 2x + \tan 2x| + C$
49. $\int_{\pi/4}^{\pi/2} \sqrt{\csc^2 y - 1} \, dy = \int_{\pi/4}^{\pi/2} \cot y \, dy = [\ln |\sin y|]_{\pi/4}^{\pi/2} = \ln 1 - \ln \frac{1}{\sqrt{2}} = \ln \sqrt{2}$
50. $\int_{\pi/4}^{3\pi/4} \sqrt{\cot^2 t + 1} \, dt = \int_{\pi/4}^{3\pi/4} \csc t \, dt = [-\ln |\csc t + \cot t|]_{\pi/4}^{3\pi/4} = -\ln \left| \csc \frac{3\pi}{4} + \cot \frac{3\pi}{4} \right| + \ln \left| \csc \frac{\pi}{4} + \cot \frac{\pi}{4} \right|$
 $= -\ln \left| \sqrt{2} - 1 \right| + \ln \left| \sqrt{2} + 1 \right| = \ln \left| \frac{\sqrt{2}+1}{\sqrt{2}-1} \right| = \ln \left| \frac{(\sqrt{2}+1)(\sqrt{2}+1)}{2-1} \right| = \ln (3 + 2\sqrt{2})$
51. $\int_0^{\pi} \sqrt{1 - \cos^2 2x} \, dx = \int_0^{\pi} |\sin 2x| \, dx = \int_0^{\pi/2} \sin 2x \, dx - \int_{\pi/2}^{\pi} \sin 2x \, dx = -\left[\frac{\cos 2x}{2}\right]_0^{\pi/2} + \left[\frac{\cos 2x}{2}\right]_{\pi/2}^{\pi}$
 $= -\left(-\frac{1}{2} - \frac{1}{2}\right) + \left[\frac{1}{2} - \left(-\frac{1}{2}\right)\right] = 2$
52. $\int_0^{2\pi} \sqrt{1 - \sin^2 \frac{x}{2}} \, dx = \int_0^{2\pi} \left| \cos \frac{x}{2} \right| \, dx = \int_0^{\pi} \cos \frac{x}{2} \, dx - \int_{\pi}^{2\pi} \cos \frac{x}{2} \, dx = \left[2 \sin \frac{x}{2}\right]_0^{\pi} - \left[2 \sin \frac{x}{2}\right]_{\pi}^{2\pi}$
 $= (2 - 0) - (0 - 2) = 4$
53. $\int_{-\pi/2}^{\pi/2} \sqrt{1 - \cos 2t} \, dt = \sqrt{2} \int_{-\pi/2}^{\pi/2} |\sin t| \, dt = 2\sqrt{2} \int_0^{\pi/2} \sin t \, dt = \left[-2\sqrt{2} \cos t\right]_0^{\pi/2} = 2\sqrt{2} [0 - (-1)] = 2\sqrt{2}$
54. $\int_{\pi}^{2\pi} \sqrt{1 + \cos 2t} \, dt = \sqrt{2} \int_{\pi}^{2\pi} |\cos t| \, dt = -\sqrt{2} \int_{\pi}^{3\pi/2} \cos t \, dt + \sqrt{2} \int_{3\pi/2}^{2\pi} \cos t \, dt$
 $= -\sqrt{2} \left[\sin t\right]_{\pi}^{3\pi/2} + \sqrt{2} \left[\sin t\right]_{3\pi/2}^{2\pi} = -\sqrt{2}(-1 - 0) + \sqrt{2}[0 - (-1)] = 2\sqrt{2}$
55. $\int \frac{x^2 \, dx}{x^2 + 4} = x - \int \frac{4 \, dx}{x^2 + 4} = x - 2 \tan^{-1} \left(\frac{x}{2}\right) + C$
56. $\int \frac{x^3 \, dx}{9 + x^2} = \int \left[\frac{x(x^2 + 9) - 9x}{x^2 + 9} \right] \, dx = \int \left(x - \frac{9x}{x^2 + 9}\right) \, dx = \frac{x^2}{2} - \frac{9}{2} \ln |9 + x^2| + C$
57. $\int \frac{4x^2 + 3}{2x - 1} \, dx = \int \left[(2x + 1) + \frac{4}{2x - 1}\right] \, dx = x + x^2 + 2 \ln |2x - 1| + C$
58. $\int \frac{2x \, dx}{x - 4} = \int \left(2 + \frac{8}{x - 4}\right) \, dx = 2x + 8 \ln |x - 4| + C$
59. $\int \frac{2y - 1}{y^2 + 4} \, dy = \int \frac{2y \, dy}{y^2 + 4} - \int \frac{dy}{y^2 + 4} = \ln |y^2 + 4| - \frac{1}{2} \tan^{-1} \left(\frac{y}{2}\right) + C$

$$60. \int \frac{y+4}{y^2+1} dy = \int \frac{y dy}{y^2+1} + 4 \int \frac{dy}{y^2+1} = \frac{1}{2} \ln(y^2+1) + 4 \tan^{-1} y + C$$

$$61. \int \frac{t+2}{\sqrt{4-t^2}} dt = \int \frac{t dt}{\sqrt{4-t^2}} + 2 \int \frac{dt}{\sqrt{4-t^2}} = -\sqrt{4-t^2} + 2 \sin^{-1} \left(\frac{t}{2}\right) + C$$

$$62. \int \frac{2t^2 + \sqrt{1-t^2}}{t\sqrt{1-t^2}} dt = \int \frac{2t dt}{\sqrt{1-t^2}} + \int \frac{dt}{t} = -2\sqrt{1-t^2} + \ln |t| + C$$

$$63. \int \frac{\tan x dx}{\tan x + \sec x} = \int \frac{\sin x dx}{\sin x + 1} = \int \frac{(\sin x)(1 - \sin x)}{1 - \sin^2 x} dx = \int \frac{\sin x - 1 + \cos^2 x}{\cos^2 x} dx$$

$$= -\int \frac{d(\cos x)}{\cos^2 x} - \int \frac{dx}{\cos^2 x} + \int dx = \frac{1}{\cos x} - \tan x + x + C = x - \tan x + \sec x + C$$

$$64. \int \frac{\cot x dx}{\cot x + \csc x} = \int \frac{\cos x dx}{\cos x + 1} = \int \frac{(\cos x)(1 - \cos x)}{1 - \cos^2 x} dx = \int \frac{\cos x - 1 + \sin^2 x}{\sin^2 x} dx$$

$$= \int \frac{d(\sin x)}{\sin^2 x} - \int \frac{dx}{\sin^2 x} + \int dx = -\frac{1}{\sin x} + \cot x + x + C = x + \cot x - \csc x + C$$

$$65. \int \sec(5-3x) dx; \left[\begin{array}{l} y = 5-3x \\ dy = -3 dx \end{array} \right] \rightarrow \int \sec y \cdot \left(-\frac{dy}{3}\right) = -\frac{1}{3} \int \sec y dy = -\frac{1}{3} \ln |\sec y + \tan y| + C$$

$$= -\frac{1}{3} \ln |\sec(5-3x) + \tan(5-3x)| + C$$

$$66. \int x \csc(x^2+3) dx = \frac{1}{2} \int \csc(x^2+3) d(x^2+3) = -\frac{1}{2} \ln |\csc(x^2+3) + \cot(x^2+3)| + C$$

$$67. \int \cot\left(\frac{x}{4}\right) dx = 4 \int \cot\left(\frac{x}{4}\right) d\left(\frac{x}{4}\right) = 4 \ln \left|\sin\left(\frac{x}{4}\right)\right| + C$$

$$68. \int \tan(2x-7) dx = \frac{1}{2} \int \tan(2x-7) d(2x-7) = -\frac{1}{2} \ln |\cos(2x-7)| + C = \frac{1}{2} \ln |\sec(2x-7)| + C$$

$$69. \int x\sqrt{1-x} dx; \left[\begin{array}{l} u = 1-x \\ du = -dx \end{array} \right] \rightarrow -\int (1-u)\sqrt{u} du = \int (u^{3/2} - u^{1/2}) du = \frac{2}{5} u^{5/2} - \frac{2}{3} u^{3/2} + C$$

$$= \frac{2}{5} (1-x)^{5/2} - \frac{2}{3} (1-x)^{3/2} + C = -2 \left[\frac{(\sqrt{1-x})^3}{3} - \frac{(\sqrt{1-x})^5}{5} \right] + C$$

$$70. \int 3x\sqrt{2x+1} dx; \left[\begin{array}{l} u = 2x+1 \\ du = 2 dx \end{array} \right] \rightarrow \int 3\left(\frac{u-1}{2}\right) \sqrt{u} \cdot \frac{1}{2} du = \frac{3}{4} \int (u^{3/2} - u^{1/2}) du = \frac{3}{4} \cdot \frac{2}{5} u^{5/2} - \frac{3}{4} \cdot \frac{2}{3} u^{3/2} + C$$

$$= \frac{3}{10} (2x+1)^{5/2} - \frac{1}{2} (2x+1)^{3/2} + C = \frac{3(\sqrt{2x+1})^5}{10} - \frac{(\sqrt{2x+1})^3}{2} + C$$

$$71. \int \sqrt{z^2+1} dz; \left[\begin{array}{l} z = \tan \theta \\ dz = \sec^2 \theta d\theta \end{array} \right] \rightarrow \int \sqrt{\tan^2 \theta + 1} \cdot \sec^2 \theta d\theta = \int \sec^3 \theta d\theta$$

$$= \frac{\sec \theta \tan \theta}{3-1} + \frac{3-2}{3-1} \int \sec \theta d\theta \quad (\text{FORMULA 92})$$

$$= \frac{\sin \theta}{2 \cos^2 \theta} + \frac{1}{2} \ln |\sec \theta + \tan \theta| + C = \frac{z\sqrt{z^2+1}}{2} + \frac{1}{2} \ln \left| z + \sqrt{1+z^2} \right| + C$$

$$72. \int (16+z^2)^{-3/2} dz; \left[\begin{array}{l} z = 4 \tan \theta \\ dz = 4 \sec^2 \theta d\theta \end{array} \right] \rightarrow \int \frac{4 \sec^2 \theta d\theta}{64 \sec^3 \theta} = \frac{1}{16} \int \cos \theta d\theta = \frac{1}{16} \sin \theta + C = \frac{z}{16\sqrt{16+z^2}} + C$$

$$= \frac{z}{16(16+z^2)^{1/2}} + C$$

73. $\int \frac{dy}{\sqrt{25+y^2}} = \frac{1}{5} \int \frac{dy}{\sqrt{1+(\frac{y}{5})^2}} = \int \frac{du}{\sqrt{1+u^2}}, [u = \frac{y}{5}]; \left[\begin{array}{l} u = \tan \theta \\ du = \sec^2 \theta d\theta \end{array} \right] \rightarrow \int \frac{\sec^2 \theta d\theta}{\sqrt{1+\tan^2 \theta}} = \int \sec \theta d\theta$
 $= \ln |\sec \theta + \tan \theta| + C_1 = \ln \left| \sqrt{1+u^2} + u \right| + C_1 = \ln \left| \sqrt{1+(\frac{y}{5})^2} + \frac{y}{5} \right| + C_1 = \ln \left| \frac{\sqrt{25+y^2}+y}{5} \right| + C_1$
 $= \ln |y + \sqrt{25+y^2}| + C$
74. $\int \frac{dy}{\sqrt{25+9y^2}} = \frac{1}{5} \int \frac{dy}{\sqrt{1+(\frac{3y}{5})^2}} = \frac{1}{3} \int \frac{du}{\sqrt{1+u^2}} = \frac{1}{3} \ln \left| \sqrt{1+u^2} + u \right| + C_1$ from Exercise 73
 $\rightarrow \frac{1}{3} \ln \left| \sqrt{25+9y^2} + 3y \right| + C$
75. $\int \frac{dx}{x^2\sqrt{1-x^2}}; \left[\begin{array}{l} x = \sin \theta \\ dx = \cos \theta d\theta \end{array} \right] \rightarrow \int \frac{\cos \theta d\theta}{\sin^2 \theta \cos \theta} = \int \csc^2 \theta d\theta = -\cot \theta + C = \frac{-\sqrt{1-x^2}}{x} + C$
76. $\int \frac{x^3 dx}{\sqrt{1-x^2}}; \left[\begin{array}{l} x = \sin \theta \\ dx = \cos \theta d\theta \end{array} \right] \rightarrow \int \frac{\sin^3 \theta \cos \theta d\theta}{\cos \theta} = \int \sin^3 \theta d\theta = \int (1-\cos^2 \theta)(\sin \theta) d\theta;$
 $[u = \cos \theta] \rightarrow -\int (1-u^2) du = -u + \frac{u^3}{3} + C = -\cos \theta + \frac{1}{3} \cos^3 \theta = -\sqrt{1-x^2} + \frac{1}{3} (1-x^2)^{3/2} + C$
Note: Ans $\equiv \frac{-x^2\sqrt{1-x^2}}{3} - \frac{2}{3}\sqrt{1-x^2} + C$ by another method
77. $\int \frac{x^2 dx}{\sqrt{1-x^2}}; \left[\begin{array}{l} x = \sin \theta \\ dx = \cos \theta d\theta \end{array} \right] \rightarrow \int \frac{\sin^2 \theta \cos \theta d\theta}{\cos \theta} = \int \sin^2 \theta d\theta = \int \frac{1-\cos 2\theta}{2} d\theta = \frac{1}{2} \theta - \frac{1}{4} \sin 2\theta + C$
 $= \frac{1}{2} \theta - \frac{1}{2} \sin \theta \cos \theta = \frac{\sin^{-1} x}{2} - \frac{x\sqrt{1-x^2}}{2} + C$
78. $\int \sqrt{4-x^2} dx; \left[\begin{array}{l} x = 2 \sin \theta \\ dx = 2 \cos \theta d\theta \end{array} \right] \rightarrow \int 2 \cos \theta \cdot 2 \cos \theta d\theta = 2 \int (1+\cos 2\theta) d\theta = 2 \left(\theta + \frac{1}{2} \sin 2\theta \right) + C$
 $= 2\theta + 2 \sin \theta \cos \theta + C = 2 \sin^{-1} \left(\frac{x}{2} \right) + x\sqrt{1-\left(\frac{x}{2}\right)^2} + C = 2 \sin^{-1} \left(\frac{x}{2} \right) + \frac{x\sqrt{4-x^2}}{2} + C$
79. $\int \frac{dx}{\sqrt{x^2-9}}; \left[\begin{array}{l} x = 3 \sec \theta \\ dx = 3 \sec \theta \tan \theta d\theta \end{array} \right] \rightarrow \int \frac{3 \sec \theta \tan \theta d\theta}{\sqrt{9 \sec^2 \theta - 9}} = \int \frac{3 \sec \theta \tan \theta d\theta}{3 \tan \theta} = \int \sec \theta d\theta$
 $= \ln |\sec \theta + \tan \theta| + C_1 = \ln \left| \frac{x}{3} + \sqrt{\left(\frac{x}{3}\right)^2 - 1} \right| + C_1 = \ln \left| \frac{x + \sqrt{x^2-9}}{3} \right| + C_1 = \ln |x + \sqrt{x^2-9}| + C$
80. $\int \frac{12 dx}{(x^2-1)^{3/2}}; \left[\begin{array}{l} x = \sec \theta \\ dx = \sec \theta \tan \theta d\theta \end{array} \right] \rightarrow \int \frac{12 \sec \theta \tan \theta d\theta}{\tan^3 \theta} = \int \frac{12 \cos \theta d\theta}{\sin^2 \theta}; \left[\begin{array}{l} u = \sin \theta \\ du = \cos \theta d\theta \end{array} \right] \rightarrow \int \frac{12 du}{u^2}$
 $= -\frac{12}{u} + C = -\frac{12}{\sin \theta} + C = -\frac{12x}{\sqrt{x^2-1}} + C$
81. $\int \frac{\sqrt{w^2-1}}{w} dw; \left[\begin{array}{l} w = \sec \theta \\ dw = \sec \theta \tan \theta d\theta \end{array} \right] \rightarrow \int \left(\frac{\tan \theta}{\sec \theta} \right) \cdot \sec \theta \tan \theta d\theta = \int \tan^2 \theta d\theta = \int (\sec^2 \theta - 1) d\theta$
 $= \tan \theta - \theta + C = \sqrt{w^2-1} - \sec^{-1} w + C$
82. $\int \frac{\sqrt{z^2-16}}{z} dz; \left[\begin{array}{l} z = 4 \sec \theta \\ dz = 4 \sec \theta \tan \theta d\theta \end{array} \right] \rightarrow \int \frac{4 \tan \theta \cdot 4 \sec \theta \tan \theta d\theta}{4 \sec \theta} = 4 \int \tan^2 \theta d\theta = 4(\tan \theta - \theta) + C$
 $= \sqrt{z^2-16} - 4 \sec^{-1} \left(\frac{z}{4} \right) + C$
83. $u = \ln(x+1), du = \frac{dx}{x+1}; dv = dx, v = x;$
 $\int \ln(x+1) dx = x \ln(x+1) - \int \frac{x}{x+1} dx = x \ln(x+1) - \int dx + \int \frac{dx}{x+1} = x \ln(x+1) - x + \ln(x+1) + C_1$
 $= (x+1) \ln(x+1) - x + C_1 = (x+1) \ln(x+1) - (x+1) + C, \text{ where } C = C_1 + 1$

84. $u = \ln x$, $du = \frac{dx}{x}$; $dv = x^2 dx$, $v = \frac{1}{3} x^3$;

$$\int x^2 \ln x dx = \frac{1}{3} x^3 \ln x - \int \frac{1}{3} x^3 \left(\frac{1}{x}\right) dx = \frac{x^3}{3} \ln x - \frac{x^3}{9} + C$$

85. $u = \tan^{-1} 3x$, $du = \frac{3 dx}{1+9x^2}$; $dv = dx$, $v = x$;

$$\int \tan^{-1} 3x dx = x \tan^{-1} 3x - \int \frac{3x dx}{1+9x^2}; \left[\begin{array}{l} y = 1 + 9x^2 \\ dy = 18x dx \end{array} \right] \rightarrow x \tan^{-1} 3x - \frac{1}{6} \int \frac{dy}{y}$$

$$= x \tan^{-1} (3x) - \frac{1}{6} \ln(1 + 9x^2) + C$$

86. $u = \cos^{-1} \left(\frac{x}{2}\right)$, $du = \frac{-dx}{\sqrt{4-x^2}}$; $dv = dx$, $v = x$;

$$\int \cos^{-1} \left(\frac{x}{2}\right) dx = x \cos^{-1} \left(\frac{x}{2}\right) + \int \frac{x dx}{\sqrt{4-x^2}}; \left[\begin{array}{l} y = 4 - x^2 \\ dy = -2x dx \end{array} \right] \rightarrow x \cos^{-1} \left(\frac{x}{2}\right) - \frac{1}{2} \int \frac{dy}{\sqrt{y}}$$

$$= x \cos^{-1} \left(\frac{x}{2}\right) - \sqrt{4-x^2} + C = x \cos^{-1} \left(\frac{x}{2}\right) - 2\sqrt{1 - \left(\frac{x}{2}\right)^2} + C$$

87. e^x

$$(x+1)^2 \xrightarrow{(+)} e^x$$

$$2(x+1) \xrightarrow{(-)} e^x$$

$$2 \xrightarrow{(+)} e^x$$

$$0 \Rightarrow \int (x+1)^2 e^x dx = [(x+1)^2 - 2(x+1) + 2] e^x + C$$

88. $\sin(1-x)$

$$x^2 \xrightarrow{(+)} \cos(1-x)$$

$$2x \xrightarrow{(-)} -\sin(1-x)$$

$$2 \xrightarrow{(+)} -\cos(1-x)$$

$$0 \Rightarrow \int x^2 \sin(1-x) dx = x^2 \cos(1-x) + 2x \sin(1-x) - 2 \cos(1-x) + C$$

89. $u = \cos 2x$, $du = -2 \sin 2x dx$; $dv = e^x dx$, $v = e^x$;

$$I = \int e^x \cos 2x dx = e^x \cos 2x + 2 \int e^x \sin 2x dx;$$

$$u = \sin 2x, du = 2 \cos 2x dx; dv = e^x dx, v = e^x;$$

$$I = e^x \cos 2x + 2 \left[e^x \sin 2x - 2 \int e^x \cos 2x dx \right] = e^x \cos 2x + 2e^x \sin 2x - 4I \Rightarrow I = \frac{e^x \cos 2x}{5} + \frac{2e^x \sin 2x}{5} + C$$

90. $u = \sin 3x$, $du = 3 \cos 3x dx$; $dv = e^{-2x} dx$, $v = -\frac{1}{2} e^{-2x}$;

$$I = \int e^{-2x} \sin 3x dx = -\frac{1}{2} e^{-2x} \sin 3x + \frac{3}{2} \int e^{-2x} \cos 3x dx;$$

$$u = \cos 3x, du = -3 \sin 3x dx; dv = e^{-2x} dx, v = -\frac{1}{2} e^{-2x};$$

$$I = -\frac{1}{2} e^{-2x} \sin 3x + \frac{3}{2} \left[-\frac{1}{2} e^{-2x} \cos 3x - \frac{3}{2} \int e^{-2x} \sin 3x dx \right] = -\frac{1}{2} e^{-2x} \sin 3x - \frac{3}{4} e^{-2x} \cos 3x - \frac{9}{4} I$$

$$\Rightarrow I = \frac{4}{13} \left(-\frac{1}{2} e^{-2x} \sin 3x - \frac{3}{4} e^{-2x} \cos 3x \right) + C = -\frac{2}{13} e^{-2x} \sin 3x - \frac{3}{13} e^{-2x} \cos 3x + C$$

91. $\int \frac{x dx}{x^2-3x+2} = \int \frac{2 dx}{x-2} - \int \frac{dx}{x-1} = 2 \ln|x-2| - \ln|x-1| + C$

92. $\int \frac{x dx}{x^2+4x+3} = \frac{3}{2} \int \frac{dx}{x+3} - \frac{1}{2} \int \frac{dx}{x+1} = \frac{3}{2} \ln|x+3| - \frac{1}{2} \ln|x+1| + C$

93. $\int \frac{dx}{x(x+1)^2} = \int \left(\frac{1}{x} - \frac{1}{x+1} + \frac{-1}{(x+1)^2} \right) dx = \ln|x| - \ln|x+1| + \frac{1}{x+1} + C$
94. $\int \frac{x+1}{x^2(x-1)} dx = \int \left(\frac{2}{x-1} - \frac{2}{x} - \frac{1}{x^2} \right) dx = 2 \ln \left| \frac{x-1}{x} \right| + \frac{1}{x} + C = -2 \ln|x| + \frac{1}{x} + 2 \ln|x-1| + C$
95. $\int \frac{\sin \theta d\theta}{\cos^2 \theta + \cos \theta - 2}; [\cos \theta = y] \rightarrow -\int \frac{dy}{y^2 + y - 2} = -\frac{1}{3} \int \frac{dy}{y-1} + \frac{1}{3} \int \frac{dy}{y+2} = \frac{1}{3} \ln \left| \frac{y+2}{y-1} \right| + C$
 $= \frac{1}{3} \ln \left| \frac{\cos \theta + 2}{\cos \theta - 1} \right| + C = -\frac{1}{3} \ln \left| \frac{\cos \theta - 1}{\cos \theta + 2} \right| + C$
96. $\int \frac{\cos \theta d\theta}{\sin^2 \theta + \sin \theta - 6}; [\sin \theta = x] \rightarrow \int \frac{dx}{x^2 + x - 6} = \frac{1}{5} \int \frac{dx}{x-2} - \frac{1}{5} \int \frac{dx}{x+3} = \frac{1}{5} \ln \left| \frac{\sin \theta - 2}{\sin \theta + 3} \right| + C$
97. $\int \frac{3x^2 + 4x + 4}{x^3 + x} dx = \int \frac{4}{x} dx - \int \frac{x-4}{x^2+1} dx = 4 \ln|x| - \frac{1}{2} \ln(x^2 + 1) + 4 \tan^{-1} x + C$
98. $\int \frac{4x dx}{x^3 + 4x} = \int \frac{4 dx}{x^2 + 4} = 2 \tan^{-1} \left(\frac{x}{2} \right) + C$
99. $\int \frac{(v+3) dv}{2v^3 - 8v} = \frac{1}{2} \int \left(-\frac{3}{4v} + \frac{5}{8(v-2)} + \frac{1}{8(v+2)} \right) dv = -\frac{3}{8} \ln|v| + \frac{5}{16} \ln|v-2| + \frac{1}{16} \ln|v+2| + C$
 $= \frac{1}{16} \ln \left| \frac{(v-2)^5(v+2)}{v^6} \right| + C$
100. $\int \frac{(3v-7) dv}{(v-1)(v-2)(v-3)} = \int \frac{(-2) dv}{v-1} + \int \frac{dv}{v-2} + \int \frac{dv}{v-3} = \ln \left| \frac{(v-2)(v-3)}{(v-1)^2} \right| + C$
101. $\int \frac{dt}{t^4 + 4t^2 + 3} = \frac{1}{2} \int \frac{dt}{t^2 + 1} - \frac{1}{2} \int \frac{dt}{t^2 + 3} = \frac{1}{2} \tan^{-1} t - \frac{1}{2\sqrt{3}} \tan^{-1} \left(\frac{t}{\sqrt{3}} \right) + C = \frac{1}{2} \tan^{-1} t - \frac{\sqrt{3}}{6} \tan^{-1} \frac{t}{\sqrt{3}} + C$
102. $\int \frac{t dt}{t^4 - t^2 - 2} = \frac{1}{3} \int \frac{t dt}{t^2 - 2} - \frac{1}{3} \int \frac{t dt}{t^2 + 1} = \frac{1}{6} \ln|t^2 - 2| - \frac{1}{6} \ln(t^2 + 1) + C$
103. $\int \frac{x^3 + x^2}{x^2 + x - 2} dx = \int \left(x + \frac{2x}{x^2 + x - 2} \right) dx = \int x dx + \frac{2}{3} \int \frac{dx}{x-1} + \frac{4}{3} \int \frac{dx}{x+2}$
 $= \frac{x^2}{2} + \frac{4}{3} \ln|x+2| + \frac{2}{3} \ln|x-1| + C$
104. $\int \frac{x^3 + 1}{x^3 - x} dx = \int \left(1 + \frac{x+1}{x^3 - x} \right) dx = \int \left[1 + \frac{1}{x(x-1)} \right] dx = \int dx + \int \frac{dx}{x-1} - \int \frac{dx}{x} = x + \ln|x-1| - \ln|x| + C$
105. $\int \frac{x^3 + 4x^2}{x^2 + 4x + 3} dx = \int \left(x - \frac{3x}{x^2 + 4x + 3} \right) dx = \int x dx + \frac{3}{2} \int \frac{dx}{x+1} - \frac{9}{2} \int \frac{dx}{x+3}$
 $= \frac{x^2}{2} - \frac{9}{2} \ln|x+3| + \frac{3}{2} \ln|x+1| + C$
106. $\int \frac{2x^3 + x^2 - 21x + 24}{x^2 + 2x - 8} dx = \int \left[(2x - 3) + \frac{x}{x^2 + 2x - 8} \right] dx = \int (2x - 3) dx + \frac{1}{3} \int \frac{dx}{x-2} + \frac{2}{3} \int \frac{dx}{x+4}$
 $= x^2 - 3x + \frac{2}{3} \ln|x+4| + \frac{1}{3} \ln|x-2| + C$
107. $\int \frac{dx}{x(3\sqrt{x+1})}; \left[\begin{array}{l} u = \sqrt{x+1} \\ du = \frac{dx}{2\sqrt{x+1}} \\ dx = 2u du \end{array} \right] \rightarrow \frac{2}{3} \int \frac{u du}{(u^2-1)u} = \frac{1}{3} \int \frac{du}{u-1} - \frac{1}{3} \int \frac{du}{u+1} = \frac{1}{3} \ln|u-1| - \frac{1}{3} \ln|u+1| + C$
 $= \frac{1}{3} \ln \left| \frac{\sqrt{x+1}-1}{\sqrt{x+1}+1} \right| + C$

$$108. \int \frac{dx}{x(1+\sqrt[3]{x})}; \left[\begin{array}{l} u = \sqrt[3]{x} \\ du = \frac{dx}{3x^{2/3}} \\ dx = 3u^2 du \end{array} \right] \rightarrow \int \frac{3u^2 du}{u^3(1+u)} = 3 \int \frac{du}{u(1+u)} = 3 \ln \left| \frac{u}{u+1} \right| + C = 3 \ln \left| \frac{\sqrt[3]{x}}{1+\sqrt[3]{x}} \right| + C$$

$$109. \int \frac{ds}{e^s-1}; \left[\begin{array}{l} u = e^s - 1 \\ du = e^s ds \\ ds = \frac{du}{u+1} \end{array} \right] \rightarrow \int \frac{du}{u(u+1)} = -\int \frac{du}{u+1} + \int \frac{du}{u} = \ln \left| \frac{u}{u+1} \right| + C = \ln \left| \frac{e^s-1}{e^s} \right| + C = \ln |1 - e^{-s}| + C$$

$$110. \int \frac{ds}{\sqrt{e^s+1}}; \left[\begin{array}{l} u = \sqrt{e^s+1} \\ du = \frac{e^s ds}{2\sqrt{e^s+1}} \\ ds = \frac{2u du}{u^2-1} \end{array} \right] \rightarrow \int \frac{2u du}{u(u^2-1)} = 2 \int \frac{du}{(u+1)(u-1)} = \int \frac{du}{u-1} - \int \frac{du}{u+1} = \ln \left| \frac{u-1}{u+1} \right| + C \\ = \ln \left| \frac{\sqrt{e^s+1}-1}{\sqrt{e^s+1}+1} \right| + C$$

$$111. (a) \int \frac{y dy}{\sqrt{16-y^2}} = -\frac{1}{2} \int \frac{d(16-y^2)}{\sqrt{16-y^2}} = -\sqrt{16-y^2} + C$$

$$(b) \int \frac{y dy}{\sqrt{16-y^2}}; [y = 4 \sin x] \rightarrow 4 \int \frac{\sin x \cos x dx}{\cos x} = -4 \cos x + C = -\frac{4\sqrt{16-y^2}}{4} + C = -\sqrt{16-y^2} + C$$

$$112. (a) \int \frac{x dx}{\sqrt{4+x^2}} = \frac{1}{2} \int \frac{d(4+x^2)}{\sqrt{4+x^2}} = \sqrt{4+x^2} + C$$

$$(b) \int \frac{x dx}{\sqrt{4+x^2}}; [x = 2 \tan y] \rightarrow \int \frac{2 \tan y \cdot 2 \sec^2 y dy}{2 \sec y} = 2 \int \sec y \tan y dy = 2 \sec y + C = \sqrt{4+x^2} + C$$

$$113. (a) \int \frac{x dx}{4-x^2} = -\frac{1}{2} \int \frac{d(4-x^2)}{4-x^2} = -\frac{1}{2} \ln |4-x^2| + C$$

$$(b) \int \frac{x dx}{4-x^2}; [x = 2 \sin \theta] \rightarrow \int \frac{2 \sin \theta \cdot 2 \cos \theta d\theta}{4 \cos^2 \theta} = \int \tan \theta d\theta = -\ln |\cos \theta| + C = -\ln \left(\frac{\sqrt{4-x^2}}{2} \right) + C \\ = -\frac{1}{2} \ln |4-x^2| + C$$

$$114. (a) \int \frac{t dt}{\sqrt{4t^2-1}} = \frac{1}{8} \int \frac{d(4t^2-1)}{\sqrt{4t^2-1}} = \frac{1}{4} \sqrt{4t^2-1} + C$$

$$(b) \int \frac{t dt}{\sqrt{4t^2-1}}; [t = \frac{1}{2} \sec \theta] \rightarrow \int \frac{\frac{1}{2} \sec \theta \tan \theta \cdot \frac{1}{2} \sec \theta d\theta}{\tan \theta} = \frac{1}{4} \int \sec^2 \theta d\theta = \frac{\tan \theta}{4} + C = \frac{\sqrt{4t^2-1}}{4} + C$$

$$115. \int \frac{x dx}{9-x^2}; \left[\begin{array}{l} u = 9-x^2 \\ du = -2x dx \end{array} \right] \rightarrow -\frac{1}{2} \int \frac{du}{u} = -\frac{1}{2} \ln |u| + C = \ln \frac{1}{\sqrt{u}} + C = \ln \frac{1}{\sqrt{9-x^2}} + C$$

$$116. \int \frac{dx}{x(9-x^2)} = \frac{1}{9} \int \frac{dx}{x} + \frac{1}{18} \int \frac{dx}{3-x} - \frac{1}{18} \int \frac{dx}{3+x} = \frac{1}{9} \ln |x| - \frac{1}{18} \ln |3-x| - \frac{1}{18} \ln |3+x| + C \\ = \frac{1}{9} \ln |x| - \frac{1}{18} \ln |9-x^2| + C$$

$$117. \int \frac{dx}{9-x^2} = \frac{1}{6} \int \frac{dx}{3-x} + \frac{1}{6} \int \frac{dx}{3+x} = -\frac{1}{6} \ln |3-x| + \frac{1}{6} \ln |3+x| + C = \frac{1}{6} \ln \left| \frac{x+3}{x-3} \right| + C$$

$$118. \int \frac{dx}{\sqrt{9-x^2}}; \left[\begin{array}{l} x = 3 \sin \theta \\ dx = 3 \cos \theta d\theta \end{array} \right] \rightarrow \int \frac{3 \cos \theta}{3 \cos \theta} d\theta = \int d\theta = \theta + C = \sin^{-1} \frac{x}{3} + C$$

$$119. \int \sin^3 x \cos^4 x dx = \int \cos^4 x (1 - \cos^2 x) \sin x dx = \int \cos^4 x \sin x dx - \int \cos^6 x \sin x dx = -\frac{\cos^5 x}{5} + \frac{\cos^7 x}{7} + C$$

$$120. \int \cos^5 x \sin^5 x dx = \int \sin^5 x \cos^4 x \cos x dx = \int \sin^5 x (1 - \sin^2 x)^2 \cos x dx \\ = \int \sin^5 x \cos x dx - 2 \int \sin^7 x \cos x dx + \int \sin^9 x \cos x dx = \frac{\sin^6 x}{6} - \frac{2 \sin^8 x}{8} + \frac{\sin^{10} x}{10} + C$$

121. $\int \tan^4 x \sec^2 x \, dx = \frac{\tan^5 x}{5} + C$

122. $\int \tan^3 x \sec^3 x \, dx = \int (\sec^2 x - 1) \sec^2 x \cdot \sec x \cdot \tan x \, dx = \int \sec^4 x \cdot \sec x \cdot \tan x \, dx - \int \sec^2 x \cdot \sec x \cdot \tan x \, dx$
 $= \frac{\sec^5 x}{5} - \frac{\sec^3 x}{3} + C$

123. $\int \sin 5\theta \cos 6\theta \, d\theta = \frac{1}{2} \int (\sin(-\theta) + \sin(11\theta)) \, d\theta = \frac{1}{2} \int \sin(-\theta) \, d\theta + \frac{1}{2} \int \sin(11\theta) \, d\theta = \frac{1}{2} \cos(-\theta) - \frac{1}{22} \cos 11\theta + C$
 $= \frac{1}{2} \cos \theta - \frac{1}{22} \cos 11\theta + C$

124. $\int \cos 3\theta \cos 3\theta \, d\theta = \frac{1}{2} \int (\cos 0 + \cos 6\theta) \, d\theta = \frac{1}{2} \int d\theta + \frac{1}{2} \int \cos 6\theta \, d\theta = \frac{1}{2} \theta + \frac{1}{12} \sin 6\theta + C$

125. $\int \sqrt{1 + \cos(\frac{1}{2}t)} \, dt = \int \sqrt{2} \left| \cos \frac{1}{4}t \right| \, dt = 4\sqrt{2} \left| \sin \frac{1}{4}t \right| + C$

126. $\int e^t \sqrt{\tan^2 e^t + 1} \, dt = \int |\sec e^t| e^t \, dt = \ln |\sec e^t + \tan e^t| + C$

127. $|E_s| \leq \frac{3-1}{180} (\Delta x)^4 M$ where $\Delta x = \frac{3-1}{n} = \frac{2}{n}$; $f(x) = \frac{1}{x} = x^{-1} \Rightarrow f'(x) = -x^{-2} \Rightarrow f''(x) = 2x^{-3} \Rightarrow f'''(x) = -6x^{-4}$
 $\Rightarrow f^{(4)}(x) = 24x^{-5}$ which is decreasing on $[1, 3] \Rightarrow$ maximum of $f^{(4)}(x)$ on $[1, 3]$ is $f^{(4)}(1) = 24 \Rightarrow M = 24$. Then
 $|E_s| \leq 0.0001 \Rightarrow \left(\frac{3-1}{180}\right) \left(\frac{2}{n}\right)^4 (24) \leq 0.0001 \Rightarrow \left(\frac{768}{180}\right) \left(\frac{1}{n^4}\right) \leq 0.0001 \Rightarrow \frac{1}{n^4} \leq (0.0001) \left(\frac{180}{768}\right) \Rightarrow n^4 \geq 10,000 \left(\frac{768}{180}\right)$
 $\Rightarrow n \geq 14.37 \Rightarrow n \geq 16$ (n must be even)

128. $|E_T| \leq \frac{1-0}{12} (\Delta x)^2 M$ where $\Delta x = \frac{1-0}{n} = \frac{1}{n}$; $0 \leq f''(x) \leq 8 \Rightarrow M = 8$. Then $|E_T| \leq 10^{-3} \Rightarrow \frac{1}{12} \left(\frac{1}{n}\right)^2 (8) \leq 10^{-3}$
 $\Rightarrow \frac{2}{3n^2} \leq 10^{-3} \Rightarrow \frac{3n^2}{2} \geq 1000 \Rightarrow n^2 \geq \frac{2000}{3} \Rightarrow n \geq 25.82 \Rightarrow n \geq 26$

129. $\Delta x = \frac{b-a}{n} = \frac{\pi-0}{6} = \frac{\pi}{6} \Rightarrow \frac{\Delta x}{2} = \frac{\pi}{12}$;
 $\sum_{i=0}^6 mf(x_i) = 12 \Rightarrow T = \left(\frac{\pi}{12}\right) (12) = \pi$;

	x_i	$f(x_i)$	m	$mf(x_i)$
x_0	0	0	1	0
x_1	$\pi/6$	1/2	2	1
x_2	$\pi/3$	3/2	2	3
x_3	$\pi/2$	2	2	4
x_4	$2\pi/3$	3/2	2	3
x_5	$5\pi/6$	1/2	2	1
x_6	π	0	1	0

$\sum_{i=0}^6 mf(x_i) = 18$ and $\frac{\Delta x}{3} = \frac{\pi}{18} \Rightarrow$
 $S = \left(\frac{\pi}{18}\right) (18) = \pi$.

	x_i	$f(x_i)$	m	$mf(x_i)$
x_0	0	0	1	0
x_1	$\pi/6$	1/2	4	2
x_2	$\pi/3$	3/2	2	3
x_3	$\pi/2$	2	4	8
x_4	$2\pi/3$	3/2	2	3
x_5	$5\pi/6$	1/2	4	2
x_6	π	0	1	0

130. $|f^{(4)}(x)| \leq 3 \Rightarrow M = 3$; $\Delta x = \frac{2-1}{n} = \frac{1}{n}$. Hence $|E_s| \leq 10^{-5} \Rightarrow \left(\frac{2-1}{180}\right) \left(\frac{1}{n}\right)^4 (3) \leq 10^{-5} \Rightarrow \frac{1}{60n^4} \leq 10^{-5} \Rightarrow n^4 \geq \frac{10^5}{60}$
 $\Rightarrow n \geq 6.38 \Rightarrow n \geq 8$ (n must be even)

131. $y_{av} = \frac{1}{365-0} \int_0^{365} [37 \sin\left(\frac{2\pi}{365}(x-101)\right) + 25] \, dx = \frac{1}{365} [-37 \left(\frac{365}{2\pi} \cos\left(\frac{2\pi}{365}(x-101)\right) + 25x\right)]_0^{365}$
 $= \frac{1}{365} [(-37 \left(\frac{365}{2\pi}\right) \cos\left[\frac{2\pi}{365}(365-101)\right] + 25(365)) - (-37 \left(\frac{365}{2\pi}\right) \cos\left[\frac{2\pi}{365}(0-101)\right] + 25(0))]$
 $= -\frac{37}{2\pi} \cos\left(\frac{2\pi}{365}(264)\right) + 25 + \frac{37}{2\pi} \cos\left(\frac{2\pi}{365}(-101)\right) = -\frac{37}{2\pi} (\cos\left(\frac{2\pi}{365}(264)\right) - \cos\left(\frac{2\pi}{365}(-101)\right)) + 25$

$$\approx -\frac{37}{2\pi} (0.16705 - 0.16705) + 25 = 25^\circ \text{F}$$

$$132. \text{av}(C_v) = \frac{1}{675-20} \int_{20}^{675} [8.27 + 10^{-5} (26T - 1.87T^2)] dT = \frac{1}{655} \left[8.27T + \frac{13}{10^6} T^2 - \frac{0.62333}{10^6} T^3 \right]_{20}^{675}$$

$$\approx \frac{1}{655} [(5582.25 + 59.23125 - 1917.03194) - (165.4 + 0.052 - 0.04987)] \approx 5.434;$$

$$8.27 + 10^{-5} (26T - 1.87T^2) = 5.434 \Rightarrow 1.87T^2 - 26T - 283,600 = 0 \Rightarrow T \approx \frac{26 + \sqrt{676 + 4(1.87)(283,600)}}{2(1.87)}$$

$$\approx 396.45^\circ \text{C}$$

133. (a) Each interval is 5 min = $\frac{1}{12}$ hour.
 $\frac{1}{24} [2.5 + 2(2.4) + 2(2.3) + \dots + 2(2.4) + 2.3] = \frac{29}{12} \approx 2.42$ gal
 (b) (60 mph) $\left(\frac{12}{29}$ hours/gal) ≈ 24.83 mi/gal

134. Using the Simpson's rule, $\Delta x = 15 \Rightarrow \frac{\Delta x}{3} = 5$;
 $\sum mf(x_i) = 1211.8 \Rightarrow \text{Area} \approx (1211.8)(5) = 6059 \text{ ft}^2$;
 The cost is $\text{Area} \cdot (\$2.10/\text{ft}^2) \approx (6059 \text{ ft}^2)(\$2.10/\text{ft}^2)$
 $= \$12,723.90 \Rightarrow$ the job cannot be done for \$11,000.

	x_i	$f(x_i)$	m	$mf(x_i)$
	x_0	0	1	0
	x_1	15	4	144
	x_2	30	2	108
	x_3	45	4	204
	x_4	60	2	99
	x_5	75	4	216
	x_6	90	2	128.8
	x_7	105	4	270
	x_8	120	1	42

$$135. \int_0^3 \frac{dx}{\sqrt{9-x^2}} = \lim_{b \rightarrow 3^-} \int_0^b \frac{dx}{\sqrt{9-x^2}} = \lim_{b \rightarrow 3^-} [\sin^{-1}(\frac{x}{3})]_0^b = \lim_{b \rightarrow 3^-} \sin^{-1}(\frac{b}{3}) - \sin^{-1}(\frac{0}{3}) = \frac{\pi}{2} - 0 = \frac{\pi}{2}$$

$$136. \int_0^1 \ln x dx = \lim_{b \rightarrow 0^+} [x \ln x - x]_b^1 = (1 \cdot \ln 1 - 1) - \lim_{b \rightarrow 0^+} [b \ln b - b] = -1 - \lim_{b \rightarrow 0^+} \frac{\ln b}{(\frac{1}{b})} = -1 - \lim_{b \rightarrow 0^+} \left(\frac{1}{b}\right)$$

$$= -1 + 0 = -1$$

$$137. \int_{-1}^1 \frac{dy}{y^{2/3}} = \int_{-1}^0 \frac{dy}{y^{2/3}} + \int_0^1 \frac{dy}{y^{2/3}} = 2 \int_0^1 \frac{dy}{y^{2/3}} = 2 \cdot 3 \lim_{b \rightarrow 0^+} [y^{1/3}]_b^1 = 6 \left(1 - \lim_{b \rightarrow 0^+} b^{1/3}\right) = 6$$

138. $\int_{-2}^{\infty} \frac{d\theta}{(\theta+1)^{3/5}} = \int_{-2}^{-1} \frac{d\theta}{(\theta+1)^{3/5}} + \int_{-1}^2 \frac{d\theta}{(\theta+1)^{3/5}} + \int_2^{\infty} \frac{d\theta}{(\theta+1)^{3/5}}$ converges if each integral converges, but
 $\lim_{\theta \rightarrow \infty} \frac{\theta^{3/5}}{(\theta+1)^{3/5}} = 1$ and $\int_2^{\infty} \frac{d\theta}{\theta^{3/5}}$ diverges $\Rightarrow \int_{-2}^{\infty} \frac{d\theta}{(\theta+1)^{3/5}}$ diverges

$$139. \int_3^{\infty} \frac{2 du}{u^2-2u} = \int_3^{\infty} \frac{du}{u-2} - \int_3^{\infty} \frac{du}{u} = \lim_{b \rightarrow \infty} [\ln | \frac{u-2}{u} |]_3^b = \lim_{b \rightarrow \infty} [\ln | \frac{b-2}{b} |] - \ln | \frac{3-2}{3} | = 0 - \ln(\frac{1}{3}) = \ln 3$$

$$140. \int_1^{\infty} \frac{3v-1}{4v^3-v^2} dv = \int_1^{\infty} \left(\frac{1}{v} + \frac{1}{v^2} - \frac{4}{4v-1}\right) dv = \lim_{b \rightarrow \infty} \left[\ln v - \frac{1}{v} - \ln(4v-1)\right]_1^b$$

$$= \lim_{b \rightarrow \infty} \left[\ln\left(\frac{b}{4b-1}\right) - \frac{1}{b}\right] - (\ln 1 - 1 - \ln 3) = \ln \frac{1}{4} + 1 + \ln 3 = 1 + \ln \frac{3}{4}$$

$$141. \int_0^{\infty} x^2 e^{-x} dx = \lim_{b \rightarrow \infty} [-x^2 e^{-x} - 2x e^{-x} - 2e^{-x}]_0^b = \lim_{b \rightarrow \infty} (-b^2 e^{-b} - 2b e^{-b} - 2e^{-b}) - (-2) = 0 + 2 = 2$$

$$142. \int_{-\infty}^0 x e^{3x} dx = \lim_{b \rightarrow -\infty} \left[\frac{x}{3} e^{3x} - \frac{1}{9} e^{3x}\right]_b^0 = -\frac{1}{9} - \lim_{b \rightarrow -\infty} \left(\frac{b}{3} e^{3b} - \frac{1}{9} e^{3b}\right) = -\frac{1}{9} - 0 = -\frac{1}{9}$$

$$143. \int_{-\infty}^{\infty} \frac{dx}{4x^2+9} = 2 \int_0^{\infty} \frac{dx}{4x^2+9} = \frac{1}{2} \int_0^{\infty} \frac{dx}{x^2+\frac{9}{4}} = \frac{1}{2} \lim_{b \rightarrow \infty} \left[\frac{2}{3} \tan^{-1}\left(\frac{2x}{3}\right)\right]_0^b = \frac{1}{2} \lim_{b \rightarrow \infty} \left[\frac{2}{3} \tan^{-1}\left(\frac{2b}{3}\right)\right] - \frac{1}{3} \tan^{-1}(0)$$

$$= \frac{1}{2} \left(\frac{2}{3} \cdot \frac{\pi}{2} \right) - 0 = \frac{\pi}{6}$$

$$144. \int_{-\infty}^{\infty} \frac{4 \, dx}{x^2+16} = 2 \int_0^{\infty} \frac{4 \, dx}{x^2+16} = 2 \lim_{b \rightarrow \infty} \left[\tan^{-1} \left(\frac{x}{4} \right) \right]_0^b = 2 \left(\lim_{b \rightarrow \infty} \left[\tan^{-1} \left(\frac{b}{4} \right) \right] - \tan^{-1}(0) \right) = 2 \left(\frac{\pi}{2} \right) - 0 = \pi$$

$$145. \lim_{\theta \rightarrow \infty} \frac{\theta}{\sqrt{\theta^2+1}} = 1 \text{ and } \int_6^{\infty} \frac{d\theta}{\theta} \text{ diverges} \Rightarrow \int_6^{\infty} \frac{d\theta}{\sqrt{\theta^2+1}} \text{ diverges}$$

$$146. I = \int_0^{\infty} e^{-u} \cos u \, du = \lim_{b \rightarrow \infty} \left[-e^{-u} \cos u \right]_0^b - \int_0^{\infty} e^{-u} \sin u \, du = 1 + \lim_{b \rightarrow \infty} \left[e^{-u} \sin u \right]_0^b - \int_0^{\infty} (e^{-u}) \cos u \, du \\ \Rightarrow I = 1 + 0 - I \Rightarrow 2I = 1 \Rightarrow I = \frac{1}{2} \text{ converges}$$

$$147. \int_1^{\infty} \frac{\ln z}{z} \, dz = \int_1^e \frac{\ln z}{z} \, dz + \int_e^{\infty} \frac{\ln z}{z} \, dz = \left[\frac{(\ln z)^2}{2} \right]_1^e + \lim_{b \rightarrow \infty} \left[\frac{(\ln z)^2}{2} \right]_e^b = \left(\frac{1^2}{2} - 0 \right) + \lim_{b \rightarrow \infty} \left[\frac{(\ln b)^2}{2} - \frac{1}{2} \right] \\ = \infty \Rightarrow \text{diverges}$$

$$148. 0 < \frac{e^{-t}}{\sqrt{t}} \leq e^{-t} \text{ for } t \geq 1 \text{ and } \int_1^{\infty} e^{-t} \, dt \text{ converges} \Rightarrow \int_1^{\infty} \frac{e^{-t}}{\sqrt{t}} \, dt \text{ converges}$$

$$149. \int_{-\infty}^{\infty} \frac{2 \, dx}{e^x+e^{-x}} = 2 \int_0^{\infty} \frac{2 \, dx}{e^x+e^{-x}} < \int_0^{\infty} \frac{4 \, dx}{e^x} \text{ converges} \Rightarrow \int_{-\infty}^{\infty} \frac{2 \, dx}{e^x+e^{-x}} \text{ converges}$$

$$150. \int_{-\infty}^{\infty} \frac{dx}{x^2(1+e^x)} = \int_{-\infty}^{-1} \frac{dx}{x^2(1+e^x)} + \int_{-1}^0 \frac{dx}{x^2(1+e^x)} + \int_0^1 \frac{dx}{x^2(1+e^x)} + \int_1^{\infty} \frac{dx}{x^2(1+e^x)}; \\ \lim_{x \rightarrow 0} \frac{\left(\frac{1}{x^2} \right)}{\left[\frac{1}{x^2(1+e^x)} \right]} = \lim_{x \rightarrow 0} \frac{x^2(1+e^x)}{x^2} = \lim_{x \rightarrow 0} (1+e^x) = 2 \text{ and } \int_0^1 \frac{dx}{x^2} \text{ diverges} \Rightarrow \int_0^1 \frac{dx}{x^2(1+e^x)} \text{ diverges} \\ \Rightarrow \int_{-\infty}^{\infty} \frac{dx}{x^2(1+e^x)} \text{ diverges}$$

$$151. \int \frac{x \, dx}{1+\sqrt{x}}; \left[\begin{array}{l} u = \sqrt{x} \\ du = \frac{dx}{2\sqrt{x}} \end{array} \right] \rightarrow \int \frac{u^2 \cdot 2u \, du}{1+u} = \int (2u^2 - 2u + 2 - \frac{2}{1+u}) \, du = \frac{2}{3} u^3 - u^2 + 2u - 2 \ln |1+u| + C \\ = \frac{2x^{3/2}}{3} - x + 2\sqrt{x} - 2 \ln(1 + \sqrt{x}) + C$$

$$152. \int \frac{x^3+2}{4-x^2} \, dx = - \int \left(x + \frac{4x+2}{x^2-4} \right) \, dx = - \int x \, dx - \frac{3}{2} \int \frac{dx}{x+2} - \frac{5}{2} \int \frac{dx}{x-2} = - \frac{x^2}{2} - \frac{3}{2} \ln |x+2| - \frac{5}{2} \ln |x-2| + C$$

$$153. \int \frac{dx}{x(x^2+1)^2}; \left[\begin{array}{l} x = \tan \theta \\ dx = \sec^2 \theta \, d\theta \end{array} \right] \rightarrow \int \frac{\sec^2 \theta \, d\theta}{\tan \theta \sec^4 \theta} = \int \frac{\cos^3 \theta \, d\theta}{\sin \theta} = \int \left(\frac{1-\sin^2 \theta}{\sin \theta} \right) d(\sin \theta) \\ = \ln |\sin \theta| - \frac{1}{2} \sin^2 \theta + C = \ln \left| \frac{x}{\sqrt{x^2+1}} \right| - \frac{1}{2} \left(\frac{x}{\sqrt{x^2+1}} \right)^2 + C$$

$$154. \int \frac{\cos \sqrt{x}}{\sqrt{x}} \, dx; \left[\begin{array}{l} u = \sqrt{x} \\ du = \frac{dx}{2\sqrt{x}} \end{array} \right] \rightarrow \int \frac{\cos u \cdot 2u \, du}{u} = 2 \int \cos u \, du = 2 \sin u + C = 2 \sin \sqrt{x} + C$$

$$155. \int \frac{dx}{\sqrt{-2x-x^2}} = \int \frac{d(x+1)}{\sqrt{1-(x+1)^2}} = \sin^{-1}(x+1) + C$$

$$156. \int \frac{(t-1) \, dt}{\sqrt{t^2-2t}}; \left[\begin{array}{l} u = t^2-2t \\ du = (2t-2) \, dt = 2(t-1) \, dt \end{array} \right] \rightarrow \frac{1}{2} \int \frac{du}{\sqrt{u}} = \sqrt{u} + C = \sqrt{t^2-2t} + C$$

$$157. \int \frac{du}{\sqrt{1+u^2}}; [u = \tan \theta] \rightarrow \int \frac{\sec^2 \theta \, d\theta}{\sec \theta} = \ln |\sec \theta + \tan \theta| + C = \ln \left| \sqrt{1+u^2} + u \right| + C$$

$$158. \int e^t \cos e^t dt = \sin e^t + C$$

$$159. \int \frac{2 - \cos x + \sin x}{\sin^2 x} dx = \int 2 \csc^2 x dx - \int \frac{\cos x dx}{\sin^2 x} + \int \csc x dx = -2 \cot x + \frac{1}{\sin x} - \ln |\csc x + \cot x| + C \\ = -2 \cot x + \csc x - \ln |\csc x + \cot x| + C$$

$$160. \int \frac{\sin^2 \theta}{\cos^2 \theta} d\theta = \int \frac{1 - \cos^2 \theta}{\cos^2 \theta} d\theta = \int \sec^2 \theta d\theta - \int d\theta = \tan \theta - \theta + C$$

$$161. \int \frac{9 dv}{81 - v^4} = \frac{1}{2} \int \frac{dv}{v^2 + 9} + \frac{1}{12} \int \frac{dv}{3 - v} + \frac{1}{12} \int \frac{dv}{3 + v} = \frac{1}{12} \ln \left| \frac{3+v}{3-v} \right| + \frac{1}{6} \tan^{-1} \frac{v}{3} + C$$

$$162. \int \frac{\cos x dx}{1 + \sin^2 x} = \int \frac{d(\sin x)}{1 + \sin^2 x} = \tan^{-1}(\sin x) + C$$

$$163. \qquad \qquad \qquad \cos(2\theta + 1)$$

$$\theta \xrightarrow{(+)} \frac{1}{2} \sin(2\theta + 1)$$

$$1 \xrightarrow{(-)} -\frac{1}{4} \cos(2\theta + 1)$$

$$0 \qquad \qquad \qquad \Rightarrow \int \theta \cos(2\theta + 1) d\theta = \frac{\theta}{2} \sin(2\theta + 1) + \frac{1}{4} \cos(2\theta + 1) + C$$

$$164. \int_2^\infty \frac{dx}{(x-1)^2} = \lim_{b \rightarrow \infty} \left[\frac{1}{1-x} \right]_2^b = \lim_{b \rightarrow \infty} \left[\frac{1}{1-b} - (-1) \right] = 0 + 1 = 1$$

$$165. \int \frac{x^3 dx}{x^2 - 2x + 1} = \int \left(x + 2 + \frac{3x-2}{x^2-2x+1} \right) dx = \int (x+2) dx + 3 \int \frac{dx}{x-1} + \int \frac{dx}{(x-1)^2} \\ = \frac{x^2}{2} + 2x + 3 \ln |x-1| - \frac{1}{x-1} + C$$

$$166. \int \frac{d\theta}{\sqrt{1+\sqrt{\theta}}} ; \left[\begin{array}{l} x = 1 + \sqrt{\theta} \\ dx = \frac{d\theta}{2\sqrt{\theta}} \\ d\theta = 2(x-1) dx \end{array} \right] \rightarrow \int \frac{2(x-1) dx}{\sqrt{x}} = 2 \int \sqrt{x} dx - 2 \int \frac{dx}{\sqrt{x}} = \frac{4}{3} x^{3/2} - 4x^{1/2} + C \\ = \frac{4}{3} (1 + \sqrt{\theta})^{3/2} - 4(1 + \sqrt{\theta})^{1/2} + C = 4 \left[\frac{(\sqrt{1+\sqrt{\theta}})^3}{3} - \sqrt{1+\sqrt{\theta}} \right] + C$$

$$167. \int \frac{2 \sin \sqrt{x} dx}{\sqrt{x} \sec \sqrt{x}} ; \left[\begin{array}{l} y = \sqrt{x} \\ dy = \frac{dx}{2\sqrt{x}} \end{array} \right] \rightarrow \int \frac{2 \sin y \cdot 2y dy}{y \sec y} = \int 2 \sin 2y dy = -\cos(2y) + C = -\cos(2\sqrt{x}) + C$$

$$168. \int \frac{x^5 dx}{x^4 - 16} = \int \left(x + \frac{16x}{x^4 - 16} \right) dx = \frac{x^2}{2} + \int \left(\frac{2x}{x^2 - 4} - \frac{2x}{x^2 + 4} \right) dx = \frac{x^2}{2} + \ln \left| \frac{x^2 - 4}{x^2 + 4} \right| + C$$

$$169. \int \frac{dy}{\sin y \cos y} = \int \frac{2 dy}{\sin 2y} = \int 2 \csc(2y) dy = -\ln |\csc(2y) + \cot(2y)| + C$$

$$170. \int \frac{d\theta}{\theta^2 - 2\theta + 4} = \int \frac{d\theta}{(\theta-1)^2 + 3} = \frac{\sqrt{3}}{3} \tan^{-1} \left(\frac{\theta-1}{\sqrt{3}} \right) + C$$

$$171. \int \frac{\tan x}{\cos^2 x} dx = \int \tan x \sec^2 x dx = \int \tan x \cdot d(\tan x) = \frac{1}{2} \tan^2 x + C$$

$$172. \int \frac{dr}{(r+1)\sqrt{r^2+2r}} = \int \frac{d(r+1)}{(r+1)\sqrt{(r+1)^2-1}} = \sec^{-1} |r+1| + C$$

$$173. \int \frac{(r+2) dr}{\sqrt{-r^2-4r}} = \int \frac{(r+2) dr}{\sqrt{4-(r+2)^2}}; \left[\begin{array}{l} u = 4 - (r+2)^2 \\ du = -2(r+2) dr \end{array} \right] \rightarrow -\int \frac{du}{2\sqrt{u}} = -\sqrt{u} + C = -\sqrt{4-(r+2)^2} + C$$

$$174. \int \frac{y dy}{4+y^4} = \frac{1}{2} \int \frac{d(y^2)}{4+(y^2)^2} = \frac{1}{4} \tan^{-1} \left(\frac{y^2}{2} \right) + C$$

$$175. \int \frac{\sin 2\theta d\theta}{(1+\cos 2\theta)^2} = -\frac{1}{2} \int \frac{d(1+\cos 2\theta)}{(1+\cos 2\theta)^2} = \frac{1}{2(1+\cos 2\theta)} + C = \frac{1}{4} \sec^2 \theta + C$$

$$176. \int \frac{dx}{(x^2-1)^2} = \int \frac{dx}{(1-x^2)^2} = \frac{x}{2(1-x^2)} + \frac{1}{4} \ln \left| \frac{x+1}{x-1} \right| + C \text{ (FORMULA 19)}$$

$$177. \int_{\pi/4}^{\pi/2} \sqrt{1+\cos 4x} dx = -\sqrt{2} \int_{\pi/4}^{\pi/2} \cos 2x dx = \left[-\frac{\sqrt{2}}{2} \sin 2x \right]_{\pi/4}^{\pi/2} = \frac{\sqrt{2}}{2}$$

$$178. \int (15)^{2x+1} dx = \frac{1}{2} \int (15)^{2x+1} d(2x+1) = \frac{1}{2} \left(\frac{15^{2x+1}}{\ln 15} \right) + C$$

$$179. \int \frac{x dx}{\sqrt{2-x}}; \left[\begin{array}{l} y = 2-x \\ dy = -dx \end{array} \right] \rightarrow -\int \frac{(2-y) dy}{\sqrt{y}} = \frac{2}{3} y^{3/2} - 4y^{1/2} + C = \frac{2}{3} (2-x)^{3/2} - 4(2-x)^{1/2} + C \\ = 2 \left[\frac{(\sqrt{2-x})^3}{3} - 2\sqrt{2-x} \right] + C$$

$$180. \int \frac{\sqrt{1-v^2}}{v^2} dv; [v = \sin \theta] \rightarrow \int \frac{\cos \theta \cdot \cos \theta d\theta}{\sin^2 \theta} = \int \frac{(1-\sin^2 \theta) d\theta}{\sin^2 \theta} = \int \csc^2 \theta d\theta - \int d\theta = \cot \theta - \theta + C \\ = -\sin^{-1} v - \frac{\sqrt{1-v^2}}{v} + C$$

$$181. \int \frac{dy}{y^2-2y+2} = \int \frac{d(y-1)}{(y-1)^2+1} = \tan^{-1} (y-1) + C$$

$$182. \int \ln \sqrt{x-1} dx; \left[\begin{array}{l} y = \sqrt{x-1} \\ dy = \frac{dx}{2\sqrt{x-1}} \end{array} \right] \rightarrow \int \ln y \cdot 2y dy; u = \ln y, du = \frac{dy}{y}; dv = 2y dy, v = y^2 \\ \Rightarrow \int 2y \ln y dy = y^2 \ln y - \int y dy = y^2 \ln y - \frac{1}{2} y^2 + C = (x-1) \ln \sqrt{x-1} - \frac{1}{2} (x-1) + C_1 \\ = \frac{1}{2} [(x-1) \ln |x-1| - x] + (C_1 + \frac{1}{2}) = \frac{1}{2} [x \ln |x-1| - x - \ln |x-1|] + C$$

$$183. \int \theta^2 \tan(\theta^3) d\theta = \frac{1}{3} \int \tan(\theta^3) d(\theta^3) = \frac{1}{3} \ln |\sec \theta^3| + C$$

$$184. \int \frac{x dx}{\sqrt{8-2x^2-x^4}} = \frac{1}{2} \int \frac{d(x^2+1)}{\sqrt{9-(x^2+1)^2}} = \frac{1}{2} \sin^{-1} \left(\frac{x^2+1}{3} \right) + C$$

$$185. \int \frac{z+1}{z^2(z^2+4)} dz = \frac{1}{4} \int \left(\frac{1}{z} + \frac{1}{z^2} - \frac{z+1}{z^2+4} \right) dz = \frac{1}{4} \ln |z| - \frac{1}{4z} - \frac{1}{8} \ln(z^2+4) - \frac{1}{8} \tan^{-1} \frac{z}{2} + C$$

$$186. \int x^3 e^{x^2} dx = \frac{1}{2} \int x^2 e^{x^2} d(x^2) = \frac{1}{2} (x^2 e^{x^2} - e^{x^2}) + C = \frac{(x^2-1)e^{x^2}}{2} + C$$

$$187. \int \frac{t dt}{\sqrt{9-4t^2}} = -\frac{1}{8} \int \frac{d(9-4t^2)}{\sqrt{9-4t^2}} = -\frac{1}{4} \sqrt{9-4t^2} + C$$

$$188. \int_0^{\pi/10} \sqrt{1+\cos 5\theta} d\theta = \sqrt{2} \int_0^{\pi/10} \cos \left(\frac{5\theta}{2} \right) d\theta = \frac{2\sqrt{2}}{5} \left[\sin \left(\frac{5\theta}{2} \right) \right]_0^{\pi/10} = \frac{2\sqrt{2}}{5} (\sin \frac{\pi}{4} - 0) = \frac{2}{5}$$

$$189. \int \frac{\cot \theta \, d\theta}{1 + \sin^2 \theta} = \int \frac{\cos \theta \, d\theta}{(\sin \theta)(1 + \sin^2 \theta)}; \left[\begin{array}{l} x = \sin \theta \\ dx = \cos \theta \, d\theta \end{array} \right] \rightarrow \int \frac{dx}{x(1+x^2)} = \int \frac{dx}{x} - \int \frac{x \, dx}{x^2+1} \\ = \ln |\sin \theta| - \frac{1}{2} \ln (1 + \sin^2 \theta) + C$$

$$190. u = \tan^{-1} x, du = \frac{dx}{1+x^2}; dv = \frac{dx}{x^2}, v = -\frac{1}{x}; \\ \int \frac{\tan^{-1} x \, dx}{x^2} = -\frac{1}{x} \tan^{-1} x + \int \frac{dx}{x(1+x^2)} = -\frac{1}{x} \tan^{-1} x + \int \frac{dx}{x} - \int \frac{x \, dx}{1+x^2} \\ = -\frac{1}{x} \tan^{-1} x + \ln |x| - \frac{1}{2} \ln (1 + x^2) + C = -\frac{\tan^{-1} x}{x} + \ln |x| - \ln \sqrt{1+x^2} + C$$

$$191. \int \frac{\tan \sqrt{y} \, dy}{2\sqrt{y}}; [\sqrt{y} = x] \rightarrow \int \frac{\tan x \cdot 2x \, dx}{2x} = \ln |\sec x| + C = \ln |\sec \sqrt{y}| + C$$

$$192. \int \frac{e^t \, dt}{e^{2t} + 3e^t + 2}; [e^t = x] \rightarrow \int \frac{dx}{(x+1)(x+2)} = \int \frac{dx}{x+1} - \int \frac{dx}{x+2} = \ln |x+1| - \ln |x+2| + C \\ = \ln \left| \frac{x+1}{x+2} \right| + C = \ln \left(\frac{e^t+1}{e^t+2} \right) + C$$

$$193. \int \frac{\theta^2 \, d\theta}{4-\theta^2} = \int \left(-1 + \frac{4}{4-\theta^2} \right) d\theta = -\int d\theta - \int \frac{d\theta}{\theta-2} + \int \frac{d\theta}{\theta+2} = -\theta - \ln |\theta-2| + \ln |\theta+2| + C \\ = -\theta + \ln \left| \frac{\theta+2}{\theta-2} \right| + C$$

$$194. \int \frac{1-\cos 2x}{1+\cos 2x} dx = \int \tan^2 x \, dx = \int (\sec^2 x - 1) dx = \tan x - x + C$$

$$195. \int \frac{\cos(\sin^{-1} x) \, dx}{\sqrt{1-x^2}}; \left[\begin{array}{l} u = \sin^{-1} x \\ du = \frac{dx}{\sqrt{1-x^2}} \end{array} \right] \rightarrow \int \cos u \, du = \sin u + C = \sin(\sin^{-1} x) + C = x + C$$

$$196. \int \frac{\cos x \, dx}{\sin^3 x - \sin x} = -\int \frac{\cos x \, dx}{(\sin x)(1-\sin^2 x)} = -\int \frac{\cos x \, dx}{(\sin x)(\cos^2 x)} = -\int \frac{2 \, dx}{\sin 2x} = -2 \int \csc 2x \, dx \\ = \ln |\csc(2x) + \cot(2x)| + C$$

$$197. \int \sin \frac{x}{2} \cos \frac{x}{2} \, dx = \int \frac{1}{2} \sin \left(\frac{x}{2} + \frac{x}{2} \right) dx = \frac{1}{2} \int \sin x \, dx = -\frac{1}{2} \cos x + C$$

$$198. \int \frac{x^2-x+2}{(x^2+2)^2} dx = \int \frac{dx}{x^2+2} - \int \frac{x \, dx}{(x^2+2)^2} = \frac{1}{\sqrt{2}} \tan^{-1} \left(\frac{x}{\sqrt{2}} \right) + \frac{1}{2} (x^2+2)^{-1} + C \\ = \frac{1}{\sqrt{2}} \tan^{-1} \left(\frac{x}{\sqrt{2}} \right) + \frac{1}{2(x^2+2)} + C$$

$$199. \int \frac{e^t \, dt}{1+e^t} = \ln(1+e^t) + C$$

$$200. \int \tan^3 t \, dt = \int (\tan t)(\sec^2 t - 1) dt = \frac{\tan^2 t}{2} - \int \tan t \, dt = \frac{\tan^2 t}{2} - \ln |\sec t| + C$$

$$201. \int_1^\infty \frac{\ln y \, dy}{y^3}; \left[\begin{array}{l} x = \ln y \\ dx = \frac{dy}{y} \\ dy = e^x \, dx \end{array} \right] \rightarrow \int_0^\infty \frac{x \cdot e^x}{e^{3x}} dx = \int_0^\infty x e^{-2x} dx = \lim_{b \rightarrow \infty} \left[-\frac{x}{2} e^{-2x} - \frac{1}{4} e^{-2x} \right]_0^b \\ = \lim_{b \rightarrow \infty} \left(\frac{-b}{2e^{2b}} - \frac{1}{4e^{2b}} \right) - \left(0 - \frac{1}{4} \right) = \frac{1}{4}$$

$$202. \int \frac{3 + \sec^2 x + \sin x}{\tan x} dx = 3 \int \cot x \, dx + \int \frac{\sec^2 x \, dx}{\tan x} + \int \cos x \, dx = 3 \ln |\sin x| + \ln |\tan x| + \sin x + C$$

$$203. \int \frac{\cot v \, dv}{\ln(\sin v)} = \int \frac{\cos v \, dv}{(\sin v) \ln(\sin v)}; \left[\begin{array}{l} u = \ln(\sin v) \\ du = \frac{\cos v \, dv}{\sin v} \end{array} \right] \rightarrow \int \frac{du}{u} = \ln |u| + C = \ln |\ln(\sin v)| + C$$

$$204. \int \frac{dx}{(2x-1)\sqrt{x^2-x}} = \int \frac{2dx}{(2x-1)\sqrt{4x^2-4x}} = \int \frac{2dx}{(2x-1)\sqrt{(2x-1)^2-1}}; \left[\begin{array}{l} u = 2x-1 \\ du = 2dx \end{array} \right] \rightarrow \int \frac{du}{u\sqrt{u^2-1}} \\ = \sec^{-1} |u| + C = \sec^{-1} |2x-1| + C$$

$$205. \int e^{\ln \sqrt{x}} dx = \int \sqrt{x} dx = \frac{2}{3} x^{3/2} + C$$

$$206. \int e^{\theta} \sqrt{3+4e^{\theta}} d\theta; \left[\begin{array}{l} u = 4e^{\theta} \\ du = 4e^{\theta} d\theta \end{array} \right] \rightarrow \frac{1}{4} \int \sqrt{3+u} du = \frac{1}{4} \cdot \frac{2}{3} (3+u)^{3/2} + C = \frac{1}{6} (3+4e^{\theta})^{3/2} + C$$

$$207. \int \frac{\sin 5t dt}{1+(\cos 5t)^2}; \left[\begin{array}{l} u = \cos 5t \\ du = -5 \sin 5t dt \end{array} \right] \rightarrow -\frac{1}{5} \int \frac{du}{1+u^2} = -\frac{1}{5} \tan^{-1} u + C = -\frac{1}{5} \tan^{-1} (\cos 5t) + C$$

$$208. \int \frac{dv}{\sqrt{e^{2v}-1}}; \left[\begin{array}{l} x = e^v \\ dx = e^v dv \end{array} \right] \rightarrow \int \frac{dx}{x\sqrt{x^2-1}} = \sec^{-1} x + C = \sec^{-1} (e^v) + C$$

$$209. \int (27)^{3\theta+1} d\theta = \frac{1}{3} \int (27)^{3\theta+1} d(3\theta+1) = \frac{1}{3 \ln 27} (27)^{3\theta+1} + C = \frac{1}{3} \left(\frac{27^{3\theta+1}}{\ln 27} \right) + C$$

$$210. \begin{array}{r} \sin x \\ x^5 \xrightarrow{(+)} -\cos x \\ 5x^4 \xrightarrow{(-)} -\sin x \\ 20x^3 \xrightarrow{(+)} \cos x \\ 60x^2 \xrightarrow{(-)} \sin x \\ 120x \xrightarrow{(+)} -\cos x \\ 120 \xrightarrow{(-)} -\sin x \\ 0 \end{array} \Rightarrow \int x^5 \sin x dx = -x^5 \cos x + 5x^4 \sin x + 20x^3 \cos x - 60x^2 \sin x - 120x \cos x + 120 \sin x + C$$

$$211. \int \frac{dr}{1+\sqrt{r}}; \left[\begin{array}{l} u = \sqrt{r} \\ du = \frac{dr}{2\sqrt{r}} \end{array} \right] \rightarrow \int \frac{2u du}{1+u} = \int (2 - \frac{2}{1+u}) du = 2u - 2 \ln |1+u| + C = 2\sqrt{r} - 2 \ln (1 + \sqrt{r}) + C$$

$$212. \int \frac{4x^3-20x}{x^4-10x^2+9} dx = \int \frac{d(x^4-10x^2+9)}{x^4-10x^2+9} = \ln |x^4-10x^2+9| + C$$

$$213. \int \frac{8 dy}{y^3(y+2)} = \int \frac{dy}{y} - \int \frac{2 dy}{y^2} + \int \frac{4 dy}{y^3} - \int \frac{dy}{(y+2)} = \ln \left| \frac{y}{y+2} \right| + \frac{2}{y} - \frac{2}{y^2} + C$$

$$214. \int \frac{(t+1) dt}{(t^2+2t)^{2/3}}; \left[\begin{array}{l} u = t^2+2t \\ du = 2(t+1) dt \end{array} \right] \rightarrow \frac{1}{2} \int \frac{du}{u^{2/3}} = \frac{1}{2} \cdot 3u^{1/3} + C = \frac{3}{2} (t^2+2t)^{1/3} + C$$

$$215. \int \frac{8 dm}{m\sqrt{49m^2-4}} = \frac{8}{7} \int \frac{dm}{m\sqrt{m^2-(\frac{2}{7})^2}} = 4 \sec^{-1} \left| \frac{7m}{2} \right| + C$$

$$216. \int \frac{dt}{(1+\ln t)\sqrt{(\ln t)(2+\ln t)}}; \left[\begin{array}{l} u = \ln t \\ du = \frac{dt}{t} \end{array} \right] \rightarrow \int \frac{du}{(1+u)\sqrt{u(2+u)}} = \int \frac{du}{(u+1)\sqrt{(u+1)^2-1}} \\ = \sec^{-1} |u+1| + C = \sec^{-1} |\ln t + 1| + C$$

217. If $u = \int_0^x \sqrt{1 + (t-1)^4} dt$ and $dv = 3(x-1)^2 dx$, then $du = \sqrt{1 + (x-1)^4} dx$, and $v = (x-1)^3$ so integration by parts $\Rightarrow \int_0^1 3(x-1)^2 \left[\int_0^x \sqrt{1 + (t-1)^4} dt \right] dx = \left[(x-1)^3 \int_0^x \sqrt{1 + (t-1)^4} dt \right]_0^1 - \int_0^1 (x-1)^3 \sqrt{1 + (x-1)^4} dx = \left[-\frac{1}{6} (1 + (x-1)^4)^{3/2} \right]_0^1 = \frac{\sqrt{8}-1}{6}$

218. $\frac{4v^3 + v - 1}{v^2(v-1)(v^2+1)} = \frac{A}{v} + \frac{B}{v^2} + \frac{C}{v-1} + \frac{Dv+E}{v^2+1} \Rightarrow 4v^3 + v - 1 = Av(v-1)(v^2+1) + B(v-1)(v^2+1) + Cv^2(v^2+1) + (Dv+E)(v^2)(v-1)$
 $v = 0: -1 = -B \Rightarrow B = 1;$
 $v = 1: 4 = 2C \Rightarrow C = 2;$
 coefficient of $v^4: 0 = A + C + D \Rightarrow A + D = -2;$
 coefficient of $v^3: 4 = -A + B + E - D$
 coefficient of $v^2: 0 = A - B + C - E \Rightarrow C - D = 4 \Rightarrow D = -2$ (summing with previous equation);
 coefficient of $v: 1 = -A + B \Rightarrow A = 0;$
 in summary: $A = 0, B = 1, C = 2, D = -2$ and $E = 1$
 $\Rightarrow \int_2^\infty \frac{4v^3 + v - 1}{v^2(v-1)(v^2+1)} dv = \lim_{b \rightarrow \infty} \int_2^b \left(\frac{2}{v-1} + v^{-2} + \frac{1}{1+v^2} - \frac{2v}{1+v^2} \right) dv$
 $= \lim_{b \rightarrow \infty} \left[\ln(v-1)^2 - \frac{1}{v} + \tan^{-1} v - \ln(1+v^2) \right]_2^b$
 $= \lim_{b \rightarrow \infty} \left[\ln \left(\frac{(b-1)^2}{1+b^2} \right) - \frac{1}{b} + \tan^{-1} b \right] - \left(\ln 1 - \frac{1}{2} + \tan^{-1} 2 - \ln 5 \right) = \left(0 - 0 + \frac{\pi}{2} \right) - \left(0 - \frac{1}{2} + \tan^{-1} 2 - \ln 5 \right)$
 $= \frac{\pi}{2} + \ln(5) + \frac{1}{2} - \tan^{-1} 2$

219. $u = f(x), du = f'(x) dx; dv = dx, v = x;$
 $\int_{\pi/2}^{3\pi/2} f(x) dx = \left[x f(x) \right]_{\pi/2}^{3\pi/2} - \int_{\pi/2}^{3\pi/2} x f'(x) dx = \left[\frac{3\pi}{2} f \left(\frac{3\pi}{2} \right) - \frac{\pi}{2} f \left(\frac{\pi}{2} \right) \right] - \int_{\pi/2}^{3\pi/2} \cos x dx$
 $= \left(\frac{3\pi b}{2} - \frac{\pi a}{2} \right) - \left[\sin x \right]_{\pi/2}^{3\pi/2} = \frac{\pi}{2}(3b - a) - [(-1) - 1] = \frac{\pi}{2}(3b - a) + 2$

220. $\int_0^a \frac{dx}{1+x^2} = [\tan^{-1} x]_0^a = \tan^{-1} a; \int_a^\infty \frac{dx}{1+x^2} = \lim_{b \rightarrow \infty} [\tan^{-1} x]_a^b = \lim_{b \rightarrow \infty} (\tan^{-1} b - \tan^{-1} a) = \frac{\pi}{2} - \tan^{-1} a;$
 therefore, $\tan^{-1} a = \frac{\pi}{2} - \tan^{-1} a \Rightarrow \tan^{-1} a = \frac{\pi}{4} \Rightarrow a = 1$ since $a > 0$.

CHAPTER 8 ADDITIONAL AND ADVANCED EXERCISES

1. $u = (\sin^{-1} x)^2, du = \frac{2 \sin^{-1} x dx}{\sqrt{1-x^2}}; dv = dx, v = x;$
 $\int (\sin^{-1} x)^2 dx = x (\sin^{-1} x)^2 - \int \frac{2x \sin^{-1} x dx}{\sqrt{1-x^2}};$
 $u = \sin^{-1} x, du = \frac{dx}{\sqrt{1-x^2}}; dv = -\frac{2x dx}{\sqrt{1-x^2}}, v = 2\sqrt{1-x^2};$
 $-\int \frac{2x \sin^{-1} x dx}{\sqrt{1-x^2}} = 2 (\sin^{-1} x) \sqrt{1-x^2} - \int 2 dx = 2 (\sin^{-1} x) \sqrt{1-x^2} - 2x + C; \text{ therefore}$
 $\int (\sin^{-1} x)^2 dx = x (\sin^{-1} x)^2 + 2 (\sin^{-1} x) \sqrt{1-x^2} - 2x + C$

2. $\frac{1}{x} = \frac{1}{x},$
 $\frac{1}{x(x+1)} = \frac{1}{x} - \frac{1}{x+1},$
 $\frac{1}{x(x+1)(x+2)} = \frac{1}{2x} - \frac{1}{x+1} + \frac{1}{2(x+2)},$
 $\frac{1}{x(x+1)(x+2)(x+3)} = \frac{1}{6x} - \frac{1}{2(x+1)} + \frac{1}{2(x+2)} - \frac{1}{6(x+3)},$
 $\frac{1}{x(x+1)(x+2)(x+3)(x+4)} = \frac{1}{24x} - \frac{1}{6(x+1)} + \frac{1}{4(x+2)} - \frac{1}{6(x+3)} + \frac{1}{24(x+4)} \Rightarrow \text{the following pattern:}$
 $\frac{1}{x(x+1)(x+2) \cdots (x+m)} = \sum_{k=0}^m \frac{(-1)^k}{(k!(m-k)!(x+k))}; \text{ therefore } \int \frac{dx}{x(x+1)(x+2) \cdots (x+m)}$

$$= \sum_{k=0}^m \left[\frac{(-1)^k}{(k!(m-k)!)} \ln |x+k| \right] + C$$

3. $u = \sin^{-1} x$, $du = \frac{dx}{\sqrt{1-x^2}}$; $dv = x dx$, $v = \frac{x^2}{2}$;

$$\begin{aligned} \int x \sin^{-1} x dx &= \frac{x^2}{2} \sin^{-1} x - \int \frac{x^2 dx}{2\sqrt{1-x^2}}; \left[\begin{array}{l} x = \sin \theta \\ dx = \cos \theta d\theta \end{array} \right] \rightarrow \int x \sin^{-1} x dx = \frac{x^2}{2} \sin^{-1} x - \int \frac{\sin^2 \theta \cos \theta d\theta}{2 \cos \theta} \\ &= \frac{x^2}{2} \sin^{-1} x - \frac{1}{2} \int \sin^2 \theta d\theta = \frac{x^2}{2} \sin^{-1} x - \frac{1}{2} \left(\frac{\theta}{2} - \frac{\sin 2\theta}{4} \right) + C = \frac{x^2}{2} \sin^{-1} x + \frac{\sin \theta \cos \theta - \theta}{4} + C \\ &= \frac{x^2}{2} \sin^{-1} x + \frac{x\sqrt{1-x^2} - \sin^{-1} x}{4} + C \end{aligned}$$

4. $\int \sin^{-1} \sqrt{y} dy$; $\left[\begin{array}{l} z = \sqrt{y} \\ dz = \frac{dy}{2\sqrt{y}} \end{array} \right] \rightarrow \int 2z \sin^{-1} z dz$; from Exercise 3, $\int z \sin^{-1} z dz$

$$\begin{aligned} &= \frac{z^2 \sin^{-1} z}{2} + \frac{z\sqrt{1-z^2} - \sin^{-1} z}{4} + C \Rightarrow \int \sin^{-1} \sqrt{y} dy = y \sin^{-1} \sqrt{y} + \frac{\sqrt{y}\sqrt{1-y} - \sin^{-1} \sqrt{y}}{2} + C \\ &= y \sin^{-1} \sqrt{y} + \frac{\sqrt{y-y^2}}{2} - \frac{\sin^{-1} \sqrt{y}}{2} + C \end{aligned}$$

5. $\int \frac{d\theta}{1-\tan^2 \theta} = \int \frac{\cos^2 \theta}{\cos^2 \theta - \sin^2 \theta} d\theta = \int \frac{1+\cos 2\theta}{2 \cos 2\theta} d\theta = \frac{1}{2} \int (\sec 2\theta + 1) d\theta = \frac{\ln |\sec 2\theta + \tan 2\theta| + 2\theta}{4} + C$

6. $u = \ln(\sqrt{x} + \sqrt{1+x})$, $du = \left(\frac{dx}{\sqrt{x} + \sqrt{1+x}} \right) \left(\frac{1}{2\sqrt{x}} + \frac{1}{2\sqrt{1+x}} \right) = \frac{dx}{2\sqrt{x}\sqrt{1+x}}$; $dv = dx$, $v = x$;

$$\int \ln(\sqrt{x} + \sqrt{1+x}) dx = x \ln(\sqrt{x} + \sqrt{1+x}) - \frac{1}{2} \int \frac{x dx}{\sqrt{x}\sqrt{1+x}}; \frac{1}{2} \int \frac{x dx}{\sqrt{(x+\frac{1}{2})^2 - \frac{1}{4}}}$$

$$\left[\begin{array}{l} x + \frac{1}{2} = \frac{1}{2} \sec \theta \\ dx = \frac{1}{2} \sec \theta \tan \theta d\theta \end{array} \right] \rightarrow \frac{1}{4} \int \frac{(\sec \theta - 1) \cdot \sec \theta \tan \theta d\theta}{(\frac{1}{2} \tan \theta)} = \frac{1}{2} \int (\sec^2 \theta - \sec \theta) d\theta$$

$$= \frac{\tan \theta - \ln |\sec \theta + \tan \theta|}{2} + C = \frac{2\sqrt{x^2+x} - \ln |2x+1+2\sqrt{x^2+x}|}{2} + C$$

$$\Rightarrow \int \ln(\sqrt{x} + \sqrt{1+x}) dx = x \ln(\sqrt{x} + \sqrt{1+x}) - \frac{2\sqrt{x^2+x} - \ln |2x+1+2\sqrt{x^2+x}|}{4} + C$$

7. $\int \frac{dt}{t-\sqrt{1-t^2}}$; $\left[\begin{array}{l} t = \sin \theta \\ dt = \cos \theta d\theta \end{array} \right] \rightarrow \int \frac{\cos \theta d\theta}{\sin \theta - \cos \theta} = \int \frac{d\theta}{\tan \theta - 1}$; $\left[\begin{array}{l} u = \tan \theta \\ du = \sec^2 \theta d\theta \\ d\theta = \frac{du}{u^2+1} \end{array} \right] \rightarrow \int \frac{du}{(u-1)(u^2+1)}$

$$= \frac{1}{2} \int \frac{du}{u-1} - \frac{1}{2} \int \frac{du}{u^2+1} - \frac{1}{2} \int \frac{u du}{u^2+1} = \frac{1}{2} \ln \left| \frac{u-1}{\sqrt{u^2+1}} \right| - \frac{1}{2} \tan^{-1} u + C = \frac{1}{2} \ln \left| \frac{\tan \theta - 1}{\sec \theta} \right| - \frac{1}{2} \theta + C$$

$$= \frac{1}{2} \ln(t - \sqrt{1-t^2}) - \frac{1}{2} \sin^{-1} t + C$$

8. $\int \frac{(2e^{2x} - e^x) dx}{\sqrt{3e^{2x} - 6e^x - 1}}$; $\left[\begin{array}{l} u = e^x \\ du = e^x dx \end{array} \right] \rightarrow \int \frac{(2u-1) du}{\sqrt{3u^2-6u-1}} = \frac{1}{\sqrt{3}} \int \frac{(2u-1) du}{\sqrt{(u-1)^2 - \frac{4}{3}}}$;

$$\left[\begin{array}{l} u-1 = \frac{2}{\sqrt{3}} \sec \theta \\ du = \frac{2}{\sqrt{3}} \sec \theta \tan \theta d\theta \end{array} \right] \rightarrow \frac{1}{\sqrt{3}} \int \left(\frac{4}{\sqrt{3}} \sec \theta + 1 \right) (\sec \theta) d\theta = \frac{4}{3} \int \sec^2 \theta d\theta + \frac{1}{\sqrt{3}} \int \sec \theta d\theta$$

$$= \frac{4}{3} \tan \theta + \frac{1}{\sqrt{3}} \ln |\sec \theta + \tan \theta| + C_1 = \frac{4}{3} \cdot \sqrt{\frac{3}{4}(u-1)^2 - 1} + \frac{1}{\sqrt{3}} \ln \left| \frac{\sqrt{3}}{2}(u-1) + \sqrt{\frac{3}{4}(u-1)^2 - 1} \right| + C_1$$

$$= \frac{2}{3} \sqrt{3u^2 - 6u - 1} + \frac{1}{\sqrt{3}} \ln \left| u-1 + \sqrt{(u-1)^2 - \frac{4}{3}} \right| + \left(C_1 + \frac{1}{\sqrt{3}} \ln \frac{\sqrt{3}}{2} \right)$$

$$= \frac{1}{\sqrt{3}} \left[2\sqrt{e^{2x} - 2e^x - \frac{1}{3}} + \ln \left| e^x - 1 + \sqrt{e^{2x} - 2e^x - \frac{1}{3}} \right| \right] + C$$

9. $\int \frac{1}{x^4+4} dx = \int \frac{1}{(x^2+2)^2-4x^2} dx = \int \frac{1}{(x^2+2x+2)(x^2-2x+2)} dx$

$$= \frac{1}{16} \int \left[\frac{2x+2}{x^2+2x+2} + \frac{2}{(x+1)^2+1} - \frac{2x-2}{x^2-2x+2} + \frac{2}{(x-1)^2+1} \right] dx$$

$$= \frac{1}{16} \ln \left| \frac{x^2+2x+2}{x^2-2x+2} \right| + \frac{1}{8} [\tan^{-1}(x+1) + \tan^{-1}(x-1)] + C$$

$$\begin{aligned} 10. \int \frac{1}{x^6-1} dx &= \frac{1}{6} \int \left(\frac{1}{x-1} - \frac{1}{x+1} + \frac{x-2}{x^2-x+1} - \frac{x+2}{x^2+x+1} \right) dx \\ &= \frac{1}{6} \ln \left| \frac{x-1}{x+1} \right| + \frac{1}{12} \int \left[\frac{2x-1}{x^2-x+1} - \frac{3}{(x-\frac{1}{2})^2+\frac{3}{4}} - \frac{2x+1}{x^2+x+1} - \frac{3}{(x+\frac{1}{2})^2+\frac{3}{4}} \right] dx \\ &= \frac{1}{6} \ln \left| \frac{x-1}{x+1} \right| + \frac{1}{12} \left[\ln \left| \frac{x^2-x+1}{x^2+x+1} \right| - 2\sqrt{3} \tan^{-1} \left(\frac{2x-1}{\sqrt{3}} \right) - 2\sqrt{3} \tan^{-1} \left(\frac{2x+1}{\sqrt{3}} \right) \right] + C \end{aligned}$$

$$11. \lim_{x \rightarrow \infty} \int_{-x}^x \sin t dt = \lim_{x \rightarrow \infty} [-\cos t]_{-x}^x = \lim_{x \rightarrow \infty} [-\cos x + \cos(-x)] = \lim_{x \rightarrow \infty} (-\cos x + \cos x) = \lim_{x \rightarrow \infty} 0 = 0$$

$$12. \lim_{x \rightarrow 0^+} \int_x^1 \frac{\cos t}{t^2} dt; \lim_{t \rightarrow 0^+} \frac{(\frac{1}{t^2})}{(\frac{\cos t}{t^2})} = \lim_{t \rightarrow 0^+} \frac{1}{\cos t} = 1 \Rightarrow \lim_{x \rightarrow 0^+} \int_x^1 \frac{\cos t}{t^2} dt \text{ diverges since } \int_0^1 \frac{dt}{t^2} \text{ diverges; thus}$$

$\lim_{x \rightarrow 0^+} x \int_x^1 \frac{\cos t}{t^2} dt$ is an indeterminate $0 \cdot \infty$ form and we apply l'Hôpital's rule:

$$\lim_{x \rightarrow 0^+} x \int_x^1 \frac{\cos t}{t^2} dt = \lim_{x \rightarrow 0^+} \frac{-\int_x^1 \frac{\cos t}{t^2} dt}{\frac{1}{x}} = \lim_{x \rightarrow 0^+} \frac{-\left(\frac{\cos x}{x^2}\right)}{\left(-\frac{1}{x^2}\right)} = \lim_{x \rightarrow 0^+} \cos x = 1$$

$$\begin{aligned} 13. \lim_{n \rightarrow \infty} \sum_{k=1}^n \ln \sqrt{1 + \frac{k}{n}} &= \lim_{n \rightarrow \infty} \sum_{k=1}^n \ln \left(1 + k \left(\frac{1}{n} \right) \right) \left(\frac{1}{n} \right) = \int_0^1 \ln(1+x) dx; \left[\begin{array}{l} u = 1+x, du = dx \\ x=0 \Rightarrow u=1, x=1 \Rightarrow u=2 \end{array} \right] \\ &\rightarrow \int_1^2 \ln u du = [u \ln u - u]_1^2 = (2 \ln 2 - 2) - (\ln 1 - 1) = 2 \ln 2 - 1 = \ln 4 - 1 \end{aligned}$$

$$\begin{aligned} 14. \lim_{n \rightarrow \infty} \sum_{k=0}^{n-1} \frac{1}{\sqrt{n^2-k^2}} &= \lim_{n \rightarrow \infty} \sum_{k=0}^{n-1} \left(\frac{n}{\sqrt{n^2-k^2}} \right) \left(\frac{1}{n} \right) = \lim_{n \rightarrow \infty} \sum_{k=0}^{n-1} \left(\frac{1}{\sqrt{1-\left[\frac{k}{n}\right]^2}} \right) \left(\frac{1}{n} \right) \\ &= \int_0^1 \frac{1}{\sqrt{1-x^2}} dx = [\sin^{-1} x]_0^1 = \frac{\pi}{2} \end{aligned}$$

$$\begin{aligned} 15. \frac{dy}{dx} = \sqrt{\cos 2x} \Rightarrow 1 + \left(\frac{dy}{dx} \right)^2 &= 1 + \cos 2x = 2 \cos^2 x; L = \int_0^{\pi/4} \sqrt{1 + \left(\sqrt{\cos 2t} \right)^2} dt = \sqrt{2} \int_0^{\pi/4} \sqrt{\cos^2 t} dt \\ &= \sqrt{2} [\sin t]_0^{\pi/4} = 1 \end{aligned}$$

$$\begin{aligned} 16. \frac{dy}{dx} = \frac{-2x}{1-x^2} \Rightarrow 1 + \left(\frac{dy}{dx} \right)^2 &= \frac{(1-x^2)^2 + 4x^2}{(1-x^2)^2} = \frac{1+2x^2+x^4}{(1-x^2)^2} = \left(\frac{1+x^2}{1-x^2} \right)^2; L = \int_0^{1/2} \sqrt{1 + \left(\frac{dy}{dx} \right)^2} dx \\ &= \int_0^{1/2} \left(\frac{1+x^2}{1-x^2} \right) dx = \int_0^{1/2} \left(-1 + \frac{2}{1-x^2} \right) dx = \int_0^{1/2} \left(-1 + \frac{1}{1+x} + \frac{1}{1-x} \right) dx = [-x + \ln \left| \frac{1+x}{1-x} \right|]_0^{1/2} \\ &= \left(-\frac{1}{2} + \ln 3 \right) - (0 + \ln 1) = \ln 3 - \frac{1}{2} \end{aligned}$$

$$\begin{aligned} 17. V &= \int_a^b 2\pi \left(\begin{array}{l} \text{shell} \\ \text{radius} \end{array} \right) \left(\begin{array}{l} \text{shell} \\ \text{height} \end{array} \right) dx = \int_0^1 2\pi xy dx \\ &= 6\pi \int_0^1 x^2 \sqrt{1-x} dx; \left[\begin{array}{l} u = 1-x \\ du = -dx \\ x^2 = (1-u)^2 \end{array} \right] \\ &\rightarrow -6\pi \int_1^0 (1-u)^2 \sqrt{u} du \\ &= -6\pi \int_1^0 (u^{1/2} - 2u^{3/2} + u^{5/2}) du \\ &= -6\pi \left[\frac{2}{3} u^{3/2} - \frac{4}{5} u^{5/2} + \frac{2}{7} u^{7/2} \right]_1^0 = 6\pi \left(\frac{2}{3} - \frac{4}{5} + \frac{2}{7} \right) \\ &= 6\pi \left(\frac{70-84+30}{105} \right) = 6\pi \left(\frac{16}{105} \right) = \frac{32\pi}{35} \end{aligned}$$

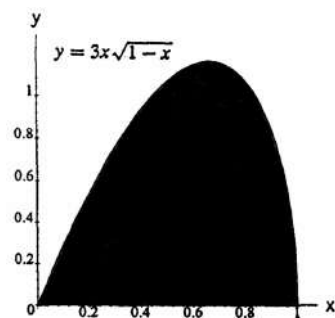

$$\begin{aligned}
 18. \quad V &= \int_a^b \pi y^2 dx = \pi \int_1^4 \frac{25 dx}{x^2(5-x)} \\
 &= \pi \int_1^4 \left(\frac{dx}{x} + \frac{5 dx}{x^2} + \frac{dx}{5-x} \right) \\
 &= \pi \left[\ln \left| \frac{x}{5-x} \right| - \frac{5}{x} \right]_1^4 = \pi \left(\ln 4 - \frac{5}{4} \right) - \pi \left(\ln \frac{1}{4} - 5 \right) \\
 &= \frac{15\pi}{4} + 2\pi \ln 4
 \end{aligned}$$

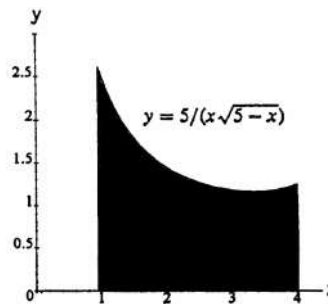

$$\begin{aligned}
 19. \quad V &= \int_a^b 2\pi \left(\frac{\text{shell}}{\text{radius}} \right) \left(\frac{\text{shell}}{\text{height}} \right) dx = \int_0^1 2\pi x e^x dx \\
 &= 2\pi [x e^x - e^x]_0^1 = 2\pi
 \end{aligned}$$

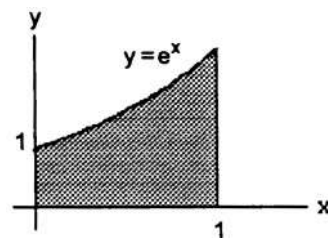

$$\begin{aligned}
 20. \quad V &= \int_0^{\ln 2} 2\pi (\ln 2 - x) (e^x - 1) dx \\
 &= 2\pi \int_0^{\ln 2} [(\ln 2) e^x - \ln 2 - x e^x + x] dx \\
 &= 2\pi \left[(\ln 2) e^x - (\ln 2)x - x e^x + e^x + \frac{x^2}{2} \right]_0^{\ln 2} \\
 &= 2\pi \left[2 \ln 2 - (\ln 2)^2 - 2 \ln 2 + 2 + \frac{(\ln 2)^2}{2} \right] - 2\pi (\ln 2 + 1) \\
 &= 2\pi \left[-\frac{(\ln 2)^2}{2} - \ln 2 + 1 \right]
 \end{aligned}$$

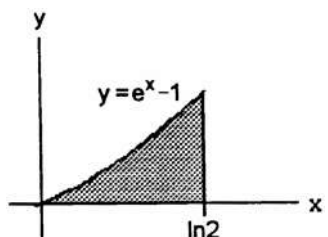

$$\begin{aligned}
 21. \quad (a) \quad V &= \int_1^e \pi [1 - (\ln x)^2] dx \\
 &= \pi [x - x(\ln x)^2]_1^e + 2\pi \int_1^e \ln x dx \\
 &\quad \text{(FORMULA 110)} \\
 &= \pi [x - x(\ln x)^2 + 2(x \ln x - x)]_1^e \\
 &= \pi [-x - x(\ln x)^2 + 2x \ln x]_1^e \\
 &= \pi [-e - e + 2e - (-1)] = \pi
 \end{aligned}$$

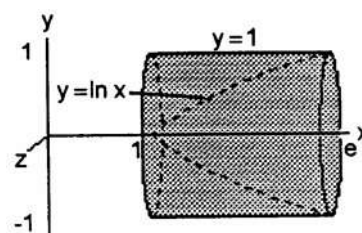

$$\begin{aligned}
 (b) \quad V &= \int_1^e \pi (1 - \ln x)^2 dx = \pi \int_1^e [1 - 2 \ln x + (\ln x)^2] dx \\
 &= \pi [x - 2(x \ln x - x) + x(\ln x)^2]_1^e - 2\pi \int_1^e \ln x dx \\
 &= \pi [x - 2(x \ln x - x) + x(\ln x)^2 - 2(x \ln x - x)]_1^e \\
 &= \pi [5x - 4x \ln x + x(\ln x)^2]_1^e \\
 &= \pi [(5e - 4e + e) - (5)] = \pi(2e - 5)
 \end{aligned}$$

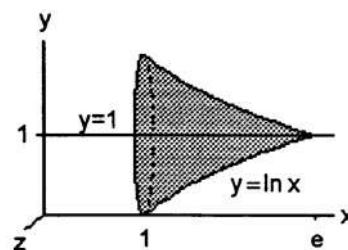

$$22. \quad (a) \quad V = \pi \int_0^1 [(e^y)^2 - 1] dy = \pi \int_0^1 (e^{2y} - 1) dy = \pi \left[\frac{e^{2y}}{2} - y \right]_0^1 = \pi \left[\frac{e^2}{2} - 1 - \left(\frac{1}{2} \right) \right] = \frac{\pi(e^2 - 3)}{2}$$

$$\begin{aligned}
 (b) \quad V &= \pi \int_0^1 (e^y - 1)^2 dy = \pi \int_0^1 (e^{2y} - 2e^y + 1) dy = \pi \left[\frac{e^{2y}}{2} - 2e^y + y \right]_0^1 = \pi \left[\left(\frac{e^2}{2} - 2e + 1 \right) - \left(\frac{1}{2} - 2 \right) \right] \\
 &= \pi \left(\frac{e^2}{2} - 2e + \frac{5}{2} \right) = \frac{\pi(e^2 - 4e + 5)}{2}
 \end{aligned}$$

$$23. \quad (a) \quad \lim_{x \rightarrow 0^+} x \ln x = 0 \Rightarrow \lim_{x \rightarrow 0^+} f(x) = 0 = f(0) \Rightarrow f \text{ is continuous}$$

$$(b) V = \int_0^2 \pi x^2 (\ln x)^2 dx; \left[\begin{array}{l} u = (\ln x)^2 \\ du = (2 \ln x) \frac{dx}{x} \\ dv = x^2 dx \\ v = \frac{x^3}{3} \end{array} \right] \rightarrow \pi \left(\lim_{b \rightarrow 0^+} \left[\frac{x^3}{3} (\ln x)^2 \right]_b^2 - \int_0^2 \left(\frac{x^3}{3} \right) (2 \ln x) \frac{dx}{x} \right)$$

$$= \pi \left[\left(\frac{8}{3} \right) (\ln 2)^2 - \left(\frac{2}{3} \right) \lim_{b \rightarrow 0^+} \left[\frac{x^3}{3} \ln x - \frac{x^3}{9} \right]_b^2 \right] = \pi \left[\frac{8(\ln 2)^2}{3} - \frac{16(\ln 2)}{9} + \frac{16}{27} \right]$$

$$24. V = \int_0^1 \pi (-\ln x)^2 dx$$

$$= \pi \left(\lim_{b \rightarrow 0^+} [x(\ln x)^2]_b^1 - 2 \int_0^1 \ln x dx \right)$$

$$= -2\pi \lim_{b \rightarrow 0^+} [x \ln x - x]_b^1 = 2\pi$$

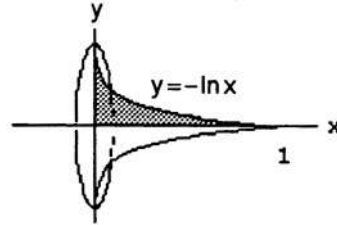

$$25. M = \int_1^e \ln x dx = [x \ln x - x]_1^e = (e - e) - (0 - 1) = 1;$$

$$M_x = \int_1^e (\ln x) \left(\frac{\ln x}{2} \right) dx = \frac{1}{2} \int_1^e (\ln x)^2 dx$$

$$= \frac{1}{2} \left([x(\ln x)^2]_1^e - 2 \int_1^e \ln x dx \right) = \frac{1}{2} (e - 2);$$

$$M_y = \int_1^e x \ln x dx = \left[\frac{x^2 \ln x}{2} \right]_1^e - \frac{1}{2} \int_1^e x dx$$

$$= \frac{1}{2} \left[x^2 \ln x - \frac{x^2}{2} \right]_1^e = \frac{1}{2} \left[\left(e^2 - \frac{e^2}{2} \right) + \frac{1}{2} \right] = \frac{1}{4} (e^2 + 1);$$

therefore, $\bar{x} = \frac{M_y}{M} = \frac{e^2 + 1}{4}$ and $\bar{y} = \frac{M_x}{M} = \frac{e - 2}{2}$

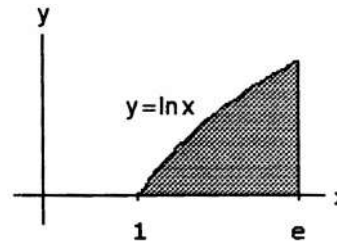

$$26. M = \int_0^1 \frac{2 dx}{\sqrt{1-x^2}} = 2 [\sin^{-1} x]_0^1 = \pi;$$

$$M_y = \int_0^1 \frac{2x dx}{\sqrt{1-x^2}} = 2 [-\sqrt{1-x^2}]_0^1 = 2;$$

therefore, $\bar{x} = \frac{M_y}{M} = \frac{2}{\pi}$ and $\bar{y} = 0$ by symmetry

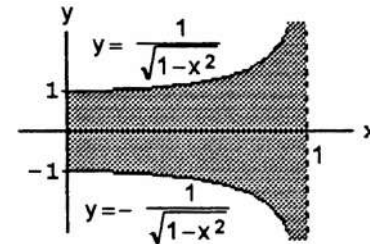

$$27. L = \int_1^e \sqrt{1 + \frac{1}{x^2}} dx = \int_1^e \frac{\sqrt{x^2 + 1}}{x} dx; \left[\begin{array}{l} x = \tan \theta \\ dx = \sec^2 \theta d\theta \end{array} \right] \rightarrow L = \int_{\pi/4}^{\tan^{-1} e} \frac{\sec \theta \cdot \sec^2 \theta d\theta}{\tan \theta}$$

$$= \int_{\pi/4}^{\tan^{-1} e} \frac{(\sec \theta)(\tan^2 \theta + 1)}{\tan \theta} d\theta = \int_{\pi/4}^{\tan^{-1} e} (\tan \theta \sec \theta + \csc \theta) d\theta = [\sec \theta - \ln |\csc \theta + \cot \theta|]_{\pi/4}^{\tan^{-1} e}$$

$$= \left(\sqrt{1 + e^2} - \ln \left| \frac{\sqrt{1+e^2}}{e} + \frac{1}{e} \right| \right) - \left[\sqrt{2} - \ln(1 + \sqrt{2}) \right] = \sqrt{1 + e^2} - \ln \left(\frac{\sqrt{1+e^2}}{e} + \frac{1}{e} \right) - \sqrt{2} + \ln(1 + \sqrt{2})$$

$$28. y = \ln x \Rightarrow 1 + \left(\frac{dx}{dy} \right)^2 = 1 + x^2 \Rightarrow S = 2\pi \int_c^d x \sqrt{1 + x^2} dy \Rightarrow S = 2\pi \int_0^1 e^y \sqrt{1 + e^{2y}} dy; \left[\begin{array}{l} u = e^y \\ du = e^y dy \end{array} \right]$$

$$\rightarrow S = 2\pi \int_1^e \sqrt{1 + u^2} du; \left[\begin{array}{l} u = \tan \theta \\ du = \sec^2 \theta d\theta \end{array} \right] \rightarrow 2\pi \int_{\pi/4}^{\tan^{-1} e} \sec \theta \cdot \sec^2 \theta d\theta$$

$$= 2\pi \left(\frac{1}{2} \right) [\sec \theta \tan \theta + \ln |\sec \theta + \tan \theta|]_{\pi/4}^{\tan^{-1} e} = \pi \left[\left(\sqrt{1 + e^2} \right) e + \ln \left| \sqrt{1 + e^2} + e \right| \right] - \pi \left[\sqrt{2} \cdot 1 + \ln(\sqrt{2} + 1) \right]$$

$$= \pi \left[e\sqrt{1 + e^2} + \ln \left(\frac{\sqrt{1+e^2} + e}{\sqrt{2} + 1} \right) - \sqrt{2} \right]$$

$$29. L = 4 \int_0^1 \sqrt{1 + \left(\frac{dy}{dx} \right)^2} dx; x^{2/3} + y^{2/3} = 1 \Rightarrow y = (1 - x^{2/3})^{3/2} \Rightarrow \frac{dy}{dx} = -\frac{3}{2} (1 - x^{2/3})^{1/2} (x^{-1/3}) \left(\frac{2}{3} \right)$$

$$\Rightarrow \left(\frac{dy}{dx}\right)^2 = \frac{1-x^{2/3}}{x^{2/3}} \Rightarrow L = 4 \int_0^1 \sqrt{1 + \left(\frac{1-x^{2/3}}{x^{2/3}}\right)} dx = 4 \int_0^1 \frac{dx}{x^{1/3}} = 6 [x^{2/3}]_0^1 = 6$$

$$\begin{aligned} 30. S &= 2\pi \int_{-1}^1 f(x) \sqrt{1 + [f'(x)]^2} dx; f(x) = (1 - x^{2/3})^{3/2} \Rightarrow [f'(x)]^2 + 1 = \frac{1}{x^{2/3}} \Rightarrow S = 2\pi \int_{-1}^1 (1 - x^{2/3})^{3/2} \cdot \frac{dx}{\sqrt{x^{2/3}}} \\ &= 4\pi \int_0^1 (1 - x^{2/3})^{3/2} \left(\frac{1}{x^{1/3}}\right) dx; \left[\begin{array}{l} u = x^{2/3} \\ du = \frac{2}{3} \frac{dx}{x^{1/3}} \end{array} \right] \rightarrow 4 \cdot \frac{3}{2} \pi \int_0^1 (1 - u)^{3/2} du = -6\pi \int_0^1 (1 - u)^{3/2} d(1 - u) \\ &= -6\pi \cdot \frac{2}{5} [(1 - u)^{5/2}]_0^1 = \frac{12\pi}{5} \end{aligned}$$

$$31. \left(\frac{dy}{dx}\right)^2 = \frac{1}{4x} \Rightarrow \frac{dy}{dx} = \frac{\pm 1}{2\sqrt{x}} \Rightarrow y = \sqrt{x} \text{ or } y = -\sqrt{x}, 0 \leq x \leq 4$$

32. The integral $\int_{-1}^1 \sqrt{1-x^2} dx$ is the area enclosed by the x-axis and the semicircle $y = \sqrt{1-x^2}$. This area is half the circle's area, or $\frac{\pi}{2}$ and multiplying by 2 gives π . The length of the circular arc $y = \sqrt{1-x^2}$ from $x = -1$ to $x = 1$ is $L = \int_{-1}^1 \sqrt{1 + \left(\frac{dy}{dx}\right)^2} dx = \int_{-1}^1 \sqrt{1 + \left(\frac{-x}{\sqrt{1-x^2}}\right)^2} dx = \int_{-1}^1 \frac{dx}{\sqrt{1-x^2}} = \frac{1}{2} (2\pi) = \pi$ since L is half the circle's circumference. In conclusion, $2 \int_{-1}^1 \sqrt{1-x^2} dx = \int_{-1}^1 \frac{dx}{\sqrt{1-x^2}}$.

$$\begin{aligned} 33. (b) \int_{-\infty}^{\infty} e^{(x-e^x)} dx &= \int_{-\infty}^{\infty} e^{(-e^x)} e^x dx & (a) \\ &= \lim_{a \rightarrow -\infty} \int_a^0 e^{(-e^x)} e^x dx + \lim_{b \rightarrow +\infty} \int_0^b e^{(-e^x)} e^x dx; \\ &\left[\begin{array}{l} u = e^x \\ du = e^x dx \end{array} \right] \rightarrow \\ &= \lim_{a \rightarrow -\infty} \int_{e^a}^1 e^{-u} du + \lim_{b \rightarrow +\infty} \int_1^{e^b} e^{-u} du \\ &= \lim_{a \rightarrow -\infty} [-e^{-u}]_{e^a}^1 + \lim_{b \rightarrow -\infty} [-e^{-u}]_1^{e^b} \\ &= \lim_{a \rightarrow -\infty} \left[-\frac{1}{e} + e^{-(e^a)}\right] + \lim_{b \rightarrow +\infty} \left[-e^{-(e^b)} + \frac{1}{e}\right] \\ &= \left(-\frac{1}{e} + e^0\right) + \left(0 + \frac{1}{e}\right) = 1 \end{aligned}$$

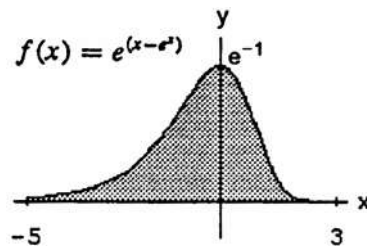

$$\begin{aligned} 34. u &= \frac{1}{1+y}, du = -\frac{dy}{(1+y)^2}; dv = ny^{n-1} dy, v = y^n; \\ n \lim_{n \rightarrow \infty} \int_0^1 \frac{ny^{n-1}}{1+y} dy &= n \lim_{n \rightarrow \infty} \left(\left[\frac{y^n}{1+y} \right]_0^1 + \int_0^1 \frac{y^n}{1+y^2} dy \right) = \frac{1}{2} + n \lim_{n \rightarrow \infty} \int_0^1 \frac{y^n}{1+y^2} dy. \text{ Now, } 0 \leq \frac{y^n}{1+y^2} \leq y^n \\ &\Rightarrow 0 \leq n \lim_{n \rightarrow \infty} \int_0^1 \frac{y^n}{1+y^2} dy \leq n \lim_{n \rightarrow \infty} \int_0^1 y^n dy = n \lim_{n \rightarrow \infty} \left[\frac{y^{n+1}}{n+1} \right]_0^1 = n \lim_{n \rightarrow \infty} \frac{1}{n+1} = 0 \Rightarrow n \lim_{n \rightarrow \infty} \int_0^1 \frac{ny^{n-1}}{1+y} dy \\ &= \frac{1}{2} + 0 = \frac{1}{2} \end{aligned}$$

$$\begin{aligned} 35. u &= x^2 - a^2 \Rightarrow du = 2x dx; \\ \int x (\sqrt{x^2 - a^2})^n dx &= \frac{1}{2} \int (\sqrt{u})^n du = \frac{1}{2} \int u^{n/2} du = \frac{1}{2} \left(\frac{u^{n/2+1}}{\frac{n}{2}+1} \right) + C, n \neq -2 \\ &= \frac{u^{(n+2)/2}}{n+2} + C = \frac{(\sqrt{u})^{n+2}}{n+2} + C = \frac{(\sqrt{x^2 - a^2})^{n+2}}{n+2} + C \end{aligned}$$

$$\begin{aligned} 36. \frac{\pi}{6} &= \sin^{-1} \frac{1}{2} = \left[\sin^{-1} \frac{x}{2} \right]_0^1 = \int_0^1 \frac{dx}{\sqrt{4-x^2}} < \int_0^1 \frac{dx}{\sqrt{4-x^2-x^3}} < \int_0^1 \frac{dx}{\sqrt{4-2x^2}} = \frac{1}{\sqrt{2}} \int_0^{\sqrt{2}} \frac{du}{\sqrt{4-u^2}} \\ &= \frac{1}{\sqrt{2}} \left[\sin^{-1} \frac{u}{2} \right]_0^{\sqrt{2}} = \frac{1}{\sqrt{2}} \sin^{-1} \frac{\sqrt{2}}{2} = \frac{1}{\sqrt{2}} \left(\frac{\pi}{4} \right) = \frac{\pi\sqrt{2}}{8} \end{aligned}$$

37. $\int_1^\infty \left(\frac{ax}{x^2+1} - \frac{1}{2x}\right) dx = \lim_{b \rightarrow \infty} \int_1^b \left(\frac{ax}{x^2+1} - \frac{1}{2x}\right) dx = \lim_{b \rightarrow \infty} \left[\frac{a}{2} \ln(x^2+1) - \frac{1}{2} \ln x\right]_1^b = \lim_{b \rightarrow \infty} \left[\frac{1}{2} \ln \frac{(x^2+1)^a}{x}\right]_1^b$
 $= \lim_{b \rightarrow \infty} \frac{1}{2} \left[\ln \frac{(b^2+1)^a}{b} - \ln 2^a\right]; \lim_{b \rightarrow \infty} \frac{(b^2+1)^a}{b} > \lim_{b \rightarrow \infty} \frac{b^{2a}}{b} = \lim_{b \rightarrow \infty} b^{2(a-\frac{1}{2})} = \infty$ if $a > \frac{1}{2} \Rightarrow$ the improper integral diverges if $a > \frac{1}{2}$; for $a = \frac{1}{2}$: $\lim_{b \rightarrow \infty} \frac{\sqrt{b^2+1}}{b} = \lim_{b \rightarrow \infty} \sqrt{1 + \frac{1}{b^2}} = 1 \Rightarrow \lim_{b \rightarrow \infty} \frac{1}{2} \left[\ln \frac{(b^2+1)^{1/2}}{b} - \ln 2^{1/2}\right]$
 $= \frac{1}{2} (\ln 1 - \frac{1}{2} \ln 2) = -\frac{\ln 2}{4}$; if $a < \frac{1}{2}$: $0 \leq \lim_{b \rightarrow \infty} \frac{(b^2+1)^a}{b} < \lim_{b \rightarrow \infty} \frac{(b+1)^{2a}}{b+1} = \lim_{b \rightarrow \infty} (b+1)^{2a-1} = 0$
 $\Rightarrow \lim_{b \rightarrow \infty} \ln \frac{(b^2+1)^a}{b} = -\infty \Rightarrow$ the improper integral diverges if $a < \frac{1}{2}$; in summary, the improper integral $\int_1^\infty \left(\frac{ax}{x^2+1} - \frac{1}{2x}\right) dx$ converges only when $a = \frac{1}{2}$ and has the value $-\frac{\ln 2}{4}$

38. $G(x) = \lim_{b \rightarrow \infty} \int_0^b e^{-xt} dt = \lim_{b \rightarrow \infty} \left[-\frac{1}{x} e^{-xt}\right]_0^b = \lim_{b \rightarrow \infty} \left(\frac{1-e^{-xb}}{x}\right) = \frac{1-0}{x} = \frac{1}{x}$ if $x > 0 \Rightarrow xG(x) = x \left(\frac{1}{x}\right) = 1$ if $x > 0$

39. $A = \int_1^\infty \frac{dx}{x^p}$ converges if $p > 1$ and diverges if $p \leq 1$. Thus, $p \leq 1$ for infinite area. The volume of the solid of revolution about the x-axis is $V = \int_1^\infty \pi \left(\frac{1}{x^p}\right)^2 dx = \pi \int_1^\infty \frac{dx}{x^{2p}}$ which converges if $2p > 1$ and diverges if $2p \leq 1$. Thus we want $p > \frac{1}{2}$ for finite volume. In conclusion, the curve $y = x^{-p}$ gives infinite area and finite volume for values of p satisfying $\frac{1}{2} < p \leq 1$.

40. The area is given by the integral $A = \int_0^1 \frac{dx}{x^p}$;

$p = 1$: $A = \lim_{b \rightarrow 0^+} [\ln x]_b^1 = -\lim_{b \rightarrow 0^+} \ln b = \infty$, diverges;

$p > 1$: $A = \lim_{b \rightarrow 0^+} [x^{1-p}]_b^1 = 1 - \lim_{b \rightarrow 0^+} b^{1-p} = -\infty$, diverges;

$p < 1$: $A = \lim_{b \rightarrow 0^+} [x^{1-p}]_b^1 = 1 - \lim_{b \rightarrow 0^+} b^{1-p} = 1 - 0$, converges; thus, $p \geq 1$ for infinite area.

The volume of the solid of revolution about the x-axis is $V_x = \pi \int_0^1 \frac{dx}{x^{2p}}$ which converges if $2p < 1$ or $p < \frac{1}{2}$, and diverges if $p \geq \frac{1}{2}$. Thus, V_x is infinite whenever the area is infinite ($p \geq 1$).

The volume of the solid of revolution about the y-axis is $V_y = \pi \int_1^\infty [R(y)]^2 dy = \pi \int_1^\infty \frac{dy}{y^{2/p}}$ which converges if $\frac{2}{p} > 1 \Leftrightarrow p < 2$ (see Exercise 39). In conclusion, the curve $y = x^{-p}$ gives infinite area and finite volume for values of p satisfying $1 \leq p < 2$, as described above.

41. e^{2x} (+) $\cos 3x$

$2e^{2x}$ (-) $\rightarrow \frac{1}{3} \sin 3x$

$4e^{2x}$ (+) $\rightarrow -\frac{1}{9} \cos 3x$

$I = \frac{e^{2x}}{3} \sin 3x + \frac{2e^{2x}}{9} \cos 3x - \frac{4}{9} I \Rightarrow \frac{13}{9} I = \frac{e^{2x}}{9} (3 \sin 3x + 2 \cos 3x) \Rightarrow I = \frac{e^{2x}}{13} (3 \sin 3x + 2 \cos 3x) + C$

42. e^{3x} (+) $\sin 4x$

$3e^{3x}$ (-) $\rightarrow -\frac{1}{4} \cos 4x$

$9e^{3x}$ (+) $\rightarrow -\frac{1}{16} \sin 4x$

$I = -\frac{e^{3x}}{4} \cos 4x + \frac{3e^{3x}}{16} \sin 4x - \frac{9}{16} I \Rightarrow \frac{25}{16} I = \frac{e^{3x}}{16} (3 \sin 4x - 4 \cos 4x) \Rightarrow I = \frac{e^{3x}}{25} (3 \sin 4x - 4 \cos 4x) + C$

43. $\sin 3x$ (+) $\sin x$
 $3 \cos 3x$ (-) $-\cos x$
 $-9 \sin 3x$ (+) $-\sin x$

$$I = -\sin 3x \cos x + 3 \cos 3x \sin x + 9I \Rightarrow -8I = -\sin 3x \cos x + 3 \cos 3x \sin x$$

$$\Rightarrow I = \frac{\sin 3x \cos x - 3 \cos 3x \sin x}{8} + C$$

44. $\cos 5x$ (+) $\sin 4x$
 $-\sin 5x$ (-) $-\frac{1}{4} \cos 4x$
 $-25 \cos 5x$ (+) $-\frac{1}{16} \sin 4x$

$$I = -\frac{1}{4} \cos 5x \cos 4x - \frac{5}{16} \sin 5x \sin 4x + \frac{25}{16} I \Rightarrow -\frac{9}{16} I = -\frac{1}{4} \cos 5x \cos 4x - \frac{5}{16} \sin 5x \sin 4x$$

$$\Rightarrow I = \frac{1}{9} (4 \cos 5x \cos 4x + 5 \sin 5x \sin 4x) + C$$

45. e^{ax} (+) $\sin bx$
 ae^{ax} (-) $-\frac{1}{b} \cos bx$
 $a^2 e^{ax}$ (+) $-\frac{1}{b^2} \sin bx$

$$I = -\frac{e^{ax}}{b} \cos bx + \frac{ae^{ax}}{b^2} \sin bx - \frac{a^2}{b^2} I \Rightarrow \left(\frac{a^2 + b^2}{b^2}\right) I = \frac{e^{ax}}{b^2} (a \sin bx - b \cos bx)$$

$$\Rightarrow I = \frac{e^{ax}}{a^2 + b^2} (a \sin bx - b \cos bx) + C$$

46. e^{ax} (+) $\cos bx$
 ae^{ax} (-) $\frac{1}{b} \sin bx$
 $a^2 e^{ax}$ (+) $-\frac{1}{b^2} \cos bx$

$$I = \frac{e^{ax}}{b} \sin bx + \frac{ae^{ax}}{b^2} \cos bx - \frac{a^2}{b^2} I \Rightarrow \left(\frac{a^2 + b^2}{b^2}\right) I = \frac{e^{ax}}{b^2} (a \cos bx + b \sin bx)$$

$$\Rightarrow I = \frac{e^{ax}}{a^2 + b^2} (a \cos bx + b \sin bx) + C$$

47. $\ln(ax)$ (+) 1
 $\frac{1}{x}$ (+) x

$$I = x \ln(ax) - \int \left(\frac{1}{x}\right) x dx = x \ln(ax) - x + C$$

48. $\ln(ax)$ (+) x^2
 $\frac{1}{x}$ (+) $\frac{1}{3} x^3$

$$I = \frac{1}{3} x^3 \ln(ax) - \int \left(\frac{1}{x}\right) \left(\frac{x^3}{3}\right) dx = \frac{1}{3} x^3 \ln(ax) - \frac{1}{9} x^3 + C$$

49. (a) $\Gamma(1) = \int_0^\infty e^{-t} dt = \lim_{b \rightarrow \infty} \int_0^b e^{-t} dt = \lim_{b \rightarrow \infty} [-e^{-t}]_0^b = \lim_{b \rightarrow \infty} \left[-\frac{1}{e^b} - (-1)\right] = 0 + 1 = 1$

(b) $u = t^x, du = xt^{x-1} dt; dv = e^{-t} dt, v = -e^{-t}; x = \text{fixed positive real}$

$$\Rightarrow \Gamma(x+1) = \int_0^\infty t^x e^{-t} dt = \lim_{b \rightarrow \infty} [-t^x e^{-t}]_0^b + x \int_0^\infty t^{x-1} e^{-t} dt = \lim_{b \rightarrow \infty} \left(-\frac{b^x}{e^b} + 0^x e^0\right) + x \Gamma(x) = x \Gamma(x)$$

(c) $\Gamma(n + 1) = n\Gamma(n) = n!$:

$n = 0$: $\Gamma(0 + 1) = \Gamma(1) = 0!$;

$n = k$: Assume $\Gamma(k + 1) = k!$

$n = k + 1$: $\Gamma(k + 1 + 1) = (k + 1)\Gamma(k + 1)$
 $= (k + 1)k!$
 $= (k + 1)!$

for some $k > 0$;
 from part (b)
 induction hypothesis
 definition of factorial

Thus, $\Gamma(n + 1) = n\Gamma(n) = n!$ for every positive integer n .

50. (a) $\Gamma(x) \approx \left(\frac{x}{e}\right)^x \sqrt{\frac{2\pi}{x}}$ and $n\Gamma(n) = n! \Rightarrow n! \approx n \left(\frac{n}{e}\right)^n \sqrt{\frac{2\pi}{n}} = \left(\frac{n}{e}\right)^n \sqrt{2n\pi}$

(b)

n	$\left(\frac{n}{e}\right)^n \sqrt{2n\pi}$	calculator
10	3598695.619	3628800
20	2.4227868×10^{18}	2.432902×10^{18}
30	2.6451710×10^{32}	2.652528×10^{32}
40	8.1421726×10^{47}	8.1591528×10^{47}
50	3.0363446×10^{64}	3.0414093×10^{64}
60	8.3094383×10^{81}	8.3209871×10^{81}

(c)

n	$\left(\frac{n}{e}\right)^n \sqrt{2n\pi}$	$\left(\frac{n}{e}\right)^n \sqrt{2n\pi} e^{1/12n}$	calculator
10	3598695.619	3628810.051	3628800

NOTES:

CHAPTER 9 FURTHER APPLICATIONS OF INTEGRATION

9.1 SLOPE FIELDS AND SEPARABLE DIFFERENTIAL EQUATIONS

- $y = e^{-x} \Rightarrow y' = -e^{-x} \Rightarrow 2y' + 3y = 2(-e^{-x}) + 3e^{-x} = e^{-x}$
 - $y = e^{-x} + e^{-3x/2} \Rightarrow y' = -e^{-x} - \frac{3}{2}e^{-3x/2} \Rightarrow 2y' + 3y = 2(-e^{-x} - \frac{3}{2}e^{-3x/2}) + 3(e^{-x} + e^{-3x/2}) = e^{-x}$
 - $y = e^{-x} + Ce^{-3x/2} \Rightarrow y' = -e^{-x} - \frac{3}{2}Ce^{-3x/2} \Rightarrow 2y' + 3y = 2(-e^{-x} - \frac{3}{2}Ce^{-3x/2}) + 3(e^{-x} + Ce^{-3x/2}) = e^{-x}$
- $y = -\frac{1}{x} \Rightarrow y' = \frac{1}{x^2} = \left(-\frac{1}{x}\right)^2 = y^2$
 - $y = -\frac{1}{x+3} \Rightarrow y' = \frac{1}{(x+3)^2} = \left[-\frac{1}{(x+3)}\right]^2 = y^2$
 - $y = \frac{1}{x+C} \Rightarrow y' = \frac{1}{(x+C)^2} = \left[-\frac{1}{x+C}\right]^2 = y^2$
- $y = \frac{1}{x} \int_1^x \frac{e^t}{t} dt \Rightarrow y' = -\frac{1}{x^2} \int_1^x \frac{e^t}{t} dt + \left(\frac{1}{x}\right) \left(\frac{e^x}{x}\right) \Rightarrow x^2 y' = -\int_1^x \frac{e^t}{t} dt + e^x = -x \left(\frac{1}{x} \int_1^x \frac{e^t}{t} dt\right) + e^x = -xy + e^x$
 $\Rightarrow x^2 y' + xy = e^x$
- $y = \frac{1}{\sqrt{1+x^4}} \int_1^x \sqrt{1+t^4} dt \Rightarrow y' = -\frac{1}{2} \left[\frac{4x^3}{(\sqrt{1+x^4})^3} \right] \int_1^x \sqrt{1+t^4} dt + \frac{1}{\sqrt{1+x^4}} (\sqrt{1+x^4})$
 $\Rightarrow y' = \left(\frac{-2x^3}{1+x^4}\right) \left(\frac{1}{\sqrt{1+x^4}} \int_1^x \sqrt{1+t^4} dt\right) + 1 \Rightarrow y' = \left(\frac{-2x^3}{1+x^4}\right) y + 1 \Rightarrow y' + \frac{2x^3}{1+x^4} \cdot y = 1$
- $y = e^{-x} \tan^{-1}(2e^x) \Rightarrow y' = -e^{-x} \tan^{-1}(2e^x) + e^{-x} \left[\frac{1}{1+(2e^x)^2} \right] (2e^x) = -e^{-x} \tan^{-1}(2e^x) + \frac{2}{1+4e^{2x}}$
 $\Rightarrow y' = -y + \frac{2}{1+4e^{2x}} \Rightarrow y' + y = \frac{2}{1+4e^{2x}}; y(-\ln 2) = e^{-(-\ln 2)} \tan^{-1}(2e^{-\ln 2}) = 2 \tan^{-1} 1 = 2 \left(\frac{\pi}{4}\right) = \frac{\pi}{2}$
- $y = (x-2)e^{-x^2} \Rightarrow y' = e^{-x^2} + (-2xe^{-x^2})(x-2) \Rightarrow y' = e^{-x^2} - 2xy; y(2) = (2-2)e^{-2^2} = 0$
- $y = \frac{\cos x}{x} \Rightarrow y' = \frac{-x \sin x - \cos x}{x^2} \Rightarrow y' = -\frac{\sin x}{x} - \frac{1}{x} \left(\frac{\cos x}{x}\right) \Rightarrow y' = -\frac{\sin x}{x} - \frac{y}{x} \Rightarrow xy' = -\sin x - y$
 $\Rightarrow xy' + y = -\sin x; y\left(\frac{\pi}{2}\right) = \frac{\cos(\pi/2)}{(\pi/2)} = 0$
- $y = \frac{x}{\ln x} \Rightarrow y' = \frac{\ln x - x \left(\frac{1}{x}\right)}{(\ln x)^2} \Rightarrow y' = \frac{1}{\ln x} - \frac{1}{(\ln x)^2} \Rightarrow x^2 y' = \frac{x^2}{\ln x} - \frac{x^2}{(\ln x)^2} \Rightarrow x^2 y' = xy - y^2; y(e) = \frac{e}{\ln e} = e$
- $2\sqrt{xy} \frac{dy}{dx} = 1 \Rightarrow 2x^{1/2}y^{1/2} dy = dx \Rightarrow 2y^{1/2} dy = x^{-1/2} dx \Rightarrow \int 2y^{1/2} dy = \int x^{-1/2} dx \Rightarrow 2\left(\frac{2}{3}y^{3/2}\right)$
 $= 2x^{1/2} + C_1 \Rightarrow \frac{2}{3}y^{3/2} - x^{1/2} = C, \text{ where } C = \frac{1}{2}C_1$
- $\frac{dy}{dx} = x^2 \sqrt{y} \Rightarrow dy = x^2 y^{1/2} dx \Rightarrow y^{-1/2} dy = x^2 dx \Rightarrow \int y^{-1/2} dy = \int x^2 dx \Rightarrow 2y^{1/2} = \frac{x^3}{3} + C$
 $\Rightarrow 2y^{1/2} - \frac{1}{3}x^3 = C$
- $\frac{dy}{dx} = e^{x-y} \Rightarrow dy = e^x e^{-y} dx \Rightarrow e^y dy = e^x dx \Rightarrow \int e^y dy = \int e^x dx \Rightarrow e^y = e^x + C \Rightarrow e^y - e^x = C$
- $\frac{dy}{dx} = 3x^2 e^{-y} \Rightarrow dy = 3x^2 e^{-y} dx \Rightarrow e^y dy = 3x^2 dx \Rightarrow \int e^y dy = \int 3x^2 dx \Rightarrow e^y = x^3 + C \Rightarrow e^y - x^3 = C$

13. $\frac{dy}{dx} = \sqrt{y} \cos^2 \sqrt{y} \Rightarrow dy = (\sqrt{y} \cos^2 \sqrt{y}) dx \Rightarrow \frac{\sec^2 \sqrt{y}}{\sqrt{y}} dy = dx \Rightarrow \int \frac{\sec^2 \sqrt{y}}{\sqrt{y}} dy = \int dx$. In the integral on the left-hand side, substitute $u = \sqrt{y} \Rightarrow du = \frac{1}{2\sqrt{y}} dy \Rightarrow 2 du = \frac{1}{\sqrt{y}} dy$, and we have $\int \sec^2 u du = \int dx \Rightarrow 2 \tan u = x + C \Rightarrow -x + 2 \tan \sqrt{y} = C$
14. $\sqrt{2xy} \frac{dy}{dx} = 1 \Rightarrow dy = \frac{1}{\sqrt{2xy}} dx \Rightarrow \sqrt{2} \sqrt{y} dy = \frac{1}{\sqrt{x}} dx \Rightarrow \sqrt{2} y^{1/2} dy = x^{-1/2} dx \Rightarrow \sqrt{2} \int y^{1/2} dy = \int x^{-1/2} dx \Rightarrow \sqrt{2} \frac{y^{3/2}}{3/2} dy = \frac{x^{1/2}}{1/2} + C_1 \Rightarrow \sqrt{2} y^{3/2} = 3\sqrt{x} + \frac{3}{2}C_1 \Rightarrow \sqrt{2} (\sqrt{y})^3 - 3\sqrt{x} = C$, where $C = \frac{3}{2}C_1$
15. $\sqrt{x} \frac{dy}{dx} = e^{y+\sqrt{x}} \Rightarrow \frac{dy}{dx} = \frac{e^{y+\sqrt{x}}}{\sqrt{x}} \Rightarrow dy = \frac{e^{y+\sqrt{x}}}{\sqrt{x}} dx \Rightarrow e^{-y} dy = \frac{e^{\sqrt{x}}}{\sqrt{x}} dx \Rightarrow \int e^{-y} dy = \int \frac{e^{\sqrt{x}}}{\sqrt{x}} dx$. In the integral on the right-hand side, substitute $u = \sqrt{x} \Rightarrow du = \frac{1}{2\sqrt{x}} dx \Rightarrow 2 du = \frac{1}{\sqrt{x}} dx$, and we have $\int e^{-y} dy = 2 \int e^u du \Rightarrow -e^{-y} = 2e^u + C_1 \Rightarrow -e^{-y} = 2e^{\sqrt{x}} + C$, where $C = -C_1$
16. $(\sec x) \frac{dy}{dx} = e^{y+\sin x} \Rightarrow \frac{dy}{dx} = e^{y+\sin x} \cos x \Rightarrow dy = (e^y e^{\sin x} \cos x) dx \Rightarrow e^{-y} dy = e^{\sin x} \cos x dx \Rightarrow \int e^{-y} dy = \int e^{\sin x} \cos x dx \Rightarrow -e^{-y} = e^{\sin x} + C_1 \Rightarrow e^{-y} + e^{\sin x} = C$, where $C = -C_1$
17. $\frac{dy}{dx} = 2x\sqrt{1-y^2} \Rightarrow dy = 2x\sqrt{1-y^2} dx \Rightarrow \frac{dy}{\sqrt{1-y^2}} = 2x dx \Rightarrow \int \frac{dy}{\sqrt{1-y^2}} = \int 2x dx \Rightarrow \sin^{-1} y = x^2 + C$ since $|y| < 1 \Rightarrow y = \sin(x^2 + C)$
18. $\frac{dy}{dx} = \frac{e^{2x-y}}{e^{x+y}} \Rightarrow dy = \frac{e^{2x-y}}{e^{x+y}} dx \Rightarrow dy = \frac{e^{2x} e^{-y}}{e^x e^y} dx = \frac{e^x}{e^{2y}} dx \Rightarrow e^{2y} dy = e^x dx \Rightarrow \int e^{2y} dy = \int e^x dx \Rightarrow \frac{e^{2y}}{2} = e^x + C_1 \Rightarrow e^{2y} - 2e^x = C$ where $C = 2C_1$

19. $y' = x + y \Rightarrow$ slope of 0 for the line $y = -x$.
 For $x, y > 0$, $y' = x + y \Rightarrow$ slope > 0 in Quadrant I.
 For $x, y < 0$, $y' = x + y \Rightarrow$ slope < 0 in Quadrant III.
 For $|y| > |x|$, $y > 0$, $x < 0$, $y' = x + y \Rightarrow$ slope > 0 in Quadrant II above $y = -x$.
 For $|y| < |x|$, $y > 0$, $x < 0$, $y' = x + y \Rightarrow$ slope < 0 in Quadrant II below $y = -x$.
 For $|y| < |x|$, $x > 0$, $y < 0$, $y' = x + y \Rightarrow$ slope > 0 in Quadrant IV above $y = -x$.
 For $|y| > |x|$, $x > 0$, $y < 0$, $y' = x + y \Rightarrow$ slope < 0 in Quadrant IV below $y = -x$.
 All of the conditions are seen in slope field (d).

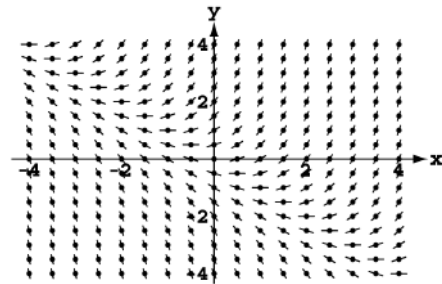

20. $y' = y + 1 \Rightarrow$ slope is constant for a given value of y , slope is 0 for $y = -1$, slope is positive for $y > -1$ and negative for $y < -1$. These characteristics are evident in slope field (c).

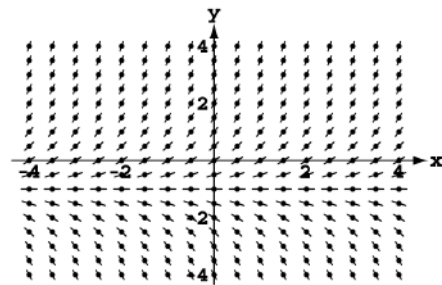

21. $y' = -\frac{x}{y} \Rightarrow$ slope = 1 on $y = -x$ and -1 on $y = x$.
 $y' = -\frac{x}{y} \Rightarrow$ slope = 0 on the y -axis, excluding $(0, 0)$,
 and is undefined on the x -axis. Slopes are positive for $x > 0, y < 0$ and $x < 0, y > 0$ (Quadrants II and IV),
 otherwise negative. Field (a) is consistent with these conditions.

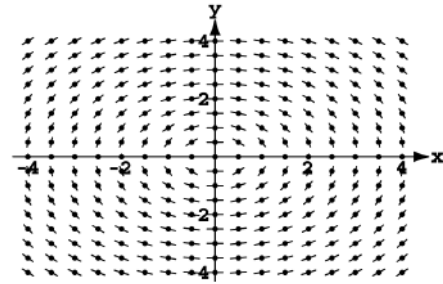

22. $y' = y^2 - x^2 \Rightarrow$ slope is 0 for $y = x$ and for $y = -x$.
 For $|y| > |x|$ slope is positive and for $|y| < |x|$ slope is negative. Field (b) has these characteristics.

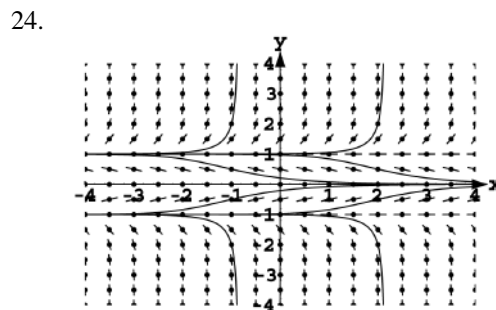
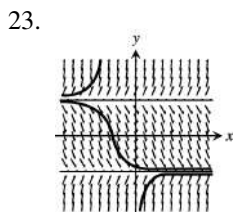
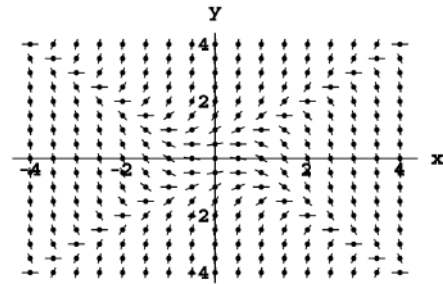

25-36. Example CAS commands:

Maple:

```
ode := diff( y(x), x ) = y(x);
icA := [0, 1];
icB := [0, 2];
icC := [0,-1];
DEplot( ode, y(x), x=0..2, [icA,icB,icC], arrows=slim, linecolor=blue, title="#25 (Section 9.1)" );
```

Mathematica:

To plot vector fields, you must begin by loading a graphics package.

```
<<Graphics`PlotField`
```

To control lengths and appearance of vectors, select the Help browser, type PlotVectorField and select Go.

```
Clear[x, y, f]
yprime = y (2 - y);
pv = PlotVectorField[{1, yprime}, {x, -5, 5}, {y, -4, 6}, Axes -> True, AxesLabel -> {x, y}];
```

To draw solution curves with Mathematica, you must first solve the differential equation. This will be done with the DSolve command. The $y[x]$ and x at the end of the command specify the dependent and independent variables.

The command will not work unless the y in the differential equation is referenced as $y[x]$.

```
equation = y'[x] == y[x] (2 - y[x]) ;
initcond = y[a] == b;
sols = DSolve[{equation, initcond}, y[x], x]
vals = {{0, 1/2}, {0, 3/2}, {0, 2}, {0, 3}}
f[{a_, b_}] = sols[[1, 1, 2]];
```

```
solnset = Map[f, vals]
ps = Plot[Evaluate[solnset, {x, -5, 5}];
Show[pv, ps, PlotRange -> {-4, 6}];
```

The code for problems such as 33 & 34 is similar for the direction field, but the analytical solutions involve complicated inverse functions, so the numerical solver NDSolve is used. Note that a domain interval is specified.

```
equation = y'[x] == Cos[2x - y[x]] ;
initcond = y[0] == 2;
sol = NDSolve[{equation, initcond}, y[x], {x, 0, 5}]
ps = Plot[Evaluate[y[x]/.sol, {x, 0, 5}];
N[y[x] /. sol/.x -> 2]
Show[pv, ps, PlotRange -> {0, 5}];
```

Solutions for 35 can be found one at a time and plots named and shown together. No direction fields here.

For 36, the direction field code is similar, but the solution is found implicitly using integrations. The plot requires loading another special graphics package.

```
<<Graphics`ImplicitPlot`
Clear[x,y]
solution[c_] = Integrate[2 (y - 1), y] == Integrate[3x^2 + 4x + 2, x] + c
values = {-6, -4, -2, 0, 2, 4, 6};
solns = Map[solution, values];
ps = ImplicitPlot[solns, {x, -3, 3}, {y, -3, 3}]
Show[pv, ps]
```

25.

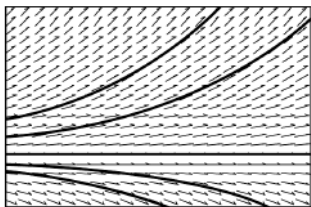

26.

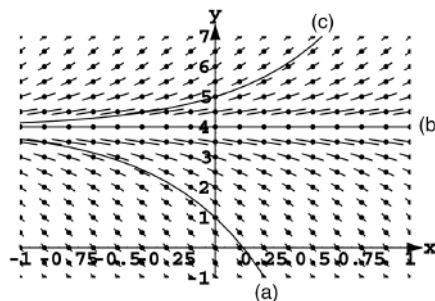

27.

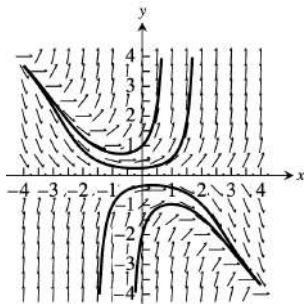

28.

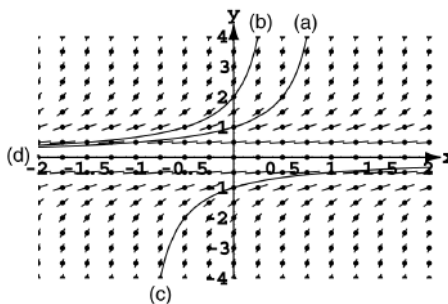

29.

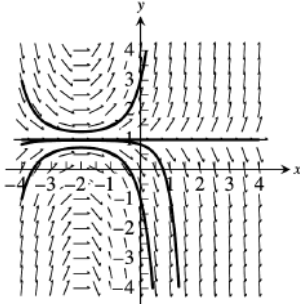

30.

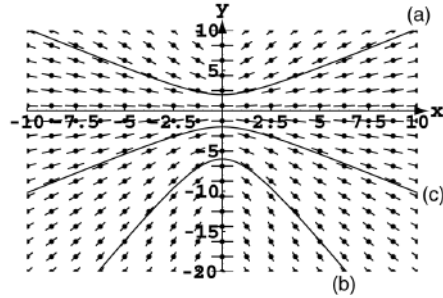

9.2 FIRST-ORDER LINEAR DIFFERENTIAL EQUATIONS

- $x \frac{dy}{dx} + y = e^x \Rightarrow \frac{dy}{dx} + \left(\frac{1}{x}\right)y = \frac{e^x}{x}$, $P(x) = \frac{1}{x}$, $Q(x) = \frac{e^x}{x}$
 $\int P(x) dx = \int \frac{1}{x} dx = \ln|x| = \ln x$, $x > 0 \Rightarrow v(x) = e^{\int P(x) dx} = e^{\ln x} = x$
 $y = \frac{1}{v(x)} \int v(x) Q(x) dx = \frac{1}{x} \int x \left(\frac{e^x}{x}\right) dx = \frac{1}{x} (e^x + C) = \frac{e^x + C}{x}$, $x > 0$
- $e^x \frac{dy}{dx} + 2e^x y = 1 \Rightarrow \frac{dy}{dx} + 2y = e^{-x}$, $P(x) = 2$, $Q(x) = e^{-x}$
 $\int P(x) dx = \int 2 dx = 2x \Rightarrow v(x) = e^{\int P(x) dx} = e^{2x}$
 $y = \frac{1}{e^{2x}} \int e^{2x} \cdot e^{-x} dx = \frac{1}{e^{2x}} \int e^x dx = \frac{1}{e^{2x}} (e^x + C) = e^{-x} + Ce^{-2x}$
- $xy' + 3y = \frac{\sin x}{x^2}$, $x > 0 \Rightarrow \frac{dy}{dx} + \left(\frac{3}{x}\right)y = \frac{\sin x}{x^3}$, $P(x) = \frac{3}{x}$, $Q(x) = \frac{\sin x}{x^3}$
 $\int \frac{3}{x} dx = 3 \ln|x| = \ln x^3$, $x > 0 \Rightarrow v(x) = e^{\ln x^3} = x^3$
 $y = \frac{1}{x^3} \int x^3 \left(\frac{\sin x}{x^3}\right) dx = \frac{1}{x^3} \int \sin x dx = \frac{1}{x^3} (-\cos x + C) = \frac{C - \cos x}{x^3}$, $x > 0$
- $y' + (\tan x)y = \cos^2 x$, $-\frac{\pi}{2} < x < \frac{\pi}{2} \Rightarrow \frac{dy}{dx} + (\tan x)y = \cos^2 x$, $P(x) = \tan x$, $Q(x) = \cos^2 x$
 $\int \tan x dx = \int \frac{\sin x}{\cos x} dx = -\ln|\cos x| = \ln(\cos x)^{-1}$, $-\frac{\pi}{2} < x < \frac{\pi}{2} \Rightarrow v(x) = e^{\ln(\cos x)^{-1}} = (\cos x)^{-1}$
 $y = \frac{1}{(\cos x)^{-1}} \int (\cos x)^{-1} \cdot \cos^2 x dx = (\cos x) \int \cos x dx = (\cos x)(\sin x + C) = \sin x \cos x + C \cos x$
- $x \frac{dy}{dx} + 2y = 1 - \frac{1}{x}$, $x > 0 \Rightarrow \frac{dy}{dx} + \left(\frac{2}{x}\right)y = \frac{1}{x} - \frac{1}{x^2}$, $P(x) = \frac{2}{x}$, $Q(x) = \frac{1}{x} - \frac{1}{x^2}$
 $\int \frac{2}{x} dx = 2 \ln|x| = \ln x^2$, $x > 0 \Rightarrow v(x) = e^{\ln x^2} = x^2$
 $y = \frac{1}{x^2} \int x^2 \left(\frac{1}{x} - \frac{1}{x^2}\right) dx = \frac{1}{x^2} \int (x - \frac{1}{x}) dx = \frac{1}{x^2} \left(\frac{x^2}{2} - x + C\right) = \frac{1}{2} - \frac{1}{x} + \frac{C}{x^2}$, $x > 0$
- $(1+x)y' + y = \sqrt{x} \Rightarrow \frac{dy}{dx} + \left(\frac{1}{1+x}\right)y = \frac{\sqrt{x}}{1+x}$, $P(x) = \frac{1}{1+x}$, $Q(x) = \frac{\sqrt{x}}{1+x}$
 $\int \frac{1}{1+x} dx = \ln(1+x)$, since $x > 0 \Rightarrow v(x) = e^{\ln(1+x)} = 1+x$
 $y = \frac{1}{1+x} \int (1+x) \left(\frac{\sqrt{x}}{1+x}\right) dx = \frac{1}{1+x} \int \sqrt{x} dx = \left(\frac{1}{1+x}\right) \left(\frac{2}{3} x^{3/2} + C\right) = \frac{2x^{3/2}}{3(1+x)} + \frac{C}{1+x}$
- $\frac{dy}{dx} - \frac{1}{2}y = \frac{1}{2}e^{x/2} \Rightarrow P(x) = -\frac{1}{2}$, $Q(x) = \frac{1}{2}e^{x/2} \Rightarrow \int P(x) dx = -\frac{1}{2}x \Rightarrow v(x) = e^{-x/2}$
 $\Rightarrow y = \frac{1}{e^{-x/2}} \int e^{-x/2} \left(\frac{1}{2}e^{x/2}\right) dx = e^{x/2} \int \frac{1}{2} dx = e^{x/2} \left(\frac{1}{2}x + C\right) = \frac{1}{2}xe^{x/2} + Ce^{x/2}$
- $\frac{dy}{dx} + 2y = 2xe^{-2x} \Rightarrow P(x) = 2$, $Q(x) = 2xe^{-2x} \Rightarrow \int P(x) dx = \int 2 dx = 2x \Rightarrow v(x) = e^{2x}$
 $\Rightarrow y = \frac{1}{e^{2x}} \int e^{2x} (2xe^{-2x}) dx = \frac{1}{e^{2x}} \int 2x dx = e^{-2x} (x^2 + C) = x^2 e^{-2x} + Ce^{-2x}$

9. $\frac{dy}{dx} - \left(\frac{1}{x}\right)y = 2 \ln x \Rightarrow P(x) = -\frac{1}{x}, Q(x) = 2 \ln x \Rightarrow \int P(x) dx = -\int \frac{1}{x} dx = -\ln x, x > 0$
 $\Rightarrow v(x) = e^{-\ln x} = \frac{1}{x} \Rightarrow y = x \int \left(\frac{1}{x}\right)(2 \ln x) dx = x[(\ln x)^2 + C] = x(\ln x)^2 + Cx$
10. $\frac{dy}{dx} + \left(\frac{2}{x}\right)y = \frac{\cos x}{x^2}, x > 0 \Rightarrow P(x) = \frac{2}{x}, Q(x) = \frac{\cos x}{x^2} \Rightarrow \int P(x) dx = \int \frac{2}{x} dx = 2 \ln |x| = \ln x^2, x > 0$
 $\Rightarrow v(x) = e^{\ln x^2} = x^2 \Rightarrow y = \frac{1}{x^2} \int x^2 \left(\frac{\cos x}{x^2}\right) dx = \frac{1}{x^2} \int \cos x dx = \frac{1}{x^2}(\sin x + C) = \frac{\sin x + C}{x^2}$
11. $\frac{ds}{dt} + \left(\frac{4}{t-1}\right)s = \frac{t+1}{(t-1)^3} \Rightarrow P(t) = \frac{4}{t-1}, Q(t) = \frac{t+1}{(t-1)^3} \Rightarrow \int P(t) dt = \int \frac{4}{t-1} dt = 4 \ln |t-1| = \ln(t-1)^4$
 $\Rightarrow v(t) = e^{\ln(t-1)^4} = (t-1)^4 \Rightarrow s = \frac{1}{(t-1)^4} \int (t-1)^4 \left[\frac{t+1}{(t-1)^3}\right] dt = \frac{1}{(t-1)^4} \int (t^2 - 1) dt$
 $= \frac{1}{(t-1)^4} \left(\frac{t^3}{3} - t + C\right) = \frac{t^3}{3(t-1)^4} - \frac{t}{(t-1)^4} + \frac{C}{(t-1)^4}$
12. $(t+1)\frac{ds}{dt} + 2s = 3(t+1) + \frac{1}{(t+1)^2} \Rightarrow \frac{ds}{dt} + \left(\frac{2}{t+1}\right)s = 3 + \frac{1}{(t+1)^3} \Rightarrow P(t) = \frac{2}{t+1}, Q(t) = 3 + (t+1)^{-3}$
 $\Rightarrow \int P(t) dt = \int \frac{2}{t+1} dt = 2 \ln |t+1| = \ln(t+1)^2 \Rightarrow v(t) = e^{\ln(t+1)^2} = (t+1)^2$
 $\Rightarrow s = \frac{1}{(t+1)^2} \int (t+1)^2 [3 + (t+1)^{-3}] dt = \frac{1}{(t+1)^2} \int [3(t+1)^2 + (t+1)^{-1}] dt$
 $= \frac{1}{(t+1)^2} [(t+1)^3 + \ln |t+1| + C] = (t+1) + (t+1)^{-2} \ln(t+1) + \frac{C}{(t+1)^2}, t > -1$
13. $\frac{dr}{d\theta} + (\cot \theta)r = \sec \theta \Rightarrow P(\theta) = \cot \theta, Q(\theta) = \sec \theta \Rightarrow \int P(\theta) d\theta = \int \cot \theta d\theta = \ln |\sin \theta| \Rightarrow v(\theta) = e^{\ln |\sin \theta|}$
 $= \sin \theta$ because $0 < \theta < \frac{\pi}{2} \Rightarrow r = \frac{1}{\sin \theta} \int (\sin \theta)(\sec \theta) d\theta = \frac{1}{\sin \theta} \int \tan \theta d\theta = \frac{1}{\sin \theta} (\ln |\sec \theta| + C)$
 $= (\csc \theta) (\ln |\sec \theta| + C)$
14. $\tan \theta \frac{dr}{d\theta} + r = \sin^2 \theta \Rightarrow \frac{dr}{d\theta} + \frac{r}{\tan \theta} = \frac{\sin^2 \theta}{\tan \theta} \Rightarrow \frac{dr}{d\theta} + (\cot \theta)r = \sin \theta \cos \theta \Rightarrow P(\theta) = \cot \theta, Q(\theta) = \sin \theta \cos \theta$
 $\Rightarrow \int P(\theta) d\theta = \int \cot \theta d\theta = \ln |\sin \theta| = \ln(\sin \theta)$ since $0 < \theta < \frac{\pi}{2} \Rightarrow v(\theta) = e^{\ln(\sin \theta)} = \sin \theta$
 $\Rightarrow r = \frac{1}{\sin \theta} \int (\sin \theta)(\sin \theta \cos \theta) d\theta = \frac{1}{\sin \theta} \int \sin^2 \theta \cos \theta d\theta = \left(\frac{1}{\sin \theta}\right) \left(\frac{\sin^3 \theta}{3} + C\right) = \frac{\sin^2 \theta}{3} + \frac{C}{\sin \theta}$
15. $\frac{dy}{dt} + 2y = 3 \Rightarrow P(t) = 2, Q(t) = 3 \Rightarrow \int P(t) dt = \int 2 dt = 2t \Rightarrow v(t) = e^{2t} \Rightarrow y = \frac{1}{e^{2t}} \int 3e^{2t} dt$
 $= \frac{1}{e^{2t}} \left(\frac{3}{2} e^{2t} + C\right); y(0) = 1 \Rightarrow \frac{3}{2} + C = 1 \Rightarrow C = -\frac{1}{2} \Rightarrow y = \frac{3}{2} - \frac{1}{2} e^{-2t}$
16. $\frac{dy}{dt} + \frac{2y}{t} = t^2 \Rightarrow P(t) = \frac{2}{t}, Q(t) = t^2 \Rightarrow \int P(t) dt = 2 \ln |t| \Rightarrow v(t) = e^{\ln t^2} = t^2 \Rightarrow y = \frac{1}{t^2} \int (t^2)(t^2) dt$
 $= \frac{1}{t^2} \int t^4 dt = \frac{1}{t^2} \left(\frac{t^5}{5} + C\right) = \frac{t^3}{5} + \frac{C}{t^2}; y(2) = 1 \Rightarrow \frac{8}{5} + \frac{C}{4} = 1 \Rightarrow C = -\frac{12}{5} \Rightarrow y = \frac{t^3}{5} - \frac{12}{5t^2}$
17. $\frac{dy}{d\theta} + \left(\frac{1}{\theta}\right)y = \frac{\sin \theta}{\theta} \Rightarrow P(\theta) = \frac{1}{\theta}, Q(\theta) = \frac{\sin \theta}{\theta} \Rightarrow \int P(\theta) d\theta = \ln |\theta| \Rightarrow v(\theta) = e^{\ln |\theta|} = |\theta|$
 $\Rightarrow y = \frac{1}{|\theta|} \int |\theta| \left(\frac{\sin \theta}{\theta}\right) d\theta = \frac{1}{\theta} \int \theta \left(\frac{\sin \theta}{\theta}\right) d\theta$ for $\theta \neq 0 \Rightarrow y = \frac{1}{\theta} \int \sin \theta d\theta = \frac{1}{\theta} (-\cos \theta + C)$
 $= -\frac{1}{\theta} \cos \theta + \frac{C}{\theta}; y\left(\frac{\pi}{2}\right) = 1 \Rightarrow C = \frac{\pi}{2} \Rightarrow y = -\frac{1}{\theta} \cos \theta + \frac{\pi}{2\theta}$
18. $\frac{dy}{d\theta} - \left(\frac{2}{\theta}\right)y = \theta^2 \sec \theta \tan \theta \Rightarrow P(\theta) = -\frac{2}{\theta}, Q(\theta) = \theta^2 \sec \theta \tan \theta \Rightarrow \int P(\theta) d\theta = -2 \ln |\theta| \Rightarrow v(\theta) = e^{-2 \ln |\theta|}$
 $= \theta^{-2} \Rightarrow y = \frac{1}{\theta^{-2}} \int (\theta^{-2})(\theta^2 \sec \theta \tan \theta) d\theta = \theta^2 \int \sec \theta \tan \theta d\theta = \theta^2 (\sec \theta + C) = \theta^2 \sec \theta + C\theta^2;$
 $y\left(\frac{\pi}{3}\right) = 2 \Rightarrow 2 = \left(\frac{\pi^2}{9}\right)(2) + C\left(\frac{\pi^2}{9}\right) \Rightarrow C = \frac{18}{\pi^2} - 2 \Rightarrow y = \theta^2 \sec \theta + \left(\frac{18}{\pi^2} - 2\right)\theta^2$

$$19. (x+1) \frac{dy}{dx} - 2(x^2+x)y = \frac{e^{x^2}}{x+1} \Rightarrow \frac{dy}{dx} - 2 \left[\frac{x(x+1)}{x+1} \right] y = \frac{e^{x^2}}{(x+1)^2} \Rightarrow \frac{dy}{dx} - 2xy = \frac{e^{x^2}}{(x+1)^2} \Rightarrow P(x) = -2x,$$

$$Q(x) = \frac{e^{x^2}}{(x+1)^2} \Rightarrow \int P(x) dx = \int -2x dx = -x^2 \Rightarrow v(x) = e^{-x^2} \Rightarrow y = \frac{1}{e^{-x^2}} \int e^{-x^2} \left[\frac{e^{x^2}}{(x+1)^2} \right] dx$$

$$= e^{x^2} \int \frac{1}{(x+1)^2} dx = e^{x^2} \left[\frac{(x+1)^{-1}}{-1} + C \right] = -\frac{e^{x^2}}{x+1} + Ce^{x^2}; y(0) = 5 \Rightarrow -\frac{1}{0+1} + C = 5 \Rightarrow -1 + C = 5$$

$$\Rightarrow C = 6 \Rightarrow y = 6e^{x^2} - \frac{e^{x^2}}{x+1}$$

$$20. \frac{dy}{dx} + xy = x \Rightarrow P(x) = x, Q(x) = x \Rightarrow \int P(x) dx = \int x dx = \frac{x^2}{2} \Rightarrow v(x) = e^{x^2/2} \Rightarrow y = \frac{1}{e^{x^2/2}} \int e^{x^2/2} \cdot x dx$$

$$= \frac{1}{e^{x^2/2}} \left(e^{x^2/2} + C \right) = 1 + \frac{C}{e^{x^2/2}}; y(0) = -6 \Rightarrow 1 + C = -6 \Rightarrow C = -7 \Rightarrow y = 1 - \frac{7}{e^{x^2/2}}$$

$$21. \frac{dy}{dt} - ky = 0 \Rightarrow P(t) = -k, Q(t) = 0 \Rightarrow \int P(t) dt = \int -k dt = -kt \Rightarrow v(t) = e^{-kt}$$

$$\Rightarrow y = \frac{1}{e^{-kt}} \int (e^{-kt}) (0) dt = e^{kt} (0 + C) = Ce^{kt}; y(0) = y_0 \Rightarrow C = y_0 \Rightarrow y = y_0 e^{kt}$$

$$22. (a) \frac{dv}{dt} + \frac{k}{m} v = 0 \Rightarrow P(t) = \frac{k}{m}, Q(t) = 0 \Rightarrow \int P(t) dt = \int \frac{k}{m} dt = \frac{k}{m} t = \frac{kt}{m} \Rightarrow v(t) = e^{kt/m}$$

$$\Rightarrow y = \frac{1}{e^{kt/m}} \int e^{kt/m} \cdot 0 dt = \frac{C}{e^{kt/m}}; v(0) = v_0 \Rightarrow \frac{C}{e^{k(0)/m}} = v_0 \Rightarrow C = v_0 \Rightarrow v = v_0 e^{-(k/m)t}$$

$$(b) \frac{dv}{dt} = -\frac{k}{m} v \Rightarrow \frac{dv}{v} = -\frac{k}{m} dt \Rightarrow \ln v = -\frac{k}{m} t + C \Rightarrow v = e^{-(k/m)t+C} \Rightarrow v = e^{-(k/m)t} \cdot e^C. \text{ Let } e^C = C_1.$$

$$\text{Then } v = \frac{1}{e^{(k/m)t}} \cdot C_1 \text{ and } v(0) = v_0 = \frac{1}{e^{(k/m)(0)}} \cdot C_1 = C_1. \text{ So } v = v_0 e^{-(k/m)t}$$

$$23. x \int \frac{1}{x} dx = x (\ln |x| + C) = x \ln |x| + Cx \Rightarrow (b) \text{ is correct}$$

$$24. \frac{1}{\cos x} \int \cos x dx = \frac{1}{\cos x} (\sin x + C) = \tan x + \frac{C}{\cos x} \Rightarrow (b) \text{ is correct}$$

25. Let $y(t)$ = the amount of salt in the container and $V(t)$ = the total volume of liquid in the tank at time t .

Then, the departure rate is $\frac{y(t)}{V(t)}$ (the outflow rate).

$$(a) \text{ Rate entering} = \frac{2 \text{ lb}}{\text{gal}} \cdot \frac{5 \text{ gal}}{\text{min}} = 10 \text{ lb/min}$$

$$(b) \text{ Volume} = V(t) = 100 \text{ gal} + (5t \text{ gal} - 4t \text{ gal}) = (100 + t) \text{ gal}$$

$$(c) \text{ The volume at time } t \text{ is } (100 + t) \text{ gal. The amount of salt in the tank at time } t \text{ is } y \text{ lbs. So the concentration at any time } t \text{ is } \frac{y}{100+t} \text{ lbs/gal. Then, the rate leaving} = \frac{y}{100+t} (\text{lbs/gal}) \cdot 4 (\text{gal/min})$$

$$= \frac{4y}{100+t} \text{ lbs/min}$$

$$(d) \frac{dy}{dt} = 10 - \frac{4y}{100+t} \Rightarrow \frac{dy}{dt} + \left(\frac{4}{100+t} \right) y = 10 \Rightarrow P(t) = \frac{4}{100+t}, Q(t) = 10 \Rightarrow \int P(t) dt = \int \frac{4}{100+t} dt$$

$$= 4 \ln(100+t) \Rightarrow v(t) = e^{4 \ln(100+t)} = (100+t)^4 \Rightarrow y = \frac{1}{(100+t)^4} \int (100+t)^4 (10 dt)$$

$$= \frac{10}{(100+t)^4} \left(\frac{(100+t)^5}{5} + C \right) = 2(100+t) + \frac{C}{(100+t)^4}; y(0) = 50 \Rightarrow 2(100+0) + \frac{C}{(100+0)^4} = 50$$

$$\Rightarrow C = -(150)(100)^4 \Rightarrow y = 2(100+t) - \frac{(150)(100)^4}{(100+t)^4} \Rightarrow y = 2(100+t) - \frac{150}{\left(1 + \frac{t}{100}\right)^4}$$

$$(e) y(25) = 2(100+25) - \frac{(150)(100)^4}{(100+25)^4} \approx 188.56 \text{ lbs} \Rightarrow \text{concentration} = \frac{y(25)}{\text{volume}} \approx \frac{188.6}{125} \approx 1.5 \text{ lb/gal}$$

$$26. (a) \frac{dV}{dt} = (5-3) = 2 \Rightarrow V = 100 + 2t$$

The tank is full when $V = 200 = 100 + 2t \Rightarrow t = 50$ min

(b) Let $y(t)$ be the amount of concentrate in the tank at time t .

$$\frac{dy}{dt} = \left(\frac{1 \text{ lb}}{2 \text{ gal}} \right) \left(5 \frac{\text{gal}}{\text{min}} \right) - \left(\frac{y}{100+2t} \frac{\text{lb}}{\text{gal}} \right) \left(3 \frac{\text{gal}}{\text{min}} \right) \Rightarrow \frac{dy}{dt} = \frac{5}{2} - \frac{3}{2} \left(\frac{y}{50+t} \right) \Rightarrow \frac{dy}{dt} + \frac{3}{2(50+t)} y = \frac{5}{2}$$

$$Q(t) = \frac{5}{2}; P(t) = \frac{3}{2} \left(\frac{1}{50+t} \right) \Rightarrow \int P(t) dt = \frac{3}{2} \int \frac{1}{t+50} dt = \frac{3}{2} \ln(t+50) \text{ since } t+50 > 0$$

$$v(t) = e^{\int P(t) dt} = e^{\frac{3}{2} \ln(t+50)} = (t+50)^{3/2}$$

$$y(t) = \frac{1}{(t+50)^{3/2}} \int \frac{5}{2}(t+50)^{3/2} dt = (t+50)^{-3/2} [(t+50)^{5/2} + C] \Rightarrow y(t) = t+50 + \frac{C}{(t+50)^{3/2}}$$

Apply the initial condition (i.e., distilled water in the tank at $t = 0$):

$$y(0) = 0 = 50 + \frac{C}{50^{3/2}} \Rightarrow C = -50^{5/2} \Rightarrow y(t) = t+50 - \frac{50^{5/2}}{(t+50)^{3/2}}. \text{ When the tank is full at } t = 50,$$

$$y(50) = 100 - \frac{50^{5/2}}{100^{3/2}} \approx 83.22 \text{ pounds of concentrate.}$$

27. Let y be the amount of fertilizer in the tank at time t . Then rate entering $= 1 \frac{\text{lb}}{\text{gal}} \cdot 1 \frac{\text{gal}}{\text{min}} = 1 \frac{\text{lb}}{\text{min}}$ and the volume in the tank at time t is $V(t) = 100 \text{ (gal)} + [1 \text{ (gal/min)} - 3 \text{ (gal/min)}]t \text{ min} = (100 - 2t) \text{ gal}$. Hence rate out $= \left(\frac{y}{100-2t}\right) 3 = \frac{3y}{100-2t} \text{ lbs/min} \Rightarrow \frac{dy}{dt} = \left(1 - \frac{3y}{100-2t}\right) \text{ lbs/min} \Rightarrow \frac{dy}{dt} + \left(\frac{3}{100-2t}\right) y = 1$
 $\Rightarrow P(t) = \frac{3}{100-2t}, Q(t) = 1 \Rightarrow \int P(t) dt = \int \frac{3}{100-2t} dt = \frac{3 \ln(100-2t)}{-2} \Rightarrow v(t) = e^{(-3 \ln(100-2t)/2)}$
 $= (100-2t)^{-3/2} \Rightarrow y = \frac{1}{(100-2t)^{-3/2}} \int (100-2t)^{-3/2} dt = (100-2t)^{-3/2} \left[\frac{-2(100-2t)^{-1/2}}{-2} + C \right]$
 $= (100-2t) + C(100-2t)^{3/2}; y(0) = 0 \Rightarrow [100 - 2(0)] + C[100 - 2(0)]^{3/2} \Rightarrow C(100)^{3/2} = -100$
 $\Rightarrow C = -(100)^{-1/2} = -\frac{1}{10} \Rightarrow y = (100-2t) - \frac{(100-2t)^{3/2}}{10}$. Let $\frac{dy}{dt} = 0 \Rightarrow \frac{dy}{dt} = -2 - \frac{(\frac{3}{2})(100-2t)^{1/2}(-2)}{10}$
 $= -2 + \frac{3\sqrt{100-2t}}{10} = 0 \Rightarrow 20 = 3\sqrt{100-2t} \Rightarrow 400 = 9(100-2t) \Rightarrow 400 = 900 - 18t \Rightarrow -500 = -18t$
 $\Rightarrow t \approx 27.8 \text{ min, the time to reach the maximum. The maximum amount is then}$
 $y(27.8) = [100 - 2(27.8)] - \frac{[100 - 2(27.8)]^{3/2}}{10} \approx 14.8 \text{ lb}$

28. Let $y = y(t)$ be the amount of carbon monoxide (CO) in the room at time t . The amount of CO entering the room is $\left(\frac{4}{100} \times \frac{3}{10}\right) = \frac{12}{1000} \text{ ft}^3/\text{min}$, and the amount of CO leaving the room is $\left(\frac{y}{4500}\right) \left(\frac{3}{10}\right) = \frac{y}{15,000} \text{ ft}^3/\text{min}$. Thus, $\frac{dy}{dt} = \frac{12}{1000} - \frac{y}{15,000} \Rightarrow \frac{dy}{dt} + \frac{1}{15,000} y = \frac{12}{1000} \Rightarrow P(t) = \frac{1}{15,000}, Q(t) = \frac{12}{1000} \Rightarrow v(t) = e^{t/15,000}$
 $\Rightarrow y = \frac{1}{e^{t/15,000}} \int \frac{12}{1000} e^{t/15,000} dt \Rightarrow y = e^{-t/15,000} \left(\frac{12 \cdot 15,000}{1000} e^{t/15,000} + C\right) = e^{-t/15,000} (180e^{t/15,000} + C)$;
 $y(0) = 0 \Rightarrow 0 = 1(180 + C) \Rightarrow C = -180 \Rightarrow y = 180 - 180e^{-t/15,000}$. When the concentration of CO is 0.01% in the room, the amount of CO satisfies $\frac{y}{4500} = \frac{0.01}{100} \Rightarrow y = 0.45 \text{ ft}^3$. When the room contains this amount we have $0.45 = 180 - 180e^{-t/15,000} \Rightarrow \frac{179.55}{180} = e^{-t/15,000} \Rightarrow t = -15,000 \ln\left(\frac{179.55}{180}\right) \approx 37.55 \text{ min}$.

29. Steady State $= \frac{V}{R}$ and we want $i = \frac{1}{2} \left(\frac{V}{R}\right) \Rightarrow \frac{1}{2} \left(\frac{V}{R}\right) = \frac{V}{R} (1 - e^{-Rt/L}) \Rightarrow \frac{1}{2} = 1 - e^{-Rt/L} \Rightarrow -\frac{1}{2} = -e^{-Rt/L}$
 $\Rightarrow \ln \frac{1}{2} = -\frac{Rt}{L} \Rightarrow -\frac{L}{R} \ln \frac{1}{2} = t \Rightarrow t = \frac{L}{R} \ln 2 \text{ sec}$

30. (a) $\frac{di}{dt} + \frac{R}{L} i = 0 \Rightarrow \frac{1}{i} di = -\frac{R}{L} dt \Rightarrow \ln i = -\frac{Rt}{L} + C_1 \Rightarrow i = e^{C_1} e^{-Rt/L} = C e^{-Rt/L}; i(0) = I \Rightarrow I = C$
 $\Rightarrow i = I e^{-Rt/L} \text{ amp}$
 (b) $\frac{1}{2} I = I e^{-Rt/L} \Rightarrow e^{-Rt/L} = \frac{1}{2} \Rightarrow -\frac{Rt}{L} = \ln \frac{1}{2} = -\ln 2 \Rightarrow t = \frac{L}{R} \ln 2 \text{ sec}$
 (c) $t = \frac{L}{R} \Rightarrow i = I e^{(-Rt/L)(L/R)} = I e^{-1} \text{ amp}$

31. (a) $t = \frac{3L}{R} \Rightarrow i = \frac{V}{R} (1 - e^{(-R/L)(3L/R)}) = \frac{V}{R} (1 - e^{-3}) \approx 0.9502 \frac{V}{R} \text{ amp, or about 95\% of the steady state value}$
 (b) $t = \frac{2L}{R} \Rightarrow i = \frac{V}{R} (1 - e^{(-R/L)(2L/R)}) = \frac{V}{R} (1 - e^{-2}) \approx 0.8647 \frac{V}{R} \text{ amp, or about 86\% of the steady state value}$

32. (a) $\frac{di}{dt} + \frac{R}{L} i = \frac{V}{L} \Rightarrow P(t) = \frac{R}{L}, Q(t) = \frac{V}{L} \Rightarrow \int P(t) dt = \int \frac{R}{L} dt = \frac{Rt}{L} \Rightarrow v(t) = e^{Rt/L}$
 $\Rightarrow i = \frac{1}{e^{Rt/L}} \int e^{Rt/L} \left(\frac{V}{L}\right) dt = \frac{1}{e^{Rt/L}} \left[\frac{L}{R} e^{Rt/L} \left(\frac{V}{L}\right) + C\right] = \frac{V}{R} + C e^{-Rt/L}$
 (b) $i(0) = 0 \Rightarrow \frac{V}{R} + C = 0 \Rightarrow C = -\frac{V}{R} \Rightarrow i = \frac{V}{R} - \frac{V}{R} e^{-Rt/L}$
 (c) $i = \frac{V}{R} \Rightarrow \frac{di}{dt} = 0 \Rightarrow \frac{di}{dt} + \frac{R}{L} i = 0 + \left(\frac{R}{L}\right) \left(\frac{V}{R}\right) = \frac{V}{L} \Rightarrow i = \frac{V}{R}$ is a solution of Eq. (11); $i = C e^{-Rt/L}$

33. $y' - y = -y^2$; we have $n = 2$, so let $u = y^{1-2} = y^{-1}$. Then $y = u^{-1}$ and $\frac{du}{dx} = -1y^{-2} \frac{dy}{dx} \Rightarrow \frac{dy}{dx} = -y^2 \frac{du}{dx}$
 $\Rightarrow -u^{-2} \frac{du}{dx} - u^{-1} = -u^{-2} \Rightarrow \frac{du}{dx} + u = 1$. With $e^{\int dx} = e^x$ as the integrating factor, we have

$$e^x \left(\frac{du}{dx} + u \right) = \frac{d}{dx}(e^x u) = e^x. \text{ Integrating, we get } e^x u = e^x + C \Rightarrow u = 1 + \frac{C}{e^x} = \frac{1}{y} \Rightarrow y = \frac{1}{1 + \frac{C}{e^x}} = \frac{e^x}{e^x + C}$$

34. $y' - y = xy^2$; we have $n = 2$, so let $u = y^{-1}$. Then $y = u^{-1}$ and $\frac{du}{dx} = -y^{-2} \frac{dy}{dx} \Rightarrow \frac{dy}{dx} = -y^2 \frac{du}{dx} = -u^{-2} \frac{du}{dx}$.

Substituting: $-u^{-2} \frac{du}{dx} - u^{-1} = xu^{-2} \Rightarrow \frac{du}{dx} + u = -x$. Using $e^{\int dx} = e^x$ as an integrating factor:

$$e^x \left(\frac{du}{dx} + u \right) = \frac{d}{dx}(e^x u) = -x e^x \Rightarrow e^x u = e^x(1 - x) + C \Rightarrow u = \frac{e^x(1-x) + C}{e^x} \Rightarrow y = u^{-1} = \frac{e^x}{e^x - xe^x + C}$$

35. $xy' + y = y^{-2} \Rightarrow y' + \left(\frac{1}{x}\right)y = \left(\frac{1}{x}\right)y^{-2}$. Let $u = y^{1-(-2)} = y^3 \Rightarrow y = u^{1/3}$ and $y^{-2} = u^{-2/3}$.

$$\frac{du}{dx} = 3y^2 \frac{dy}{dx} \Rightarrow y' = \frac{dy}{dx} = \left(\frac{1}{3}\right) \left(\frac{du}{dx}\right) (y^{-2}) = \left(\frac{1}{3}\right) \left(\frac{du}{dx}\right) (u^{-2/3}). \text{ Thus we have}$$

$$\left(\frac{1}{3}\right) \left(\frac{du}{dx}\right) (u^{-2/3}) + \left(\frac{1}{x}\right)u^{1/3} = \left(\frac{1}{x}\right)u^{-2/3} \Rightarrow \frac{du}{dx} + \left(\frac{3}{x}\right)u = \left(\frac{3}{x}\right)1. \text{ The integrating factor, } v(x), \text{ is}$$

$$e^{\int \frac{3}{x} dx} = e^{3 \ln x} = e^{\ln x^3} = x^3. \text{ Thus } \frac{d}{dx}(x^3 u) = \left(\frac{3}{x}\right)x^3 = 3x^2 \Rightarrow x^3 u = x^3 + C \Rightarrow u = 1 + \frac{C}{x^3} = y^3$$

$$\Rightarrow y = \left(1 + \frac{C}{x^3}\right)^{1/3}$$

36. $x^2 y' + 2xy = y^3 \Rightarrow y' + \left(\frac{2}{x}\right)y = \left(\frac{1}{x^2}\right)y^3$. $P(x) = \left(\frac{2}{x}\right)$, $Q(x) = \left(\frac{1}{x^2}\right)$, $n = 3$. Let $u = y^{1-3} = y^{-2}$.

Substituting gives $\frac{du}{dx} + (-2)\left(\frac{2}{x}\right)u = -2\left(\frac{1}{x^2}\right) \Rightarrow \frac{du}{dx} + \left(\frac{-4}{x}\right)u = \frac{-2}{x^2}$. Let the integrating factor, $v(x)$, be

$$e^{\int \left(\frac{-4}{x}\right) dx} = e^{\ln x^{-4}} = x^{-4}. \text{ Thus } \frac{d}{dx}(x^{-4} u) = -2x^{-6} \Rightarrow x^{-4} u = \frac{2}{5}x^{-5} + C \Rightarrow u = \frac{2}{5x} + Cx^4 = y^{-2}$$

$$\Rightarrow y = \left(\frac{2}{5x} + Cx^4\right)^{-1/2}$$

9.3 EULER'S METHOD

1. $y_1 = y_0 + \left(1 - \frac{y_0}{x_0}\right) dx = -1 + \left(1 - \frac{-1}{2}\right)(.5) = -0.25$,

$$y_2 = y_1 + \left(1 - \frac{y_1}{x_1}\right) dx = -0.25 + \left(1 - \frac{-0.25}{2.5}\right)(.5) = 0.3,$$

$$y_3 = y_2 + \left(1 - \frac{y_2}{x_2}\right) dx = 0.3 + \left(1 - \frac{0.3}{3}\right)(.5) = 0.75;$$

$$\frac{dy}{dx} + \left(\frac{1}{x}\right)y = 1 \Rightarrow P(x) = \frac{1}{x}, Q(x) = 1 \Rightarrow \int P(x) dx = \int \frac{1}{x} dx = \ln|x| = \ln x, x > 0 \Rightarrow v(x) = e^{\ln x} = x$$

$$\Rightarrow y = \frac{1}{x} \int x \cdot 1 dx = \frac{1}{x} \left(\frac{x^2}{2} + C\right); x = 2, y = -1 \Rightarrow -1 = 1 + \frac{C}{2} \Rightarrow C = -4 \Rightarrow y = \frac{x}{2} - \frac{4}{x}$$

$$\Rightarrow y(3.5) = \frac{3.5}{2} - \frac{4}{3.5} = \frac{4.25}{7} \approx 0.6071$$

2. $y_1 = y_0 + x_0(1 - y_0) dx = 0 + 1(1 - 0)(.2) = .2$,

$$y_2 = y_1 + x_1(1 - y_1) dx = .2 + 1.2(1 - .2)(.2) = .392,$$

$$y_3 = y_2 + x_2(1 - y_2) dx = .392 + 1.4(1 - .392)(.2) = .5622;$$

$$\frac{dy}{1-y} = x dx \Rightarrow -\ln|1-y| = \frac{x^2}{2} + C; x = 1, y = 0 \Rightarrow -\ln 1 = \frac{1}{2} + C \Rightarrow C = -\frac{1}{2} \Rightarrow \ln|1-y| = -\frac{x^2}{2} + \frac{1}{2}$$

$$\Rightarrow y = 1 - e^{(1-x^2)/2} \Rightarrow y(1.6) \approx .5416$$

3. $y_1 = y_0 + (2x_0 y_0 + 2y_0) dx = 3 + [2(0)(3) + 2(3)](.2) = 4.2$,

$$y_2 = y_1 + (2x_1 y_1 + 2y_1) dx = 4.2 + [2(.2)(4.2) + 2(4.2)](.2) = 6.216,$$

$$y_3 = y_2 + (2x_2 y_2 + 2y_2) dx = 6.216 + [2(.4)(6.216) + 2(6.216)](.2) = 9.6969;$$

$$\frac{dy}{dx} = 2y(x+1) \Rightarrow \frac{dy}{y} = 2(x+1) dx \Rightarrow \ln|y| = (x+1)^2 + C; x = 0, y = 3 \Rightarrow \ln 3 = 1 + C \Rightarrow C = \ln 3 - 1$$

$$\Rightarrow \ln y = (x+1)^2 + \ln 3 - 1 \Rightarrow y = e^{(x+1)^2 + \ln 3 - 1} = e^{\ln 3} e^{x^2 + 2x} = 3e^{x(x+2)} \Rightarrow y(.6) \approx 14.2765$$

4. $y_1 = y_0 + y_0^2(1 + 2x_0) dx = 1 + 1^2[1 + 2(-1)](.5) = .5$,

$$y_2 = y_1 + y_1^2(1 + 2x_1) dx = .5 + (.5)^2[1 + 2(-.5)](.5) = .5,$$

$$y_3 = y_2 + y_2^2(1 + 2x_2) dx = .5 + (.5)^2[1 + 2(0)](.5) = .625;$$

$$\frac{dy}{y^2} = (1 + 2x) dx \Rightarrow -\frac{1}{y} = x + x^2 + C; x = -1, y = 1 \Rightarrow -1 = -1 + (-1)^2 + C \Rightarrow C = -1 \Rightarrow \frac{1}{y} = 1 - x - x^2$$

$$\Rightarrow y = \frac{1}{1-x-x^2} \Rightarrow y(.5) = \frac{1}{1-.5-(.5)^2} = 4$$

5. $y_1 = y_0 + 2x_0e^{x_0^2} dx = 2 + 2(0)(.1) = 2$,
 $y_2 = y_1 + 2x_1e^{x_1^2} dx = 2 + 2(.1)e^{.1^2}(.1) = 2.0202$,
 $y_3 = y_2 + 2x_2e^{x_2^2} dx = 2.0202 + 2(.2)e^{.2^2}(.1) = 2.0618$,
 $dy = 2xe^{x^2} dx \Rightarrow y = e^{x^2} + C$; $y(0) = 2 \Rightarrow 2 = 1 + C \Rightarrow C = 1 \Rightarrow y = e^{x^2} + 1 \Rightarrow y(.3) = e^{.3^2} + 1 \approx 2.0942$
6. $y_1 = y_0 + (y_0 + e^{x_0} - 2) dx = 2 + (2 + e^0 - 2)(.5) = 2.5$,
 $y_2 = y_1 + (y_1 + e^{x_1} - 2) dx = 2.5 + (2.5 + e^{.5} - 2)(.5) = 3.5744$,
 $y_3 = y_2 + (y_2 + e^{x_2} - 2) dx = 3.5744 + (3.5744 + e^1 - 2)(.5) = 5.7207$;
 $\frac{dy}{dx} - y = e^x - 2 \Rightarrow P(x) = -1, Q(x) = e^x - 2 \Rightarrow \int P(x) dx = -x \Rightarrow v(x) = e^{-x} \Rightarrow y = \frac{1}{e^{-x}} \int e^{-x}(e^x - 2) dx$
 $= e^x(x + 2e^{-x} + C)$; $y(0) = 2 \Rightarrow 2 = 2 + C \Rightarrow C = 0 \Rightarrow y = xe^x + 2 \Rightarrow y(1.5) = 1.5e^{1.5} + 2 \approx 8.7225$
7. $y_1 = 1 + 1(.2) = 1.2$,
 $y_2 = 1.2 + (1.2)(.2) = 1.44$,
 $y_3 = 1.44 + (1.44)(.2) = 1.728$,
 $y_4 = 1.728 + (1.728)(.2) = 2.0736$,
 $y_5 = 2.0736 + (2.0736)(.2) = 2.48832$;
 $\frac{dy}{y} = dx \Rightarrow \ln y = x + C_1 \Rightarrow y = Ce^x$; $y(0) = 1 \Rightarrow 1 = Ce^0 \Rightarrow C = 1 \Rightarrow y = e^x \Rightarrow y(1) = e \approx 2.7183$
8. $y_1 = 2 + \left(\frac{2}{1}\right)(.2) = 2.4$,
 $y_2 = 2.4 + \left(\frac{2.4}{1.2}\right)(.2) = 2.8$,
 $y_3 = 2.8 + \left(\frac{2.8}{1.4}\right)(.2) = 3.2$,
 $y_4 = 3.2 + \left(\frac{3.2}{1.6}\right)(.2) = 3.6$,
 $y_5 = 3.6 + \left(\frac{3.6}{1.8}\right)(.2) = 4$;
 $\frac{dy}{y} = \frac{dx}{x} \Rightarrow \ln y = \ln x + C \Rightarrow y = kx$; $y(1) = 2 \Rightarrow 2 = k \Rightarrow y = 2x \Rightarrow y(2) = 4$
9. $y_1 = -1 + \left[\frac{(-1)^2}{\sqrt{1}}\right](.5) = -.5$,
 $y_2 = -.5 + \left[\frac{(-.5)^2}{\sqrt{1.5}}\right](.5) = -.39794$,
 $y_3 = -.39794 + \left[\frac{(-.39794)^2}{\sqrt{2}}\right](.5) = -.34195$,
 $y_4 = -.34195 + \left[\frac{(-.34195)^2}{\sqrt{2.5}}\right](.5) = -.30497$,
 $y_5 = -.27812, y_6 = -.25745, y_7 = -.24088, y_8 = -.2272$;
 $\frac{dy}{y^2} = \frac{dx}{\sqrt{x}} \Rightarrow -\frac{1}{y} = 2\sqrt{x} + C$; $y(1) = -1 \Rightarrow 1 = 2 + C \Rightarrow C = -1 \Rightarrow y = \frac{1}{1-2\sqrt{x}} \Rightarrow y(5) = \frac{1}{1-2\sqrt{5}} \approx -.2880$
10. $y_1 = 1 + (1 - e^0)\left(\frac{1}{3}\right) = 1$,
 $y_2 = 1 + (1 - e^{2/3})\left(\frac{1}{3}\right) = 0.68408$,
 $y_3 = 0.68408 + (0.68408 - e^{4/3})\left(\frac{1}{3}\right) = -0.35245$,
 $y_4 = -0.35245 + (-0.35245 - e^{6/3})\left(\frac{1}{3}\right) = -2.93295$,
 $y_5 = -2.93295 + (-2.93295 - e^{8/3})\left(\frac{1}{3}\right) = -8.70790$,
 $y_6 = -8.7079 + (-8.7079 - e^{10/3})\left(\frac{1}{3}\right) = -20.95441$;
 $y' - y = -e^{2x} \Rightarrow P(x) = -1, Q(x) = -e^{2x} \Rightarrow \int P(x) dx = -x \Rightarrow v(x) = e^{-x} \Rightarrow y = \frac{1}{e^{-x}} \int e^{-x}(-e^{2x}) dx$
 $= e^x(-e^x + C)$; $y(0) = 1 \Rightarrow 1 = -1 + C \Rightarrow C = 2 \Rightarrow y = -e^{2x} + 2e^x \Rightarrow y(2) = -e^4 + 2e^2 \approx -39.8200$
11. Let $z_n = y_{n-1} + 2y_{n-1}(x_{n-1} + 1)dx$ and $y_n = y_{n-1} + (y_{n-1}(x_{n-1} + 1) + z_n(x_n + 1))dx$ with $x_0 = 0, y_0 = 3$, and $dx = 0.2$.
The exact solution is $y = 3e^{x(x+2)}$. Using a programmable calculator or a spreadsheet (I used a spreadsheet) gives the values in the following table.

x	z	y-approx	y-exact	Error
0	---	3	3	0
0.2	4.2	4.608	4.658122	0.050122
0.4	6.81984	7.623475	7.835089	0.211614
0.6	11.89262	13.56369	14.27646	0.712777

12. Let $z_n = y_{n-1} + x_{n-1}(1 - y_{n-1})dx$ and $y_n = y_{n-1} + \left(\frac{x_{n-1}(1 - y_{n-1}) + x_n(1 - z_n)}{2}\right)dx$ with $x_0 = 1$, $y_0 = 0$, and $dx = 0.2$.

The exact solution is $y = 1 - e^{(1-x^2)/2}$. Using a programmable calculator or a spreadsheet (I used a spreadsheet) gives the values in the following table.

x	z	y-approx	y-exact	Error
1	---	0	0	0
1.2	0.2	1.196	0.197481	0.001481
1.4	0.38896	0.378026	0.381217	0.003191
1.6	0.552178	0.536753	0.541594	0.004841

13. $\frac{dy}{dx} = 2xe^{x^2}$, $y(0) = 2 \Rightarrow y_{n+1} = y_n + 2x_n e^{x_n^2} dx = y_n + 2x_n e^{x_n^2} (0.1) = y_n + 0.2x_n e^{x_n^2}$

On a TI-92 Plus calculator home screen, type the following commands:

2 STO > y: 0 STO > x: y (enter)

$y + 0.2 * x * e^{(x^2)}$ STO > y: x + 0.1 STO > x: y (enter, 10 times)

The last value displayed gives $y_{\text{Euler}}(1) \approx 3.45835$

The exact solution: $dy = 2xe^{x^2} dx \Rightarrow y = e^{x^2} + C$; $y(0) = 2 = e^0 + C \Rightarrow C = 1 \Rightarrow y = 1 + e^{x^2}$

$\Rightarrow y_{\text{exact}}(1) = 1 + e \approx 3.71828$

14. $\frac{dy}{dx} = y + e^x - 2$, $y(0) = 2 \Rightarrow y_{n+1} = y_n + (y_n + e^{x_n} - 2)dx = y_n + 0.5(y_n + e^{x_n} - 2)$

On a TI-92 Plus calculator home screen, type the following commands:

2 STO > y: 0 STO > x: y (enter)

$y + 0.5 * (y + e^x - 2)$ STO > y: x + 0.5 STO > x: y (enter, 4 times)

The last value displayed gives $y_{\text{Euler}}(2) \approx 9.82187$

The exact solution: $\frac{dy}{dx} - y = e^x - 2 \Rightarrow P(x) = 1$, $Q(x) = e^x - 2 \Rightarrow \int P(x) dx = -x \Rightarrow v(x) = e^{-x}$

$\Rightarrow y = \frac{1}{e^{-x}} \int e^{-x}(e^x - 2) dx = e^x(x + 2e^{-x} + C)$; $y(0) = 2 \Rightarrow 2 = 2 + C \Rightarrow C = 0$

$\Rightarrow y = xe^x + 2 \Rightarrow y_{\text{exact}}(2) = 2e^2 + 2 \approx 16.7781$

15. $\frac{dy}{dx} = \frac{\sqrt{x}}{y}$, $y > 0$, $y(0) = 1 \Rightarrow y_{n+1} = y_n + \frac{\sqrt{x_n}}{y_n} dx = y_n + \frac{\sqrt{x_n}}{y_n} (0.1) = y_n + 0.1 \frac{\sqrt{x_n}}{y_n}$

On a TI-92 Plus calculator home screen, type the following commands:

1 STO > y: 0 STO > x: y (enter)

$y + 0.1 * (\sqrt{x} / y)$ STO > y: x + 0.1 STO > x: y (enter, 10 times)

The last value displayed gives $y_{\text{Euler}}(1) \approx 1.5000$

The exact solution: $dy = \frac{\sqrt{x}}{y} dx \Rightarrow y dy = \sqrt{x} dx \Rightarrow \frac{y^2}{2} = \frac{2}{3}x^{3/2} + C$; $\frac{(y(0))^2}{2} = \frac{1^2}{2} = \frac{1}{2} = \frac{2}{3}(0)^{3/2} + C \Rightarrow C = \frac{1}{2}$

$\Rightarrow \frac{y^2}{2} = \frac{2}{3}x^{3/2} + \frac{1}{2} \Rightarrow y = \sqrt{\frac{4}{3}x^{3/2} + 1} \Rightarrow y_{\text{exact}}(1) = \sqrt{\frac{4}{3}(1)^{3/2} + 1} \approx 1.5275$

16. $\frac{dy}{dx} = 1 + y^2$, $y(0) = 0 \Rightarrow y_{n+1} = y_n + (1 + y_n^2)dx = y_n + (1 + y_n^2)(0.1) = y_n + 0.1(1 + y_n^2)$

On a TI-92 Plus calculator home screen, type the following commands:

0 STO > y: 0 STO > x: y (enter)

$y + 0.1 * (1 + y^2)$ STO > y: x + 0.1 STO > x: y (enter, 10 times)

The last value displayed gives $y_{\text{Euler}}(1) \approx 1.3964$

The exact solution: $dy = (1 + y^2)dx \Rightarrow \frac{dy}{1+y^2} = dx \Rightarrow \tan^{-1}y = x + C$; $\tan^{-1}y(0) = \tan^{-1}0 = 0 = 0 + C \Rightarrow C = 0$

$$\Rightarrow \tan^{-1}y = x \Rightarrow y = \tan x \Rightarrow y_{\text{exact}}(1) = \tan 1 \approx 1.5574$$

17. (a) $\frac{dy}{dx} = 2y^2(x-1) \Rightarrow \frac{dy}{y^2} = 2(x-1)dx \Rightarrow \int y^{-2}dy = \int (2x-2)dx \Rightarrow -y^{-1} = x^2 - 2x + C$

Initial value: $y(2) = -\frac{1}{2} \Rightarrow 2 = 2^2 - 2(2) + C \Rightarrow C = 2$

Solution: $-y^{-1} = x^2 - 2x + 2$ or $y = -\frac{1}{x^2 - 2x + 2}$

$y(3) = -\frac{1}{3^2 - 2(3) + 2} = -\frac{1}{5} = -0.2$

(b) To find the approximation, set $y_1 = 2y^2(x-1)$ and use EULERT with initial values $x = 2$ and $y = -\frac{1}{2}$ and step size 0.2 for 5 Points. This gives $y(3) \approx -0.1851$; error ≈ 0.0149 .

(c) Use step size 0.1 for 10 points. This gives $y(3) \approx -0.1929$; error ≈ 0.0071 .

(d) Use step size 0.05 for 20 points. This gives $y(3) \approx -0.1965$; error ≈ 0.0035 .

18. (a) $\frac{dy}{dx} = y - 1 \Rightarrow \int \frac{dy}{y-1} = \int dx \Rightarrow \ln |y-1| = x + C \Rightarrow |y-1| = e^{x+C} \Rightarrow y-1 = \pm e^C e^x \Rightarrow y = Ae^x + 1$

Initial value: $y(0) = 3 \Rightarrow 3 = Ae^0 + 1 \Rightarrow A = 2$

Solution: $y = 2e^x + 1$

$y(1) = 2e + 1 \approx 6.4366$

(b) To find the approximation, set $y_1 = y - 1$ and use a graphing calculator or CAS with initial values $x = 0$ and $y = 3$ and step size 0.2 for 5 Points. This gives $y(1) \approx 5.9766$; error ≈ 0.4599

(c) Use step size 0.1 for 10 points. This gives $y(1) \approx 6.1875$; error ≈ 0.2491 .

(d) Use step size 0.05 for 20 points. This gives $y(1) \approx 6.3066$; error ≈ 0.1300 .

19. The exact solution is $y = \frac{-1}{x^2 - 2x + 2}$, so $y(3) = -0.2$. To find the approximation, let $z_n = y_{n-1} + 2y_{n-1}^2(x_{n-1} - 1)dx$ and $y_n = y_{n-1} + (y_{n-1}^2(x_{n-1} - 1) + z_n^2(x_n^2 - 1))dx$ with initial values $x_0 = 2$ and $y_0 = -\frac{1}{2}$. Use a spreadsheet, graphing calculator, or CAS as indicated in parts (a) through (d).

(a) Use $dx = 0.2$ with 5 steps to obtain $y(3) \approx -0.2024 \Rightarrow$ error ≈ 0.0024 .

(b) Use $dx = 0.1$ with 10 steps to obtain $y(3) \approx -0.2005 \Rightarrow$ error ≈ 0.0005 .

(c) Use $dx = 0.05$ with 20 steps to obtain $y(3) \approx -0.2001 \Rightarrow$ error ≈ 0.0001 .

(d) Each time the step size is cut in half, the error is reduced to approximately one-fourth of what it was for the larger step size.

20. The exact solution is $y = 2e^x + 1$, so $y(1) = 2e + 1 \approx 6.4366$. To find the approximation, let $z_n = y_{n-1} + (y_{n-1} - 1)dx$ and $y_n = y_{n-1} + \left(\frac{y_{n-1} + z_n - 2}{2}\right)dx$ with initial value $y_n = 3$. Use a spreadsheet, graphing calculator, or CAS as indicated in parts (a) through (d).

(a) Use $dx = 0.2$ with 5 steps to obtain $y(1) \approx 6.4054 \Rightarrow$ error ≈ 0.0311 .

(b) Use $dx = 0.1$ with 10 steps to obtain $y(1) \approx 6.4282 \Rightarrow$ error ≈ 0.0084

(c) Use $dx = 0.05$ with 20 steps to obtain $y(1) \approx 6.4344 \Rightarrow$ error ≈ 0.0022

(d) Each time the step size is cut in half, the error is reduced to approximately one-fourth of what it was for the larger step size.

13-16. Example CAS commands:

Maple:

```
ode := diff( y(x), x ) = 2*x*exp(x^2); ic := y(0)=2;
```

```
xstar := 1;
```

```
dx := 0.1;
```

```
approx := dsolve( {ode,ic}, y(x), numeric, method=classical[foreuler], stepsize=dx );
```

```
approx(xstar);
```

```
exact := dsolve( {ode,ic}, y(x) );
```

```
eval( exact, x=xstar );
```

```
evalf( % );
```

17. Example CAS commands:

Maple:

```
ode := diff( y(x), x ) = 2*y(x)*(x-1); ic := y(2)=-1/2;
xstar := 3;
exact := dsolve( {ode,ic}, y(x) ); # (a)
eval( exact, x=xstar );
evalf( % );
approx1 := dsolve( {ode,ic}, y(x), # (b)
    numeric, method=classical[foreuler], stepsize=0.2 ):
approx1(xstar);
approx2 := dsolve( {ode,ic}, y(x), # (c)
    numeric, method=classical[foreuler], stepsize=0.1 ):
approx2(xstar);
approx3 := dsolve( {ode,ic}, y(x), # (d)
    numeric, method=classical[foreuler], stepsize=0.05 ):
approx3(xstar);
```

19. Example CAS commands:

Maple:

```
ode := diff( y(x), x ) = 2*y(x)*(x-1); ic := y(2)=-1/2;
xstar := 3;
approx1 := dsolve( {ode,ic}, y(x), # (a)
    numeric, method=classical[heunform], stepsize=0.2 ):
approx1(xstar);
approx2 := dsolve( {ode,ic}, y(x), # (b)
    numeric, method=classical[heunform], stepsize=0.1 ):
approx2(xstar);
approx3 := dsolve( {ode,ic}, y(x), # (c)
    numeric, method=classical[heunform], stepsize=0.05 ):
approx3(xstar);
```

21. Example CAS commands:

Maple:

```
ode := diff( y(x), x ) = x + y(x); ic := y(0)=-7/10;
x0 := -4; x1 := 4; y0 := -4; y1 := 4;
b := 1;
P1 := DEplot( ode, y(x), x=x0..x1, y=y0..y1, arrows=thin, title="#21(a) (Section 9.3)" ):
P1;
Ygen := unapply( rhs(dsolve( ode, y(x) )), x, _C1 ); # (b)
P2 := seq( plot( Ygen(x,c), x=x0..x1, y=y0..y1, color=blue ), c=-2..2 ); # (c)
display( [P1,P2], title="#21(c) (Section 9.3)" );
CC := solve( Ygen(0,C)=rhs(ic), C ); # (d)
Ypart := Ygen(x,CC);
P3 := plot( Ypart, x=0..b, title="#21(d) (Section 9.3)" ):
P3;
euler4 := dsolve( {ode,ic}, numeric, method=classical[foreuler], stepsize=(x1-x0)/4 ); # (e)
P4 := odeplot( euler4, [x,y(x)], x=0..b, numpoints=4, color=blue );
```

```

display( [P3,P4], title="#21(e) (Section 9.3)" );
euler8 := dsolve( {ode,ic}, numeric, method=classical[foreuler], stepsize=(x1-x0)/8 ): # (f)
P5 := odeplot( euler8, [x,y(x)], x=0..b, numpoints=8, color=green ):
euler16 := dsolve( {ode,ic}, numeric, method=classical[foreuler], stepsize=(x1-x0)/16 ):
P6 := odeplot( euler16, [x,y(x)], x=0..b, numpoints=16, color=pink ):
euler32 := dsolve( {ode,ic}, numeric, method=classical[foreuler], stepsize=(x1-x0)/32 ):
P7 := odeplot( euler32, [x,y(x)], x=0..b, numpoints=32, color=cyan ):
display( [P3,P4,P5,P6,P7], title="#21(f) (Section 9.3)" );
<< N | h      | `percent error` >, # (g)
< 4 | (x1-x0)/4 | evalf[5]( abs(1-eval(y(x),euler4(b))/eval(Ypart,x=b))*100 ) >,
< 8 | (x1-x0)/8 | evalf[5]( abs(1-eval(y(x),euler8(b))/eval(Ypart,x=b))*100 ) >,
< 16 | (x1-x0)/16 | evalf[5]( abs(1-eval(y(x),euler16(b))/eval(Ypart,x=b))*100 ) >,
< 32 | (x1-x0)/32 | evalf[5]( abs(1-eval(y(x),euler32(b))/eval(Ypart,x=b))*100 ) >;

```

13-24. Example CAS commands:

Mathematica: (assigned functions, step sizes, and values for initial conditions may vary)

For exercises 13 - 20, find the exact solution as follows. Set up two error lists.

```

Clear[x, y, f]
f[x_,y_]:= 2 y^2 (x - 1)
a = 2; b = -1/2;
xstar = 3;
desol=DSolve[{y'[x] == f[x, y[x]], y[a] == b}, y[x], x] //Simplify
actual[x_] = desol[[1, 1, 2]];
{xstar, actual[xstar]}
errorlisteuler = { };
errorlisteulerimp = { };
pa = Plot[actual[x], {x, a, xstar}]

```

Euler's method with error at x^* . The **Do** command is used with a sequence of commands that are repeated n times.

```

a = 2; b = -1/2;
dx = 0.2;
xstar = 3; n = (xstar - a) / dx;
solnslist = {{a,b}};
Do[ {new = b + f[a,b] dx, a = a + dx, b = new, AppendTo[solnslist, {a,b}]} , {n}
solnslist
error= actual[xstar] - solnslist[[n, 2]]
relativeerror= error / actual[xstar]
AppendTo[errorlisteuler, error]
pe = ListPlot[solnslist, PlotStyle -> {Hue[.4], PointSize[0.02]}]
Show[pa, pe]

```

Rerun with different values for dx , starting from largest to smallest. After doing this, observe what happens to the error as the step size decreases by entering the input command: `errorlisteuler`

Improved Euler's method. with error at x^*

```

a = 2; b = -1/2;
dx = 0.2;
xstar = 3; n = (xstar - a) / dx;
solnslist = {{a,b}};
Do[{new1 = b + f[a,b] dx, new2 = b + (f[a, b] + f[a+dx, new1])/2 dx, a = a + dx, b = new2,
AppendTo[solnslist, {a,b}]} , {n}
solnslist
error= actual[xstar] - solnslist[[n, 2]]

```

```
relativeerror= error / actual[xstar]
AppendTo[errorlisteulerimp, error]
peimp = ListPlot[solnslist, PlotStyle -> {Hue[.8], PointSize[0.02]}]
Show[pa, peimp]
```

Rerun with different values for dx, starting from largest to smallest. After doing this, observe what happens to the error as the step size decreases by entering the input command: errorlisteulerimp

You can also type Show[pa, pe, peimp]. This would be appropriate for a fixed value of dx with each method.

You can also make a list of relative errors.

Problems 21 - 24 involve use of code from section 9.1 together with the above code for Euler's method.

9.4 GRAPHICAL SOLUTIONS OF AUTONOMOUS DIFFERENTIAL EQUATIONS

1. $y' = (y + 2)(y - 3)$

(a) $y = -2$ is a stable equilibrium value and $y = 3$ is an unstable equilibrium.

(b) $y'' = (2y - 1)y' = 2(y + 2)(y - \frac{1}{2})(y - 3)$

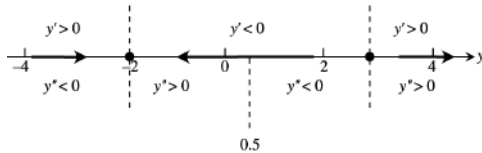

(c)

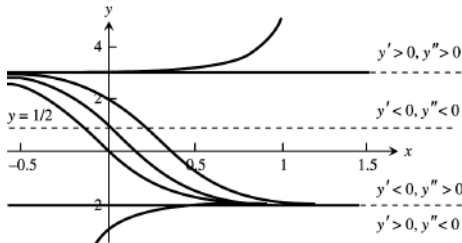

2. $y' = (y + 2)(y - 2)$

(a) $y = -2$ is a stable equilibrium value and $y = 2$ is an unstable equilibrium.

(b) $y'' = 2yy' = 2(y + 2)y(y - 2)$

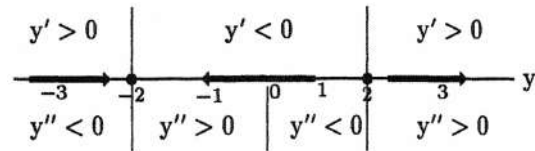

(c)

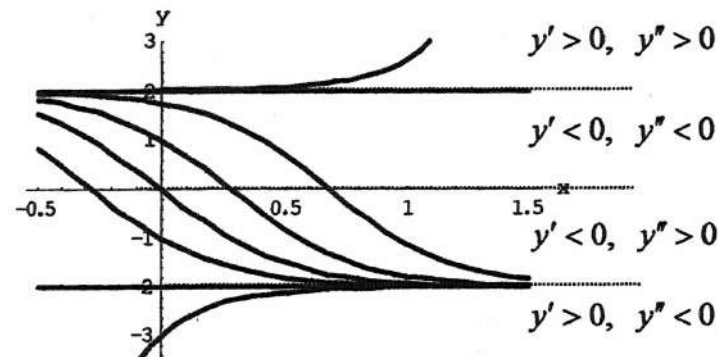

3. $y' = y^3 - y = (y + 1)y(y - 1)$

(a) $y = -1$ and $y = 1$ is an unstable equilibrium and $y = 0$ is a stable equilibrium value.

(b) $y'' = (3y^2 - 1)y' = 3(y + 1)\left(y + \frac{1}{\sqrt{3}}\right)y\left(y - \frac{1}{\sqrt{3}}\right)(y - 1)$

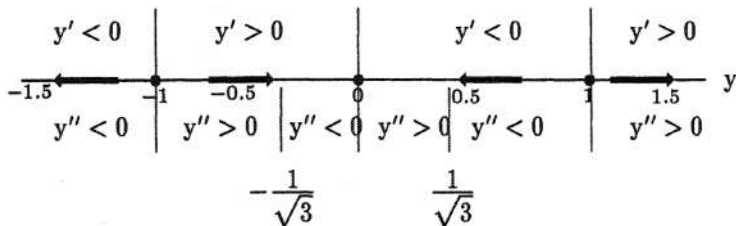

(c)

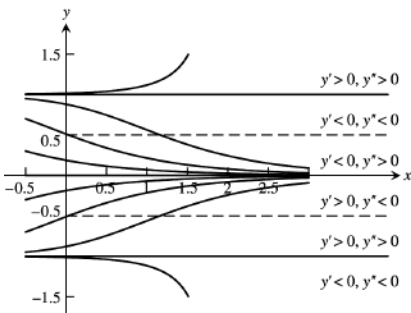

4. $y' = y(y - 2)$

(a) $y = 0$ is a stable equilibrium value and $y = 2$ is an unstable equilibrium.

(b) $y'' = (2y - 2)y' = 2y(y - 1)(y - 2)$

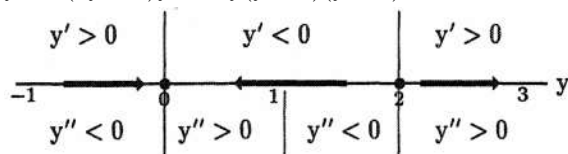

(c)

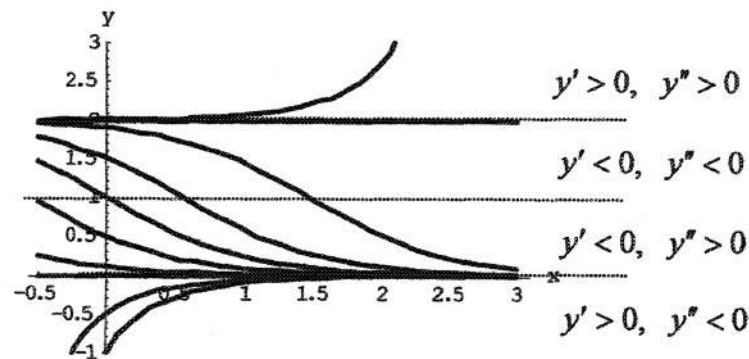

5. $y' = \sqrt{y}, y > 0$

(a) There are no equilibrium values.

(b) $y'' = \frac{1}{2\sqrt{y}} y' = \frac{1}{2\sqrt{y}} \sqrt{y} = \frac{1}{2}$

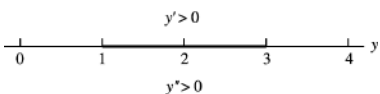

(c)

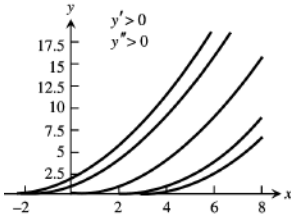

6. $y' = y - \sqrt{y}, y > 0$

(a) $y = 1$ is an unstable equilibrium.

(b) $y'' = \left(1 - \frac{1}{2\sqrt{y}}\right) y' = \left(1 - \frac{1}{2\sqrt{y}}\right)(y - \sqrt{y}) = \left(\sqrt{y} - \frac{1}{2}\right)(\sqrt{y} - 1)$

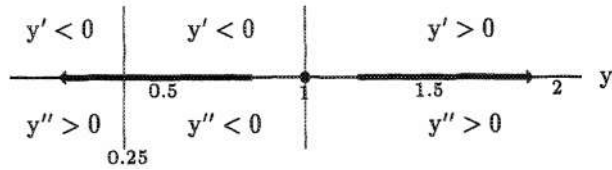

(c)

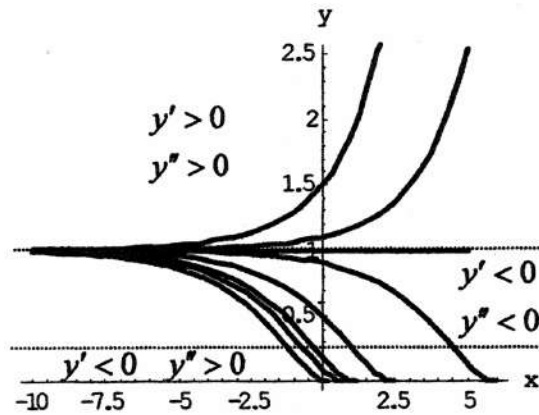

7. $y' = (y - 1)(y - 2)(y - 3)$

(a) $y = 1$ and $y = 3$ is an unstable equilibrium and $y = 2$ is a stable equilibrium value.

(b) $y'' = (3y^2 - 12y + 11)(y - 1)(y - 2)(y - 3) = 3(y - 1)\left(y - \frac{6 - \sqrt{3}}{3}\right)(y - 2)\left(y - \frac{6 + \sqrt{3}}{3}\right)(y - 3)$

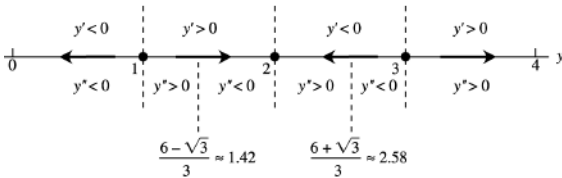

(c)

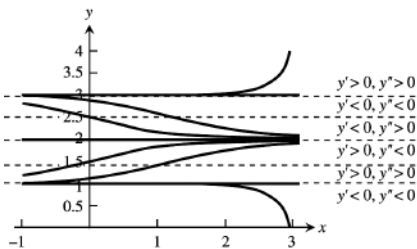

8. $y' = y^3 - y^2 = y^2(y - 1)$

(a) $y = 0$ and $y = 1$ is an unstable equilibrium.

(b) $y'' = (3y^2 - 2y)(y^3 - y^2) = y^3(3y - 2)(y - 1)$

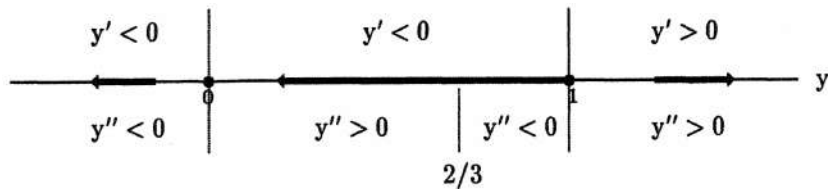

(c)

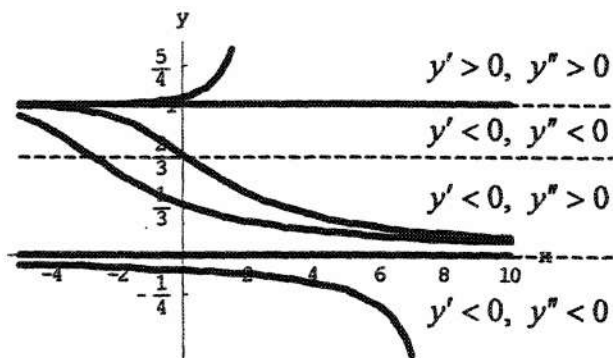

9. $\frac{dP}{dt} = 1 - 2P$ has a stable equilibrium at $P = \frac{1}{2}$. $\frac{d^2P}{dt^2} = -2\frac{dP}{dt} = -2(1 - 2P)$

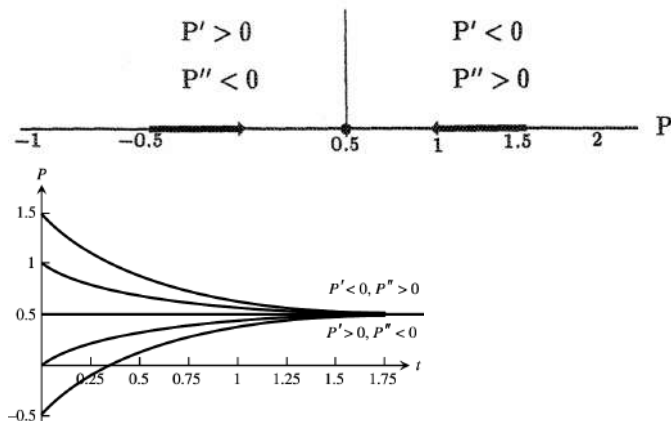

10. $\frac{dP}{dt} = P(1 - 2P)$ has an unstable equilibrium at $P = 0$ and a stable equilibrium at $P = \frac{1}{2}$.

$\frac{d^2P}{dt^2} = (1 - 4P)\frac{dP}{dt} = P(1 - 4P)(1 - 2P)$

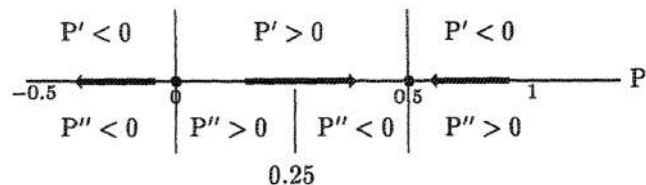

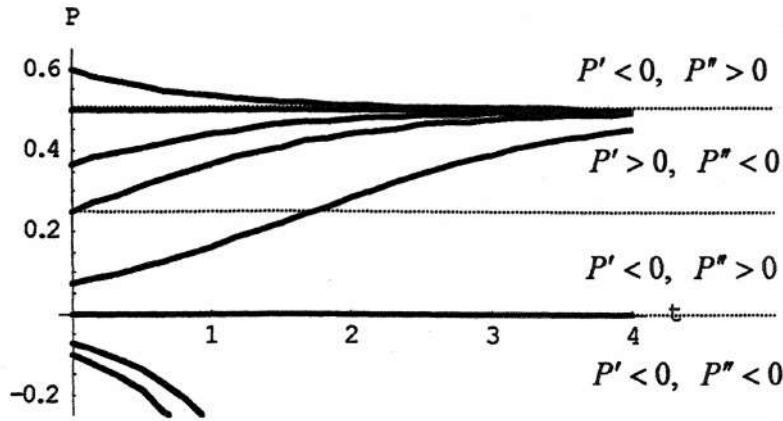

11. $\frac{dP}{dt} = 2P(P - 3)$ has a stable equilibrium at $P = 0$ and an unstable equilibrium at $P = 3$.
 $\frac{d^2P}{dt^2} = 2(2P - 3)\frac{dP}{dt} = 4P(2P - 3)(P - 3)$

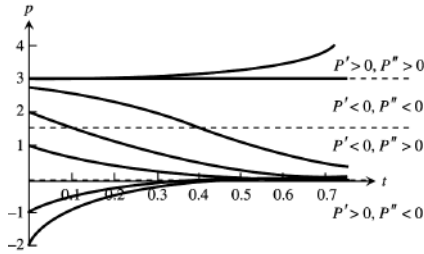
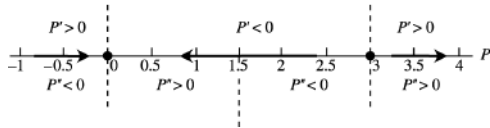

12. $\frac{dP}{dt} = 3P(1 - P)(P - \frac{1}{2})$ has a stable equilibria at $P = 0$ and $P = 1$ an unstable equilibrium at $P = \frac{1}{2}$.
 $\frac{d^2P}{dt^2} = -\frac{3}{2}(6P^2 - 6P + 1)\frac{dP}{dt} = \frac{3}{2}P(P - \frac{3 - \sqrt{3}}{6})(P - \frac{1}{2})(P - \frac{3 + \sqrt{3}}{6})(P - 1)$

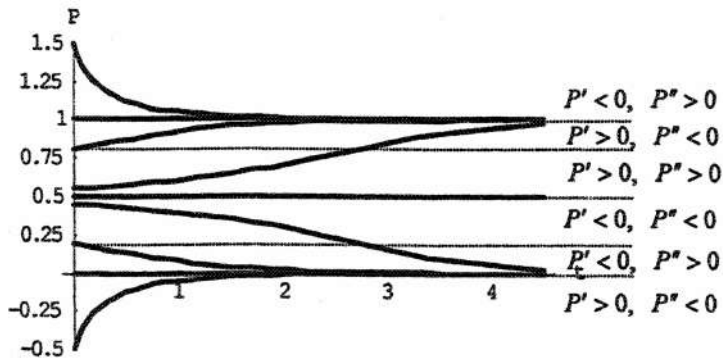
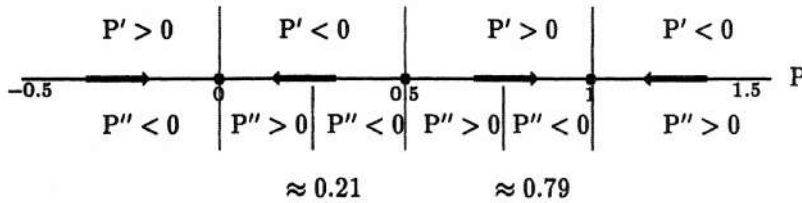

13.

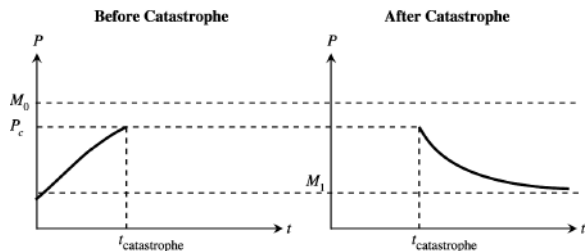

Before the catastrophe, the population exhibits logistic growth and $P(t) \rightarrow M_0$, the stable equilibrium. After the catastrophe, the population declines logistically and $P(t) \rightarrow M_1$, the new stable equilibrium.

14. $\frac{dP}{dt} = rP(M - P)(P - m)$, $r, M, m > 0$

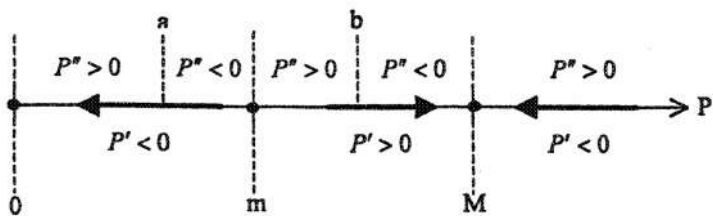

The model has 3 equilibrium points. The rest point $P = 0$, $P = M$ are asymptotically stable while $P = m$ is unstable. For initial populations greater than m , the model predicts P approaches M for large t . For initial populations less than m , the model predicts extinction. Points of inflection occur at $P = a$ and $P = b$ where $a = \frac{1}{3}[M + m - \sqrt{M^2 - mM + m^2}]$ and $b = \frac{1}{3}[M + m + \sqrt{M^2 - mM + m^2}]$.

- (a) The model is reasonable in the sense that if $P < m$, then $P \rightarrow 0$ as $t \rightarrow \infty$; if $m < P < M$, then $P \rightarrow M$ as $t \rightarrow \infty$; if $P > M$, then $P \rightarrow M$ as $t \rightarrow \infty$.
- (b) It is different if the population falls below m , for then $P \rightarrow 0$ as $t \rightarrow \infty$ (extinction). It is probably a more realistic model for that reason because we know some populations have become extinct after the population level became too low.
- (c) For $P > M$ we see that $\frac{dP}{dt} = rP(M - P)(P - m)$ is negative. Thus the curve is everywhere decreasing. Moreover, $P \equiv M$ is a solution to the differential equation. Since the equation satisfies the existence and uniqueness conditions, solution trajectories cannot cross. Thus, $P \rightarrow M$ as $t \rightarrow \infty$.
- (d) See the initial discussion above.
- (e) See the initial discussion above.

15. $\frac{dv}{dt} = g - \frac{k}{m}v^2$, $g, k, m > 0$ and $v(t) \geq 0$

Equilibrium: $\frac{dv}{dt} = g - \frac{k}{m}v^2 = 0 \Rightarrow v = \sqrt{\frac{mg}{k}}$

Concavity: $\frac{d^2v}{dt^2} = -2\left(\frac{k}{m}v\right)\frac{dv}{dt} = -2\left(\frac{k}{m}v\right)\left(g - \frac{k}{m}v^2\right)$

(a)

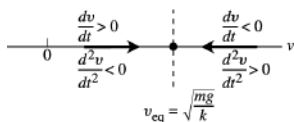

(b)

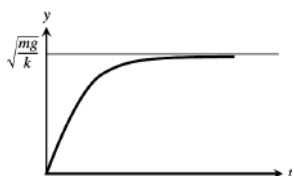

(c) $v_{\text{terminal}} = \sqrt{\frac{160}{0.005}} = 178.9 \frac{\text{ft}}{\text{s}} = 122 \text{ mph}$

16. $F = F_p - F_r$

$$ma = mg - k\sqrt{v}$$

$$\frac{dv}{dt} = g - \frac{k}{m}\sqrt{v}, v(0) = v_0$$

Thus, $\frac{dv}{dt} = 0$ implies $v = \left(\frac{mg}{k}\right)^2$, the terminal velocity. If $v_0 < \left(\frac{mg}{k}\right)^2$, the object will fall faster and faster, approaching the terminal velocity; if $v_0 > \left(\frac{mg}{k}\right)^2$, the object will slow down to the terminal velocity.

17. $F = F_p - F_r$

$$ma = 50 - 5|v|$$

$$\frac{dv}{dt} = \frac{1}{m}(50 - 5|v|)$$

The maximum velocity occurs when $\frac{dv}{dt} = 0$ or $v = 10 \frac{ft}{sec}$.

18. (a) The model seems reasonable because the rate of spread of a piece of information, an innovation, or a cultural fad is proportional to the product of the number of individuals who have it (X) and those who do not ($N - X$). When X is small, there are only a few individuals to spread the item so the rate of spread is slow. On the other hand, when $(N - X)$ is small the rate of spread will be slow because there are only a few individuals who can receive it during the interval of time. The rate of spread will be fastest when both X and $(N - X)$ are large because then there are a lot of individuals to spread the item and a lot of individuals to receive it.

(b) There is a stable equilibrium at $X = N$ and an unstable equilibrium at $X = 0$.

$$\frac{d^2X}{dt^2} = k \frac{dX}{dt} (N - X) - kX \frac{dX}{dt} = k^2 X(N - X)(N - 2X) \Rightarrow \text{inflection points at } X = 0, X = \frac{N}{2}, \text{ and } X = N.$$

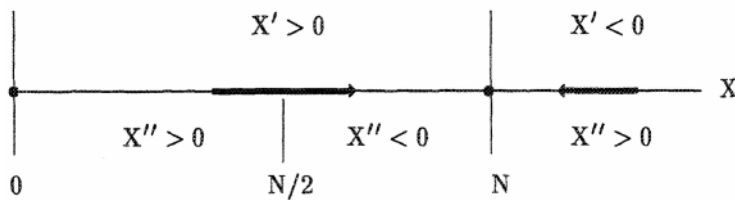

(c)

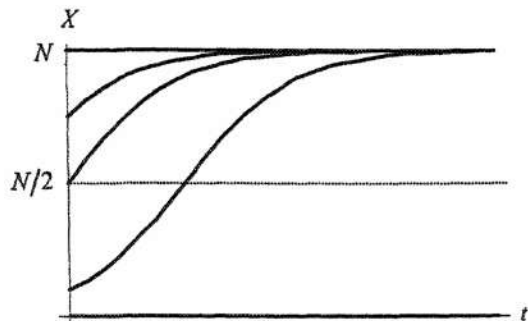

(d) The spread rate is most rapid when $x = \frac{N}{2}$. Eventually all of the people will receive the item.

19. $L \frac{di}{dt} + Ri = V \Rightarrow \frac{di}{dt} = \frac{V}{L} - \frac{R}{L}i = \frac{R}{L} \left(\frac{V}{R} - i \right), V, L, R > 0$

Equilibrium: $\frac{di}{dt} = \frac{R}{L} \left(\frac{V}{R} - i \right) = 0 \Rightarrow i = \frac{V}{R}$

Concavity: $\frac{d^2i}{dt^2} = -\left(\frac{R}{L}\right) \frac{di}{dt} = -\left(\frac{R}{L}\right)^2 \left(\frac{V}{R} - i\right)$

Phase Line:

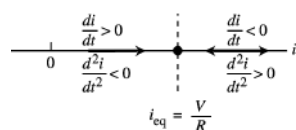

If the switch is closed at $t = 0$, then $i(0) = 0$, and the graph of the solution looks like this:

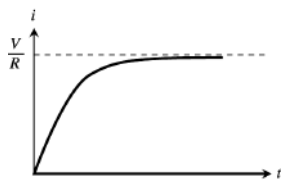

As $t \rightarrow \infty$, it $\rightarrow i_{\text{steady state}} = \frac{V}{R}$. (In the steady state condition, the self-inductance acts like a simple wire connector and, as a result, the current through the resistor can be calculated using the familiar version of Ohm's Law.)

20. (a) Free body diagram of the pearl:

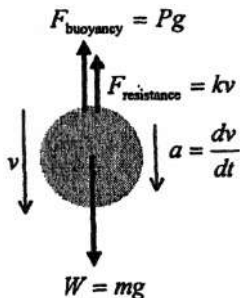

(b) Use Newton's Second Law, summing forces in the direction of the acceleration:

$$mg - Pg - kv = ma \Rightarrow \frac{dv}{dt} = \left(\frac{m-P}{m}\right)g - \frac{k}{m}v.$$

(c) Equilibrium: $\frac{dv}{dt} = \frac{k}{m} \left(\frac{(m-P)g}{k} - v\right) = 0$

$$\Rightarrow v_{\text{terminal}} = \frac{(m-P)g}{k}$$

$$\text{Concavity: } \frac{d^2v}{dt^2} = -\frac{k}{m} \frac{dv}{dt} = -\left(\frac{k}{m}\right)^2 \left(\frac{(m-P)g}{k} - v\right)$$

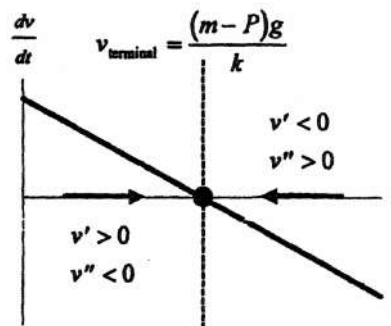

(d)

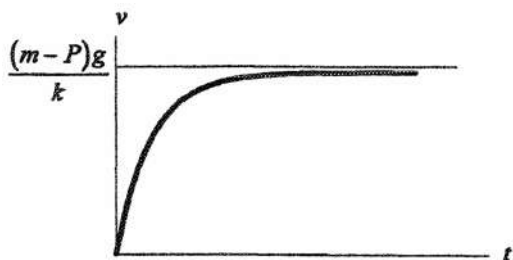

(e) The terminal velocity of the pearl is $\frac{(m-P)g}{k}$.

9.5 APPLICATIONS OF FIRST ORDER DIFFERENTIAL EQUATIONS

1. Note that the total mass is $66 + 7 = 73$ kg, therefore, $v = v_0 e^{-(k/m)t} \Rightarrow v = 9e^{-3.9t/73}$

(a) $s(t) = \int 9e^{-3.9t/73} dt = -\frac{2190}{13}e^{-3.9t/73} + C$

Since $s(0) = 0$ we have $C = \frac{2190}{13}$ and $\lim_{t \rightarrow \infty} s(t) = \lim_{t \rightarrow \infty} \frac{2190}{13}(1 - e^{-3.9t/73}) = \frac{2190}{13} \approx 168.5$

The cyclist will coast about 168.5 meters.

(b) $1 = 9e^{-3.9t/73} \Rightarrow \frac{3.9t}{73} = \ln 9 \Rightarrow t = \frac{73 \ln 9}{3.9} \approx 41.13$ sec

It will take about 41.13 seconds.

2. $v = v_0 e^{-(k/m)t} \Rightarrow v = 9e^{-(59,000/51,000,000)t} \Rightarrow v = 9e^{-59t/51,000}$

(a) $s(t) = \int 9e^{-59t/51,000} dt = -\frac{459,000}{59} e^{-59t/51,000} + C$

Since $s(0) = 0$ we have $C = \frac{459,000}{59}$ and $\lim_{t \rightarrow \infty} s(t) = \lim_{t \rightarrow \infty} \frac{459,000}{59} (1 - e^{-59t/51,000}) = \frac{459,000}{59} \approx 7780$ m

The ship will coast about 7780 m, or 7.78 km.

(b) $1 = 9e^{-59t/51,000} \Rightarrow \frac{59t}{51,000} = \ln 9 \Rightarrow t = \frac{51,000 \ln 9}{59} \approx 1899.3$ sec

It will take about 31.65 minutes.

3. The total distance traveled $= \frac{v_0 m}{k} \Rightarrow \frac{(2.75)(39.92)}{k} = 4.91 \Rightarrow k = 22.36$. Therefore, the distance traveled is given by the function $s(t) = 4.91(1 - e^{-(22.36/39.92)t})$. The graph shows $s(t)$ and the data points.

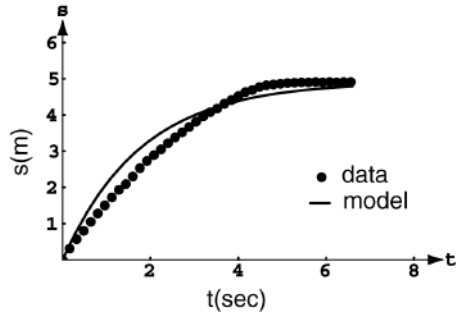

4. $\frac{v_0 m}{k} = \text{coasting distance} \Rightarrow \frac{(0.80)(49.90)}{k} = 1.32 \Rightarrow k = \frac{998}{33}$

We know that $\frac{v_0 m}{k} = 1.32$ and $\frac{k}{m} = \frac{998}{33(49.9)} = \frac{20}{33}$.

Using Equation 3, we have: $s(t) = \frac{v_0 m}{k} (1 - e^{-(k/m)t}) = 1.32(1 - e^{-20t/33}) \approx 1.32(1 - e^{-0.606t})$

5. (a) $\frac{dP}{dt} = 0.0015P(150 - P) = \frac{0.255}{150}P(150 - P) = \frac{k}{M}P(M - P)$

Thus, $k = 0.255$ and $M = 150$, and $P = \frac{M}{1 + Ae^{-kt}} = \frac{150}{1 + Ae^{-0.255t}}$

Initial condition: $P(0) = 6 \Rightarrow 6 = \frac{150}{1 + Ae^0} \Rightarrow 1 + A = 25 \Rightarrow A = 24$

Formula: $P = \frac{150}{1 + 24e^{-0.255t}}$

(b) $100 = \frac{150}{1 + 24e^{-0.255t}} \Rightarrow 1 + 24e^{-0.255t} = \frac{3}{2} \Rightarrow 24e^{-0.255t} = \frac{1}{2} \Rightarrow e^{-0.255t} = \frac{1}{48} \Rightarrow -0.255t = -\ln 48$
 $\Rightarrow t = \frac{\ln 48}{0.255} \approx 17.21$ weeks

$125 = \frac{150}{1 + 24e^{-0.255t}} \Rightarrow 1 + 24e^{-0.255t} = \frac{6}{5} \Rightarrow 24e^{-0.255t} = \frac{1}{5} \Rightarrow e^{-0.255t} = \frac{1}{120} \Rightarrow -0.255t = -\ln 120$
 $\Rightarrow t = \frac{\ln 120}{0.255} \approx 21.28$

It will take about 17.21 weeks to reach 100 guppies, and about 21.28 weeks to reach 125 guppies.

6. (a) $\frac{dP}{dt} = 0.0004P(250 - P) = \frac{0.1}{250}P(250 - P) = \frac{k}{M}P(M - P)$

Thus, $k = 0.1$ and $M = 250$, and $P = \frac{M}{1 + Ae^{-kt}} = \frac{250}{1 + Ae^{-0.1t}}$

Initial condition: $P(0) = 28$, where $t = 0$ represents the year 1970

$28 = \frac{250}{1 + Ae^0} \Rightarrow 28(1 + A) = 250 \Rightarrow A = \frac{250}{28} - 1 = \frac{111}{14} \approx 7.9286$

Formula: $P = \frac{250}{1 + \frac{111}{14}e^{-0.1t}}$ or approximately $P = \frac{250}{1 + 7.9286e^{-0.1t}}$

(b) The population $P(t)$ will round to 250 when $P(t) \geq 249.5 \Rightarrow 249.5 = \frac{250}{1 + \frac{111}{14}e^{-0.1t}} \Rightarrow 249.5(1 + \frac{111}{14}e^{-0.1t}) = 250$

$\Rightarrow \frac{(249.5)(111e^{-0.1t})}{14} = 0.5 \Rightarrow e^{-0.1t} = \frac{14}{55,389} \Rightarrow -0.1t = \ln \frac{14}{55,389} \Rightarrow t = 10(\ln 55,389 - \ln 14) \approx 82.8$.

It will take about 83 years.

7. (a) Using the general solution form Example 2, part (c),

$\frac{dy}{dt} = (0.08875 \times 10^{-7})(8 \times 10^7 - y)y \Rightarrow y(t) = \frac{M}{1 + Ae^{-Mt}} = \frac{8 \times 10^7}{1 + Ae^{-(0.08875)(8)t}} = \frac{8 \times 10^7}{1 + Ae^{-0.71t}}$

Apply the initial condition:

$$y(0) = 1.6 \times 10^7 = \frac{8 \times 10^7}{1+A} \Rightarrow \frac{8}{1.6} - 1 = 4 \Rightarrow y(1) = \frac{8 \times 10^7}{1+4e^{-0.7\pi}} \approx 2.69671 \times 10^7 \text{ kg.}$$

(b) $y(t) = 4 \times 10^7 = \frac{8 \times 10^7}{1+4e^{-0.7\pi t}} \Rightarrow 4e^{-0.7\pi t} = 1 \Rightarrow t = -\frac{\ln(\frac{1}{4})}{0.7\pi} \approx 1.95253 \text{ years.}$

8. (a) If a part of the population leaves or is removed from the environment (e.g., a preserve or a region) each year, then c would represent the rate of reduction of the population due to this removal and/or migration. When grizzly bears become a nuisance (e.g., feeding on livestock) or threaten human safety, they are often relocated to other areas or even eliminated, but only after relocation efforts fail. In addition, bears are killed, sometimes accidentally and sometimes maliciously. For an environment that has a capacity of about 100 bears, a realistic value for c would probably be between 0 and 4.

(b)

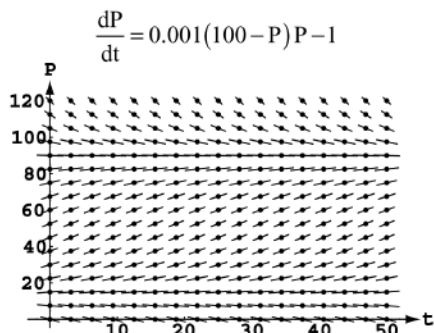

Equilibrium solutions: $\frac{dP}{dt} = 0 = 0.001(100 - P)P - 1 \Rightarrow P^2 - 100P + 1000 = 0 \Rightarrow P_{eq} \approx 11.27$ (unstable) and $P_{eq} \approx 88.73$ (stable)

(c)

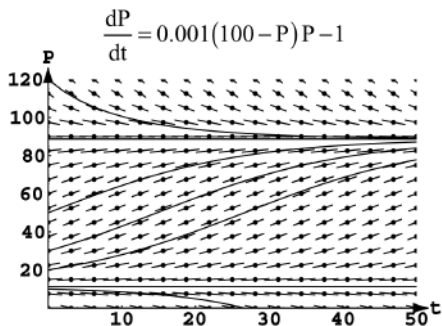

For $0 < P(0) \leq 11$, the bear population will eventually disappear, for $12 \leq P(0) \leq 88$, the population will grow to about 89, the population will remain at about 89, and for $P(0) > 89$, the population will decrease to about 89 bears.

9. (a) $\frac{dy}{dt} = 1 + y \Rightarrow dy = (1 + y)dt \Rightarrow \frac{dy}{1+y} = dt \Rightarrow \ln |1 + y| = t + C_1 \Rightarrow e^{\ln |1+y|} = e^{t+C_1} \Rightarrow |1 + y| = e^t e^{C_1}$
 $1 + y = \pm C_2 e^t \Rightarrow y = C e^t - 1$, where $C_2 = e^{C_1}$ and $C = \pm C_2$. Apply the initial condition: $y(0) = 1 = C e^0 - 1$
 $\Rightarrow C = 2 \Rightarrow y = 2e^t - 1$.

- (b) $\frac{dy}{dt} = 0.5(400 - y)y \Rightarrow dy = 0.5(400 - y)y dt \Rightarrow \frac{dy}{(400 - y)y} = 0.5 dt$. Using the partial fraction decomposition in

Example 2, part (c), we obtain $\frac{1}{400} \left(\frac{1}{y} + \frac{1}{400 - y} \right) dy = 0.5 dt \Rightarrow \left(\frac{1}{y} + \frac{1}{400 - y} \right) dy = 200 dt$

$$\Rightarrow \int \left(\frac{1}{y} + \frac{1}{400 - y} \right) dy = \int 200 dt \Rightarrow \ln |y| - \ln |y - 400| = 200t + C_1 \Rightarrow \ln \left| \frac{y}{y - 400} \right| = 200t + C_1$$

$$\Rightarrow e^{\ln \left| \frac{y}{y - 400} \right|} = e^{200t + C_1} = e^{200t} e^{C_1} \Rightarrow \left| \frac{y}{y - 400} \right| = C_2 e^{200t} \text{ (where } C_2 = e^{C_1}) \Rightarrow \frac{y}{y - 400} = \pm C_2 e^{200t}$$

$$\Rightarrow \frac{y}{y - 400} = C e^{200t} \text{ (where } C = \pm C_2) \Rightarrow y = C e^{200t} y - 400 C e^{200t} \Rightarrow (1 - C e^{200t})y = -400 C e^{200t}$$

$$\Rightarrow y = \frac{400 C e^{200t}}{C e^{200t} - 1} \Rightarrow y = \frac{400}{1 - \frac{1}{C} e^{-200t}} = \frac{400}{1 + A e^{-200t}}, \text{ where } A = -\frac{1}{C}. \text{ Apply the initial condition:}$$

$$y(0) = 2 = \frac{400}{1 + A e^0} \Rightarrow A = 199 \Rightarrow y(t) = \frac{400}{1 + 199 e^{-200t}}$$

10. $\frac{dP}{dt} = r(M - P)P \Rightarrow dP = r(M - P)P dt \Rightarrow \frac{dP}{(M-P)P} = r dt$. Using the partial fraction decomposition in Example 6, part (c),

we obtain $\frac{1}{M}(\frac{1}{P} + \frac{1}{M-P})dP = r dt \Rightarrow (\frac{1}{P} + \frac{1}{M-P})dP = rM dt \Rightarrow \int (\frac{1}{P} - \frac{1}{P-M})dP = \int rM dt$
 $\Rightarrow \ln|P| - \ln|P - M| = (rM)t + C_1 \Rightarrow \ln|\frac{P}{P-M}| = (rM)t + C_1 \Rightarrow e^{\ln|\frac{P}{P-M}|} = e^{(rM)t+C_1} = e^{(rM)t}e^{C_1}$
 $\Rightarrow |\frac{P}{P-M}| = C_2e^{(rM)t}$ (where $C_2 = e^{C_1}$) $\Rightarrow \frac{P}{P-M} = \pm C_2e^{(rM)t} \Rightarrow \frac{P}{P-M} = Ce^{(rM)t}$ (where $C = \pm C_2$)
 $\Rightarrow P = Ce^{(rM)t}P - MCe^{(rM)t} \Rightarrow (1 - Ce^{(rM)t})P = -MCe^{(rM)t} \Rightarrow P = \frac{MCe^{(rM)t}}{Ce^{(rM)t} - 1} \Rightarrow P = \frac{M}{1 - \frac{1}{C}e^{-(rM)t}}$
 $\Rightarrow P = \frac{M}{1 - Ae^{-(rM)t}}$, where $A = -\frac{1}{C}$.

11. (a) $\frac{dP}{dt} = kP^2 \Rightarrow \int P^{-2}dP = \int k dt \Rightarrow -P^{-1} = kt + C \Rightarrow P = \frac{-1}{kt+C}$

Initial condition: $P(0) = P_0 \Rightarrow P_0 = -\frac{1}{C} \Rightarrow C = -\frac{1}{P_0}$

Solution: $P = -\frac{1}{kt - (1/P_0)} = \frac{P_0}{1 - kP_0t}$

(b) There is a vertical asymptote at $t = \frac{1}{kP_0}$

12. (a) $\frac{dP}{dt} = r(M - P)(P - m) \Rightarrow \frac{dP}{dt} = r(1200 - P)(P - 100) \Rightarrow \frac{1}{(1200-P)(P-100)} \frac{dP}{dt} = r \Rightarrow \frac{1100}{(1200-P)(P-100)} \frac{dP}{dt} = 1100 r$

$\Rightarrow \frac{(P-100)+(1200-P)}{(1200-P)(P-100)} \frac{dP}{dt} = 1100 r \Rightarrow (\frac{1}{1200-P} + \frac{1}{P-100}) \frac{dP}{dt} = 1100 r \Rightarrow (\frac{1}{1200-P} + \frac{1}{P-100})dP = 1100 r dt$

$\Rightarrow \int (\frac{1}{1200-P} + \frac{1}{P-100})dP = \int 1100 r dt \Rightarrow -\ln(1200 - P) + \ln(P - 100) = 1100 rt + C_1$

$\Rightarrow \ln|\frac{P-100}{1200-P}| = 1100 rt + C_1 \Rightarrow \ln|\frac{P-100}{1200-P}| = 1100 rt + C_1 \Rightarrow \frac{P-100}{1200-P} = \pm e^{C_1}e^{1100 rt} \Rightarrow \frac{P-100}{1200-P} = Ce^{1100 rt}$

where $C = \pm e^{C_1} \Rightarrow P - 100 = 1200Ce^{1100 rt} - CPe^{1100 rt} \Rightarrow P(1 + Ce^{1100 rt}) = 1200Ce^{1100 rt} + 100$

$\Rightarrow P = \frac{1200Ce^{1100 rt} + 100}{Ce^{1100 rt} + 1} = \frac{1200 + \frac{100}{C}e^{-1100 rt}}{1 + \frac{1}{C}e^{-1100 rt}} \Rightarrow P = \frac{1200 + 100Ae^{-1100 rt}}{1 + Ae^{-1100 rt}}$ where $A = \frac{1}{C}$.

(b) Apply the initial condition: $300 = \frac{1200 + 100A}{1 + A} \Rightarrow 300 + 300A = 1200 + 100A \Rightarrow A = \frac{9}{2} \Rightarrow P = \frac{2400 + 900Ae^{-1100 rt}}{2 + 9e^{-1100 rt}}$.

(Note that $P \rightarrow 1200$ as $t \rightarrow \infty$.)

(c) $\frac{dP}{dt} = r(M - P)(P - m) \Rightarrow \frac{1}{(M-P)(P-m)} \frac{dP}{dt} = r \Rightarrow \frac{M-m}{(M-P)(P-m)} \frac{dP}{dt} = r(M - m) \Rightarrow \frac{(P-m) + (M-P)}{(M-P)(P-m)} \frac{dP}{dt} = r(M - m)$

$\Rightarrow (\frac{1}{M-P} + \frac{1}{P-m}) \frac{dP}{dt} = r(M - m) \Rightarrow \int (\frac{1}{M-P} + \frac{1}{P-m})dP = \int r(M - m)dt$

$\Rightarrow -\ln(M - P) + \ln(P - m) = (M - m)rt + C_1 \Rightarrow \ln|\frac{P-m}{M-P}| = (M - m)rt + C_1 \Rightarrow \frac{P-m}{M-P} = \pm e^{C_1}e^{(M-m)rt}$

$\Rightarrow \frac{P-m}{M-P} = Ce^{(M-m)rt}$ where $C = \pm e^{C_1} \Rightarrow P - m = MCE^{(M-m)rt} - CPE^{(M-m)rt}$

$\Rightarrow P(1 + Ce^{(M-m)rt}) = MCE^{(M-m)rt} + m \Rightarrow P = \frac{MCE^{(M-m)rt} + m}{Ce^{(M-m)rt} + 1} \Rightarrow P = \frac{M + \frac{m}{C}e^{-(M-m)rt}}{1 + \frac{1}{C}e^{-(M-m)rt}} \Rightarrow P = \frac{M + mAe^{-(M-m)rt}}{1 + Ae^{-(M-m)rt}}$

$A = \frac{1}{C}$.

Apply the initial condition $P(0) = P_0$

$P_0 = \frac{M+mA}{1+A} \Rightarrow P_0 + P_0A = M + mA \Rightarrow A = \frac{M-P_0}{P_0-m} \Rightarrow P = \frac{M(P_0-m) + m(M-P_0)e^{-(M-m)rt}}{(P_0-m) + (M-P_0)e^{-(M-m)rt}}$

(Note that $P \rightarrow M$ as $t \rightarrow \infty$ provided $P_0 > m$.)

13. $y = mx \Rightarrow \frac{y}{x} = m \Rightarrow \frac{xy' - y}{x^2} = 0 \Rightarrow y' = \frac{y}{x}$. So for

orthogonals: $\frac{dy}{dx} = -\frac{x}{y} \Rightarrow y dy = -x dx \Rightarrow \frac{y^2}{2} + \frac{x^2}{2} = C$

$\Rightarrow x^2 + y^2 = C_1$

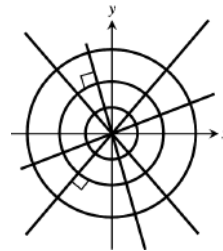

14. $y = cx^2 \Rightarrow \frac{y}{x^2} = c \Rightarrow \frac{x^2 y' - 2xy}{x^4} = 0 \Rightarrow x^2 y' = 2xy$
 $\Rightarrow y' = \frac{2y}{x}$. So for the orthogonals: $\frac{dy}{dx} = -\frac{x}{2y}$
 $\Rightarrow 2y dy = -x dx \Rightarrow y^2 = -\frac{x^2}{2} + C \Rightarrow y = \pm \sqrt{\frac{x^2}{2} + C}$,
 $C > 0$

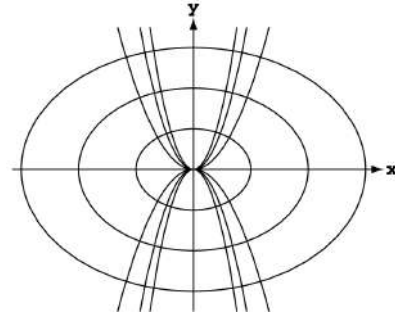

15. $kx^2 + y^2 = 1 \Rightarrow 1 - y^2 = kx^2 \Rightarrow \frac{1-y^2}{x^2} = k$
 $\Rightarrow \frac{x^2(2y)y' - (1-y^2)2x}{x^4} = 0 \Rightarrow -2yx^2 y' = (1-y^2)(2x)$
 $\Rightarrow y' = \frac{(1-y^2)(2x)}{-2xy^2} = \frac{(1-y^2)}{-xy}$. So for the orthogonals:
 $\frac{dy}{dx} = \frac{xy}{1-y^2} \Rightarrow \frac{(1-y^2)}{y} dy = x dx \Rightarrow \ln y - \frac{y^2}{2} = \frac{x^2}{2} + C$

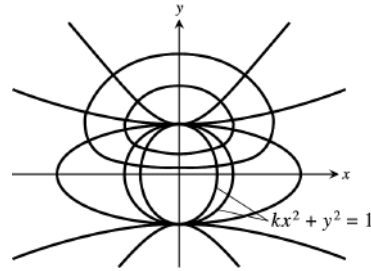

16. $2x^2 + y^2 = c^2 \Rightarrow 4x + 2yy' = 0 \Rightarrow y' = -\frac{4x}{2y} = -\frac{2x}{y}$. For
 orthogonals: $\frac{dy}{dx} = \frac{y}{2x} \Rightarrow \frac{dy}{y} = \frac{dx}{2x} \Rightarrow \ln y = \frac{1}{2} \ln x + C$
 $\Rightarrow \ln y = \ln x^{1/2} + \ln C_1 \Rightarrow y = C_1 |x|^{1/2}$

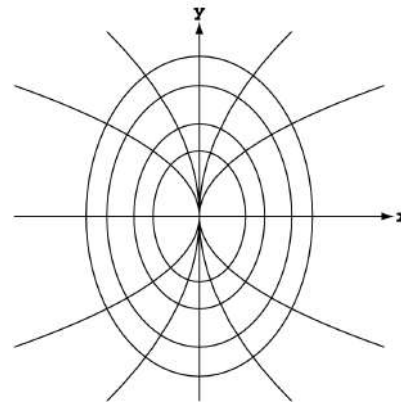

17. $y = ce^{-x} \Rightarrow \frac{y}{e^{-x}} = c \Rightarrow \frac{e^{-x}y' - y(e^{-x})(-1)}{(e^{-x})^2} = 0$
 $\Rightarrow e^{-x}y' = -ye^{-x} \Rightarrow y' = -y$. So for the orthogonals:
 $\frac{dy}{dx} = \frac{1}{y} \Rightarrow y dy = dx \Rightarrow \frac{y^2}{2} = x + C$
 $\Rightarrow y^2 = 2x + C_1 \Rightarrow y = \pm \sqrt{2x + C_1}$

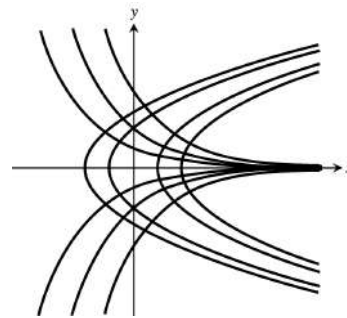

18. $y = e^{kx} \Rightarrow \ln y = kx \Rightarrow \frac{\ln y}{x} = k \Rightarrow \frac{x(\frac{1}{y})y' - \ln y}{x^2} = 0$
 $\Rightarrow \left(\frac{x}{y}\right)y' - \ln y = 0 \Rightarrow y' = \frac{y \ln y}{x}$. So for the orthogonals:
 $\frac{dy}{dx} = \frac{-x}{y \ln y} \Rightarrow y \ln y dy = -x dx$
 $\Rightarrow \frac{1}{2}y^2 \ln y - \frac{1}{4}(y^2) = (-\frac{1}{2}x^2) + C$
 $\Rightarrow y^2 \ln y - \frac{y^2}{2} = -x^2 + C_1$

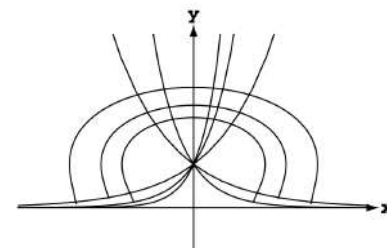

19. $2x^2 + 3y^2 = 5$ and $y^2 = x^3$ intersect at $(1, 1)$. Also, $2x^2 + 3y^2 = 5 \Rightarrow 4x + 6y y' = 0 \Rightarrow y' = -\frac{4x}{6y} \Rightarrow y'(1, 1) = -\frac{2}{3}$
 $y_1^2 = x^3 \Rightarrow 2y_1 y_1' = 3x^2 \Rightarrow y_1' = \frac{3x^2}{2y_1} \Rightarrow y_1'(1, 1) = \frac{3}{2}$. Since $y' \cdot y_1' = (-\frac{2}{3})(\frac{3}{2}) = -1$, the curves are orthogonal.

20. (a) $x dx + y dy = 0 \Rightarrow \frac{x^2}{2} + \frac{y^2}{2} = C$ is the general equation of the family with slope $y' = -\frac{x}{y}$. For the orthogonals:
 $y' = \frac{y}{x} \Rightarrow \frac{dy}{y} = \frac{dx}{x} \Rightarrow \ln y = \ln x + C$ or $y = C_1 x$
 (where $C_1 = e^C$) is the general equation of the orthogonals.

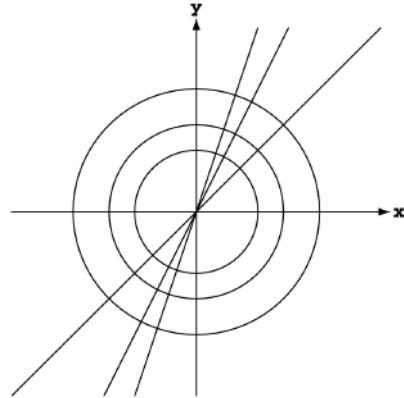

(b) $x dy - 2y dx = 0 \Rightarrow 2y dx = x dy \Rightarrow \frac{dy}{y} = \frac{dx}{2x}$
 $\Rightarrow \frac{1}{2} \left(\frac{dy}{y} \right) = \frac{dx}{x} \Rightarrow \frac{1}{2} \ln y = \ln x + C \Rightarrow y = C_1 x^2$
 the equation for the solution family.
 $\frac{1}{2} \ln y - \ln x = C \Rightarrow \frac{1}{2} \frac{y'}{y} - \frac{1}{x} = 0 \Rightarrow y' = \frac{2y}{x}$
 \Rightarrow slope of orthogonals is $\frac{dy}{dx} = -\frac{x}{2y}$
 $\Rightarrow 2y dy = -x dx \Rightarrow y^2 = -\frac{x^2}{2} + C$ is the general equation of the orthogonals.

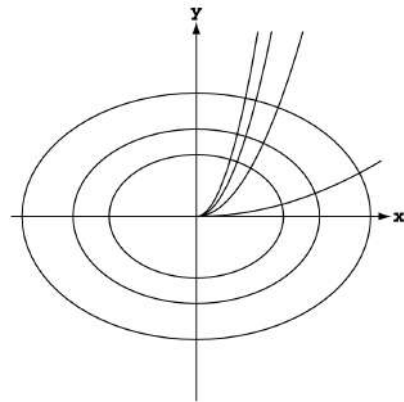

21. $y^2 = 4a^2 - 4ax$ and $y^2 = 4b^2 + 4bx \Rightarrow$ (at intersection) $4a^2 - 4ax = 4b^2 + 4bx \Rightarrow a^2 - b^2 = x(a + b)$
 $\Rightarrow (a + b)(a - b) = (a + b)x \Rightarrow x = a - b$. Now, $y^2 = 4a^2 - 4a(a - b) = 4a^2 - 4a^2 + 4ab = 4ab \Rightarrow y = \pm 2\sqrt{ab}$.
 Thus the intersections are at $(a - b, \pm 2\sqrt{ab})$. So, $y^2 = 4a^2 - 4ax \Rightarrow y_1' = -\frac{4a}{2y}$ which are equal to $-\frac{4a}{2(2\sqrt{ab})}$ and $-\frac{4a}{2(-2\sqrt{ab})} = -\sqrt{\frac{a}{b}}$ and $\sqrt{\frac{a}{b}}$ at the intersections. Also, $y^2 = 4b^2 + 4bx \Rightarrow y_2' = \frac{4b}{2y}$ which are equal to $\frac{4b}{2(2\sqrt{ab})}$ and $\frac{4b}{2(-2\sqrt{ab})} = -\sqrt{\frac{b}{a}}$ and $\sqrt{\frac{b}{a}}$ at the intersections. $(y_1') \cdot (y_2') = -1$. Thus the curves are orthogonal.

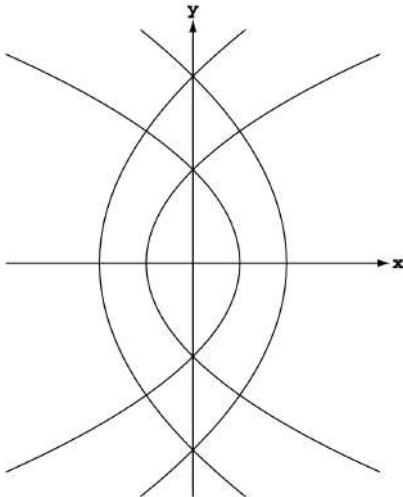

CHAPTER 9 PRACTICE EXERCISES

- $\frac{dy}{dx} = \sqrt{y} \cos^2 \sqrt{y} \Rightarrow \frac{dy}{\sqrt{y} \cos^2 \sqrt{y}} = dx \Rightarrow 2 \tan \sqrt{y} = x + C \Rightarrow y = (\tan^{-1}(\frac{x+C}{2}))^2$
- $y' = \frac{3y(x+1)^2}{y-1} \Rightarrow \frac{(y-1)}{y} dy = 3(x+1)^2 dx \Rightarrow y - \ln y = (x+1)^3 + C$
- $yy' = \sec(y^2) \sec^2 x \Rightarrow \frac{y dy}{\sec(y^2)} = \sec^2 x dx \Rightarrow \frac{\sin(y^2)}{2} = \tan x + C \Rightarrow \sin(y^2) = 2 \tan x + C_1$
- $y \cos^2(x) dy + \sin x dx = 0 \Rightarrow y dy = -\frac{\sin x}{\cos^2(x)} dx \Rightarrow \frac{y^2}{2} = -\frac{1}{\cos(x)} + C \Rightarrow y = \pm \sqrt{\frac{-2}{\cos(x)} + C_1}$
- $y' = xe^y \sqrt{x-2} \Rightarrow e^{-y} dy = x \sqrt{x-2} dx \Rightarrow -e^{-y} = \frac{2(x-2)^{3/2}(3x+4)}{15} + C \Rightarrow e^{-y} = \frac{-2(x-2)^{3/2}(3x+4)}{15} - C$
 $\Rightarrow -y = \ln \left[\frac{-2(x-2)^{3/2}(3x+4)}{15} - C \right] \Rightarrow y = -\ln \left[\frac{-2(x-2)^{3/2}(3x+4)}{15} - C \right]$
- $y' = xye^{x^2} \Rightarrow \frac{dy}{y} = e^{x^2} x dx \Rightarrow \ln y = \frac{1}{2} e^{x^2} + C$
- $\sec x dy + x \cos^2 y dx = 0 \Rightarrow \frac{dy}{\cos^2 y} = -\frac{x dx}{\sec x} \Rightarrow \tan y = -\cos x - x \sin x + C$
- $2x^2 dx - 3\sqrt{y} \csc x dy = 0 \Rightarrow 3\sqrt{y} dy = \frac{2x^2}{\csc x} dx \Rightarrow 2y^{3/2} = 2(2-x^2)\cos x + 4x \sin x + C$
 $\Rightarrow y^{3/2} = (2-x^2)\cos x + 2x \sin x + C_1$
- $y' = \frac{e^y}{xy} \Rightarrow ye^{-y} dy = \frac{dx}{x} \Rightarrow (y+1)e^{-y} = -\ln|x| + C$
- $y' = xe^{x-y} \csc y \Rightarrow y' = \frac{xe^x}{e^y} \csc y \Rightarrow \frac{e^y}{\csc y} dy = xe^x dx \Rightarrow \frac{e^y}{2} (\sin y - \cos y) = (x-1)e^x + C$
- $x(x-1)dy - y dx = 0 \Rightarrow x(x-1)dy = y dx \Rightarrow \frac{dy}{y} = \frac{dx}{x(x-1)} \Rightarrow \ln y = \ln(x-1) - \ln(x) + C$
 $\Rightarrow \ln y = \ln(x-1) - \ln(x) + \ln C_1 \Rightarrow \ln y = \ln \left(\frac{C_1(x-1)}{x} \right) \Rightarrow y = \frac{C_1(x-1)}{x}$
- $y' = (y^2 - 1)(x^{-1}) \Rightarrow \frac{dy}{y^2-1} = \frac{dx}{x} \Rightarrow \frac{\ln \left(\frac{y-1}{y+1} \right)}{2} = \ln x + C \Rightarrow \ln \left(\frac{y-1}{y+1} \right) = 2 \ln x + \ln C_1 \Rightarrow \frac{y-1}{y+1} = C_1 x^2$
- $2y' - y = xe^{x/2} \Rightarrow y' - \frac{1}{2}y = \frac{x}{2}e^{x/2}$
 $p(x) = -\frac{1}{2}, v(x) = e^{\int (-\frac{1}{2}) dx} = e^{-x/2}$
 $e^{-x/2} y' - \frac{1}{2}e^{-x/2} y = (e^{-x/2}) \left(\frac{x}{2} \right) (e^{x/2}) = \frac{x}{2} \Rightarrow \frac{d}{dx} (e^{-x/2} y) = \frac{x}{2} \Rightarrow e^{-x/2} y = \frac{x^2}{4} + C \Rightarrow y = e^{x/2} \left(\frac{x^2}{4} + C \right)$
- $\frac{y'}{2} + y = e^{-x} \sin x \Rightarrow y' + 2y = 2e^{-x} \sin x$
 $p(x) = 2, v(x) = e^{\int 2 dx} = e^{2x}$
 $e^{2x} y' + 2e^{2x} y = 2e^{2x} e^{-x} \sin x = 2e^x \sin x \Rightarrow \frac{d}{dx} (e^{2x} y) = 2e^x \sin x \Rightarrow e^{2x} y = e^x (\sin x - \cos x) + C$
 $\Rightarrow y = e^{-x} (\sin x - \cos x) + Ce^{-2x}$
- $xy' + 2y = 1 - x^{-1} \Rightarrow y' + \left(\frac{2}{x} \right) y = \frac{1}{x} - \frac{1}{x^2}$
 $v(x) = e^{2 \int \frac{dx}{x}} = e^{2 \ln x} = e^{\ln x^2} = x^2$
 $x^2 y' + 2xy = x - 1 \Rightarrow \frac{d}{dx} (x^2 y) = x - 1 \Rightarrow x^2 y = \frac{x^2}{2} - x + C \Rightarrow y = \frac{1}{2} - \frac{1}{x} + \frac{C}{x^2}$

16. $xy' - y = 2x \ln x \Rightarrow y' - \left(\frac{1}{x}\right)y = 2 \ln x.$

$$v(x) = e^{-\int \frac{dx}{x}} = e^{-\ln x} = \frac{1}{x}. \left(\frac{1}{x}\right)y' - \left(\frac{1}{x}\right)^2 y = \frac{2}{x} \ln x \Rightarrow$$

$$\frac{d}{dx} \left(\frac{1}{x} \cdot y\right) = \frac{2}{x} \ln x \Rightarrow \frac{1}{x} \cdot y = [\ln x]^2 + C \Rightarrow y = x[\ln x]^2 + Cx$$

17. $(1 + e^x)dy + (ye^x + e^{-x})dx = 0 \Rightarrow (1 + e^x)y' + e^x y = -e^{-x} \Rightarrow y' = \frac{e^x}{1+e^x}y = \frac{-e^{-x}}{(1+e^x)}.$

$$v(x) = e^{\int \frac{e^x dx}{1+e^x}} = e^{\ln(e^x+1)} = e^x + 1.$$

$$(e^x + 1)y' + (e^x + 1)\left(\frac{e^x}{1+e^x}\right)y = \frac{-e^{-x}}{(1+e^x)}(e^x + 1) \Rightarrow \frac{d}{dx}[(e^x + 1)y] = -e^{-x} \Rightarrow (e^x + 1)y = e^{-x} + C$$

$$\Rightarrow y = \frac{e^{-x} + C}{e^x + 1} = \frac{e^{-x} + C}{1 + e^x}$$

18. $\frac{dx}{dy} + x - 4ye^y = 0 \Rightarrow x' + x = 4ye^y.$ Let $v(y) = e^{\int dy} = e^y.$ Then $e^y x' + xe^y = 4ye^{2y} \Rightarrow \frac{d}{dy}(xe^y) = 4ye^{2y}$

$$\Rightarrow xe^y = (2y - 1)e^{2y} + C \Rightarrow x = (2y - 1)e^y + Ce^{-y}$$

19. $(x + 3y^2)dy + ydx = 0 \Rightarrow xdy + ydx = -3y^2dy \Rightarrow \frac{d}{dx}(xy) = -3y^2dy \Rightarrow xy = -y^3 + C$

20. $ydx + (3x - y^{-2}\cos y)dx = 0 \Rightarrow x' + \left(\frac{3}{y}\right)x = y^{-3}\cos y.$ Let $v(y) = e^{\int \frac{3dy}{y}} = e^{3\ln y} = e^{\ln y^3} = y^3.$

$$\text{Then } y^3 x' + 3y^2 x = \cos y \text{ and } y^3 x = \int \cos y dy = \sin y + C. \text{ So } x = y^{-3}(\sin y + C)$$

21. $\frac{dy}{dx} = e^{-x-y-2} \Rightarrow e^y dy = e^{-(x+2)} dx \Rightarrow e^y = -e^{-(x+2)} + C.$ We have $y(0) = -2,$ so $e^{-2} = -e^{-2} + C \Rightarrow C = 2e^{-2}$ and $e^y = -e^{-(x+2)} + 2e^{-2} \Rightarrow y = \ln(-e^{-(x+2)} + 2e^{-2})$

22. $\frac{dy}{dx} = \frac{y \ln y}{1+x^2} \Rightarrow \frac{dy}{y \ln y} = \frac{dx}{1+x^2} \Rightarrow \ln(\ln y) = \tan^{-1}(x) + C \Rightarrow y = e^{e^{\tan^{-1}(x)+C}}.$ We have $y(0) = e^2 \Rightarrow e^2 = e^{e^{\tan^{-1}(0)+C}} \Rightarrow e^{\tan^{-1}(0)+C} = 2 \Rightarrow \tan^{-1}(0) + C = \ln 2 \Rightarrow 0 + C = \ln 2 \Rightarrow C = \ln 2 \Rightarrow y = e^{e^{\tan^{-1}(x)+\ln 2}}$

23. $(x + 1)\frac{dy}{dx} + 2y = x \Rightarrow y' + \left(\frac{2}{x+1}\right)y = \frac{x}{x+1}.$ Let $v(x) = e^{\int \frac{2}{x+1} dx} = e^{2\ln(x+1)} = e^{\ln(x+1)^2} = (x + 1)^2.$

$$\text{So } y'(x + 1)^2 + \frac{2}{(x+1)}(x + 1)^2 y = \frac{x}{(x+1)}(x + 1)^2 \Rightarrow \frac{d}{dx}[y(x + 1)^2] = x(x + 1) \Rightarrow y(x + 1)^2 = \int x(x + 1) dx$$

$$\Rightarrow y(x + 1)^2 = \frac{x^3}{3} + \frac{x^2}{2} + C \Rightarrow y = (x + 1)^{-2} \left(\frac{x^3}{3} + \frac{x^2}{2} + C\right). \text{ We have } y(0) = 1 \Rightarrow 1 = C. \text{ So}$$

$$y = (x + 1)^{-2} \left(\frac{x^3}{3} + \frac{x^2}{2} + 1\right)$$

24. $x\frac{dy}{dx} + 2y = x^2 + 1 \Rightarrow y' + \left(\frac{2}{x}\right)y = x + \frac{1}{x}.$ Let $v(x) = e^{\int \left(\frac{2}{x}\right) dx} = e^{\ln x^2} = x^2.$ So $x^2 y' + 2xy = x^3 + x$

$$\Rightarrow \frac{d}{dx}(x^2 y) = x^3 + x \Rightarrow x^2 y = \frac{x^4}{4} + \frac{x^2}{2} + C \Rightarrow y = \frac{x^2}{4} + \frac{C}{x^2} + \frac{1}{2}. \text{ We have } y(1) = 1 \Rightarrow 1 = \frac{1}{4} + C + \frac{1}{2} \Rightarrow C = \frac{1}{4}.$$

$$\text{So } y = \frac{x^2}{4} + \frac{1}{4x^2} + \frac{1}{2} = \frac{x^4 + 2x^2 + 1}{4x^2}$$

25. $\frac{dy}{dx} + 3x^2 y = x^2.$ Let $v(x) = e^{\int 3x^2 dx} = e^{x^3}.$ So $e^{x^3} y' + 3x^2 e^{x^3} y = x^2 e^{x^3} \Rightarrow \frac{d}{dx}(e^{x^3} y) = x^2 e^{x^3} \Rightarrow e^{x^3} y = \frac{1}{3} e^{x^3} + C.$

$$\text{We have } y(0) = -1 \Rightarrow e^{0^3}(-1) = \frac{1}{3}e^{0^3} + C \Rightarrow -1 = \frac{1}{3} + C \Rightarrow C = -\frac{4}{3} \text{ and } e^{x^3} y = \frac{1}{3}e^{x^3} - \frac{4}{3} \Rightarrow y = \frac{1}{3} - \frac{4}{3}e^{-x^3}$$

26. $x dy + (y - \cos x)dx = 0 \Rightarrow xy' + y - \cos x = 0 \Rightarrow y' + \left(\frac{1}{x}\right)y = \frac{\cos x}{x}.$ Let $v(x) = e^{\int \frac{1}{x} dx} = e^{\ln x} = x.$

$$\text{So } xy' + x\left(\frac{1}{x}\right)y = \cos x \Rightarrow \frac{d}{dx}(xy) = \cos x \Rightarrow xy = \int \cos x dx \Rightarrow xy = \sin x + C. \text{ We have } y\left(\frac{\pi}{2}\right) = 0 \Rightarrow \left(\frac{\pi}{2}\right)0 = 1 + C$$

$$\Rightarrow C = -1. \text{ So } xy = -1 + \sin x \Rightarrow y = \frac{-1 + \sin x}{x}$$

27. $x dy - (y + \sqrt{y})dx = 0 \Rightarrow \frac{dy}{(y + \sqrt{y})} = \frac{dx}{x} \Rightarrow 2\ln(\sqrt{y} + 1) = \ln x + C.$ We have $y(1) = 1 \Rightarrow 2\ln(\sqrt{1} + 1) = \ln 1 + C$

$$\Rightarrow 2\ln 2 = C = \ln 2^2 = \ln 4. \text{ So } 2\ln(\sqrt{y} + 1) = \ln x + \ln 4 = \ln(4x) \Rightarrow \ln(\sqrt{y} + 1) = \frac{1}{2}\ln(4x) = \ln(4x)^{1/2}$$

$$\Rightarrow e^{\ln(\sqrt{y}+1)} = e^{\ln(4x)^{1/2}} \Rightarrow \sqrt{y} + 1 = 2\sqrt{x} \Rightarrow y = (2\sqrt{x} - 1)^2$$

28. $y^{-2} \frac{dx}{dy} = \frac{e^x}{e^{2x+1}} \Rightarrow \frac{e^{2x}+1}{e^x} dx = \frac{dy}{y^2} \Rightarrow \frac{y^3}{3} = e^x - e^{-x} + C$. We have $y(0) = 1 \Rightarrow \frac{(1)^3}{3} = e^0 - e^0 + C \Rightarrow C = \frac{1}{3}$.

So $\frac{y^3}{3} = e^x - e^{-x} + \frac{1}{3} \Rightarrow y^3 = 3(e^x - e^{-x}) + 1 \Rightarrow y = [3(e^x - e^{-x}) + 1]^{1/3}$

29. $xy' + (x-2)y = 3x^3e^{-x} \Rightarrow y' + \left(\frac{x-2}{x}\right)y = 3x^2e^{-x}$. Let $v(x) = e^{\int(\frac{x-2}{x})dx} = e^{x-2\ln x} = \frac{e^x}{x^2}$. So

$\frac{e^x}{x^2}y' + \frac{e^x}{x^2}\left(\frac{x-2}{x}\right)y = 3 \Rightarrow \frac{d}{dx}\left(y \cdot \frac{e^x}{x^2}\right) = 3 \Rightarrow y \cdot \frac{e^x}{x^2} = 3x + C$. We have $y(1) = 0 \Rightarrow 0 = 3(1) + C \Rightarrow C = -3$
 $\Rightarrow y \cdot \frac{e^x}{x^2} = 3x - 3 \Rightarrow y = x^2e^{-x}(3x - 3)$

30. $y dx + (3x - xy + 2)dy = 0 \Rightarrow \frac{dx}{dy} + \frac{3x-xy+2}{y} = 0 \Rightarrow \frac{dx}{dy} + \frac{3x}{y} - x = -\frac{2}{y} \Rightarrow \frac{dx}{dy} + \left(\frac{3}{y} - 1\right)x = -\frac{2}{y}$.

$P(y) = \frac{3}{y} - 1 \Rightarrow \int P(y)dy = 3\ln y - y \Rightarrow v(y) = e^{3\ln y - y} = y^3e^{-y}$

$y^3e^{-y}x' + y^3e^{-y}\left(\frac{3}{y} - 1\right)x = -2y^2e^{-y} \Rightarrow y^3e^{-y}x = \int -2y^2e^{-y}dy = 2e^{-y}(y^2 + 2y + 2) + C$

$\Rightarrow y^3 = \frac{2(y^2+2y+2)+Ce^y}{x}$. We have $y(2) = -1 \Rightarrow -1 = \frac{2(1-2+2)+Ce^{-1}}{2} \Rightarrow C = -4e$ and

$\Rightarrow y^3 = \frac{2(y^2+2y+2) - 4e^{y+1}}{x}$

31. To find the approximate values let $y_n = y_{n-1} + (y_{n-1} + \cos x_{n-1})(0.1)$ with $x_0 = 0$, $y_0 = 0$, and 20 steps. Use a spreadsheet, graphing calculator, or CAS to obtain the values in the following table.

x	y	x	y
0	0	1.1	1.6241
0.1	0.1000	1.2	1.8319
0.2	0.2095	1.3	2.0513
0.3	0.3285	1.4	2.2832
0.4	0.4568	1.5	2.5285
0.5	0.5946	1.6	2.7884
0.6	0.7418	1.7	3.0643
0.7	0.8986	1.8	3.3579
0.8	1.0649	1.9	3.6709
0.9	1.2411	2.0	4.0057
1.0	1.4273		

32. To find the approximate values let $z_n = y_{n-1} + ((2 - y_{n-1})(2x_{n-1} + 3))(0.1)$ and

$y_n = y_{n-1} + \left(\frac{(2-y_{n-1})(2x_{n-1}+3) + (2-z_n)(2x_n+3)}{2}\right)(0.1)$ with initial values $x_0 = -3$, $y_0 = 1$, and 20 steps. Use a

spreadsheet, graphing calculator, or CAS to obtain the values in the following table.

x	y	x	y
-3	1	-1.9	-5.9686
-2.9	0.6680	-1.8	-6.5456
-2.8	0.2599	-1.7	-6.9831
-2.7	-0.2294	-1.6	-7.2562
-2.6	-0.8011	-1.5	-7.3488
-2.5	-1.4509	-1.4	-7.2553
-2.4	-2.1687	-1.3	-6.9813
-2.3	-2.9374	-1.2	-6.5430
-2.2	-3.7333	-1.1	-5.9655
-2.1	-4.5268	-1.0	-5.2805
-2.0	-5.2840		

33. To estimate $y(3)$, let $z_n = y_{n-1} + \left(\frac{x_{n-1} - 2y_{n-1}}{x_{n-1} + 1}\right)(0.05)$ and $y_n = y_{n-1} + \frac{1}{2}\left(\frac{x_{n-1} - 2y_{n-1}}{x_{n-1} + 1} + \frac{x_n - 2z_n}{x_n + 1}\right)(0.05)$ with initial values $x_0 = 0$, $y_0 = 1$, and 60 steps. Use a spreadsheet, graphing calculator, or CAS to obtain $y(3) \approx 0.9063$.
34. To estimate $y(4)$, let $z_n = y_{n-1} + \left(\frac{x_{n-1}^2 - 2y_{n-1} + 1}{x_{n-1}}\right)(0.05)$ with initial values $x_0 = 1$, $y_0 = 1$, and 60 steps. Use a spreadsheet, graphing calculator, or CAS to obtain $y(4) \approx 4.4974$.
35. Let $y_n = y_{n-1} + \left(\frac{1}{e^{x_{n-1}} + y_{n-1} + 2}\right)(dx)$ with starting values $x_0 = 0$ and $y_0 = 2$, and steps of 0.1 and -0.1 . Use a spreadsheet, programmable calculator, or CAS to generate the following graphs.

(a)

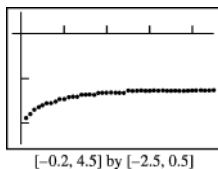

- (b) Note that we choose a small interval of x -values because the y -values decrease very rapidly and our calculator cannot handle the calculations for $x \leq -1$. (This occurs because the analytic solution is $y = -2 + \ln(2 - e^{-x})$, which has an asymptote at $x = -\ln 2 \approx 0.69$. Obviously, the Euler approximations are misleading for $x \leq -0.7$.)

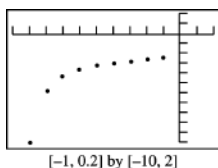

36. Let $z_n = y_{n-1} - \left(\frac{x_{n-1}^2 + y_{n-1}}{e^{y_{n-1}} + x_{n-1}}\right)(dx)$ and $y_n = y_{n-1} + \frac{1}{2}\left(\frac{x_{n-1}^2 + y_{n-1}}{e^{y_{n-1}} + x_{n-1}} + \frac{x_n^2 + z_n}{e^{z_n} + x_n}\right)(dx)$ with starting values $x_0 = 0$ and $y_0 = 0$, and steps of 0.1 and -0.1 . Use a spreadsheet, programmable calculator, or CAS to generate the following graphs.

(a)

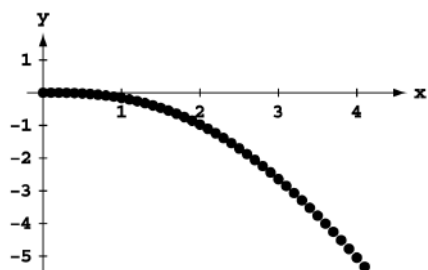

(b)

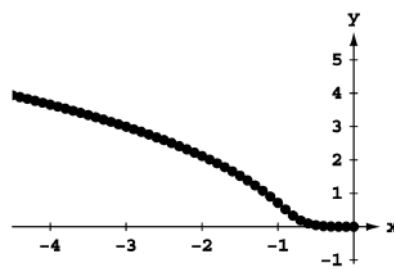

37.

x	1	1.2	1.4	1.6	1.8	2.0
y	-1	-0.8	-0.56	-0.28	0.04	0.4

$$\frac{dy}{dx} = x \Rightarrow dy = x dx \Rightarrow y = \frac{x^2}{2} + C; x = 1 \text{ and } y = -1$$

$$\Rightarrow -1 = \frac{1}{2} + C \Rightarrow C = -\frac{3}{2} \Rightarrow y(\text{exact}) = \frac{x^2}{2} - \frac{3}{2}$$

$$\Rightarrow y(2) = \frac{2^2}{2} - \frac{3}{2} = \frac{1}{2} \text{ is the exact value.}$$

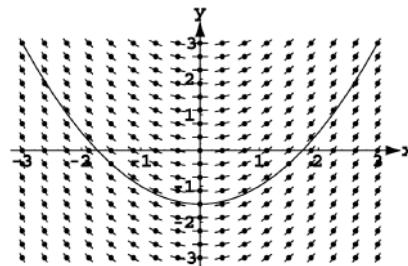

38.	x	1	1.2	1.4	1.6	1.8	2.0
	y	-1	-0.8	-0.6333	-0.4904	-0.3654	-0.2544

$$\frac{dy}{dx} = \frac{1}{x} \Rightarrow dy = \frac{1}{x} dx \Rightarrow y = \ln|x| + C; x = 1 \text{ and } y = -1$$

$$\Rightarrow -1 = \ln 1 + C \Rightarrow C = -1 \Rightarrow y(\text{exact}) = \ln|x| - 1$$

$$\Rightarrow y(2) = \ln 2 - 1 \approx -0.3069 \text{ is the exact value.}$$

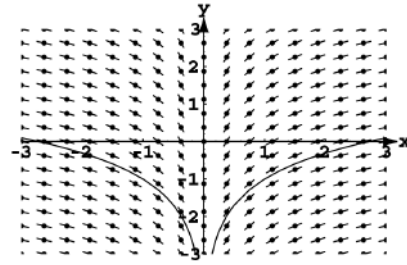

39.	x	1	1.2	1.4	1.6	1.8	2.0
	y	-1	-1.2	-0.488	-1.9046	-2.5141	-3.4192

$$\frac{dy}{dx} = xy \Rightarrow \frac{dy}{y} = x dx \Rightarrow \ln|y| = \frac{x^2}{2} + C$$

$$\Rightarrow y = e^{\frac{x^2}{2} + C} = e^{\frac{x^2}{2}} \cdot e^C = C_1 e^{\frac{x^2}{2}}; x = 1 \text{ and } y = -1$$

$$\Rightarrow -1 = C_1 e^{1/2} \Rightarrow C_1 = -e^{1/2} y(\text{exact}) = -e^{1/2} \cdot e^{\frac{x^2}{2}}$$

$$= -e^{(x^2-1)/2} \Rightarrow y(2) = -e^{3/2} \approx -4.4817 \text{ is the exact value.}$$

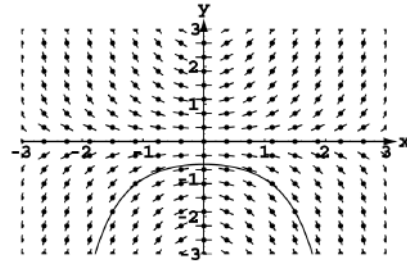

40.	x	1	1.2	1.4	1.6	1.8	2.0
	y	-1	-1.2	-1.3667	-1.5130	-1.6452	-1.7688

$$\frac{dy}{dx} = \frac{1}{y} \Rightarrow y dy = dx \Rightarrow \frac{y^2}{2} = x + C; x = 1 \text{ and } y = -1$$

$$\frac{1}{2} = 1 + C \Rightarrow C = -\frac{1}{2} \Rightarrow y^2 = 2x - 1$$

$$\Rightarrow y(\text{exact}) = \sqrt{2x - 1} \Rightarrow y(2) = -\sqrt{3} \approx -1.7321 \text{ is the exact value.}$$

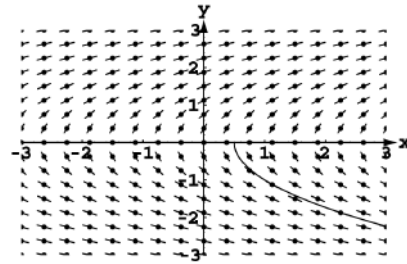

41. $\frac{dy}{dx} = y^2 - 1 \Rightarrow y' = (y + 1)(y - 1)$. We have $y' = 0 \Rightarrow (y + 1) = 0, (y - 1) = 0 \Rightarrow y = -1, 1$.
- (a) Equilibrium points are -1 (stable) and 1 (unstable)
- (b) $y' = y^2 - 1 \Rightarrow y'' = 2yy' \Rightarrow y'' = 2y(y^2 - 1) = 2y(y + 1)(y - 1)$. So $y'' = 0 \Rightarrow y = 0, y = -1, y = 1$.

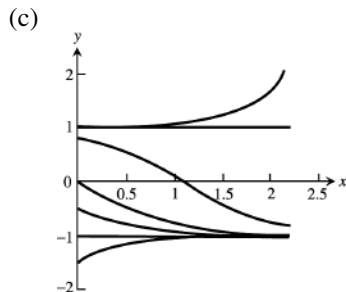
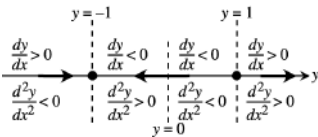

42. $\frac{dy}{dx} = y - y^2 \Rightarrow y' = y(1 - y)$. We have $y' = 0 \Rightarrow y(1 - y) = 0 \Rightarrow y = 0, 1 - y = 0 \Rightarrow y = 0, 1$.

- (a) The equilibrium points are 0 and 1. So, 0 is unstable and 1 is stable.
- (b) Let \rightarrow = increasing, \leftarrow = decreasing.

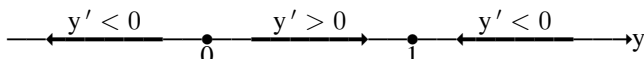

$$y' = y - y^2 \Rightarrow y'' = y' - 2yy' \Rightarrow y'' = (y - y^2) - 2y(y - y^2) = y - y^2 - 2y^2 + 2y^3 \Rightarrow y'' = 2y^3 - 3y^2 + y$$

$$= y(2y^2 - 3y + 1) \Rightarrow y'' = y(2y - 1)(y - 1)$$

So, $y'' = 0 \Rightarrow y = 0, 2y - 1 = 0, y - 1 = 0 \Rightarrow y = 0, y = \frac{1}{2}, y = 1$.

$y = 1$.

Let \rightarrow = concave up, \leftarrow = concave down.

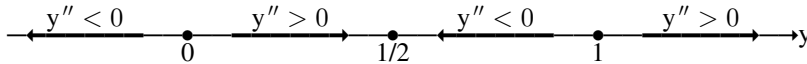

(c)

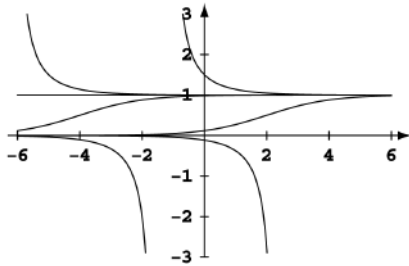

43. (a) Force = Mass times Acceleration (Newton's Second Law) or $F = ma$. Let $a = \frac{dv}{dt} = \frac{dv}{ds} \cdot \frac{ds}{dt} = v \frac{dv}{ds}$. Then $ma = -mgR^2s^{-2} \Rightarrow a = -gR^2s^{-2} \Rightarrow v \frac{dv}{ds} = -gR^2s^{-2} \Rightarrow v dv = -gR^2s^{-2} ds \Rightarrow \int v dv = \int -gR^2s^{-2} ds$
 $\Rightarrow \frac{v^2}{2} = \frac{gR^2}{s} + C_1 \Rightarrow v^2 = \frac{2gR^2}{s} + 2C_1 = \frac{2gR^2}{s} + C$. When $t = 0$, $v = v_0$ and $s = R \Rightarrow v_0^2 = \frac{2gR^2}{R} + C$
 $\Rightarrow C = v_0^2 - 2gR \Rightarrow v^2 = \frac{2gR^2}{s} + v_0^2 - 2gR$
- (b) If $v_0 = \sqrt{2gR}$, then $v^2 = \frac{2gR^2}{s} \Rightarrow v = \sqrt{\frac{2gR^2}{s}}$, since $v \geq 0$ if $v_0 \geq \sqrt{2gR}$. Then $\frac{ds}{dt} = \frac{\sqrt{2gR^2}}{\sqrt{s}} \Rightarrow \sqrt{s} ds = \sqrt{2gR^2} dt$
 $\Rightarrow \int s^{1/2} ds = \int \sqrt{2gR^2} dt \Rightarrow \frac{2}{3}s^{3/2} = \sqrt{2gR^2}t + C_1 \Rightarrow s^{3/2} = (\frac{3}{2}\sqrt{2gR^2})t + C$; $t = 0$ and $s = R$
 $\Rightarrow R^{3/2} = (\frac{3}{2}\sqrt{2gR^2})(0) + C \Rightarrow C = R^{3/2} \Rightarrow s^{3/2} = (\frac{3}{2}\sqrt{2gR^2})t + R^{3/2} = (\frac{3}{2}R\sqrt{2g})t + R^{3/2}$
 $= R^{3/2} [(\frac{3}{2}R^{-1/2}\sqrt{2g})t + 1] = R^{3/2} [(\frac{3v_0}{2R})t + 1] \Rightarrow s = R [1 + (\frac{3v_0}{2R})t]^{2/3}$
44. $\frac{v_0 m}{k} = \text{coasting distance} \Rightarrow \frac{(0.86)(30.84)}{k} = 0.97 \Rightarrow k \approx 27.343$. $s(t) = \frac{v_0 m}{k}(1 - e^{-(k/m)t}) \Rightarrow s(t) = 0.97(1 - e^{-(27.343/30.84)t})$
 $\Rightarrow s(t) = 0.97(1 - e^{-0.8866t})$. A graph of the model is shown superimposed on a graph of the data.

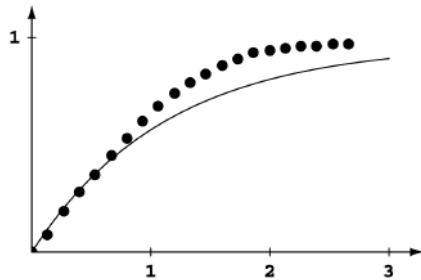

CHAPTER 9 ADDITIONAL AND ADVANCED EXERCISES

1. (a) $\frac{dy}{dt} = k \frac{A}{V}(c - y) \Rightarrow dy = -k \frac{A}{V}(y - c)dt \Rightarrow \frac{dy}{y - c} = -k \frac{A}{V} dt \Rightarrow \int \frac{dy}{y - c} = -\int k \frac{A}{V} dt \Rightarrow \ln|y - c| = -k \frac{A}{V} t + C_1$
 $\Rightarrow y - c = \pm e^{C_1} e^{-k \frac{A}{V} t}$. Apply the initial condition, $y(0) = y_0 \Rightarrow y_0 - c = c + C \Rightarrow C = y_0 - c$
 $\Rightarrow y = c + (y_0 - c)e^{-k \frac{A}{V} t}$.
- (b) Steady state solution: $y_\infty = \lim_{t \rightarrow \infty} y(t) = \lim_{t \rightarrow \infty} [c + (y_0 - c)e^{-k \frac{A}{V} t}] = c + (y_0 - c)(0) = c$
2. Measure the amounts of oxygen involved in mL. Then the inflow of oxygen is 1000 mL/min (Assumed: it will take 5 minutes to deliver the 5L = 5000mL); the amount of oxygen at $t = 0$ is 210 mL; letting $A =$ the amount of oxygen in the flask, the concentration at time t is A mL/L; the outflow rate of oxygen is A mL/L (lb/sec). The rate of change in A , $\frac{dA}{dt}$, equals the rate of gain (1000 mL/min) minus rate of loss (A mL/min). Thus:
 $\frac{dA}{dt} = 1000 - A \Rightarrow \frac{dA}{1000 - A} = dt \Rightarrow \ln(A - 1000) = -t + C \Rightarrow A - 1000 = Ce^{-t}$. At $t = 0$, $A = 210$, so $C = -790$ and $A = 1000 - 790e^{-t}$. Thus, $A(5) = 1000 - 790e^{-5} \approx 994.7$ mL. The concentration is $\frac{994.7 \text{ mL}}{1000 \text{ mL}} = 99.47\%$.

3. The amount of CO₂ in the room at time t is $A(t)$. The rate of change in the amount of CO₂, $\frac{dA}{dt}$ is the rate of internal production (R_1) plus the inflow rate (R_2) minus the outflow rate (R_3).

$$R_1 = \left(20 \frac{\text{breaths/min}}{\text{student}}\right)(30 \text{ students})\left(\frac{100}{1728} \text{ ft}^3\right)\left(0.04 \frac{\text{ft}^3 \text{ CO}_2}{\text{ft}^3}\right) \approx 1.39 \frac{\text{ft}^3 \text{ CO}_2}{\text{min}}$$

$$R_2 = \left(1000 \frac{\text{ft}^3}{\text{min}}\right)\left(0.0004 \frac{\text{ft}^3 \text{ CO}_2}{\text{min}}\right) = 0.4 \frac{\text{ft}^3 \text{ CO}_2}{\text{min}}$$

$$R_3 = \left(\frac{A}{10,000}\right)1000 = 0.1A \frac{\text{ft}^3 \text{ CO}_2}{\text{min}}$$

$$\frac{dA}{dt} = 1.39 + 0.4 - 0.1A = 1.79 - 0.1A \Rightarrow A' + 0.1A = 1.79. \text{ Let } v(t) = e^{\int 0.1 dt}. \text{ We have } \frac{d}{dt}\left(Ae^{\int 0.1 dt}\right) = 1.79e^{\int 0.1 dt}$$

$$\Rightarrow Ae^{0.1t} = \int 1.79e^{0.1t} dt = 17.9e^{0.1t} + C. \text{ At } t = 0, A = (10,000)(0.0004) = 4 \text{ ft}^3 \text{ CO}_2 \Rightarrow C = -13.9$$

$\Rightarrow A = 17.9 - 13.9e^{-0.1t}$. So $A(60) = 17.9 - 13.9e^{-0.1(60)} \approx 17.87 \text{ ft}^3$ of CO₂ in the 10,000 ft³ room. The percent of CO₂ is $\frac{17.87}{10,000} \times 100 = 0.18\%$

4. $\frac{d(mv)}{dt} = F + (v + u)\frac{dm}{dt} \Rightarrow F = \frac{d(mv)}{dt} - (v + u)\frac{dm}{dt} \Rightarrow F = m\frac{dv}{dt} + v\frac{dm}{dt} - v\frac{dm}{dt} - u\frac{dm}{dt} \Rightarrow F = m\frac{dv}{dt} - u\frac{dm}{dt}$.

$$\frac{dm}{dt} = -b \Rightarrow m = -|b|t + C. \text{ At } t = 0, m = m_0, \text{ so } C = m_0 \text{ and } m = m_0 - |b|t.$$

$$\text{Thus, } F = (m_0 - |b|t)\frac{dv}{dt} - u|b| = -(m_0 - |b|t)|g| \Rightarrow \frac{dv}{dt} = -g + \frac{u|b|}{m_0 - |b|t} \Rightarrow v = -gt - u \ln\left(\frac{m_0 - |b|t}{m_0}\right) + C_1$$

$$v = 0 \text{ at } t = 0 \Rightarrow C_1 = 0. \text{ So } v = -gt - u \ln\left(\frac{m_0 - |b|t}{m_0}\right) = \frac{dy}{dt} \Rightarrow y = \int \left[-gt - u \ln\left(\frac{m_0 - |b|t}{m_0}\right)\right] dt \text{ and } u = c, y = 0 \text{ at}$$

$$t = 0 \Rightarrow y = -\frac{1}{2}gt^2 + c \left[t + \left(\frac{m_0 - |b|t}{|b|}\right) \ln\left(\frac{m_0 - |b|t}{m_0}\right) \right]$$

5. (a) Let y be any function such that $v(x)y = \int v(x)Q(x) dx + C$, $v(x) = e^{\int P(x) dx}$. Then

$$\frac{d}{dx}(v(x) \cdot y) = v(x) \cdot y' + y \cdot v'(x) = v(x)Q(x). \text{ We have } v(x) = e^{\int P(x) dx} \Rightarrow v'(x) = P(x)v(x) = v(x)P(x).$$

Thus $v(x) \cdot y' + y \cdot v(x)P(x) = v(x)Q(x) \Rightarrow y' + yP(x) = Q(x) \Rightarrow$ the given y is a solution.

- (b) If v and Q are continuous on $[a, b]$ and $x \in (a, b)$, then $\frac{d}{dx} \left[\int_{x_0}^x v(t)Q(t) dt \right] = v(x)Q(x)$

$$\Rightarrow \int_{x_0}^x v(t)Q(t) dt = \int v(x)Q(x) dx. \text{ So } C = y_0v(x_0) - \int v(x)Q(x) dx. \text{ From part (a), } v(x)y = \int v(x)Q(x) dx + C.$$

Substituting for C : $v(x)y = \int v(x)Q(x) dx + y_0v(x_0) - \int v(x)Q(x) dx \Rightarrow v(x)y = y_0v(x_0)$ when $x = x_0$.

6. (a) $y' + P(x)y = 0$, $y(x_0) = 0$. Use $v(x) = e^{\int P(x) dx}$ as an integrating factor. Then $\frac{d}{dx}(v(x)y) = 0 \Rightarrow v(x)y = C$

$$\Rightarrow y = Ce^{-\int P(x) dx} \text{ and } y_1 = C_1e^{-\int P(x) dx}, y_2 = C_2e^{-\int P(x) dx}, y_1(x_0) = y_2(x_0) = 0, y_1 - y_2 = (C_1 - C_2)e^{-\int P(x) dx} \\ = C_3e^{-\int P(x) dx} \text{ and } y_1 - y_2 = 0 - 0 = 0. \text{ So } y_1 - y_2 \text{ is a solution to } y' + P(x)y = 0 \text{ with } y(x_0) = 0.$$

- (b) $\frac{d}{dx}(v(x)[y_1(x) - y_2(x)]) = \frac{d}{dx} \left(e^{\int P(x) dx} \left[e^{-\int P(x) dx} (C_1 - C_2) \right] \right) = \frac{d}{dx}(C_1 - C_2) = \frac{d}{dx}(C_3) = 0$.

$$\int \frac{d}{dx}(v(x)[y_1(x) - y_2(x)]) dx = (v(x)[y_1(x) - y_2(x)]) = \int 0 dx = C$$

- (c) $y_1 = C_1e^{-\int P(x) dx}$, $y_2 = C_2e^{-\int P(x) dx}$, $y = y_1 - y_2$. So $y(x_0) = 0 \Rightarrow C_1e^{-\int P(x) dx} - C_2e^{-\int P(x) dx} = 0$

$$\Rightarrow C_1 - C_2 = 0 \Rightarrow C_1 = C_2 \Rightarrow y_1(x) = y_2(x) \text{ for } a < x < b.$$

CHAPTER 10 CONIC SECTIONS AND POLAR COORDINATES

10.1 CONIC SECTIONS AND QUADRATIC EQUATIONS

- $x = \frac{y^2}{8} \Rightarrow 4p = 8 \Rightarrow p = 2$; focus is $(2, 0)$, directrix is $x = -2$
- $x = -\frac{y^2}{4} \Rightarrow 4p = 4 \Rightarrow p = 1$; focus is $(-1, 0)$, directrix is $x = 1$
- $y = -\frac{x^2}{6} \Rightarrow 4p = 6 \Rightarrow p = \frac{3}{2}$; focus is $(0, -\frac{3}{2})$, directrix is $y = \frac{3}{2}$
- $y = \frac{x^2}{2} \Rightarrow 4p = 2 \Rightarrow p = \frac{1}{2}$; focus is $(0, \frac{1}{2})$, directrix is $y = -\frac{1}{2}$
- $\frac{x^2}{4} - \frac{y^2}{9} = 1 \Rightarrow c = \sqrt{4+9} = \sqrt{13} \Rightarrow$ foci are $(\pm\sqrt{13}, 0)$; vertices are $(\pm 2, 0)$; asymptotes are $y = \pm \frac{3}{2}x$
- $\frac{x^2}{4} + \frac{y^2}{9} = 1 \Rightarrow c = \sqrt{9-4} = \sqrt{5} \Rightarrow$ foci are $(0, \pm\sqrt{5})$; vertices are $(0, \pm 3)$
- $\frac{x^2}{2} + y^2 = 1 \Rightarrow c = \sqrt{2-1} = 1 \Rightarrow$ foci are $(\pm 1, 0)$; vertices are $(\pm\sqrt{2}, 0)$
- $\frac{y^2}{4} - x^2 = 1 \Rightarrow c = \sqrt{4+1} = \sqrt{5} \Rightarrow$ foci are $(0, \pm\sqrt{5})$; vertices are $(0, \pm 2)$; asymptotes are $y = \pm 2x$
- $y^2 = 12x \Rightarrow x = \frac{y^2}{12} \Rightarrow 4p = 12 \Rightarrow p = 3$;
focus is $(3, 0)$, directrix is $x = -3$
- $x^2 = 6y \Rightarrow y = \frac{x^2}{6} \Rightarrow 4p = 6 \Rightarrow p = \frac{3}{2}$;
focus is $(0, \frac{3}{2})$, directrix is $y = -\frac{3}{2}$

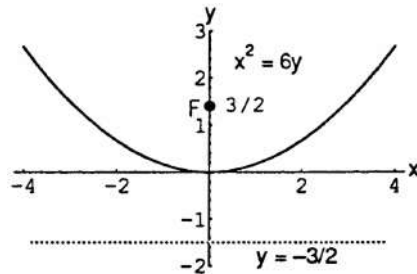
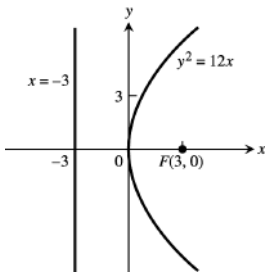

- $x^2 = -8y \Rightarrow y = \frac{x^2}{-8} \Rightarrow 4p = 8 \Rightarrow p = 2$;
focus is $(0, -2)$, directrix is $y = 2$
- $y^2 = -2x \Rightarrow x = \frac{y^2}{-2} \Rightarrow 4p = 2 \Rightarrow p = \frac{1}{2}$;
focus is $(-\frac{1}{2}, 0)$, directrix is $x = \frac{1}{2}$

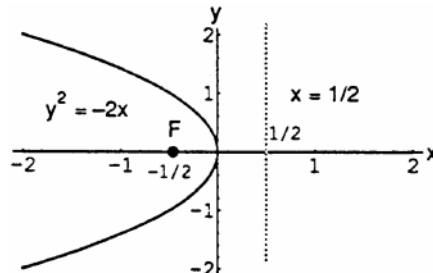
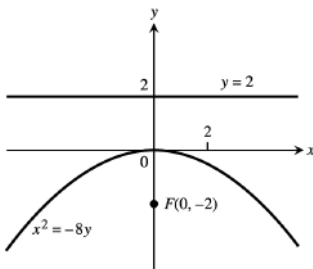

13. $y = 4x^2 \Rightarrow y = \frac{x^2}{(\frac{1}{4})} \Rightarrow 4p = \frac{1}{4} \Rightarrow p = \frac{1}{16}$;
 focus is $(0, \frac{1}{16})$, directrix is $y = -\frac{1}{16}$

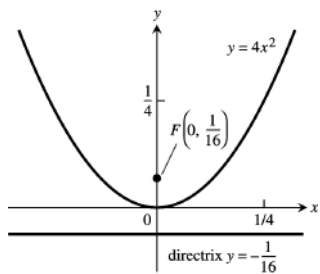

14. $y = -8x^2 \Rightarrow y = -\frac{x^2}{(\frac{1}{8})} \Rightarrow 4p = \frac{1}{8} \Rightarrow p = \frac{1}{32}$;
 focus is $(0, -\frac{1}{32})$, directrix is $y = \frac{1}{32}$

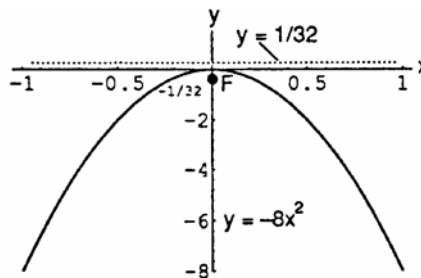

15. $x = -3y^2 \Rightarrow x = -\frac{y^2}{(\frac{1}{3})} \Rightarrow 4p = \frac{1}{3} \Rightarrow p = \frac{1}{12}$;
 focus is $(-\frac{1}{12}, 0)$, directrix is $x = \frac{1}{12}$

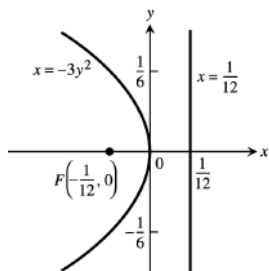

16. $x = 2y^2 \Rightarrow x = \frac{y^2}{(\frac{1}{2})} \Rightarrow 4p = \frac{1}{2} \Rightarrow p = \frac{1}{8}$;
 focus is $(\frac{1}{8}, 0)$, directrix is $x = -\frac{1}{8}$

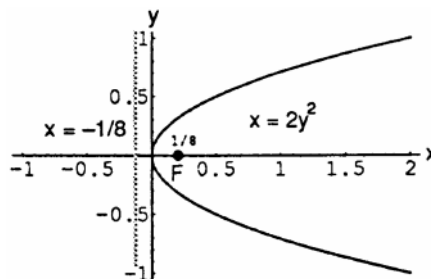

17. $16x^2 + 25y^2 = 400 \Rightarrow \frac{x^2}{25} + \frac{y^2}{16} = 1$
 $\Rightarrow c = \sqrt{a^2 - b^2} = \sqrt{25 - 16} = 3$

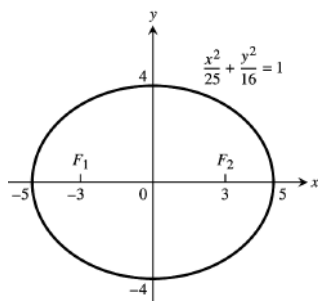

18. $7x^2 + 16y^2 = 112 \Rightarrow \frac{x^2}{16} + \frac{y^2}{7} = 1$
 $\Rightarrow c = \sqrt{a^2 - b^2} = \sqrt{16 - 7} = 3$

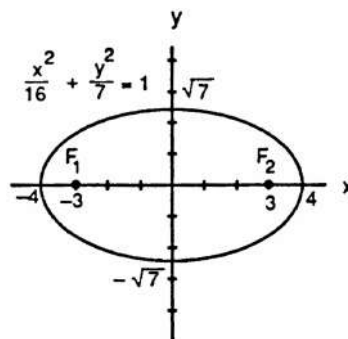

19. $2x^2 + y^2 = 2 \Rightarrow x^2 + \frac{y^2}{2} = 1$
 $\Rightarrow c = \sqrt{a^2 - b^2} = \sqrt{2 - 1} = 1$

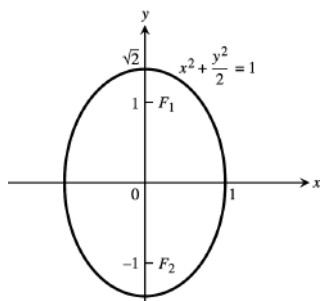

20. $2x^2 + y^2 = 4 \Rightarrow \frac{x^2}{2} + \frac{y^2}{4} = 1$
 $\Rightarrow c = \sqrt{a^2 - b^2} = \sqrt{4 - 2} = \sqrt{2}$

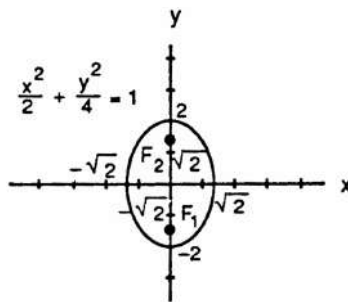

21. $3x^2 + 2y^2 = 6 \Rightarrow \frac{x^2}{2} + \frac{y^2}{3} = 1$
 $\Rightarrow c = \sqrt{a^2 - b^2} = \sqrt{3 - 2} = 1$

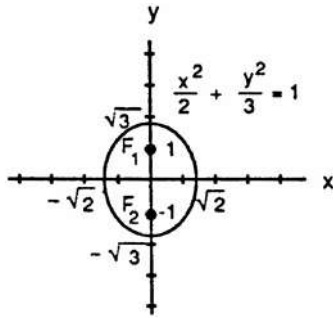

22. $9x^2 + 10y^2 = 90 \Rightarrow \frac{x^2}{10} + \frac{y^2}{9} = 1$
 $\Rightarrow c = \sqrt{a^2 - b^2} = \sqrt{10 - 9} = 1$

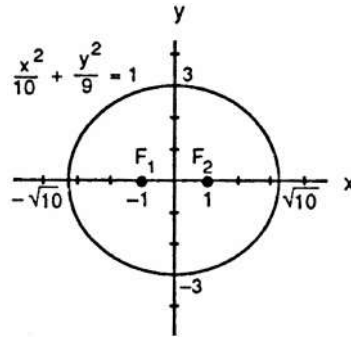

23. $6x^2 + 9y^2 = 54 \Rightarrow \frac{x^2}{9} + \frac{y^2}{6} = 1$
 $\Rightarrow c = \sqrt{a^2 - b^2} = \sqrt{9 - 6} = \sqrt{3}$

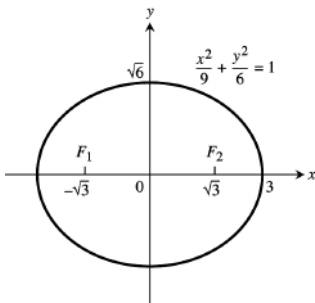

24. $169x^2 + 25y^2 = 4225 \Rightarrow \frac{x^2}{25} + \frac{y^2}{169} = 1$
 $\Rightarrow c = \sqrt{a^2 - b^2} = \sqrt{169 - 25} = 12$

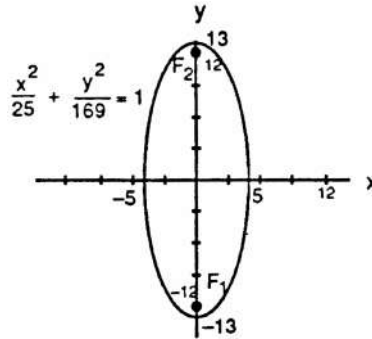

25. Foci: $(\pm\sqrt{2}, 0)$, Vertices: $(\pm 2, 0) \Rightarrow a = 2, c = \sqrt{2} \Rightarrow b^2 = a^2 - c^2 = 4 - (\sqrt{2})^2 = 2 \Rightarrow \frac{x^2}{4} + \frac{y^2}{2} = 1$

26. Foci: $(0, \pm 4)$, Vertices: $(0, \pm 5) \Rightarrow a = 5, c = 4 \Rightarrow b^2 = 25 - 16 = 9 \Rightarrow \frac{x^2}{9} + \frac{y^2}{25} = 1$

27. $x^2 - y^2 = 1 \Rightarrow c = \sqrt{a^2 + b^2} = \sqrt{1 + 1} = \sqrt{2}$;
 asymptotes are $y = \pm x$

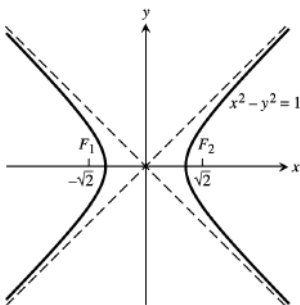

28. $9x^2 - 16y^2 = 144 \Rightarrow \frac{x^2}{16} - \frac{y^2}{9} = 1$
 $\Rightarrow c = \sqrt{a^2 + b^2} = \sqrt{16 + 9} = 5$;
 asymptotes are $y = \pm \frac{3}{4}x$

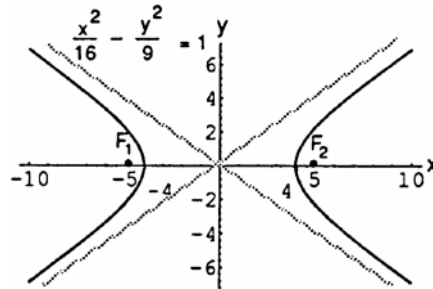

29. $y^2 - x^2 = 8 \Rightarrow \frac{y^2}{8} - \frac{x^2}{8} = 1 \Rightarrow c = \sqrt{a^2 + b^2}$
 $= \sqrt{8 + 8} = 4$; asymptotes are $y = \pm x$

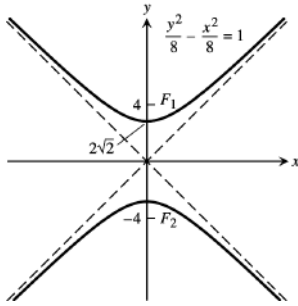

30. $y^2 - x^2 = 4 \Rightarrow \frac{y^2}{4} - \frac{x^2}{4} = 1 \Rightarrow c = \sqrt{a^2 + b^2}$
 $= \sqrt{4 + 4} = 2\sqrt{2}$; asymptotes are $y = \pm x$

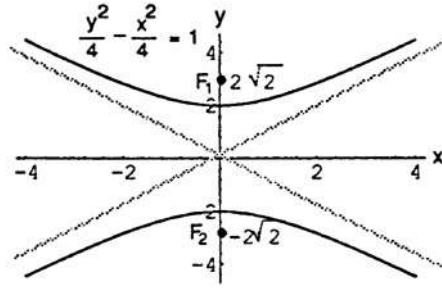

31. $8x^2 - 2y^2 = 16 \Rightarrow \frac{x^2}{2} - \frac{y^2}{8} = 1 \Rightarrow c = \sqrt{a^2 + b^2}$
 $= \sqrt{2 + 8} = \sqrt{10}$; asymptotes are $y = \pm 2x$

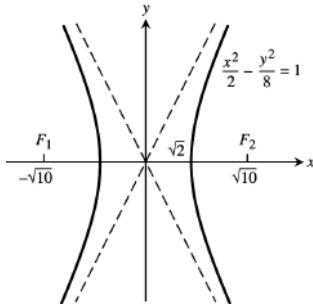

32. $y^2 - 3x^2 = 3 \Rightarrow \frac{y^2}{3} - x^2 = 1 \Rightarrow c = \sqrt{a^2 + b^2}$
 $= \sqrt{3 + 1} = 2$; asymptotes are $y = \pm \sqrt{3}x$

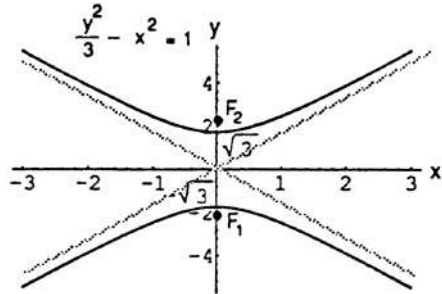

33. $8y^2 - 2x^2 = 16 \Rightarrow \frac{y^2}{2} - \frac{x^2}{8} = 1 \Rightarrow c = \sqrt{a^2 + b^2}$
 $= \sqrt{2 + 8} = \sqrt{10}$; asymptotes are $y = \pm \frac{x}{2}$

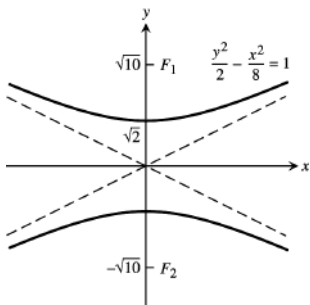

34. $64x^2 - 36y^2 = 2304 \Rightarrow \frac{x^2}{36} - \frac{y^2}{64} = 1 \Rightarrow c = \sqrt{a^2 + b^2}$
 $= \sqrt{36 + 64} = 10$; asymptotes are $y = \pm \frac{4}{3}x$

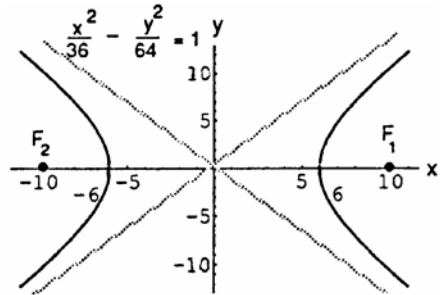

35. Foci: $(0, \pm \sqrt{2})$, Asymptotes: $y = \pm x \Rightarrow c = \sqrt{2}$ and $\frac{a}{b} = 1 \Rightarrow a = b \Rightarrow c^2 = a^2 + b^2 = 2a^2 \Rightarrow 2 = 2a^2$
 $\Rightarrow a = 1 \Rightarrow b = 1 \Rightarrow y^2 - x^2 = 1$

36. Foci: $(\pm 2, 0)$, Asymptotes: $y = \pm \frac{1}{\sqrt{3}}x \Rightarrow c = 2$ and $\frac{b}{a} = \frac{1}{\sqrt{3}} \Rightarrow b = \frac{a}{\sqrt{3}} \Rightarrow c^2 = a^2 + b^2 = a^2 + \frac{a^2}{3} = \frac{4a^2}{3}$
 $\Rightarrow 4 = \frac{4a^2}{3} \Rightarrow a^2 = 3 \Rightarrow a = \sqrt{3} \Rightarrow b = 1 \Rightarrow \frac{x^2}{3} - y^2 = 1$

37. Vertices: $(\pm 3, 0)$, Asymptotes: $y = \pm \frac{4}{3}x \Rightarrow a = 3$ and $\frac{b}{a} = \frac{4}{3} \Rightarrow b = \frac{4}{3}(3) = 4 \Rightarrow \frac{x^2}{9} - \frac{y^2}{16} = 1$

38. Vertices: $(0, \pm 2)$, Asymptotes: $y = \pm \frac{1}{2}x \Rightarrow a = 2$ and $\frac{a}{b} = \frac{1}{2} \Rightarrow b = 2(2) = 4 \Rightarrow \frac{y^2}{4} - \frac{x^2}{16} = 1$

39. (a) $y^2 = 8x \Rightarrow 4p = 8 \Rightarrow p = 2 \Rightarrow$ directrix is $x = -2$, focus is $(2, 0)$, and vertex is $(0, 0)$; therefore the new directrix is $x = -1$, the new focus is $(3, -2)$, and the new vertex is $(1, -2)$

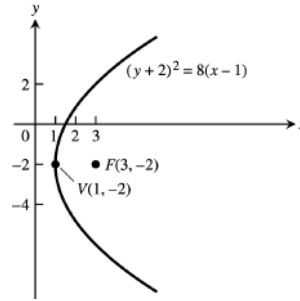

40. (a) $x^2 = -4y \Rightarrow 4p = 4 \Rightarrow p = 1 \Rightarrow$ directrix is $y = 1$, focus is $(0, -1)$, and vertex is $(0, 0)$; therefore the new directrix is $y = 4$, the new focus is $(-1, 2)$, and the new vertex is $(-1, 3)$

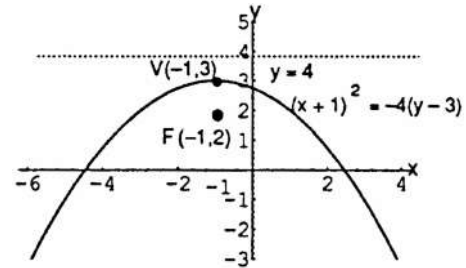

41. (a) $\frac{x^2}{16} + \frac{y^2}{9} = 1 \Rightarrow$ center is $(0, 0)$, vertices are $(-4, 0)$ and $(4, 0)$; $c = \sqrt{a^2 - b^2} = \sqrt{7} \Rightarrow$ foci are $(\sqrt{7}, 0)$ and $(-\sqrt{7}, 0)$; therefore the new center is $(4, 3)$, the new vertices are $(0, 3)$ and $(8, 3)$, and the new foci are $(4 \pm \sqrt{7}, 3)$

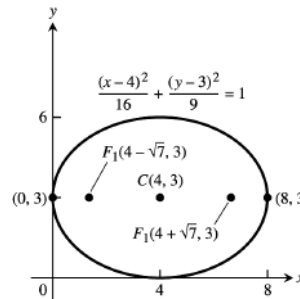

42. (a) $\frac{x^2}{9} + \frac{y^2}{25} = 1 \Rightarrow$ center is $(0, 0)$, vertices are $(0, 5)$ and $(0, -5)$; $c = \sqrt{a^2 - b^2} = \sqrt{16} = 4 \Rightarrow$ foci are $(0, 4)$ and $(0, -4)$; therefore the new center is $(-3, -2)$, the new vertices are $(-3, 3)$ and $(-3, -7)$, and the new foci are $(-3, 2)$ and $(-3, -6)$

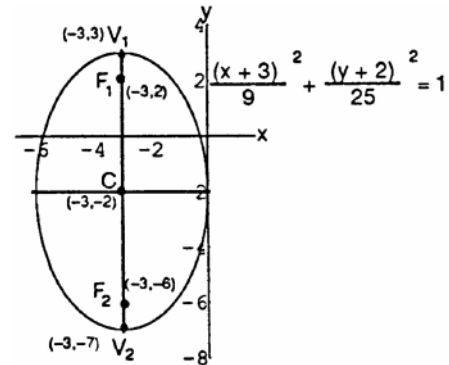

43. (a) $\frac{x^2}{16} - \frac{y^2}{9} = 1 \Rightarrow$ center is $(0, 0)$, vertices are $(-4, 0)$ and $(4, 0)$, and the asymptotes are $\frac{x}{4} = \pm \frac{y}{3}$ or $y = \pm \frac{3x}{4}$; $c = \sqrt{a^2 + b^2} = \sqrt{25} = 5 \Rightarrow$ foci are $(-5, 0)$ and $(5, 0)$; therefore the new center is $(2, 0)$, the new vertices are $(-2, 0)$ and $(6, 0)$, the new foci are $(-3, 0)$ and $(7, 0)$, and the new asymptotes are $y = \pm \frac{3(x-2)}{4}$

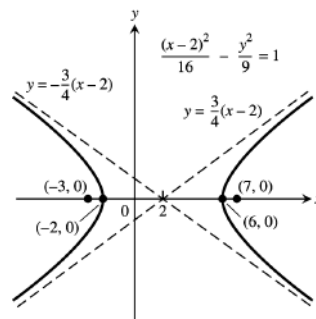

44. (a) $\frac{y^2}{4} - \frac{x^2}{5} = 1 \Rightarrow$ center is $(0, 0)$, vertices are $(0, -2)$ and $(0, 2)$, and the asymptotes are $\frac{y}{2} = \pm \frac{x}{\sqrt{5}}$ or $y = \pm \frac{2x}{\sqrt{5}}$; $c = \sqrt{a^2 + b^2} = \sqrt{9} = 3 \Rightarrow$ foci are $(0, 3)$ and $(0, -3)$; therefore the new center is $(0, -2)$, the new vertices are $(0, -4)$ and $(0, 0)$, the new foci are $(0, 1)$ and $(0, -5)$, and the new asymptotes are $y + 2 = \pm \frac{2x}{\sqrt{5}}$

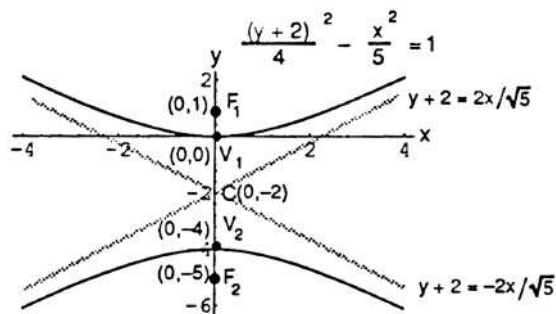

45. $y^2 = 4x \Rightarrow 4p = 4 \Rightarrow p = 1 \Rightarrow$ focus is $(1, 0)$, directrix is $x = -1$, and vertex is $(0, 0)$; therefore the new vertex is $(-2, -3)$, the new focus is $(-1, -3)$, and the new directrix is $x = -3$; the new equation is $(y + 3)^2 = 4(x + 2)$
46. $y^2 = -12x \Rightarrow 4p = 12 \Rightarrow p = 3 \Rightarrow$ focus is $(-3, 0)$, directrix is $x = 3$, and vertex is $(0, 0)$; therefore the new vertex is $(4, 3)$, the new focus is $(1, 3)$, and the new directrix is $x = 7$; the new equation is $(y - 3)^2 = -12(x - 4)$
47. $x^2 = 8y \Rightarrow 4p = 8 \Rightarrow p = 2 \Rightarrow$ focus is $(0, 2)$, directrix is $y = -2$, and vertex is $(0, 0)$; therefore the new vertex is $(1, -7)$, the new focus is $(1, -5)$, and the new directrix is $y = -9$; the new equation is $(x - 1)^2 = 8(y + 7)$
48. $x^2 = 6y \Rightarrow 4p = 6 \Rightarrow p = \frac{3}{2} \Rightarrow$ focus is $(0, \frac{3}{2})$, directrix is $y = -\frac{3}{2}$, and vertex is $(0, 0)$; therefore the new vertex is $(-3, -2)$, the new focus is $(-3, -\frac{1}{2})$, and the new directrix is $y = -\frac{7}{2}$; the new equation is $(x + 3)^2 = 6(y + 2)$
49. $\frac{x^2}{6} + \frac{y^2}{9} = 1 \Rightarrow$ center is $(0, 0)$, vertices are $(0, 3)$ and $(0, -3)$; $c = \sqrt{a^2 - b^2} = \sqrt{9 - 6} = \sqrt{3} \Rightarrow$ foci are $(0, \sqrt{3})$ and $(0, -\sqrt{3})$; therefore the new center is $(-2, -1)$, the new vertices are $(-2, 2)$ and $(-2, -4)$, and the new foci are $(-2, -1 \pm \sqrt{3})$; the new equation is $\frac{(x+2)^2}{6} + \frac{(y+1)^2}{9} = 1$
50. $\frac{x^2}{2} + y^2 = 1 \Rightarrow$ center is $(0, 0)$, vertices are $(\sqrt{2}, 0)$ and $(-\sqrt{2}, 0)$; $c = \sqrt{a^2 - b^2} = \sqrt{2 - 1} = 1 \Rightarrow$ foci are $(-1, 0)$ and $(1, 0)$; therefore the new center is $(3, 4)$, the new vertices are $(3 \pm \sqrt{2}, 4)$, and the new foci are $(2, 4)$ and $(4, 4)$; the new equation is $\frac{(x-3)^2}{2} + (y - 4)^2 = 1$
51. $\frac{x^2}{3} + \frac{y^2}{2} = 1 \Rightarrow$ center is $(0, 0)$, vertices are $(\sqrt{3}, 0)$ and $(-\sqrt{3}, 0)$; $c = \sqrt{a^2 - b^2} = \sqrt{3 - 2} = 1 \Rightarrow$ foci are $(-1, 0)$ and $(1, 0)$; therefore the new center is $(2, 3)$, the new vertices are $(2 \pm \sqrt{3}, 3)$, and the new foci are $(1, 3)$ and $(3, 3)$; the new equation is $\frac{(x-2)^2}{3} + \frac{(y-3)^2}{2} = 1$
52. $\frac{x^2}{16} + \frac{y^2}{25} = 1 \Rightarrow$ center is $(0, 0)$, vertices are $(0, 5)$ and $(0, -5)$; $c = \sqrt{a^2 - b^2} = \sqrt{25 - 16} = 3 \Rightarrow$ foci are $(0, 3)$ and $(0, -3)$; therefore the new center is $(-4, -5)$, the new vertices are $(-4, 0)$ and $(-4, -10)$, and the new foci are $(-4, -2)$ and $(-4, -8)$; the new equation is $\frac{(x+4)^2}{16} + \frac{(y+5)^2}{25} = 1$
53. $\frac{x^2}{4} - \frac{y^2}{5} = 1 \Rightarrow$ center is $(0, 0)$, vertices are $(2, 0)$ and $(-2, 0)$; $c = \sqrt{a^2 + b^2} = \sqrt{4 + 5} = 3 \Rightarrow$ foci are $(3, 0)$ and $(-3, 0)$; the asymptotes are $\pm \frac{x}{2} = \frac{y}{\sqrt{5}} \Rightarrow y = \pm \frac{\sqrt{5}x}{2}$; therefore the new center is $(2, 2)$, the new vertices are $(4, 2)$ and $(0, 2)$, and the new foci are $(5, 2)$ and $(-1, 2)$; the new asymptotes are $y - 2 = \pm \frac{\sqrt{5}(x-2)}{2}$; the new

equation is $\frac{(x-2)^2}{4} - \frac{(y-2)^2}{5} = 1$

54. $\frac{x^2}{16} - \frac{y^2}{9} = 1 \Rightarrow$ center is $(0, 0)$, vertices are $(4, 0)$ and $(-4, 0)$; $c = \sqrt{a^2 + b^2} = \sqrt{16 + 9} = 5 \Rightarrow$ foci are $(-5, 0)$ and $(5, 0)$; the asymptotes are $\pm \frac{x}{4} = \frac{y}{3} \Rightarrow y = \pm \frac{3x}{4}$; therefore the new center is $(-5, -1)$, the new vertices are $(-1, -1)$ and $(-9, -1)$, and the new foci are $(-10, -1)$ and $(0, -1)$; the new asymptotes are $y + 1 = \pm \frac{3(x+5)}{4}$; the new equation is $\frac{(x+5)^2}{16} - \frac{(y+1)^2}{9} = 1$
55. $y^2 - x^2 = 1 \Rightarrow$ center is $(0, 0)$, vertices are $(0, 1)$ and $(0, -1)$; $c = \sqrt{a^2 + b^2} = \sqrt{1 + 1} = \sqrt{2} \Rightarrow$ foci are $(0, \pm \sqrt{2})$; the asymptotes are $y = \pm x$; therefore the new center is $(-1, -1)$, the new vertices are $(-1, 0)$ and $(-1, -2)$, and the new foci are $(-1, -1 \pm \sqrt{2})$; the new asymptotes are $y + 1 = \pm (x + 1)$; the new equation is $(y + 1)^2 - (x + 1)^2 = 1$
56. $\frac{y^2}{3} - x^2 = 1 \Rightarrow$ center is $(0, 0)$, vertices are $(0, \sqrt{3})$ and $(0, -\sqrt{3})$; $c = \sqrt{a^2 + b^2} = \sqrt{3 + 1} = 2 \Rightarrow$ foci are $(0, 2)$ and $(0, -2)$; the asymptotes are $\pm x = \frac{y}{\sqrt{3}} \Rightarrow y = \pm \sqrt{3}x$; therefore the new center is $(1, 3)$, the new vertices are $(1, 3 \pm \sqrt{3})$, and the new foci are $(1, 5)$ and $(1, 1)$; the new asymptotes are $y - 3 = \pm \sqrt{3}(x - 1)$; the new equation is $\frac{(y-3)^2}{3} - (x - 1)^2 = 1$
57. $x^2 + 4x + y^2 = 12 \Rightarrow x^2 + 4x + 4 + y^2 = 12 + 4 \Rightarrow (x + 2)^2 + y^2 = 16$; this is a circle: center at $C(-2, 0)$, $a = 4$
58. $2x^2 + 2y^2 - 28x + 12y + 114 = 0 \Rightarrow x^2 - 14x + 49 + y^2 + 6y + 9 = -57 + 49 + 9 \Rightarrow (x - 7)^2 + (y + 3)^2 = 1$; this is a circle: center at $C(7, -3)$, $a = 1$
59. $x^2 + 2x + 4y - 3 = 0 \Rightarrow x^2 + 2x + 1 = -4y + 3 + 1 \Rightarrow (x + 1)^2 = -4(y - 1)$; this is a parabola: $V(-1, 1)$, $F(-1, 0)$
60. $y^2 - 4y - 8x - 12 = 0 \Rightarrow y^2 - 4y + 4 = 8x + 12 + 4 \Rightarrow (y - 2)^2 = 8(x + 2)$; this is a parabola: $V(-2, 2)$, $F(0, 2)$
61. $x^2 + 5y^2 + 4x = 1 \Rightarrow x^2 + 4x + 4 + 5y^2 = 5 \Rightarrow (x + 2)^2 + 5y^2 = 5 \Rightarrow \frac{(x+2)^2}{5} + y^2 = 1$; this is an ellipse: the center is $(-2, 0)$, the vertices are $(-2 \pm \sqrt{5}, 0)$; $c = \sqrt{a^2 - b^2} = \sqrt{5 - 1} = 2 \Rightarrow$ the foci are $(-4, 0)$ and $(0, 0)$
62. $9x^2 + 6y^2 + 36y = 0 \Rightarrow 9x^2 + 6(y^2 + 6y + 9) = 54 \Rightarrow 9x^2 + 6(y + 3)^2 = 54 \Rightarrow \frac{x^2}{6} + \frac{(y+3)^2}{9} = 1$; this is an ellipse: the center is $(0, -3)$, the vertices are $(0, 0)$ and $(0, -6)$; $c = \sqrt{a^2 - b^2} = \sqrt{9 - 6} = \sqrt{3} \Rightarrow$ the foci are $(0, -3 \pm \sqrt{3})$
63. $x^2 + 2y^2 - 2x - 4y = -1 \Rightarrow x^2 - 2x + 1 + 2(y^2 - 2y + 1) = 2 \Rightarrow (x - 1)^2 + 2(y - 1)^2 = 2 \Rightarrow \frac{(x-1)^2}{2} + (y - 1)^2 = 1$; this is an ellipse: the center is $(1, 1)$, the vertices are $(1 \pm \sqrt{2}, 1)$; $c = \sqrt{a^2 - b^2} = \sqrt{2 - 1} = 1 \Rightarrow$ the foci are $(2, 1)$ and $(0, 1)$
64. $4x^2 + y^2 + 8x - 2y = -1 \Rightarrow 4(x^2 + 2x + 1) + y^2 - 2y + 1 = 4 \Rightarrow 4(x + 1)^2 + (y - 1)^2 = 4 \Rightarrow (x + 1)^2 + \frac{(y-1)^2}{4} = 1$; this is an ellipse: the center is $(-1, 1)$, the vertices are $(-1, 3)$ and

$(-1, -1)$; $c = \sqrt{a^2 - b^2} = \sqrt{4 - 1} = \sqrt{3} \Rightarrow$ the foci are $(-1, 1 \pm \sqrt{3})$

65. $x^2 - y^2 - 2x + 4y = 4 \Rightarrow x^2 - 2x + 1 - (y^2 - 4y + 4) = 1 \Rightarrow (x - 1)^2 - (y - 2)^2 = 1$; this is a hyperbola: the center is $(1, 2)$, the vertices are $(2, 2)$ and $(0, 2)$; $c = \sqrt{a^2 + b^2} = \sqrt{1 + 1} = \sqrt{2} \Rightarrow$ the foci are $(1 \pm \sqrt{2}, 2)$; the asymptotes are $y - 2 = \pm(x - 1)$

66. $x^2 - y^2 + 4x - 6y = 6 \Rightarrow x^2 + 4x + 4 - (y^2 + 6y + 9) = 1 \Rightarrow (x + 2)^2 - (y + 3)^2 = 1$; this is a hyperbola: the center is $(-2, -3)$, the vertices are $(-1, -3)$ and $(-3, -3)$; $c = \sqrt{a^2 + b^2} = \sqrt{1 + 1} = \sqrt{2} \Rightarrow$ the foci are $(-2 \pm \sqrt{2}, -3)$; the asymptotes are $y + 3 = \pm(x + 2)$

67. $2x^2 - y^2 + 6y = 3 \Rightarrow 2x^2 - (y^2 - 6y + 9) = -6 \Rightarrow \frac{(y-3)^2}{6} - \frac{x^2}{3} = 1$; this is a hyperbola: the center is $(0, 3)$, the vertices are $(0, 3 \pm \sqrt{6})$; $c = \sqrt{a^2 + b^2} = \sqrt{6 + 3} = 3 \Rightarrow$ the foci are $(0, 6)$ and $(0, 0)$; the asymptotes are $\frac{y-3}{\sqrt{6}} = \pm \frac{x}{\sqrt{3}} \Rightarrow y = \pm \sqrt{2}x + 3$

68. $y^2 - 4x^2 + 16x = 24 \Rightarrow y^2 - 4(x^2 - 4x + 4) = 8 \Rightarrow \frac{y^2}{8} - \frac{(x-2)^2}{2} = 1$; this is a hyperbola: the center is $(2, 0)$, the vertices are $(2, \pm \sqrt{8})$; $c = \sqrt{a^2 + b^2} = \sqrt{8 + 2} = \sqrt{10} \Rightarrow$ the foci are $(2, \pm \sqrt{10})$; the asymptotes are $\frac{y}{\sqrt{8}} = \pm \frac{x-2}{\sqrt{2}} \Rightarrow y = \pm 2(x - 2)$

69.

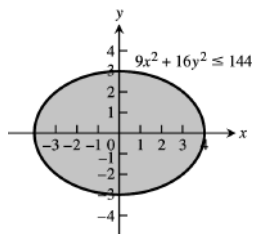

70.

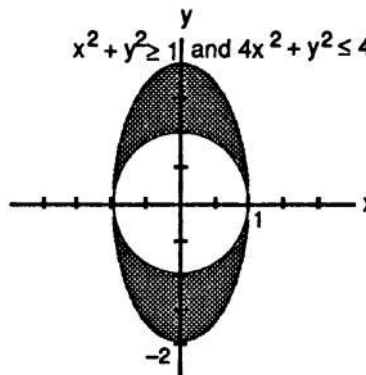

71.

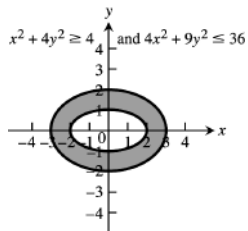

72.

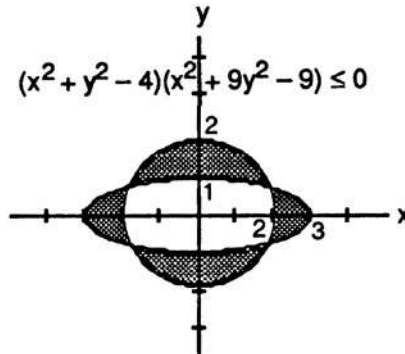

73.

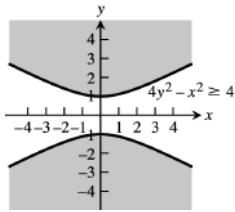

$$74. |x^2 - y^2| \leq 1 \Rightarrow -1 \leq x^2 - y^2 \leq 1 \Rightarrow -1 \leq x^2 - y^2 \text{ and } x^2 - y^2 \leq 1 \Rightarrow 1 \geq y^2 - x^2 \text{ and } x^2 - y^2 \leq 1$$

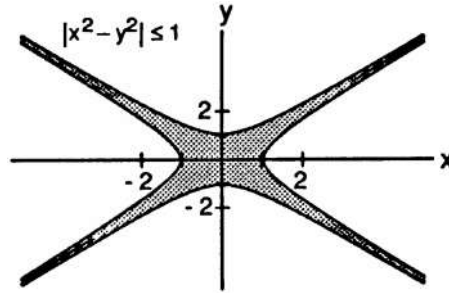

$$75. \text{ Volume of the Parabolic Solid: } V_1 = \int_0^{b/2} 2\pi x \left(h - \frac{4h}{b^2} x^2 \right) dx = 2\pi h \int_0^{b/2} \left(x - \frac{4x^3}{b^2} \right) dx = 2\pi h \left[\frac{x^2}{2} - \frac{x^4}{b^2} \right]_0^{b/2} \\ = \frac{\pi h b^2}{8}; \text{ Volume of the Cone: } V_2 = \frac{1}{3} \pi \left(\frac{b}{2} \right)^2 h = \frac{1}{3} \pi \left(\frac{b^2}{4} \right) h = \frac{\pi h b^2}{12}; \text{ therefore } V_1 = \frac{3}{2} V_2$$

$$76. y = \int \frac{w}{H} x dx = \frac{w}{H} \left(\frac{x^2}{2} \right) + C = \frac{wx^2}{2H} + C; y = 0 \text{ when } x = 0 \Rightarrow 0 = \frac{w(0)^2}{2H} + C \Rightarrow C = 0; \text{ therefore } y = \frac{wx^2}{2H} \text{ is the equation of the cable's curve}$$

77. A general equation of the circle is $x^2 + y^2 + ax + by + c = 0$, so we will substitute the three given points into

$$\text{this equation and solve the resulting system: } \left. \begin{array}{l} a + c = -1 \\ b + c = -1 \\ 2a + 2b + c = -8 \end{array} \right\} \Rightarrow c = \frac{4}{3} \text{ and } a = b = -\frac{7}{3}; \text{ therefore}$$

$$3x^2 + 3y^2 - 7x - 7y + 4 = 0 \text{ represents the circle}$$

78. A general equation of the circle is $x^2 + y^2 + ax + by + c = 0$, so we will substitute each of the three given points

$$\text{into this equation and solve the resulting system: } \left. \begin{array}{l} 2a + 3b + c = -13 \\ 3a + 2b + c = -13 \\ -4a + 3b + c = -25 \end{array} \right\} \Rightarrow a = 2, b = 2, \text{ and } c = -23;$$

$$\text{therefore } x^2 + y^2 + 2x + 2y - 23 = 0 \text{ represents the circle}$$

$$79. r^2 = (-2 - 1)^2 + (1 - 3)^2 = 13 \Rightarrow (x + 2)^2 + (y - 1)^2 = 13 \text{ is an equation of the circle; the distance from the center to } (1.1, 2.8) \text{ is } \sqrt{(-2 - 1.1)^2 + (1 - 2.8)^2} = \sqrt{12.85} < \sqrt{13}, \text{ the radius } \Rightarrow \text{ the point is inside the circle}$$

$$80. (x - 2)^2 + (y - 1)^2 = 5 \Rightarrow 2(x - 2) + 2(y - 1) \frac{dy}{dx} = 0 \Rightarrow \frac{dy}{dx} = -\frac{x-2}{y-1}; y = 0 \Rightarrow (x - 2)^2 + (0 - 1)^2 = 5$$

$$\Rightarrow (x - 2)^2 = 4 \Rightarrow x = 4 \text{ or } x = 0 \Rightarrow \text{ the circle crosses the } x\text{-axis at } (4, 0) \text{ and } (0, 0); x = 0$$

$$\Rightarrow (0 - 2)^2 + (y - 1)^2 = 5 \Rightarrow (y - 1)^2 = 1 \Rightarrow y = 2 \text{ or } y = 0 \Rightarrow \text{ the circle crosses the } y\text{-axis at } (0, 2) \text{ and } (0, 0).$$

$$\text{At } (4, 0): \frac{dy}{dx} = -\frac{4-2}{0-1} = 2 \Rightarrow \text{ the tangent line is } y = 2(x - 4) \text{ or } y = 2x - 8$$

$$\text{At } (0, 0): \frac{dy}{dx} = -\frac{0-2}{0-1} = -2 \Rightarrow \text{ the tangent line is } y = -2x$$

$$\text{At } (0, 2): \frac{dy}{dx} = -\frac{0-2}{2-1} = 2 \Rightarrow \text{ the tangent line is } y - 2 = 2x \text{ or } y = 2x + 2$$

81. (a) $y^2 = kx \Rightarrow x = \frac{y^2}{k}$; the volume of the solid formed by revolving R_1 about the y -axis is $V_1 = \int_0^{\sqrt{kx}} \pi \left(\frac{y^2}{k}\right)^2 dy = \frac{\pi}{k^2} \int_0^{\sqrt{kx}} y^4 dy = \frac{\pi x^2 \sqrt{kx}}{5}$; the volume of the right circular cylinder formed by revolving PQ about the y -axis is $V_2 = \pi x^2 \sqrt{kx} \Rightarrow$ the volume of the solid formed by revolving R_2 about the y -axis is $V_3 = V_2 - V_1 = \frac{4\pi x^2 \sqrt{kx}}{5}$. Therefore we can see the ratio of V_3 to V_1 is 4:1.

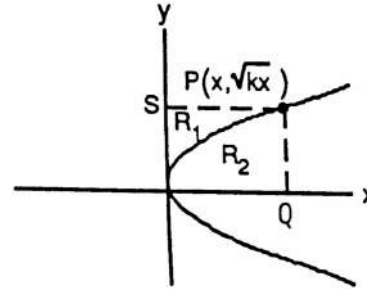

(b) The volume of the solid formed by revolving R_2 about the x -axis is $V_1 = \int_0^x \pi (\sqrt{kt})^2 dt = \pi k \int_0^x t dt = \frac{\pi kx^2}{2}$. The volume of the right circular cylinder formed by revolving PS about the x -axis is $V_2 = \pi (\sqrt{kx})^2 x = \pi kx^2 \Rightarrow$ the volume of the solid formed by revolving R_1 about the x -axis is $V_3 = V_2 - V_1 = \pi kx^2 - \frac{\pi kx^2}{2} = \frac{\pi kx^2}{2}$. Therefore the ratio of V_3 to V_1 is 1:1.

82. Let $P_1(-p, y_1)$ be any point on $x = -p$, and let $P(x, y)$ be a point where a tangent intersects $y^2 = 4px$. Now $y^2 = 4px \Rightarrow 2y \frac{dy}{dx} = 4p \Rightarrow \frac{dy}{dx} = \frac{2p}{y}$; then the slope of a tangent line from P_1 is $\frac{y - y_1}{x - (-p)} = \frac{dy}{dx} = \frac{2p}{y} \Rightarrow y^2 - yy_1 = 2px + 2p^2$. Since $x = \frac{y^2}{4p}$, we have $y^2 - yy_1 = 2p\left(\frac{y^2}{4p}\right) + 2p^2 \Rightarrow y^2 - yy_1 = \frac{1}{2}y^2 + 2p^2 \Rightarrow \frac{1}{2}y^2 - yy_1 - 2p^2 = 0 \Rightarrow y = \frac{2y_1 \pm \sqrt{4y_1^2 + 16p^2}}{2} = y_1 \pm \sqrt{y_1^2 + 4p^2}$. Therefore the slopes of the two tangents from P_1 are $m_1 = \frac{2p}{y_1 + \sqrt{y_1^2 + 4p^2}}$ and $m_2 = \frac{2p}{y_1 - \sqrt{y_1^2 + 4p^2}} \Rightarrow m_1 m_2 = \frac{4p^2}{y_1^2 - (y_1^2 + 4p^2)} = -1 \Rightarrow$ the lines are perpendicular

83. Let $y = \sqrt{1 - \frac{x^2}{4}}$ on the interval $0 \leq x \leq 2$. The area of the inscribed rectangle is given by $A(x) = 2x \left(2\sqrt{1 - \frac{x^2}{4}}\right) = 4x\sqrt{1 - \frac{x^2}{4}}$ (since the length is $2x$ and the height is $2y$) $\Rightarrow A'(x) = 4\sqrt{1 - \frac{x^2}{4}} - \frac{x^2}{\sqrt{1 - \frac{x^2}{4}}}$. Thus $A'(x) = 0 \Rightarrow 4\sqrt{1 - \frac{x^2}{4}} - \frac{x^2}{\sqrt{1 - \frac{x^2}{4}}} = 0 \Rightarrow 4\left(1 - \frac{x^2}{4}\right) - x^2 = 0 \Rightarrow x^2 = 2 \Rightarrow x = \sqrt{2}$ (only the positive square root lies in the interval). Since $A(0) = A(2) = 0$ we have that $A(\sqrt{2}) = 4$ is the maximum area when the length is $2\sqrt{2}$ and the height is $\sqrt{2}$.

84. (a) Around the x -axis: $9x^2 + 4y^2 = 36 \Rightarrow y^2 = 9 - \frac{9}{4}x^2 \Rightarrow y = \pm \sqrt{9 - \frac{9}{4}x^2}$ and we use the positive root $\Rightarrow V = 2 \int_0^2 \pi \left(\sqrt{9 - \frac{9}{4}x^2}\right)^2 dx = 2 \int_0^2 \pi \left(9 - \frac{9}{4}x^2\right) dx = 2\pi \left[9x - \frac{3}{4}x^3\right]_0^2 = 24\pi$

(b) Around the y -axis: $9x^2 + 4y^2 = 36 \Rightarrow x^2 = 4 - \frac{4}{9}y^2 \Rightarrow x = \pm \sqrt{4 - \frac{4}{9}y^2}$ and we use the positive root $\Rightarrow V = 2 \int_0^3 \pi \left(\sqrt{4 - \frac{4}{9}y^2}\right)^2 dy = 2 \int_0^3 \pi \left(4 - \frac{4}{9}y^2\right) dy = 2\pi \left[4y - \frac{4}{27}y^3\right]_0^3 = 16\pi$

85. $9x^2 - 4y^2 = 36 \Rightarrow y^2 = \frac{9x^2 - 36}{4} \Rightarrow y = \pm \frac{3}{2}\sqrt{x^2 - 4}$ on the interval $2 \leq x \leq 4 \Rightarrow V = \int_2^4 \pi \left(\frac{3}{2}\sqrt{x^2 - 4}\right)^2 dx = \frac{9\pi}{4} \int_2^4 (x^2 - 4) dx = \frac{9\pi}{4} \left[\frac{x^3}{3} - 4x\right]_2^4 = \frac{9\pi}{4} \left[\left(\frac{64}{3} - 16\right) - \left(\frac{8}{3} - 8\right)\right] = \frac{9\pi}{4} \left(\frac{56}{3} - 8\right) = \frac{3\pi}{4} (56 - 24) = 24\pi$

86. $x^2 - y^2 = 1 \Rightarrow x = \pm \sqrt{1 + y^2}$ on the interval $-3 \leq y \leq 3 \Rightarrow V = \int_{-3}^3 \pi (\sqrt{1 + y^2})^2 dy = 2 \int_0^3 \pi (\sqrt{1 + y^2})^2 dy = 2\pi \int_0^3 (1 + y^2) dy = 2\pi \left[y + \frac{y^3}{3}\right]_0^3 = 24\pi$

87. Let $y = \sqrt{16 - \frac{16}{9}x^2}$ on the interval $-3 \leq x \leq 3$. Since the plate is symmetric about the y-axis, $\bar{x} = 0$. For a vertical strip: $(\tilde{x}, \tilde{y}) = \left(x, \frac{\sqrt{16 - \frac{16}{9}x^2}}{2}\right)$, length $= \sqrt{16 - \frac{16}{9}x^2}$, width $= dx \Rightarrow$ area $= dA = \sqrt{16 - \frac{16}{9}x^2} dx$
 \Rightarrow mass $= dm = \delta dA = \delta \sqrt{16 - \frac{16}{9}x^2} dx$. Moment of the strip about the x-axis:
 $\tilde{y} dm = \frac{\sqrt{16 - \frac{16}{9}x^2}}{2} \left(\delta \sqrt{16 - \frac{16}{9}x^2}\right) dx = \delta \left(8 - \frac{8}{9}x^2\right) dx$ so the moment of the plate about the x-axis is
 $M_x = \int \tilde{y} dm = \int_{-3}^3 \delta \left(8 - \frac{8}{9}x^2\right) dx = \delta \left[8x - \frac{8}{27}x^3\right]_{-3}^3 = 32\delta$; also the mass of the plate is
 $M = \int_{-3}^3 \delta \sqrt{16 - \frac{16}{9}x^2} dx = \int_{-3}^3 4\delta \sqrt{1 - \left(\frac{1}{3}x\right)^2} dx = 4\delta \int_{-1}^1 3\sqrt{1 - u^2} du$ where $u = \frac{x}{3} \Rightarrow 3 du = dx$; $x = -3$
 $\Rightarrow u = -1$ and $x = 3 \Rightarrow u = 1$. Hence, $4\delta \int_{-1}^1 3\sqrt{1 - u^2} du = 12\delta \int_{-1}^1 \sqrt{1 - u^2} du$
 $= 12\delta \left[\frac{1}{2} \left(u\sqrt{1 - u^2} + \sin^{-1} u\right)\right]_{-1}^1 = 6\pi\delta \Rightarrow \bar{y} = \frac{M_x}{M} = \frac{32\delta}{6\pi\delta} = \frac{16}{3\pi}$. Therefore the center of mass is $\left(0, \frac{16}{3\pi}\right)$.

88. $y = \sqrt{x^2 + 1} \Rightarrow \frac{dy}{dx} = \frac{1}{2}(x^2 + 1)^{-1/2}(2x) = \frac{x}{\sqrt{x^2 + 1}} \Rightarrow \left(\frac{dy}{dx}\right)^2 = \frac{x^2}{x^2 + 1} \Rightarrow \sqrt{1 + \left(\frac{dy}{dx}\right)^2} = \sqrt{1 + \frac{x^2}{x^2 + 1}}$
 $= \sqrt{\frac{2x^2 + 1}{x^2 + 1}} \Rightarrow S = \int_0^{\sqrt{2}} 2\pi y \sqrt{1 + \left(\frac{dy}{dx}\right)^2} dx = \int_0^{\sqrt{2}} 2\pi \sqrt{x^2 + 1} \sqrt{\frac{2x^2 + 1}{x^2 + 1}} dx = \int_0^{\sqrt{2}} 2\pi \sqrt{2x^2 + 1} dx$;
 $\left[\begin{array}{l} u = \sqrt{2}x \\ du = \sqrt{2} dx \end{array} \right] \rightarrow \frac{2\pi}{\sqrt{2}} \int_0^2 \sqrt{u^2 + 1} du = \frac{2\pi}{\sqrt{2}} \left[\frac{1}{2} \left(u\sqrt{u^2 + 1} + \ln(u + \sqrt{u^2 + 1})\right)\right]_0^2 = \frac{\pi}{\sqrt{2}} \left[2\sqrt{5} + \ln(2 + \sqrt{5})\right]$

89. $\frac{dr_A}{dt} = \frac{dr_B}{dt} \Rightarrow \frac{d}{dt}(r_A - r_B) = 0 \Rightarrow r_A - r_B = C$, a constant \Rightarrow the points $P(t)$ lie on a hyperbola with foci at A and B

90. (a) $\tan \beta = m_L \Rightarrow \tan \beta = f'(x_0)$ where $f(x) = \sqrt{4px}$;

$$f'(x) = \frac{1}{2}(4px)^{-1/2}(4p) = \frac{2p}{\sqrt{4px}} \Rightarrow f'(x_0) = \frac{2p}{\sqrt{4px_0}}$$

$$= \frac{2p}{y_0} \Rightarrow \tan \beta = \frac{2p}{y_0}$$

(b) $\tan \phi = m_{FP} = \frac{y_0 - 0}{x_0 - p} = \frac{y_0}{x_0 - p}$

(c) $\tan \alpha = \frac{\tan \phi - \tan \beta}{1 + \tan \phi \tan \beta} = \frac{\left(\frac{y_0}{x_0 - p} - \frac{2p}{y_0}\right)}{1 + \left(\frac{y_0}{x_0 - p}\right)\left(\frac{2p}{y_0}\right)}$

$$= \frac{\frac{y_0^2 - 2p(x_0 - p)}{y_0(x_0 - p) + 2p}}{\frac{y_0(x_0 - p) + 2p}{y_0(x_0 - p)}} = \frac{4px_0 - 2px_0 + 2p^2}{y_0(x_0 + p)} = \frac{2p(x_0 + p)}{y_0(x_0 + p)} = \frac{2p}{y_0}$$

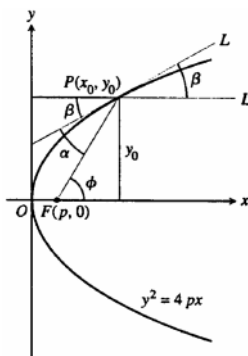

91. PF will always equal PB because the string has constant length $AB = FP + PA = AP + PB$.

92. (a) In the labeling of the accompanying figure we have

$\frac{y}{1} = \tan t$ so the coordinates of A are $(1, \tan t)$. The

coordinates of P are therefore $(1 + r, \tan t)$. Since

$$1^2 + y^2 = (OA)^2, \text{ we have } 1^2 + \tan^2 t = (1 + r)^2$$

$$\Rightarrow 1 + r = \sqrt{1 + \tan^2 t} = \sec t \Rightarrow r = \sec t - 1.$$

The coordinates of P are therefore $(x, y) = (\sec t, \tan t)$

$$\Rightarrow x^2 - y^2 = \sec^2 t - \tan^2 t = 1$$

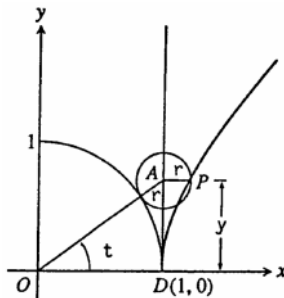

- (b) In the labeling of the accompany figure the coordinates of A are $(\cos t, \sin t)$, the coordinates of C are $(1, \tan t)$, and the coordinates of P are $(1 + d, \tan t)$. By similar triangles, $\frac{d}{AB} = \frac{OC}{OA} \Rightarrow \frac{d}{1 - \cos t} = \frac{\sqrt{1 + \tan^2 t}}{1}$
 $\Rightarrow d = (1 - \cos t)(\sec t) = \sec t - 1$. The coordinates of P are therefore $(\sec t, \tan t)$ and P moves on the hyperbola $x^2 - y^2 = 1$ as in part (a).

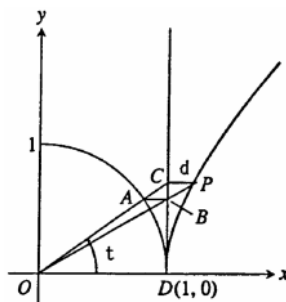

93. $x^2 = 4py$ and $y = p \Rightarrow x^2 = 4p^2 \Rightarrow x = \pm 2p$. Therefore the line $y = p$ cuts the parabola at points $(-2p, p)$ and $(2p, p)$, and these points are $\sqrt{[2p - (-2p)]^2 + (p - p)^2} = 4p$ units apart.

94. $\lim_{x \rightarrow \infty} \left(\frac{b}{a}x - \frac{b}{a}\sqrt{x^2 - a^2} \right) = \frac{b}{a} \lim_{x \rightarrow \infty} \left(x - \sqrt{x^2 - a^2} \right) = \frac{b}{a} \lim_{x \rightarrow \infty} \left[\frac{(x - \sqrt{x^2 - a^2})(x + \sqrt{x^2 - a^2})}{x + \sqrt{x^2 - a^2}} \right]$
 $= \frac{b}{a} \lim_{x \rightarrow \infty} \left[\frac{x^2 - (x^2 - a^2)}{x + \sqrt{x^2 - a^2}} \right] = \frac{b}{a} \lim_{x \rightarrow \infty} \left[\frac{a^2}{x + \sqrt{x^2 - a^2}} \right] = 0$

10.2 CLASSIFYING CONIC SECTIONS BY ECCENTRICITY

1. $16x^2 + 25y^2 = 400 \Rightarrow \frac{x^2}{25} + \frac{y^2}{16} = 1 \Rightarrow c = \sqrt{a^2 - b^2}$
 $= \sqrt{25 - 16} = 3 \Rightarrow e = \frac{c}{a} = \frac{3}{5}; F(\pm 3, 0);$
 directrices are $x = 0 \pm \frac{a}{e} = \pm \frac{25}{3}$

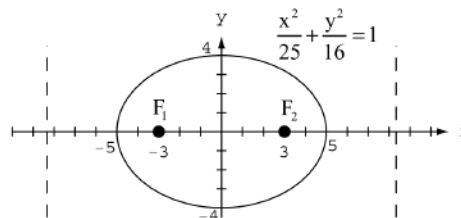

2. $7x^2 + 16y^2 = 112 \Rightarrow \frac{x^2}{16} + \frac{y^2}{7} = 1 \Rightarrow c = \sqrt{a^2 - b^2}$
 $= \sqrt{16 - 7} = 3 \Rightarrow e = \frac{c}{a} = \frac{3}{4}; F(\pm 3, 0);$
 directrices are $x = 0 \pm \frac{a}{e} = \pm \frac{16}{3}$

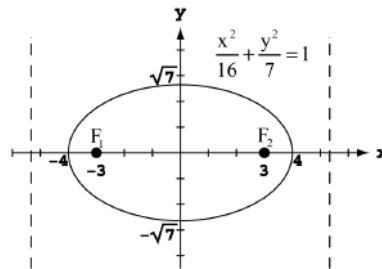

3. $2x^2 + y^2 = 2 \Rightarrow x^2 + \frac{y^2}{2} = 1 \Rightarrow c = \sqrt{a^2 - b^2}$
 $= \sqrt{2 - 1} = 1 \Rightarrow e = \frac{c}{a} = \frac{1}{\sqrt{2}}; F(0, \pm 1);$
 directrices are $y = 0 \pm \frac{a}{e} = \pm \frac{\sqrt{2}}{(\frac{1}{\sqrt{2}})} = \pm 2$

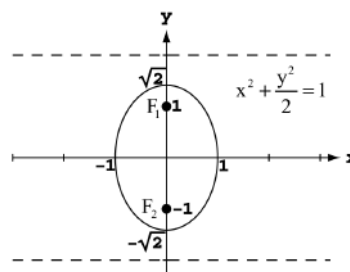

4. $2x^2 + y^2 = 4 \Rightarrow \frac{x^2}{2} + \frac{y^2}{4} = 1 \Rightarrow c = \sqrt{a^2 - b^2}$
 $= \sqrt{4 - 2} = \sqrt{2} \Rightarrow e = \frac{c}{a} = \frac{\sqrt{2}}{2}; F(0, \pm \sqrt{2});$
 directrices are $y = 0 \pm \frac{a}{e} = \pm \frac{2}{(\frac{\sqrt{2}}{2})} = \pm 2\sqrt{2}$

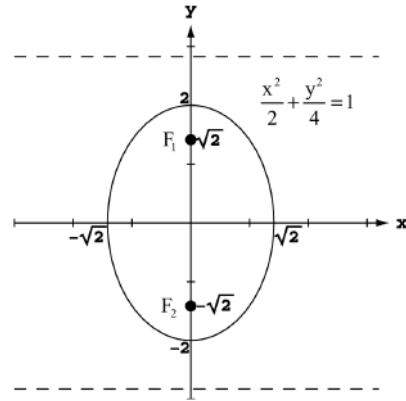

5. $3x^2 + 2y^2 = 6 \Rightarrow \frac{x^2}{2} + \frac{y^2}{3} = 1 \Rightarrow c = \sqrt{a^2 - b^2}$
 $= \sqrt{3 - 2} = 1 \Rightarrow e = \frac{c}{a} = \frac{1}{\sqrt{3}}; F(0, \pm 1);$
 directrices are $y = 0 \pm \frac{a}{e} = \pm \frac{\sqrt{3}}{(\frac{1}{\sqrt{3}})} = \pm 3$

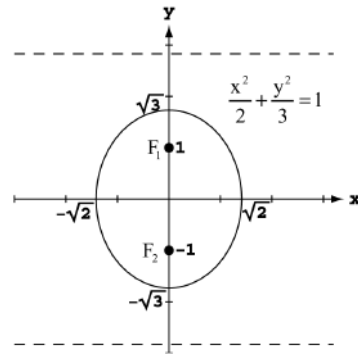

6. $9x^2 + 10y^2 = 90 \Rightarrow \frac{x^2}{10} + \frac{y^2}{9} = 1 \Rightarrow c = \sqrt{a^2 - b^2}$
 $= \sqrt{10 - 9} = 1 \Rightarrow e = \frac{c}{a} = \frac{1}{\sqrt{10}}; F(\pm 1, 0);$
 directrices are $x = 0 \pm \frac{a}{e} = \pm \frac{\sqrt{10}}{(\frac{1}{\sqrt{10}})} = \pm 10$

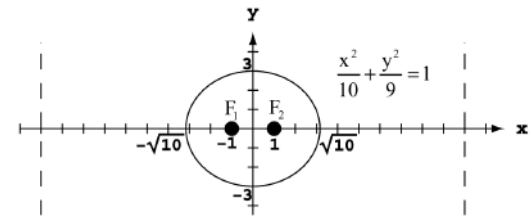

7. $6x^2 + 9y^2 = 54 \Rightarrow \frac{x^2}{9} + \frac{y^2}{6} = 1 \Rightarrow c = \sqrt{a^2 - b^2}$
 $= \sqrt{9 - 6} = \sqrt{3} \Rightarrow e = \frac{c}{a} = \frac{\sqrt{3}}{3}; F(\pm \sqrt{3}, 0);$
 directrices are $x = 0 \pm \frac{a}{e} = \pm \frac{3}{(\frac{\sqrt{3}}{3})} = \pm 3\sqrt{3}$

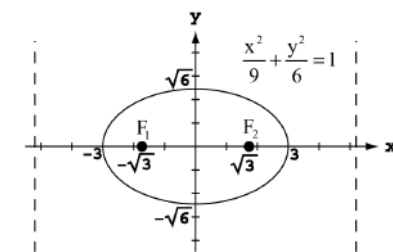

$$8. 169x^2 + 25y^2 = 4225 \Rightarrow \frac{x^2}{25} + \frac{y^2}{169} = 1 \Rightarrow c = \sqrt{a^2 - b^2}$$

$$= \sqrt{169 - 25} = 12 \Rightarrow e = \frac{c}{a} = \frac{12}{13}; F(0, \pm 12);$$

$$\text{directrices are } y = 0 \pm \frac{a}{e} = \pm \frac{13}{\left(\frac{12}{13}\right)} = \pm \frac{169}{12}$$

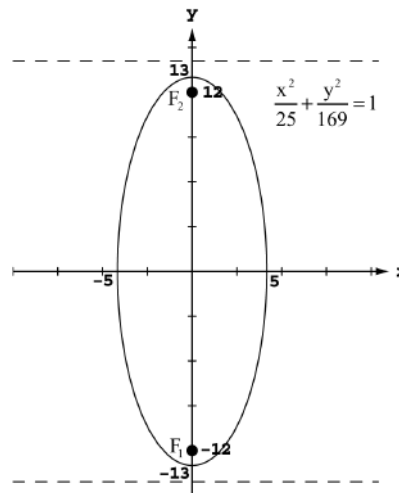

$$9. \text{Foci: } (0, \pm 3), e = 0.5 \Rightarrow c = 3 \text{ and } a = \frac{c}{e} = \frac{3}{0.5} = 6 \Rightarrow b^2 = 36 - 9 = 27 \Rightarrow \frac{x^2}{27} + \frac{y^2}{36} = 1$$

$$10. \text{Foci: } (\pm 8, 0), e = 0.2 \Rightarrow c = 8 \text{ and } a = \frac{c}{e} = \frac{8}{0.2} = 40 \Rightarrow b^2 = 1600 - 64 = 1536 \Rightarrow \frac{x^2}{1600} + \frac{y^2}{1536} = 1$$

$$11. \text{Vertices: } (0, \pm 70), e = 0.1 \Rightarrow a = 70 \text{ and } c = ae = 70(0.1) = 7 \Rightarrow b^2 = 4900 - 49 = 4851 \Rightarrow \frac{x^2}{4851} + \frac{y^2}{4900} = 1$$

$$12. \text{Vertices: } (\pm 10, 0), e = 0.24 \Rightarrow a = 10 \text{ and } c = ae = 10(0.24) = 2.4 \Rightarrow b^2 = 100 - 5.76 = 94.24$$

$$\Rightarrow \frac{x^2}{100} + \frac{y^2}{94.24} = 1$$

$$13. \text{Focus: } (\sqrt{5}, 0), \text{Directrix: } x = \frac{9}{\sqrt{5}} \Rightarrow c = ae = \sqrt{5} \text{ and } \frac{a}{e} = \frac{9}{\sqrt{5}} \Rightarrow \frac{ae}{e^2} = \frac{9}{\sqrt{5}} \Rightarrow \frac{\sqrt{5}}{e^2} = \frac{9}{\sqrt{5}} \Rightarrow e^2 = \frac{5}{9}$$

$$\Rightarrow e = \frac{\sqrt{5}}{3}. \text{ Then PF} = \frac{\sqrt{5}}{3} \text{PD} \Rightarrow \sqrt{(x - \sqrt{5})^2 + (y - 0)^2} = \frac{\sqrt{5}}{3} \left| x - \frac{9}{\sqrt{5}} \right| \Rightarrow (x - \sqrt{5})^2 + y^2 = \frac{5}{9} \left(x - \frac{9}{\sqrt{5}} \right)^2$$

$$\Rightarrow x^2 - 2\sqrt{5}x + 5 + y^2 = \frac{5}{9} \left(x^2 - \frac{18}{\sqrt{5}}x + \frac{81}{5} \right) \Rightarrow \frac{4}{9}x^2 + y^2 = 4 \Rightarrow \frac{x^2}{9} + \frac{y^2}{4} = 1$$

$$14. \text{Focus: } (4, 0), \text{Directrix: } x = \frac{16}{3} \Rightarrow c = ae = 4 \text{ and } \frac{a}{e} = \frac{16}{3} \Rightarrow \frac{ae}{e^2} = \frac{16}{3} \Rightarrow \frac{4}{e^2} = \frac{16}{3} \Rightarrow e^2 = \frac{3}{4} \Rightarrow e = \frac{\sqrt{3}}{2}. \text{ Then}$$

$$\text{PF} = \frac{\sqrt{3}}{2} \text{PD} \Rightarrow \sqrt{(x - 4)^2 + (y - 0)^2} = \frac{\sqrt{3}}{2} \left| x - \frac{16}{3} \right| \Rightarrow (x - 4)^2 + y^2 = \frac{3}{4} \left(x - \frac{16}{3} \right)^2 \Rightarrow x^2 - 8x + 16 + y^2$$

$$= \frac{3}{4} \left(x^2 - \frac{32}{3}x + \frac{256}{9} \right) \Rightarrow \frac{1}{4}x^2 + y^2 = \frac{16}{3} \Rightarrow \frac{x^2}{\left(\frac{64}{3}\right)} + \frac{y^2}{\left(\frac{16}{3}\right)} = 1$$

$$15. \text{Focus: } (-4, 0), \text{Directrix: } x = -16 \Rightarrow c = ae = 4 \text{ and } \frac{a}{e} = 16 \Rightarrow \frac{ae}{e^2} = 16 \Rightarrow \frac{4}{e^2} = 16 \Rightarrow e^2 = \frac{1}{4} \Rightarrow e = \frac{1}{2}. \text{ Then}$$

$$\text{PF} = \frac{1}{2} \text{PD} \Rightarrow \sqrt{(x + 4)^2 + (y - 0)^2} = \frac{1}{2} |x + 16| \Rightarrow (x + 4)^2 + y^2 = \frac{1}{4} (x + 16)^2 \Rightarrow x^2 + 8x + 16 + y^2$$

$$= \frac{1}{4} (x^2 + 32x + 256) \Rightarrow \frac{3}{4}x^2 + y^2 = 48 \Rightarrow \frac{x^2}{64} + \frac{y^2}{48} = 1$$

$$16. \text{Focus: } (-\sqrt{2}, 0), \text{Directrix: } x = -2\sqrt{2} \Rightarrow c = ae = \sqrt{2} \text{ and } \frac{a}{e} = 2\sqrt{2} \Rightarrow \frac{ae}{e^2} = 2\sqrt{2} \Rightarrow \frac{\sqrt{2}}{e^2} = 2\sqrt{2} \Rightarrow e^2 = \frac{1}{2}$$

$$\Rightarrow e = \frac{1}{\sqrt{2}}. \text{ Then PF} = \frac{1}{\sqrt{2}} \text{PD} \Rightarrow \sqrt{(x + \sqrt{2})^2 + (y - 0)^2} = \frac{1}{\sqrt{2}} |x + 2\sqrt{2}| \Rightarrow (x + \sqrt{2})^2 + y^2$$

$$= \frac{1}{2} (x + 2\sqrt{2})^2 \Rightarrow x^2 + 2\sqrt{2}x + 2 + y^2 = \frac{1}{2} (x^2 + 4\sqrt{2}x + 8) \Rightarrow \frac{1}{2}x^2 + y^2 = 2 \Rightarrow \frac{x^2}{4} + \frac{y^2}{2} = 1$$

17. $e = \frac{4}{5} \Rightarrow$ take $c = 4$ and $a = 5; c^2 = a^2 - b^2$
 $\Rightarrow 16 = 25 - b^2 \Rightarrow b^2 = 9 \Rightarrow b = 3$; therefore
 $\frac{x^2}{25} + \frac{y^2}{9} = 1$

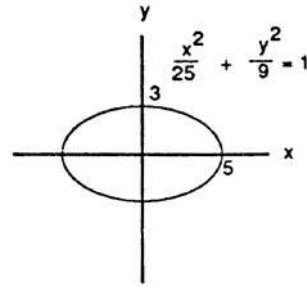

18. The eccentricity e for Pluto is $0.25 \Rightarrow e = \frac{c}{a} = 0.25 = \frac{1}{4}$
 \Rightarrow take $c = 1$ and $a = 4; c^2 = a^2 - b^2 \Rightarrow 1 = 16 - b^2$
 $\Rightarrow b^2 = 15 \Rightarrow b = \sqrt{15}$; therefore, $\frac{x^2}{16} + \frac{y^2}{15} = 1$ is a
 model of Pluto's orbit.

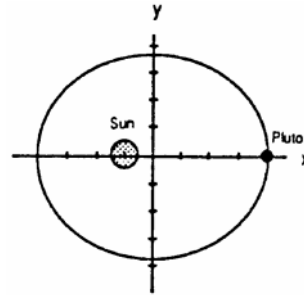

19. One axis is from $A(1, 1)$ to $B(1, 7)$ and is 6 units long; the
 other axis is from $C(3, 4)$ to $D(-1, 4)$ and is 4 units long.
 Therefore $a = 3, b = 2$ and the major axis is vertical. The
 center is the point $C(1, 4)$ and the ellipse is given by
 $\frac{(x-1)^2}{4} + \frac{(y-4)^2}{9} = 1; c^2 = a^2 - b^2 = 3^2 - 2^2 = 5$
 $\Rightarrow c = \sqrt{5}$; therefore the foci are $F(1, 4 \pm \sqrt{5})$, the
 eccentricity is $e = \frac{c}{a} = \frac{\sqrt{5}}{3}$, and the directrices are
 $y = 4 \pm \frac{a}{e} = 4 \pm \frac{3}{\frac{\sqrt{5}}{3}} = 4 \pm \frac{9\sqrt{5}}{5}$.

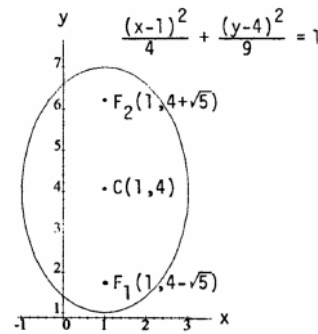

20. Using $PF = e \cdot PD$, we have $\sqrt{(x-4)^2 + y^2} = \frac{2}{3} |x-9| \Rightarrow (x-4)^2 + y^2 = \frac{4}{9} (x-9)^2 \Rightarrow x^2 - 8x + 16 + y^2$
 $= \frac{4}{9} (x^2 - 18x + 81) \Rightarrow \frac{5}{9} x^2 + y^2 = 20 \Rightarrow 5x^2 + 9y^2 = 180$ or $\frac{x^2}{36} + \frac{y^2}{20} = 1$.

21. The ellipse must pass through $(0, 0) \Rightarrow c = 0$; the point $(-1, 2)$ lies on the ellipse $\Rightarrow -a + 2b = -8$. The ellipse
 is tangent to the x -axis \Rightarrow its center is on the y -axis, so $a = 0$ and $b = -4 \Rightarrow$ the equation is $4x^2 + y^2 - 4y = 0$.
 Next, $4x^2 + y^2 - 4y + 4 = 4 \Rightarrow 4x^2 + (y-2)^2 = 4 \Rightarrow x^2 + \frac{(y-2)^2}{4} = 1 \Rightarrow a = 2$ and $b = 1$ (now using the
 standard symbols) $\Rightarrow c^2 = a^2 - b^2 = 4 - 1 = 3 \Rightarrow c = \sqrt{3} \Rightarrow e = \frac{c}{a} = \frac{\sqrt{3}}{2}$.

22. We first prove a result which we will use: let m_1 , and
 m_2 be two nonparallel, nonperpendicular lines. Let α be
 the acute angle between the lines. Then $\tan \alpha = \frac{m_1 - m_2}{1 + m_1 m_2}$.

To see this result, let θ_1 be the angle of inclination of the
 line with slope m_1 , and θ_2 be the angle of inclination of the
 line with slope m_2 . Assume $m_1 > m_2$. Then $\theta_1 > \theta_2$ and we
 have $\alpha = \theta_1 - \theta_2$. Then $\tan \alpha = \tan(\theta_1 - \theta_2)$

$$= \frac{\tan \theta_1 - \tan \theta_2}{1 + \tan \theta_1 \tan \theta_2} = \frac{m_1 - m_2}{1 + m_1 m_2}, \text{ since } m_1 = \tan \theta_1 \text{ and and } m_2 = \tan \theta_2.$$

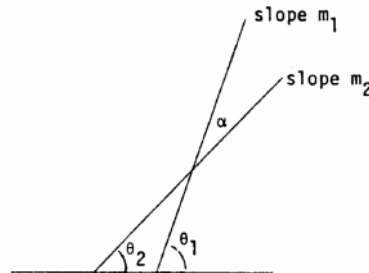

Now we prove the reflective property of ellipses (see the accompanying figure): If $\frac{x^2}{a^2} + \frac{y^2}{b^2} = 1$, then

$$b^2x^2 + a^2y^2 = a^2b^2 \text{ and } y = \frac{b}{a} \sqrt{a^2 - x^2} \Rightarrow y' = \frac{-bx}{a\sqrt{a^2 - x^2}}.$$

Let $P(x_0, y_0)$ be any point on the ellipse

$$\Rightarrow y'(x_0) = \frac{-bx_0}{a\sqrt{a^2 - x_0^2}} = \frac{-b^2x_0}{a^2y_0}. \text{ Let } F_1(c, 0) \text{ and } F_2(-c, 0)$$

be the foci. Then $m_{PF_1} = \frac{y_0}{x_0 - c}$ and $m_{PF_2} = \frac{y_0}{x_0 + c}$. Let α and β be the angles between the tangent line and PF_1 and PF_2 , respectively. Then

$$\tan \alpha = \frac{\left(\frac{-b^2x_0}{a^2y_0} - \frac{y_0}{x_0 - c} \right)}{\left(1 - \frac{b^2x_0y_0}{a^2y_0(x_0 - c)} \right)} = \frac{-b^2x_0^2 + b^2x_0c - a^2y_0^2}{a^2y_0x_0 - a^2y_0c - b^2x_0y_0} = \frac{b^2x_0c - (b^2x_0^2 + a^2y_0^2)}{-a^2y_0c + (a^2 - b^2)x_0y_0} = \frac{b^2x_0c - a^2b^2}{-a^2y_0c + c^2x_0y_0} = \frac{b^2}{cy_0}.$$

Similarly, $\tan \beta = \frac{b^2}{cy_0}$. Since $\tan \alpha = \tan \beta$, and α and β are both less than 90° , we have $\alpha = \beta$.

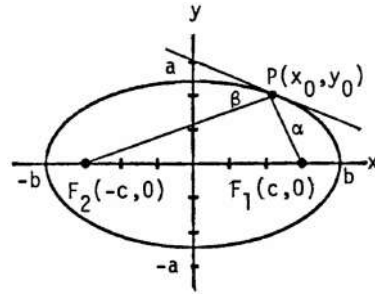

23. $x^2 - y^2 = 1 \Rightarrow c = \sqrt{a^2 + b^2} = \sqrt{1 + 1} = \sqrt{2} \Rightarrow e = \frac{c}{a} = \frac{\sqrt{2}}{1} = \sqrt{2}$; asymptotes are $y = \pm x$; $F(\pm\sqrt{2}, 0)$; directrices are $x = 0 \pm \frac{a}{e} = \pm \frac{1}{\sqrt{2}}$

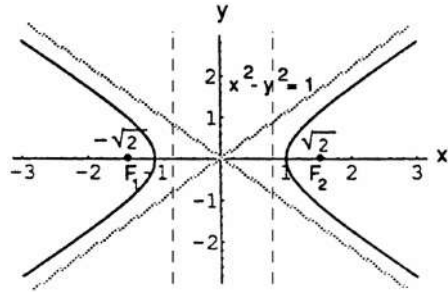

24. $9x^2 - 16y^2 = 144 \Rightarrow \frac{x^2}{16} - \frac{y^2}{9} = 1 \Rightarrow c = \sqrt{a^2 + b^2} = \sqrt{16 + 9} = 5 \Rightarrow e = \frac{c}{a} = \frac{5}{4}$; asymptotes are $y = \pm \frac{3}{4}x$; $F(\pm 5, 0)$; directrices are $x = 0 \pm \frac{a}{e} = \pm \frac{16}{5}$

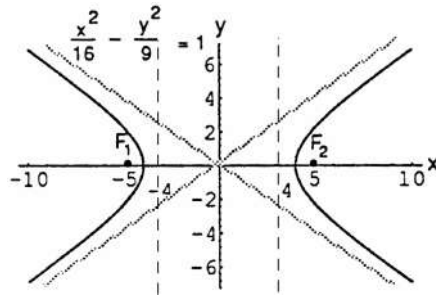

25. $y^2 - x^2 = 8 \Rightarrow \frac{y^2}{8} - \frac{x^2}{8} = 1 \Rightarrow c = \sqrt{a^2 + b^2} = \sqrt{8 + 8} = 4 \Rightarrow e = \frac{c}{a} = \frac{4}{\sqrt{8}} = \sqrt{2}$; asymptotes are $y = \pm x$; $F(0, \pm 4)$; directrices are $y = 0 \pm \frac{a}{e} = \pm \frac{\sqrt{8}}{\sqrt{2}} = \pm 2$

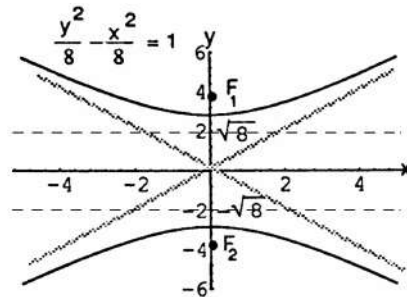

26. $y^2 - x^2 = 4 \Rightarrow \frac{y^2}{4} - \frac{x^2}{4} = 1 \Rightarrow c = \sqrt{a^2 + b^2}$
 $= \sqrt{4 + 4} = 2\sqrt{2} \Rightarrow e = \frac{c}{a} = \frac{2\sqrt{2}}{2} = \sqrt{2}$; asymptotes
 are $y = \pm x$; $F(0, \pm 2\sqrt{2})$; directrices are $y = 0 \pm \frac{a}{e}$
 $= \pm \frac{2}{\sqrt{2}} = \pm \sqrt{2}$

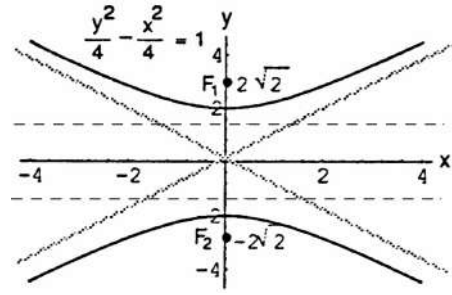

27. $8x^2 - 2y^2 = 16 \Rightarrow \frac{x^2}{2} - \frac{y^2}{8} = 1 \Rightarrow c = \sqrt{a^2 + b^2}$
 $= \sqrt{2 + 8} = \sqrt{10} \Rightarrow e = \frac{c}{a} = \frac{\sqrt{10}}{\sqrt{2}} = \sqrt{5}$; asymptotes
 are $y = \pm 2x$; $F(\pm \sqrt{10}, 0)$; directrices are $x = 0 \pm \frac{a}{e}$
 $= \pm \frac{\sqrt{2}}{\sqrt{5}} = \pm \frac{2}{\sqrt{10}}$

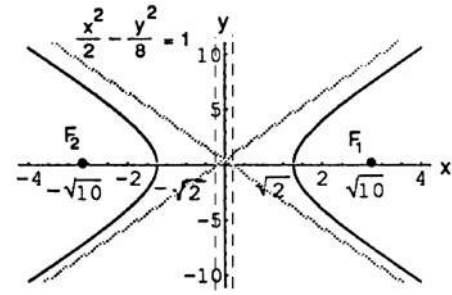

28. $y^2 - 3x^2 = 3 \Rightarrow \frac{y^2}{3} - x^2 = 1 \Rightarrow c = \sqrt{a^2 + b^2}$
 $= \sqrt{3 + 1} = 2 \Rightarrow e = \frac{c}{a} = \frac{2}{\sqrt{3}}$; asymptotes are
 $y = \pm \sqrt{3}x$; $F(0, \pm 2)$; directrices are $y = 0 \pm \frac{a}{e}$
 $= \pm \frac{\sqrt{3}}{(\frac{2}{\sqrt{3}})} = \pm \frac{3}{2}$

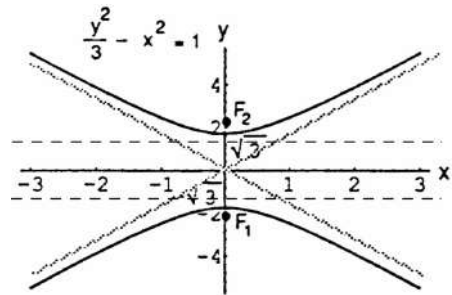

29. $8y^2 - 2x^2 = 16 \Rightarrow \frac{y^2}{2} - \frac{x^2}{8} = 1 \Rightarrow c = \sqrt{a^2 + b^2}$
 $= \sqrt{2 + 8} = \sqrt{10} \Rightarrow e = \frac{c}{a} = \frac{\sqrt{10}}{\sqrt{2}} = \sqrt{5}$; asymptotes
 are $y = \pm \frac{x}{2}$; $F(0, \pm \sqrt{10})$; directrices are $y = 0 \pm \frac{a}{e}$
 $= \pm \frac{\sqrt{2}}{\sqrt{5}} = \pm \frac{2}{\sqrt{10}}$

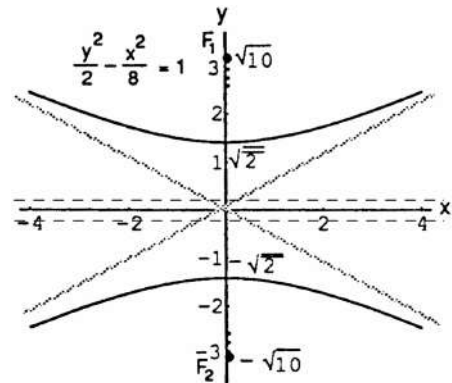

30. $64x^2 - 36y^2 = 2304 \Rightarrow \frac{x^2}{36} - \frac{y^2}{64} = 1 \Rightarrow c = \sqrt{a^2 + b^2}$
 $= \sqrt{36 + 64} = 10 \Rightarrow e = \frac{c}{a} = \frac{10}{6} = \frac{5}{3}$; asymptotes are
 $y = \pm \frac{4}{3}x$; $F(\pm 10, 0)$; directrices are $x = 0 \pm \frac{a}{e}$
 $= \pm \frac{6}{(\frac{5}{3})} = \pm \frac{18}{5}$

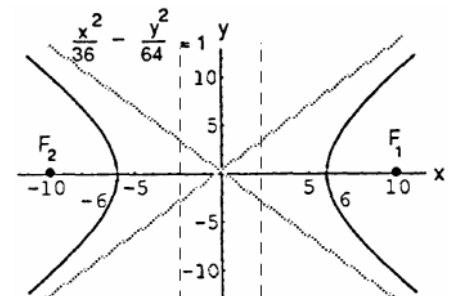

31. Vertices $(0, \pm 1)$ and $e = 3 \Rightarrow a = 1$ and $e = \frac{c}{a} = 3 \Rightarrow c = 3a = 3 \Rightarrow b^2 = c^2 - a^2 = 9 - 1 = 8 \Rightarrow y^2 - \frac{x^2}{8} = 1$

32. Vertices $(\pm 2, 0)$ and $e = 2 \Rightarrow a = 2$ and $e = \frac{c}{a} = 2 \Rightarrow c = 2a = 4 \Rightarrow b^2 = c^2 - a^2 = 16 - 4 = 12 \Rightarrow \frac{x^2}{4} - \frac{y^2}{12} = 1$

33. Foci $(\pm 3, 0)$ and $e = 3 \Rightarrow c = 3$ and $e = \frac{c}{a} = 3 \Rightarrow c = 3a \Rightarrow a = 1 \Rightarrow b^2 = c^2 - a^2 = 9 - 1 = 8 \Rightarrow x^2 - \frac{y^2}{8} = 1$

34. Foci $(0, \pm 5)$ and $e = 1.25 \Rightarrow c = 5$ and $e = \frac{c}{a} = 1.25 = \frac{5}{4} \Rightarrow c = \frac{5}{4}a \Rightarrow 5 = \frac{5}{4}a \Rightarrow a = 4 \Rightarrow b^2 = c^2 - a^2 = 25 - 16 = 9 \Rightarrow \frac{y^2}{16} - \frac{x^2}{9} = 1$

35. Focus $(4, 0)$ and Directrix $x = 2 \Rightarrow c = ae = 4$ and $\frac{a}{c} = 2 \Rightarrow \frac{ae}{c^2} = 2 \Rightarrow \frac{4}{c^2} = 2 \Rightarrow e^2 = 2 \Rightarrow e = \sqrt{2}$. Then $PF = \sqrt{2} PD \Rightarrow \sqrt{(x-4)^2 + (y-0)^2} = \sqrt{2} |x-2| \Rightarrow (x-4)^2 + y^2 = 2(x-2)^2 \Rightarrow x^2 - 8x + 16 + y^2 = 2(x^2 - 4x + 4) \Rightarrow -x^2 + y^2 = -8 \Rightarrow \frac{x^2}{8} - \frac{y^2}{8} = 1$

36. Focus $(\sqrt{10}, 0)$ and Directrix $x = \sqrt{2} \Rightarrow c = ae = \sqrt{10}$ and $\frac{a}{c} = \sqrt{2} \Rightarrow \frac{ae}{c^2} = \sqrt{2} \Rightarrow \frac{\sqrt{10}}{c^2} = \sqrt{2} \Rightarrow e^2 = \sqrt{5} \Rightarrow e = \sqrt[4]{5}$. Then $PF = \sqrt[4]{5} PD \Rightarrow \sqrt[4]{(x-\sqrt{10})^2 + (y-0)^2} = \sqrt[4]{5} |x-\sqrt{2}| \Rightarrow (x-\sqrt{10})^2 + y^2 = \sqrt{5} (x-\sqrt{2})^2 \Rightarrow x^2 - 2\sqrt{10}x + 10 + y^2 = \sqrt{5} (x^2 - 2\sqrt{2}x + 2) \Rightarrow (1-\sqrt{5})x^2 + y^2 = 2\sqrt{5} - 10 \Rightarrow \frac{(1-\sqrt{5})x^2}{2\sqrt{5}-10} + \frac{y^2}{2\sqrt{5}-10} = 1 \Rightarrow \frac{x^2}{2\sqrt{5}} - \frac{y^2}{10-2\sqrt{5}} = 1$

37. Focus $(-2, 0)$ and Directrix $x = -\frac{1}{2} \Rightarrow c = ae = 2$ and $\frac{a}{c} = \frac{1}{2} \Rightarrow \frac{ae}{c^2} = \frac{1}{2} \Rightarrow \frac{2}{c^2} = \frac{1}{2} \Rightarrow e^2 = 4 \Rightarrow e = 2$. Then $PF = 2PD \Rightarrow \sqrt{(x+2)^2 + (y-0)^2} = 2|x+\frac{1}{2}| \Rightarrow (x+2)^2 + y^2 = 4(x+\frac{1}{2})^2 \Rightarrow x^2 + 4x + 4 + y^2 = 4(x^2 + x + \frac{1}{4}) \Rightarrow -3x^2 + y^2 = -3 \Rightarrow x^2 - \frac{y^2}{3} = 1$

38. Focus $(-6, 0)$ and Directrix $x = -2 \Rightarrow c = ae = 6$ and $\frac{a}{c} = 2 \Rightarrow \frac{ae}{c^2} = 2 \Rightarrow \frac{6}{c^2} = 2 \Rightarrow e^2 = 3 \Rightarrow e = \sqrt{3}$. Then $PF = \sqrt{3} PD \Rightarrow \sqrt{(x+6)^2 + (y-0)^2} = \sqrt{3} |x+2| \Rightarrow (x+6)^2 + y^2 = 3(x+2)^2 \Rightarrow x^2 + 12x + 36 + y^2 = 3(x^2 + 4x + 4) \Rightarrow -2x^2 + y^2 = -24 \Rightarrow \frac{x^2}{12} - \frac{y^2}{24} = 1$

39. $\sqrt{(x-1)^2 + (y+3)^2} = \frac{3}{2} |y-2| \Rightarrow x^2 - 2x + 1 + y^2 + 6y + 9 = \frac{9}{4} (y^2 - 4y + 4) \Rightarrow 4x^2 - 5y^2 - 8x + 60y + 4 = 0 \Rightarrow 4(x^2 - 2x + 1) - 5(y^2 - 12y + 36) = -4 + 4 - 180 \Rightarrow \frac{(y-6)^2}{36} - \frac{(x-1)^2}{45} = 1$

40. $c^2 = a^2 + b^2 \Rightarrow b^2 = c^2 - a^2; e = \frac{c}{a} \Rightarrow c = ea \Rightarrow c^2 = e^2 a^2 \Rightarrow b^2 = e^2 a^2 - a^2 = a^2 (e^2 - 1)$; thus, $\frac{x^2}{a^2} - \frac{y^2}{b^2} = 1 \Rightarrow \frac{x^2}{a^2} - \frac{y^2}{a^2(e^2-1)} = 1$; the asymptotes of this hyperbola are $y = \pm (e^2 - 1)x \Rightarrow$ as e increases, the absolute values of the slopes of the asymptotes increase and the hyperbola approaches a straight line.

41. To prove the reflective property for hyperbolas:
 $\frac{x^2}{a^2} - \frac{y^2}{b^2} = 1 \Rightarrow a^2 y^2 = b^2 x^2 - a^2 b^2$ and $\frac{dy}{dx} = \frac{xb^2}{ya^2}$.
 Let $P(x_0, y_0)$ be a point of tangency (see the accompanying figure). The slope from P to $F_1(-c, 0)$ is $\frac{y_0}{x_0 + c}$ and from P to $F_2(c, 0)$ it is $\frac{y_0}{x_0 - c}$. Let the tangent through P meet the x -axis in point A , and define the angles $\angle F_1PA = \alpha$ and $\angle F_2PA = \beta$. We will show that $\tan \alpha = \tan \beta$. From the preliminary result in Exercise 22,

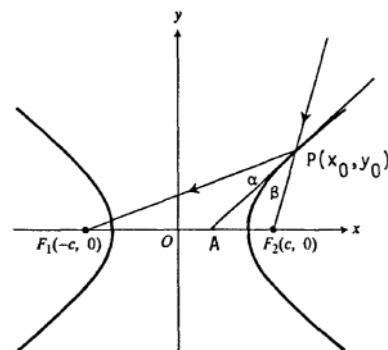

$$\tan \alpha = \frac{\left(\frac{x_0 b^2}{y_0 a^2} - \frac{y_0}{x_0 + c}\right)}{1 + \left(\frac{x_0 b^2}{y_0 a^2}\right)\left(\frac{y_0}{x_0 + c}\right)} = \frac{x_0^2 b^2 + x_0 b^2 c - y_0^2 a^2}{x_0 y_0 a^2 + y_0 a^2 c + x_0 y_0 b^2} = \frac{a^2 b^2 + x_0 b^2 c}{x_0 y_0 c^2 + y_0 a^2 c} = \frac{b^2}{y_0 c}.$$

In a similar manner,

$$\tan \beta = \frac{\left(\frac{y_0}{x_0 - c} - \frac{x_0 b^2}{y_0 a^2}\right)}{1 + \left(\frac{y_0}{x_0 - c}\right)\left(\frac{x_0 b^2}{y_0 a^2}\right)} = \frac{b^2}{y_0 c}.$$

Since $\tan \alpha = \tan \beta$, and α and β are acute angles, we have $\alpha = \beta$.

42. From the accompanying figure, a ray of light emanating from the focus A that met the parabola at P would be reflected from the hyperbola as if it came directly from B (Exercise 41). The same light ray would be reflected off the ellipse to pass through B. Thus BPC is a straight line. Let β be the angle of incidence of the light ray on the hyperbola. Let α be the angle of incidence of the light ray on the ellipse. Note that $\alpha + \beta$ is the angle between the tangent lines to the ellipse and hyperbola at P. Since BPC is a straight line, $2\alpha + 2\beta = 180^\circ$. Thus $\alpha + \beta = 90^\circ$.

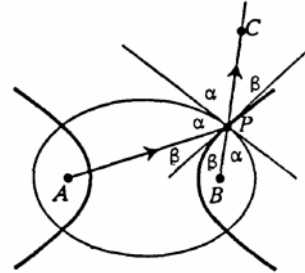

10.3 QUADRATIC EQUATIONS AND ROTATIONS

1. $x^2 - 3xy + y^2 - x = 0 \Rightarrow B^2 - 4AC = (-3)^2 - 4(1)(1) = 5 > 0 \Rightarrow$ Hyperbola
2. $3x^2 - 18xy + 27y^2 - 5x + 7y = -4 \Rightarrow B^2 - 4AC = (-18)^2 - 4(3)(27) = 0 \Rightarrow$ Parabola
3. $3x^2 - 7xy + \sqrt{17}y^2 = 1 \Rightarrow B^2 - 4AC = (-7)^2 - 4(3)\sqrt{17} \approx -0.477 < 0 \Rightarrow$ Ellipse
4. $2x^2 - \sqrt{15}xy + 2y^2 + x + y = 0 \Rightarrow B^2 - 4AC = \left(-\sqrt{15}\right)^2 - 4(2)(2) = -1 < 0 \Rightarrow$ Ellipse
5. $x^2 + 2xy + y^2 + 2x - y + 2 = 0 \Rightarrow B^2 - 4AC = 2^2 - 4(1)(1) = 0 \Rightarrow$ Parabola
6. $2x^2 - y^2 + 4xy - 2x + 3y = 6 \Rightarrow B^2 - 4AC = 4^2 - 4(2)(-1) = 24 > 0 \Rightarrow$ Hyperbola
7. $x^2 + 4xy + 4y^2 - 3x = 6 \Rightarrow B^2 - 4AC = 4^2 - 4(1)(4) = 0 \Rightarrow$ Parabola
8. $x^2 + y^2 + 3x - 2y = 10 \Rightarrow B^2 - 4AC = 0^2 - 4(1)(1) = -4 < 0 \Rightarrow$ Ellipse (circle)
9. $xy + y^2 - 3x = 5 \Rightarrow B^2 - 4AC = 1^2 - 4(0)(1) = 1 > 0 \Rightarrow$ Hyperbola
10. $3x^2 + 6xy + 3y^2 - 4x + 5y = 12 \Rightarrow B^2 - 4AC = 6^2 - 4(3)(3) = 0 \Rightarrow$ Parabola
11. $3x^2 - 5xy + 2y^2 - 7x - 14y = -1 \Rightarrow B^2 - 4AC = (-5)^2 - 4(3)(2) = 1 > 0 \Rightarrow$ Hyperbola
12. $2x^2 - 4.9xy + 3y^2 - 4x = 7 \Rightarrow B^2 - 4AC = (-4.9)^2 - 4(2)(3) = 0.01 > 0 \Rightarrow$ Hyperbola
13. $x^2 - 3xy + 3y^2 + 6y = 7 \Rightarrow B^2 - 4AC = (-3)^2 - 4(1)(3) = -3 < 0 \Rightarrow$ Ellipse
14. $25x^2 + 21xy + 4y^2 - 350x = 0 \Rightarrow B^2 - 4AC = 21^2 - 4(25)(4) = 41 > 0 \Rightarrow$ Hyperbola
15. $6x^2 + 3xy + 2y^2 + 17y + 2 = 0 \Rightarrow B^2 - 4AC = 3^2 - 4(6)(2) = -39 < 0 \Rightarrow$ Ellipse

16. $3x^2 + 12xy + 12y^2 + 435x - 9y + 72 = 0 \Rightarrow B^2 - 4AC = 12^2 - 4(3)(12) = 0 \Rightarrow$ Parabola

17. $\cot 2\alpha = \frac{A-C}{B} = \frac{0}{1} = 0 \Rightarrow 2\alpha = \frac{\pi}{2} \Rightarrow \alpha = \frac{\pi}{4}$; therefore $x = x' \cos \alpha - y' \sin \alpha$,

$$y = x' \sin \alpha + y' \cos \alpha \Rightarrow x = x' \frac{\sqrt{2}}{2} - y' \frac{\sqrt{2}}{2}, y = x' \frac{\sqrt{2}}{2} + y' \frac{\sqrt{2}}{2}$$

$$\Rightarrow \left(\frac{\sqrt{2}}{2}x' - \frac{\sqrt{2}}{2}y'\right)\left(\frac{\sqrt{2}}{2}x' + \frac{\sqrt{2}}{2}y'\right) = 2 \Rightarrow \frac{1}{2}x'^2 - \frac{1}{2}y'^2 = 2 \Rightarrow x'^2 - y'^2 = 4 \Rightarrow \text{Hyperbola}$$

18. $\cot 2\alpha = \frac{A-C}{B} = \frac{1-1}{1} = 0 \Rightarrow 2\alpha = \frac{\pi}{2} \Rightarrow \alpha = \frac{\pi}{4}$; therefore $x = x' \cos \alpha - y' \sin \alpha$,

$$y = x' \sin \alpha + y' \cos \alpha \Rightarrow x = x' \frac{\sqrt{2}}{2} - y' \frac{\sqrt{2}}{2}, y = x' \frac{\sqrt{2}}{2} + y' \frac{\sqrt{2}}{2}$$

$$\Rightarrow \left(\frac{\sqrt{2}}{2}x' - \frac{\sqrt{2}}{2}y'\right)^2 + \left(\frac{\sqrt{2}}{2}x' + \frac{\sqrt{2}}{2}y'\right)\left(\frac{\sqrt{2}}{2}x' - \frac{\sqrt{2}}{2}y'\right) + \left(\frac{\sqrt{2}}{2}x' + \frac{\sqrt{2}}{2}y'\right)^2 = 1$$

$$\Rightarrow \frac{1}{2}x'^2 - x'y' + \frac{1}{2}y'^2 + \frac{1}{2}x'^2 - \frac{1}{2}y'^2 + \frac{1}{2}x'^2 + x'y' + \frac{1}{2}y'^2 = 1 \Rightarrow \frac{3}{2}x'^2 + \frac{1}{2}y'^2 = 1 \Rightarrow 3x'^2 + y'^2 = 2 \Rightarrow \text{Ellipse}$$

19. $\cot 2\alpha = \frac{A-C}{B} = \frac{3-1}{2\sqrt{3}} = \frac{1}{\sqrt{3}} \Rightarrow 2\alpha = \frac{\pi}{3} \Rightarrow \alpha = \frac{\pi}{6}$; therefore $x = x' \cos \alpha - y' \sin \alpha$,

$$y = x' \sin \alpha + y' \cos \alpha \Rightarrow x = \frac{\sqrt{3}}{2}x' - \frac{1}{2}y', y = \frac{1}{2}x' + \frac{\sqrt{3}}{2}y'$$

$$\Rightarrow 3\left(\frac{\sqrt{3}}{2}x' - \frac{1}{2}y'\right)^2 + 2\sqrt{3}\left(\frac{\sqrt{3}}{2}x' + \frac{1}{2}y'\right)\left(\frac{1}{2}x' + \frac{\sqrt{3}}{2}y'\right) + \left(\frac{1}{2}x' + \frac{\sqrt{3}}{2}y'\right)^2 - 8\left(\frac{\sqrt{3}}{2}x' - \frac{1}{2}y'\right)$$

$$+ 8\sqrt{3}\left(\frac{1}{2}x' + \frac{\sqrt{3}}{2}y'\right) = 0 \Rightarrow 4x'^2 + 16y' = 0 \Rightarrow \text{Parabola}$$

20. $\cot 2\alpha = \frac{A-C}{B} = \frac{1-2}{-\sqrt{3}} = \frac{1}{\sqrt{3}} \Rightarrow 2\alpha = \frac{\pi}{3} \Rightarrow \alpha = \frac{\pi}{6}$; therefore $x = x' \cos \alpha - y' \sin \alpha$,

$$y = x' \sin \alpha + y' \cos \alpha \Rightarrow x = \frac{\sqrt{3}}{2}x' - \frac{1}{2}y', y = \frac{1}{2}x' + \frac{\sqrt{3}}{2}y'$$

$$\Rightarrow \left(\frac{\sqrt{3}}{2}x' - \frac{1}{2}y'\right)^2 - \sqrt{3}\left(\frac{\sqrt{3}}{2}x' - \frac{1}{2}y'\right)\left(\frac{1}{2}x' + \frac{\sqrt{3}}{2}y'\right) + 2\left(\frac{1}{2}x' + \frac{\sqrt{3}}{2}y'\right)^2 = 1 \Rightarrow \frac{1}{2}x'^2 + \frac{5}{2}y'^2 = 1$$

$$\Rightarrow x'^2 + 5y'^2 = 2 \Rightarrow \text{Ellipse}$$

21. $\cot 2\alpha = \frac{A-C}{B} = \frac{1-1}{-2} = 0 \Rightarrow 2\alpha = \frac{\pi}{2} \Rightarrow \alpha = \frac{\pi}{4}$; therefore $x = x' \cos \alpha - y' \sin \alpha$,

$$y = x' \sin \alpha + y' \cos \alpha \Rightarrow x = \frac{\sqrt{2}}{2}x' - \frac{\sqrt{2}}{2}y', y = \frac{\sqrt{2}}{2}x' + \frac{\sqrt{2}}{2}y'$$

$$\Rightarrow \left(\frac{\sqrt{2}}{2}x' - \frac{\sqrt{2}}{2}y'\right)^2 - 2\left(\frac{\sqrt{2}}{2}x' - \frac{\sqrt{2}}{2}y'\right)\left(\frac{\sqrt{2}}{2}x' + \frac{\sqrt{2}}{2}y'\right) + \left(\frac{\sqrt{2}}{2}x' + \frac{\sqrt{2}}{2}y'\right)^2 = 2 \Rightarrow y'^2 = 1$$

$$\Rightarrow \text{Parallel horizontal lines}$$

22. $\cot 2\alpha = \frac{A-C}{B} = \frac{3-1}{-2\sqrt{3}} = -\frac{1}{\sqrt{3}} \Rightarrow 2\alpha = \frac{2\pi}{3} \Rightarrow \alpha = \frac{\pi}{3}$; therefore $x = x' \cos \alpha - y' \sin \alpha$,

$$y = x' \sin \alpha + y' \cos \alpha \Rightarrow x = \frac{1}{2}x' - \frac{\sqrt{3}}{2}y', y = \frac{\sqrt{3}}{2}x' + \frac{1}{2}y'$$

$$\Rightarrow 3\left(\frac{1}{2}x' - \frac{\sqrt{3}}{2}y'\right)^2 - 2\sqrt{3}\left(\frac{1}{2}x' - \frac{\sqrt{3}}{2}y'\right)\left(\frac{\sqrt{3}}{2}x' + \frac{1}{2}y'\right) + \left(\frac{\sqrt{3}}{2}x' + \frac{1}{2}y'\right)^2 = 1 \Rightarrow 4y'^2 = 1$$

$$\Rightarrow \text{Parallel horizontal lines}$$

23. $\cot 2\alpha = \frac{A-C}{B} = \frac{\sqrt{2}-\sqrt{2}}{2\sqrt{2}} = 0 \Rightarrow 2\alpha = \frac{\pi}{2} \Rightarrow \alpha = \frac{\pi}{4}$; therefore $x = x' \cos \alpha - y' \sin \alpha$,

$$y = x' \sin \alpha + y' \cos \alpha \Rightarrow x = \frac{\sqrt{2}}{2}x' - \frac{\sqrt{2}}{2}y', y = \frac{\sqrt{2}}{2}x' + \frac{\sqrt{2}}{2}y'$$

$$\Rightarrow \sqrt{2}\left(\frac{\sqrt{2}}{2}x' - \frac{\sqrt{2}}{2}y'\right)^2 + 2\sqrt{2}\left(\frac{\sqrt{2}}{2}x' - \frac{\sqrt{2}}{2}y'\right)\left(\frac{\sqrt{2}}{2}x' + \frac{\sqrt{2}}{2}y'\right) + \sqrt{2}\left(\frac{\sqrt{2}}{2}x' + \frac{\sqrt{2}}{2}y'\right)^2$$

$$- 8\left(\frac{\sqrt{2}}{2}x' - \frac{\sqrt{2}}{2}y'\right) + 8\left(\frac{\sqrt{2}}{2}x' + \frac{\sqrt{2}}{2}y'\right) = 0 \Rightarrow 2\sqrt{2}x'^2 + 8\sqrt{2}y' = 0 \Rightarrow \text{Parabola}$$

24. $\cot 2\alpha = \frac{A-C}{B} = \frac{0-0}{1} = 0 \Rightarrow 2\alpha = \frac{\pi}{2} \Rightarrow \alpha = \frac{\pi}{4}$; therefore $x = x' \cos \alpha - y' \sin \alpha$,

$$y = x' \sin \alpha + y' \cos \alpha \Rightarrow x = \frac{\sqrt{2}}{2}x' - \frac{\sqrt{2}}{2}y', y = \frac{\sqrt{2}}{2}x' + \frac{\sqrt{2}}{2}y'$$

$$\Rightarrow \left(\frac{\sqrt{2}}{2}x' - \frac{\sqrt{2}}{2}y'\right)\left(\frac{\sqrt{2}}{2}x' + \frac{\sqrt{2}}{2}y'\right) - \left(\frac{\sqrt{2}}{2}x' + \frac{\sqrt{2}}{2}y'\right) - \left(\frac{\sqrt{2}}{2}x' - \frac{\sqrt{2}}{2}y'\right) + 1 = 0 \Rightarrow x'^2 - y'^2 - 2\sqrt{2}x' + 2 = 0 \Rightarrow \text{Hyperbola}$$

25. $\cot 2\alpha = \frac{A-C}{B} = \frac{3-3}{2} = 0 \Rightarrow 2\alpha = \frac{\pi}{2} \Rightarrow \alpha = \frac{\pi}{4}$; therefore $x = x' \cos \alpha - y' \sin \alpha$,

$$y = x' \sin \alpha + y' \cos \alpha \Rightarrow x = \frac{\sqrt{2}}{2}x' - \frac{\sqrt{2}}{2}y', y = \frac{\sqrt{2}}{2}x' + \frac{\sqrt{2}}{2}y'$$

$$\Rightarrow 3\left(\frac{\sqrt{2}}{2}x' - \frac{\sqrt{2}}{2}y'\right)^2 + 2\left(\frac{\sqrt{2}}{2}x' - \frac{\sqrt{2}}{2}y'\right)\left(\frac{\sqrt{2}}{2}x' + \frac{\sqrt{2}}{2}y'\right) + 3\left(\frac{\sqrt{2}}{2}x' + \frac{\sqrt{2}}{2}y'\right)^2 = 19 \Rightarrow 4x'^2 + 2y'^2 = 19 \Rightarrow \text{Ellipse}$$

26. $\cot 2\alpha = \frac{A-C}{B} = \frac{3-(-1)}{4\sqrt{3}} = \frac{1}{\sqrt{3}} \Rightarrow 2\alpha = \frac{\pi}{3} \Rightarrow \alpha = \frac{\pi}{6}$; therefore $x = x' \cos \alpha - y' \sin \alpha$,

$$y = x' \sin \alpha + y' \cos \alpha \Rightarrow x = \frac{\sqrt{3}}{2}x' - \frac{1}{2}y', y = \frac{1}{2}x' + \frac{\sqrt{3}}{2}y'$$

$$\Rightarrow 3\left(\frac{\sqrt{3}}{2}x' - \frac{1}{2}y'\right)^2 + 4\sqrt{3}\left(\frac{\sqrt{3}}{2}x' - \frac{1}{2}y'\right)\left(\frac{1}{2}x' + \frac{\sqrt{3}}{2}y'\right) - \left(\frac{1}{2}x' + \frac{\sqrt{3}}{2}y'\right)^2 = 7 \Rightarrow 5x'^2 - 3y'^2 = 7 \Rightarrow \text{Hyperbola}$$

27. $\cot 2\alpha = \frac{14-2}{16} = \frac{3}{4} \Rightarrow \cos 2\alpha = \frac{3}{5}$ (if we choose 2α in Quadrant I); thus $\sin \alpha = \sqrt{\frac{1-\cos 2\alpha}{2}} = \sqrt{\frac{1-\frac{3}{5}}{2}} = \frac{1}{\sqrt{5}}$

and $\cos \alpha = \sqrt{\frac{1+\cos 2\alpha}{2}} = \sqrt{\frac{1+\frac{3}{5}}{2}} = \frac{2}{\sqrt{5}}$ (or $\sin \alpha = \frac{2}{\sqrt{5}}$ and $\cos \alpha = \frac{-1}{\sqrt{5}}$)

28. $\cot 2\alpha = \frac{A-C}{B} = \frac{4-1}{-4} = -\frac{3}{4} \Rightarrow \cos 2\alpha = -\frac{3}{5}$ (if we choose 2α in Quadrant II); thus $\sin \alpha = \sqrt{\frac{1-\cos 2\alpha}{2}}$

$$= \sqrt{\frac{1-(-\frac{3}{5})}{2}} = \frac{2}{\sqrt{5}} \text{ and } \cos \alpha = \sqrt{\frac{1+\cos 2\alpha}{2}} = \sqrt{\frac{1+(-\frac{3}{5})}{2}} = \frac{1}{\sqrt{5}} \text{ (or } \sin \alpha = \frac{1}{\sqrt{5}} \text{ and } \cos \alpha = \frac{-2}{\sqrt{5}})$$

29. $\tan 2\alpha = \frac{-1}{1-3} = \frac{1}{2} \Rightarrow 2\alpha \approx 26.57^\circ \Rightarrow \alpha \approx 13.28^\circ \Rightarrow \sin \alpha \approx 0.23, \cos \alpha \approx 0.97$; then $A' \approx 0.9, B' \approx 0.0, C' \approx 3.1, D' \approx 0.7, E' \approx -1.2$, and $F' = -3 \Rightarrow 0.9x'^2 + 3.1y'^2 + 0.7x' - 1.2y' - 3 = 0$, an ellipse

30. $\tan 2\alpha = \frac{1}{2-(-3)} = \frac{1}{5} \Rightarrow 2\alpha \approx 11.31^\circ \Rightarrow \alpha \approx 5.65^\circ \Rightarrow \sin \alpha \approx 0.10, \cos \alpha \approx 1.00$; then $A' \approx 2.1, B' \approx 0.0, C' \approx -3.1, D' \approx 3.0, E' \approx -0.3$, and $F' = -7 \Rightarrow 2.1x'^2 - 3.1y'^2 + 3.0x' - 0.3y' - 7 = 0$, a hyperbola

31. $\tan 2\alpha = \frac{-4}{1-4} = \frac{4}{3} \Rightarrow 2\alpha \approx 53.13^\circ \Rightarrow \alpha \approx 26.57^\circ \Rightarrow \sin \alpha \approx 0.45, \cos \alpha \approx 0.89$; then $A' \approx 0.0, B' \approx 0.0, C' \approx 5.0, D' \approx 0, E' \approx 0$, and $F' = -5 \Rightarrow 5.0y'^2 - 5 = 0$ or $y' = \pm 1.0$, parallel lines

32. $\tan 2\alpha = \frac{-12}{2-18} = \frac{3}{4} \Rightarrow 2\alpha \approx 36.87^\circ \Rightarrow \alpha \approx 18.43^\circ \Rightarrow \sin \alpha \approx 0.32, \cos \alpha \approx 0.95$; then $A' \approx 0.0, B' \approx 0.0, C' \approx 20.1, D' \approx 0, E' \approx 0$, and $F' = -49 \Rightarrow 20.1y'^2 - 49 = 0$, parallel lines

33. $\tan 2\alpha = \frac{5}{3-2} = 5 \Rightarrow 2\alpha \approx 78.69^\circ \Rightarrow \alpha \approx 39.35^\circ \Rightarrow \sin \alpha \approx 0.63, \cos \alpha \approx 0.77$; then $A' \approx 5.0, B' \approx 0.0, C' \approx -0.05, D' \approx -5.0, E' \approx -6.2$, and $F' = -1 \Rightarrow 5.0x'^2 - 0.05y'^2 - 5.0x' - 6.2y' - 1 = 0$, a hyperbola

34. $\tan 2\alpha = \frac{7}{2-9} = -1 \Rightarrow 2\alpha \approx -45.00^\circ \Rightarrow \alpha \approx -22.5^\circ \Rightarrow \sin \alpha \approx -0.38, \cos \alpha \approx 0.92$; then $A' \approx 0.5, B' \approx 0.0, C' \approx 10.4, D' \approx 18.4, E' \approx 7.6$, and $F' = -86 \Rightarrow 0.5x'^2 + 10.4(y')^2 + 18.4x' + 7.6y' - 86 = 0$, an ellipse

35. $\alpha = 90^\circ \Rightarrow x = x' \cos 90^\circ - y' \sin 90^\circ = -y'$ and $y = x' \sin 90^\circ + y' \cos 90^\circ = x'$

(a) $\frac{x'^2}{b^2} + \frac{y'^2}{a^2} = 1$

(b) $\frac{y'^2}{a^2} - \frac{x'^2}{b^2} = 1$

(c) $x'^2 + y'^2 = a^2$

(d) $y = mx \Rightarrow y - mx = 0 \Rightarrow D = -m$ and $E = 1$; $\alpha = 90^\circ \Rightarrow D' = 1$ and $E' = m \Rightarrow my' + x' = 0 \Rightarrow y' = -\frac{1}{m}x'$

(e) $y = mx + b \Rightarrow y - mx - b = 0 \Rightarrow D = -m$ and $E = 1$; $\alpha = 90^\circ \Rightarrow D' = 1, E' = m$ and $F' = -b \Rightarrow my' + x' - b = 0 \Rightarrow y' = -\frac{1}{m}x' + \frac{b}{m}$

$$36. \alpha = 180^\circ \Rightarrow x = x' \cos 180^\circ - y' \sin 180^\circ = -x' \text{ and } y = x' \sin 180^\circ + y' \cos 180^\circ = -y'$$

$$(a) \frac{x'^2}{a^2} + \frac{y'^2}{b^2} = 1$$

$$(b) \frac{x'^2}{a^2} - \frac{y'^2}{b^2} = 1$$

$$(c) x'^2 + y'^2 = a^2$$

$$(d) y = mx \Rightarrow y - mx = 0 \Rightarrow D = -m \text{ and } E = 1; \alpha = 180^\circ \Rightarrow D' = m \text{ and } E' = -1 \Rightarrow -y' + mx' = 0 \Rightarrow y' = mx'$$

$$(e) y = mx + b \Rightarrow y - mx - b = 0 \Rightarrow D = -m \text{ and } E = 1; \alpha = 180^\circ \Rightarrow D' = m, E' = -1 \text{ and } F' = -b \Rightarrow -y' + mx' - b = 0 \Rightarrow y' = mx' - b$$

$$37. (a) A' = \cos 45^\circ \sin 45^\circ = \left(\frac{\sqrt{2}}{2}\right) \left(\frac{\sqrt{2}}{2}\right) = \frac{1}{2}, B' = 0, C' = -\cos 45^\circ \sin 45^\circ = -\frac{1}{2}, F' = -1$$

$$\Rightarrow \frac{1}{2}x'^2 - \frac{1}{2}y'^2 = 1 \Rightarrow x'^2 - y'^2 = 2$$

$$(b) A' = \frac{1}{2}, C' = -\frac{1}{2} \text{ (see part (a) above), } D' = E' = B' = 0, F' = -a \Rightarrow \frac{1}{2}x'^2 - \frac{1}{2}y'^2 = a \Rightarrow x'^2 - y'^2 = 2a$$

$$38. xy = 2 \Rightarrow x'^2 - y'^2 = 4 \Rightarrow \frac{x'^2}{4} - \frac{y'^2}{4} = 1 \text{ (see Exercise 37(b)) } \Rightarrow a = 2 \text{ and } b = 2 \Rightarrow c = \sqrt{4+4} = 2\sqrt{2}$$

$$\Rightarrow e = \frac{c}{a} = \frac{2\sqrt{2}}{2} = \sqrt{2}$$

39. Yes, the graph is a hyperbola: with $AC < 0$ we have $-4AC > 0$ and $B^2 - 4AC > 0$.

40. The one curve that meets all three of the stated criteria is the ellipse $x^2 + 4xy + 5y^2 - 1 = 0$. The reasoning: The symmetry about the origin means that $(-x, -y)$ lies on the graph whenever (x, y) does. Adding $Ax^2 + Bxy + Cy^2 + Dx + Ey + F = 0$ and $A(-x)^2 + B(-x)(-y) + C(-y)^2 + D(-x) + E(-y) + F = 0$ and dividing the result by 2 produces the equivalent equation $Ax^2 + Bxy + Cy^2 + F = 0$. Substituting $x = 1, y = 0$ (because the point $(1, 0)$ lies on the curve) shows further that $A = -F$. Then $-Fx^2 + Bxy + Cy^2 + F = 0$. By implicit differentiation, $-2Fx + By + Bxy' + 2Cyy' = 0$, so substituting $x = -2, y = 1$, and $y' = 0$ (from Property 3) gives $4F + B = 0 \Rightarrow B = -4F \Rightarrow$ the conic is $-Fx^2 - 4Fxy + Cy^2 + F = 0$. Now substituting $x = -2$ and $y = 1$ again gives $-4F + 8F + C + F = 0 \Rightarrow C = -5F \Rightarrow$ the equation is now $-Fx^2 - 4Fxy - 5Fy^2 + F = 0$. Finally, dividing through by $-F$ gives the equation $x^2 + 4xy + 5y^2 - 1 = 0$.

41. Let α be any angle. Then $A' = \cos^2 \alpha + \sin^2 \alpha = 1, B' = 0, C' = \sin^2 \alpha + \cos^2 \alpha = 1, D' = E' = 0$ and $F' = -a^2 \Rightarrow x'^2 + y'^2 = a^2$.

42. If $A = C$, then $B' = B \cos 2\alpha + (C - A) \sin 2\alpha = B \cos 2\alpha$. Then $\alpha = \frac{\pi}{4} \Rightarrow 2\alpha = \frac{\pi}{2} \Rightarrow B' = B \cos \frac{\pi}{2} = 0$ so the xy -term is eliminated.

43. (a) $B^2 - 4AC = 4^2 - 4(1)(4) = 0$, so the discriminant indicates this conic is a parabola

(b) The left-hand side of $x^2 + 4xy + 4y^2 + 6x + 12y + 9 = 0$ factors as a perfect square: $(x + 2y + 3)^2 = 0 \Rightarrow x + 2y + 3 = 0 \Rightarrow 2y = -x - 3$; thus the curve is a degenerate parabola (i.e., a straight line).

44. (a) $B^2 - 4AC = 6^2 - 4(9)(1) = 0$, so the discriminant indicates this conic is a parabola

(b) The left-hand side of $9x^2 + 6xy + y^2 - 12x - 4y + 4 = 0$ factors as a perfect square: $(3x + y - 2)^2 = 0 \Rightarrow 3x + y - 2 = 0 \Rightarrow y = -3x + 2$; thus the curve is a degenerate parabola (i.e., a straight line).

45. (a) $B^2 - 4AC = 1 - 4(0)(0) = 1 \Rightarrow$ hyperbola
 (b) $xy + 2x - y = 0 \Rightarrow y(x - 1) = -2x \Rightarrow y = \frac{-2x}{x-1}$
 (c) $y = \frac{-2x}{x-1} \Rightarrow \frac{dy}{dx} = \frac{2}{(x-1)^2}$ and we want $\left(\frac{dy}{dx}\right)^{-1} = -2$,
 the slope of $y = -2x \Rightarrow -2 = -\frac{(x-1)^2}{2}$
 $\Rightarrow (x-1)^2 = 4 \Rightarrow x = 3$ or $x = -1$; $x = 3$
 $\Rightarrow y = -3 \Rightarrow (3, -3)$ is a point on the hyperbola
 where the line with slope $m = -2$ is normal
 \Rightarrow the line is $y + 3 = -2(x - 3)$ or $y = -2x + 3$;
 $x = -1 \Rightarrow y = -1 \Rightarrow (-1, -1)$ is a point on the
 hyperbola where the line with slope $m = -2$ is
 normal \Rightarrow the line is $y + 1 = -2(x + 1)$ or
 $y = -2x - 3$

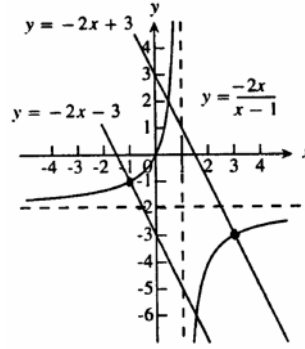

46. (a) False: let $A = C = 1, B = 2 \Rightarrow B^2 - 4AC = 0 \Rightarrow$ parabola
 (b) False: see part (a) above
 (c) True: $AC < 0 \Rightarrow -4AC > 0 \Rightarrow B^2 - 4AC > 0 \Rightarrow$ hyperbola
47. Assume the ellipse has been rotated to eliminate the xy -term \Rightarrow the new equation is $A'x'^2 + C'y'^2 = 1 \Rightarrow$ the semi-axes are $\sqrt{\frac{1}{A'}}$ and $\sqrt{\frac{1}{C'}}$ \Rightarrow the area is $\pi \left(\sqrt{\frac{1}{A'}}\right) \left(\sqrt{\frac{1}{C'}}\right) = \frac{\pi}{\sqrt{A'C'}} = \frac{2\pi}{\sqrt{4A'C'}}$. Since $B^2 - 4AC = B'^2 - 4A'C' = -4A'C'$ (because $B' = 0$) we find that the area is $\frac{2\pi}{\sqrt{4AC - B^2}}$ as claimed.
48. (a) $A' + C' = (A \cos^2 \alpha + B \cos \alpha \sin \alpha + C \sin^2 \alpha) + (A \sin^2 \alpha - B \cos \alpha \sin \alpha + C \cos^2 \alpha)$
 $= A(\cos^2 \alpha + \sin^2 \alpha) + C(\sin^2 \alpha + \cos^2 \alpha) = A + C$
 (b) $D'^2 + E'^2 = (D \cos \alpha + E \sin \alpha)^2 + (-D \sin \alpha + E \cos \alpha)^2 = D^2 \cos^2 \alpha + 2DE \cos \alpha \sin \alpha + E^2 \sin^2 \alpha$
 $+ D^2 \sin^2 \alpha - 2DE \sin \alpha \cos \alpha + E^2 \cos^2 \alpha = D^2(\cos^2 \alpha + \sin^2 \alpha) + E^2(\sin^2 \alpha + \cos^2 \alpha) = D^2 + E^2$
49. $B'^2 - 4A'C'$
 $= (B \cos 2\alpha + (C - A) \sin 2\alpha)^2 - 4(A \cos^2 \alpha + B \cos \alpha \sin \alpha + C \sin^2 \alpha)(A \sin^2 \alpha - B \cos \alpha \sin \alpha + C \cos^2 \alpha)$
 $= B^2 \cos^2 2\alpha + 2B(C - A) \sin 2\alpha \cos 2\alpha + (C - A)^2 \sin^2 2\alpha - 4A^2 \cos^2 \alpha \sin^2 \alpha + 4AB \cos^3 \alpha \sin \alpha$
 $- 4AC \cos^4 \alpha - 4AB \cos \alpha \sin^3 \alpha + 4B^2 \cos^2 \alpha \sin^2 \alpha - 4BC \cos^3 \alpha \sin \alpha - 4AC \sin^4 \alpha + 4BC \cos \alpha \sin^3 \alpha$
 $- 4C^2 \cos^2 \alpha \sin^2 \alpha$
 $= B^2 \cos^2 2\alpha + 2BC \sin 2\alpha \cos 2\alpha - 2AB \sin 2\alpha \cos 2\alpha + C^2 \sin^2 2\alpha - 2AC \sin^2 2\alpha + A^2 \sin^2 2\alpha$
 $- 4A^2 \cos^2 \alpha \sin^2 \alpha + 4AB \cos^3 \alpha \sin \alpha - 4AC \cos^4 \alpha - 4AB \cos \alpha \sin^3 \alpha + B^2 \sin^2 2\alpha - 4BC \cos^3 \alpha \sin \alpha$
 $- 4AC \sin^4 \alpha + 4BC \cos \alpha \sin^3 \alpha - 4C^2 \cos^2 \alpha \sin^2 \alpha$
 $= B^2 + 2BC(2 \sin \alpha \cos \alpha)(\cos^2 \alpha - \sin^2 \alpha) - 2AB(2 \sin \alpha \cos \alpha)(\cos^2 \alpha - \sin^2 \alpha) + C^2(4 \sin^2 \alpha \cos^2 \alpha)$
 $- 2AC(4 \sin^2 \alpha \cos^2 \alpha) + A^2(4 \sin^2 \alpha \cos^2 \alpha) - 4A^2 \cos^2 \alpha \sin^2 \alpha + 4AB \cos^3 \alpha \sin \alpha - 4AC \cos^4 \alpha$
 $- 4AB \cos \alpha \sin^3 \alpha - 4BC \cos^3 \alpha \sin \alpha - 4AC \sin^4 \alpha + 4BC \cos \alpha \sin^3 \alpha - 4C^2 \cos^2 \alpha \sin^2 \alpha$
 $= B^2 - 8AC \sin^2 \alpha \cos^2 \alpha - 4AC \cos^4 \alpha - 4AC \sin^4 \alpha$
 $= B^2 - 4AC(\cos^4 \alpha + 2 \sin^2 \alpha \cos^2 \alpha + \sin^4 \alpha)$
 $= B^2 - 4AC(\cos^2 \alpha + \sin^2 \alpha)^2$
 $= B^2 - 4AC$

10.4 CONICS AND PARAMETRIC EQUATIONS; THE CYCLOID

1. $x = \cos t, y = \sin t, 0 \leq t \leq \pi$
 $\Rightarrow \cos^2 t + \sin^2 t = 1 \Rightarrow x^2 + y^2 = 1$

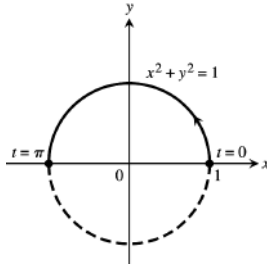

2. $x = \sin(2\pi(1-t)), y = \cos(2\pi(1-t)), 0 \leq t \leq 1$
 $\Rightarrow \sin^2(2\pi(1-t)) + \cos^2(2\pi(1-t)) = 1$
 $\Rightarrow x^2 + y^2 = 1$

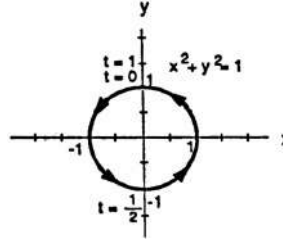

3. $x = 4 \cos t, y = 5 \sin t, 0 \leq t \leq \pi$
 $\Rightarrow \frac{16 \cos^2 t}{16} + \frac{25 \sin^2 t}{25} = 1 \Rightarrow \frac{x^2}{16} + \frac{y^2}{25} = 1$

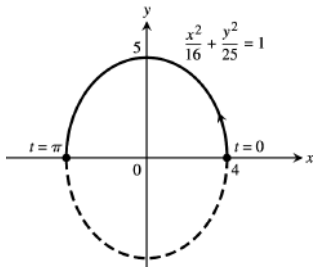

4. $x = 4 \sin t, y = 5 \cos t, 0 \leq t \leq 2\pi$
 $\Rightarrow \frac{16 \sin^2 t}{16} + \frac{25 \cos^2 t}{25} = 1 \Rightarrow \frac{x^2}{16} + \frac{y^2}{25} = 1$

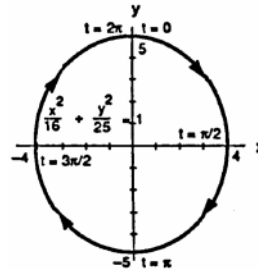

5. $x = t, y = \sqrt{t}, t \geq 0 \Rightarrow y = \sqrt{x}$

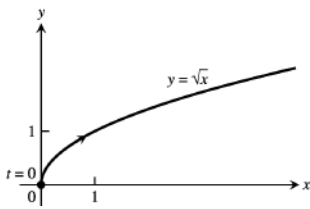

6. $x = \sec^2 t - 1, y = \tan t, -\frac{\pi}{2} < t < \frac{\pi}{2}$
 $\Rightarrow \sec^2 t - 1 = \tan^2 t \Rightarrow x = y^2$

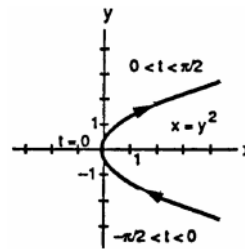

7. $x = -\sec t, y = \tan t, -\frac{\pi}{2} < t < \frac{\pi}{2}$
 $\Rightarrow \sec^2 t - \tan^2 t = 1 \Rightarrow x^2 - y^2 = 1$

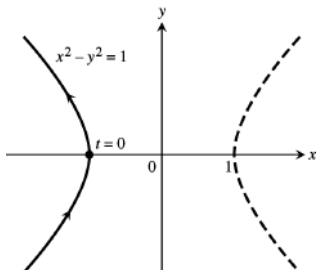

8. $x = \csc t, y = \cot t, 0 < t < \pi$
 $\Rightarrow 1 + \cot^2 t = \csc^2 t \Rightarrow 1 + y^2 = x^2 \Rightarrow x^2 - y^2 = 1$

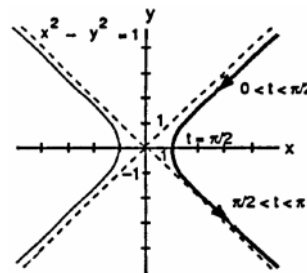

9. $x = t, y = \sqrt{4 - t^2}, 0 \leq t \leq 2$
 $\Rightarrow y = \sqrt{4 - x^2}$

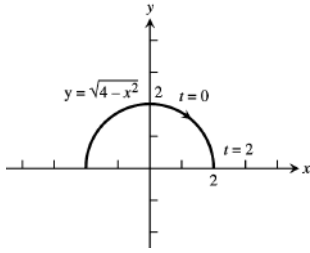

10. $x = t^2, y = \sqrt{t^4 + 1}, t \geq 0$
 $\Rightarrow y = \sqrt{x^2 + 1}, x \geq 0$

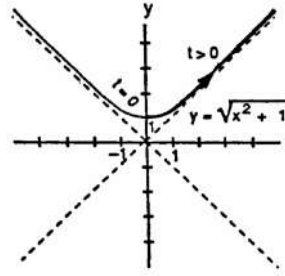

11. $x = -\cosh t, y = \sinh t, -\infty < t < \infty$
 $\Rightarrow \cosh^2 t - \sinh^2 t = 1 \Rightarrow x^2 - y^2 = 1$

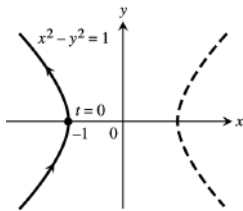

12. $x = 2 \sinh t, y = 2 \cosh t, -\infty < t < \infty$
 $\Rightarrow 4 \cosh^2 t - 4 \sinh^2 t = 4 \Rightarrow y^2 - x^2 = 4$

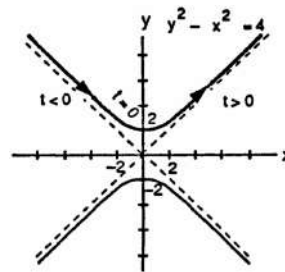

13. Arc PF = Arc AF since each is the distance rolled and $\frac{\text{Arc PF}}{b} = \angle FCP \Rightarrow \text{Arc PF} = b(\angle FCP)$; $\frac{\text{Arc AF}}{a} = \theta \Rightarrow \text{Arc AF} = a\theta \Rightarrow a\theta = b(\angle FCP) \Rightarrow \angle FCP = \frac{a}{b}\theta$; $\angle OCG = \frac{\pi}{2} - \theta$; $\angle OCG = \angle OCP + \angle PCE = \angle OCP + (\frac{\pi}{2} - \alpha)$. Now $\angle OCP = \pi - \angle FCP = \pi - \frac{a}{b}\theta$. Thus $\angle OCG = \pi - \frac{a}{b}\theta + \frac{\pi}{2} - \alpha \Rightarrow \frac{\pi}{2} - \theta = \pi - \frac{a}{b}\theta + \frac{\pi}{2} - \alpha \Rightarrow \alpha = \pi - \frac{a}{b}\theta + \theta = \pi - (\frac{a-b}{b})\theta$.

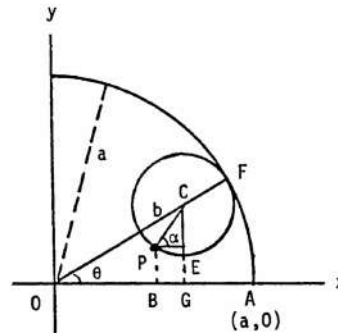

Then $x = \text{OG} - \text{BG} = \text{OG} - \text{PE} = (a - b) \cos \theta - b \cos \alpha = (a - b) \cos \theta - b \cos (\pi - \frac{a-b}{b}\theta)$
 $= (a - b) \cos \theta + b \cos (\frac{a-b}{b}\theta)$. Also $y = \text{EG} = \text{CG} - \text{CE} = (a - b) \sin \theta - b \sin \alpha$
 $= (a - b) \sin \theta - b \sin (\pi - \frac{a-b}{b}\theta) = (a - b) \sin \theta - b \sin (\frac{a-b}{b}\theta)$. Therefore
 $x = (a - b) \cos \theta + b \cos (\frac{a-b}{b}\theta)$ and $y = (a - b) \sin \theta - b \sin (\frac{a-b}{b}\theta)$.

If $b = \frac{a}{4}$, then $x = (a - \frac{a}{4}) \cos \theta + \frac{a}{4} \cos (\frac{a - (\frac{a}{4})}{(\frac{a}{4})}\theta)$
 $= \frac{3a}{4} \cos \theta + \frac{a}{4} \cos 3\theta = \frac{3a}{4} \cos \theta + \frac{a}{4} (\cos \theta \cos 2\theta - \sin \theta \sin 2\theta)$
 $= \frac{3a}{4} \cos \theta + \frac{a}{4} ((\cos \theta)(\cos^2 \theta - \sin^2 \theta) - (\sin \theta)(2 \sin \theta \cos \theta))$
 $= \frac{3a}{4} \cos \theta + \frac{a}{4} \cos^3 \theta - \frac{a}{4} \cos \theta \sin^2 \theta - \frac{2a}{4} \sin^2 \theta \cos \theta$
 $= \frac{3a}{4} \cos \theta + \frac{a}{4} \cos^3 \theta - \frac{3a}{4} (\cos \theta)(1 - \cos^2 \theta) = a \cos^3 \theta$;
 $y = (a - \frac{a}{4}) \sin \theta - \frac{a}{4} \sin (\frac{a - (\frac{a}{4})}{(\frac{a}{4})}\theta) = \frac{3a}{4} \sin \theta - \frac{a}{4} \sin 3\theta = \frac{3a}{4} \sin \theta - \frac{a}{4} (\sin \theta \cos 2\theta + \cos \theta \sin 2\theta)$
 $= \frac{3a}{4} \sin \theta - \frac{a}{4} ((\sin \theta)(\cos^2 \theta - \sin^2 \theta) + (\cos \theta)(2 \sin \theta \cos \theta))$
 $= \frac{3a}{4} \sin \theta - \frac{a}{4} \sin \theta \cos^2 \theta + \frac{a}{4} \sin^3 \theta - \frac{2a}{4} \cos^2 \theta \sin \theta$
 $= \frac{3a}{4} \sin \theta - \frac{3a}{4} \sin \theta \cos^2 \theta + \frac{a}{4} \sin^3 \theta$
 $= \frac{3a}{4} \sin \theta - \frac{3a}{4} (\sin \theta)(1 - \sin^2 \theta) + \frac{a}{4} \sin^3 \theta = a \sin^3 \theta$.

14. P traces a hypocycloid where the larger radius is $2a$ and the smaller is $a \Rightarrow x = (2a - a) \cos \theta + a \cos \left(\frac{2a-a}{a} \theta\right) = 2a \cos \theta, 0 \leq \theta \leq 2\pi$, and $y = (2a - a) \sin \theta - a \sin \left(\frac{2a-a}{a} \theta\right) = a \sin \theta - a \sin \theta = 0$. Therefore P traces the diameter of the circle back and forth as θ goes from 0 to 2π .

15. Draw line AM in the figure and note that $\angle AMO$ is a right angle since it is an inscribed angle which spans the diameter of a circle. Then $AN^2 = MN^2 + AM^2$. Now, $OA = a$, $\frac{AN}{a} = \tan t$, and $\frac{AM}{a} = \sin t$. Next $MN = OP \Rightarrow OP^2 = AN^2 - AM^2 = a^2 \tan^2 t - a^2 \sin^2 t \Rightarrow OP = \sqrt{a^2 \tan^2 t - a^2 \sin^2 t} = (a \sin t) \sqrt{\sec^2 t - 1} = \frac{a \sin^2 t}{\cos t}$. In triangle BPO, $x = OP \sin t = \frac{a \sin^2 t}{\cos t} \sin t = a \sin^2 t \tan t$ and $y = OP \cos t = a \sin^2 t \Rightarrow x = a \sin^2 t \tan t$ and $y = a \sin^2 t$.

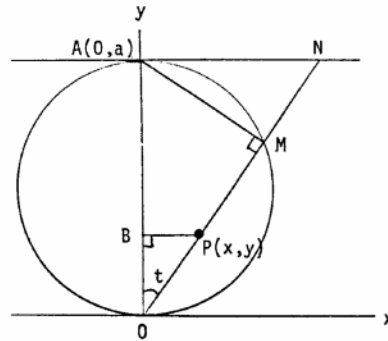

16. Let the x-axis be the line the wheel rolls along with the y-axis through a low point of the trochoid (see the accompanying figure).

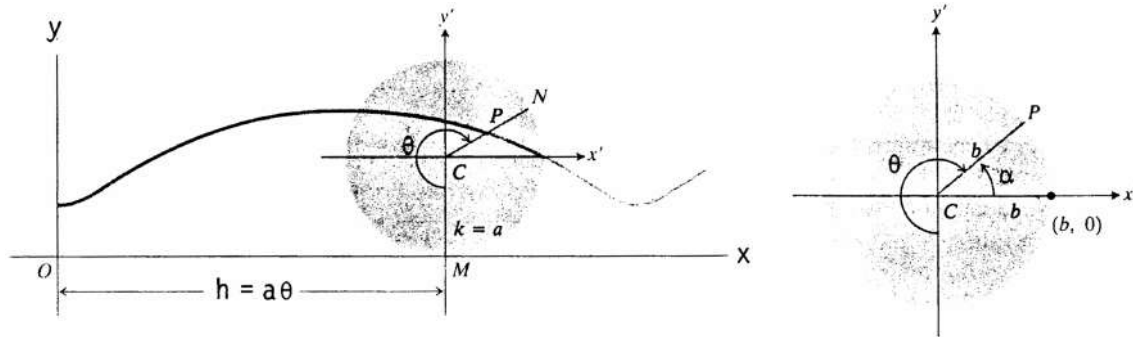

Let θ denote the angle through which the wheel turns. Then $h = a\theta$ and $k = a$. Next introduce $x'y'$ -axes parallel to the xy -axes and having their origin at the center C of the wheel. Then $x' = b \cos \alpha$ and $y' = b \sin \alpha$, where $\alpha = \frac{3\pi}{2} - \theta$. It follows that $x' = b \cos \left(\frac{3\pi}{2} - \theta\right) = -b \sin \theta$ and $y' = b \sin \left(\frac{3\pi}{2} - \theta\right) = -b \cos \theta \Rightarrow x = h + x' = a\theta - b \sin \theta$ and $y = k + y' = a - b \cos \theta$ are parametric equations of the trochoid.

17. $D = \sqrt{(x - 2)^2 + (y - \frac{1}{2})^2} \Rightarrow D^2 = (x - 2)^2 + (y - \frac{1}{2})^2 = (t - 2)^2 + (t^2 - \frac{1}{2})^2 \Rightarrow D^2 = t^4 - 4t + \frac{17}{4} \Rightarrow \frac{d(D^2)}{dt} = 4t^3 - 4 = 0 \Rightarrow t = 1$. The second derivative is always positive for $t \neq 0 \Rightarrow t = 1$ gives a local minimum for D^2 (and hence D) which is an absolute minimum since it is the only extremum \Rightarrow the closest point on the parabola is $(1, 1)$.

18. $D = \sqrt{\left(2 \cos t - \frac{3}{4}\right)^2 + (\sin t - 0)^2} \Rightarrow D^2 = \left(2 \cos t - \frac{3}{4}\right)^2 + \sin^2 t \Rightarrow \frac{d(D^2)}{dt} = 2 \left(2 \cos t - \frac{3}{4}\right) (-2 \sin t) + 2 \sin t \cos t = (-2 \sin t) \left(3 \cos t - \frac{3}{2}\right) = 0 \Rightarrow -2 \sin t = 0$ or $3 \cos t - \frac{3}{2} = 0 \Rightarrow t = 0, \pi$ or $t = \frac{\pi}{3}, \frac{5\pi}{3}$. Now $\frac{d^2(D^2)}{dt^2} = -6 \cos^2 t + 3 \cos t + 6 \sin^2 t$ so that $\frac{d^2(D^2)}{dt^2}(0) = -3 \Rightarrow$ relative maximum, $\frac{d^2(D^2)}{dt^2}(\pi) = -9 \Rightarrow$ relative maximum, $\frac{d^2(D^2)}{dt^2}\left(\frac{\pi}{3}\right) = \frac{9}{2} \Rightarrow$ relative minimum, and $\frac{d^2(D^2)}{dt^2}\left(\frac{5\pi}{3}\right) = \frac{9}{2} \Rightarrow$ relative minimum. Therefore both $t = \frac{\pi}{3}$ and $t = \frac{5\pi}{3}$ give points on the ellipse closest to the point $\left(\frac{3}{4}, 0\right) \Rightarrow \left(1, \frac{\sqrt{3}}{2}\right)$ and $\left(1, -\frac{\sqrt{3}}{2}\right)$ are the desired points.

19. (a)

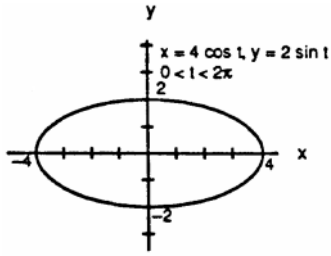

(b)

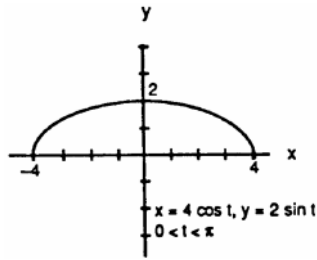

(c)

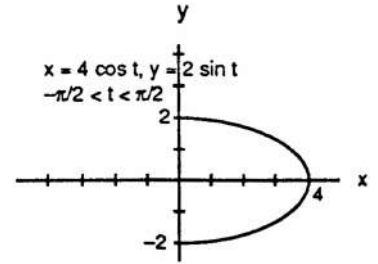

20. (a)

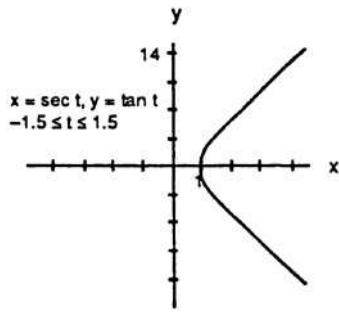

(b)

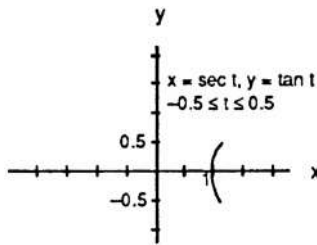

(c)

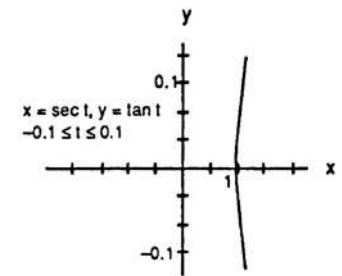

21.

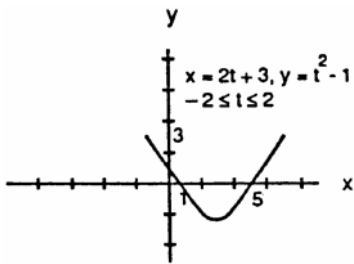

22. (a)

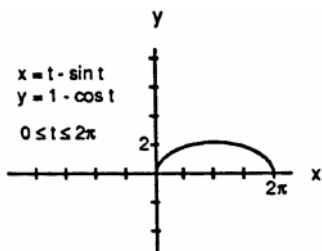

(b)

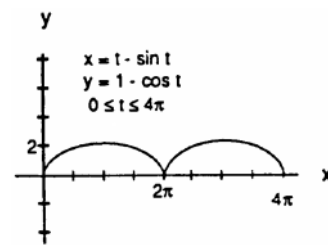

(c)

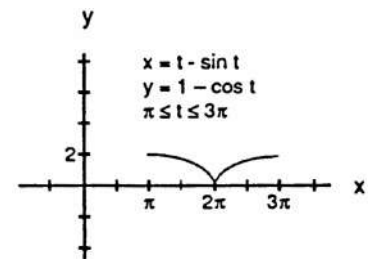

23. (a)

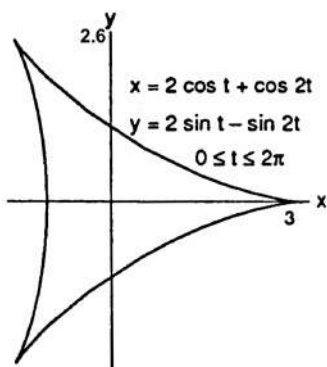

(b)

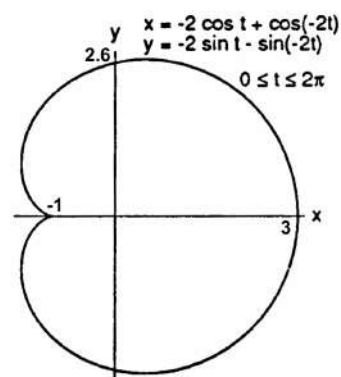

24. (a)

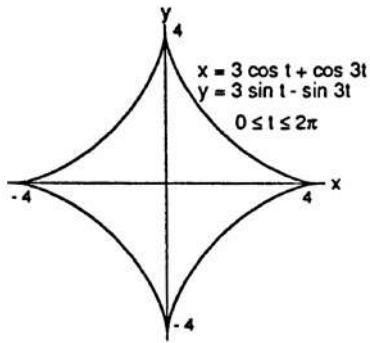

(b)

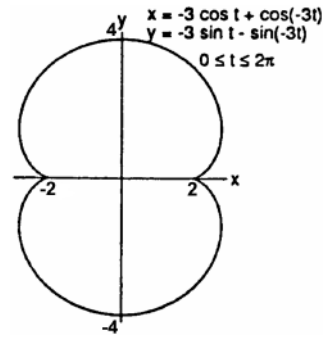

25. (a)

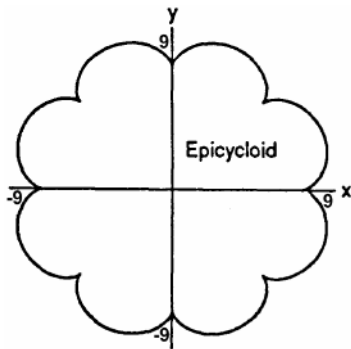

(b)

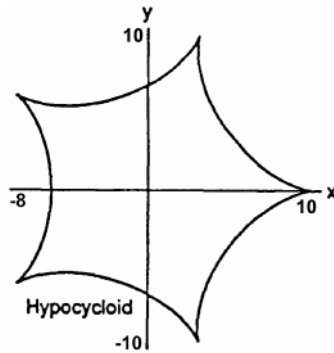

(c)

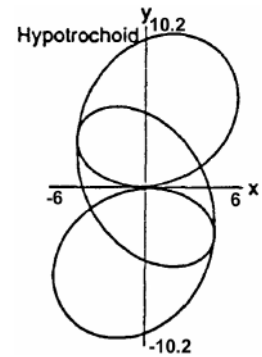

26. (a)

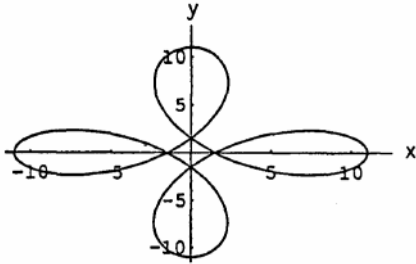

$x = 6 \cos t + 5 \cos 3t, \quad y = 6 \sin t - 5 \sin 3t,$
 $0 \leq t \leq 2\pi$

(b)

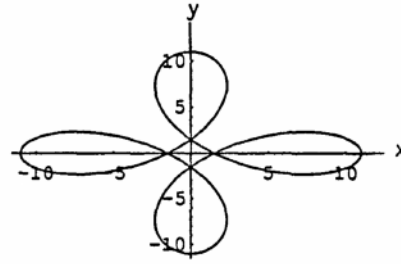

$x = 6 \cos 2t + 5 \cos 6t, \quad y = 6 \sin 2t - 5 \sin 6t,$
 $0 \leq t \leq \pi$

(c)

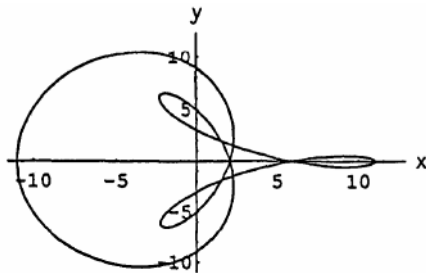

$x = 6 \cos t + 5 \cos 3t, \quad y = 6 \sin 2t - 5 \sin 3t,$
 $0 \leq t \leq 2\pi$

(d)

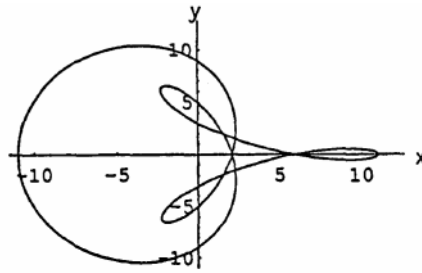

$x = 6 \cos 2t + 5 \cos 6t, \quad y = 6 \sin 4t - 5 \sin 6t,$
 $0 \leq t \leq \pi$

10.5 POLAR COORDINATES

1. a, e; b, g; c, h; d, f

2. a, f; b, h; c, g; d, e

3. (a) $(2, \frac{\pi}{2} + 2n\pi)$ and $(-2, \frac{\pi}{2} + (2n + 1)\pi)$, n an integer
 (b) $(2, 2n\pi)$ and $(-2, (2n + 1)\pi)$, n an integer
 (c) $(2, \frac{3\pi}{2} + 2n\pi)$ and $(-2, \frac{3\pi}{2} + (2n + 1)\pi)$, n an integer
 (d) $(2, (2n + 1)\pi)$ and $(-2, 2n\pi)$, n an integer

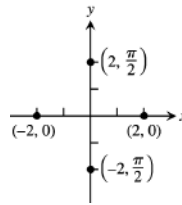

4. (a) $(3, \frac{\pi}{4} + 2n\pi)$ and $(-3, \frac{5\pi}{4} + 2n\pi)$, n an integer
 (b) $(-3, \frac{\pi}{4} + 2n\pi)$ and $(3, \frac{5\pi}{4} + 2n\pi)$, n an integer
 (c) $(3, -\frac{\pi}{4} + 2n\pi)$ and $(-3, \frac{3\pi}{4} + 2n\pi)$, n an integer
 (d) $(-3, -\frac{\pi}{4} + 2n\pi)$ and $(3, \frac{3\pi}{4} + 2n\pi)$, n an integer

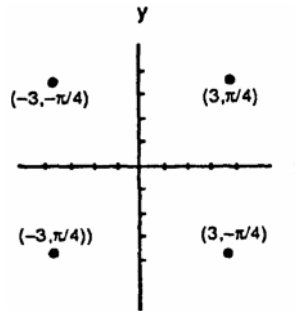

5. (a) $x = r \cos \theta = 3 \cos 0 = 3, y = r \sin \theta = 3 \sin 0 = 0 \Rightarrow$ Cartesian coordinates are $(3, 0)$
 (b) $x = r \cos \theta = -3 \cos 0 = -3, y = r \sin \theta = -3 \sin 0 = 0 \Rightarrow$ Cartesian coordinates are $(-3, 0)$
 (c) $x = r \cos \theta = 2 \cos \frac{2\pi}{3} = -1, y = r \sin \theta = 2 \sin \frac{2\pi}{3} = \sqrt{3} \Rightarrow$ Cartesian coordinates are $(-1, \sqrt{3})$
 (d) $x = r \cos \theta = 2 \cos \frac{7\pi}{3} = 1, y = r \sin \theta = 2 \sin \frac{7\pi}{3} = \sqrt{3} \Rightarrow$ Cartesian coordinates are $(1, \sqrt{3})$
 (e) $x = r \cos \theta = -3 \cos \pi = 3, y = r \sin \theta = -3 \sin \pi = 0 \Rightarrow$ Cartesian coordinates are $(3, 0)$
 (f) $x = r \cos \theta = 2 \cos \frac{\pi}{3} = 1, y = r \sin \theta = 2 \sin \frac{\pi}{3} = \sqrt{3} \Rightarrow$ Cartesian coordinates are $(1, \sqrt{3})$
 (g) $x = r \cos \theta = -3 \cos 2\pi = -3, y = r \sin \theta = -3 \sin 2\pi = 0 \Rightarrow$ Cartesian coordinates are $(-3, 0)$
 (h) $x = r \cos \theta = -2 \cos (-\frac{\pi}{3}) = -1, y = r \sin \theta = -2 \sin (-\frac{\pi}{3}) = \sqrt{3} \Rightarrow$ Cartesian coordinates are $(-1, \sqrt{3})$
6. (a) $x = \sqrt{2} \cos \frac{\pi}{4} = 1, y = \sqrt{2} \sin \frac{\pi}{4} = 1 \Rightarrow$ Cartesian coordinates are $(1, 1)$
 (b) $x = 1 \cos 0 = 1, y = 1 \sin 0 = 0 \Rightarrow$ Cartesian coordinates are $(1, 0)$
 (c) $x = 0 \cos \frac{\pi}{2} = 0, y = 0 \sin \frac{\pi}{2} = 0 \Rightarrow$ Cartesian coordinates are $(0, 0)$
 (d) $x = -\sqrt{2} \cos (\frac{\pi}{4}) = -1, y = -\sqrt{2} \sin (\frac{\pi}{4}) = -1 \Rightarrow$ Cartesian coordinates are $(-1, -1)$
 (e) $x = -3 \cos \frac{5\pi}{6} = \frac{3\sqrt{3}}{2}, y = -3 \sin \frac{5\pi}{6} = -\frac{3}{2} \Rightarrow$ Cartesian coordinates are $(\frac{3\sqrt{3}}{2}, -\frac{3}{2})$
 (f) $x = 5 \cos (\tan^{-1} \frac{4}{3}) = 3, y = 5 \sin (\tan^{-1} \frac{4}{3}) = 4 \Rightarrow$ Cartesian coordinates are $(3, 4)$
 (g) $x = -1 \cos 7\pi = 1, y = -1 \sin 7\pi = 0 \Rightarrow$ Cartesian coordinates are $(1, 0)$
 (h) $x = 2\sqrt{3} \cos \frac{2\pi}{3} = -\sqrt{3}, y = 2\sqrt{3} \sin \frac{2\pi}{3} = 3 \Rightarrow$ Cartesian coordinates are $(-\sqrt{3}, 3)$

7.

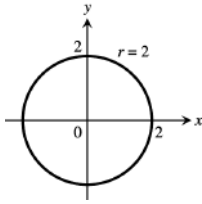

8.

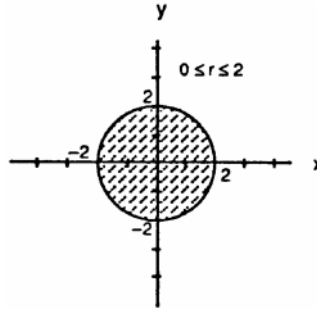

9.

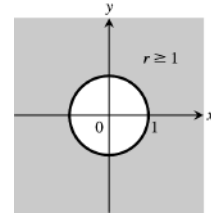

10.

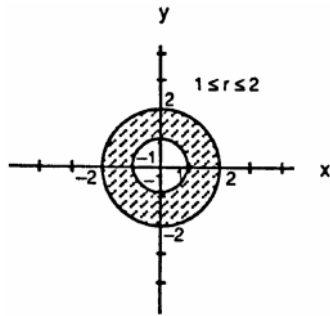

11.

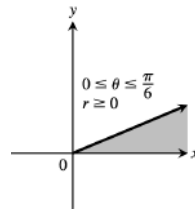

12.

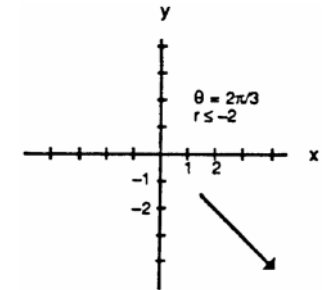

13.

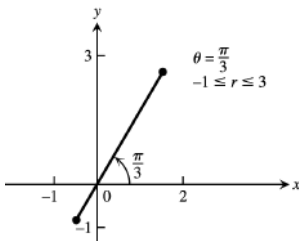

14.

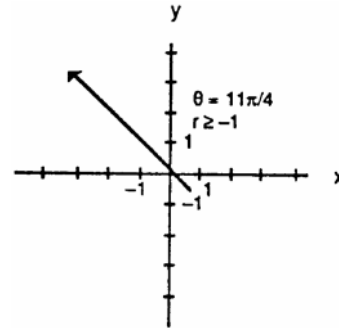

15.

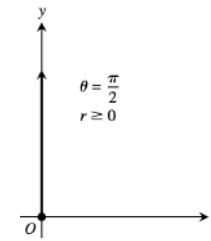

16.

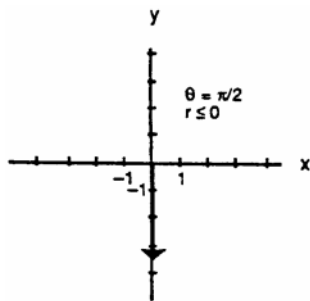

17.

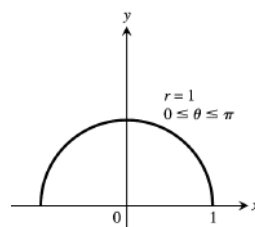

18.

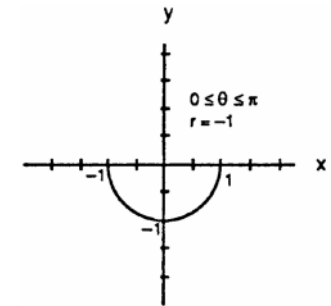

19.

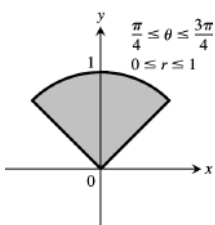

20.

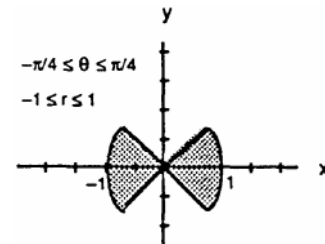

21.

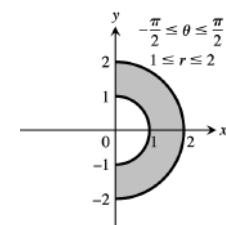

22.

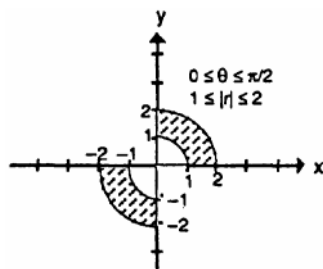

23. $r \cos \theta = 2 \Rightarrow x = 2$, vertical line through $(2, 0)$ 24. $r \sin \theta = -1 \Rightarrow y = -1$, horizontal line through $(0, -1)$
25. $r \sin \theta = 0 \Rightarrow y = 0$, the x-axis 26. $r \cos \theta = 0 \Rightarrow x = 0$, the y-axis
27. $r = 4 \csc \theta \Rightarrow r = \frac{4}{\sin \theta} \Rightarrow r \sin \theta = 4 \Rightarrow y = 4$, a horizontal line through $(0, 4)$
28. $r = -3 \sec \theta \Rightarrow r = \frac{-3}{\cos \theta} \Rightarrow r \cos \theta = -3 \Rightarrow x = -3$, a vertical line through $(-3, 0)$
29. $r \cos \theta + r \sin \theta = 1 \Rightarrow x + y = 1$, line with slope $m = -1$ and intercept $b = 1$
30. $r \sin \theta = r \cos \theta \Rightarrow y = x$, line with slope $m = 1$ and intercept $b = 0$
31. $r^2 = 1 \Rightarrow x^2 + y^2 = 1$, circle with center $C = (0, 0)$ and radius 1
32. $r^2 = 4r \sin \theta \Rightarrow x^2 + y^2 = 4y \Rightarrow x^2 + y^2 - 4y + 4 = 4 \Rightarrow x^2 + (y - 2)^2 = 4$, circle with center $C = (0, 2)$ and radius 2
33. $r = \frac{5}{\sin \theta - 2 \cos \theta} \Rightarrow r \sin \theta - 2r \cos \theta = 5 \Rightarrow y - 2x = 5$, line with slope $m = 2$ and intercept $b = 5$
34. $r^2 \sin 2\theta = 2 \Rightarrow 2r^2 \sin \theta \cos \theta = 2 \Rightarrow (r \sin \theta)(r \cos \theta) = 1 \Rightarrow xy = 1$, hyperbola with focal axis $y = x$
35. $r = \cot \theta \csc \theta = \left(\frac{\cos \theta}{\sin \theta}\right) \left(\frac{1}{\sin \theta}\right) \Rightarrow r \sin^2 \theta = \cos \theta \Rightarrow r^2 \sin^2 \theta = r \cos \theta \Rightarrow y^2 = x$, parabola with vertex $(0, 0)$ which opens to the right
36. $r = 4 \tan \theta \sec \theta \Rightarrow r = 4 \left(\frac{\sin \theta}{\cos^2 \theta}\right) \Rightarrow r \cos^2 \theta = 4 \sin \theta \Rightarrow r^2 \cos^2 \theta = 4r \sin \theta \Rightarrow x^2 = 4y$, parabola with vertex $(0, 0)$ which opens upward
37. $r = (\csc \theta) e^{r \cos \theta} \Rightarrow r \sin \theta = e^{r \cos \theta} \Rightarrow y = e^x$, graph of the natural exponential function
38. $r \sin \theta = \ln r + \ln \cos \theta = \ln(r \cos \theta) \Rightarrow y = \ln x$, graph of the natural logarithm function
39. $r^2 + 2r^2 \cos \theta \sin \theta = 1 \Rightarrow x^2 + y^2 + 2xy = 1 \Rightarrow x^2 + 2xy + y^2 = 1 \Rightarrow (x + y)^2 = 1 \Rightarrow x + y = \pm 1$, two parallel straight lines of slope -1 and y-intercepts $b = \pm 1$
40. $\cos^2 \theta = \sin^2 \theta \Rightarrow r^2 \cos^2 \theta = r^2 \sin^2 \theta \Rightarrow x^2 = y^2 \Rightarrow |x| = |y| \Rightarrow \pm x = y$, two perpendicular lines through the origin with slopes 1 and -1 , respectively.
41. $r^2 = -4r \cos \theta \Rightarrow x^2 + y^2 = -4x \Rightarrow x^2 + 4x + y^2 = 0 \Rightarrow x^2 + 4x + 4 + y^2 = 4 \Rightarrow (x + 2)^2 + y^2 = 4$, a circle with center $C(-2, 0)$ and radius 2

650 Chapter 10 Conic Sections and Polar Coordinates

42. $r^2 = -6r \sin \theta \Rightarrow x^2 + y^2 = -6y \Rightarrow x^2 + y^2 + 6y = 0 \Rightarrow x^2 + y^2 + 6y + 9 = 9 \Rightarrow x^2 + (y + 3)^2 = 9$, a circle with center $C(0, -3)$ and radius 3

43. $r = 8 \sin \theta \Rightarrow r^2 = 8r \sin \theta \Rightarrow x^2 + y^2 = 8y \Rightarrow x^2 + y^2 - 8y = 0 \Rightarrow x^2 + y^2 - 8y + 16 = 16 \Rightarrow x^2 + (y - 4)^2 = 16$, a circle with center $C(0, 4)$ and radius 4

44. $r = 3 \cos \theta \Rightarrow r^2 = 3r \cos \theta \Rightarrow x^2 + y^2 = 3x \Rightarrow x^2 + y^2 - 3x = 0 \Rightarrow x^2 - 3x + \frac{9}{4} + y^2 = \frac{9}{4} \Rightarrow (x - \frac{3}{2})^2 + y^2 = \frac{9}{4}$, a circle with center $C(\frac{3}{2}, 0)$ and radius $\frac{3}{2}$

45. $r = 2 \cos \theta + 2 \sin \theta \Rightarrow r^2 = 2r \cos \theta + 2r \sin \theta \Rightarrow x^2 + y^2 = 2x + 2y \Rightarrow x^2 - 2x + y^2 - 2y = 0 \Rightarrow (x - 1)^2 + (y - 1)^2 = 2$, a circle with center $C(1, 1)$ and radius $\sqrt{2}$

46. $r = 2 \cos \theta - \sin \theta \Rightarrow r^2 = 2r \cos \theta - r \sin \theta \Rightarrow x^2 + y^2 = 2x - y \Rightarrow x^2 - 2x + y^2 + y = 0 \Rightarrow (x - 1)^2 + (y + \frac{1}{2})^2 = \frac{5}{4}$, a circle with center $C(1, -\frac{1}{2})$ and radius $\frac{\sqrt{5}}{2}$

47. $r \sin(\theta + \frac{\pi}{6}) = 2 \Rightarrow r(\sin \theta \cos \frac{\pi}{6} + \cos \theta \sin \frac{\pi}{6}) = 2 \Rightarrow \frac{\sqrt{3}}{2} r \sin \theta + \frac{1}{2} r \cos \theta = 2 \Rightarrow \frac{\sqrt{3}}{2} y + \frac{1}{2} x = 2 \Rightarrow \sqrt{3} y + x = 4$, line with slope $m = -\frac{1}{\sqrt{3}}$ and intercept $b = \frac{4}{\sqrt{3}}$

48. $r \sin(\frac{2\pi}{3} - \theta) = 5 \Rightarrow r(\sin \frac{2\pi}{3} \cos \theta - \cos \frac{2\pi}{3} \sin \theta) = 5 \Rightarrow \frac{\sqrt{3}}{2} r \cos \theta + \frac{1}{2} r \sin \theta = 5 \Rightarrow \frac{\sqrt{3}}{2} x + \frac{1}{2} y = 5 \Rightarrow \sqrt{3} x + y = 10$, line with slope $m = -\sqrt{3}$ and intercept $b = 10$

49. $x = 7 \Rightarrow r \cos \theta = 7$

50. $y = 1 \Rightarrow r \sin \theta = 1$

51. $x = y \Rightarrow r \cos \theta = r \sin \theta \Rightarrow \theta = \frac{\pi}{4}$

52. $x - y = 3 \Rightarrow r \cos \theta - r \sin \theta = 3$

53. $x^2 + y^2 = 4 \Rightarrow r^2 = 4 \Rightarrow r = 2$ or $r = -2$

54. $x^2 - y^2 = 1 \Rightarrow r^2 \cos^2 \theta - r^2 \sin^2 \theta = 1 \Rightarrow r^2 (\cos^2 \theta - \sin^2 \theta) = 1 \Rightarrow r^2 \cos 2\theta = 1$

55. $\frac{x^2}{9} + \frac{y^2}{4} = 1 \Rightarrow 4x^2 + 9y^2 = 36 \Rightarrow 4r^2 \cos^2 \theta + 9r^2 \sin^2 \theta = 36$

56. $xy = 2 \Rightarrow (r \cos \theta)(r \sin \theta) = 2 \Rightarrow r^2 \cos \theta \sin \theta = 2 \Rightarrow 2r^2 \cos \theta \sin \theta = 4 \Rightarrow r^2 \sin 2\theta = 4$

57. $y^2 = 4x \Rightarrow r^2 \sin^2 \theta = 4r \cos \theta \Rightarrow r \sin^2 \theta = 4 \cos \theta$

58. $x^2 + xy + y^2 = 1 \Rightarrow x^2 + y^2 + xy = 1 \Rightarrow r^2 + r^2 \sin \theta \cos \theta = 1 \Rightarrow r^2 (1 + \sin \theta \cos \theta) = 1$

59. $x^2 + (y - 2)^2 = 4 \Rightarrow x^2 + y^2 - 4y + 4 = 4 \Rightarrow x^2 + y^2 = 4y \Rightarrow r^2 = 4r \sin \theta \Rightarrow r = 4 \sin \theta$

60. $(x - 5)^2 + y^2 = 25 \Rightarrow x^2 - 10x + 25 + y^2 = 25 \Rightarrow x^2 + y^2 = 10x \Rightarrow r^2 = 10r \cos \theta \Rightarrow r = 10 \cos \theta$

61. $(x - 3)^2 + (y + 1)^2 = 4 \Rightarrow x^2 - 6x + 9 + y^2 + 2y + 1 = 4 \Rightarrow x^2 + y^2 = 6x - 2y - 6 \Rightarrow r^2 = 6r \cos \theta - 2r \sin \theta - 6$

62. $(x + 2)^2 + (y - 5)^2 = 16 \Rightarrow x^2 + 4x + 4 + y^2 - 10y + 25 = 16 \Rightarrow x^2 + y^2 = -4x + 10y - 13 \Rightarrow r^2 = -4r \cos \theta + 10r \sin \theta - 13$

63. $(0, \theta)$ where θ is any angle

64. (a) $x = a \Rightarrow r \cos \theta = a \Rightarrow r = \frac{a}{\cos \theta} \Rightarrow r = a \sec \theta$
 (b) $y = b \Rightarrow r \sin \theta = b \Rightarrow r = \frac{b}{\sin \theta} \Rightarrow r = b \csc \theta$

10.6 GRAPHING IN POLAR COORDINATES

1. $1 + \cos(-\theta) = 1 + \cos \theta = r \Rightarrow$ symmetric about the x-axis; $1 + \cos(-\theta) \neq -r$ and $1 + \cos(\pi - \theta) = 1 - \cos \theta \neq r \Rightarrow$ not symmetric about the y-axis; therefore not symmetric about the origin

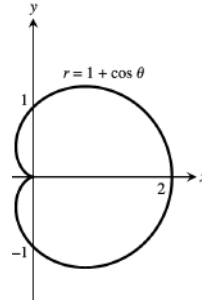

2. $2 - 2 \cos(-\theta) = 2 - 2 \cos \theta = r \Rightarrow$ symmetric about the x-axis; $2 - 2 \cos(-\theta) \neq -r$ and $2 - 2 \cos(\pi - \theta) = 2 + 2 \cos \theta \neq r \Rightarrow$ not symmetric about the y-axis; therefore not symmetric about the origin

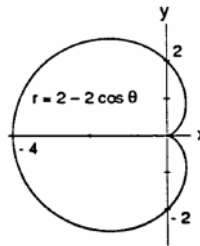

3. $1 - \sin(-\theta) = 1 + \sin \theta \neq r$ and $1 - \sin(\pi - \theta) = 1 - \sin \theta \neq -r \Rightarrow$ not symmetric about the x-axis; $1 - \sin(\pi - \theta) = 1 - \sin \theta = r \Rightarrow$ symmetric about the y-axis; therefore not symmetric about the origin

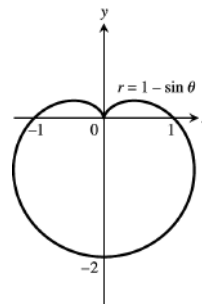

4. $1 + \sin(-\theta) = 1 - \sin \theta \neq r$ and $1 + \sin(\pi - \theta) = 1 + \sin \theta \neq -r \Rightarrow$ not symmetric about the x-axis; $1 + \sin(\pi - \theta) = 1 + \sin \theta = r \Rightarrow$ symmetric about the y-axis; therefore not symmetric about the origin

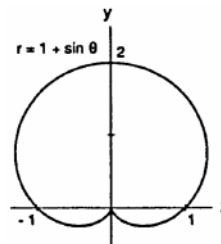

5. $2 + \sin(-\theta) = 2 - \sin \theta \neq r$ and $2 + \sin(\pi - \theta) = 2 + \sin \theta \neq -r \Rightarrow$ not symmetric about the x-axis; $2 + \sin(\pi - \theta) = 2 + \sin \theta = r \Rightarrow$ symmetric about the y-axis; therefore not symmetric about the origin

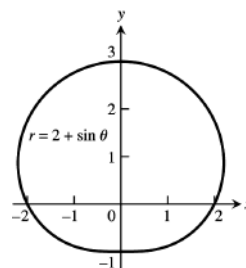

6. $1 + 2 \sin(-\theta) = 1 - 2 \sin \theta \neq r$ and $1 + 2 \sin(\pi - \theta) = 1 + 2 \sin \theta \neq -r \Rightarrow$ not symmetric about the x-axis;
 $1 + 2 \sin(\pi - \theta) = 1 + 2 \sin \theta = r \Rightarrow$ symmetric about the y-axis; therefore not symmetric about the origin

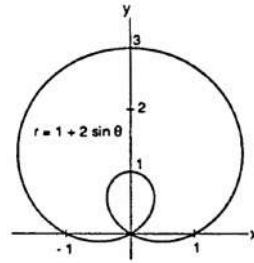

7. $\sin(-\frac{\theta}{2}) = -\sin(\frac{\theta}{2}) = -r \Rightarrow$ symmetric about the y-axis;
 $\sin(\frac{2\pi-\theta}{2}) = \sin(\frac{\theta}{2})$, so the graph is symmetric about the x-axis, and hence the origin.

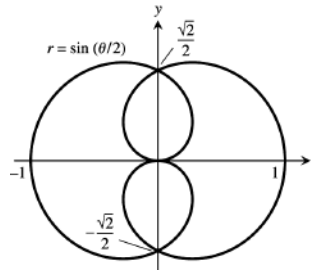

8. $\cos(-\frac{\theta}{2}) = \cos(\frac{\theta}{2}) = r \Rightarrow$ symmetric about the x-axis;
 $\cos(\frac{2\pi-\theta}{2}) = \cos(\frac{\theta}{2})$, so the graph is symmetric about the y-axis, and hence the origin.

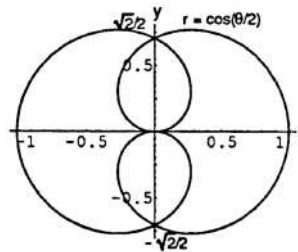

9. $\cos(-\theta) = \cos \theta = r^2 \Rightarrow (r, -\theta)$ and $(-r, -\theta)$ are on the graph when (r, θ) is on the graph \Rightarrow symmetric about the x-axis and the y-axis; therefore symmetric about the origin

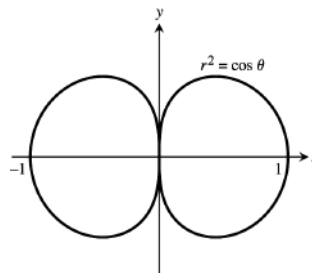

10. $\sin(\pi - \theta) = \sin \theta = r^2 \Rightarrow (r, \pi - \theta)$ and $(-r, \pi - \theta)$ are on the graph when (r, θ) is on the graph \Rightarrow symmetric about the y-axis and the x-axis; therefore symmetric about the origin

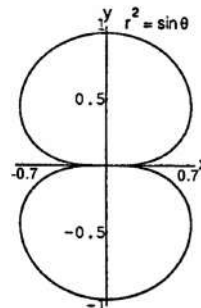

11. $-\sin(\pi - \theta) = -\sin \theta = r^2 \Rightarrow (r, \pi - \theta)$ and $(-r, \pi - \theta)$ are on the graph when (r, θ) is on the graph \Rightarrow symmetric about the y-axis and the x-axis; therefore symmetric about the origin

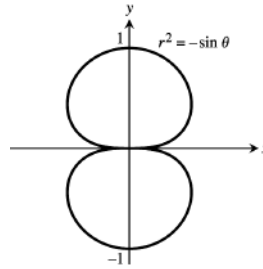

12. $-\cos(-\theta) = -\cos \theta = r^2 \Rightarrow (r, -\theta)$ and $(-r, -\theta)$ are on the graph when (r, θ) is on the graph \Rightarrow symmetric about the x-axis and the y-axis; therefore symmetric about the origin

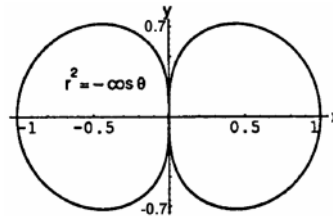

13. Since $(\pm r, -\theta)$ are on the graph when (r, θ) is on the graph $((\pm r)^2 = 4 \cos 2(-\theta) \Rightarrow r^2 = 4 \cos 2\theta)$, the graph is symmetric about the x-axis and the y-axis \Rightarrow the graph is symmetric about the origin

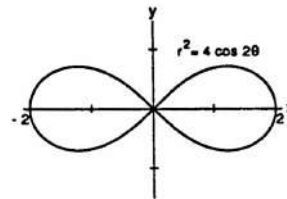

14. Since (r, θ) on the graph $\Rightarrow (-r, \theta)$ is on the graph $((\pm r)^2 = 4 \sin 2\theta \Rightarrow r^2 = 4 \sin 2\theta)$, the graph is symmetric about the origin. But $4 \sin 2(-\theta) = -4 \sin 2\theta \neq r^2$ and $4 \sin 2(\pi - \theta) = 4 \sin(2\pi - 2\theta) = 4 \sin(-2\theta) = -4 \sin 2\theta \neq r^2 \Rightarrow$ the graph is not symmetric about the x-axis; therefore the graph is not symmetric about the y-axis

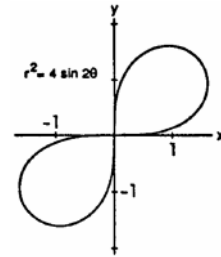

15. Since (r, θ) on the graph $\Rightarrow (-r, \theta)$ is on the graph $((\pm r)^2 = -\sin 2\theta \Rightarrow r^2 = -\sin 2\theta)$, the graph is symmetric about the origin. But $-\sin 2(-\theta) = -(-\sin 2\theta) = \sin 2\theta \neq r^2$ and $-\sin 2(\pi - \theta) = -\sin(2\pi - 2\theta) = -\sin(-2\theta) = \sin 2\theta \neq r^2 \Rightarrow$ the graph is not symmetric about the x-axis; therefore the graph is not symmetric about the y-axis

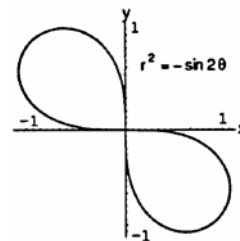

16. Since $(\pm r, -\theta)$ are on the graph when (r, θ) is on the graph $((\pm r)^2 = -\cos 2(-\theta) \Rightarrow r^2 = -\cos 2\theta)$, the graph is symmetric about the x-axis and the y-axis \Rightarrow the graph is symmetric about the origin.

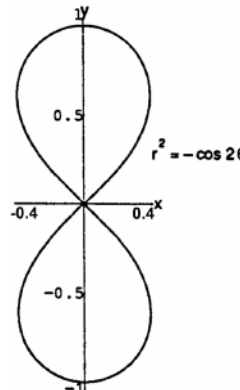

$$\begin{aligned}
 17. \theta = \frac{\pi}{2} &\Rightarrow r = -1 \Rightarrow \left(-1, \frac{\pi}{2}\right), \text{ and } \theta = -\frac{\pi}{2} \Rightarrow r = -1 \\
 &\Rightarrow \left(-1, -\frac{\pi}{2}\right); r' = \frac{dr}{d\theta} = -\sin \theta; \text{ Slope} = \frac{r' \sin \theta + r \cos \theta}{r' \cos \theta - r \sin \theta} \\
 &= \frac{-\sin^2 \theta + r \cos \theta}{-\sin \theta \cos \theta - r \sin \theta} \Rightarrow \text{Slope at } \left(-1, \frac{\pi}{2}\right) \text{ is} \\
 &\frac{-\sin^2(\frac{\pi}{2}) + (-1) \cos \frac{\pi}{2}}{-\sin \frac{\pi}{2} \cos \frac{\pi}{2} - (-1) \sin \frac{\pi}{2}} = -1; \text{ Slope at } \left(-1, -\frac{\pi}{2}\right) \text{ is} \\
 &\frac{-\sin^2(-\frac{\pi}{2}) + (-1) \cos(-\frac{\pi}{2})}{-\sin(-\frac{\pi}{2}) \cos(-\frac{\pi}{2}) - (-1) \sin(-\frac{\pi}{2})} = 1
 \end{aligned}$$

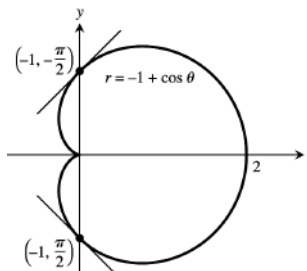

$$\begin{aligned}
 18. \theta = 0 &\Rightarrow r = -1 \Rightarrow (-1, 0), \text{ and } \theta = \pi \Rightarrow r = -1 \\
 &\Rightarrow (-1, \pi); r' = \frac{dr}{d\theta} = \cos \theta; \\
 \text{Slope} &= \frac{r' \sin \theta + r \cos \theta}{r' \cos \theta - r \sin \theta} = \frac{\cos \theta \sin \theta + r \cos \theta}{\cos \theta \cos \theta - r \sin \theta} \\
 &= \frac{\cos \theta \sin \theta + r \cos \theta}{\cos^2 \theta - r \sin \theta} \Rightarrow \text{Slope at } (-1, 0) \text{ is } \frac{\cos 0 \sin 0 + (-1) \cos 0}{\cos^2 0 - (-1) \sin 0} \\
 &= -1; \text{ Slope at } (-1, \pi) \text{ is } \frac{\cos \pi \sin \pi + (-1) \cos \pi}{\cos^2 \pi - (-1) \sin \pi} = 1
 \end{aligned}$$

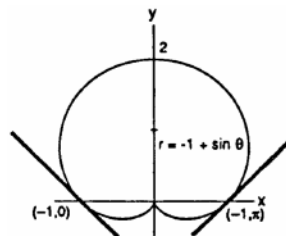

$$\begin{aligned}
 19. \theta = \frac{\pi}{4} &\Rightarrow r = 1 \Rightarrow \left(1, \frac{\pi}{4}\right); \theta = -\frac{\pi}{4} \Rightarrow r = -1 \\
 &\Rightarrow \left(-1, -\frac{\pi}{4}\right); \theta = \frac{3\pi}{4} \Rightarrow r = -1 \Rightarrow \left(-1, \frac{3\pi}{4}\right); \\
 &\theta = -\frac{3\pi}{4} \Rightarrow r = 1 \Rightarrow \left(1, -\frac{3\pi}{4}\right); \\
 r' &= \frac{dr}{d\theta} = 2 \cos 2\theta; \\
 \text{Slope} &= \frac{r' \sin \theta + r \cos \theta}{r' \cos \theta - r \sin \theta} = \frac{2 \cos 2\theta \sin \theta + r \cos \theta}{2 \cos 2\theta \cos \theta - r \sin \theta} \\
 &\Rightarrow \text{Slope at } \left(1, \frac{\pi}{4}\right) \text{ is } \frac{2 \cos(\frac{\pi}{2}) \sin(\frac{\pi}{4}) + (1) \cos(\frac{\pi}{4})}{2 \cos(\frac{\pi}{2}) \cos(\frac{\pi}{4}) - (1) \sin(\frac{\pi}{4})} = -1; \\
 \text{Slope at } \left(-1, -\frac{\pi}{4}\right) &\text{ is } \frac{2 \cos(-\frac{\pi}{2}) \sin(-\frac{\pi}{4}) + (-1) \cos(-\frac{\pi}{4})}{2 \cos(-\frac{\pi}{2}) \cos(-\frac{\pi}{4}) - (-1) \sin(-\frac{\pi}{4})} = 1; \\
 \text{Slope at } \left(-1, \frac{3\pi}{4}\right) &\text{ is } \frac{2 \cos(\frac{3\pi}{2}) \sin(\frac{3\pi}{4}) + (-1) \cos(\frac{3\pi}{4})}{2 \cos(\frac{3\pi}{2}) \cos(\frac{3\pi}{4}) - (-1) \sin(\frac{3\pi}{4})} = 1; \\
 \text{Slope at } \left(1, -\frac{3\pi}{4}\right) &\text{ is } \frac{2 \cos(-\frac{3\pi}{2}) \sin(-\frac{3\pi}{4}) + (1) \cos(-\frac{3\pi}{4})}{2 \cos(-\frac{3\pi}{2}) \cos(-\frac{3\pi}{4}) - (1) \sin(-\frac{3\pi}{4})} = -1
 \end{aligned}$$

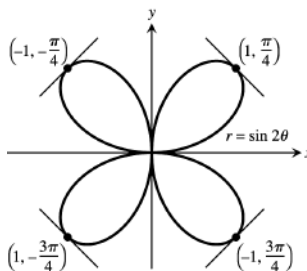

$$\begin{aligned}
 20. \theta = 0 &\Rightarrow r = 1 \Rightarrow (1, 0); \theta = \frac{\pi}{2} \Rightarrow r = -1 \Rightarrow \left(-1, \frac{\pi}{2}\right); \\
 &\theta = -\frac{\pi}{2} \Rightarrow r = -1 \Rightarrow \left(-1, -\frac{\pi}{2}\right); \theta = \pi \Rightarrow r = 1 \\
 &\Rightarrow (1, \pi); r' = \frac{dr}{d\theta} = -2 \sin 2\theta; \\
 \text{Slope} &= \frac{r' \sin \theta + r \cos \theta}{r' \cos \theta - r \sin \theta} = \frac{-2 \sin 2\theta \sin \theta + r \cos \theta}{-2 \sin 2\theta \cos \theta - r \sin \theta} \\
 &\Rightarrow \text{Slope at } (1, 0) \text{ is } \frac{-2 \sin 0 \sin 0 + \cos 0}{-2 \sin 0 \cos 0 - \sin 0}, \text{ which is undefined;} \\
 \text{Slope at } \left(-1, \frac{\pi}{2}\right) &\text{ is } \frac{-2 \sin 2(\frac{\pi}{2}) \sin(\frac{\pi}{2}) + (-1) \cos(\frac{\pi}{2})}{-2 \sin 2(\frac{\pi}{2}) \cos(\frac{\pi}{2}) - (-1) \sin(\frac{\pi}{2})} = 0; \\
 \text{Slope at } \left(-1, -\frac{\pi}{2}\right) &\text{ is } \frac{-2 \sin 2(-\frac{\pi}{2}) \sin(-\frac{\pi}{2}) + (-1) \cos(-\frac{\pi}{2})}{-2 \sin 2(-\frac{\pi}{2}) \cos(-\frac{\pi}{2}) - (-1) \sin(-\frac{\pi}{2})} = 0; \\
 \text{Slope at } (1, \pi) &\text{ is } \frac{-2 \sin 2\pi \sin \pi + \cos \pi}{-2 \sin 2\pi \cos \pi - \sin \pi}, \text{ which is undefined}
 \end{aligned}$$

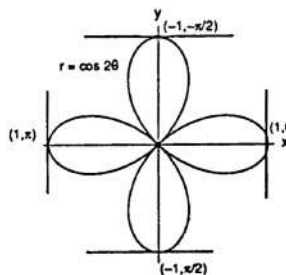

21. (a)

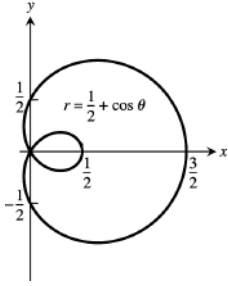

(b)

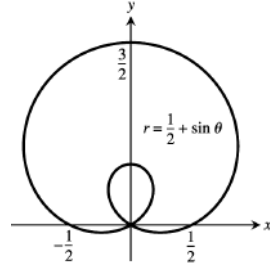

22. (a)

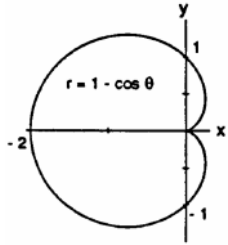

(b)

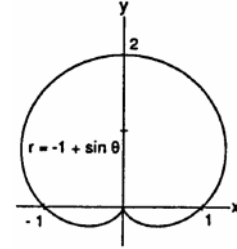

23. (a)

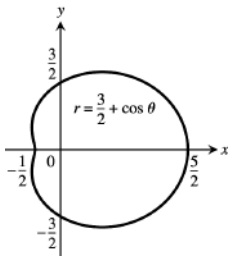

(b)

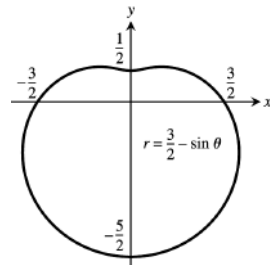

24. (a)

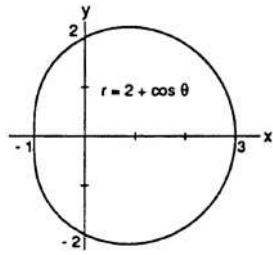

(b)

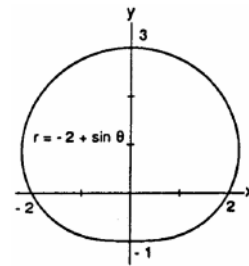

25.

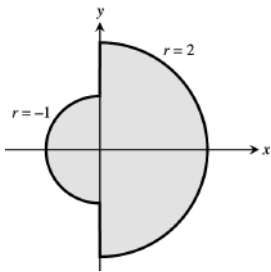

26. $r = 2 \sec \theta \Rightarrow r = \frac{2}{\cos \theta} \Rightarrow r \cos \theta = 2 \Rightarrow x = 2$

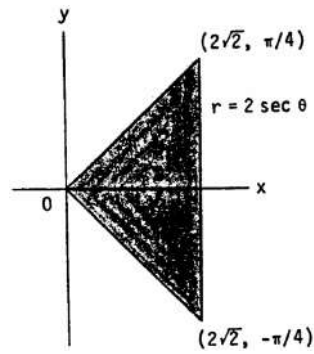

27.

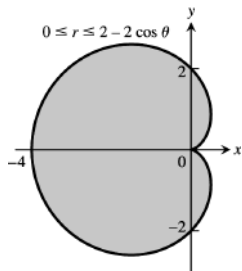

28.

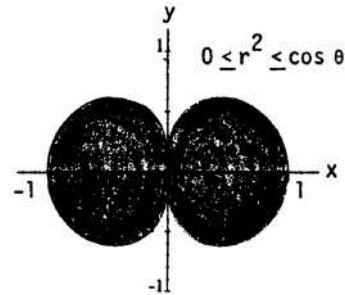

29. $(2, \frac{3\pi}{4})$ is the same point as $(-2, -\frac{\pi}{4})$; $r = 2 \sin 2(-\frac{\pi}{4}) = 2 \sin(-\frac{\pi}{2}) = -2 \Rightarrow (-2, -\frac{\pi}{4})$ is on the graph $\Rightarrow (2, \frac{3\pi}{4})$ is on the graph

30. $(\frac{1}{2}, \frac{3\pi}{2})$ is the same point as $(-\frac{1}{2}, \frac{\pi}{2})$; $r = -\sin(\frac{\pi}{6}) = -\sin \frac{\pi}{6} = -\frac{1}{2} \Rightarrow (-\frac{1}{2}, \frac{\pi}{2})$ is on the graph $\Rightarrow (\frac{1}{2}, \frac{3\pi}{2})$ is on the graph

31. $1 + \cos \theta = 1 - \cos \theta \Rightarrow \cos \theta = 0 \Rightarrow \theta = \frac{\pi}{2}, \frac{3\pi}{2}$
 $\Rightarrow r = 1$; points of intersection are $(1, \frac{\pi}{2})$ and $(1, \frac{3\pi}{2})$.
 The point of intersection $(0, 0)$ is found by graphing.

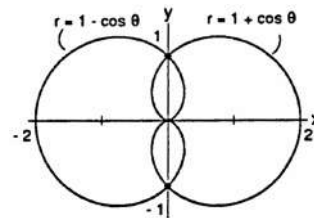

32. $1 + \sin \theta = 1 - \sin \theta \Rightarrow \sin \theta = 0 \Rightarrow \theta = 0, \pi \Rightarrow r = 1$;
 points of intersection are $(1, 0)$ and $(1, \pi)$. The point of intersection $(0, 0)$ is found by graphing.

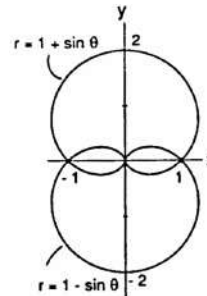

33. $2 \sin \theta = 2 \sin 2\theta \Rightarrow \sin \theta = \sin 2\theta \Rightarrow \sin \theta = 2 \sin \theta \cos \theta \Rightarrow \sin \theta - 2 \sin \theta \cos \theta = 0$
 $\Rightarrow (\sin \theta)(1 - 2 \cos \theta) = 0 \Rightarrow \sin \theta = 0$ or $\cos \theta = \frac{1}{2}$
 $\Rightarrow \theta = 0, \pi, \frac{\pi}{3},$ or $-\frac{\pi}{3}; \theta = 0$ or $\pi \Rightarrow r = 0,$
 $\theta = \frac{\pi}{3} \Rightarrow r = \sqrt{3},$ and $\theta = -\frac{\pi}{3} \Rightarrow r = -\sqrt{3};$ points of intersection are $(0, 0), (\sqrt{3}, \frac{\pi}{3}),$ and $(-\sqrt{3}, -\frac{\pi}{3})$

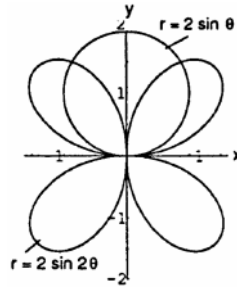

34. $\cos \theta = 1 - \cos \theta \Rightarrow 2 \cos \theta = 1 \Rightarrow \cos \theta = \frac{1}{2}$
 $\Rightarrow \theta = \frac{\pi}{3}, -\frac{\pi}{3} \Rightarrow r = \frac{1}{2};$ points of intersection are $(\frac{1}{2}, \frac{\pi}{3})$ and $(\frac{1}{2}, -\frac{\pi}{3}).$ The point $(0, 0)$ is found by graphing.

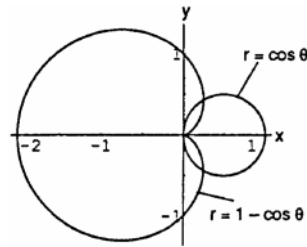

35. $(\sqrt{2})^2 = 4 \sin \theta \Rightarrow \frac{1}{2} = \sin \theta \Rightarrow \theta = \frac{\pi}{6}, \frac{5\pi}{6};$ points of intersection are $(\sqrt{2}, \frac{\pi}{6})$ and $(\sqrt{2}, \frac{5\pi}{6}).$ The points $(\sqrt{2}, -\frac{\pi}{6})$ and $(\sqrt{2}, -\frac{5\pi}{6})$ are found by graphing.

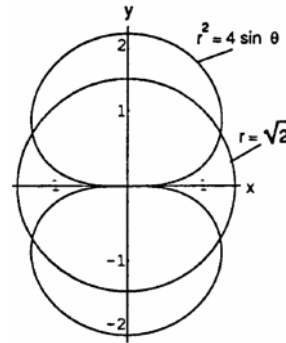

36. $\sqrt{2} \sin \theta = \sqrt{2} \cos \theta \Rightarrow \sin \theta = \cos \theta \Rightarrow \theta = \frac{\pi}{4}, \frac{5\pi}{4};$
 $\theta = \frac{\pi}{4} \Rightarrow r^2 = 1 \Rightarrow r = \pm 1$ and $\theta = \frac{5\pi}{4} \Rightarrow r^2 = -1$
 \Rightarrow no solution for $r;$ points of intersection are $(\pm 1, \frac{\pi}{4}).$
 The points $(0, 0)$ and $(\pm 1, \frac{3\pi}{4})$ are found by graphing.

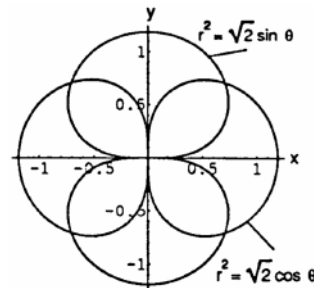

37. $1 = 2 \sin 2\theta \Rightarrow \sin 2\theta = \frac{1}{2} \Rightarrow 2\theta = \frac{\pi}{6}, \frac{5\pi}{6}, \frac{13\pi}{6}, \frac{17\pi}{6}$
 $\Rightarrow \theta = \frac{\pi}{12}, \frac{5\pi}{12}, \frac{13\pi}{12}, \frac{17\pi}{12};$ points of intersection are $(1, \frac{\pi}{12}), (1, \frac{5\pi}{12}), (1, \frac{13\pi}{12}),$ and $(1, \frac{17\pi}{12}).$ No other points are found by graphing.

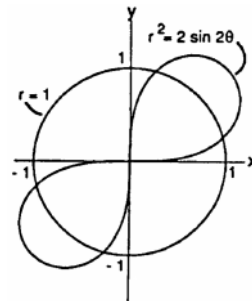

38. $\sqrt{2} \cos 2\theta = \sqrt{2} \sin 2\theta \Rightarrow \cos 2\theta = \sin 2\theta$
 $\Rightarrow 2\theta = \frac{\pi}{4}, \frac{5\pi}{4}, \frac{9\pi}{4}, \frac{13\pi}{4} \Rightarrow \theta = \frac{\pi}{8}, \frac{5\pi}{8}, \frac{9\pi}{8}, \frac{13\pi}{8};$
 $\theta = \frac{\pi}{8}, \frac{9\pi}{8} \Rightarrow r^2 = 1 \Rightarrow r = \pm 1; \theta = \frac{5\pi}{8}, \frac{13\pi}{8}$
 $\Rightarrow r^2 = -1 \Rightarrow$ no solution for r ; points of intersection are $(1, \frac{\pi}{8})$ and $(1, \frac{9\pi}{8})$. The point of intersection $(0, 0)$ is found by graphing.

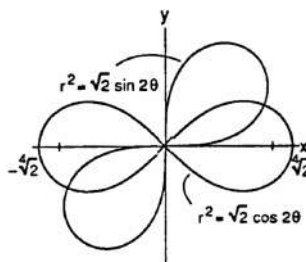

39. $r^2 = \sin 2\theta$ and $r^2 = \cos 2\theta$ are generated completely for $0 \leq \theta \leq \frac{\pi}{2}$. Then $\sin 2\theta = \cos 2\theta \Rightarrow 2\theta = \frac{\pi}{4}$ is the only solution on that interval $\Rightarrow \theta = \frac{\pi}{8} \Rightarrow r^2 = \sin 2(\frac{\pi}{8}) = \frac{1}{\sqrt{2}}$
 $\Rightarrow r = \pm \frac{1}{\sqrt[4]{2}}$; points of intersection are $(\pm \frac{1}{\sqrt[4]{2}}, \frac{\pi}{8})$.
 The point of intersection $(0, 0)$ is found by graphing.

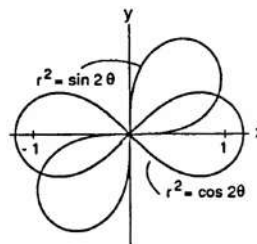

40. $1 - \sin \frac{\theta}{2} = 1 + \cos \frac{\theta}{2} \Rightarrow -\sin \frac{\theta}{2} = \cos \frac{\theta}{2} \Rightarrow \frac{\theta}{2} = \frac{3\pi}{4}, \frac{7\pi}{4}$
 $\Rightarrow \theta = \frac{3\pi}{2}, \frac{7\pi}{2}; \theta = \frac{3\pi}{2} \Rightarrow r = 1 + \cos \frac{3\pi}{4} = 1 - \frac{\sqrt{2}}{2};$
 $\theta = \frac{7\pi}{2} \Rightarrow r = 1 + \cos \frac{7\pi}{4} = 1 + \frac{\sqrt{2}}{2}$; points of intersection are $(1 - \frac{\sqrt{2}}{2}, \frac{3\pi}{2})$ and $(1 + \frac{\sqrt{2}}{2}, \frac{7\pi}{2})$. The three points of intersection $(0, 0)$ and $(1 \pm \frac{\sqrt{2}}{2}, \frac{\pi}{2})$ are found by graphing and symmetry.

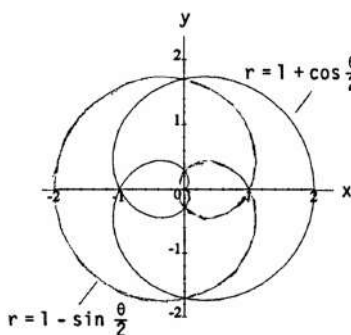

41. $1 = 2 \sin 2\theta \Rightarrow \sin 2\theta = \frac{1}{2} \Rightarrow 2\theta = \frac{\pi}{6}, \frac{5\pi}{6}, \frac{13\pi}{6}, \frac{17\pi}{6}$
 $\Rightarrow \theta = \frac{\pi}{12}, \frac{5\pi}{12}, \frac{13\pi}{12}, \frac{17\pi}{12}$; points of intersection are $(1, \frac{\pi}{12}), (1, \frac{5\pi}{12}), (1, \frac{13\pi}{12}),$ and $(1, \frac{17\pi}{12})$. The points of intersection $(1, \frac{7\pi}{12}), (1, \frac{11\pi}{12}), (1, \frac{19\pi}{12})$ and $(1, \frac{23\pi}{12})$ are found by graphing and symmetry.

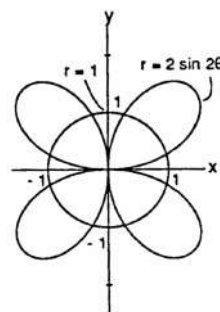

42. $r^2 = 2 \sin 2\theta$ is completely generated on $0 \leq \theta \leq \frac{\pi}{2}$ so that $1 = 2 \sin 2\theta \Rightarrow \sin 2\theta = \frac{1}{2} \Rightarrow 2\theta = \frac{\pi}{6}, \frac{5\pi}{6} \Rightarrow \theta = \frac{\pi}{12}, \frac{5\pi}{12}$; points of intersection are $(1, \frac{\pi}{12})$ and $(1, \frac{5\pi}{12})$. The points of intersection $(-1, \frac{\pi}{12})$ and $(-1, \frac{5\pi}{12})$ are found by graphing.

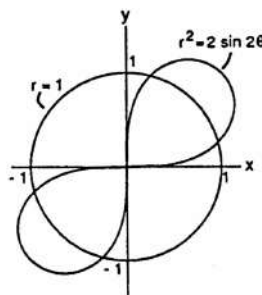

43. Note that (r, θ) and $(-r, \theta + \pi)$ describe the same point in the plane. Then $r = 1 - \cos \theta \Leftrightarrow -1 - \cos(\theta + \pi) = -1 - (\cos \theta \cos \pi - \sin \theta \sin \pi) = -1 + \cos \theta = -(1 - \cos \theta) = -r$; therefore (r, θ) is on the graph of $r = 1 - \cos \theta \Leftrightarrow (-r, \theta + \pi)$ is on the graph of $r = -1 - \cos \theta \Rightarrow$ the answer is (a).

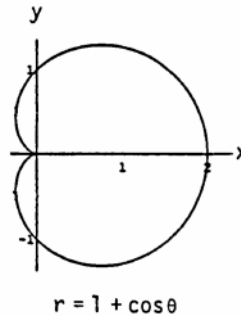
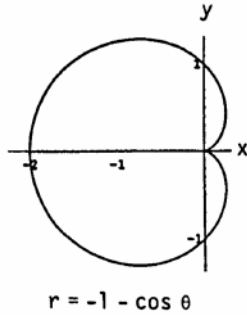
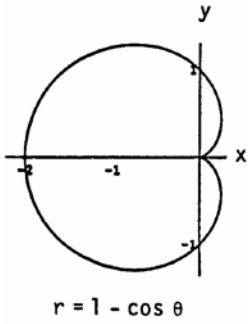

44. Note that (r, θ) and $(-r, \theta + \pi)$ describe the same point in the plane. Then $r = \cos 2\theta \Leftrightarrow -\sin(2(\theta + \pi) + \frac{\pi}{2}) = -\sin(2\theta + \frac{5\pi}{2}) = -\sin(2\theta) \cos(\frac{5\pi}{2}) - \cos(2\theta) \sin(\frac{5\pi}{2}) = -\cos 2\theta = -r$; therefore (r, θ) is on the graph of $r = -\sin(2\theta + \frac{\pi}{2}) \Rightarrow$ the answer is (a).

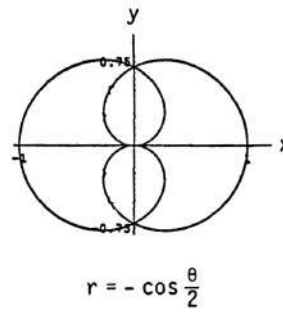
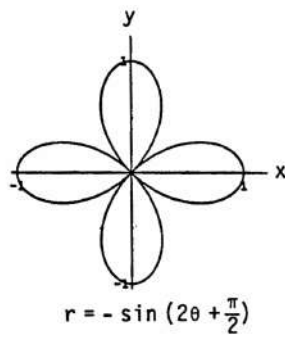
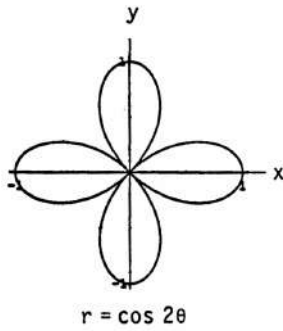

45.

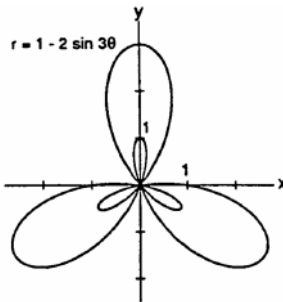

46.

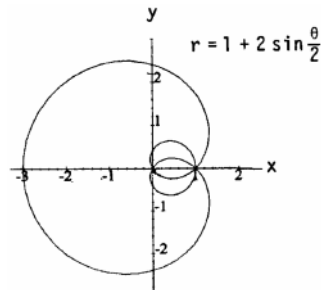

47. (a)

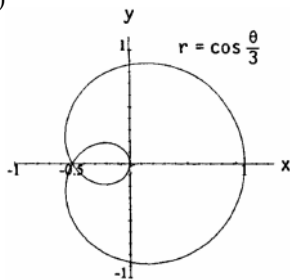

(b)

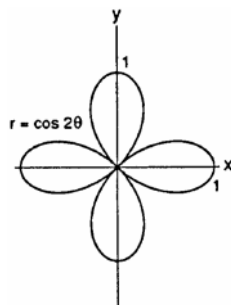

(c)

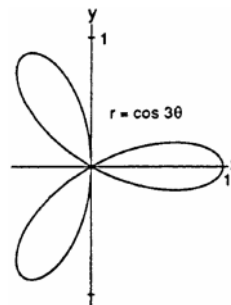

(d)

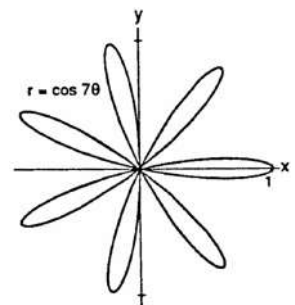

48. (a)

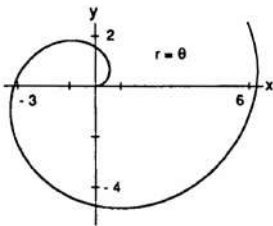

(b)

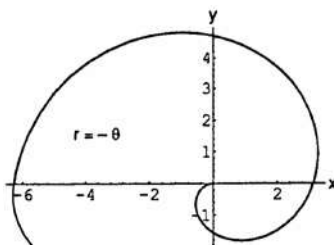

(c)

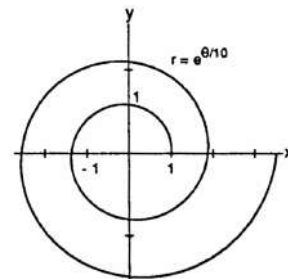

(d)

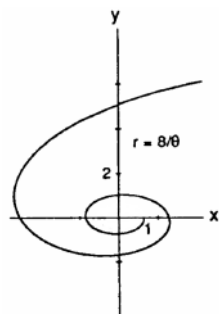

(e)

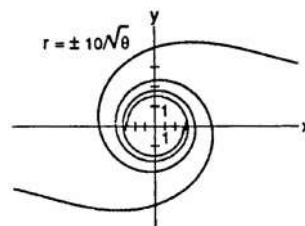

49. (a) $r^2 = -4 \cos \theta \Rightarrow \cos \theta = -\frac{r^2}{4}$; $r = 1 - \cos \theta \Rightarrow r = 1 - \left(-\frac{r^2}{4}\right) \Rightarrow 0 = r^2 - 4r + 4 \Rightarrow (r - 2)^2 = 0$
 $\Rightarrow r = 2$; therefore $\cos \theta = -\frac{2^2}{4} = -1 \Rightarrow \theta = \pi \Rightarrow (2, \pi)$ is a point of intersection

(b) $r = 0 \Rightarrow 0^2 = 4 \cos \theta \Rightarrow \cos \theta = 0 \Rightarrow \theta = \frac{\pi}{2}, \frac{3\pi}{2} \Rightarrow (0, \frac{\pi}{2})$ or $(0, \frac{3\pi}{2})$ is on the graph; $r = 0 \Rightarrow 0 = 1 - \cos \theta$
 $\Rightarrow \cos \theta = 1 \Rightarrow \theta = 0 \Rightarrow (0, 0)$ is on the graph. Since $(0, 0) = (0, \frac{\pi}{2})$ for polar coordinates, the graphs intersect at the origin.

50. (a) Let $r = f(\theta)$ be symmetric about the x-axis and the y-axis. Then (r, θ) on the graph $\Rightarrow (r, -\theta)$ is on the graph because of symmetry about the x-axis. Then $(-r, -(-\theta)) = (-r, \theta)$ is on the graph because of symmetry about the y-axis. Therefore $r = f(\theta)$ is symmetric about the origin.

(b) Let $r = f(\theta)$ be symmetric about the x-axis and the origin. Then (r, θ) on the graph $\Rightarrow (r, -\theta)$ is on the graph because of symmetry about the x-axis. Then $(-r, -\theta)$ is on the graph because of symmetry about the origin. Therefore $r = f(\theta)$ is symmetric about the y-axis.

(c) Let $r = f(\theta)$ be symmetric about the y-axis and the origin. Then (r, θ) on the graph $\Rightarrow (-r, -\theta)$ is on the graph because of symmetry about the y-axis. Then $(-(-r), -\theta) = (r, -\theta)$ is on the graph because of symmetry about the origin. Therefore $r = f(\theta)$ is symmetric about the x-axis.

51. The maximum width of the petal of the rose which lies along the x-axis is twice the largest y value of the curve on the interval $0 \leq \theta \leq \frac{\pi}{4}$. So we wish to maximize $2y = 2r \sin \theta = 2 \cos 2\theta \sin \theta$ on $0 \leq \theta \leq \frac{\pi}{4}$. Let $f(\theta) = 2 \cos 2\theta \sin \theta = 2(1 - 2 \sin^2 \theta)(\sin \theta) = 2 \sin \theta - 4 \sin^3 \theta \Rightarrow f'(\theta) = 2 \cos \theta - 12 \sin^2 \theta \cos \theta$. Then $f'(\theta) = 0 \Rightarrow 2 \cos \theta - 12 \sin^2 \theta \cos \theta = 0 \Rightarrow (\cos \theta)(1 - 6 \sin^2 \theta) = 0 \Rightarrow \cos \theta = 0$ or $1 - 6 \sin^2 \theta = 0 \Rightarrow \theta = \frac{\pi}{2}$ or $\sin \theta = \frac{\pm 1}{\sqrt{6}}$. Since we want $0 \leq \theta \leq \frac{\pi}{4}$, we choose $\theta = \sin^{-1}\left(\frac{1}{\sqrt{6}}\right) \Rightarrow f(\theta) = 2 \sin \theta - 4 \sin^3 \theta$
 $= 2\left(\frac{1}{\sqrt{6}}\right) - 4 \cdot \frac{1}{6\sqrt{6}} = \frac{2\sqrt{6}}{9}$. We can see from the graph of $r = \cos 2\theta$ that a maximum does occur in the interval $0 \leq \theta \leq \frac{\pi}{4}$. Therefore the maximum width occurs at $\theta = \sin^{-1}\left(\frac{1}{\sqrt{6}}\right)$, and the maximum width is $\frac{2\sqrt{6}}{9}$.

52. We wish to maximize $y = r \sin \theta = 2(1 + \cos \theta)(\sin \theta) = 2 \sin \theta + 2 \sin \theta \cos \theta$. Then $\frac{dy}{d\theta} = 2 \cos \theta + 2(\sin \theta)(-\sin \theta) + 2 \cos \theta \cos \theta = 2 \cos \theta - 2 \sin^2 \theta + 2 \cos^2 \theta = 2 \cos \theta + 4 \cos^2 \theta - 2$; thus $\frac{dy}{d\theta} = 0 \Rightarrow 4 \cos^2 \theta + 2 \cos \theta - 2 = 0 \Rightarrow 2 \cos^2 \theta + \cos \theta - 1 = 0 \Rightarrow (2 \cos \theta - 1)(\cos \theta + 1) = 0 \Rightarrow \cos \theta = \frac{1}{2}$ or $\cos \theta = -1 \Rightarrow \theta = \frac{\pi}{3}, \frac{5\pi}{3}, \pi$. From the graph, we can see that the maximum occurs in the first quadrant so we choose $\theta = \frac{\pi}{3}$. Then $y = 2 \sin \frac{\pi}{3} + 2 \sin \frac{\pi}{3} \cos \frac{\pi}{3} = \frac{3\sqrt{3}}{2}$. The x-coordinate of this point is $x = r \cos \frac{\pi}{3} = 2(1 + \cos \frac{\pi}{3})(\cos \frac{\pi}{3}) = \frac{3}{2}$. Thus the maximum height is $h = \frac{3\sqrt{3}}{2}$ occurring at $x = \frac{3}{2}$.

10.7 AREA AND LENGTHS IN POLAR COORDINATES

$$1. A = \int_0^{2\pi} \frac{1}{2} (4 + 2 \cos \theta)^2 d\theta = \int_0^{2\pi} \frac{1}{2} (16 + 16 \cos \theta + 4 \cos^2 \theta) d\theta = \int_0^{2\pi} [8 + 8 \cos \theta + 2 \left(\frac{1 + \cos 2\theta}{2}\right)] d\theta \\ = \int_0^{2\pi} (9 + 8 \cos \theta + \cos 2\theta) d\theta = [9\theta + 8 \sin \theta + \frac{1}{2} \sin 2\theta]_0^{2\pi} = 18\pi$$

$$2. A = \int_0^{2\pi} \frac{1}{2} [a(1 + \cos \theta)]^2 d\theta = \int_0^{2\pi} \frac{1}{2} a^2 (1 + 2 \cos \theta + \cos^2 \theta) d\theta = \frac{1}{2} a^2 \int_0^{2\pi} (1 + 2 \cos \theta + \frac{1 + \cos 2\theta}{2}) d\theta \\ = \frac{1}{2} a^2 \int_0^{2\pi} (\frac{3}{2} + 2 \cos \theta + \frac{1}{2} \cos 2\theta) d\theta = \frac{1}{2} a^2 [\frac{3}{2} \theta + 2 \sin \theta + \frac{1}{4} \sin 2\theta]_0^{2\pi} = \frac{3}{2} \pi a^2$$

$$3. A = 2 \int_0^{\pi/4} \frac{1}{2} \cos^2 2\theta d\theta = \int_0^{\pi/4} \frac{1 + \cos 4\theta}{2} d\theta = \frac{1}{2} [\theta + \frac{\sin 4\theta}{4}]_0^{\pi/4} = \frac{\pi}{8}$$

$$4. A = 2 \int_{-\pi/4}^{\pi/4} \frac{1}{2} (2a^2 \cos 2\theta) d\theta = 2a^2 \int_{-\pi/4}^{\pi/4} \cos 2\theta d\theta = 2a^2 [\frac{\sin 2\theta}{2}]_{-\pi/4}^{\pi/4} = 2a^2$$

$$5. A = \int_0^{\pi/2} \frac{1}{2} (4 \sin 2\theta) d\theta = \int_0^{\pi/2} 2 \sin 2\theta d\theta = [-\cos 2\theta]_0^{\pi/2} = 2$$

$$6. A = (6)(2) \int_0^{\pi/6} \frac{1}{2} (2 \sin 3\theta) d\theta = 12 \int_0^{\pi/6} \sin 3\theta d\theta = 12 [-\frac{\cos 3\theta}{3}]_0^{\pi/6} = 4$$

$$7. r = 2 \cos \theta \text{ and } r = 2 \sin \theta \Rightarrow 2 \cos \theta = 2 \sin \theta \\ \Rightarrow \cos \theta = \sin \theta \Rightarrow \theta = \frac{\pi}{4}; \text{ therefore}$$

$$A = 2 \int_0^{\pi/4} \frac{1}{2} (2 \sin \theta)^2 d\theta = \int_0^{\pi/4} 4 \sin^2 \theta d\theta \\ = \int_0^{\pi/4} 4 \left(\frac{1 - \cos 2\theta}{2}\right) d\theta = \int_0^{\pi/4} (2 - 2 \cos 2\theta) d\theta \\ = [2\theta - \sin 2\theta]_0^{\pi/4} = \frac{\pi}{2} - 1$$

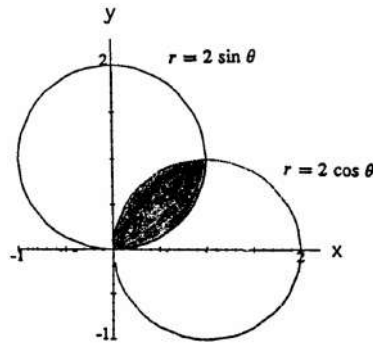

$$8. r = 1 \text{ and } r = 2 \sin \theta \Rightarrow 2 \sin \theta = 1 \Rightarrow \sin \theta = \frac{1}{2} \\ \Rightarrow \theta = \frac{\pi}{6} \text{ or } \frac{5\pi}{6}; \text{ therefore}$$

$$A = \pi(1)^2 - \int_{\pi/6}^{5\pi/6} \frac{1}{2} [(2 \sin \theta)^2 - 1^2] d\theta \\ = \pi - \int_{\pi/6}^{5\pi/6} (2 \sin^2 \theta - \frac{1}{2}) d\theta \\ = \pi - \int_{\pi/6}^{5\pi/6} (1 - \cos 2\theta - \frac{1}{2}) d\theta \\ = \pi - \int_{\pi/6}^{5\pi/6} (\frac{1}{2} - \cos 2\theta) d\theta = \pi - [\frac{1}{2} \theta - \frac{\sin 2\theta}{2}]_{\pi/6}^{5\pi/6} \\ = \pi - (\frac{5\pi}{12} - \frac{1}{2} \sin \frac{5\pi}{3}) + (\frac{\pi}{12} - \frac{1}{2} \sin \frac{\pi}{3}) = \frac{4\pi - 3\sqrt{3}}{6}$$

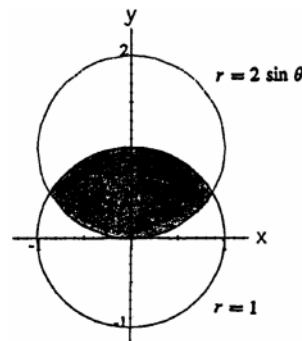

$$9. \quad r = 2 \text{ and } r = 2(1 - \cos \theta) \Rightarrow 2 = 2(1 - \cos \theta) \\ \Rightarrow \cos \theta = 0 \Rightarrow \theta = \pm \frac{\pi}{2}; \text{ therefore}$$

$$A = 2 \int_0^{\pi/2} \frac{1}{2} [2(1 - \cos \theta)]^2 d\theta + \frac{1}{2} \text{area of the circle} \\ = \int_0^{\pi/2} 4(1 - 2\cos \theta + \cos^2 \theta) d\theta + \left(\frac{1}{2} \pi\right) (2)^2 \\ = \int_0^{\pi/2} 4\left(1 - 2\cos \theta + \frac{1 + \cos 2\theta}{2}\right) d\theta + 2\pi \\ = \int_0^{\pi/2} (4 - 8\cos \theta + 2 + 2\cos 2\theta) d\theta + 2\pi \\ = [6\theta - 8\sin \theta + \sin 2\theta]_0^{\pi/2} + 2\pi = 5\pi - 8$$

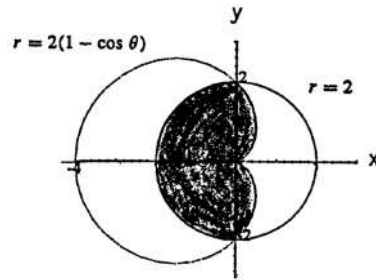

$$10. \quad r = 2(1 - \cos \theta) \text{ and } r = 2(1 + \cos \theta) \Rightarrow 1 - \cos \theta \\ = 1 + \cos \theta \Rightarrow \cos \theta = 0 \Rightarrow \theta = \frac{\pi}{2} \text{ or } \frac{3\pi}{2}; \text{ the graph also} \\ \text{gives the point of intersection } (0, 0); \text{ therefore}$$

$$A = 2 \int_0^{\pi/2} \frac{1}{2} [2(1 - \cos \theta)]^2 d\theta + 2 \int_{\pi/2}^{\pi} \frac{1}{2} [2(1 + \cos \theta)]^2 d\theta \\ = \int_0^{\pi/2} 4(1 - 2\cos \theta + \cos^2 \theta) d\theta \\ + \int_{\pi/2}^{\pi} 4(1 + 2\cos \theta + \cos^2 \theta) d\theta \\ = \int_0^{\pi/2} 4\left(1 - 2\cos \theta + \frac{1 + \cos 2\theta}{2}\right) d\theta + \int_{\pi/2}^{\pi} 4\left(1 + 2\cos \theta + \frac{1 + \cos 2\theta}{2}\right) d\theta \\ = \int_0^{\pi/2} (6 - 8\cos \theta + 2\cos 2\theta) d\theta + \int_{\pi/2}^{\pi} (6 + 8\cos \theta + 2\cos 2\theta) d\theta \\ = [6\theta - 8\sin \theta + \sin 2\theta]_0^{\pi/2} + [6\theta + 8\sin \theta + \sin 2\theta]_{\pi/2}^{\pi} = 6\pi - 16$$

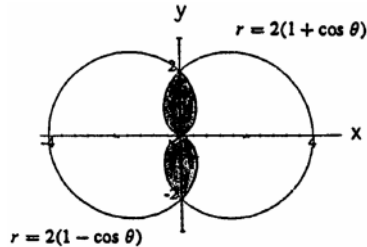

$$11. \quad r = \sqrt{3} \text{ and } r^2 = 6 \cos 2\theta \Rightarrow 3 = 6 \cos 2\theta \Rightarrow \cos 2\theta = \frac{1}{2} \\ \Rightarrow \theta = \frac{\pi}{6} \text{ (in the 1st quadrant); we use symmetry of the} \\ \text{graph to find the area, so}$$

$$A = 4 \int_0^{\pi/6} \left[\frac{1}{2} (6 \cos 2\theta) - \frac{1}{2} (\sqrt{3})^2 \right] d\theta \\ = 2 \int_0^{\pi/6} (6 \cos 2\theta - 3) d\theta = 2 [3 \sin 2\theta - 3\theta]_0^{\pi/6} \\ = 3\sqrt{3} - \pi$$

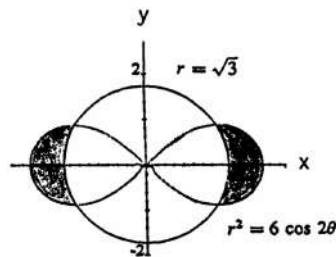

$$12. \quad r = 3a \cos \theta \text{ and } r = a(1 + \cos \theta) \Rightarrow 3a \cos \theta = a(1 + \cos \theta) \\ \Rightarrow 3 \cos \theta = 1 + \cos \theta \Rightarrow \cos \theta = \frac{1}{2} \Rightarrow \theta = \frac{\pi}{3} \text{ or } -\frac{\pi}{3}; \\ \text{the graph also gives the point of intersection } (0, 0); \text{ therefore}$$

$$A = 2 \int_0^{\pi/3} \frac{1}{2} [(3a \cos \theta)^2 - a^2(1 + \cos \theta)^2] d\theta \\ = \int_0^{\pi/3} (9a^2 \cos^2 \theta - a^2 - 2a^2 \cos \theta - a^2 \cos^2 \theta) d\theta \\ = \int_0^{\pi/3} (8a^2 \cos^2 \theta - 2a^2 \cos \theta - a^2) d\theta \\ = \int_0^{\pi/3} [4a^2(1 + \cos 2\theta) - 2a^2 \cos \theta - a^2] d\theta \\ = \int_0^{\pi/3} (3a^2 + 4a^2 \cos 2\theta - 2a^2 \cos \theta) d\theta \\ = [3a^2\theta + 2a^2 \sin 2\theta - 2a^2 \sin \theta]_0^{\pi/3} = \pi a^2 + 2a^2 \left(\frac{1}{2}\right) - 2a^2 \left(\frac{\sqrt{3}}{2}\right) = a^2 (\pi + 1 - \sqrt{3})$$

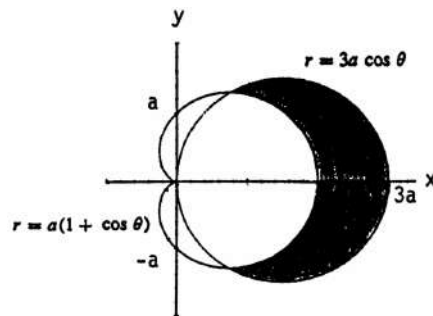

13. $r = 1$ and $r = -2 \cos \theta \Rightarrow 1 = -2 \cos \theta \Rightarrow \cos \theta = -\frac{1}{2}$
 $\Rightarrow \theta = \frac{2\pi}{3}$ in quadrant II; therefore

$$A = 2 \int_{2\pi/3}^{\pi} \frac{1}{2} [(-2 \cos \theta)^2 - 1^2] d\theta = \int_{2\pi/3}^{\pi} (4 \cos^2 \theta - 1) d\theta$$

$$= \int_{2\pi/3}^{\pi} [2(1 + \cos 2\theta) - 1] d\theta = \int_{2\pi/3}^{\pi} (1 + 2 \cos 2\theta) d\theta$$

$$= [\theta + \sin 2\theta]_{2\pi/3}^{\pi} = \frac{\pi}{3} + \frac{\sqrt{3}}{2}$$

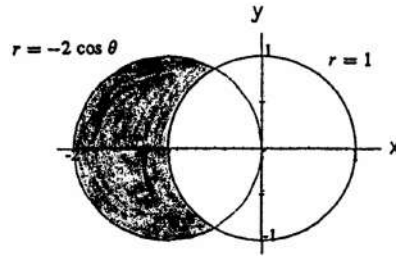

14. (a) $A = 2 \int_0^{2\pi/3} \frac{1}{2} (2 \cos \theta + 1)^2 d\theta = \int_0^{2\pi/3} (4 \cos^2 \theta + 4 \cos \theta + 1) d\theta = \int_0^{2\pi/3} [2(1 + \cos 2\theta) + 4 \cos \theta + 1] d\theta$

$$= \int_0^{2\pi/3} (3 + 2 \cos 2\theta + 4 \cos \theta) d\theta = [3\theta + \sin 2\theta + 4 \sin \theta]_0^{2\pi/3} = 2\pi - \frac{\sqrt{3}}{2} + \frac{4\sqrt{3}}{2} = 2\pi + \frac{3\sqrt{3}}{2}$$

(b) $A = \left(2\pi + \frac{3\sqrt{3}}{2}\right) - \left(\pi - \frac{3\sqrt{3}}{2}\right) = \pi + 3\sqrt{3}$ (from 14(a) above and Example 2 in the text)

15. $r = 6$ and $r = 3 \csc \theta \Rightarrow 6 \sin \theta = 3 \Rightarrow \sin \theta = \frac{1}{2}$

$$\Rightarrow \theta = \frac{\pi}{6} \text{ or } \frac{5\pi}{6}; \text{ therefore } A = \int_{\pi/6}^{5\pi/6} \frac{1}{2} (6^2 - 9 \csc^2 \theta) d\theta$$

$$= \int_{\pi/6}^{5\pi/6} \left(18 - \frac{9}{2} \csc^2 \theta\right) d\theta = \left[18\theta + \frac{9}{2} \cot \theta\right]_{\pi/6}^{5\pi/6}$$

$$= \left(15\pi - \frac{9}{2} \sqrt{3}\right) - \left(3\pi + \frac{9}{2} \sqrt{3}\right) = 12\pi - 9\sqrt{3}$$

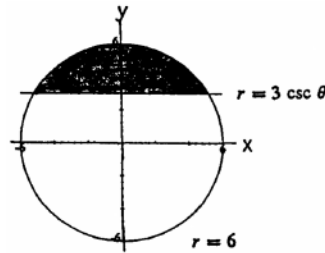

16. $r^2 = 6 \cos 2\theta$ and $r = \frac{3}{2} \sec \theta \Rightarrow \frac{9}{4} \sec^2 \theta = 6 \cos 2\theta \Rightarrow \frac{9}{24} = \cos^2 \theta \cos 2\theta \Rightarrow \frac{3}{8} = (\cos^2 \theta) (2 \cos^2 \theta - 1)$

$$\Rightarrow \frac{3}{8} = 2 \cos^4 \theta - \cos^2 \theta \Rightarrow 2 \cos^4 \theta - \cos^2 \theta - \frac{3}{8} = 0 \Rightarrow 16 \cos^4 \theta - 8 \cos^2 \theta - 3 = 0$$

$$\Rightarrow (4 \cos^2 \theta + 1)(4 \cos^2 \theta - 3) = 0 \Rightarrow \cos^2 \theta = \frac{3}{4} \text{ or } \cos^2 \theta = -\frac{1}{4} \Rightarrow \cos \theta = \pm \frac{\sqrt{3}}{2} \text{ (the second equation has no real roots)}$$

$$\Rightarrow \theta = \frac{\pi}{6} \text{ (in the first quadrant); thus } A = 2 \int_0^{\pi/6} \frac{1}{2} \left(6 \cos 2\theta - \frac{9}{4} \sec^2 \theta\right) d\theta = \int_0^{\pi/6} \left(6 \cos 2\theta - \frac{9}{4} \sec^2 \theta\right) d\theta$$

$$= \left[3 \sin 2\theta - \frac{9}{4} \tan \theta\right]_0^{\pi/6} = 3 \left(\frac{\sqrt{3}}{2}\right) - \frac{9}{4\sqrt{3}} = \frac{3\sqrt{3}}{2} - \frac{3\sqrt{3}}{4} = \frac{3\sqrt{3}}{4}$$

17. (a) $r = \tan \theta$ and $r = \left(\frac{\sqrt{2}}{2}\right) \csc \theta \Rightarrow \tan \theta = \left(\frac{\sqrt{2}}{2}\right) \csc \theta$

$$\Rightarrow \sin^2 \theta = \left(\frac{\sqrt{2}}{2}\right) \cos \theta \Rightarrow 1 - \cos^2 \theta = \left(\frac{\sqrt{2}}{2}\right) \cos \theta$$

$$\Rightarrow \cos^2 \theta + \left(\frac{\sqrt{2}}{2}\right) \cos \theta - 1 = 0 \Rightarrow \cos \theta = -\sqrt{2} \text{ or } \frac{\sqrt{2}}{2}$$

$\frac{\sqrt{2}}{2}$ (use the quadratic formula) $\Rightarrow \theta = \frac{\pi}{4}$ (the solution in the first quadrant); therefore the area of R_1 is

$$A_1 = \int_0^{\pi/4} \frac{1}{2} \tan^2 \theta d\theta = \frac{1}{2} \int_0^{\pi/4} (\sec^2 \theta - 1) d\theta = \frac{1}{2} [\tan \theta - \theta]_0^{\pi/4} = \frac{1}{2} \left(\tan \frac{\pi}{4} - \frac{\pi}{4}\right) = \frac{1}{2} - \frac{\pi}{8};$$

$$AO = \left(\frac{\sqrt{2}}{2}\right) \csc \frac{\pi}{2} = \frac{\sqrt{2}}{2} \text{ and } OB = \left(\frac{\sqrt{2}}{2}\right) \csc \frac{\pi}{4} = 1 \Rightarrow AB = \sqrt{1^2 - \left(\frac{\sqrt{2}}{2}\right)^2} = \frac{\sqrt{2}}{2}$$

\Rightarrow the area of R_2 is $A_2 = \frac{1}{2} \left(\frac{\sqrt{2}}{2}\right) \left(\frac{\sqrt{2}}{2}\right) = \frac{1}{4}$; therefore the area of the region shaded in the text is

$2 \left(\frac{1}{2} - \frac{\pi}{8} + \frac{1}{4}\right) = \frac{3}{2} - \frac{\pi}{4}$. Note: The area must be found this way since no common interval generates the region. For example, the interval $0 \leq \theta \leq \frac{\pi}{4}$ generates the arc OB of $r = \tan \theta$ but does not generate the segment AB of the line $r = \frac{\sqrt{2}}{2} \csc \theta$.

Instead the interval generates the half-line from B to $+\infty$ on the line $r = \frac{\sqrt{2}}{2} \csc \theta$.

(b) $\lim_{\theta \rightarrow \pi/2^-} \tan \theta = \infty$ and the line $x = 1$ is $r = \sec \theta$ in polar coordinates; then $\lim_{\theta \rightarrow \pi/2^-} (\tan \theta - \sec \theta)$

$$= \lim_{\theta \rightarrow \pi/2^-} \left(\frac{\sin \theta}{\cos \theta} - \frac{1}{\cos \theta}\right) = \lim_{\theta \rightarrow \pi/2^-} \left(\frac{\sin \theta - 1}{\cos \theta}\right) = \lim_{\theta \rightarrow \pi/2^-} \left(\frac{-\cos \theta}{-\sin \theta}\right) = 0 \Rightarrow r = \tan \theta \text{ approaches}$$

$r = \sec \theta$ as $\theta \rightarrow \frac{\pi}{2}^- \Rightarrow r = \sec \theta$ (or $x = 1$) is a vertical asymptote of $r = \tan \theta$. Similarly, $r = -\sec \theta$

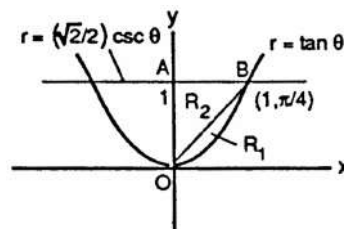

(or $x = -1$) is a vertical asymptote of $r = \tan \theta$.

18. It is not because the circle is generated twice from $\theta = 0$ to 2π . The area of the cardioid is

$$\begin{aligned} A &= 2 \int_0^\pi \frac{1}{2} (\cos \theta + 1)^2 d\theta = \int_0^\pi (\cos^2 \theta + 2 \cos \theta + 1) d\theta = \int_0^\pi \left(\frac{1 + \cos 2\theta}{2} + 2 \cos \theta + 1 \right) d\theta \\ &= \left[\frac{3\theta}{2} + \frac{\sin 2\theta}{4} + 2 \sin \theta \right]_0^\pi = \frac{3\pi}{2}. \text{ The area of the circle is } A = \pi \left(\frac{1}{2} \right)^2 = \frac{\pi}{4} \Rightarrow \text{the area requested is actually} \\ &\frac{3\pi}{2} - \frac{\pi}{4} = \frac{5\pi}{4} \end{aligned}$$

$$\begin{aligned} 19. r &= \theta^2, 0 \leq \theta \leq \sqrt{5} \Rightarrow \frac{dr}{d\theta} = 2\theta; \text{ therefore Length} = \int_0^{\sqrt{5}} \sqrt{(\theta^2)^2 + (2\theta)^2} d\theta = \int_0^{\sqrt{5}} \sqrt{\theta^4 + 4\theta^2} d\theta \\ &= \int_0^{\sqrt{5}} |\theta| \sqrt{\theta^2 + 4} d\theta = (\text{since } \theta \geq 0) \int_0^{\sqrt{5}} \theta \sqrt{\theta^2 + 4} d\theta; [u = \theta^2 + 4 \Rightarrow \frac{1}{2} du = \theta d\theta; \theta = 0 \Rightarrow u = 4, \\ &\theta = \sqrt{5} \Rightarrow u = 9] \rightarrow \int_4^9 \frac{1}{2} \sqrt{u} du = \frac{1}{2} \left[\frac{2}{3} u^{3/2} \right]_4^9 = \frac{19}{3} \end{aligned}$$

$$\begin{aligned} 20. r &= \frac{e^\theta}{\sqrt{2}}, 0 \leq \theta \leq \pi \Rightarrow \frac{dr}{d\theta} = \frac{e^\theta}{\sqrt{2}}; \text{ therefore Length} = \int_0^\pi \sqrt{\left(\frac{e^\theta}{\sqrt{2}} \right)^2 + \left(\frac{e^\theta}{\sqrt{2}} \right)^2} d\theta = \int_0^\pi \sqrt{2 \left(\frac{e^{2\theta}}{2} \right)} d\theta \\ &= \int_0^\pi e^\theta d\theta = [e^\theta]_0^\pi = e^\pi - 1 \end{aligned}$$

$$\begin{aligned} 21. r &= 1 + \cos \theta \Rightarrow \frac{dr}{d\theta} = -\sin \theta; \text{ therefore Length} = \int_0^{2\pi} \sqrt{(1 + \cos \theta)^2 + (-\sin \theta)^2} d\theta \\ &= 2 \int_0^\pi \sqrt{2 + 2 \cos \theta} d\theta = 2 \int_0^\pi \sqrt{\frac{4(1 + \cos \theta)}{2}} d\theta = 4 \int_0^\pi \sqrt{\frac{1 + \cos \theta}{2}} d\theta = 4 \int_0^\pi \cos \left(\frac{\theta}{2} \right) d\theta = 4 \left[2 \sin \frac{\theta}{2} \right]_0^\pi = 8 \end{aligned}$$

$$\begin{aligned} 22. r &= a \sin^2 \frac{\theta}{2}, 0 \leq \theta \leq \pi, a > 0 \Rightarrow \frac{dr}{d\theta} = a \sin \frac{\theta}{2} \cos \frac{\theta}{2}; \text{ therefore Length} = \int_0^\pi \sqrt{\left(a \sin^2 \frac{\theta}{2} \right)^2 + \left(a \sin \frac{\theta}{2} \cos \frac{\theta}{2} \right)^2} d\theta \\ &= \int_0^\pi \sqrt{a^2 \sin^4 \frac{\theta}{2} + a^2 \sin^2 \frac{\theta}{2} \cos^2 \frac{\theta}{2}} d\theta = \int_0^\pi a \left| \sin \frac{\theta}{2} \right| \sqrt{\sin^2 \frac{\theta}{2} + \cos^2 \frac{\theta}{2}} d\theta = (\text{since } 0 \leq \theta \leq \pi) a \int_0^\pi \sin \left(\frac{\theta}{2} \right) d\theta \\ &= [-2a \cos \frac{\theta}{2}]_0^\pi = 2a \end{aligned}$$

$$\begin{aligned} 23. r &= \frac{6}{1 + \cos \theta}, 0 \leq \theta \leq \frac{\pi}{2} \Rightarrow \frac{dr}{d\theta} = \frac{6 \sin \theta}{(1 + \cos \theta)^2}; \text{ therefore Length} = \int_0^{\pi/2} \sqrt{\left(\frac{6}{1 + \cos \theta} \right)^2 + \left(\frac{6 \sin \theta}{(1 + \cos \theta)^2} \right)^2} d\theta \\ &= \int_0^{\pi/2} \sqrt{\frac{36}{(1 + \cos \theta)^2} + \frac{36 \sin^2 \theta}{(1 + \cos \theta)^4}} d\theta = 6 \int_0^{\pi/2} \left| \frac{1}{1 + \cos \theta} \right| \sqrt{1 + \frac{\sin^2 \theta}{(1 + \cos \theta)^2}} d\theta \\ &= (\text{since } \frac{1}{1 + \cos \theta} > 0 \text{ on } 0 \leq \theta \leq \frac{\pi}{2}) 6 \int_0^{\pi/2} \left(\frac{1}{1 + \cos \theta} \right) \sqrt{\frac{1 + 2 \cos \theta + \cos^2 \theta + \sin^2 \theta}{(1 + \cos \theta)^2}} d\theta \\ &= 6 \int_0^{\pi/2} \left(\frac{1}{1 + \cos \theta} \right) \sqrt{\frac{2 + 2 \cos \theta}{(1 + \cos \theta)^2}} d\theta = 6\sqrt{2} \int_0^{\pi/2} \frac{d\theta}{(1 + \cos \theta)^{3/2}} = 6\sqrt{2} \int_0^{\pi/2} \frac{d\theta}{(2 \cos^2 \frac{\theta}{2})^{3/2}} = 3 \int_0^{\pi/2} \left| \sec^3 \frac{\theta}{2} \right| d\theta \\ &= 3 \int_0^{\pi/2} \sec^3 \frac{\theta}{2} d\theta = 6 \int_0^{\pi/4} \sec^3 u du = (\text{use tables}) 6 \left(\left[\frac{\sec u \tan u}{2} \right]_0^{\pi/4} + \frac{1}{2} \int_0^{\pi/4} \sec u du \right) \\ &= 6 \left(\frac{1}{\sqrt{2}} + \left[\frac{1}{2} \ln |\sec u + \tan u| \right]_0^{\pi/4} \right) = 3 \left[\sqrt{2} + \ln \left(1 + \sqrt{2} \right) \right] \end{aligned}$$

$$\begin{aligned} 24. r &= \frac{2}{1 - \cos \theta}, \frac{\pi}{2} \leq \theta \leq \pi \Rightarrow \frac{dr}{d\theta} = \frac{-2 \sin \theta}{(1 - \cos \theta)^2}; \text{ therefore Length} = \int_{\pi/2}^\pi \sqrt{\left(\frac{2}{1 - \cos \theta} \right)^2 + \left(\frac{-2 \sin \theta}{(1 - \cos \theta)^2} \right)^2} d\theta \\ &= \int_{\pi/2}^\pi \sqrt{\frac{4}{(1 - \cos \theta)^2} \left(1 + \frac{\sin^2 \theta}{(1 - \cos \theta)^2} \right)} d\theta = \int_{\pi/2}^\pi \left| \frac{2}{1 - \cos \theta} \right| \sqrt{\frac{(1 - \cos \theta)^2 + \sin^2 \theta}{(1 - \cos \theta)^2}} d\theta \\ &= (\text{since } 1 - \cos \theta \geq 0 \text{ on } \frac{\pi}{2} \leq \theta \leq \pi) 2 \int_{\pi/2}^\pi \left(\frac{1}{1 - \cos \theta} \right) \sqrt{\frac{1 - 2 \cos \theta + \cos^2 \theta + \sin^2 \theta}{(1 - \cos \theta)^2}} d\theta \\ &= 2 \int_{\pi/2}^\pi \left(\frac{1}{1 - \cos \theta} \right) \sqrt{\frac{2 - 2 \cos \theta}{(1 - \cos \theta)^2}} d\theta = 2\sqrt{2} \int_{\pi/2}^\pi \frac{d\theta}{(1 - \cos \theta)^{3/2}} = 2\sqrt{2} \int_{\pi/2}^\pi \frac{d\theta}{(2 \sin^2 \frac{\theta}{2})^{3/2}} = \int_{\pi/2}^\pi \left| \csc^3 \frac{\theta}{2} \right| d\theta \\ &= \int_{\pi/2}^\pi \csc^3 \left(\frac{\theta}{2} \right) d\theta = (\text{since } \csc \frac{\theta}{2} \geq 0 \text{ on } \frac{\pi}{2} \leq \theta \leq \pi) 2 \int_{\pi/4}^{\pi/2} \csc^3 u du = (\text{use tables}) \end{aligned}$$

$$2\left(\left[-\frac{\csc u \cot u}{2}\right]_{\pi/4}^{\pi/2} + \frac{1}{2} \int_{\pi/4}^{\pi/2} \csc u \, du\right) = 2\left(\frac{1}{\sqrt{2}} - \left[\frac{1}{2} \ln |\csc u + \cot u|\right]_{\pi/4}^{\pi/2}\right) = 2\left[\frac{1}{\sqrt{2}} + \frac{1}{2} \ln(\sqrt{2} + 1)\right]$$

$$= \sqrt{2} + \ln(1 + \sqrt{2})$$

25. $r = \cos^3 \frac{\theta}{3} \Rightarrow \frac{dr}{d\theta} = -\sin \frac{\theta}{3} \cos^2 \frac{\theta}{3}$; therefore Length $= \int_0^{\pi/4} \sqrt{(\cos^3 \frac{\theta}{3})^2 + (-\sin \frac{\theta}{3} \cos^2 \frac{\theta}{3})^2} \, d\theta$

$$= \int_0^{\pi/4} \sqrt{\cos^6 \left(\frac{\theta}{3}\right) + \sin^2 \left(\frac{\theta}{3}\right) \cos^4 \left(\frac{\theta}{3}\right)} \, d\theta = \int_0^{\pi/4} \left(\cos^2 \frac{\theta}{3}\right) \sqrt{\cos^2 \left(\frac{\theta}{3}\right) + \sin^2 \left(\frac{\theta}{3}\right)} \, d\theta = \int_0^{\pi/4} \cos^2 \left(\frac{\theta}{3}\right) \, d\theta$$

$$= \int_0^{\pi/4} \frac{1 + \cos \left(\frac{2\theta}{3}\right)}{2} \, d\theta = \frac{1}{2} \left[\theta + \frac{3}{2} \sin \frac{2\theta}{3}\right]_0^{\pi/4} = \frac{\pi}{8} + \frac{3}{8}$$

26. $r = \sqrt{1 + \sin 2\theta}$, $0 \leq \theta \leq \pi\sqrt{2} \Rightarrow \frac{dr}{d\theta} = \frac{1}{2}(1 + \sin 2\theta)^{-1/2}(2 \cos 2\theta) = (\cos 2\theta)(1 + \sin 2\theta)^{-1/2}$; therefore

$$\text{Length} = \int_0^{\pi\sqrt{2}} \sqrt{(1 + \sin 2\theta) + \frac{\cos^2 2\theta}{(1 + \sin 2\theta)}} \, d\theta = \int_0^{\pi\sqrt{2}} \sqrt{\frac{1 + 2 \sin 2\theta + \sin^2 2\theta + \cos^2 2\theta}{1 + \sin 2\theta}} \, d\theta$$

$$= \int_0^{\pi\sqrt{2}} \sqrt{\frac{2 + 2 \sin 2\theta}{1 + \sin 2\theta}} \, d\theta = \int_0^{\pi\sqrt{2}} \sqrt{2} \, d\theta = \left[\sqrt{2} \theta\right]_0^{\pi\sqrt{2}} = 2\pi$$

27. $r = \sqrt{1 + \cos 2\theta} \Rightarrow \frac{dr}{d\theta} = \frac{1}{2}(1 + \cos 2\theta)^{-1/2}(-2 \sin 2\theta)$; therefore Length $= \int_0^{\pi\sqrt{2}} \sqrt{(1 + \cos 2\theta) + \frac{\sin^2 2\theta}{(1 + \cos 2\theta)}} \, d\theta$

$$= \int_0^{\pi\sqrt{2}} \sqrt{\frac{1 + 2 \cos 2\theta + \cos^2 2\theta + \sin^2 2\theta}{1 + \cos 2\theta}} \, d\theta = \int_0^{\pi\sqrt{2}} \sqrt{\frac{2 + 2 \cos 2\theta}{1 + \cos 2\theta}} \, d\theta = \int_0^{\pi\sqrt{2}} \sqrt{2} \, d\theta = \left[\sqrt{2} \theta\right]_0^{\pi\sqrt{2}} = 2\pi$$

28. (a) $r = a \Rightarrow \frac{dr}{d\theta} = 0$; Length $= \int_0^{2\pi} \sqrt{a^2 + 0^2} \, d\theta = \int_0^{2\pi} |a| \, d\theta = [a\theta]_0^{2\pi} = 2\pi a$

(b) $r = a \cos \theta \Rightarrow \frac{dr}{d\theta} = -a \sin \theta$; Length $= \int_0^{\pi} \sqrt{(a \cos \theta)^2 + (-a \sin \theta)^2} \, d\theta = \int_0^{\pi} \sqrt{a^2 (\cos^2 \theta + \sin^2 \theta)} \, d\theta$

$$= \int_0^{\pi} |a| \, d\theta = [a\theta]_0^{\pi} = \pi a$$

(c) $r = a \sin \theta \Rightarrow \frac{dr}{d\theta} = a \cos \theta$; Length $= \int_0^{\pi} \sqrt{(a \cos \theta)^2 + (a \sin \theta)^2} \, d\theta = \int_0^{\pi} \sqrt{a^2 (\cos^2 \theta + \sin^2 \theta)} \, d\theta$

$$= \int_0^{\pi} |a| \, d\theta = [a\theta]_0^{\pi} = \pi a$$

29. $r = \sqrt{\cos 2\theta}$, $0 \leq \theta \leq \frac{\pi}{4} \Rightarrow \frac{dr}{d\theta} = \frac{1}{2}(\cos 2\theta)^{-1/2}(-\sin 2\theta)(2) = \frac{-\sin 2\theta}{\sqrt{\cos 2\theta}}$; therefore Surface Area

$$= \int_0^{\pi/4} (2\pi r \cos \theta) \sqrt{(\sqrt{\cos 2\theta})^2 + \left(\frac{-\sin 2\theta}{\sqrt{\cos 2\theta}}\right)^2} \, d\theta = \int_0^{\pi/4} (2\pi \sqrt{\cos 2\theta}) (\cos \theta) \sqrt{\cos 2\theta + \frac{\sin^2 2\theta}{\cos 2\theta}} \, d\theta$$

$$= \int_0^{\pi/4} (2\pi \sqrt{\cos 2\theta}) (\cos \theta) \sqrt{\frac{1}{\cos 2\theta}} \, d\theta = \int_0^{\pi/4} 2\pi \cos \theta \, d\theta = [2\pi \sin \theta]_0^{\pi/4} = \pi\sqrt{2}$$

30. $r = \sqrt{2}e^{\theta/2}$, $0 \leq \theta \leq \frac{\pi}{2} \Rightarrow \frac{dr}{d\theta} = \sqrt{2} \left(\frac{1}{2}\right) e^{\theta/2} = \frac{\sqrt{2}}{2} e^{\theta/2}$; therefore Surface Area

$$= \int_0^{\pi/2} (2\pi \sqrt{2} e^{\theta/2}) (\sin \theta) \sqrt{(\sqrt{2} e^{\theta/2})^2 + \left(\frac{\sqrt{2}}{2} e^{\theta/2}\right)^2} \, d\theta = \int_0^{\pi/2} (2\pi \sqrt{2} e^{\theta/2}) (\sin \theta) \sqrt{2e^{\theta} + \frac{1}{2} e^{\theta}} \, d\theta$$

$$= \int_0^{\pi/2} (2\pi \sqrt{2} e^{\theta/2}) (\sin \theta) \sqrt{\frac{5}{2} e^{\theta}} \, d\theta = \int_0^{\pi/2} (2\pi \sqrt{2} e^{\theta/2}) (\sin \theta) \left(\frac{\sqrt{5}}{2} e^{\theta/2}\right) \, d\theta = 2\pi\sqrt{5} \int_0^{\pi/2} e^{\theta} \sin \theta \, d\theta$$

$$= 2\pi\sqrt{5} \left[\frac{e^{\theta}}{2} (\sin \theta - \cos \theta)\right]_0^{\pi/2} = \pi\sqrt{5} (e^{\pi/2} + 1) \text{ where we integrated by parts}$$

31. $r^2 = \cos 2\theta \Rightarrow r = \pm \sqrt{\cos 2\theta}$; use $r = \sqrt{\cos 2\theta}$ on $[0, \frac{\pi}{4}] \Rightarrow \frac{dr}{d\theta} = \frac{1}{2}(\cos 2\theta)^{-1/2}(-\sin 2\theta)(2) = \frac{-\sin 2\theta}{\sqrt{\cos 2\theta}}$;

therefore Surface Area $= 2 \int_0^{\pi/4} (2\pi \sqrt{\cos 2\theta}) (\sin \theta) \sqrt{\cos 2\theta + \frac{\sin^2 2\theta}{\cos 2\theta}} \, d\theta = 4\pi \int_0^{\pi/4} \sqrt{\cos 2\theta} (\sin \theta) \sqrt{\frac{1}{\cos 2\theta}} \, d\theta$

$$= 4\pi \int_0^{\pi/4} \sin \theta \, d\theta = 4\pi [-\cos \theta]_0^{\pi/4} = 4\pi \left[-\frac{\sqrt{2}}{2} - (-1)\right] = 2\pi (2 - \sqrt{2})$$

$$\begin{aligned}
32. \quad r = 2a \cos \theta &\Rightarrow \frac{dr}{d\theta} = -2a \sin \theta; \text{ therefore Surface Area} = \int_0^\pi 2\pi(2a \cos \theta)(\cos \theta) \sqrt{(2a \cos \theta)^2 + (-2a \sin \theta)^2} d\theta \\
&= 4a\pi \int_0^\pi (\cos^2 \theta) \sqrt{4a^2 (\cos^2 \theta + \sin^2 \theta)} d\theta = 8a\pi \int_0^\pi (\cos^2 \theta) |a| d\theta = 8a^2\pi \int_0^\pi \cos^2 \theta d\theta \\
&= 8a^2\pi \int_0^\pi \left(\frac{1+\cos 2\theta}{2}\right) d\theta = 4a^2\pi \int_0^\pi (1 + \cos 2\theta) d\theta = 4a^2\pi \left[\theta + \frac{1}{2} \sin 2\theta\right]_0^\pi = 4a^2\pi^2
\end{aligned}$$

$$\begin{aligned}
33. \quad \text{Let } r = f(\theta). \text{ Then } x = f(\theta) \cos \theta &\Rightarrow \frac{dx}{d\theta} = f'(\theta) \cos \theta - f(\theta) \sin \theta \Rightarrow \left(\frac{dx}{d\theta}\right)^2 = [f'(\theta) \cos \theta - f(\theta) \sin \theta]^2 \\
&= [f'(\theta)]^2 \cos^2 \theta - 2f'(\theta) f(\theta) \sin \theta \cos \theta + [f(\theta)]^2 \sin^2 \theta; \quad y = f(\theta) \sin \theta \Rightarrow \frac{dy}{d\theta} = f'(\theta) \sin \theta + f(\theta) \cos \theta \\
&\Rightarrow \left(\frac{dy}{d\theta}\right)^2 = [f'(\theta) \sin \theta + f(\theta) \cos \theta]^2 = [f'(\theta)]^2 \sin^2 \theta + 2f'(\theta)f(\theta) \sin \theta \cos \theta + [f(\theta)]^2 \cos^2 \theta. \text{ Therefore} \\
\left(\frac{dx}{d\theta}\right)^2 + \left(\frac{dy}{d\theta}\right)^2 &= [f'(\theta)]^2 (\cos^2 \theta + \sin^2 \theta) + [f(\theta)]^2 (\cos^2 \theta + \sin^2 \theta) = [f'(\theta)]^2 + [f(\theta)]^2 = r^2 + \left(\frac{dr}{d\theta}\right)^2.
\end{aligned}$$

$$\text{Thus, } L = \int_\alpha^\beta \sqrt{\left(\frac{dx}{d\theta}\right)^2 + \left(\frac{dy}{d\theta}\right)^2} d\theta = \int_\alpha^\beta \sqrt{r^2 + \left(\frac{dr}{d\theta}\right)^2} d\theta.$$

$$34. \quad (\text{a}) \quad r_{\text{av}} = \frac{1}{2\pi-0} \int_0^{2\pi} a(1 - \cos \theta) d\theta = \frac{a}{2\pi} [\theta - \sin \theta]_0^{2\pi} = a$$

$$(\text{b}) \quad r_{\text{av}} = \frac{1}{2\pi-0} \int_0^{2\pi} a d\theta = \frac{1}{2\pi} [a\theta]_0^{2\pi} = a$$

$$(\text{c}) \quad r_{\text{av}} = \frac{1}{\left(\frac{\pi}{2}\right) - \left(-\frac{\pi}{2}\right)} \int_{-\pi/2}^{\pi/2} a \cos \theta d\theta = \frac{1}{\pi} [a \sin \theta]_{-\pi/2}^{\pi/2} = \frac{2a}{\pi}$$

$$\begin{aligned}
35. \quad r = 2f(\theta), \alpha \leq \theta \leq \beta &\Rightarrow \frac{dr}{d\theta} = 2f'(\theta) \Rightarrow r^2 + \left(\frac{dr}{d\theta}\right)^2 = [2f(\theta)]^2 + [2f'(\theta)]^2 \Rightarrow \text{Length} = \int_\alpha^\beta \sqrt{4[f(\theta)]^2 + 4[f'(\theta)]^2} d\theta \\
&= 2 \int_\alpha^\beta \sqrt{[f(\theta)]^2 + [f'(\theta)]^2} d\theta \text{ which is twice the length of the curve } r = f(\theta) \text{ for } \alpha \leq \theta \leq \beta.
\end{aligned}$$

$$\begin{aligned}
36. \quad \text{Again } r = 2f(\theta) &\Rightarrow r^2 + \left(\frac{dr}{d\theta}\right)^2 = [2f(\theta)]^2 + [2f'(\theta)]^2 \Rightarrow \text{Surface Area} = \int_\alpha^\beta 2\pi[2f(\theta) \sin \theta] \sqrt{4[f(\theta)]^2 + 4[f'(\theta)]^2} d\theta \\
&= 4 \int_\alpha^\beta 2\pi[f(\theta) \sin \theta] \sqrt{[f(\theta)]^2 + [f'(\theta)]^2} d\theta \text{ which is four times the area of the surface generated by revolving} \\
&r = f(\theta) \text{ about the x-axis for } \alpha \leq \theta \leq \beta.
\end{aligned}$$

$$\begin{aligned}
37. \quad \bar{x} &= \frac{\frac{2}{3} \int_0^{2\pi} r^3 \cos \theta d\theta}{\int_0^{2\pi} r^2 d\theta} = \frac{\frac{2}{3} \int_0^{2\pi} [a(1 + \cos \theta)]^3 (\cos \theta) d\theta}{\int_0^{2\pi} [a(1 + \cos \theta)]^2 d\theta} = \frac{\frac{2}{3} a^3 \int_0^{2\pi} (1 + 3 \cos \theta + 3 \cos^2 \theta + \cos^3 \theta) (\cos \theta) d\theta}{a^2 \int_0^{2\pi} (1 + 2 \cos \theta + \cos^2 \theta) d\theta} \\
&= \frac{\frac{2}{3} a \int_0^{2\pi} \left[\cos \theta + 3 \left(\frac{1 + \cos 2\theta}{2}\right) + 3(1 - \sin^2 \theta) (\cos \theta) + \left(\frac{1 + \cos 2\theta}{2}\right)^2\right] d\theta}{\int_0^{2\pi} [1 + 2 \cos \theta + \left(\frac{1 + \cos 2\theta}{2}\right)] d\theta} = \text{(After considerable algebra using}
\end{aligned}$$

$$\text{the identity } \cos^2 A = \frac{1 + \cos 2A}{2}) \quad \frac{a \int_0^{2\pi} \left(\frac{15}{12} + \frac{8}{3} \cos \theta + \frac{4}{3} \cos 2\theta - 2 \cos \theta \sin^2 \theta + \frac{1}{12} \cos 4\theta\right) d\theta}{\int_0^{2\pi} \left(\frac{3}{2} + 2 \cos \theta + \frac{1}{2} \cos 2\theta\right) d\theta}$$

$$= \frac{a \left[\frac{15}{12} \theta + \frac{8}{3} \sin \theta + \frac{2}{3} \sin 2\theta - \frac{2}{3} \sin^3 \theta + \frac{1}{48} \sin 4\theta\right]_0^{2\pi}}{\left[\frac{3}{2} \theta + 2 \sin \theta + \frac{1}{4} \sin 2\theta\right]_0^{2\pi}} = \frac{a \left(\frac{15}{6} \pi\right)}{3\pi} = \frac{5}{6} a;$$

$$\bar{y} = \frac{\frac{2}{3} \int_0^{2\pi} r^3 \sin \theta d\theta}{\int_0^{2\pi} r^2 d\theta} = \frac{\frac{2}{3} \int_0^{2\pi} [a(1 + \cos \theta)]^3 (\sin \theta) d\theta}{3\pi}; \quad [u = a(1 + \cos \theta) \Rightarrow -\frac{1}{a} du = \sin \theta d\theta; \theta = 0 \Rightarrow u = 2a;$$

$$\theta = 2\pi \Rightarrow u = 2a] \rightarrow \frac{\frac{2}{3} \int_{2a}^{-\frac{1}{a}} u^3 du}{3\pi} = \frac{0}{3\pi} = 0. \text{ Therefore the centroid is } (\bar{x}, \bar{y}) = \left(\frac{5}{6} a, 0\right)$$

$$38. \quad \int_0^\pi r^2 d\theta = \int_0^\pi a^2 d\theta = [a^2 \theta]_0^\pi = a^2 \pi; \quad \bar{x} = \frac{\frac{2}{3} \int_0^\pi r^3 \cos \theta d\theta}{\int_0^\pi r^2 d\theta} = \frac{\frac{2}{3} \int_0^\pi a^3 \cos \theta d\theta}{a^2 \pi} = \frac{\frac{2}{3} a^3 [\sin \theta]_0^\pi}{a^2 \pi} = \frac{0}{a^2 \pi} = 0;$$

$$\bar{y} = \frac{\frac{2}{3} \int_0^\pi r^3 \sin \theta d\theta}{\int_0^\pi r^2 d\theta} = \frac{\frac{2}{3} \int_0^\pi a^3 \sin \theta d\theta}{a^2 \pi} = \frac{\frac{2}{3} a^3 [-\cos \theta]_0^\pi}{a^2 \pi} = \frac{\left(\frac{4}{3}\right) a^3}{a^2 \pi} = \frac{4a}{3\pi}. \text{ Therefore the centroid is } (\bar{x}, \bar{y}) = \left(0, \frac{4a}{3\pi}\right).$$

10.8 CONIC SECTIONS IN POLAR COORDINATES

$$1. \quad r \cos\left(\theta - \frac{\pi}{6}\right) = 5 \Rightarrow r\left(\cos\theta \cos\frac{\pi}{6} + \sin\theta \sin\frac{\pi}{6}\right) = 5 \Rightarrow \frac{\sqrt{3}}{2}r \cos\theta + \frac{1}{2}r \sin\theta = 5 \Rightarrow \frac{\sqrt{3}}{2}x + \frac{1}{2}y = 5 \Rightarrow \sqrt{3}x + y = 10 \Rightarrow y = -\sqrt{3}x + 10$$

$$2. \quad r \cos\left(\theta - \frac{3\pi}{4}\right) = 2 \Rightarrow r\left(\cos\theta \cos\frac{3\pi}{4} + \sin\theta \sin\frac{3\pi}{4}\right) = 2 \Rightarrow -\frac{\sqrt{2}}{2}r \cos\theta + \frac{\sqrt{2}}{2}r \sin\theta = 2 \Rightarrow -\frac{\sqrt{2}}{2}x + \frac{\sqrt{2}}{2}y = 2 \Rightarrow -\sqrt{2}x + \sqrt{2}y = 4 \Rightarrow y = x + 2\sqrt{2}$$

$$3. \quad r \cos\left(\theta - \frac{4\pi}{3}\right) = 3 \Rightarrow r\left(\cos\theta \cos\frac{4\pi}{3} + \sin\theta \sin\frac{4\pi}{3}\right) = 3 \Rightarrow -\frac{1}{2}r \cos\theta - \frac{\sqrt{3}}{2}r \sin\theta = 3 \Rightarrow -\frac{1}{2}x - \frac{\sqrt{3}}{2}y = 3 \Rightarrow x + \sqrt{3}y = -6 \Rightarrow y = -\frac{\sqrt{3}}{3}x - 2\sqrt{3}$$

$$4. \quad r \cos\left(\theta - \left(-\frac{\pi}{4}\right)\right) = 4 \Rightarrow r \cos\left(\theta + \frac{\pi}{4}\right) = 4 \Rightarrow r\left(\cos\theta \cos\frac{\pi}{4} - \sin\theta \sin\frac{\pi}{4}\right) = 4 \Rightarrow \frac{\sqrt{2}}{2}r \cos\theta - \frac{\sqrt{2}}{2}r \sin\theta = 4 \Rightarrow \frac{\sqrt{2}}{2}x - \frac{\sqrt{2}}{2}y = 4 \Rightarrow \sqrt{2}x - \sqrt{2}y = 8 \Rightarrow y = x - 4\sqrt{2}$$

$$5. \quad r \cos\left(\theta - \frac{\pi}{4}\right) = \sqrt{2} \Rightarrow r\left(\cos\theta \cos\frac{\pi}{4} + \sin\theta \sin\frac{\pi}{4}\right) = \sqrt{2} \Rightarrow \frac{1}{\sqrt{2}}r \cos\theta + \frac{1}{\sqrt{2}}r \sin\theta = \sqrt{2} \Rightarrow \frac{1}{\sqrt{2}}x + \frac{1}{\sqrt{2}}y = \sqrt{2} \Rightarrow x + y = 2 \Rightarrow y = 2 - x$$

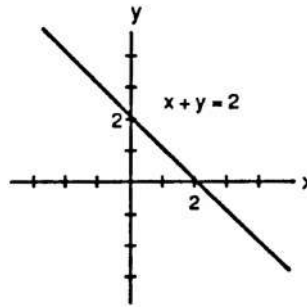

$$6. \quad r \cos\left(\theta + \frac{3\pi}{4}\right) = 1 \Rightarrow r\left(\cos\theta \cos\frac{3\pi}{4} - \sin\theta \sin\frac{3\pi}{4}\right) = 1 \Rightarrow -\frac{\sqrt{2}}{2}r \cos\theta - \frac{\sqrt{2}}{2}r \sin\theta = 1 \Rightarrow x + y = -\sqrt{2} \Rightarrow y = -x - \sqrt{2}$$

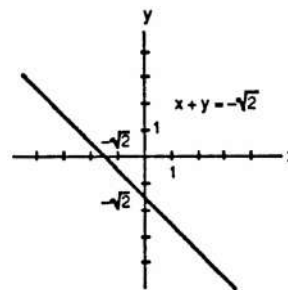

$$7. \quad r \cos\left(\theta - \frac{2\pi}{3}\right) = 3 \Rightarrow r\left(\cos\theta \cos\frac{2\pi}{3} + \sin\theta \sin\frac{2\pi}{3}\right) = 3 \Rightarrow -\frac{1}{2}r \cos\theta + \frac{\sqrt{3}}{2}r \sin\theta = 3 \Rightarrow -\frac{1}{2}x + \frac{\sqrt{3}}{2}y = 3 \Rightarrow -x + \sqrt{3}y = 6 \Rightarrow y = \frac{\sqrt{3}}{3}x + 2\sqrt{3}$$

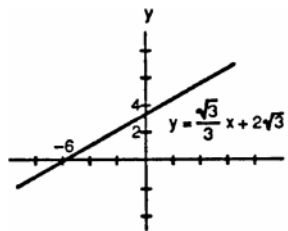

$$\begin{aligned}
 8. \quad r \cos\left(\theta + \frac{\pi}{3}\right) &= 2 \Rightarrow r\left(\cos\theta \cos\frac{\pi}{3} - \sin\theta \sin\frac{\pi}{3}\right) = 2 \\
 &\Rightarrow \frac{1}{2}r \cos\theta - \frac{\sqrt{3}}{2}r \sin\theta = 2 \Rightarrow \frac{1}{2}x - \frac{\sqrt{3}}{2}y = 2 \\
 &\Rightarrow x - \sqrt{3}y = 4 \Rightarrow y = \frac{\sqrt{3}}{3}x - \frac{4\sqrt{3}}{3}
 \end{aligned}$$

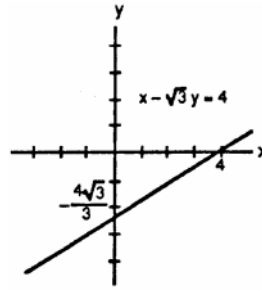

$$\begin{aligned}
 9. \quad \sqrt{2}x + \sqrt{2}y &= 6 \Rightarrow \sqrt{2}r \cos\theta + \sqrt{2}r \sin\theta = 6 \Rightarrow r\left(\frac{\sqrt{2}}{2}\cos\theta + \frac{\sqrt{2}}{2}\sin\theta\right) = 3 \\
 &\Rightarrow r\left(\cos\frac{\pi}{4}\cos\theta + \sin\frac{\pi}{4}\sin\theta\right) = 3 \Rightarrow r \cos\left(\theta - \frac{\pi}{4}\right) = 3
 \end{aligned}$$

$$\begin{aligned}
 10. \quad \sqrt{3}x - y &= 1 \Rightarrow \sqrt{3}r \cos\theta - r \sin\theta = 1 \Rightarrow r\left(\frac{\sqrt{3}}{2}\cos\theta - \frac{1}{2}\sin\theta\right) = \frac{1}{2} \\
 &\Rightarrow r\left(\cos\frac{\pi}{6}\cos\theta - \sin\frac{\pi}{6}\sin\theta\right) = \frac{1}{2} \Rightarrow r \cos\left(\theta + \frac{\pi}{6}\right) = \frac{1}{2}
 \end{aligned}$$

$$11. \quad y = -5 \Rightarrow r \sin\theta = -5 \Rightarrow -r \sin\theta = 5 \Rightarrow r \sin(-\theta) = 5 \Rightarrow r \cos\left(\frac{\pi}{2} - (-\theta)\right) = 5 \Rightarrow r \cos\left(\theta + \frac{\pi}{2}\right) = 5$$

$$12. \quad x = -4 \Rightarrow r \cos\theta = -4 \Rightarrow -r \cos\theta = 4 \Rightarrow r \cos(\theta - \pi) = 4$$

$$13. \quad r = 2(4) \cos\theta = 8 \cos\theta$$

$$14. \quad r = -2(1) \sin\theta = -2 \sin\theta$$

$$15. \quad r = 2\sqrt{2} \sin\theta$$

$$16. \quad r = -2\left(\frac{1}{2}\right) \cos\theta = -\cos\theta$$

17.

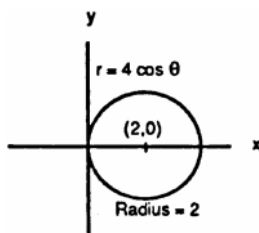

18.

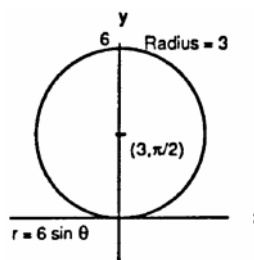

19.

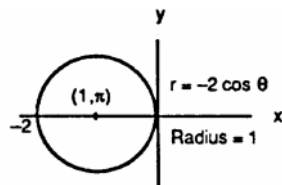

20.

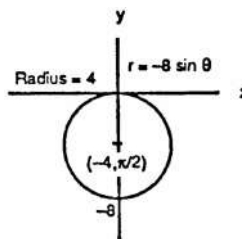

21. $(x - 6)^2 + y^2 = 36 \Rightarrow C = (6, 0), a = 6$
 $\Rightarrow r = 12 \cos \theta$ is the polar equation

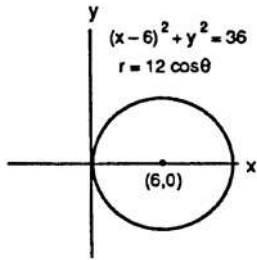

22. $(x + 2)^2 + y^2 = 4 \Rightarrow C = (-2, 0), a = 2$
 $\Rightarrow r = -4 \cos \theta$ is the polar equation

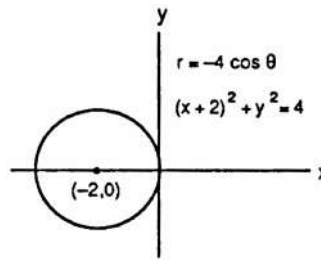

23. $x^2 + (y - 5)^2 = 25 \Rightarrow C = (0, 5), a = 5$
 $\Rightarrow r = 10 \sin \theta$ is the polar equation

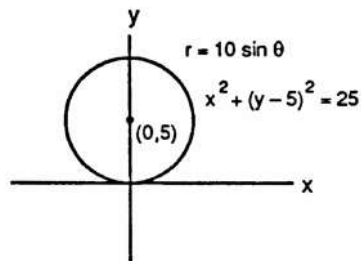

24. $x^2 + (y + 7)^2 = 49 \Rightarrow C = (0, -7), a = 7$
 $\Rightarrow r = -14 \sin \theta$ is the polar equation

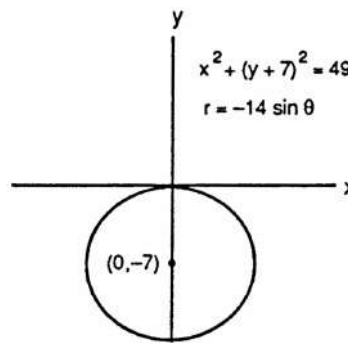

25. $x^2 + 2x + y^2 = 0 \Rightarrow (x + 1)^2 + y^2 = 1$
 $\Rightarrow C = (-1, 0), a = 1 \Rightarrow r = -2 \cos \theta$ is the polar equation

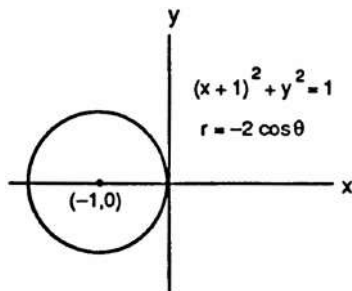

26. $x^2 - 16x + y^2 = 0 \Rightarrow (x - 8)^2 + y^2 = 64$
 $\Rightarrow C = (8, 0), a = 8 \Rightarrow r = 16 \cos \theta$ is the polar equation

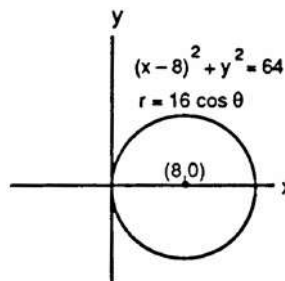

27. $x^2 + y^2 + y = 0 \Rightarrow x^2 + (y + \frac{1}{2})^2 = \frac{1}{4}$
 $\Rightarrow C = (0, -\frac{1}{2}), a = \frac{1}{2} \Rightarrow r = -\sin \theta$ is the polar equation

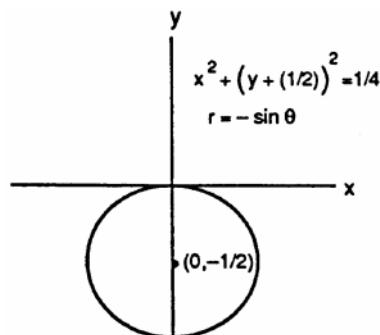

28. $x^2 + y^2 - \frac{4}{3}y = 0 \Rightarrow x^2 + (y - \frac{2}{3})^2 = \frac{4}{9}$
 $\Rightarrow C = (0, \frac{2}{3}), a = \frac{2}{3} \Rightarrow r = \frac{4}{3} \sin \theta$ is the polar equation

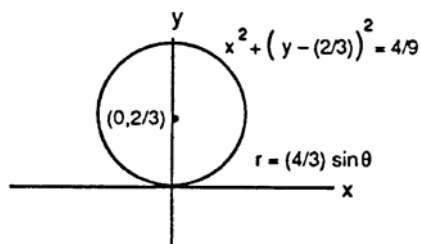

29. $e = 1, x = 2 \Rightarrow k = 2 \Rightarrow r = \frac{2(1)}{1+(1)\cos\theta} = \frac{2}{1+\cos\theta}$

30. $e = 1, y = 2 \Rightarrow k = 2 \Rightarrow r = \frac{2(1)}{1+(1)\sin\theta} = \frac{2}{1+\sin\theta}$

31. $e = 5, y = -6 \Rightarrow k = 6 \Rightarrow r = \frac{6(5)}{1-5\sin\theta} = \frac{30}{1-5\sin\theta}$

32. $e = 2, x = 4 \Rightarrow k = 4 \Rightarrow r = \frac{4(2)}{1+2\cos\theta} = \frac{8}{1+2\cos\theta}$

33. $e = \frac{1}{2}, x = 1 \Rightarrow k = 1 \Rightarrow r = \frac{(\frac{1}{2})(1)}{1+(\frac{1}{2})\cos\theta} = \frac{1}{2+\cos\theta}$

34. $e = \frac{1}{4}, x = -2 \Rightarrow k = 2 \Rightarrow r = \frac{(\frac{1}{4})(2)}{1-(\frac{1}{4})\cos\theta} = \frac{2}{4-\cos\theta}$

35. $e = \frac{1}{5}, x = -10 \Rightarrow k = 10 \Rightarrow r = \frac{(\frac{1}{5})(10)}{1-(\frac{1}{5})\sin\theta} = \frac{10}{5-\sin\theta}$

36. $e = \frac{1}{3}, y = 6 \Rightarrow k = 6 \Rightarrow r = \frac{(\frac{1}{3})(6)}{1+(\frac{1}{3})\sin\theta} = \frac{6}{3+\sin\theta}$

37. $r = \frac{1}{1+\cos\theta} \Rightarrow e = 1, k = 1 \Rightarrow x = 1$

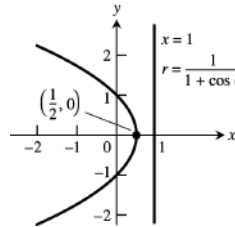

38. $r = \frac{6}{2+\cos\theta} = \frac{3}{1+(\frac{1}{2})\cos\theta} \Rightarrow e = \frac{1}{2}, k = 6 \Rightarrow x = 6;$

$a(1 - e^2) = ke \Rightarrow a\left[1 - \left(\frac{1}{2}\right)^2\right] = 3 \Rightarrow \frac{3}{4}a = 3$

$\Rightarrow a = 4 \Rightarrow ea = 2$

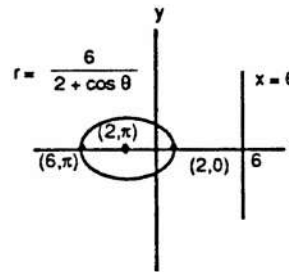

39. $r = \frac{25}{10-5\cos\theta} \Rightarrow r = \frac{(\frac{25}{10})}{1-(\frac{5}{10})\cos\theta} = \frac{(\frac{5}{2})}{1-(\frac{1}{2})\cos\theta}$

$\Rightarrow e = \frac{1}{2}, k = 5 \Rightarrow x = -5; a(1 - e^2) = ke$

$\Rightarrow a\left[1 - \left(\frac{1}{2}\right)^2\right] = \frac{5}{2} \Rightarrow \frac{3}{4}a = \frac{5}{2} \Rightarrow a = \frac{10}{3} \Rightarrow ea = \frac{5}{3}$

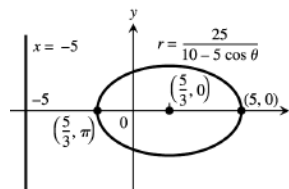

40. $r = \frac{4}{2-2\cos\theta} \Rightarrow r = \frac{2}{1-\cos\theta} \Rightarrow e = 1, k = 2 \Rightarrow x = -2$

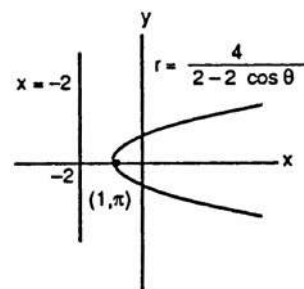

41. $r = \frac{400}{16 + 8 \sin \theta} \Rightarrow r = \frac{\left(\frac{400}{16}\right)}{1 + \left(\frac{8}{16}\right) \sin \theta} \Rightarrow r = \frac{25}{1 + \left(\frac{1}{2}\right) \sin \theta}$
 $e = \frac{1}{2}, k = 50 \Rightarrow y = 50; a(1 - e^2) = ke$
 $\Rightarrow a \left[1 - \left(\frac{1}{2}\right)^2\right] = 25 \Rightarrow \frac{3}{4}a = 25 \Rightarrow a = \frac{100}{3}$
 $\Rightarrow ea = \frac{50}{3}$

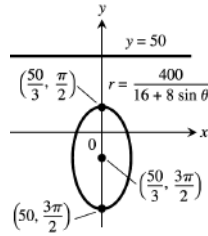

42. $r = \frac{12}{3 + 3 \sin \theta} \Rightarrow r = \frac{4}{1 + \sin \theta} \Rightarrow e = 1,$
 $k = 4 \Rightarrow y = 4$

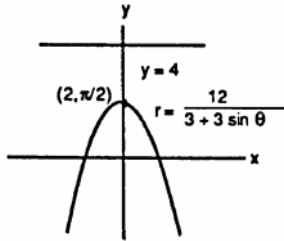

43. $r = \frac{8}{2 - 2 \sin \theta} \Rightarrow r = \frac{4}{1 - \sin \theta} \Rightarrow e = 1,$
 $k = 4 \Rightarrow y = -4$

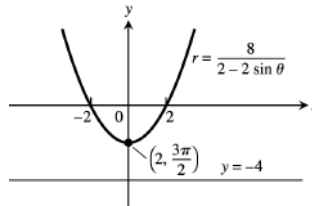

44. $r = \frac{4}{2 - \sin \theta} \Rightarrow r = \frac{2}{1 - \left(\frac{1}{2}\right) \sin \theta} \Rightarrow e = \frac{1}{2}, k = 4$
 $\Rightarrow y = -4; a(1 - e^2) = ke \Rightarrow a \left[1 - \left(\frac{1}{2}\right)^2\right] = 2$
 $\Rightarrow \frac{3}{4}a = 2 \Rightarrow a = \frac{8}{3} \Rightarrow ea = \frac{4}{3}$

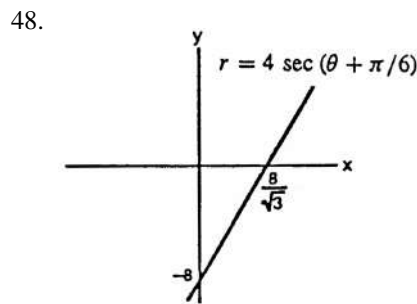
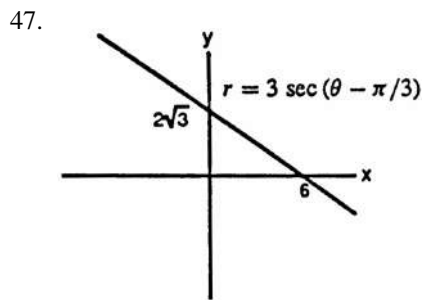
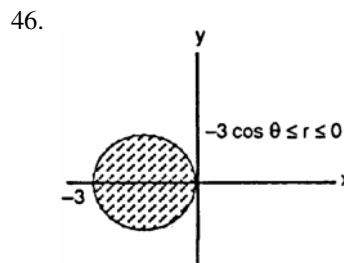
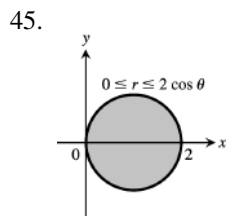
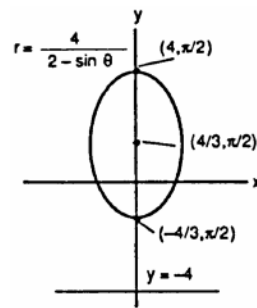

49.

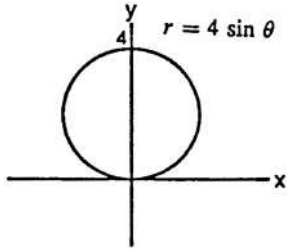

50.

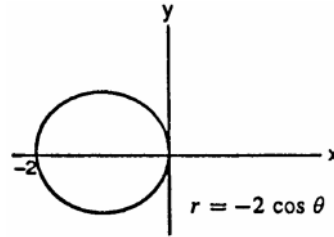

51.

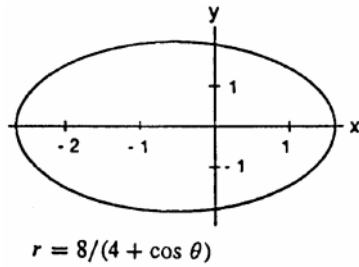

52.

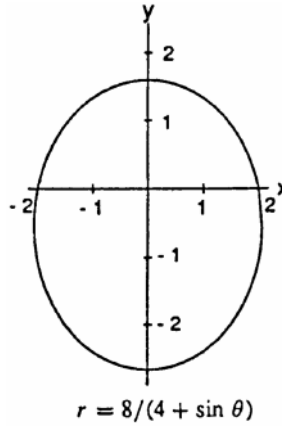

53.

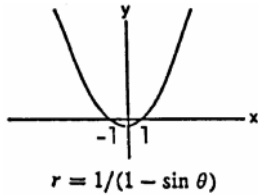

54.

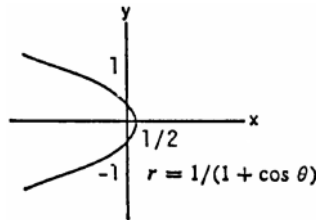

55.

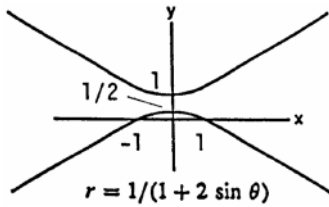

56.

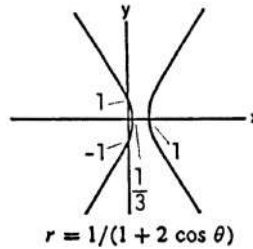

57. (a) Perihelion = $a - ae = a(1 - e)$, Aphelion = $ea + a = a(1 + e)$

(b)

Planet	Perihelion	Aphelion
Mercury	0.3075 AU	0.4667 AU
Venus	0.7184 AU	0.7282 AU
Earth	0.9833 AU	1.0167 AU
Mars	1.3817 AU	1.6663 AU
Jupiter	4.9512 AU	5.4548 AU
Saturn	9.0210 AU	10.0570 AU
Uranus	18.2977 AU	20.0623 AU
Neptune	29.8135 AU	30.3065 AU
Pluto	29.6549 AU	49.2251 AU

$$\begin{aligned}
 58. \text{ Mercury: } r &= \frac{(0.3871)(1-0.2056^2)}{1+0.2056 \cos \theta} = \frac{0.3707}{1+0.2056 \cos \theta} \\
 \text{ Venus: } r &= \frac{(0.7233)(1-0.0068^2)}{1+0.0068 \cos \theta} = \frac{0.7233}{1+0.0068 \cos \theta} \\
 \text{ Earth: } r &= \frac{1(1-0.0167^2)}{1+0.0167 \cos \theta} = \frac{0.9997}{1+0.0167 \cos \theta} \\
 \text{ Mars: } r &= \frac{(1.524)(1-0.0934^2)}{1+0.0934 \cos \theta} = \frac{1.511}{1+0.0934 \cos \theta} \\
 \text{ Jupiter: } r &= \frac{(5.203)(1-0.0484^2)}{1+0.0484 \cos \theta} = \frac{5.191}{1+0.0484 \cos \theta} \\
 \text{ Saturn: } r &= \frac{(9.539)(1-0.0543^2)}{1+0.0543 \cos \theta} = \frac{9.511}{1+0.0543 \cos \theta} \\
 \text{ Uranus: } r &= \frac{(19.18)(1-0.0460^2)}{1+0.0460 \cos \theta} = \frac{19.14}{1+0.0460 \cos \theta} \\
 \text{ Neptune: } r &= \frac{(30.06)(1-0.0082^2)}{1+0.0082 \cos \theta} = \frac{30.06}{1+0.0082 \cos \theta}
 \end{aligned}$$

59. (a) $r = 4 \sin \theta \Rightarrow r^2 = 4r \sin \theta \Rightarrow x^2 + y^2 = 4y$;
 $r = \sqrt{3} \sec \theta \Rightarrow r = \frac{\sqrt{3}}{\cos \theta} \Rightarrow r \cos \theta = \sqrt{3}$
 $\Rightarrow x = \sqrt{3}; x = \sqrt{3} \Rightarrow (\sqrt{3})^2 + y^2 = 4y$
 $\Rightarrow y^2 - 4y + 3 = 0 \Rightarrow (y-3)(y-1) = 0 \Rightarrow y = 3$
 or $y = 1$. Therefore in Cartesian coordinates, the points of intersection are $(\sqrt{3}, 3)$ and $(\sqrt{3}, 1)$. In polar coordinates, $4 \sin \theta = \sqrt{3} \sec \theta \Rightarrow 4 \sin \theta \cos \theta = \sqrt{3}$
 $\Rightarrow 2 \sin \theta \cos \theta = \frac{\sqrt{3}}{2} \Rightarrow \sin 2\theta = \frac{\sqrt{3}}{2} \Rightarrow 2\theta = \frac{\pi}{3}$ or $\frac{2\pi}{3}$
 $\Rightarrow \theta = \frac{\pi}{6}$ or $\frac{\pi}{3}; \theta = \frac{\pi}{6} \Rightarrow r = 2$, and $\theta = \frac{\pi}{3}$
 $\Rightarrow r = 2\sqrt{3} \Rightarrow (2, \frac{\pi}{6})$ and $(2\sqrt{3}, \frac{\pi}{3})$ are the points of intersection in polar coordinates.

(b)

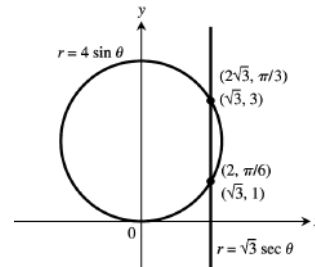

60. (a) $r = 8 \cos \theta \Rightarrow r^2 = 8r \cos \theta \Rightarrow x^2 + y^2 = 8x$
 $\Rightarrow x^2 - 8x + y^2 = 0 \Rightarrow (x-4)^2 + y^2 = 16$;
 $r = 2 \sec \theta \Rightarrow r = \frac{2}{\cos \theta} \Rightarrow r \cos \theta = 2$
 $\Rightarrow x = 2; x = 2 \Rightarrow 2^2 - 8(2) + y^2 = 0$
 $\Rightarrow y^2 = 12 \Rightarrow y = \pm 2\sqrt{3}$. Therefore $(2, \pm 2\sqrt{3})$ are the points of intersection in Cartesian coordinates.
 In polar coordinates, $8 \cos \theta = 2 \sec \theta \Rightarrow 8 \cos^2 \theta = 2$
 $\Rightarrow \cos^2 \theta = \frac{1}{4} \Rightarrow \cos \theta = \pm \frac{1}{2} \Rightarrow \theta = \frac{\pi}{3}, \frac{2\pi}{3}, \frac{4\pi}{3},$ or $\frac{5\pi}{3}; \theta = \frac{\pi}{3}$ and $\frac{5\pi}{3} \Rightarrow r = 4$, and $\theta = \frac{2\pi}{3}$ and $\frac{4\pi}{3}$
 $\Rightarrow r = -4 \Rightarrow (4, \frac{\pi}{3})$ and $(4, \frac{5\pi}{3})$ are the points of intersection in polar coordinates. The points $(-4, \frac{2\pi}{3})$ and $(-4, \frac{4\pi}{3})$ are the same points.

(b)

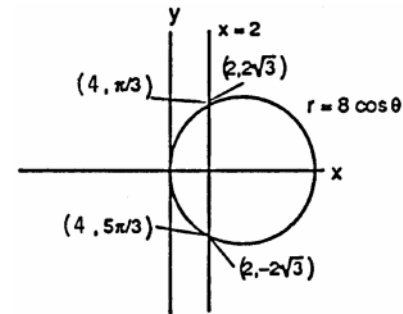

61. $r \cos \theta = 4 \Rightarrow x = 4 \Rightarrow k = 4$: parabola $\Rightarrow e = 1 \Rightarrow r = \frac{4}{1 + \cos \theta}$

62. $r \cos(\theta - \frac{\pi}{2}) = 2 \Rightarrow r(\cos \theta \cos \frac{\pi}{2} + \sin \theta \sin \frac{\pi}{2}) = 2 \Rightarrow r \sin \theta = 2 \Rightarrow y = 2 \Rightarrow k = 2$: parabola $\Rightarrow e = 1$
 $\Rightarrow r = \frac{2}{1 + \sin \theta}$

63. (a) Let the ellipse be the orbit, with the Sun at one focus.

$$\text{Then } r_{\max} = a + c \text{ and } r_{\min} = a - c \Rightarrow \frac{r_{\max} - r_{\min}}{r_{\max} + r_{\min}} = \frac{(a+c) - (a-c)}{(a+c) + (a-c)} = \frac{2c}{2a} = \frac{c}{a} = e$$

(b) Let F_1, F_2 be the foci. Then $PF_1 + PF_2 = 10$ where P is any point on the ellipse. If P is a vertex, then

$$PF_1 = a + c \text{ and } PF_2 = a - c$$

$$\Rightarrow (a + c) + (a - c) = 10$$

$$\Rightarrow 2a = 10 \Rightarrow a = 5. \text{ Since } e = \frac{c}{a} \text{ we have } 0.2 = \frac{c}{5}$$

$$\Rightarrow c = 1.0 \Rightarrow \text{the pins should be 2 inches apart.}$$

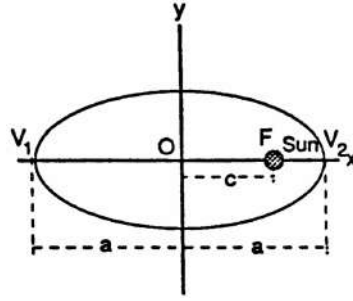

64. $e = 0.97$, Major axis = 36.18 AU $\Rightarrow a = 18.09$, Minor axis = 9.12 AU $\Rightarrow b = 4.56$ (1 AU $\approx 1.49 \times 10^8$ km)

$$(a) \ r = \frac{ke}{1+e \cos \theta} = \frac{a(1-e^2)}{1+e \cos \theta} = \frac{(18.09)[1-(0.97)^2]}{1+0.97 \cos \theta} = \frac{1.07}{1+0.97 \cos \theta} \text{ AU}$$

$$(b) \ \theta = 0 \Rightarrow r = \frac{1.07}{1+0.97} \approx 0.5431 \text{ AU} \approx 8.09 \times 10^7 \text{ km}$$

$$(c) \ \theta = \pi \Rightarrow r = \frac{1.07}{1-0.97} \approx 35.7 \text{ AU} \approx 5.32 \times 10^9 \text{ km}$$

65. $x^2 + y^2 - 2ay = 0 \Rightarrow (r \cos \theta)^2 + (r \sin \theta)^2 - 2ar \sin \theta = 0$

$$\Rightarrow r^2 \cos^2 \theta + r^2 \sin^2 \theta - 2ar \sin \theta = 0 \Rightarrow r^2 = 2ar \sin \theta$$

$$\Rightarrow r = 2a \sin \theta$$

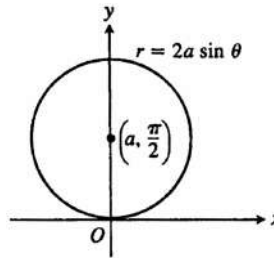

66. $y^2 = 4ax + 4a^2 \Rightarrow (r \sin \theta)^2 = 4ar \cos \theta + 4a^2 \Rightarrow r^2 \sin^2 \theta = 4ar \cos \theta + 4a^2$

$$\Rightarrow r^2 \cos^2 \theta + 4a^2 \Rightarrow r^2 (1 - \cos^2 \theta) = 4ar \cos \theta + 4a^2$$

$$\Rightarrow r^2 - r^2 \cos^2 \theta = 4ar \cos \theta + 4a^2 \Rightarrow r^2$$

$$= r^2 \cos^2 \theta + 4ar \cos \theta + 4a^2 \Rightarrow r^2 = (r \cos \theta + 2a)^2$$

$$\Rightarrow r = \pm (r \cos \theta + 2a) \Rightarrow r - r \cos \theta = 2a \text{ or}$$

$$r + r \cos \theta = -2a \Rightarrow r = \frac{2a}{1 - \cos \theta} \text{ or } r = \frac{-2a}{1 + \cos \theta};$$

the equations have the same graph, which is a parabola opening to the right

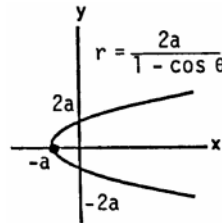

67. $x \cos \alpha + y \sin \alpha = p \Rightarrow r \cos \theta \cos \alpha + r \sin \theta \sin \alpha = p$

$$\Rightarrow r(\cos \theta \cos \alpha + \sin \theta \sin \alpha) = p \Rightarrow r \cos(\theta - \alpha) = p$$

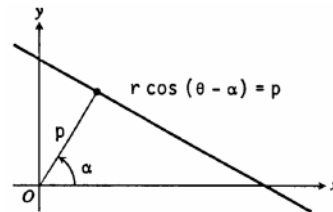

68. $(x^2 + y^2)^2 + 2ax(x^2 + y^2) - a^2y^2 = 0$

$$\Rightarrow (r^2)^2 + 2a(r \cos \theta)(r^2) - a^2(r \sin \theta)^2 = 0$$

$$\Rightarrow r^4 + 2ar^3 \cos \theta - a^2r^2 \sin^2 \theta = 0$$

$$\Rightarrow r^2 [r^2 + 2ar \cos \theta - a^2(1 - \cos^2 \theta)] = 0 \text{ (assume } r \neq 0)$$

$$\Rightarrow r^2 + 2ar \cos \theta - a^2 + a^2 \cos^2 \theta = 0$$

$$\Rightarrow (r^2 + 2ar \cos \theta + a^2 \cos^2 \theta) - a^2 = 0$$

$$\Rightarrow (r + a \cos \theta)^2 = a^2 \Rightarrow r + a \cos \theta = \pm a$$

$$\Rightarrow r = a(1 - \cos \theta) \text{ or } r = -a(1 + \cos \theta);$$

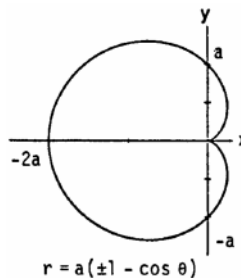

the equations have the same graph, which is a cardioid

69 - 70. Example CAS commands:

Maple:

```
with( plots );#69
f := (r,k,e) -> k*e/(1+e*cos(theta));
elist := [3/4,1,5/4];          # (a)
P1 := seq( plot( f(r,-2,e), theta=-Pi..Pi, coords=polar ), e=elist ):
display( [P1], insequence=true, view=[-20..20,-20..20], title="#69(a) (Section 10.8)\nk=-2" );
P2 := seq( plot( f(r,2,e), theta=-Pi..Pi, coords=polar ), e=elist ):
display( [P2], insequence=true, view=[-20..20,-20..20], title="#69(a) (Section 10.8)\nk=2" );
elist2 := [7/6,5/4,4/3,3/2,2,3,5,10,20];  # (b)
P3 := seq( plot( f(r,-1,e), theta=-Pi..Pi, coords=polar ), e=elist2 ):
display( [P3], insequence=true, view=[-20..20,-20..20], title="#69(b) (Section 10.8)\nk=-1, e>1" );
elist3 := [1/2,1/3,1/4,1/10,1/20];
P4 := seq( plot( f(r,-1,e), theta=-Pi..Pi, coords=polar ), e=elist3 ):
display( [P4], insequence=true, title="#69(b) (Section 10.8)\nk=-1, e<1" );
klist := -5..-1;              # (c)
P5 := seq( plot( f(r,k,1/2), theta=-Pi..Pi, coords=polar ), k=klist ):
display( [P5], insequence=true, title="#69(c) (Section 10.8)\ne=1/2, k<0" );
P6 := seq( plot( f(r,k,1), theta=-Pi..Pi, coords=polar ), k=klist ):
display( [P6], insequence=true, view=[-4..50,-50..50], title="#69(c) (Section 10.8)\ne=1, k<0" );
P7 := seq( plot( f(r,k,2), theta=-Pi..Pi, coords=polar ), k=klist ):
display( [P5], insequence=true, title="#69(c) (Section 10.8)\ne=2, k<0" );
```

Mathematica: (assigned function and values for parameters and bounds may vary):

To do polar plots in Mathematica, it is necessary to first load a graphics package

In the **PolarPlot** command, it is assumed that the variable r is given as a function of the variable θ .

```
<<Graphics`Graphics`
f[θ_, k_, ec_] := (k ec) / (1 + ec Cos[θ])
PolarPlot[{ f[θ, -2, 3/4], f[θ, -2, 1], f[θ, -2, 5/4] }, {θ, 0, 2π}, PlotRange → {-20, 20},
  PlotStyle → {RGBColor[1, 0, 0], RGBColor[0, 1, 0], RGBColor[0, 0, 1]};
PolarPlot[{ f[θ, -1, 1], f[θ, -2, 1], f[θ, -3, 1], f[θ, -4, 1], f[θ, -5, 1] }, {θ, 0, 2π}, PlotRange → {-20, 20},
  PlotStyle →
  {RGBColor[1, 0, 0], RGBColor[0, 1, 0], RGBColor[0, 0, 1], RGBColor[.5, .5, 0], RGBColor[0, .5, .5]}];
```

The limitation on the range is primarily needed when plotting hyperbolas.

Problem 70 can be done in a similar fashion.

CHAPTER 10 PRACTICE EXERCISES

- $x^2 = -4y \Rightarrow y = -\frac{x^2}{4} \Rightarrow 4p = 4 \Rightarrow p = 1$;
therefore Focus is $(0, -1)$, Directrix is $y = 1$
- $x^2 = 2y \Rightarrow \frac{x^2}{2} = y \Rightarrow 4p = 2 \Rightarrow p = \frac{1}{2}$;
therefore Focus is $(0, \frac{1}{2})$; Directrix is $y = -\frac{1}{2}$

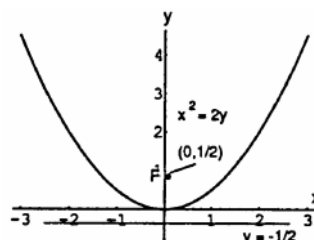
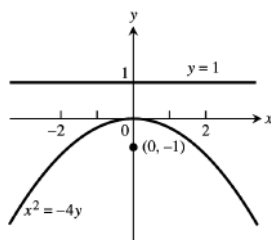

3. $y^2 = 3x \Rightarrow x = \frac{y^2}{3} \Rightarrow 4p = 3 \Rightarrow p = \frac{3}{4}$;
 therefore Focus is $(\frac{3}{4}, 0)$, Directrix is $x = -\frac{3}{4}$

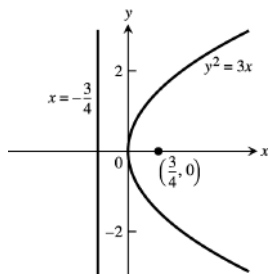

4. $y^2 = -\frac{8}{3}x \Rightarrow x = -\frac{y^2}{(8/3)} \Rightarrow 4p = \frac{8}{3} \Rightarrow p = \frac{2}{3}$;
 therefore Focus is $(-\frac{2}{3}, 0)$, Directrix is $x = \frac{2}{3}$

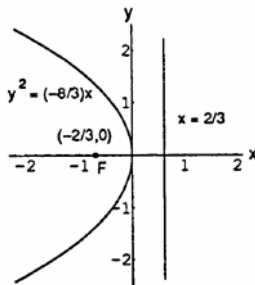

5. $16x^2 + 7y^2 = 112 \Rightarrow \frac{x^2}{7} + \frac{y^2}{16} = 1$
 $\Rightarrow c^2 = 16 - 7 = 9 \Rightarrow c = 3; e = \frac{c}{a} = \frac{3}{4}$

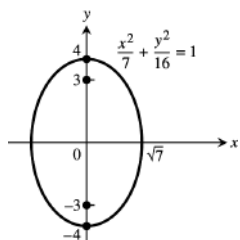

6. $x^2 + 2y^2 = 4 \Rightarrow \frac{x^2}{4} + \frac{y^2}{2} = 1 \Rightarrow c^2 = 4 - 2 = 2$
 $\Rightarrow c = \sqrt{2}; e = \frac{c}{a} = \frac{\sqrt{2}}{2}$

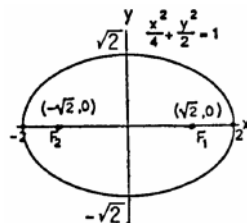

7. $3x^2 - y^2 = 3 \Rightarrow x^2 - \frac{y^2}{3} = 1 \Rightarrow c^2 = 1 + 3 = 4$
 $\Rightarrow c = 2; e = \frac{c}{a} = \frac{2}{1} = 2$; the asymptotes are
 $y = \pm \sqrt{3}x$

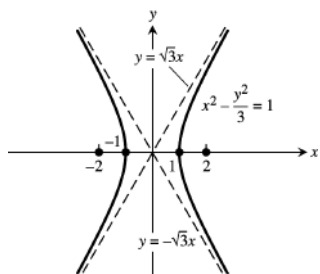

8. $5y^2 - 4x^2 = 20 \Rightarrow \frac{y^2}{4} - \frac{x^2}{5} = 1 \Rightarrow c^2 = 4 + 5 = 9$
 $\Rightarrow c = 3, e = \frac{c}{a} = \frac{3}{2}$; the asymptotes are $y = \pm \frac{2}{\sqrt{5}}x$

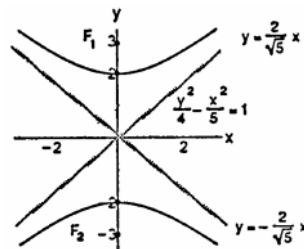

9. $x^2 = -12y \Rightarrow -\frac{x^2}{12} = y \Rightarrow 4p = 12 \Rightarrow p = 3 \Rightarrow$ focus is $(0, -3)$, directrix is $y = 3$, vertex is $(0, 0)$; therefore new vertex is $(2, 3)$, new focus is $(2, 0)$, new directrix is $y = 6$, and the new equation is $(x - 2)^2 = -12(y - 3)$

10. $y^2 = 10x \Rightarrow \frac{y^2}{10} = x \Rightarrow 4p = 10 \Rightarrow p = \frac{5}{2} \Rightarrow$ focus is $(\frac{5}{2}, 0)$, directrix is $x = -\frac{5}{2}$, vertex is $(0, 0)$; therefore new vertex is $(-\frac{1}{2}, -1)$, new focus is $(2, -1)$, new directrix is $x = -3$, and the new equation is $(y + 1)^2 = 10(x + \frac{1}{2})$

11. $\frac{x^2}{9} + \frac{y^2}{25} = 1 \Rightarrow a = 5$ and $b = 3 \Rightarrow c = \sqrt{25 - 9} = 4 \Rightarrow$ foci are $(0, \pm 4)$, vertices are $(0, \pm 5)$, center is $(0, 0)$; therefore the new center is $(-3, -5)$, new foci are $(-3, -1)$ and $(-3, -9)$, new vertices are $(-3, -10)$ and $(-3, 0)$, and the new equation is $\frac{(x+3)^2}{9} + \frac{(y+5)^2}{25} = 1$

12. $\frac{x^2}{169} + \frac{y^2}{144} = 1 \Rightarrow a = 13$ and $b = 12 \Rightarrow c = \sqrt{169 - 144} = 5 \Rightarrow$ foci are $(\pm 5, 0)$, vertices are $(\pm 13, 0)$, center is $(0, 0)$; therefore the new center is $(5, 12)$, new foci are $(10, 12)$ and $(0, 12)$, new vertices are $(18, 12)$ and

$(-8, 12)$, and the new equation is $\frac{(x-5)^2}{169} + \frac{(y-12)^2}{144} = 1$

13. $\frac{y^2}{8} - \frac{x^2}{2} = 1 \Rightarrow a = 2\sqrt{2}$ and $b = \sqrt{2} \Rightarrow c = \sqrt{8+2} = \sqrt{10} \Rightarrow$ foci are $(0, \pm\sqrt{10})$, vertices are $(0, \pm 2\sqrt{2})$, center is $(0, 0)$, and the asymptotes are $y = \pm 2x$; therefore the new center is $(2, 2\sqrt{2})$, new foci are $(2, 2\sqrt{2} \pm \sqrt{10})$, new vertices are $(2, 4\sqrt{2})$ and $(2, 0)$, the new asymptotes are $y = 2x - 4 + 2\sqrt{2}$ and $y = -2x + 4 + 2\sqrt{2}$; the new equation is $\frac{(y-2\sqrt{2})^2}{8} - \frac{(x-2)^2}{2} = 1$
14. $\frac{x^2}{36} - \frac{y^2}{64} = 1 \Rightarrow a = 6$ and $b = 8 \Rightarrow c = \sqrt{36+64} = 10 \Rightarrow$ foci are $(\pm 10, 0)$, vertices are $(\pm 6, 0)$, the center is $(0, 0)$ and the asymptotes are $\frac{y}{8} = \pm \frac{x}{6}$ or $y = \pm \frac{4}{3}x$; therefore the new center is $(-10, -3)$, the new foci are $(-20, -3)$ and $(0, -3)$, the new vertices are $(-16, -3)$ and $(-4, -3)$, the new asymptotes are $y = \frac{4}{3}x + \frac{31}{3}$ and $y = -\frac{4}{3}x - \frac{49}{3}$; the new equation is $\frac{(x+10)^2}{36} - \frac{(y+3)^2}{64} = 1$
15. $x^2 - 4x - 4y^2 = 0 \Rightarrow x^2 - 4x + 4 - 4y^2 = 4 \Rightarrow (x-2)^2 - 4y^2 = 4 \Rightarrow \frac{(x-2)^2}{4} - y^2 = 1$, a hyperbola; $a = 2$ and $b = 1 \Rightarrow c = \sqrt{1+4} = \sqrt{5}$; the center is $(2, 0)$, the vertices are $(0, 0)$ and $(4, 0)$; the foci are $(2 \pm \sqrt{5}, 0)$ and the asymptotes are $y = \pm \frac{x-2}{2}$
16. $4x^2 - y^2 + 4y = 8 \Rightarrow 4x^2 - y^2 + 4y - 4 = 4 \Rightarrow 4x^2 - (y-2)^2 = 4 \Rightarrow x^2 - \frac{(y-2)^2}{4} = 1$, a hyperbola; $a = 1$ and $b = 2 \Rightarrow c = \sqrt{1+4} = \sqrt{5}$; the center is $(0, 2)$, the vertices are $(1, 2)$ and $(-1, 2)$, the foci are $(\pm \sqrt{5}, 2)$ and the asymptotes are $y = \pm 2x + 2$
17. $y^2 - 2y + 16x = -49 \Rightarrow y^2 - 2y + 1 = -16x - 48 \Rightarrow (y-1)^2 = -16(x+3)$, a parabola; the vertex is $(-3, 1)$; $4p = 16 \Rightarrow p = 4 \Rightarrow$ the focus is $(-7, 1)$ and the directrix is $x = 1$
18. $x^2 - 2x + 8y = -17 \Rightarrow x^2 - 2x + 1 = -8y - 16 \Rightarrow (x-1)^2 = -8(y+2)$, a parabola; the vertex is $(1, -2)$; $4p = 8 \Rightarrow p = 2 \Rightarrow$ the focus is $(1, -4)$ and the directrix is $y = 0$
19. $9x^2 + 16y^2 + 54x - 64y = -1 \Rightarrow 9(x^2 + 6x) + 16(y^2 - 4y) = -1 \Rightarrow 9(x^2 + 6x + 9) + 16(y^2 - 4y + 4) = 144$
 $\Rightarrow 9(x+3)^2 + 16(y-2)^2 = 144 \Rightarrow \frac{(x+3)^2}{16} + \frac{(y-2)^2}{9} = 1$, an ellipse; the center is $(-3, 2)$; $a = 4$ and $b = 3$
 $\Rightarrow c = \sqrt{16-9} = \sqrt{7}$; the foci are $(-3 \pm \sqrt{7}, 2)$; the vertices are $(1, 2)$ and $(-7, 2)$
20. $25x^2 + 9y^2 - 100x + 54y = 44 \Rightarrow 25(x^2 - 4x) + 9(y^2 + 6y) = 44 \Rightarrow 25(x^2 - 4x + 4) + 9(y^2 + 6y + 9) = 225$
 $\Rightarrow \frac{(x-2)^2}{9} + \frac{(y+3)^2}{25} = 1$, an ellipse; the center is $(2, -3)$; $a = 5$ and $b = 3 \Rightarrow c = \sqrt{25-9} = 4$; the foci are $(2, 1)$ and $(2, -7)$; the vertices are $(2, 2)$ and $(2, -8)$
21. $x^2 + y^2 - 2x - 2y = 0 \Rightarrow x^2 - 2x + 1 + y^2 - 2y + 1 = 2 \Rightarrow (x-1)^2 + (y-1)^2 = 2$, a circle with center $(1, 1)$ and radius $= \sqrt{2}$
22. $x^2 + y^2 + 4x + 2y = 1 \Rightarrow x^2 + 4x + 4 + y^2 + 2y + 1 = 6 \Rightarrow (x+2)^2 + (y+1)^2 = 6$, a circle with center $(-2, -1)$ and radius $= \sqrt{6}$
23. $B^2 - 4AC = 1 - 4(1)(1) = -3 < 0 \Rightarrow$ ellipse
24. $B^2 - 4AC = 4^2 - 4(1)(4) = 0 \Rightarrow$ parabola
25. $B^2 - 4AC = 3^2 - 4(1)(2) = 1 > 0 \Rightarrow$ hyperbola
26. $B^2 - 4AC = 2^2 - 4(1)(-2) = 12 > 0 \Rightarrow$ hyperbola

27. $x^2 - 2xy + y^2 = 0 \Rightarrow (x - y)^2 = 0 \Rightarrow x - y = 0$ or $y = x$, a straight line

28. $B^2 - 4AC = (-3)^2 - 4(1)(4) = -7 < 0 \Rightarrow$ ellipse

29. $B^2 - 4AC = 1^2 - 4(2)(2) = -15 < 0 \Rightarrow$ ellipse; $\cot 2\alpha = \frac{A-C}{B} = 0 \Rightarrow 2\alpha = \frac{\pi}{2} \Rightarrow \alpha = \frac{\pi}{4}$; $x = \frac{\sqrt{2}}{2}x' - \frac{\sqrt{2}}{2}y'$ and $y = \frac{\sqrt{2}}{2}x' + \frac{\sqrt{2}}{2}y' \Rightarrow 2\left(\frac{\sqrt{2}}{2}x' - \frac{\sqrt{2}}{2}y'\right)^2 + \left(\frac{\sqrt{2}}{2}x' - \frac{\sqrt{2}}{2}y'\right)\left(\frac{\sqrt{2}}{2}x' + \frac{\sqrt{2}}{2}y'\right) + 2\left(\frac{\sqrt{2}}{2}x' + \frac{\sqrt{2}}{2}y'\right)^2 - 15 = 0 \Rightarrow 5x'^2 + 3y'^2 = 30$

30. $B^2 - 4AC = 2^2 - 4(3)(3) = -32 < 0 \Rightarrow$ ellipse; $\cot 2\alpha = \frac{A-C}{B} = 0 \Rightarrow 2\alpha = \frac{\pi}{2} \Rightarrow \alpha = \frac{\pi}{4}$; $x = \frac{\sqrt{2}}{2}x' - \frac{\sqrt{2}}{2}y'$ and $y = \frac{\sqrt{2}}{2}x' + \frac{\sqrt{2}}{2}y' \Rightarrow 3\left(\frac{\sqrt{2}}{2}x' - \frac{\sqrt{2}}{2}y'\right)^2 + 2\left(\frac{\sqrt{2}}{2}x' - \frac{\sqrt{2}}{2}y'\right)\left(\frac{\sqrt{2}}{2}x' + \frac{\sqrt{2}}{2}y'\right) + 3\left(\frac{\sqrt{2}}{2}x' + \frac{\sqrt{2}}{2}y'\right)^2 = 19 \Rightarrow 4x'^2 + 2y'^2 = 19$

31. $B^2 - 4AC = (2\sqrt{3})^2 - 4(1)(-1) = 16 \Rightarrow$ hyperbola; $\cot 2\alpha = \frac{A-C}{B} = \frac{1}{\sqrt{3}} \Rightarrow 2\alpha = \frac{\pi}{3} \Rightarrow \alpha = \frac{\pi}{6}$; $x = \frac{\sqrt{3}}{2}x' - \frac{1}{2}y'$ and $y = \frac{1}{2}x' + \frac{\sqrt{3}}{2}y' \Rightarrow \left(\frac{\sqrt{3}}{2}x' - \frac{1}{2}y'\right)^2 + 2\sqrt{3}\left(\frac{\sqrt{3}}{2}x' - \frac{1}{2}y'\right)\left(\frac{1}{2}x' + \frac{\sqrt{3}}{2}y'\right) - \left(\frac{1}{2}x' + \frac{\sqrt{3}}{2}y'\right)^2 = 4 \Rightarrow 2x'^2 - 2y'^2 = -4 \Rightarrow y'^2 - x'^2 = 2$

32. $B^2 - 4AC = (-3)^2 - 4(1)(1) = 5 > 0 \Rightarrow$ hyperbola; $\cot 2\alpha = \frac{A-C}{B} = 0 \Rightarrow 2\alpha = \frac{\pi}{2} \Rightarrow \alpha = \frac{\pi}{4}$; $x = \frac{\sqrt{2}}{2}x' - \frac{\sqrt{2}}{2}y'$ and $y = \frac{\sqrt{2}}{2}x' + \frac{\sqrt{2}}{2}y' \Rightarrow \left(\frac{\sqrt{2}}{2}x' - \frac{\sqrt{2}}{2}y'\right)^2 - 3\left(\frac{\sqrt{2}}{2}x' - \frac{\sqrt{2}}{2}y'\right)\left(\frac{\sqrt{2}}{2}x' + \frac{\sqrt{2}}{2}y'\right) + \left(\frac{\sqrt{2}}{2}x' + \frac{\sqrt{2}}{2}y'\right)^2 = 5 \Rightarrow \frac{5}{2}y'^2 - \frac{1}{2}x'^2 = 5$ or $5y'^2 - x'^2 = 10$

33. $x = \frac{1}{2} \tan t$ and $y = \frac{1}{2} \sec t \Rightarrow x^2 = \frac{1}{4} \tan^2 t$
 and $y^2 = \frac{1}{4} \sec^2 t \Rightarrow 4x^2 = \tan^2 t$ and
 $4y^2 = \sec^2 t \Rightarrow 4x^2 + 1 = 4y^2 \Rightarrow 4y^2 - 4x^2 = 1$

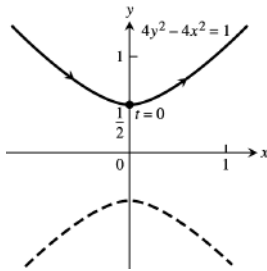

34. $x = -2 \cos t$ and $y = 2 \sin t \Rightarrow x^2 = 4 \cos^2 t$ and
 $y^2 = 4 \sin^2 t \Rightarrow x^2 + y^2 = 4$

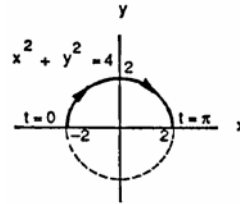

35. $x = -\cos t$ and $y = \cos^2 t \Rightarrow y = (-x)^2 = x^2$

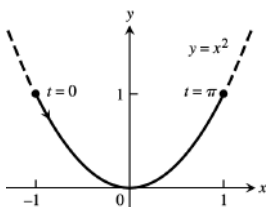

35. $x = 4 \cos t$ and $y = 9 \sin^2 t \Rightarrow x^2 = 16 \cos^2 t$ and
 $y^2 = 81 \sin^2 t \Rightarrow \frac{x^2}{16} + \frac{y^2}{81} = 1$

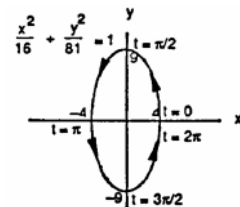

37.

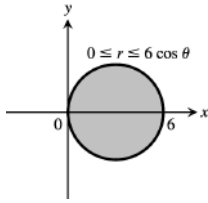

38.

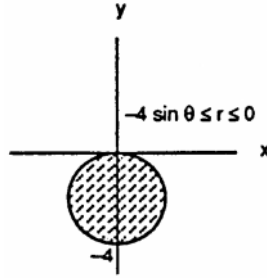

39. d

40. e

41. l

42. f

43. k

44. h

45. i

46. j

47. $r = \sin \theta$ and $r = 1 + \sin \theta \Rightarrow \sin \theta = 1 + \sin \theta \Rightarrow 0 = 1$
 so no solutions exist. There are no points of intersection
 found by solving the system. The point of intersection
 $(0, 0)$ is found by graphing.

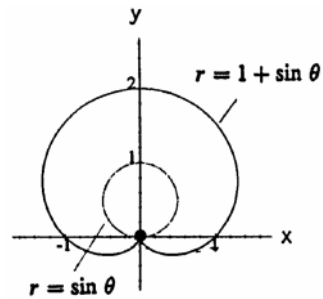

48. $r = \cos \theta$ and $r = 1 - \cos \theta \Rightarrow \cos \theta = 1 - \cos \theta$
 $\Rightarrow \cos \theta = \frac{1}{2} \Rightarrow \theta = \frac{\pi}{3}, -\frac{\pi}{3}; \theta = \frac{\pi}{3} \Rightarrow r = \frac{1}{2}; \theta = -\frac{\pi}{3}$
 $\Rightarrow r = \frac{1}{2}$. The points of intersection are $(\frac{1}{2}, \frac{\pi}{3})$ and
 $(\frac{1}{2}, -\frac{\pi}{3})$. The point of intersection $(0, 0)$ is found
 by graphing.

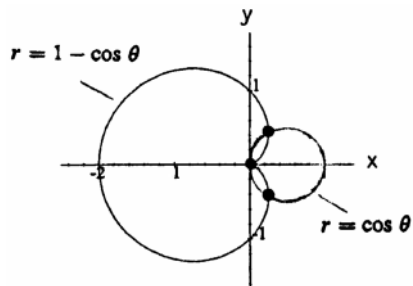

49. $r = 1 + \cos \theta$ and $r = 1 - \cos \theta \Rightarrow 1 + \cos \theta = 1 - \cos \theta$
 $\Rightarrow 2 \cos \theta = 0 \Rightarrow \cos \theta = 0 \Rightarrow \theta = \frac{\pi}{2}, \frac{3\pi}{2}; \theta = \frac{\pi}{2}$ or $\frac{3\pi}{2}$
 $\Rightarrow r = 1$. The points of intersection are $(1, \frac{\pi}{2})$ and $(1, \frac{3\pi}{2})$.
 The point of intersection $(0, 0)$ is found by graphing.

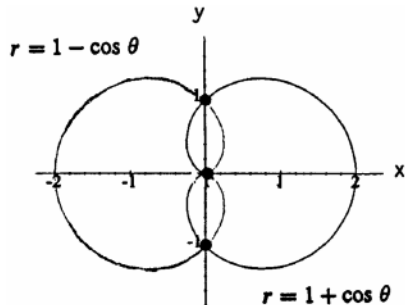

50. $r = 1 + \sin \theta$ and $r = 1 - \sin \theta \Rightarrow 1 + \sin \theta = 1 - \sin \theta$
 $\Rightarrow 2 \sin \theta = 0 \Rightarrow \sin \theta = 0 \Rightarrow \theta = 0, \pi; \theta = 0$ or π
 $\Rightarrow r = 1$. The points of intersection are $(1, 0)$ and $(1, \pi)$.
 The point of intersection $(0, 0)$ is found by graphing.

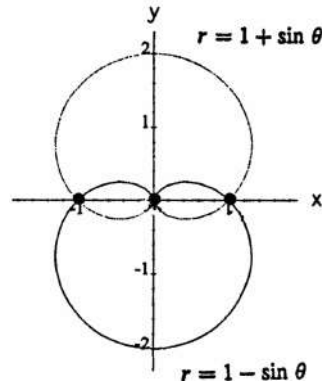

51. $r = 1 + \sin \theta$ and $r = -1 + \sin \theta$ intersect at all points of $r = 1 + \sin \theta$ because the graphs coincide. This can be seen by graphing them.

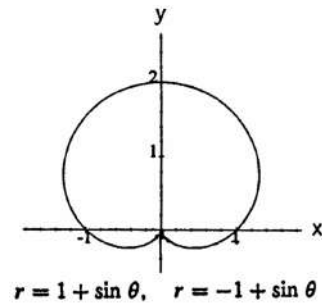

52. $r = 1 + \cos \theta$ and $r = -1 + \cos \theta$ intersect at all points of $r = 1 + \cos \theta$ because the graphs coincide. This can be seen by graphing them.

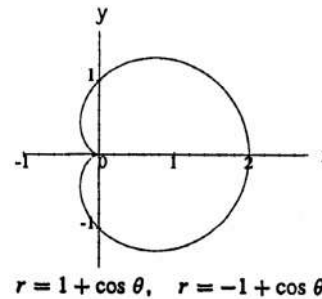

53. $r = \sec \theta$ and $r = 2 \sin \theta \Rightarrow \sec \theta = 2 \sin \theta$
 $\Rightarrow 1 = 2 \sin \theta \cos \theta \Rightarrow 1 = \sin 2\theta \Rightarrow 2\theta = \frac{\pi}{2} \Rightarrow \theta = \frac{\pi}{4}$
 $\Rightarrow r = 2 \sin \frac{\pi}{4} = \sqrt{2} \Rightarrow$ the point of intersection is $(\sqrt{2}, \frac{\pi}{4})$. No other points of intersection exist.

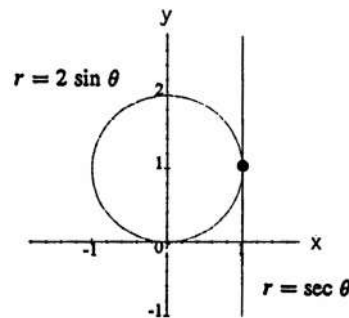

54. $r = -2 \csc \theta$ and $r = -4 \cos \theta \Rightarrow -2 \csc \theta = -4 \cos \theta$
 $\Rightarrow 1 = 2 \sin \theta \cos \theta \Rightarrow 1 = \sin 2\theta \Rightarrow 2\theta = \frac{\pi}{2}, \frac{5\pi}{2}$
 $\Rightarrow \theta = \frac{\pi}{4}, \frac{5\pi}{4}; \theta = \frac{\pi}{4} \Rightarrow r = -4 \cos \frac{\pi}{4} = -2\sqrt{2};$
 $\theta = \frac{5\pi}{4} \Rightarrow r = -4 \cos \frac{5\pi}{4} = 2\sqrt{2}$. The point of intersection is $(2\sqrt{2}, \frac{5\pi}{4})$ and the point $(-2\sqrt{2}, \frac{\pi}{4})$ is the same point.

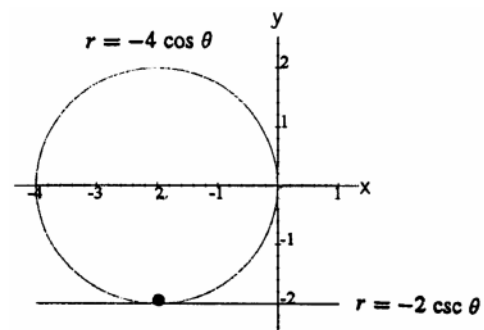

$$\begin{aligned}
 55. \quad r \cos\left(\theta + \frac{\pi}{3}\right) &= 2\sqrt{3} \Rightarrow r\left(\cos\theta \cos\frac{\pi}{3} - \sin\theta \sin\frac{\pi}{3}\right) \\
 &= 2\sqrt{3} \Rightarrow \frac{1}{2}r \cos\theta - \frac{\sqrt{3}}{2}r \sin\theta = 2\sqrt{3} \\
 &\Rightarrow r \cos\theta - \sqrt{3}r \sin\theta = 4\sqrt{3} \Rightarrow x - \sqrt{3}y = 4\sqrt{3} \\
 &\Rightarrow y = \frac{\sqrt{3}}{3}x - 4
 \end{aligned}$$

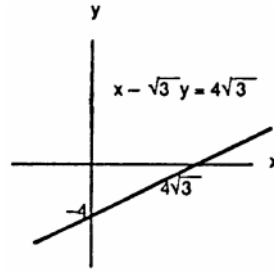

$$\begin{aligned}
 56. \quad r \cos\left(\theta - \frac{3\pi}{4}\right) &= \frac{\sqrt{2}}{2} \Rightarrow r\left(\cos\theta \cos\frac{3\pi}{4} + \sin\theta \sin\frac{3\pi}{4}\right) \\
 &= \frac{\sqrt{2}}{2} \Rightarrow -\frac{\sqrt{2}}{2}r \cos\theta + \frac{\sqrt{2}}{2}r \sin\theta = \frac{\sqrt{2}}{2} \Rightarrow -x + y = 1 \\
 &\Rightarrow y = x + 1
 \end{aligned}$$

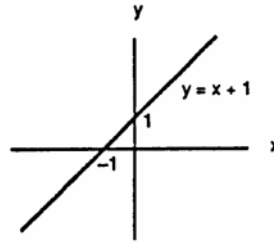

$$57. \quad r = 2 \sec\theta \Rightarrow r = \frac{2}{\cos\theta} \Rightarrow r \cos\theta = 2 \Rightarrow x = 2$$

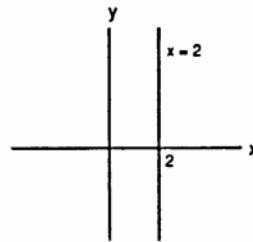

$$58. \quad r = -\sqrt{2} \sec\theta \Rightarrow r \cos\theta = -\sqrt{2} \Rightarrow x = -\sqrt{2}$$

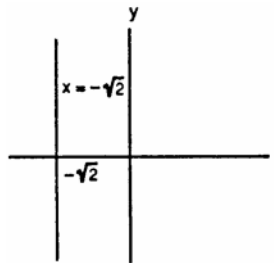

$$59. \quad r = -\frac{3}{2} \csc\theta \Rightarrow r \sin\theta = -\frac{3}{2} \Rightarrow y = -\frac{3}{2}$$

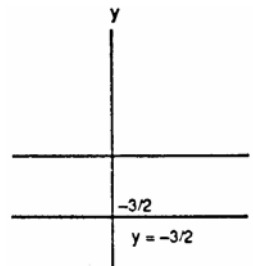

$$60. \quad r = 3\sqrt{3} \csc\theta \Rightarrow r \sin\theta = 3\sqrt{3} \Rightarrow y = 3\sqrt{3}$$

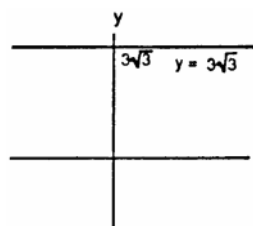

61. $r = -4 \sin \theta \Rightarrow r^2 = -4r \sin \theta \Rightarrow x^2 + y^2 + 4y = 0$
 $\Rightarrow x^2 + (y + 2)^2 = 4$; circle with center $(0, -2)$ and radius 2.

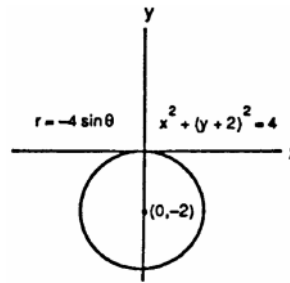

62. $r = 3\sqrt{3} \sin \theta \Rightarrow r^2 = 3\sqrt{3} r \sin \theta$
 $\Rightarrow x^2 + y^2 - 3\sqrt{3} y = 0 \Rightarrow x^2 + \left(y - \frac{3\sqrt{3}}{2}\right)^2 = \frac{27}{4}$;
 circle with center $\left(0, \frac{3\sqrt{3}}{2}\right)$ and radius $\frac{3\sqrt{3}}{2}$

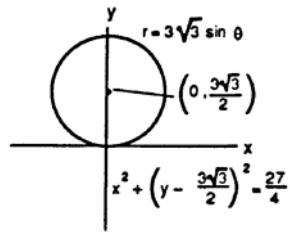

63. $r = 2\sqrt{2} \cos \theta \Rightarrow r^2 = 2\sqrt{2} r \cos \theta$
 $\Rightarrow x^2 + y^2 - 2\sqrt{2} x = 0 \Rightarrow (x - \sqrt{2})^2 + y^2 = 2$;
 circle with center $(\sqrt{2}, 0)$ and radius $\sqrt{2}$

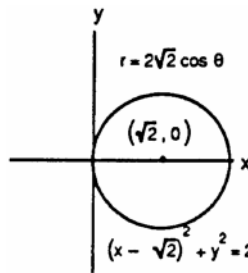

64. $r = -6 \cos \theta \Rightarrow r^2 = -6r \cos \theta \Rightarrow x^2 + y^2 + 6x = 0$
 $\Rightarrow (x + 3)^2 + y^2 = 9$; circle with center $(-3, 0)$ and radius 3

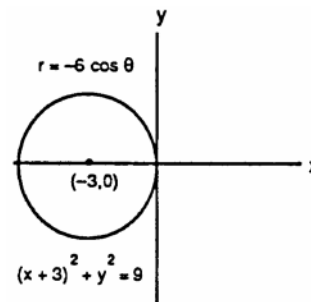

65. $x^2 + y^2 + 5y = 0 \Rightarrow x^2 + \left(y + \frac{5}{2}\right)^2 = \frac{25}{4} \Rightarrow C = \left(0, -\frac{5}{2}\right)$
 and $a = \frac{5}{2}$; $r^2 + 5r \sin \theta = 0 \Rightarrow r = -5 \sin \theta$

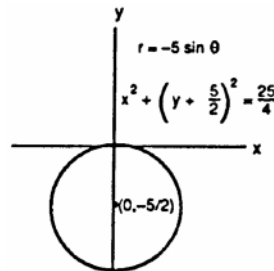

66. $x^2 + y^2 - 2y = 0 \Rightarrow x^2 + (y - 1)^2 = 1 \Rightarrow C = (0, 1)$ and
 $a = 1$; $r^2 - 2r \sin \theta = 0 \Rightarrow r = 2 \sin \theta$

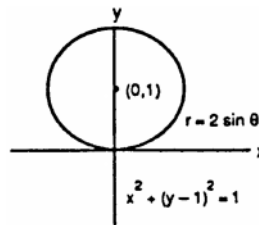

67. $x^2 + y^2 - 3x = 0 \Rightarrow (x - \frac{3}{2})^2 + y^2 = \frac{9}{4} \Rightarrow C = (\frac{3}{2}, 0)$
 and $a = \frac{3}{2}; r^2 - 3r \cos \theta = 0 \Rightarrow r = 3 \cos \theta$

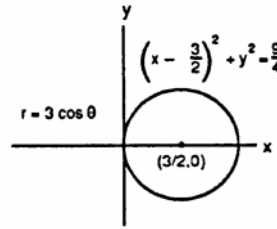

68. $x^2 + y^2 + 4x = 0 \Rightarrow (x + 2)^2 + y^2 = 4 \Rightarrow C = (-2, 0)$
 and $a = 2; r^2 + 4r \cos \theta = 0 \Rightarrow r = -4 \cos \theta$

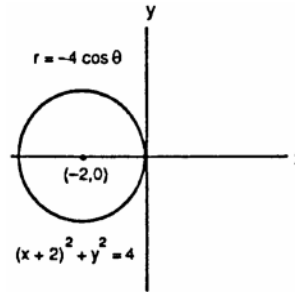

69. $r = \frac{2}{1 + \cos \theta} \Rightarrow e = 1 \Rightarrow$ parabola with vertex at $(1, 0)$

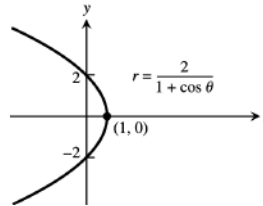

70. $r = \frac{8}{2 + \cos \theta} \Rightarrow r = \frac{4}{1 + (\frac{1}{2}) \cos \theta} \Rightarrow e = \frac{1}{2} \Rightarrow$ ellipse;
 $ke = 4 \Rightarrow \frac{1}{2}k = 4 \Rightarrow k = 8; k = \frac{a}{e} - ea \Rightarrow 8 = \frac{a}{(\frac{1}{2})} - \frac{1}{2}a$
 $\Rightarrow a = \frac{16}{3} \Rightarrow ea = (\frac{1}{2})(\frac{16}{3}) = \frac{8}{3};$ therefore the center is $(\frac{8}{3}, \pi);$ vertices are $(8, \pi)$ and $(\frac{8}{3}, 0)$

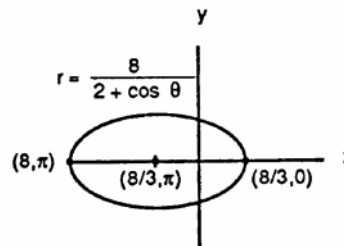

71. $r = \frac{6}{1 - 2 \cos \theta} \Rightarrow e = 2 \Rightarrow$ hyperbola; $ke = 6 \Rightarrow 2k = 6$
 $\Rightarrow k = 3 \Rightarrow$ vertices are $(2, \pi)$ and $(6, \pi)$

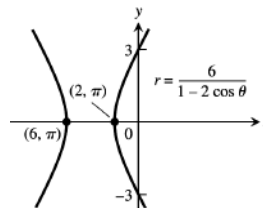

72. $r = \frac{12}{3 + \sin \theta} \Rightarrow r = \frac{4}{1 + (\frac{1}{3}) \sin \theta} \Rightarrow e = \frac{1}{3}; ke = 4$
 $\Rightarrow \frac{1}{3}k = 4 \Rightarrow k = 12; a(1 - e^2) = 4 \Rightarrow a[1 - (\frac{1}{3})^2]$
 $= 4 \Rightarrow a = \frac{9}{2} \Rightarrow ea = (\frac{1}{3})(\frac{9}{2}) = \frac{3}{2};$ therefore the center is $(\frac{3}{2}, \frac{3\pi}{2});$ vertices are $(3, \frac{\pi}{2})$ and $(6, \frac{3\pi}{2})$

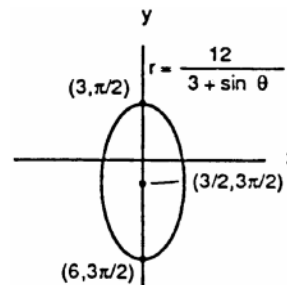

73. $e = 2$ and $r \cos \theta = 2 \Rightarrow x = 2$ is directrix $\Rightarrow k = 2;$ the conic is a hyperbola; $r = \frac{ke}{1 + e \cos \theta} \Rightarrow r = \frac{(2)(2)}{1 + 2 \cos \theta}$
 $\Rightarrow r = \frac{4}{1 + 2 \cos \theta}$

$$74. e = 1 \text{ and } r \cos \theta = -4 \Rightarrow x = -4 \text{ is directrix} \Rightarrow k = 4; \text{ the conic is a parabola; } r = \frac{ke}{1 - e \cos \theta} \Rightarrow r = \frac{(4)(1)}{1 - \cos \theta} \\ \Rightarrow r = \frac{4}{1 - \cos \theta}$$

$$75. e = \frac{1}{2} \text{ and } r \sin \theta = 2 \Rightarrow y = 2 \text{ is directrix} \Rightarrow k = 2; \text{ the conic is an ellipse; } r = \frac{ke}{1 + e \sin \theta} \Rightarrow r = \frac{(2)(\frac{1}{2})}{1 + (\frac{1}{2}) \sin \theta} \\ \Rightarrow r = \frac{2}{2 + \sin \theta}$$

$$76. e = \frac{1}{3} \text{ and } r \sin \theta = -6 \Rightarrow y = -6 \text{ is directrix} \Rightarrow k = 6; \text{ the conic is an ellipse; } r = \frac{ke}{1 - e \sin \theta} \Rightarrow r = \frac{(6)(\frac{1}{3})}{1 - (\frac{1}{3}) \sin \theta} \\ \Rightarrow r = \frac{6}{3 - \sin \theta}$$

$$77. A = 2 \int_0^\pi \frac{1}{2} r^2 d\theta = \int_0^\pi (2 - \cos \theta)^2 d\theta = \int_0^\pi (4 - 4 \cos \theta + \cos^2 \theta) d\theta = \int_0^\pi (4 - 4 \cos \theta + \frac{1 + \cos 2\theta}{2}) d\theta \\ = \int_0^\pi (\frac{9}{2} - 4 \cos \theta + \frac{\cos 2\theta}{2}) d\theta = [\frac{9}{2} \theta - 4 \sin \theta + \frac{\sin 2\theta}{4}]_0^\pi = \frac{9}{2} \pi$$

$$78. A = \int_0^{\pi/3} \frac{1}{2} (\sin^2 3\theta) d\theta = \int_0^{\pi/3} (\frac{1 - \cos 6\theta}{2}) d\theta = \frac{1}{4} [\theta - \frac{1}{6} \sin 6\theta]_0^{\pi/3} = \frac{\pi}{12}$$

$$79. r = 1 + \cos 2\theta \text{ and } r = 1 \Rightarrow 1 = 1 + \cos 2\theta \Rightarrow 0 = \cos 2\theta \Rightarrow 2\theta = \frac{\pi}{2} \Rightarrow \theta = \frac{\pi}{4}; \text{ therefore}$$

$$A = 4 \int_0^{\pi/4} \frac{1}{2} [(1 + \cos 2\theta)^2 - 1^2] d\theta = 2 \int_0^{\pi/4} (1 + 2 \cos 2\theta + \cos^2 2\theta - 1) d\theta \\ = 2 \int_0^{\pi/4} (2 \cos 2\theta + \frac{1}{2} + \frac{\cos 4\theta}{2}) d\theta = 2 [\sin 2\theta + \frac{1}{2} \theta + \frac{\sin 4\theta}{8}]_0^{\pi/4} = 2 (1 + \frac{\pi}{8} + 0) = 2 + \frac{\pi}{4}$$

80. The circle lies interior to the cardioid (see the graphs in Exercises 61 and 63). Thus,

$$A = 2 \int_{-\pi/2}^{\pi/2} \frac{1}{2} [2(1 + \sin \theta)]^2 d\theta - \pi \text{ (the integral is the area of the cardioid minus the area of the circle)} \\ = \int_{-\pi/2}^{\pi/2} 4(1 + 2 \sin \theta + \sin^2 \theta) d\theta - \pi = \int_{-\pi/2}^{\pi/2} (6 + 8 \sin \theta - 2 \cos 2\theta) d\theta - \pi = [6\theta - 8 \cos \theta - \sin 2\theta]_{-\pi/2}^{\pi/2} - \pi \\ = [3\pi - (-3\pi)] - \pi = 5\pi$$

$$81. r = -1 + \cos \theta \Rightarrow \frac{dr}{d\theta} = -\sin \theta; \text{ Length} = \int_0^{2\pi} \sqrt{(-1 + \cos \theta)^2 + (-\sin \theta)^2} d\theta = \int_0^{2\pi} \sqrt{2 - 2 \cos \theta} d\theta \\ = \int_0^{2\pi} \sqrt{\frac{4(1 - \cos \theta)}{2}} d\theta = \int_0^{2\pi} 2 \sin \frac{\theta}{2} d\theta = [-4 \cos \frac{\theta}{2}]_0^{2\pi} = (-4)(-1) - (-4)(1) = 8$$

$$82. r = 2 \sin \theta + 2 \cos \theta, 0 \leq \theta \leq \frac{\pi}{2} \Rightarrow \frac{dr}{d\theta} = 2 \cos \theta - 2 \sin \theta; r^2 + (\frac{dr}{d\theta})^2 = (2 \sin \theta + 2 \cos \theta)^2 + (2 \cos \theta - 2 \sin \theta)^2 \\ = 8(\sin^2 \theta + \cos^2 \theta) = 8 \Rightarrow L = \int_0^{\pi/2} \sqrt{8} d\theta = [2\sqrt{2}\theta]_0^{\pi/2} = 2\sqrt{2}(\frac{\pi}{2}) = \pi\sqrt{2}$$

$$83. r = 8 \sin^3(\frac{\theta}{3}), 0 \leq \theta \leq \frac{\pi}{4} \Rightarrow \frac{dr}{d\theta} = 8 \sin^2(\frac{\theta}{3}) \cos(\frac{\theta}{3}); r^2 + (\frac{dr}{d\theta})^2 = [8 \sin^3(\frac{\theta}{3})]^2 + [8 \sin^2(\frac{\theta}{3}) \cos(\frac{\theta}{3})]^2 \\ = 64 \sin^4(\frac{\theta}{3}) \Rightarrow L = \int_0^{\pi/4} \sqrt{64 \sin^4(\frac{\theta}{3})} d\theta = \int_0^{\pi/4} 8 \sin^2(\frac{\theta}{3}) d\theta = \int_0^{\pi/4} 8 [\frac{1 - \cos(\frac{2\theta}{3})}{2}] d\theta \\ = \int_0^{\pi/4} [4 - 4 \cos(\frac{2\theta}{3})] d\theta = [4\theta - 6 \sin(\frac{2\theta}{3})]_0^{\pi/4} = 4(\frac{\pi}{4}) - 6 \sin(\frac{\pi}{6}) - 0 = \pi - 3$$

$$84. r = \sqrt{1 + \cos 2\theta} \Rightarrow \frac{dr}{d\theta} = \frac{1}{2} (1 + \cos 2\theta)^{-1/2} (-2 \sin 2\theta) = \frac{-\sin 2\theta}{\sqrt{1 + \cos 2\theta}} \Rightarrow (\frac{dr}{d\theta})^2 = \frac{\sin^2 2\theta}{1 + \cos 2\theta} \\ \Rightarrow r^2 + (\frac{dr}{d\theta})^2 = 1 + \cos 2\theta + \frac{\sin^2 2\theta}{1 + \cos 2\theta} = \frac{(1 + \cos 2\theta)^2 + \sin^2 2\theta}{1 + \cos 2\theta} = \frac{1 + 2 \cos 2\theta + \cos^2 2\theta + \sin^2 2\theta}{1 + \cos 2\theta} \\ = \frac{2 + 2 \cos 2\theta}{1 + \cos 2\theta} = 2 \Rightarrow L = \int_{-\pi/2}^{\pi/2} \sqrt{2} d\theta = \sqrt{2} [\frac{\pi}{2} - (-\frac{\pi}{2})] = \sqrt{2} \pi$$

85. $r = \sqrt{\cos 2\theta} \Rightarrow \frac{dr}{d\theta} = \frac{-\sin 2\theta}{\sqrt{\cos 2\theta}}$; Surface Area $= \int_0^{\pi/4} 2\pi(r \sin \theta) \sqrt{r^2 + \left(\frac{dr}{d\theta}\right)^2} d\theta$
 $= \int_0^{\pi/4} 2\pi\sqrt{\cos 2\theta} (\sin \theta) \sqrt{\cos 2\theta + \frac{\sin^2 2\theta}{\cos 2\theta}} d\theta = \int_0^{\pi/4} 2\pi\sqrt{\cos 2\theta} (\sin \theta) \sqrt{\frac{1}{\cos 2\theta}} d\theta = \int_0^{\pi/4} 2\pi \sin \theta d\theta$
 $= [2\pi(-\cos \theta)]_0^{\pi/4} = 2\pi\left(1 - \frac{\sqrt{2}}{2}\right) = (2 - \sqrt{2})\pi$
86. $r^2 = \sin 2\theta \Rightarrow 2r \frac{dr}{d\theta} = 2 \cos 2\theta \Rightarrow r \frac{dr}{d\theta} = \cos 2\theta$; Surface Area $= 2 \int_0^{\pi/2} 2\pi(r \cos \theta) \sqrt{r^2 + \left(\frac{dr}{d\theta}\right)^2} d\theta$
 $= 2 \int_0^{\pi/2} 2\pi(\cos \theta) \sqrt{r^4 + \left(r \frac{dr}{d\theta}\right)^2} d\theta = 2 \int_0^{\pi/2} 2\pi(\cos \theta) \sqrt{(\sin 2\theta)^2 + (\cos 2\theta)^2} d\theta = 2 \int_0^{\pi/2} 2\pi \cos \theta d\theta$
 $= 2 [2\pi \sin \theta]_0^{\pi/2} = 4\pi$
87. (a) Around the x-axis: $9x^2 + 4y^2 = 36 \Rightarrow y^2 = 9 - \frac{9}{4}x^2 \Rightarrow y = \pm \sqrt{9 - \frac{9}{4}x^2}$ and we use the positive root:
 $V = 2 \int_0^2 \pi \left(\sqrt{9 - \frac{9}{4}x^2}\right)^2 dx = 2 \int_0^2 \pi \left(9 - \frac{9}{4}x^2\right) dx = 2\pi \left[9x - \frac{3}{4}x^3\right]_0^2 = 24\pi$
- (b) Around the y-axis: $9x^2 + 4y^2 = 36 \Rightarrow x^2 = 4 - \frac{4}{9}y^2 \Rightarrow x = \pm \sqrt{4 - \frac{4}{9}y^2}$ and we use the positive root:
 $V = 2 \int_0^3 \pi \left(\sqrt{4 - \frac{4}{9}y^2}\right)^2 dy = 2 \int_0^3 \pi \left(4 - \frac{4}{9}y^2\right) dy = 2\pi \left[4y - \frac{4}{27}y^3\right]_0^3 = 16\pi$
88. $9x^2 - 4y^2 = 36, x = 4 \Rightarrow y^2 = \frac{9x^2 - 36}{4} \Rightarrow y = \frac{3}{2} \sqrt{x^2 - 4}$; $V = \int_2^4 \pi \left(\frac{3}{2} \sqrt{x^2 - 4}\right)^2 dx = \frac{9\pi}{4} \int_2^4 (x^2 - 4) dx$
 $= \frac{9\pi}{4} \left[\frac{x^3}{3} - 4x\right]_2^4 = \frac{9\pi}{4} \left[\left(\frac{64}{3} - 16\right) - \left(\frac{8}{3} - 8\right)\right] = \frac{9\pi}{4} \left(\frac{56}{3} - \frac{24}{3}\right) = \frac{3\pi}{4} (32) = 24\pi$
89. Each portion of the wave front reflects to the other focus, and since the wave front travels at a constant speed as it expands, the different portions of the wave arrive at the second focus simultaneously, from all directions, causing a spurt at the second focus.
90. The velocity of the signals is $v = 980$ ft/ms. Let t_1 be the time it takes for the signal to go from A to S. Then
 $d_1 = 980t_1$ and $d_2 = 980(t_1 + 1400)$
 $\Rightarrow d_2 - d_1 = 980(1400) = 1.372 \times 10^6$ ft or 259.8 miles.
 The ship is 259.8 miles closer to A than to B.
 The difference of the distances is always constant (259.8 miles) so the ship is traveling along a branch of a hyperbola with foci at the two towers. The branch is the one having tower A as its focus.

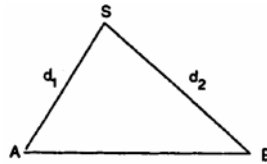

91. The time for the bullet to hit the target remains constant, say $t = t_0$. Let the time it takes for sound to travel from the target to the listener be t_2 . Since the listener hears the sounds simultaneously, $t_1 = t_0 + t_2$ where t_1 is the time for the sound to travel from the rifle to the listener. If v is the velocity of sound, then $vt_1 = vt_0 + vt_2$ or $vt_1 - vt_2 = vt_0$. Now vt_1 is the distance from the rifle to the listener and vt_2 is the distance from the target to the listener. Therefore the difference of the distances is constant since vt_0 is constant so the listener is on a branch of a hyperbola with foci at the rifle and the target. The branch is the one with the target as focus.
92. Let (r_1, θ_1) be a point on the graph where $r_1 = a\theta_1$. Let (r_2, θ_2) be on the graph where $r_2 = a\theta_2$ and $\theta_2 = \theta_1 + 2\pi$. Then r_1 and r_2 lie on the same ray on consecutive turns of the spiral and the distance between the two points is $r_2 - r_1 = a\theta_2 - a\theta_1 = a(\theta_2 - \theta_1) = 2\pi a$, which is constant.

93. (a) $r = \frac{k}{1+e \cos \theta} \Rightarrow r + er \cos \theta = k \Rightarrow \sqrt{x^2 + y^2} + ex = k \Rightarrow \sqrt{x^2 + y^2} = k - ex \Rightarrow x^2 + y^2 = k^2 - 2kex + e^2x^2 \Rightarrow x^2 - e^2x^2 + y^2 + 2kex - k^2 = 0 \Rightarrow (1 - e^2)x^2 + y^2 + 2kex - k^2 = 0$
 (b) $e = 0 \Rightarrow x^2 + y^2 - k^2 = 0 \Rightarrow x^2 + y^2 = k^2 \Rightarrow$ circle;
 $0 < e < 1 \Rightarrow e^2 < 1 \Rightarrow e^2 - 1 < 0 \Rightarrow B^2 - 4AC = 0^2 - 4(1 - e^2)(1) = 4(e^2 - 1) < 0 \Rightarrow$ ellipse;
 $e = 1 \Rightarrow B^2 - 4AC = 0^2 - 4(0)(1) = 0 \Rightarrow$ parabola;
 $e > 1 \Rightarrow e^2 > 1 \Rightarrow B^2 - 4AC = 0^2 - 4(1 - e^2)(1) = 4e^2 - 4 > 0 \Rightarrow$ hyperbola
94. (a) The length of the major axis is 300 miles + 8000 miles + 1000 miles = 2a $\Rightarrow a = 4650$ miles. If the center of the earth is one focus and the distance from the center of the earth to the satellite's low point is 4300 miles (half the diameter plus the distance above the North Pole), then the distance from the center of the ellipse to the focus (center of the earth) is 4650 miles - 4300 miles = 350 miles = c. Therefore $e = \frac{c}{a} = \frac{350 \text{ miles}}{4650 \text{ miles}} = \frac{7}{93}$.
- (b) $r = \frac{a(1-e^2)}{1+e \cos \theta} \Rightarrow r = \frac{4650 [1 - (\frac{7}{93})^2]}{(1 + \frac{7}{93} \cos \theta)} = \frac{430,000}{93+7 \cos \theta}$ mile

CHAPTER 10 ADDITIONAL AND ADVANCED EXERCISES

1. Directrix $x = 3$ and focus $(4, 0) \Rightarrow$ vertex is $(\frac{7}{2}, 0)$
 $\Rightarrow p = \frac{1}{2} \Rightarrow$ the equation is $x - \frac{7}{2} = \frac{y^2}{2}$

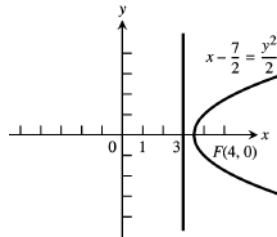

2. $x^2 - 6x - 12y + 9 = 0 \Rightarrow x^2 - 6x + 9 = 12y \Rightarrow \frac{(x-3)^2}{12} = y \Rightarrow$ vertex is $(3, 0)$ and $p = 3 \Rightarrow$ focus is $(3, 3)$ and the directrix is $y = -3$
3. $x^2 = 4y \Rightarrow$ vertex is $(0, 0)$ and $p = 1 \Rightarrow$ focus is $(0, 1)$; thus the distance from $P(x, y)$ to the vertex is $\sqrt{x^2 + y^2}$ and the distance from P to the focus is $\sqrt{x^2 + (y - 1)^2} \Rightarrow \sqrt{x^2 + y^2} = 2\sqrt{x^2 + (y - 1)^2} \Rightarrow x^2 + y^2 = 4[x^2 + (y - 1)^2] \Rightarrow x^2 + y^2 = 4x^2 + 4y^2 - 8y + 4 \Rightarrow 3x^2 + 3y^2 - 8y + 4 = 0$, which is a circle

4. Let the segment $a + b$ intersect the y -axis in point A and intersect the x -axis in point B so that $PB = b$ and $PA = a$ (see figure). Draw the horizontal line through P and let it intersect the y -axis in point C . Let $\angle PBO = \theta$
 $\Rightarrow \angle APC = \theta$. Then $\sin \theta = \frac{y}{b}$ and $\cos \theta = \frac{x}{a}$
 $\Rightarrow \frac{x^2}{a^2} + \frac{y^2}{b^2} = \cos^2 \theta + \sin^2 \theta = 1$.

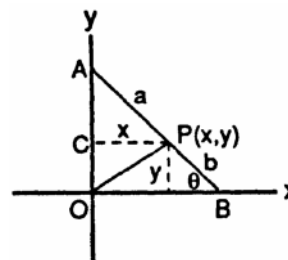

5. Vertices are $(0, \pm 2) \Rightarrow a = 2$; $e = \frac{c}{a} \Rightarrow 0.5 = \frac{c}{2} \Rightarrow c = 1 \Rightarrow$ foci are $(0, \pm 1)$
6. Let the center of the ellipse be $(x, 0)$; directrix $x = 2$, focus $(4, 0)$, and $e = \frac{2}{3} \Rightarrow \frac{a}{c} - c = 2 \Rightarrow \frac{a}{c} = 2 + c$
 $\Rightarrow a = \frac{2}{3}(2 + c)$. Also $c = ae = \frac{2}{3}a \Rightarrow a = \frac{2}{3}(2 + \frac{2}{3}a) \Rightarrow a = \frac{4}{3} + \frac{4}{9}a \Rightarrow \frac{5}{9}a = \frac{4}{3} \Rightarrow a = \frac{12}{5}$; $x - 2 = \frac{a}{e}$
 $\Rightarrow x - 2 = (\frac{12}{5})(\frac{3}{2}) = \frac{18}{5} \Rightarrow x = \frac{28}{5} \Rightarrow$ the center is $(\frac{28}{5}, 0)$; $x - 4 = c \Rightarrow c = \frac{28}{5} - 4 = \frac{8}{5}$ so that $c^2 = a^2 - b^2$
 $= (\frac{12}{5})^2 - (\frac{8}{5})^2 = \frac{80}{25}$; therefore the equation is $\frac{(x - \frac{28}{5})^2}{(\frac{144}{25})} + \frac{y^2}{(\frac{80}{25})} = 1$ or $\frac{25(x - \frac{28}{5})^2}{144} + \frac{5y^2}{16} = 1$

7. Let the center of the hyperbola be $(0, y)$.

- (a) Directrix $y = -1$, focus $(0, -7)$ and $e = 2 \Rightarrow c - \frac{a}{e} = 6 \Rightarrow \frac{a}{e} = c - 6 \Rightarrow a = 2c - 12$. Also $c = ae = 2a \Rightarrow a = 2(2a) - 12 \Rightarrow a = 4 \Rightarrow c = 8; y - (-1) = \frac{a}{e} = \frac{4}{2} = 2 \Rightarrow y = 1 \Rightarrow$ the center is $(0, 1); c^2 = a^2 + b^2 \Rightarrow b^2 = c^2 - a^2 = 64 - 16 = 48$; therefore the equation is $\frac{(y-1)^2}{16} - \frac{x^2}{48} = 1$
- (b) $e = 5 \Rightarrow c - \frac{a}{e} = 6 \Rightarrow \frac{a}{e} = c - 6 \Rightarrow a = 5c - 30$. Also, $c = ae = 5a \Rightarrow a = 5(5a) - 30 \Rightarrow 24a = 30 \Rightarrow a = \frac{5}{4} \Rightarrow c = \frac{25}{4}; y - (-1) = \frac{a}{e} = \frac{(\frac{5}{4})}{5} = \frac{1}{4} \Rightarrow y = -\frac{3}{4} \Rightarrow$ the center is $(0, -\frac{3}{4}); c^2 = a^2 + b^2 \Rightarrow b^2 = c^2 - a^2 = \frac{625}{16} - \frac{25}{16} = \frac{75}{2}$; therefore the equation is $\frac{(y+\frac{3}{4})^2}{(\frac{25}{16})} - \frac{x^2}{(\frac{75}{2})} = 1$ or $\frac{16(y+\frac{3}{4})^2}{25} - \frac{2x^2}{75} = 1$

8. The center is $(0, 0)$ and $c = 2 \Rightarrow 4 = a^2 + b^2 \Rightarrow b^2 = 4 - a^2$. The equation is $\frac{y^2}{a^2} - \frac{x^2}{b^2} = 1 \Rightarrow \frac{49}{a^2} - \frac{144}{b^2} = 1 \Rightarrow \frac{49}{a^2} - \frac{144}{(4-a^2)} = 1 \Rightarrow 49(4-a^2) - 144a^2 = a^2(4-a^2) \Rightarrow 196 - 49a^2 - 144a^2 = 4a^2 - a^4 \Rightarrow a^4 - 197a^2 + 196 = 0 \Rightarrow (a^2 - 196)(a^2 - 1) = 0 \Rightarrow a = 14$ or $a = 1; a = 14 \Rightarrow b^2 = 4 - (14)^2 < 0$ which is impossible; $a = 1 \Rightarrow b^2 = 4 - 1 = 3$; therefore the equation is $y^2 - \frac{x^2}{3} = 1$

9. (a) $b^2x^2 + a^2y^2 = a^2b^2 \Rightarrow \frac{dy}{dx} = -\frac{b^2x}{a^2y}$; at (x_1, y_1) the tangent line is $y - y_1 = \left(-\frac{b^2x_1}{a^2y_1}\right)(x - x_1) \Rightarrow a^2yy_1 + b^2xx_1 = b^2x_1^2 + a^2y_1^2 = a^2b^2 \Rightarrow b^2xx_1 + a^2yy_1 - a^2b^2 = 0$
- (b) $b^2x^2 - a^2y^2 = a^2b^2 \Rightarrow \frac{dy}{dx} = \frac{b^2x}{a^2y}$; at (x_1, y_1) the tangent line is $y - y_1 = \left(\frac{b^2x_1}{a^2y_1}\right)(x - x_1) \Rightarrow b^2xx_1 - a^2yy_1 = b^2x_1^2 - a^2y_1^2 = a^2b^2 \Rightarrow b^2xx_1 - a^2yy_1 - a^2b^2 = 0$

10. $Ax^2 + Bxy + Cy^2 + Dx + Ey + F = 0$ has the derivative $\frac{dy}{dx} = \frac{-2Ax - By - D}{Bx + 2Cy + E}$; at (x_1, y_1) the tangent line is $y - y_1 = \left(\frac{-2Ax_1 - By_1 - D}{Bx_1 + 2Cy_1 + E}\right)(x - x_1) \Rightarrow Byx_1 + 2Cyy_1 + Ey - By_1x_1 - 2Cy_1^2 - Ey_1 = -2Axx_1 - Bxy_1 - Dx + 2Ax_1^2 + Bx_1y_1 + Dx_1 \Rightarrow 2Axx_1 + B(yx_1 + xy_1) + 2Cyy_1 + Dx - Dx_1 + Ey - Ey_1 = 2Ax_1^2 + 2Bx_1y_1 + 2Cy_1^2$. Now add $2Dx_1 + 2Ey_1$ to both sides of this last equation, divide the result by 2, and represent the constant value on the right by $-F$ to get: $Axx_1 + B\left(\frac{yx_1 + xy_1}{2}\right) + Cyy_1 + D\left(\frac{x+x_1}{2}\right) + E\left(\frac{y+y_1}{2}\right) = -F$

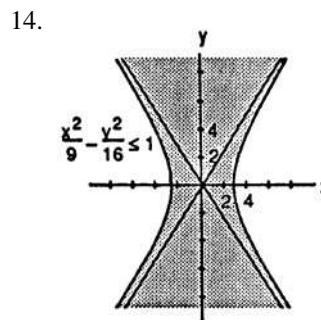
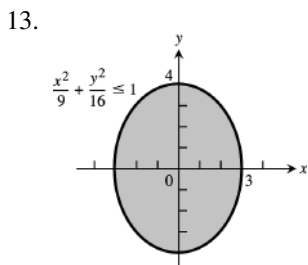
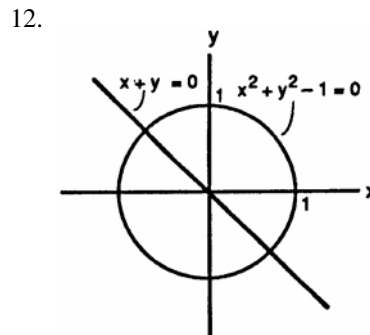
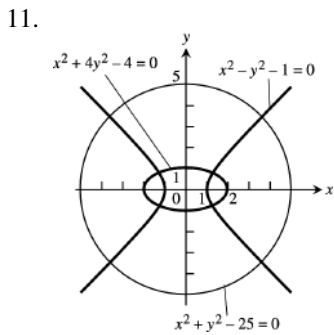

15. $(9x^2 + 4y^2 - 36)(4x^2 + 9y^2 - 16) \leq 0$
 $\Rightarrow 9x^2 + 4y^2 - 36 \leq 0$ and $4x^2 + 9y^2 - 16 \geq 0$
 or $9x^2 + 4y^2 - 36 \geq 0$ and $4x^2 + 9y^2 - 16 \leq 0$

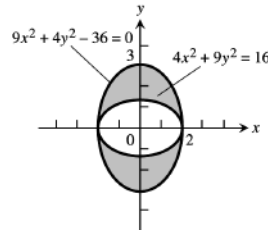

16. $(9x^2 + 4y^2 - 36)(4x^2 + 9y^2 - 16) > 0$, which is the complement of the set in Exercise 15

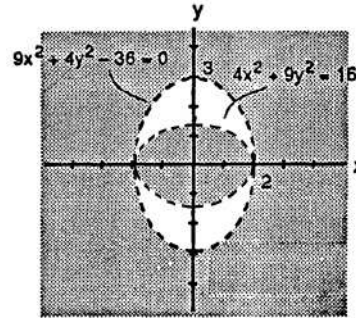

17. $x^4 - (y^2 - 9)^2 = 0 \Rightarrow x^2 - (y^2 - 9) = 0$ or
 $x^2 + (y^2 - 9) = 0 \Rightarrow y^2 - x^2 = 9$ or $x^2 + y^2 = 9$

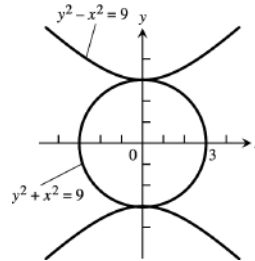

18. $x^2 + xy + y^2 < 3 \Rightarrow \tan 2\alpha = \frac{1}{1-1}$ which is undefined
 $\Rightarrow 2\alpha = 90^\circ \Rightarrow \alpha = 45^\circ \Rightarrow A' =$
 $= \cos^2 45^\circ + \cos 45^\circ \sin 45^\circ + \sin^2 45^\circ = \frac{3}{2}, B' = 0,$
 $C' = \sin^2 45^\circ - \sin 45^\circ \cos 45^\circ + \cos^2 45^\circ = \frac{1}{2}$
 $\Rightarrow \frac{3}{2}x'^2 + \frac{1}{2}y'^2 < 3$ which is the interior of a rotated ellipse

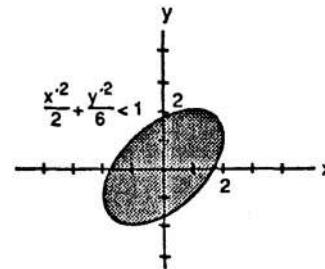

19. Arc PF = Arc AF since each is the distance rolled;
 $\angle PCF = \frac{\text{Arc PF}}{b} \Rightarrow \text{Arc PF} = b(\angle PCF); \theta = \frac{\text{Arc AF}}{a}$
 $\Rightarrow \text{Arc AF} = a\theta \Rightarrow a\theta = b(\angle PCF) \Rightarrow \angle PCF = \left(\frac{a}{b}\right)\theta;$
 $\angle OCB = \frac{\pi}{2} - \theta$ and $\angle OCB = \angle PCF - \angle PCE$
 $= \angle PCF - \left(\frac{\pi}{2} - \alpha\right) = \left(\frac{a}{b}\right)\theta - \left(\frac{\pi}{2} - \alpha\right) \Rightarrow \frac{\pi}{2} - \theta$
 $= \left(\frac{a}{b}\right)\theta - \left(\frac{\pi}{2} - \alpha\right) \Rightarrow \frac{\pi}{2} - \theta = \left(\frac{a}{b}\right)\theta - \frac{\pi}{2} + \alpha$
 $\Rightarrow \alpha = \pi - \theta - \left(\frac{a}{b}\right)\theta \Rightarrow \alpha = \pi - \left(\frac{a+b}{b}\right)\theta.$

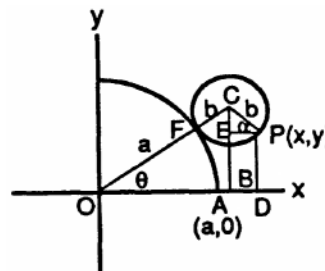

Now $x = OB + BD = OB + EP = (a + b) \cos \theta + b \cos \alpha = (a + b) \cos \theta + b \cos \left(\pi - \left(\frac{a+b}{b}\right)\theta\right)$
 $= (a + b) \cos \theta + b \cos \pi \cos \left(\left(\frac{a+b}{b}\right)\theta\right) + b \sin \pi \sin \left(\left(\frac{a+b}{b}\right)\theta\right) = (a + b) \cos \theta - b \cos \left(\left(\frac{a+b}{b}\right)\theta\right)$ and
 $y = PD = CB - CE = (a + b) \sin \theta - b \sin \alpha = (a + b) \sin \theta - b \sin \left(\left(\frac{a+b}{b}\right)\theta\right)$
 $= (a + b) \sin \theta - b \sin \pi \cos \left(\left(\frac{a+b}{b}\right)\theta\right) + b \cos \pi \sin \left(\left(\frac{a+b}{b}\right)\theta\right) = (a + b) \sin \theta - b \sin \left(\left(\frac{a+b}{b}\right)\theta\right);$
 therefore $x = (a + b) \cos \theta - b \cos \left(\left(\frac{a+b}{b}\right)\theta\right)$ and $y = (a + b) \sin \theta - b \sin \left(\left(\frac{a+b}{b}\right)\theta\right)$

20. (a) $x = a(t - \sin t) \Rightarrow \frac{dx}{dt} = a(1 - \cos t)$ and let $\delta = 1 \Rightarrow dm = dA = y dx = y \left(\frac{dx}{dt}\right) dt$
- $$= a(1 - \cos t) a(1 - \cos t) dt = a^2(1 - \cos t)^2 dt; \text{ then } A = \int_0^{2\pi} a^2(1 - \cos t)^2 dt$$
- $$= a^2 \int_0^{2\pi} (1 - 2 \cos t + \cos^2 t) dt = a^2 \int_0^{2\pi} \left(1 - 2 \cos t + \frac{1}{2} + \frac{1}{2} \cos 2t\right) dt = a^2 \left[\frac{3}{2}t - 2 \sin t + \frac{\sin 2t}{4}\right]_0^{2\pi}$$
- $$= 3\pi a^2; \tilde{x} = x = a(t - \sin t) \text{ and } \tilde{y} = \frac{1}{2}y = \frac{1}{2}a(1 - \cos t) \Rightarrow M_x = \int \tilde{y} dm = \int \tilde{y} \delta dA$$
- $$= \int_0^{2\pi} \frac{1}{2} a(1 - \cos t) a^2 (1 - \cos t)^2 dt = \frac{1}{2} a^3 \int_0^{2\pi} (1 - \cos t)^3 dt = \frac{a^3}{2} \int_0^{2\pi} (1 - 3 \cos t + 3 \cos^2 t - \cos^3 t) dt$$
- $$= \frac{a^3}{2} \int_0^{2\pi} \left[1 - 3 \cos t + \frac{3}{2} + \frac{3 \cos 2t}{2} - (1 - \sin^2 t) (\cos t)\right] dt = \frac{a^3}{2} \left[\frac{5}{2}t - 3 \sin t + \frac{3 \sin 2t}{4} - \sin t + \frac{\sin^3 t}{3}\right]_0^{2\pi}$$
- $$= \frac{5\pi a^3}{2}. \text{ Therefore } \bar{y} = \frac{M_x}{M} = \frac{\left(\frac{5\pi a^3}{2}\right)}{3\pi a^2} = \frac{5}{6}a. \text{ Also, } M_y = \int \tilde{x} dm = \int \tilde{x} \delta dA$$
- $$= \int_0^{2\pi} a(t - \sin t) a^2 (1 - \cos t)^2 dt = a^3 \int_0^{2\pi} (t - 2t \cos t + t \cos^2 t - \sin t + 2 \sin t \cos t - \sin t \cos^2 t) dt$$
- $$= a^3 \left[\frac{t^2}{2} - 2 \cos t - 2t \sin t + \frac{1}{4}t^2 + \frac{1}{8} \cos 2t + \frac{1}{4} \sin 2t + \cos t + \sin^2 t + \frac{\cos^3 t}{3}\right]_0^{2\pi} = 3\pi^2 a^3. \text{ Thus}$$
- $$\bar{x} = \frac{M_y}{M} = \frac{3\pi^2 a^3}{3\pi a^2} = \pi a \Rightarrow (\pi a, \frac{5}{6}a) \text{ is the center of mass.}$$
- (b) $x = \frac{2}{3}t^{3/2} \Rightarrow \frac{dx}{dt} = t^{1/2}$ and $y = 2t^{1/2} \Rightarrow \frac{dy}{dt} = t^{-1/2}$; let $\delta = 1 \Rightarrow dm = dA = y dx = y \left(\frac{dx}{dt}\right) dt$
- $$\Rightarrow (2t^{1/2})(t^{1/2}) dt = 2t dt; \tilde{x} = x = \frac{2}{3}t^{3/2} \text{ and } \tilde{y} = \frac{y}{2} = t^{1/2} \Rightarrow M_x = \int \tilde{y} dm = \int_0^{\sqrt{3}} t^{1/2} (2t dt)$$
- $$= \int_0^{\sqrt{3}} 2t^{3/2} dt = \left[\frac{4}{5}t^{5/2}\right]_0^{\sqrt{3}} = \frac{12}{5}\sqrt{3}. \text{ Also, } M_y = \int \tilde{x} dm = \int \tilde{x} dA = \int_0^{\sqrt{3}} \frac{2}{3}t^{3/2} (2t dt)$$
- $$= \int_0^{\sqrt{3}} \frac{4}{3}t^{5/2} dt = \left[\frac{8}{21}t^{7/2}\right]_0^{\sqrt{3}} = \frac{8}{7}\sqrt{27}.$$

21. (a) $x = e^{2t} \cos t$ and $y = e^{2t} \sin t \Rightarrow x^2 + y^2 = e^{4t} \cos^2 t + e^{4t} \sin^2 t = e^{4t}$. Also $\frac{y}{x} = \frac{e^{2t} \sin t}{e^{2t} \cos t} = \tan t$
- $$\Rightarrow t = \tan^{-1}\left(\frac{y}{x}\right) \Rightarrow x^2 + y^2 = e^{4 \tan^{-1}(y/x)}$$
- is the Cartesian equation. Since $r^2 = x^2 + y^2$ and $\theta = \tan^{-1}\left(\frac{y}{x}\right)$, the polar equation is $r^2 = e^{4\theta}$ or $r = e^{2\theta}$ for $r > 0$

- (b) $ds^2 = r^2 d\theta^2 + dr^2; r = e^{2\theta} \Rightarrow dr = 2e^{2\theta} d\theta$
- $$\Rightarrow ds^2 = r^2 d\theta^2 + (2e^{2\theta} d\theta)^2 = (e^{2\theta})^2 d\theta^2 + 4e^{4\theta} d\theta^2$$
- $$= 5e^{4\theta} d\theta^2 \Rightarrow ds = \sqrt{5}e^{2\theta} d\theta \Rightarrow L = \int_0^{2\pi} \sqrt{5}e^{2\theta} d\theta$$
- $$= \left[\frac{\sqrt{5}e^{2\theta}}{2}\right]_0^{2\pi} = \frac{\sqrt{5}}{2}(e^{4\pi} - 1)$$

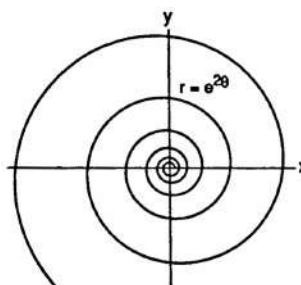

22. $r = 2 \sin^3\left(\frac{\theta}{3}\right) \Rightarrow dr = 2 \sin^2\left(\frac{\theta}{3}\right) \cos\left(\frac{\theta}{3}\right) d\theta \Rightarrow ds^2 = r^2 d\theta^2 + dr^2 = \left[2 \sin^3\left(\frac{\theta}{3}\right)\right]^2 d\theta^2 + \left[2 \sin^2\left(\frac{\theta}{3}\right) \cos\left(\frac{\theta}{3}\right) d\theta\right]^2$
- $$= 4 \sin^6\left(\frac{\theta}{3}\right) d\theta^2 + 4 \sin^4\left(\frac{\theta}{3}\right) \cos^2\left(\frac{\theta}{3}\right) d\theta^2 = \left[4 \sin^4\left(\frac{\theta}{3}\right)\right] \left[\sin^2\left(\frac{\theta}{3}\right) + \cos^2\left(\frac{\theta}{3}\right)\right] d\theta^2 = 4 \sin^4\left(\frac{\theta}{3}\right) d\theta^2$$
- $$\Rightarrow ds = 2 \sin^2\left(\frac{\theta}{3}\right) d\theta. \text{ Then } L = \int_0^{3\pi} 2 \sin^2\left(\frac{\theta}{3}\right) d\theta = \int_0^{3\pi} [1 - \cos\left(\frac{2\theta}{3}\right)] d\theta = \left[\theta - \frac{3}{2} \sin\left(\frac{2\theta}{3}\right)\right]_0^{3\pi} = 3\pi$$

23. $r = 1 + \cos \theta$ and $S = \int 2\pi \rho ds$, where $\rho = y = r \sin \theta; ds = \sqrt{r^2 d\theta^2 + dr^2}$
- $$= \sqrt{(1 + \cos \theta)^2 d\theta^2 + \sin^2 \theta d\theta^2} \sqrt{1 + 2 \cos \theta + \cos^2 \theta + \sin^2 \theta} d\theta = \sqrt{2 + 2 \cos \theta} d\theta = \sqrt{4 \cos^2\left(\frac{\theta}{2}\right)} d\theta$$
- $$= 2 \cos\left(\frac{\theta}{2}\right) d\theta \text{ since } 0 \leq \theta \leq \frac{\pi}{2}. \text{ Then } S = \int_0^{\pi/2} 2\pi(r \sin \theta) \cdot 2 \cos\left(\frac{\theta}{2}\right) d\theta = \int_0^{\pi/2} 4\pi(1 + \cos \theta) \cdot \sin \theta \cos\left(\frac{\theta}{2}\right) d\theta$$
- $$= \int_0^{\pi/2} 4\pi \left[2 \cos^2\left(\frac{\theta}{2}\right)\right] \left[2 \sin\left(\frac{\theta}{2}\right) \cos\left(\frac{\theta}{2}\right) \cos\left(\frac{\theta}{2}\right)\right] d\theta = \int_0^{\pi/2} 16\pi \cos^4\left(\frac{\theta}{2}\right) \sin\left(\frac{\theta}{2}\right) d\theta = \left[\frac{-32\pi \cos^5\left(\frac{\theta}{2}\right)}{5}\right]_0^{\pi/2}$$
- $$= \frac{(-32\pi)\left(\frac{\sqrt{2}}{2}\right)^5}{5} - \left(-\frac{32\pi}{5}\right) = \frac{32\pi - 4\pi\sqrt{2}}{5}$$

24. The region in question is the figure eight in the middle.

The arc of $r = 2a \sin^2(\frac{\theta}{2})$ in the first quadrant gives

$\frac{1}{4}$ of that region. Therefore the area is $A = 4 \int_0^{\pi/2} \frac{1}{2} r^2 d\theta$

$$= 4 \int_0^{\pi/2} \frac{1}{2} [2a \sin^2(\frac{\theta}{2})]^2 d\theta = 8a^2 \int_0^{\pi/2} \sin^4(\frac{\theta}{2}) d\theta$$

$$= 8a^2 \int_0^{\pi/2} \sin^2(\frac{\theta}{2}) [1 - \cos^2(\frac{\theta}{2})] d\theta$$

$$= 8a^2 \int_0^{\pi/2} [\sin^2(\frac{\theta}{2}) - \sin^2(\frac{\theta}{2}) \cos^2(\frac{\theta}{2})] d\theta$$

$$= 8a^2 \int_0^{\pi/2} (\frac{1 - \cos \theta}{2} - \frac{\sin^2 \theta}{4}) d\theta$$

$$= 2a^2 \int_0^{\pi/2} (2 - 2 \cos \theta - \frac{1 - \cos 2\theta}{2}) d\theta = a^2 \int_0^{\pi/2} (3 - 4 \cos \theta + \cos 2\theta) d\theta = a^2 [3\theta - 4 \sin \theta + \frac{1}{2} \sin 2\theta]_0^{\pi/2}$$

$$= a^2 (\frac{3\pi}{2} - 4)$$

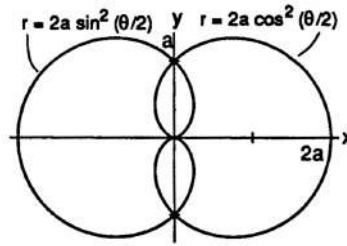

25. $e = 2$ and $r \cos \theta = 2 \Rightarrow x = 2$ is the directrix $\Rightarrow k = 2$; the conic is a hyperbola with $r = \frac{ke}{1 + e \cos \theta}$

$$\Rightarrow r = \frac{(2)(2)}{1 + 2 \cos \theta} = \frac{4}{1 + 2 \cos \theta}$$

26. $e = 1$ and $r \cos \theta = -4 \Rightarrow x = -4$ is the directrix $\Rightarrow k = 4$; the conic is a parabola with $r = \frac{ke}{1 - e \cos \theta}$

$$\Rightarrow r = \frac{(4)(1)}{1 - \cos \theta} = \frac{4}{1 - \cos \theta}$$

27. $e = \frac{1}{2}$ and $r \sin \theta = 2 \Rightarrow y = 2$ is the directrix $\Rightarrow k = 2$; the conic is an ellipse with $r = \frac{ke}{1 + e \sin \theta}$

$$\Rightarrow r = \frac{2(\frac{1}{2})}{1 + (\frac{1}{2}) \sin \theta} = \frac{2}{2 + \sin \theta}$$

28. $e = \frac{1}{3}$ and $r \sin \theta = -6 \Rightarrow y = -6$ is the directrix $\Rightarrow k = 6$; the conic is an ellipse with $r = \frac{ke}{1 - e \sin \theta}$

$$\Rightarrow r = \frac{6(\frac{1}{3})}{1 - (\frac{1}{3}) \sin \theta} = \frac{6}{3 - \sin \theta}$$

29. The length of the rope is $L = 2x + 2c + y \geq 8c$.

(a) The angle A ($\angle BED$) occurs when the distance

$CF = \ell$ is maximized. Now $\ell = \sqrt{x^2 - c^2} + y$

$$\Rightarrow \ell = \sqrt{x^2 - c^2} + L - 2x - 2c$$

$$\Rightarrow \frac{d\ell}{dx} = \frac{1}{2} (x^2 - c^2)^{-1/2} (2x) - 2 = \frac{x}{\sqrt{x^2 - c^2}} - 2.$$

Thus $\frac{d\ell}{dx} = 0 \Rightarrow \frac{x}{\sqrt{x^2 - c^2}} - 2 = 0 \Rightarrow x = 2\sqrt{x^2 - c^2}$

$$\Rightarrow x^2 = 4x^2 - 4c^2 \Rightarrow 3x^2 = 4c^2 \Rightarrow \frac{c^2}{x^2} = \frac{3}{4}$$

$$\Rightarrow \frac{c}{x} = \frac{\sqrt{3}}{2}. \text{ Since } \frac{c}{x} = \sin \frac{A}{2} \text{ we have } \sin \frac{A}{2} = \frac{\sqrt{3}}{2}$$

$$\Rightarrow \frac{A}{2} = 60^\circ \Rightarrow A = 120^\circ$$

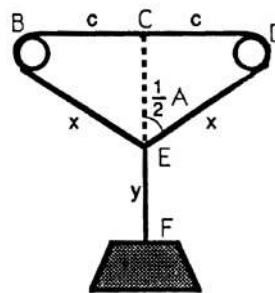

(b) If the ring is fixed at E (i.e., y is held constant) and E is moved to the right, for example, the rope will slip around the pegs so that BE lengthens and DE becomes shorter $\Rightarrow BE + ED$ is always $2x = L - y - 2c$, which is constant \Rightarrow the point E lies on an ellipse with the pegs as foci.

(c) Minimal potential energy occurs when the weight is at its lowest point \Rightarrow E is at the intersection of the ellipse and its minor axis.

30. $\frac{d_1}{c} + \frac{d_2}{c} = \frac{30}{c} \Rightarrow d_1 + d_2 = 30$; $\frac{d_3}{c} + \frac{d_4}{c} = \frac{30}{c}$
 $\Rightarrow d_3 + d_4 = 30$. Therefore P and Q lie on an ellipse with F_1 and F_2 as foci. Now $2a = d_1 + d_2 = 30 \Rightarrow a = 15$ and the focal distance is 10 $\Rightarrow b^2 = 15^2 - 10^2 = 125$
 \Rightarrow an equation of the ellipse is $\frac{x^2}{225} + \frac{y^2}{125} = 1$. Next
 $x_2 = x_1 + v_0 t = x_1 + v_0 \left(\frac{10}{v_0}\right) = x_1 + 10$.

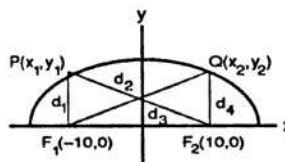

If the plane is flying level, then P and Q must be symmetric to the y-axis $\Rightarrow x_1 = -x_2 \Rightarrow x_2 = -x_1 + 10$
 $\Rightarrow x_2 = 5 \Rightarrow \frac{5^2}{225} + \frac{y_2^2}{125} = 1 \Rightarrow y_2^2 = \frac{1000}{9} \Rightarrow y_2 = \frac{10\sqrt{10}}{3}$ since y_2 must be positive. Therefore the position of the plane is $\left(5, \frac{10\sqrt{10}}{3}\right)$ where the origin $(0, 0)$ is located midway between the two stations.

31. If the vertex is $(0, 0)$, then the focus is $(p, 0)$. Let $P(x, y)$ be the present position of the comet. Then $\sqrt{(x-p)^2 + y^2} = 4 \times 10^7$. Since $y^2 = 4px$ we have $\sqrt{(x-p)^2 + 4px} = 4 \times 10^7 \Rightarrow (x-p)^2 + 4px = 16 \times 10^{14}$. Also, $x-p = 4 \times 10^7 \cos 60^\circ = 2 \times 10^7 \Rightarrow x = p + 2 \times 10^7$. Therefore $(2 \times 10^7)^2 + 4p(p + 2 \times 10^7) = 16 \times 10^{14} \Rightarrow 4 \times 10^{14} + 4p^2 + 8p \times 10^7 = 16 \times 10^{14} \Rightarrow 4p^2 + 8p \times 10^7 - 12 \times 10^{14} = 0 \Rightarrow p^2 + 2p \times 10^7 - 3 \times 10^{14} = 0 \Rightarrow (p + 3 \times 10^7)(p - 10^7) = 0 \Rightarrow p = -3 \times 10^7$ or $p = 10^7$. Since p is positive we obtain $p = 10^7$ miles.

32. $x = 2t$ and $y = t^2 \Rightarrow y = \frac{x^2}{4}$; let $D = \sqrt{(x-0)^2 + \left(\frac{x^2}{4} - 3\right)^2} = \sqrt{x^2 + \frac{x^4}{16} - \frac{3}{2}x^2 + 9} = \sqrt{\frac{x^4}{16} - \frac{1}{2}x^2 + 9}$
 $= \frac{1}{4} \sqrt{x^4 - 8x^2 + 144}$ be the distance from any point on the parabola to $(0, 3)$. We want to minimize D . Then $\frac{dD}{dx} = \frac{1}{8} (x^4 - 8x^2 + 144)^{-1/2} (4x^3 - 16x) = \frac{(\frac{1}{2})x^3 - 2x}{\sqrt{x^4 - 8x^2 + 144}} = 0 \Rightarrow \frac{1}{2}x^3 - 2x = 0 \Rightarrow x^3 - 4x = 0 \Rightarrow x = 0$ or $x = \pm 2$. Now $x = 0 \Rightarrow y = 0$ and $x = \pm 2 \Rightarrow y = 1$. The distance from $(0, 0)$ to $(0, 3)$ is $D = 3$. The distance from $(\pm 2, 1)$ to $(0, 3)$ is $D = \sqrt{(\pm 2)^2 + (1-3)^2} = 2\sqrt{2}$ which is less than 3. Therefore the points closest to $(0, 3)$ are $(\pm 2, 1)$.

33. $\cot 2\alpha = \frac{A-C}{B} = 0 \Rightarrow \alpha = 45^\circ$ is the angle of rotation $\Rightarrow A' = \cos^2 45^\circ + \cos 45^\circ \sin 45^\circ + \sin^2 45^\circ = \frac{3}{2}$, $B' = 0$, and $C' = \sin^2 45^\circ - \sin 45^\circ \cos 45^\circ + \cos^2 45^\circ = \frac{1}{2} \Rightarrow \frac{3}{2}x^2 + \frac{1}{2}y^2 = 1 \Rightarrow b = \sqrt{\frac{2}{3}}$ and $a = \sqrt{2} \Rightarrow c^2 = a^2 - b^2 = 2 - \frac{2}{3} = \frac{4}{3} \Rightarrow c = \frac{2}{\sqrt{3}}$. Therefore the eccentricity is $e = \frac{c}{a} = \frac{(\frac{2}{\sqrt{3}})}{\sqrt{2}} = \sqrt{\frac{2}{3}} \approx 0.82$.

34. The angle of rotation is $\alpha = \frac{\pi}{4} \Rightarrow A' = \sin \frac{\pi}{4} \cos \frac{\pi}{4} = \frac{1}{2}$, $B' = 0$, and $C' = -\sin \frac{\pi}{4} \cos \frac{\pi}{4} = -\frac{1}{2} \Rightarrow \frac{x'^2}{2} - \frac{y'^2}{2} = 1 \Rightarrow a = \sqrt{2}$ and $b = \sqrt{2} \Rightarrow c^2 = a^2 + b^2 = 4 \Rightarrow c = 2$. Therefore the eccentricity is $e = \frac{c}{a} = \frac{2}{\sqrt{2}} = \sqrt{2}$.

35. $\sqrt{x} + \sqrt{y} = 1 \Rightarrow x + 2\sqrt{xy} + y = 1 \Rightarrow 2\sqrt{xy} = 1 - (x+y) \Rightarrow 4xy = 1 - 2(x+y) + (x+y)^2 \Rightarrow 4xy = x^2 + 2xy + y^2 - 2x - 2y + 1 \Rightarrow x^2 - 2xy + y^2 - 2x - 2y + 1 = 0 \Rightarrow B^2 - 4AC = (-2)^2 - 4(1)(1) = 0 \Rightarrow$ the curve is part of a parabola

36. $\alpha = \frac{\pi}{4} \Rightarrow A' = 2 \sin \frac{\pi}{4} \cos \frac{\pi}{4} = 1$, $B' = 0$, $C' = -2 \sin \frac{\pi}{4} \cos \frac{\pi}{4} = -1$, $D' = -\sqrt{2} \sin \frac{\pi}{4} = -1$, $E' = -\sqrt{2} \cos \frac{\pi}{4} = -1$, $F' = 2 \Rightarrow x'^2 - y'^2 - x' - y' + 2 = 0 \Rightarrow (x'^2 - x') - (y'^2 + y') = -2 \Rightarrow (x'^2 - x' + \frac{1}{4}) - (y'^2 + y' + \frac{1}{4}) = -2 \Rightarrow \frac{(x' + \frac{1}{2})^2}{2} - \frac{(y' - \frac{1}{2})^2}{2} = 1$. The center is $(x', y') = (\frac{1}{2}, -\frac{1}{2}) \Rightarrow x = \frac{1}{2} \cos \frac{\pi}{4} - (-\frac{1}{2}) \sin \frac{\pi}{4} = \frac{\sqrt{2}}{2}$ and $y = \frac{1}{2} \sin \frac{\pi}{4} - \frac{1}{2} \cos \frac{\pi}{4} = 0$ or the center is $(x, y) = (\frac{\sqrt{2}}{2}, 0)$. Next $a = \sqrt{2} \Rightarrow$ the vertices are $(x', y') = (\frac{1}{2}, \sqrt{2} - \frac{1}{2})$ and $(\frac{1}{2}, -\sqrt{2} - \frac{1}{2}) \Rightarrow x = \frac{1}{2} \cos \frac{\pi}{4} - (\sqrt{2} - \frac{1}{2}) \sin \frac{\pi}{4} = \frac{\sqrt{2}}{2} - 1$ and $y = \frac{1}{2} \sin \frac{\pi}{4} + (\sqrt{2} - \frac{1}{2}) \cos \frac{\pi}{4} = 1$ or $(x, y) = (\frac{\sqrt{2}}{2} - 1, 1)$ is one vertex, and $x = \frac{1}{2} \cos \frac{\pi}{4} - (-\sqrt{2} - \frac{1}{2}) \sin \frac{\pi}{4}$

$= \frac{\sqrt{2}}{2} + 1$ and $y = \frac{1}{2} \sin \frac{\pi}{4} + \left(-\sqrt{2} - \frac{1}{2}\right) \sin \frac{\pi}{4} = -1$ or $(x, y) = \left(\frac{\sqrt{2}}{2} + 1, -1\right)$ is the other vertex. Also $c^2 = 2 + 2 = 4 \Rightarrow c = 2 \Rightarrow$ the foci are $(x', y') = \left(\frac{1}{2}, \frac{3}{2}\right)$ and $\left(\frac{1}{2}, -\frac{5}{2}\right) \Rightarrow x = \frac{1}{2} \cos \frac{\pi}{4} - \frac{3}{2} \sin \frac{\pi}{4} = -\frac{\sqrt{2}}{2}$ and $y = \frac{1}{2} \sin \frac{\pi}{4} + \frac{3}{2} \cos \frac{\pi}{4} = \sqrt{2}$ or $(x, y) = \left(-\frac{\sqrt{2}}{2}, \sqrt{2}\right)$ is one focus, and $x = \frac{1}{2} \cos \frac{\pi}{4} + \frac{5}{2} \sin \frac{\pi}{4} = \frac{3\sqrt{2}}{2}$ and $y = \frac{1}{2} \sin \frac{\pi}{4} - \frac{5}{2} \cos \frac{\pi}{4} = -\sqrt{2}$ or $(x, y) = \left(\frac{3\sqrt{2}}{2}, -\sqrt{2}\right)$ is the other focus. The asymptotes are $y' + \frac{1}{2} = \pm \left(x' - \frac{1}{2}\right)$ in the rotated system. Since $x = \frac{1}{\sqrt{2}} x' - \frac{1}{\sqrt{2}} y'$ and $y = \frac{1}{\sqrt{2}} x' + \frac{1}{\sqrt{2}} y' \Rightarrow x + y = \frac{2}{\sqrt{2}} x' \Rightarrow \frac{\sqrt{2}}{2} x + \frac{\sqrt{2}}{2} y = x'$ and $x - y = -\frac{2}{\sqrt{2}} y' \Rightarrow -\frac{\sqrt{2}}{2} x + \frac{\sqrt{2}}{2} y = y'$; the asymptotes are $-\frac{\sqrt{2}}{2} x + \frac{\sqrt{2}}{2} y + \frac{1}{2} = \pm \left(\frac{\sqrt{2}}{2} x + \frac{\sqrt{2}}{2} y - \frac{1}{2}\right) \Rightarrow$ the asymptotes are $-\sqrt{2}x + 1 = 0$ or $x = \frac{1}{\sqrt{2}}$ and $\sqrt{2}y = 0$ or $y = 0$. Finally, the x' -axis is the line through $\left(\frac{\sqrt{2}}{2}, 0\right)$ with a slope of 1 (recall that $\alpha = \frac{\pi}{4}$) $\Rightarrow y = x - \frac{\sqrt{2}}{2}$. The y' -axis is the line through $\left(\frac{\sqrt{2}}{2}, 0\right)$ with a slope of $-1 \Rightarrow y = -x + \frac{\sqrt{2}}{2}$.

37. (a) The equation of a parabola with focus $(0, 0)$ and vertex $(a, 0)$ is $r = \frac{2a}{1 + \cos \theta}$ and rotating this parabola through $\alpha = 45^\circ$ gives $r = \frac{2a}{1 + \cos(\theta - \frac{\pi}{4})}$.
- (b) Foci at $(0, 0)$ and $(2, 0) \Rightarrow$ the center is $(1, 0) \Rightarrow a = 3$ and $c = 1$ since one vertex is at $(4, 0)$. Then $e = \frac{c}{a} = \frac{1}{3}$. For ellipses with one focus at the origin and major axis along the x -axis we have $r = \frac{a(1 - e^2)}{1 - e \cos \theta} = \frac{3(1 - \frac{1}{9})}{1 - (\frac{1}{3}) \cos \theta} = \frac{8}{3 - \cos \theta}$.
- (c) Center at $(2, \frac{\pi}{2})$ and focus at $(0, 0) \Rightarrow c = 2$; center at $(2, \frac{\pi}{2})$ and vertex at $(1, \frac{\pi}{2}) \Rightarrow a = 1$. Then $e = \frac{c}{a} = \frac{2}{1} = 2$. Also $k = ae - \frac{a}{e} = (1)(2) - \frac{1}{2} = \frac{3}{2}$. Therefore $r = \frac{ke}{1 + e \sin \theta} = \frac{(\frac{3}{2})(2)}{1 + 2 \sin \theta} = \frac{3}{1 + 2 \sin \theta}$.

38. Let (d_1, θ_1) and (d_2, θ_2) be the polar coordinates of P_1 and P_2 , respectively. Then $\theta_2 = \theta_1 + \pi$, and we have $d_1 = \frac{3}{2 + \cos \theta_1}$ and $d_2 = \frac{3}{2 + \cos(\theta_1 + \pi)}$. Therefore $\frac{1}{d_1} + \frac{1}{d_2} = \frac{2 + \cos \theta_1}{3} + \frac{2 + \cos(\theta_1 + \pi)}{3} = \frac{4 + \cos \theta_1 + \cos \theta_1 \cos \pi - \sin \theta_1 \sin \pi}{3} = \frac{4}{3}$.

39. Arc $PT =$ Arc TO since each is the same distance rolled. Now Arc $PT = a(\angle TAP)$ and Arc $TO = a(\angle TBO) \Rightarrow \angle TAP = \angle TBO$. Since $AP = a = BO$ we have that $\triangle ADP$ is congruent to $\triangle BCO \Rightarrow CO = DP \Rightarrow OP$ parallel to $AB \Rightarrow \angle TBO = \angle TAP = \theta$. Then $OPDC$ is a square $\Rightarrow r = CD = AB - AD - CB = AB - 2CB \Rightarrow r = 2a - 2a \cos \theta = 2a(1 - \cos \theta)$, which is the polar equation of a cardioid.

40. Note first that the point P traces out a circular arc as the door closes until the second door panel is tangent to the circle. This happens when P is located at $\left(\frac{1}{\sqrt{2}}, \frac{1}{\sqrt{2}}\right)$, since $\angle OPQ$ is 90° at that time. Thus the curve is the circle $x^2 + y^2 = 1$ for $0 \leq x \leq \frac{1}{\sqrt{2}}$. When $x \geq \frac{1}{\sqrt{2}}$, the second door panel is tangent to the curve at P . Now let t represent $\angle POQ$ so that as t runs from $\frac{\pi}{2}$ to 0 , the door closes. The coordinates of P are given by $(\cos t, \sin t)$, and the coordinates of Q by $(2 \cos t, 0)$ (since triangle POQ is isosceles). Therefore at a fixed instant of time t , the slope of the line formed by the second panel PQ is $m = \frac{\Delta y}{\Delta x} = \frac{\sin t - 0}{\cos t - 2 \cos t} = -\tan t \Rightarrow$ the tangent line PQ is $y - 0 = (-\tan t)(x - 2 \cos t) \Rightarrow y = (-\tan t)x + 2 \sin t$. Now, to find an equation of the curve for $\frac{1}{\sqrt{2}} \leq x \leq 1$, we want to find, for fixed x , the largest value of y as t ranges over the interval $0 \leq t \leq \frac{\pi}{4}$. We solve $\frac{dy}{dt} = 0 \Rightarrow (-\sec^2 t)x + 2 \cos t = 0 \Rightarrow (-\sec^2 t)x = -2 \cos t \Rightarrow x = 2 \cos^3 t$. (Note that $\frac{d^2 y}{dt^2} = (-2 \sec^2 t \tan t)x - 2 \sin t < 0$ on $0 \leq t \leq \frac{\pi}{2}$, so a maximum occurs for y .) Now $x = 2 \cos^3 t \Rightarrow$ the

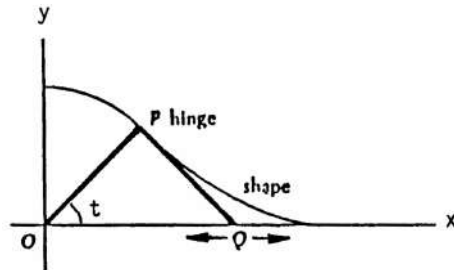

corresponding y value is $y = (-\tan t)(2 \cos^3 t) + 2 \sin t = -2 \sin t \cos^2 t + 2 \sin t = (2 \sin t)(-\cos^2 t + 1) = 2 \sin^3 t$. Therefore parametric equations for the path of the curve are given by $x = 2 \cos^3 t$ and $y = 2 \sin^3 t$ for $0 \leq t \leq \frac{\pi}{4}$. In Cartesian coordinates, we have the curve $x^{2/3} + y^{2/3} = (2 \cos^3 t)^{2/3} + (2 \sin^3 t)^{2/3} = 2^{2/3}(\cos^2 t + \sin^2 t) = 2^{2/3} \Rightarrow$ the curve traced out by the door is given by

$$\left. \begin{aligned} x^2 + y^2 &= 1 && \text{for } 0 \leq x \leq \frac{1}{\sqrt{2}} \\ x^{2/3} + y^{2/3} &= 2^{2/3} && \text{for } \frac{1}{\sqrt{2}} \leq x \leq 1 \end{aligned} \right\}$$

41. $\beta = \psi_2 - \psi_1 \Rightarrow \tan \beta = \tan(\psi_2 - \psi_1) = \frac{\tan \psi_2 - \tan \psi_1}{1 + \tan \psi_2 \tan \psi_1}$;
 the curves will be orthogonal when $\tan \beta$ is undefined, or
 when $\tan \psi_2 = \frac{-1}{\tan \psi_1} \Rightarrow \frac{r}{g'(\theta)} = \frac{-1}{\left[\frac{r}{f'(\theta)}\right]}$
 $\Rightarrow r^2 = -f'(\theta)g'(\theta)$

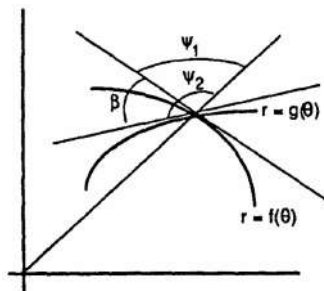

42. $r = \sin^4\left(\frac{\theta}{4}\right) \Rightarrow \frac{dr}{d\theta} = \sin^3\left(\frac{\theta}{4}\right) \cos\left(\frac{\theta}{4}\right) \Rightarrow \tan \psi = \frac{\sin^4\left(\frac{\theta}{4}\right)}{\sin^3\left(\frac{\theta}{4}\right) \cos\left(\frac{\theta}{4}\right)} = \tan\left(\frac{\theta}{4}\right)$

43. $r = 2a \sin 3\theta \Rightarrow \frac{dr}{d\theta} = 6a \cos 3\theta \Rightarrow \tan \psi = \frac{r}{\left(\frac{dr}{d\theta}\right)} = \frac{2a \sin 3\theta}{6a \cos 3\theta} = \frac{1}{3} \tan 3\theta$; when $\theta = \frac{\pi}{6}$, $\tan \psi = \frac{1}{3} \tan \frac{\pi}{2} \Rightarrow \psi = \frac{\pi}{2}$

44. (a)

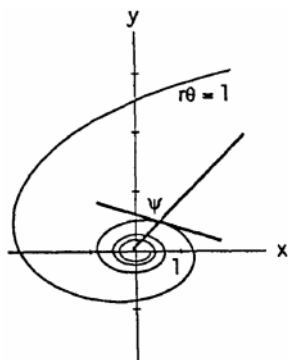

(b) $r\theta = 1 \Rightarrow r = \theta^{-1} \Rightarrow \frac{dr}{d\theta} = -\theta^{-2} \Rightarrow \tan \psi|_{\theta=1} = \frac{\theta^{-1}}{-\theta^{-2}} = -\theta \Rightarrow \lim_{\theta \rightarrow \infty} \tan \psi = -\infty \Rightarrow \psi \rightarrow \frac{\pi}{2}$ from the right as the spiral winds in around the origin.

45. $\tan \psi_1 = \frac{\sqrt{3} \cos \theta}{-\sqrt{3} \sin \theta} = -\cot \theta$ is $-\frac{1}{\sqrt{3}}$ at $\theta = \frac{\pi}{3}$; $\tan \psi_2 = \frac{\sin \theta}{\cos \theta} = \tan \theta$ is $\sqrt{3}$ at $\theta = \frac{\pi}{3}$; since the product of these slopes is -1 , the tangents are perpendicular

46. $a(1 + \cos \theta) = 3a \cos \theta \Rightarrow 1 = 2 \cos \theta \Rightarrow \cos \theta = \frac{1}{2}$ or $\theta = \frac{\pi}{3}$; $\tan \psi_1 = \frac{a(1 + \cos \theta)}{-a \sin \theta}$ is $-\sqrt{3}$ at $\theta = \frac{\pi}{3}$;
 $\tan \psi_2 = \frac{3a \cos \theta}{-3a \sin \theta}$ is $-\frac{1}{\sqrt{3}}$ at $\theta = \frac{\pi}{3}$. Then
 $\tan \beta = \frac{-\frac{1}{\sqrt{3}} - (-\sqrt{3})}{1 + (-\frac{1}{\sqrt{3}})(-\sqrt{3})} = \frac{-\frac{1}{\sqrt{3}} + \sqrt{3}}{2} = \frac{1}{\sqrt{3}} \Rightarrow \beta = \frac{\pi}{6}$

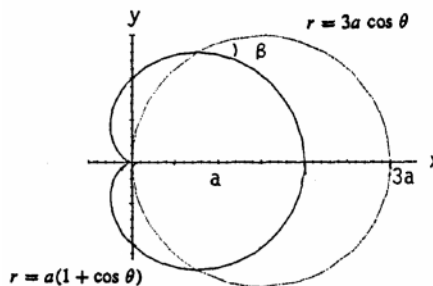

47. $r_1 = \frac{1}{1 - \cos \theta} \Rightarrow \frac{dr_1}{d\theta} = -\frac{\sin \theta}{(1 - \cos \theta)^2}$; $r_2 = \frac{3}{1 + \cos \theta} \Rightarrow \frac{dr_2}{d\theta} = \frac{3 \sin \theta}{(1 + \cos \theta)^2}$; $\frac{1}{1 - \cos \theta} = \frac{3}{1 + \cos \theta}$
 $\Rightarrow 1 + \cos \theta = 3 - 3 \cos \theta \Rightarrow 4 \cos \theta = 2 \Rightarrow \cos \theta = \frac{1}{2} \Rightarrow \theta = \pm \frac{\pi}{3} \Rightarrow r_1 = r_2 = 2 \Rightarrow$ the curves intersect at the
 points $(2, \pm \frac{\pi}{3})$; $\tan \psi_1 = \frac{\left(\frac{1}{1 - \cos \theta}\right)}{\left[\frac{-\sin \theta}{(1 - \cos \theta)^2}\right]} = -\frac{1 - \cos \theta}{\sin \theta}$ is $-\frac{1}{\sqrt{3}}$ at $\theta = \frac{\pi}{3}$; $\tan \psi_2 = \frac{\left(\frac{3}{1 + \cos \theta}\right)}{\left[\frac{3 \sin \theta}{(1 + \cos \theta)^2}\right]} = \frac{1 + \cos \theta}{\sin \theta}$ is
 $\sqrt{3}$ at $\theta = \frac{\pi}{3}$; therefore $\tan \beta$ is undefined at $\theta = \frac{\pi}{3}$ since $1 + \tan \psi_1 \tan \psi_2 = 1 + \left(-\frac{1}{\sqrt{3}}\right)(\sqrt{3}) = 0 \Rightarrow \beta = \frac{\pi}{2}$;
 $\tan \psi_1|_{\theta=-\pi/3} = -\frac{1 - \cos(-\pi/3)}{\sin(-\pi/3)} = \frac{1}{\sqrt{3}}$ and $\tan \psi_2|_{\theta=-\pi/3} = \frac{1 + \cos(-\pi/3)}{\sin(-\pi/3)} = -\sqrt{3} \Rightarrow \tan \beta$ is also undefined
 at $\theta = -\frac{\pi}{3} \Rightarrow \beta = \frac{\pi}{2}$

48. (a) We need $\psi + \theta = \pi$, so that $\tan \psi = \tan(\pi - \theta)$
 $= -\tan \theta$. Now $\tan \psi = \frac{r}{\left(\frac{dr}{d\theta}\right)} = \frac{a(1 + \cos \theta)}{-a \sin \theta}$
 $= -\tan \theta = -\frac{\sin \theta}{\cos \theta} \Rightarrow \cos \theta + \cos^2 \theta = \sin^2 \theta$
 $\Rightarrow \cos \theta + \cos^2 \theta = 1 - \cos^2 \theta$
 $\Rightarrow 2 \cos^2 \theta + \cos \theta - 1 = 0$
 $\Rightarrow \cos \theta = \frac{1}{2}$ or $\cos \theta = -1$; $\cos \theta = \frac{1}{2} \Rightarrow \theta = \pm \frac{\pi}{3}$
 $\Rightarrow r = \frac{3a}{2}$; $\cos \theta = -1 \Rightarrow \theta = \pi \Rightarrow r = 0$.

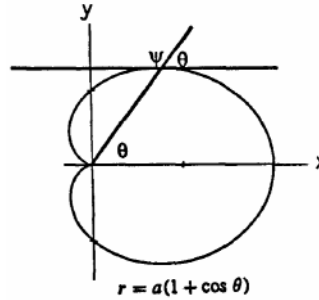

Therefore the points where the tangent line
 is horizontal are $(\frac{3a}{2}, \pm \frac{\pi}{3})$ and $(0, \pi)$.

(b) We need $\psi + \theta = \frac{\pi}{2}$ so that $\tan \psi = \tan(\frac{\pi}{2} - \theta) = \cot \theta$. Thus $\tan \psi = \frac{r}{\left(\frac{dr}{d\theta}\right)} = \frac{a(1 + \cos \theta)}{-a \sin \theta} = \cot \theta$
 $= \frac{\cos \theta}{\sin \theta} \Rightarrow \sin \theta + \sin \theta \cos \theta = -\sin \theta \cos \theta \Rightarrow \cos \theta = -\frac{1}{2}$ or $\sin \theta = 0$; $\cos \theta = -\frac{1}{2} \Rightarrow \theta = \pm \frac{2\pi}{3}$
 $\Rightarrow r = \frac{a}{2}$; $\sin \theta = 0 \Rightarrow \theta = 0$ (not π , see part (a)) $\Rightarrow r = 2a$. Therefore the points where the tangent line
 is vertical are $(\frac{a}{2}, \pm \frac{2\pi}{3})$ and $(2a, 0)$.

49. $r_1 = \frac{a}{1 + \cos \theta} \Rightarrow \frac{dr_1}{d\theta} = \frac{a \sin \theta}{(1 + \cos \theta)^2}$ and $r_2 = \frac{b}{1 - \cos \theta} \Rightarrow \frac{dr_2}{d\theta} = -\frac{b \sin \theta}{(1 - \cos \theta)^2}$; then
 $\tan \psi_1 = \frac{\left(\frac{a}{1 + \cos \theta}\right)}{\left[\frac{a \sin \theta}{(1 + \cos \theta)^2}\right]} = \frac{1 + \cos \theta}{\sin \theta}$ and $\tan \psi_2 = \frac{\left(\frac{b}{1 - \cos \theta}\right)}{\left[\frac{-b \sin \theta}{(1 - \cos \theta)^2}\right]} = \frac{1 - \cos \theta}{-\sin \theta} \Rightarrow 1 + \tan \psi_1 \tan \psi_2$
 $= 1 + \left(\frac{1 + \cos \theta}{\sin \theta}\right)\left(\frac{1 - \cos \theta}{-\sin \theta}\right) = 1 - \frac{1 - \cos^2 \theta}{\sin^2 \theta} = 0 \Rightarrow \beta$ is undefined \Rightarrow the parabolas are orthogonal at each
 point of intersection

50. $\tan \psi = \frac{r}{\left(\frac{dr}{d\theta}\right)} = \frac{a(1 - \cos \theta)}{a \sin \theta}$ is 1 at $\theta = \frac{\pi}{2} \Rightarrow \psi = \frac{\pi}{4}$

51. $r = 3 \sec \theta \Rightarrow r = \frac{3}{\cos \theta}$; $\frac{3}{\cos \theta} = 4 + 4 \cos \theta \Rightarrow 3 = 4 \cos \theta + 4 \cos^2 \theta \Rightarrow (2 \cos \theta + 3)(2 \cos \theta - 1) = 0$
 $\Rightarrow \cos \theta = \frac{1}{2}$ or $\cos \theta = -\frac{3}{2} \Rightarrow \theta = \frac{\pi}{3}$ or $\frac{5\pi}{3}$ (the second equation has no solutions); $\tan \psi_2 = \frac{4(1 + \cos \theta)}{-4 \sin \theta}$
 $= -\frac{1 + \cos \theta}{\sin \theta}$ is $-\sqrt{3}$ at $\frac{\pi}{3}$ and $\tan \psi_1 = \frac{3 \sec \theta}{3 \sec \theta \tan \theta} = \cot \theta$ is $\frac{1}{\sqrt{3}}$ at $\frac{\pi}{3}$. Then $\tan \beta$ is undefined since
 $1 + \tan \psi_1 \tan \psi_2 = 1 + \left(\frac{1}{\sqrt{3}}\right)(-\sqrt{3}) = 0 \Rightarrow \beta = \frac{\pi}{2}$. Also, $\tan \psi_2|_{5\pi/3} = \sqrt{3}$ and $\tan \psi_1|_{5\pi/3} = -\frac{1}{\sqrt{3}}$
 $\Rightarrow 1 + \tan \psi_1 \tan \psi_2 = 1 + \left(-\frac{1}{\sqrt{3}}\right)(\sqrt{3}) = 0 \Rightarrow \tan \beta$ is also undefined $\Rightarrow \beta = \frac{\pi}{2}$.

52. $\tan \psi = \frac{a \tan(\frac{\theta}{2})}{\frac{2}{3} \sec^2(\frac{\theta}{2})} = 1$ at $\theta = \frac{\pi}{2} \Rightarrow \psi = \frac{\pi}{4}$; $m_{\tan} = \tan(\theta + \psi) = \tan \frac{3\pi}{4} = -1$

53. $\frac{1}{1 - \cos \theta} = \frac{1}{1 - \sin \theta} \Rightarrow 1 - \cos \theta = 1 - \sin \theta \Rightarrow \cos \theta = \sin \theta \Rightarrow \theta = \frac{\pi}{4}$; $\tan \psi_1 = \frac{\left(\frac{1}{1 - \cos \theta}\right)}{\left[\frac{-\sin \theta}{(1 - \cos \theta)^2}\right]} = \frac{1 - \cos \theta}{-\sin \theta}$;
 $\tan \psi_2 = \frac{\left(\frac{1 - \sin \theta}{\cos \theta}\right)}{\left[\frac{1 - \sin \theta}{(1 - \sin \theta)^2}\right]} = \frac{1 - \sin \theta}{\cos \theta}$. Thus at $\theta = \frac{\pi}{4}$, $\tan \psi_1 = \frac{1 - \cos(\frac{\pi}{4})}{-\sin(\frac{\pi}{4})} = 1 - \sqrt{2}$ and

$$\tan \psi_2 = \frac{1 - \sin(\frac{\pi}{4})}{\cos(\frac{\pi}{4})} = \sqrt{2} - 1. \text{ Then } \tan \beta = \frac{(\sqrt{2}-1) - (1-\sqrt{2})}{1 + (\sqrt{2}-1)(1-\sqrt{2})} = \frac{2\sqrt{2}-2}{2\sqrt{2}-2} = 1 \Rightarrow \beta = \frac{\pi}{4}$$

54. (a)

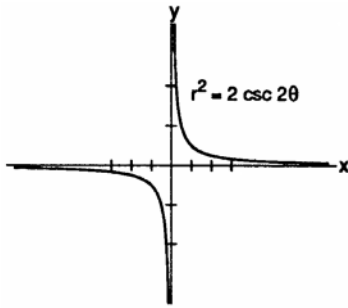

(b) $r^2 = 2 \csc 2\theta = \frac{2}{\sin 2\theta} = \frac{2}{2 \sin \theta \cos \theta}$
 $\Rightarrow r^2 \sin \theta \cos \theta = 1 \Rightarrow xy = 1$, a hyperbola

(c) At $\theta = \frac{\pi}{4}$, $x = y = 1 \Rightarrow \frac{dy}{dx} = -\frac{1}{x^2} = -1$
 $= m_{\tan} \Rightarrow \phi = \frac{3\pi}{4} \Rightarrow \psi = \phi - \theta = \frac{3\pi}{4} - \frac{\pi}{4} = \frac{\pi}{2}$

55. (a) $\tan \alpha = \frac{r}{(\frac{dr}{d\theta})} \Rightarrow \frac{dr}{r} = \frac{d\theta}{\tan \alpha} \Rightarrow \ln r = \frac{\theta}{\tan \alpha} + C$ (by integration) $\Rightarrow r = Be^{\theta/(\tan \alpha)}$ for some constant B;

$$A = \frac{1}{2} \int_{\theta_1}^{\theta_2} B^2 e^{2\theta/(\tan \alpha)} d\theta = \left[\frac{B^2 (\tan \alpha) e^{2\theta/(\tan \alpha)}}{4} \right]_{\theta_1}^{\theta_2} = \frac{\tan \alpha}{4} [B^2 e^{2\theta_2/(\tan \alpha)} - B^2 e^{2\theta_1/(\tan \alpha)}]$$

$$= \frac{\tan \alpha}{4} (r_2^2 - r_1^2) \text{ since } r_2^2 = B^2 e^{2\theta_2/(\tan \alpha)} \text{ and } r_1^2 = B^2 e^{2\theta_1/(\tan \alpha)}; \text{ constant of proportionality } K = \frac{\tan \alpha}{4}$$

(b) $\tan \alpha = \frac{r}{(\frac{dr}{d\theta})} \Rightarrow \frac{dr}{d\theta} = \frac{r}{\tan \alpha} \Rightarrow (\frac{dr}{d\theta})^2 = \frac{r^2}{\tan^2 \alpha} \Rightarrow r^2 + (\frac{dr}{d\theta})^2 = r^2 + \frac{r^2}{\tan^2 \alpha} = r^2 \left(\frac{\tan^2 \alpha + 1}{\tan^2 \alpha} \right)$
 $= r^2 \left(\frac{\sec^2 \alpha}{\tan^2 \alpha} \right) \Rightarrow \text{Length} = \int_{\theta_1}^{\theta_2} r \left(\frac{\sec \alpha}{\tan \alpha} \right) d\theta = \int_{\theta_1}^{\theta_2} B e^{\theta/(\tan \alpha)} \cdot \frac{\sec \alpha}{\tan \alpha} d\theta = [B (\sec \alpha) e^{\theta/(\tan \alpha)}]_{\theta_1}^{\theta_2}$
 $= (\sec \alpha) [B e^{\theta_2/(\tan \alpha)} - B e^{\theta_1/(\tan \alpha)}] = K (r_2 - r_1)$ where $K = \sec \alpha$ is the constant of proportionality

56. $r^2 \sin 2\theta = 2a^2 \Rightarrow r^2 \sin \theta \cos \theta = a^2 \Rightarrow xy = a^2$ and

$\frac{dy}{dx} = -\frac{a^2}{x^2}$. If $P(x_1, y_1)$ is a point on the curve, the tangent line is $y - y_1 = -\frac{a^2}{x_1^2} (x - x_1)$, so the tangent line crosses

the x-axis when $y = 0 \Rightarrow -y_1 = -\frac{a^2}{x_1^2} (x - x_1)$

$$\Rightarrow \frac{x_1^2 y_1}{a^2} = x - x_1 \Rightarrow x = \frac{x_1^2 y_1}{a^2} + x_1 = x_1 + x_1 = 2x_1$$

since $\frac{x_1 y_1}{a^2} = 1$. Let Q be $(2x_1, 0)$. Then

$$PQ = \sqrt{(2x_1 - x_1)^2 + (0 - y_1)^2} = \sqrt{x_1^2 + y_1^2} \text{ and}$$

$$OP = r = \sqrt{(x_1 - 0)^2 + (y_1 - 0)^2} = \sqrt{x_1^2 + y_1^2} \Rightarrow OP = PQ \text{ and the triangle is isosceles.}$$

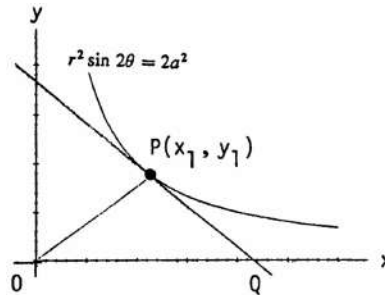

NOTES:

CHAPTER 11 INFINITE SEQUENCES AND SERIES

11.1 SEQUENCES

- $a_1 = \frac{1-1}{1^2} = 0, a_2 = \frac{1-2}{2^2} = -\frac{1}{4}, a_3 = \frac{1-3}{3^2} = -\frac{2}{9}, a_4 = \frac{1-4}{4^2} = -\frac{3}{16}$
- $a_1 = \frac{1}{1!} = 1, a_2 = \frac{1}{2!} = \frac{1}{2}, a_3 = \frac{1}{3!} = \frac{1}{6}, a_4 = \frac{1}{4!} = \frac{1}{24}$
- $a_1 = \frac{(-1)^2}{2-1} = 1, a_2 = \frac{(-1)^3}{4-1} = -\frac{1}{3}, a_3 = \frac{(-1)^4}{6-1} = \frac{1}{5}, a_4 = \frac{(-1)^5}{8-1} = -\frac{1}{7}$
- $a_1 = 2 + (-1)^1 = 1, a_2 = 2 + (-1)^2 = 3, a_3 = 2 + (-1)^3 = 1, a_4 = 2 + (-1)^4 = 3$
- $a_1 = \frac{2}{2^2} = \frac{1}{2}, a_2 = \frac{2^2}{2^3} = \frac{1}{2}, a_3 = \frac{2^3}{2^4} = \frac{1}{2}, a_4 = \frac{2^4}{2^5} = \frac{1}{2}$
- $a_1 = \frac{2-1}{2} = \frac{1}{2}, a_2 = \frac{2^2-1}{2^2} = \frac{3}{4}, a_3 = \frac{2^3-1}{2^3} = \frac{7}{8}, a_4 = \frac{2^4-1}{2^4} = \frac{15}{16}$
- $a_1 = 1, a_2 = 1 + \frac{1}{2} = \frac{3}{2}, a_3 = \frac{3}{2} + \frac{1}{2^2} = \frac{7}{4}, a_4 = \frac{7}{4} + \frac{1}{2^3} = \frac{15}{8}, a_5 = \frac{15}{8} + \frac{1}{2^4} = \frac{31}{16}, a_6 = \frac{63}{32},$
 $a_7 = \frac{127}{64}, a_8 = \frac{255}{128}, a_9 = \frac{511}{256}, a_{10} = \frac{1023}{512}$
- $a_1 = 1, a_2 = \frac{1}{2}, a_3 = \frac{(\frac{1}{2})}{3} = \frac{1}{6}, a_4 = \frac{(\frac{1}{6})}{4} = \frac{1}{24}, a_5 = \frac{(\frac{1}{24})}{5} = \frac{1}{120}, a_6 = \frac{1}{720}, a_7 = \frac{1}{5040}, a_8 = \frac{1}{40,320},$
 $a_9 = \frac{1}{362,880}, a_{10} = \frac{1}{3,628,800}$
- $a_1 = 2, a_2 = \frac{(-1)^2(2)}{2} = 1, a_3 = \frac{(-1)^3(1)}{2} = -\frac{1}{2}, a_4 = \frac{(-1)^4(-\frac{1}{2})}{2} = -\frac{1}{4}, a_5 = \frac{(-1)^5(-\frac{1}{4})}{2} = \frac{1}{8},$
 $a_6 = \frac{1}{16}, a_7 = -\frac{1}{32}, a_8 = -\frac{1}{64}, a_9 = \frac{1}{128}, a_{10} = \frac{1}{256}$
- $a_1 = -2, a_2 = \frac{1 \cdot (-2)}{2} = -1, a_3 = \frac{2 \cdot (-1)}{3} = -\frac{2}{3}, a_4 = \frac{3 \cdot (-\frac{2}{3})}{4} = -\frac{1}{2}, a_5 = \frac{4 \cdot (-\frac{1}{2})}{5} = -\frac{2}{5}, a_6 = -\frac{1}{3},$
 $a_7 = -\frac{2}{7}, a_8 = -\frac{1}{4}, a_9 = -\frac{2}{9}, a_{10} = -\frac{1}{5}$
- $a_1 = 1, a_2 = 1, a_3 = 1 + 1 = 2, a_4 = 2 + 1 = 3, a_5 = 3 + 2 = 5, a_6 = 8, a_7 = 13, a_8 = 21, a_9 = 34, a_{10} = 55$
- $a_1 = 2, a_2 = -1, a_3 = -\frac{1}{2}, a_4 = \frac{(-\frac{1}{2})}{-1} = \frac{1}{2}, a_5 = \frac{(\frac{1}{2})}{(-\frac{1}{2})} = -1, a_6 = -2, a_7 = 2, a_8 = -1, a_9 = -\frac{1}{2}, a_{10} = \frac{1}{2}$
- $a_n = (-1)^{n+1}, n = 1, 2, \dots$
- $a_n = (-1)^n, n = 1, 2, \dots$
- $a_n = (-1)^{n+1}n^2, n = 1, 2, \dots$
- $a_n = \frac{(-1)^{n+1}}{n^2}, n = 1, 2, \dots$
- $a_n = n^2 - 1, n = 1, 2, \dots$
- $a_n = n - 4, n = 1, 2, \dots$
- $a_n = 4n - 3, n = 1, 2, \dots$
- $a_n = 4n - 2, n = 1, 2, \dots$
- $a_n = \frac{1 + (-1)^{n+1}}{2}, n = 1, 2, \dots$
- $a_n = \frac{n - \frac{1}{2} + (-1)^n(\frac{1}{2})}{2} = \lfloor \frac{n}{2} \rfloor, n = 1, 2, \dots$
- $\lim_{n \rightarrow \infty} 2 + (0.1)^n = 2 \Rightarrow \text{converges}$ (Theorem 5, #4)

$$24. \lim_{n \rightarrow \infty} \frac{n+(-1)^n}{n} = \lim_{n \rightarrow \infty} 1 + \frac{(-1)^n}{n} = 1 \Rightarrow \text{converges}$$

$$25. \lim_{n \rightarrow \infty} \frac{1-2n}{1+2n} = \lim_{n \rightarrow \infty} \frac{\left(\frac{1}{n}\right)-2}{\left(\frac{1}{n}\right)+2} = \lim_{n \rightarrow \infty} \frac{-2}{2} = -1 \Rightarrow \text{converges}$$

$$26. \lim_{n \rightarrow \infty} \frac{2n+1}{1-3\sqrt{n}} = \lim_{n \rightarrow \infty} \frac{2\sqrt{n} + \left(\frac{1}{\sqrt{n}}\right)}{\left(\frac{1}{\sqrt{n}} - 3\right)} = -\infty \Rightarrow \text{diverges}$$

$$27. \lim_{n \rightarrow \infty} \frac{1-5n^4}{n^4+8n^3} = \lim_{n \rightarrow \infty} \frac{\left(\frac{1}{n^4}\right)-5}{1+\left(\frac{8}{n}\right)} = -5 \Rightarrow \text{converges}$$

$$28. \lim_{n \rightarrow \infty} \frac{n+3}{n^2+5n+6} = \lim_{n \rightarrow \infty} \frac{n+3}{(n+3)(n+2)} = \lim_{n \rightarrow \infty} \frac{1}{n+2} = 0 \Rightarrow \text{converges}$$

$$29. \lim_{n \rightarrow \infty} \frac{n^2-2n+1}{n-1} = \lim_{n \rightarrow \infty} \frac{(n-1)(n-1)}{n-1} = \lim_{n \rightarrow \infty} (n-1) = \infty \Rightarrow \text{diverges}$$

$$30. \lim_{n \rightarrow \infty} \frac{1-n^3}{70-4n^2} = \lim_{n \rightarrow \infty} \frac{\left(\frac{1}{n^2}\right)-n}{\left(\frac{70}{n^2}\right)-4} = \infty \Rightarrow \text{diverges}$$

$$31. \lim_{n \rightarrow \infty} (1+(-1)^n) \text{ does not exist} \Rightarrow \text{diverges} \quad 32. \lim_{n \rightarrow \infty} (-1)^n \left(1 - \frac{1}{n}\right) \text{ does not exist} \Rightarrow \text{diverges}$$

$$33. \lim_{n \rightarrow \infty} \left(\frac{n+1}{2n}\right) \left(1 - \frac{1}{n}\right) = \lim_{n \rightarrow \infty} \left(\frac{1}{2} + \frac{1}{2n}\right) \left(1 - \frac{1}{n}\right) = \frac{1}{2} \Rightarrow \text{converges}$$

$$34. \lim_{n \rightarrow \infty} \left(2 - \frac{1}{2^n}\right) \left(3 + \frac{1}{2^n}\right) = 6 \Rightarrow \text{converges} \quad 35. \lim_{n \rightarrow \infty} \frac{(-1)^{n+1}}{2n-1} = 0 \Rightarrow \text{converges}$$

$$36. \lim_{n \rightarrow \infty} \left(-\frac{1}{2}\right)^n = \lim_{n \rightarrow \infty} \frac{(-1)^n}{2^n} = 0 \Rightarrow \text{converges}$$

$$37. \lim_{n \rightarrow \infty} \sqrt{\frac{2n}{n+1}} = \sqrt{\lim_{n \rightarrow \infty} \frac{2n}{n+1}} = \sqrt{\lim_{n \rightarrow \infty} \left(\frac{2}{1+\frac{1}{n}}\right)} = \sqrt{2} \Rightarrow \text{converges}$$

$$38. \lim_{n \rightarrow \infty} \frac{1}{(0.9)^n} = \lim_{n \rightarrow \infty} \left(\frac{10}{9}\right)^n = \infty \Rightarrow \text{diverges}$$

$$39. \lim_{n \rightarrow \infty} \sin\left(\frac{\pi}{2} + \frac{1}{n}\right) = \sin\left(\lim_{n \rightarrow \infty} \left(\frac{\pi}{2} + \frac{1}{n}\right)\right) = \sin \frac{\pi}{2} = 1 \Rightarrow \text{converges}$$

$$40. \lim_{n \rightarrow \infty} n\pi \cos(n\pi) = \lim_{n \rightarrow \infty} (n\pi)(-1)^n \text{ does not exist} \Rightarrow \text{diverges}$$

$$41. \lim_{n \rightarrow \infty} \frac{\sin n}{n} = 0 \text{ because } -\frac{1}{n} \leq \frac{\sin n}{n} \leq \frac{1}{n} \Rightarrow \text{converges by the Sandwich Theorem for sequences}$$

$$42. \lim_{n \rightarrow \infty} \frac{\sin^2 n}{2^n} = 0 \text{ because } 0 \leq \frac{\sin^2 n}{2^n} \leq \frac{1}{2^n} \Rightarrow \text{converges by the Sandwich Theorem for sequences}$$

$$43. \lim_{n \rightarrow \infty} \frac{n}{2^n} = \lim_{n \rightarrow \infty} \frac{1}{2^n \ln 2} = 0 \Rightarrow \text{converges (using l'Hôpital's rule)}$$

$$44. \lim_{n \rightarrow \infty} \frac{3^n}{n^3} = \lim_{n \rightarrow \infty} \frac{3^n \ln 3}{3n^2} = \lim_{n \rightarrow \infty} \frac{3^n (\ln 3)^2}{6n} = \lim_{n \rightarrow \infty} \frac{3^n (\ln 3)^3}{6} = \infty \Rightarrow \text{diverges (using l'Hôpital's rule)}$$

$$45. \lim_{n \rightarrow \infty} \frac{\ln(n+1)}{\sqrt{n}} = \lim_{n \rightarrow \infty} \frac{\left(\frac{1}{n+1}\right)}{\left(\frac{1}{2\sqrt{n}}\right)} = \lim_{n \rightarrow \infty} \frac{2\sqrt{n}}{n+1} = \lim_{n \rightarrow \infty} \frac{\left(\frac{2}{\sqrt{n}}\right)}{1+\left(\frac{1}{n}\right)} = 0 \Rightarrow \text{converges}$$

46. $\lim_{n \rightarrow \infty} \frac{\ln n}{\ln 2n} = \lim_{n \rightarrow \infty} \frac{(\frac{1}{2})}{(\frac{2}{n})} = 1 \Rightarrow$ converges
47. $\lim_{n \rightarrow \infty} 8^{1/n} = 1 \Rightarrow$ converges (Theorem 5, #3)
48. $\lim_{n \rightarrow \infty} (0.03)^{1/n} = 1 \Rightarrow$ converges (Theorem 5, #3)
49. $\lim_{n \rightarrow \infty} \left(1 + \frac{7}{n}\right)^n = e^7 \Rightarrow$ converges (Theorem 5, #5)
50. $\lim_{n \rightarrow \infty} \left(1 - \frac{1}{n}\right)^n = \lim_{n \rightarrow \infty} \left[1 + \frac{(-1)}{n}\right]^n = e^{-1} \Rightarrow$ converges (Theorem 5, #5)
51. $\lim_{n \rightarrow \infty} \sqrt[n]{10n} = \lim_{n \rightarrow \infty} 10^{1/n} \cdot n^{1/n} = 1 \cdot 1 = 1 \Rightarrow$ converges (Theorem 5, #3 and #2)
52. $\lim_{n \rightarrow \infty} \sqrt[n]{n^2} = \lim_{n \rightarrow \infty} (\sqrt[n]{n})^2 = 1^2 = 1 \Rightarrow$ converges (Theorem 5, #2)
53. $\lim_{n \rightarrow \infty} \left(\frac{3}{n}\right)^{1/n} = \frac{\lim_{n \rightarrow \infty} 3^{1/n}}{\lim_{n \rightarrow \infty} n^{1/n}} = \frac{1}{1} = 1 \Rightarrow$ converges (Theorem 5, #3 and #2)
54. $\lim_{n \rightarrow \infty} (n+4)^{1/(n+4)} = \lim_{x \rightarrow \infty} x^{1/x} = 1 \Rightarrow$ converges; (let $x = n+4$, then use Theorem 5, #2)
55. $\lim_{n \rightarrow \infty} \frac{\ln n}{n^{1/n}} = \frac{\lim_{n \rightarrow \infty} \ln n}{\lim_{n \rightarrow \infty} n^{1/n}} = \frac{\infty}{1} = \infty \Rightarrow$ diverges (Theorem 5, #2)
56. $\lim_{n \rightarrow \infty} [\ln n - \ln(n+1)] = \lim_{n \rightarrow \infty} \ln\left(\frac{n}{n+1}\right) = \ln\left(\lim_{n \rightarrow \infty} \frac{n}{n+1}\right) = \ln 1 = 0 \Rightarrow$ converges
57. $\lim_{n \rightarrow \infty} \sqrt[n]{4^n n} = \lim_{n \rightarrow \infty} 4 \sqrt[n]{n} = 4 \cdot 1 = 4 \Rightarrow$ converges (Theorem 5, #2)
58. $\lim_{n \rightarrow \infty} \sqrt[n]{3^{2n+1}} = \lim_{n \rightarrow \infty} 3^{2+(1/n)} = \lim_{n \rightarrow \infty} 3^2 \cdot 3^{1/n} = 9 \cdot 1 = 9 \Rightarrow$ converges (Theorem 5, #3)
59. $\lim_{n \rightarrow \infty} \frac{n!}{n^n} = \lim_{n \rightarrow \infty} \frac{1 \cdot 2 \cdot 3 \cdots (n-1)(n)}{n \cdot n \cdot n \cdots n} \leq \lim_{n \rightarrow \infty} \left(\frac{1}{n}\right) = 0$ and $\frac{n!}{n^n} \geq 0 \Rightarrow \lim_{n \rightarrow \infty} \frac{n!}{n^n} = 0 \Rightarrow$ converges
60. $\lim_{n \rightarrow \infty} \frac{(-4)^n}{n!} = 0 \Rightarrow$ converges (Theorem 5, #6)
61. $\lim_{n \rightarrow \infty} \frac{n!}{10^{6n}} = \lim_{n \rightarrow \infty} \frac{1}{\left(\frac{10^6}{n!}\right)} = \infty \Rightarrow$ diverges (Theorem 5, #6)
62. $\lim_{n \rightarrow \infty} \frac{n!}{2^n 3^n} = \lim_{n \rightarrow \infty} \frac{1}{\left(\frac{6^n}{n!}\right)} = \infty \Rightarrow$ diverges (Theorem 5, #6)
63. $\lim_{n \rightarrow \infty} \left(\frac{1}{n}\right)^{1/(\ln n)} = \lim_{n \rightarrow \infty} \exp\left(\frac{1}{\ln n} \ln\left(\frac{1}{n}\right)\right) = \lim_{n \rightarrow \infty} \exp\left(\frac{\ln 1 - \ln n}{\ln n}\right) = e^{-1} \Rightarrow$ converges
64. $\lim_{n \rightarrow \infty} \ln\left(1 + \frac{1}{n}\right)^n = \ln\left(\lim_{n \rightarrow \infty} \left(1 + \frac{1}{n}\right)^n\right) = \ln e = 1 \Rightarrow$ converges (Theorem 5, #5)
65. $\lim_{n \rightarrow \infty} \left(\frac{3n+1}{3n-1}\right)^n = \lim_{n \rightarrow \infty} \exp\left(n \ln\left(\frac{3n+1}{3n-1}\right)\right) = \lim_{n \rightarrow \infty} \exp\left(\frac{\ln(3n+1) - \ln(3n-1)}{\frac{1}{n}}\right)$

$$= \lim_{n \rightarrow \infty} \exp \left(\frac{\frac{3}{3n+1} - \frac{3}{3n-1}}{\left(-\frac{1}{n^2}\right)} \right) = \lim_{n \rightarrow \infty} \exp \left(\frac{6n^2}{(3n+1)(3n-1)} \right) = \exp \left(\frac{6}{9} \right) = e^{2/3} \Rightarrow \text{converges}$$

$$66. \lim_{n \rightarrow \infty} \left(\frac{n}{n+1} \right)^n = \lim_{n \rightarrow \infty} \exp \left(n \ln \left(\frac{n}{n+1} \right) \right) = \lim_{n \rightarrow \infty} \exp \left(\frac{\ln n - \ln(n+1)}{\left(\frac{1}{n}\right)} \right) = \lim_{n \rightarrow \infty} \exp \left(\frac{\frac{1}{n} - \frac{1}{n+1}}{\left(-\frac{1}{n^2}\right)} \right) \\ = \lim_{n \rightarrow \infty} \exp \left(-\frac{n^2}{n(n+1)} \right) = e^{-1} \Rightarrow \text{converges}$$

$$67. \lim_{n \rightarrow \infty} \left(\frac{x^n}{2n+1} \right)^{1/n} = \lim_{n \rightarrow \infty} x \left(\frac{1}{2n+1} \right)^{1/n} = x \lim_{n \rightarrow \infty} \exp \left(\frac{1}{n} \ln \left(\frac{1}{2n+1} \right) \right) = x \lim_{n \rightarrow \infty} \exp \left(\frac{-\ln(2n+1)}{n} \right) \\ = x \lim_{n \rightarrow \infty} \exp \left(\frac{-2}{2n+1} \right) = xe^0 = x, x > 0 \Rightarrow \text{converges}$$

$$68. \lim_{n \rightarrow \infty} \left(1 - \frac{1}{n^2} \right)^n = \lim_{n \rightarrow \infty} \exp \left(n \ln \left(1 - \frac{1}{n^2} \right) \right) = \lim_{n \rightarrow \infty} \exp \left(\frac{\ln \left(1 - \frac{1}{n^2} \right)}{\left(\frac{1}{n}\right)} \right) = \lim_{n \rightarrow \infty} \exp \left[\frac{\left(\frac{2}{n^3}\right) / \left(1 - \frac{1}{n^2}\right)}{\left(-\frac{1}{n^2}\right)} \right] \\ = \lim_{n \rightarrow \infty} \exp \left(\frac{-2n}{n^2-1} \right) = e^0 = 1 \Rightarrow \text{converges}$$

$$69. \lim_{n \rightarrow \infty} \frac{3^n \cdot 6^n}{2^{n \cdot n} \cdot n!} = \lim_{n \rightarrow \infty} \frac{36^n}{n!} = 0 \Rightarrow \text{converges} \quad (\text{Theorem 5, \#6})$$

$$70. \lim_{n \rightarrow \infty} \frac{\left(\frac{10}{11}\right)^n}{\left(\frac{9}{10}\right)^n + \left(\frac{11}{12}\right)^n} = \lim_{n \rightarrow \infty} \frac{\left(\frac{12}{11}\right)^n \left(\frac{10}{11}\right)^n}{\left(\frac{12}{11}\right)^n \left(\frac{9}{10}\right)^n + \left(\frac{12}{11}\right)^n \left(\frac{11}{12}\right)^n} = \lim_{n \rightarrow \infty} \frac{\left(\frac{120}{121}\right)^n}{\left(\frac{108}{110}\right)^n + 1} = 0 \Rightarrow \text{converges} \\ (\text{Theorem 5, \#4})$$

$$71. \lim_{n \rightarrow \infty} \tanh n = \lim_{n \rightarrow \infty} \frac{e^n - e^{-n}}{e^n + e^{-n}} = \lim_{n \rightarrow \infty} \frac{e^{2n} - 1}{e^{2n} + 1} = \lim_{n \rightarrow \infty} \frac{2e^{2n}}{2e^{2n}} = \lim_{n \rightarrow \infty} 1 = 1 \Rightarrow \text{converges}$$

$$72. \lim_{n \rightarrow \infty} \sinh(\ln n) = \lim_{n \rightarrow \infty} \frac{e^{\ln n} - e^{-\ln n}}{2} = \lim_{n \rightarrow \infty} \frac{n - \frac{1}{n}}{2} = \infty \Rightarrow \text{diverges}$$

$$73. \lim_{n \rightarrow \infty} \frac{n^2 \sin \left(\frac{1}{n}\right)}{2n-1} = \lim_{n \rightarrow \infty} \frac{\sin \left(\frac{1}{n}\right)}{\left(\frac{2}{n} - \frac{1}{n^2}\right)} = \lim_{n \rightarrow \infty} \frac{-\left(\cos \left(\frac{1}{n}\right)\right) \left(\frac{1}{n^2}\right)}{\left(-\frac{2}{n^2} + \frac{2}{n^3}\right)} = \lim_{n \rightarrow \infty} \frac{-\cos \left(\frac{1}{n}\right)}{-2 + \left(\frac{2}{n}\right)} = \frac{1}{2} \Rightarrow \text{converges}$$

$$74. \lim_{n \rightarrow \infty} n \left(1 - \cos \frac{1}{n} \right) = \lim_{n \rightarrow \infty} \frac{\left(1 - \cos \frac{1}{n}\right)}{\left(\frac{1}{n}\right)} = \lim_{n \rightarrow \infty} \frac{\left[\sin \left(\frac{1}{n}\right)\right] \left(\frac{1}{n^2}\right)}{\left(\frac{1}{n^2}\right)} = \lim_{n \rightarrow \infty} \sin \left(\frac{1}{n}\right) = 0 \Rightarrow \text{converges}$$

$$75. \lim_{n \rightarrow \infty} \tan^{-1} n = \frac{\pi}{2} \Rightarrow \text{converges}$$

$$76. \lim_{n \rightarrow \infty} \frac{1}{\sqrt{n}} \tan^{-1} n = 0 \cdot \frac{\pi}{2} = 0 \Rightarrow \text{converges}$$

$$77. \lim_{n \rightarrow \infty} \left(\frac{1}{3}\right)^n + \frac{1}{\sqrt{2^n}} = \lim_{n \rightarrow \infty} \left(\left(\frac{1}{3}\right)^n + \left(\frac{1}{\sqrt{2}}\right)^n \right) = 0 \Rightarrow \text{converges} \quad (\text{Theorem 5, \#4})$$

$$78. \lim_{n \rightarrow \infty} \sqrt[n]{n^2 + n} = \lim_{n \rightarrow \infty} \exp \left[\frac{\ln(n^2 + n)}{n} \right] = \lim_{n \rightarrow \infty} \exp \left(\frac{2n+1}{n^2+n} \right) = e^0 = 1 \Rightarrow \text{converges}$$

$$79. \lim_{n \rightarrow \infty} \frac{(\ln n)^{200}}{n} = \lim_{n \rightarrow \infty} \frac{200(\ln n)^{199}}{n} = \lim_{n \rightarrow \infty} \frac{200 \cdot 199 (\ln n)^{198}}{n} = \dots = \lim_{n \rightarrow \infty} \frac{200!}{n} = 0 \Rightarrow \text{converges}$$

$$80. \lim_{n \rightarrow \infty} \frac{(\ln n)^5}{\sqrt{n}} = \lim_{n \rightarrow \infty} \left[\frac{\left(\frac{5(\ln n)^4}{n}\right)}{\left(\frac{1}{2\sqrt{n}}\right)} \right] = \lim_{n \rightarrow \infty} \frac{10(\ln n)^4}{\sqrt{n}} = \lim_{n \rightarrow \infty} \frac{80(\ln n)^3}{\sqrt{n}} = \dots = \lim_{n \rightarrow \infty} \frac{3840}{\sqrt{n}} = 0 \Rightarrow \text{converges}$$

$$81. \lim_{n \rightarrow \infty} \left(n - \sqrt{n^2 - n} \right) = \lim_{n \rightarrow \infty} \left(n - \sqrt{n^2 - n} \right) \left(\frac{n + \sqrt{n^2 - n}}{n + \sqrt{n^2 - n}} \right) = \lim_{n \rightarrow \infty} \frac{n}{n + \sqrt{n^2 - n}} = \lim_{n \rightarrow \infty} \frac{1}{1 + \sqrt{1 - \frac{1}{n}}} = \frac{1}{2} \Rightarrow \text{converges}$$

$$82. \lim_{n \rightarrow \infty} \frac{1}{\sqrt{n^2 - 1} - \sqrt{n^2 + n}} = \lim_{n \rightarrow \infty} \left(\frac{1}{\sqrt{n^2 - 1} - \sqrt{n^2 + n}} \right) \left(\frac{\sqrt{n^2 - 1} + \sqrt{n^2 + n}}{\sqrt{n^2 - 1} + \sqrt{n^2 + n}} \right) = \lim_{n \rightarrow \infty} \frac{\sqrt{n^2 - 1} + \sqrt{n^2 + n}}{-1 - n} = \lim_{n \rightarrow \infty} \frac{\sqrt{1 - \frac{1}{n^2}} + \sqrt{1 + \frac{1}{n}}}{(-\frac{1}{n} - 1)} = -2 \Rightarrow \text{converges}$$

$$83. \lim_{n \rightarrow \infty} \frac{1}{n} \int_1^n \frac{1}{x} dx = \lim_{n \rightarrow \infty} \frac{\ln n}{n} = \lim_{n \rightarrow \infty} \frac{1}{n} = 0 \Rightarrow \text{converges} \quad (\text{Theorem 5, \#1})$$

$$84. \lim_{n \rightarrow \infty} \int_1^n \frac{1}{x^p} dx = \lim_{n \rightarrow \infty} \left[\frac{1}{1-p} \frac{1}{x^{p-1}} \right]_1^n = \lim_{n \rightarrow \infty} \frac{1}{1-p} \left(\frac{1}{n^{p-1}} - 1 \right) = \frac{1}{p-1} \text{ if } p > 1 \Rightarrow \text{converges}$$

$$85. 1, 1, 2, 4, 8, 16, 32, \dots = 1, 2^0, 2^1, 2^2, 2^3, 2^4, 2^5, \dots \Rightarrow x_1 = 1 \text{ and } x_n = 2^{n-2} \text{ for } n \geq 2$$

$$86. (a) 1^2 - 2(1)^2 = -1, 3^2 - 2(2)^2 = 1; \text{ let } f(a, b) = (a + 2b)^2 - 2(a + b)^2 = a^2 + 4ab + 4b^2 - 2a^2 - 4ab - 2b^2 = 2b^2 - a^2; a^2 - 2b^2 = -1 \Rightarrow f(a, b) = 2b^2 - a^2 = 1; a^2 - 2b^2 = 1 \Rightarrow f(a, b) = 2b^2 - a^2 = -1$$

$$(b) r_n^2 - 2 = \left(\frac{a+2b}{a+b} \right)^2 - 2 = \frac{a^2 + 4ab + 4b^2 - 2a^2 - 4ab - 2b^2}{(a+b)^2} = \frac{-(a^2 - 2b^2)}{(a+b)^2} = \frac{\pm 1}{y_n^2} \Rightarrow r_n = \sqrt{2 \pm \left(\frac{1}{y_n} \right)^2}$$

In the first and second fractions, $y_n \geq n$. Let $\frac{a}{b}$ represent the $(n-1)$ th fraction where $\frac{a}{b} \geq 1$ and $b \geq n-1$ for n a positive integer ≥ 3 . Now the n th fraction is $\frac{a+2b}{a+b}$ and $a+b \geq 2b \geq 2n-2 \geq n \Rightarrow y_n \geq n$. Thus,

$$\lim_{n \rightarrow \infty} r_n = \sqrt{2}.$$

$$87. (a) f(x) = x^2 - 2; \text{ the sequence converges to } 1.414213562 \approx \sqrt{2}$$

$$(b) f(x) = \tan(x) - 1; \text{ the sequence converges to } 0.7853981635 \approx \frac{\pi}{4}$$

$$(c) f(x) = e^x; \text{ the sequence } 1, 0, -1, -2, -3, -4, -5, \dots \text{ diverges}$$

$$88. (a) \lim_{n \rightarrow \infty} n f\left(\frac{1}{n}\right) = \lim_{\Delta x \rightarrow 0^+} \frac{f(\Delta x)}{\Delta x} = \lim_{\Delta x \rightarrow 0^+} \frac{f(0+\Delta x) - f(0)}{\Delta x} = f'(0), \text{ where } \Delta x = \frac{1}{n}$$

$$(b) \lim_{n \rightarrow \infty} n \tan^{-1}\left(\frac{1}{n}\right) = f'(0) = \frac{1}{1+0^2} = 1, f(x) = \tan^{-1} x$$

$$(c) \lim_{n \rightarrow \infty} n(e^{1/n} - 1) = f'(0) = e^0 = 1, f(x) = e^x - 1$$

$$(d) \lim_{n \rightarrow \infty} n \ln\left(1 + \frac{2}{n}\right) = f'(0) = \frac{2}{1+2(0)} = 2, f(x) = \ln(1 + 2x)$$

$$89. (a) \text{ If } a = 2n + 1, \text{ then } b = \lfloor \frac{a^2}{2} \rfloor = \lfloor \frac{4n^2 + 4n + 1}{2} \rfloor = \lfloor 2n^2 + 2n + \frac{1}{2} \rfloor = 2n^2 + 2n, c = \lceil \frac{a^2}{2} \rceil = \lceil 2n^2 + 2n + \frac{1}{2} \rceil = 2n^2 + 2n + 1 \text{ and } a^2 + b^2 = (2n + 1)^2 + (2n^2 + 2n)^2 = 4n^2 + 4n + 1 + 4n^4 + 8n^3 + 4n^2 = 4n^4 + 8n^3 + 8n^2 + 4n + 1 = (2n^2 + 2n + 1)^2 = c^2.$$

$$(b) \lim_{a \rightarrow \infty} \frac{\lfloor \frac{a^2}{2} \rfloor}{\lceil \frac{a^2}{2} \rceil} = \lim_{a \rightarrow \infty} \frac{2n^2 + 2n}{2n^2 + 2n + 1} = 1 \text{ or } \lim_{a \rightarrow \infty} \frac{\lfloor \frac{a^2}{2} \rfloor}{\lceil \frac{a^2}{2} \rceil} = \lim_{a \rightarrow \infty} \sin \theta = \lim_{\theta \rightarrow \pi/2} \sin \theta = 1$$

$$90. (a) \lim_{n \rightarrow \infty} (2n\pi)^{1/(2n)} = \lim_{n \rightarrow \infty} \exp\left(\frac{\ln 2n\pi}{2n}\right) = \lim_{n \rightarrow \infty} \exp\left(\frac{\left(\frac{2\pi}{2n}\right)}{2}\right) = \lim_{n \rightarrow \infty} \exp\left(\frac{1}{2n}\right) = e^0 = 1;$$

$n! \approx \left(\frac{n}{e}\right)^n \sqrt{2n\pi}$, Stirlings approximation $\Rightarrow \sqrt[n]{n!} \approx \left(\frac{n}{e}\right) (2n\pi)^{1/(2n)} \approx \frac{n}{e}$ for large values of n

(b)

n	$\sqrt[n]{n!}$	$\frac{n}{e}$
40	15.76852702	14.71517765
50	19.48325423	18.39397206
60	23.19189561	22.07276647

91. (a) $\lim_{n \rightarrow \infty} \frac{\ln n}{n^c} = \lim_{n \rightarrow \infty} \frac{(\frac{1}{n})}{cn^{c-1}} = \lim_{n \rightarrow \infty} \frac{1}{cn^c} = 0$
 (b) For all $\epsilon > 0$, there exists an $N = e^{-(\ln \epsilon)/c}$ such that $n > e^{-(\ln \epsilon)/c} \Rightarrow \ln n > -\frac{\ln \epsilon}{c} \Rightarrow \ln n^c > \ln \left(\frac{1}{\epsilon}\right) \Rightarrow n^c > \frac{1}{\epsilon} \Rightarrow \frac{1}{n^c} < \epsilon \Rightarrow \left|\frac{1}{n^c} - 0\right| < \epsilon \Rightarrow \lim_{n \rightarrow \infty} \frac{1}{n^c} = 0$
92. Let $\{a_n\}$ and $\{b_n\}$ be sequences both converging to L . Define $\{c_n\}$ by $c_{2n} = b_n$ and $c_{2n-1} = a_n$, where $n = 1, 2, 3, \dots$. For all $\epsilon > 0$ there exists N_1 such that when $n > N_1$ then $|a_n - L| < \epsilon$ and there exists N_2 such that when $n > N_2$ then $|b_n - L| < \epsilon$. If $n > 1 + 2\max\{N_1, N_2\}$, then $|c_n - L| < \epsilon$, so $\{c_n\}$ converges to L .
93. $\lim_{n \rightarrow \infty} n^{1/n} = \lim_{n \rightarrow \infty} \exp\left(\frac{1}{n} \ln n\right) = \lim_{n \rightarrow \infty} \exp\left(\frac{1}{n}\right) = e^0 = 1$
94. $\lim_{n \rightarrow \infty} x^{1/n} = \lim_{n \rightarrow \infty} \exp\left(\frac{1}{n} \ln x\right) = e^0 = 1$, because x remains fixed while n gets large
95. Assume the hypotheses of the theorem and let ϵ be a positive number. For all ϵ there exists a N_1 such that when $n > N_1$ then $|a_n - L| < \epsilon \Rightarrow -\epsilon < a_n - L < \epsilon \Rightarrow L - \epsilon < a_n$, and there exists a N_2 such that when $n > N_2$ then $|c_n - L| < \epsilon \Rightarrow -\epsilon < c_n - L < \epsilon \Rightarrow c_n < L + \epsilon$. If $n > \max\{N_1, N_2\}$, then $L - \epsilon < a_n \leq b_n \leq c_n < L + \epsilon \Rightarrow |b_n - L| < \epsilon \Rightarrow \lim_{n \rightarrow \infty} b_n = L$.
96. Let $\epsilon > 0$. We have f continuous at $L \Rightarrow$ there exists δ so that $|x - L| < \delta \Rightarrow |f(x) - f(L)| < \epsilon$. Also, $a_n \rightarrow L \Rightarrow$ there exists N so that for $n > N$ $|a_n - L| < \delta$. Thus for $n > N$, $|f(a_n) - f(L)| < \epsilon \Rightarrow f(a_n) \rightarrow f(L)$.
97. $a_{n+1} \geq a_n \Rightarrow \frac{3(n+1)+1}{(n+1)+1} > \frac{3n+1}{n+1} \Rightarrow \frac{3n+4}{n+2} > \frac{3n+1}{n+1} \Rightarrow 3n^2 + 3n + 4n + 4 > 3n^2 + 6n + n + 2 \Rightarrow 4 > 2$; the steps are reversible so the sequence is nondecreasing; $\frac{3n+1}{n+1} < 3 \Rightarrow 3n + 1 < 3n + 3 \Rightarrow 1 < 3$; the steps are reversible so the sequence is bounded above by 3
98. $a_{n+1} \geq a_n \Rightarrow \frac{(2(n+1)+3)!}{((n+1)+1)!} > \frac{(2n+3)!}{(n+1)!} \Rightarrow \frac{(2n+5)!}{(n+2)!} > \frac{(2n+3)!}{(n+1)!} \Rightarrow \frac{(2n+5)!}{(2n+3)!} > \frac{(n+2)!}{(n+1)!} \Rightarrow (2n+5)(2n+4) > n+2$; the steps are reversible so the sequence is nondecreasing; the sequence is not bounded since $\frac{(2n+3)!}{(n+1)!} = (2n+3)(2n+2)\cdots(n+2)$ can become as large as we please
99. $a_{n+1} \leq a_n \Rightarrow \frac{2^{n+1}3^{n+1}}{(n+1)!} \leq \frac{2^n 3^n}{n!} \Rightarrow \frac{2^{n+1}3^{n+1}}{2^n 3^n} \leq \frac{(n+1)!}{n!} \Rightarrow 2 \cdot 3 \leq n+1$ which is true for $n \geq 5$; the steps are reversible so the sequence is decreasing after a_5 , but it is not nondecreasing for all its terms; $a_1 = 6$, $a_2 = 18$, $a_3 = 36$, $a_4 = 54$, $a_5 = \frac{324}{5} = 64.8 \Rightarrow$ the sequence is bounded from above by 64.8
100. $a_{n+1} \geq a_n \Rightarrow 2 - \frac{2}{n+1} - \frac{1}{2^{n+1}} \geq 2 - \frac{2}{n} - \frac{1}{2^n} \Rightarrow \frac{2}{n} - \frac{2}{n+1} \geq \frac{1}{2^{n+1}} - \frac{1}{2^n} \Rightarrow \frac{2}{n(n+1)} \geq -\frac{1}{2^{n+1}}$; the steps are reversible so the sequence is nondecreasing; $2 - \frac{2}{n} - \frac{1}{2^n} \leq 2 \Rightarrow$ the sequence is bounded from above
101. $a_n = 1 - \frac{1}{n}$ converges because $\frac{1}{n} \rightarrow 0$ by Example 1; also it is a nondecreasing sequence bounded above by 1
102. $a_n = n - \frac{1}{n}$ diverges because $n \rightarrow \infty$ and $\frac{1}{n} \rightarrow 0$ by Example 1, so the sequence is unbounded
103. $a_n = \frac{2^n - 1}{2^n} = 1 - \frac{1}{2^n}$ and $0 < \frac{1}{2^n} < \frac{1}{n}$; since $\frac{1}{n} \rightarrow 0$ (by Example 1) $\Rightarrow \frac{1}{2^n} \rightarrow 0$, the sequence converges; also it is a nondecreasing sequence bounded above by 1
104. $a_n = \frac{2^n - 1}{3^n} = \left(\frac{2}{3}\right)^n - \frac{1}{3^n}$; the sequence converges to 0 by Theorem 5, #4

105. $a_n = ((-1)^n + 1) \left(\frac{n+1}{n}\right)$ diverges because $a_n = 0$ for n odd, while for n even $a_n = 2 \left(1 + \frac{1}{n}\right)$ converges to 2; it diverges by definition of divergence
106. $x_n = \max \{\cos 1, \cos 2, \cos 3, \dots, \cos n\}$ and $x_{n+1} = \max \{\cos 1, \cos 2, \cos 3, \dots, \cos(n+1)\} \geq x_n$ with $x_n \leq 1$ so the sequence is nondecreasing and bounded above by 1 \Rightarrow the sequence converges.
107. If $\{a_n\}$ is nonincreasing with lower bound M , then $\{-a_n\}$ is a nondecreasing sequence with upper bound $-M$. By Theorem 1, $\{-a_n\}$ converges and hence $\{a_n\}$ converges. If $\{a_n\}$ has no lower bound, then $\{-a_n\}$ has no upper bound and therefore diverges. Hence, $\{a_n\}$ also diverges.
108. $a_n \geq a_{n+1} \Leftrightarrow \frac{n+1}{n} \geq \frac{(n+1)+1}{n+1} \Leftrightarrow n^2 + 2n + 1 \geq n^2 + 2n \Leftrightarrow 1 \geq 0$ and $\frac{n+1}{n} \geq 1$; thus the sequence is nonincreasing and bounded below by 1 \Rightarrow it converges
109. $a_n \geq a_{n+1} \Leftrightarrow \frac{1+\sqrt{2n}}{\sqrt{n}} \geq \frac{1+\sqrt{2(n+1)}}{\sqrt{n+1}} \Leftrightarrow \sqrt{n+1} + \sqrt{2n^2+2n} \geq \sqrt{n} + \sqrt{2n^2+2n} \Leftrightarrow \sqrt{n+1} \geq \sqrt{n}$ and $\frac{1+\sqrt{2n}}{\sqrt{n}} \geq \sqrt{2}$; thus the sequence is nonincreasing and bounded below by $\sqrt{2} \Rightarrow$ it converges
110. $a_n \geq a_{n+1} \Leftrightarrow \frac{1-4^n}{2^n} \geq \frac{1-4^{n+1}}{2^{n+1}} \Leftrightarrow 2^{n+1} - 2^{n+1}4^n \geq 2^n - 2^n4^{n+1} \Leftrightarrow 2^{n+1} - 2^n \geq 2^{n+1}4^n - 2^n4^{n+1}$
 $\Leftrightarrow 2 - 1 \geq 2 \cdot 4^n - 4^{n+1} \Leftrightarrow 1 \geq 4^n(2 - 4) \Leftrightarrow 1 \geq (-2) \cdot 4^n$; thus the sequence is nonincreasing. However, $a_n = \frac{1}{2^n} - \frac{4^n}{2^n} = \frac{1}{2^n} - 2^n$ which is not bounded below so the sequence diverges
111. $\frac{4^{n+1}+3^n}{4^n} = 4 + \left(\frac{3}{4}\right)^n$ so $a_n \geq a_{n+1} \Leftrightarrow 4 + \left(\frac{3}{4}\right)^n \geq 4 + \left(\frac{3}{4}\right)^{n+1} \Leftrightarrow \left(\frac{3}{4}\right)^n \geq \left(\frac{3}{4}\right)^{n+1} \Leftrightarrow 1 \geq \frac{3}{4}$ and $4 + \left(\frac{3}{4}\right)^n \geq 4$; thus the sequence is nonincreasing and bounded below by 4 \Rightarrow it converges
112. $a_1 = 1, a_2 = 2 - 3, a_3 = 2(2 - 3) - 3 = 2^2 - (2^2 - 1) \cdot 3, a_4 = 2(2^2 - (2^2 - 1) \cdot 3) - 3 = 2^3 - (2^3 - 1) \cdot 3,$
 $a_5 = 2[2^3 - (2^3 - 1) \cdot 3] - 3 = 2^4 - (2^4 - 1) \cdot 3, \dots, a_n = 2^{n-1} - (2^{n-1} - 1) \cdot 3 = 2^{n-1} - 3 \cdot 2^{n-1} + 3$
 $= 2^{n-1}(1 - 3) + 3 = -2^n + 3; a_n \geq a_{n+1} \Leftrightarrow -2^n + 3 \geq -2^{n+1} + 3 \Leftrightarrow -2^n \geq -2^{n+1} \Leftrightarrow 1 \leq 2$
 so the sequence is nonincreasing but not bounded below and therefore diverges
113. Let $0 < M < 1$ and let N be an integer greater than $\frac{M}{1-M}$. Then $n > N \Rightarrow n > \frac{M}{1-M} \Rightarrow n - nM > M$
 $\Rightarrow n > M + nM \Rightarrow n > M(n+1) \Rightarrow \frac{n}{n+1} > M$.
114. Since M_1 is a least upper bound and M_2 is an upper bound, $M_1 \leq M_2$. Since M_2 is a least upper bound and M_1 is an upper bound, $M_2 \leq M_1$. We conclude that $M_1 = M_2$ so the least upper bound is unique.
115. The sequence $a_n = 1 + \frac{(-1)^n}{2}$ is the sequence $\frac{1}{2}, \frac{3}{2}, \frac{1}{2}, \frac{3}{2}, \dots$. This sequence is bounded above by $\frac{3}{2}$, but it clearly does not converge, by definition of convergence.
116. Let L be the limit of the convergent sequence $\{a_n\}$. Then by definition of convergence, for $\frac{\epsilon}{2}$ there corresponds an N such that for all m and $n, m > N \Rightarrow |a_m - L| < \frac{\epsilon}{2}$ and $n > N \Rightarrow |a_n - L| < \frac{\epsilon}{2}$. Now $|a_m - a_n| = |a_m - L + L - a_n| \leq |a_m - L| + |L - a_n| < \frac{\epsilon}{2} + \frac{\epsilon}{2} = \epsilon$ whenever $m > N$ and $n > N$.
117. Given an $\epsilon > 0$, by definition of convergence there corresponds an N such that for all $n > N$, $|L_1 - a_n| < \epsilon$ and $|L_2 - a_n| < \epsilon$. Now $|L_2 - L_1| = |L_2 - a_n + a_n - L_1| \leq |L_2 - a_n| + |a_n - L_1| < \epsilon + \epsilon = 2\epsilon$. $|L_2 - L_1| < 2\epsilon$ says that the difference between two fixed values is smaller than any positive number 2ϵ . The only nonnegative number smaller than every positive number is 0, so $|L_1 - L_2| = 0$ or $L_1 = L_2$.

118. Let $k(n)$ and $i(n)$ be two order-preserving functions whose domains are the set of positive integers and whose ranges are a subset of the positive integers. Consider the two subsequences $a_{k(n)}$ and $a_{i(n)}$, where $a_{k(n)} \rightarrow L_1$, $a_{i(n)} \rightarrow L_2$ and $L_1 \neq L_2$. Thus $|a_{k(n)} - a_{i(n)}| \rightarrow |L_1 - L_2| > 0$. So there does not exist N such that for all $m, n > N \Rightarrow |a_m - a_n| < \epsilon$. So by Exercise 116, the sequence $\{a_n\}$ is not convergent and hence diverges.
119. $a_{2k} \rightarrow L \Leftrightarrow$ given an $\epsilon > 0$ there corresponds an N_1 such that $[2k > N_1 \Rightarrow |a_{2k} - L| < \epsilon]$. Similarly, $a_{2k+1} \rightarrow L \Leftrightarrow [2k + 1 > N_2 \Rightarrow |a_{2k+1} - L| < \epsilon]$. Let $N = \max\{N_1, N_2\}$. Then $n > N \Rightarrow |a_n - L| < \epsilon$ whether n is even or odd, and hence $a_n \rightarrow L$.
120. Assume $a_n \rightarrow 0$. This implies that given an $\epsilon > 0$ there corresponds an N such that $n > N \Rightarrow |a_n - 0| < \epsilon \Rightarrow |a_n| < \epsilon \Rightarrow ||a_n|| < \epsilon \Rightarrow ||a_n| - 0| < \epsilon \Rightarrow |a_n| \rightarrow 0$. On the other hand, assume $|a_n| \rightarrow 0$. This implies that given an $\epsilon > 0$ there corresponds an N such that for $n > N$, $||a_n| - 0| < \epsilon \Rightarrow ||a_n|| < \epsilon \Rightarrow |a_n| < \epsilon \Rightarrow |a_n - 0| < \epsilon \Rightarrow a_n \rightarrow 0$.
121. $|\sqrt[n]{0.5} - 1| < 10^{-3} \Rightarrow -\frac{1}{1000} < \left(\frac{1}{2}\right)^{1/n} - 1 < \frac{1}{1000} \Rightarrow \left(\frac{999}{1000}\right)^n < \frac{1}{2} < \left(\frac{1001}{1000}\right)^n \Rightarrow n > \frac{\ln(\frac{1}{2})}{\ln(\frac{999}{1000})} \Rightarrow n > 692.8 \Rightarrow N = 692; a_n = \left(\frac{1}{2}\right)^{1/n}$ and $\lim_{n \rightarrow \infty} a_n = 1$
122. $|\sqrt[n]{n} - 1| < 10^{-3} \Rightarrow -\frac{1}{1000} < n^{1/n} - 1 < \frac{1}{1000} \Rightarrow \left(\frac{999}{1000}\right)^n < n < \left(\frac{1001}{1000}\right)^n \Rightarrow n > 9123 \Rightarrow N = 9123; a_n = \sqrt[n]{n} = n^{1/n}$ and $\lim_{n \rightarrow \infty} a_n = 1$
123. $(0.9)^n < 10^{-3} \Rightarrow n \ln(0.9) < -3 \ln 10 \Rightarrow n > \frac{-3 \ln 10}{\ln(0.9)} \approx 65.54 \Rightarrow N = 65; a_n = \left(\frac{9}{10}\right)^n$ and $\lim_{n \rightarrow \infty} a_n = 0$
124. $\frac{2^n}{n!} < 10^{-7} \Rightarrow n! > 2^n 10^7$ and by calculator experimentation, $n > 14 \Rightarrow N = 14; a_n = \frac{2^n}{n!}$ and $\lim_{n \rightarrow \infty} a_n = 0$
125. (a) $f(x) = x^2 - a \Rightarrow f'(x) = 2x \Rightarrow x_{n+1} = x_n - \frac{x_n^2 - a}{2x_n} \Rightarrow x_{n+1} = \frac{2x_n^2 - (x_n^2 - a)}{2x_n} = \frac{x_n^2 + a}{2x_n} = \frac{(x_n + \frac{a}{x_n})}{2}$
 (b) $x_1 = 2, x_2 = 1.75, x_3 = 1.732142857, x_4 = 1.73205081, x_5 = 1.732050808$; we are finding the positive number where $x^2 - 3 = 0$; that is, where $x^2 = 3, x > 0$, or where $x = \sqrt{3}$.
126. $x_1 = 1.5, x_2 = 1.416666667, x_3 = 1.414215686, x_4 = 1.414213562, x_5 = 1.414213562$; we are finding the positive number $x^2 - 2 = 0$; that is, where $x^2 = 2, x > 0$, or where $x = \sqrt{2}$.
127. $x_1 = 1, x_2 = 1 + \cos(1) = 1.540302306, x_3 = 1.540302306 + \cos(1 + \cos(1)) = 1.570791601, x_4 = 1.570791601 + \cos(1.570791601) = 1.570796327 = \frac{\pi}{2}$ to 9 decimal places. After a few steps, the arc (x_{n-1}) and line segment $\cos(x_{n-1})$ are nearly the same as the quarter circle.
128. (a) $S_1 = 6.815, S_2 = 6.4061, S_3 = 6.021734, S_4 = 5.66042996, S_5 = 5.320804162, S_6 = 5.001555913, S_7 = 4.701462558, S_8 = 4.419374804, S_9 = 4.154212316, S_{10} = 3.904959577, S_{11} = 3.670662003, S_{12} = 3.450422282$ so it will take Ford about 12 years to catch up
 (b) $x \approx 11.8$

129-140. Example CAS Commands:

Maple:

with(Student[Calculus1]);

f := x -> sin(x);

a := 0;

b := Pi;

```

plot( f(x), x=a..b, title="#23(a) (Section 5.1)" );
N := [ 100, 200, 1000 ]; # (b)
for n in N do
  Xlist := [ a+1.*(b-a)/n*i $ i=0..n ];
  Ylist := map( f, Xlist );
end do;
for n in N do # (c)
  Avg[n] := evalf(add(y,y=Ylist)/nops(Ylist));
end do;
avg := FunctionAverage( f(x), x=a..b, output=value );
evalf( avg );
FunctionAverage(f(x),x=a..b,output=plot); # (d)
fsolve( f(x)=avg, x=0.5 );
fsolve( f(x)=avg, x=2.5 );
fsolve( f(x)=Avg[1000], x=0.5 );
fsolve( f(x)=Avg[1000], x=2.5 );

```

Mathematica: (sequence functions may vary):

```

Clear[a, n]
a[n_]; = n1/n
first25= Table[N[a[n]],{n, 1, 25}]
Limit[a[n], n → 8]

```

The last command (Limit) will not always work in Mathematica. You could also explore the limit by enlarging your table to more than the first 25 values.

If you know the limit (1 in the above example), to determine how far to go to have all further terms within 0.01 of the limit, do the following.

```

Clear[minN, lim]
lim= 1
Do[{diff=Abs[a[n] - lim], If[diff < .01, {minN= n, Abort[]}]}, {n, 2, 1000}]
minN

```

For sequences that are given recursively, the following code is suggested. The portion of the command `a[n_]:=a[n]` stores the elements of the sequence and helps to streamline computation.

```

Clear[a, n]
a[1]= 1;
a[n_]; = a[n]= a[n - 1] + (1/5)(n-1)
first25= Table[N[a[n]], {n, 1, 25}]

```

The limit command does not work in this case, but the limit can be observed as 1.25.

```

Clear[minN, lim]
lim= 1.25
Do[{diff=Abs[a[n] - lim], If[diff < .01, {minN= n, Abort[]}]}, {n, 2, 1000}]
minN

```

141. Example CAS Commands:

Maple:

```

with( Student[Calculus1] );
A := n->(1+r/m)*A(n-1) + b;
A(0) := A0;
A(0) := 1000; r := 0.02015; m := 12; b := 50; # (a)
pts1 := [seq( [n,A(n)], n=0..99 )];
plot( pts1, style=point, title="#141(a) (Section 11.1)");

```

```

A(60);
The sequence { A[n] } is not unbounded;
limit( A[n], n=infinity ) = infinity.
A(0) := 5000; r := 0.0589; m := 12; b := -50;           # (b)
pts1 := [seq( [n,A(n)], n=0..99 )];
plot( pts1, style=point, title="#141(b) (Section 11.1)");
A(60);
pts1 := [seq( [n,A(n)], n=0..199 )];
plot( pts1, style=point, title="#141(b) (Section 11.1)");
# This sequence is not bounded, and diverges to -infinity:
limit( A[n], n=infinity ) = -infinity.
A(0) := 5000; r := 0.045; m := 4; b := 0;             # (c)
for n from 1 while A(n)<20000 do end do; n;

```

It takes 31 years (124 quarters) for the investment to grow to \$20,000 when the interest rate is 4.5%, compounded quarterly.

```

r := 0.0625;
for n from 1 while A(n)<20000 do end do; n;

```

When the interest rate increases to 6.25% (compounded quarterly), it takes only 22.5 years for the balance to reach \$20,000.

```

B := k -> (1+r/m)^k * (A(0)+m*b/r) - m*b/r;           # (d)
A(0) := 1000.; r := 0.02015; m := 12; b := 50;
for k from 0 to 49 do
  printf( "%5d %9.2f %9.2f %9.2fn", k, A(k), B(k), B(k)-A(k) );
end do;
A(0) := 'A(0)'; r := 'r'; m := 'm'; b := 'b'; n := 'n';
eval( AA(n+1) - ((1+r/m)*AA(n) + b), AA=B );
simplify( % );

```

142. Example CAS Commands:

Maple:

```

r := 3/4.;                                           # (a)
for k in $1..9 do
  A := k/10.;
  L := [0,A];
  for n from 1 to 99 do
    A := r*A*(1-A);
    L := L, [n,A];
  end do;
  pt[r,k/10] := [L];
end do;
plot( [seq( pt[r,a], a=[$1..9]/10 )], style=point, title="#142(a) (Section 11.1) );
R1 := [1.1, 1.2, 1.5, 2.5, 2.8, 2.9];              # (b)
for r in R1 do
  for k in $1..9 do
    A := k/10.;
    L := [0,A];
    for n from 1 to 99 do
      A := r*A*(1-A);
      L := L, [n,A];
    end do;
  end do;
end do;

```

```

end do;
pt[r,k/10] := [L];
end do;
t := sprintf("#142(b) (Section 11.1)\nr = %f", r);
P[r] := plot( [seq( pt[r,a], a=[($1..9)/10] ), style=point, title=t );
end do;
display( [seq(P[r], r=R1)], insequence=true );
R2 := [3.05, 3.1, 3.2, 3.3, 3.35, 3.4];          # (c)
for r in R2 do
for k in $1..9 do
A := k/10.;
L := [0,A];
for n from 1 to 99 do
A := r*A*(1-A);
L := L, [n,A];
end do;
pt[r,k/10] := [L];
end do;
t := sprintf("#142(c) (Section 11.1)\nr = %f", r);
P[r] := plot( [seq( pt[r,a], a=[($1..9)/10] ), style=point, title=t );
end do;
display( [seq(P[r], r=R2)], insequence=true );
R3 := [3.46, 3.47, 3.48, 3.49, 3.5, 3.51, 3.52, 3.53, 3.542, 3.544, 3.546, 3.548];    # (d)
for r in R3 do
for k in $1..9 do
A := k/10.;
L := [0,A];
for n from 1 to 199 do
A := r*A*(1-A);
L := L, [n,A];
end do;
pt[r,k/10] := [L];
end do;
t := sprintf("#142(d) (Section 11.1)\nr = %f", r);
P[r] := plot( [seq( pt[r,a], a=[($1..9)/10] ), style=point, title=t );
end do;
display( [seq(P[r], r=R3)], insequence=true );
R4 := [3.5695];          # (e)
for r in R4 do
for k in $1..9 do
A := k/10.;
L := [0,A];
for n from 1 to 299 do
A := r*A*(1-A);
L := L, [n,A];
end do;
pt[r,k/10] := [L];
end do;
t := sprintf("#142(e) (Section 11.1)\nr = %f", r);

```

```

P[r] := plot( [seq( pt[r,a], a=[($1..9)/10] ), style=point, title=t );
end do:
display( [seq(P[r], r=R4)], insequence=true );
R5 := [3.65]; # (f)
for r in R5 do
  for k in $1..9 do
    A := k/10.;
    L := [0,A];
    for n from 1 to 299 do
      A := r*A*(1-A);
      L := L, [n,A];
    end do;
    pt[r,k/10] := [L];
  end do:
  t := sprintf("#142(f) (Section 11.1)\nr = %f", r);
  P[r] := plot( [seq( pt[r,a], a=[($1..9)/10] ), style=point, title=t );
end do:
display( [seq(P[r], r=R5)], insequence=true );
R6 := [3.65, 3.75]; # (g)
for r in R6 do
  for a in [0.300, 0.301, 0.600, 0.601 ] do
    A := a;
    L := [0,a];
    for n from 1 to 299 do
      A := r*A*(1-A);
      L := L, [n,A];
    end do;
    pt[r,a] := [L];
  end do:
  t := sprintf("#142(g) (Section 11.1)\nr = %f", r);
  P[r] := plot( [seq( pt[r,a], a=[0.300, 0.301, 0.600, 0.601 ] ), style=point, title=t );
end do:
display( [seq(P[r], r=R6)], insequence=true );

```

11.2 INFINITE SERIES

$$1. \quad s_n = \frac{a(1-r^n)}{(1-r)} = \frac{2(1-(\frac{1}{3})^n)}{1-(\frac{1}{3})} \Rightarrow \lim_{n \rightarrow \infty} s_n = \frac{2}{1-(\frac{1}{3})} = 3$$

$$2. \quad s_n = \frac{a(1-r^n)}{(1-r)} = \frac{(\frac{9}{100})(1-(\frac{1}{100})^n)}{1-(\frac{1}{100})} \Rightarrow \lim_{n \rightarrow \infty} s_n = \frac{(\frac{9}{100})}{1-(\frac{1}{100})} = \frac{1}{11}$$

$$3. \quad s_n = \frac{a(1-r^n)}{(1-r)} = \frac{1-(-\frac{1}{2})^n}{1-(-\frac{1}{2})} \Rightarrow \lim_{n \rightarrow \infty} s_n = \frac{1}{(\frac{3}{2})} = \frac{2}{3}$$

$$4. \quad s_n = \frac{1-(-2)^n}{1-(-2)}, \text{ a geometric series where } |r| > 1 \Rightarrow \text{divergence}$$

$$5. \quad \frac{1}{(n+1)(n+2)} = \frac{1}{n+1} - \frac{1}{n+2} \Rightarrow s_n = \left(\frac{1}{2} - \frac{1}{3}\right) + \left(\frac{1}{3} - \frac{1}{4}\right) + \dots + \left(\frac{1}{n+1} - \frac{1}{n+2}\right) = \frac{1}{2} - \frac{1}{n+2} \Rightarrow \lim_{n \rightarrow \infty} s_n = \frac{1}{2}$$

$$6. \frac{5}{n(n+1)} = \frac{5}{n} - \frac{5}{n+1} \Rightarrow s_n = \left(5 - \frac{5}{2}\right) + \left(\frac{5}{2} - \frac{5}{3}\right) + \left(\frac{5}{3} - \frac{5}{4}\right) + \dots + \left(\frac{5}{n-1} - \frac{5}{n}\right) + \left(\frac{5}{n} - \frac{5}{n+1}\right) = 5 - \frac{5}{n+1}$$

$$\Rightarrow \lim_{n \rightarrow \infty} s_n = 5$$

$$7. 1 - \frac{1}{4} + \frac{1}{16} - \frac{1}{64} + \dots, \text{ the sum of this geometric series is } \frac{1}{1 - (-\frac{1}{4})} = \frac{1}{1 + (\frac{1}{4})} = \frac{4}{5}$$

$$8. \frac{1}{16} + \frac{1}{64} + \frac{1}{256} + \dots, \text{ the sum of this geometric series is } \frac{(\frac{1}{16})}{1 - (\frac{1}{4})} = \frac{1}{12}$$

$$9. \frac{7}{4} + \frac{7}{16} + \frac{7}{64} + \dots, \text{ the sum of this geometric series is } \frac{(\frac{7}{4})}{1 - (\frac{1}{4})} = \frac{7}{3}$$

$$10. 5 - \frac{5}{4} + \frac{5}{16} - \frac{5}{64} + \dots, \text{ the sum of this geometric series is } \frac{5}{1 - (-\frac{1}{4})} = 4$$

$$11. (5 + 1) + \left(\frac{5}{2} + \frac{1}{3}\right) + \left(\frac{5}{4} + \frac{1}{9}\right) + \left(\frac{5}{8} + \frac{1}{27}\right) + \dots, \text{ is the sum of two geometric series; the sum is}$$

$$\frac{5}{1 - (\frac{1}{2})} + \frac{1}{1 - (\frac{1}{3})} = 10 + \frac{3}{2} = \frac{23}{2}$$

$$12. (5 - 1) + \left(\frac{5}{2} - \frac{1}{3}\right) + \left(\frac{5}{4} - \frac{1}{9}\right) + \left(\frac{5}{8} - \frac{1}{27}\right) + \dots, \text{ is the difference of two geometric series; the sum is}$$

$$\frac{5}{1 - (\frac{1}{2})} - \frac{1}{1 - (\frac{1}{3})} = 10 - \frac{3}{2} = \frac{17}{2}$$

$$13. (1 + 1) + \left(\frac{1}{2} - \frac{1}{5}\right) + \left(\frac{1}{4} + \frac{1}{25}\right) + \left(\frac{1}{8} - \frac{1}{125}\right) + \dots, \text{ is the sum of two geometric series; the sum is}$$

$$\frac{1}{1 - (\frac{1}{2})} + \frac{1}{1 + (\frac{1}{5})} = 2 + \frac{5}{6} = \frac{17}{6}$$

$$14. 2 + \frac{4}{5} + \frac{8}{25} + \frac{16}{125} + \dots = 2 \left(1 + \frac{2}{5} + \frac{4}{25} + \frac{8}{125} + \dots\right); \text{ the sum of this geometric series is } 2 \left(\frac{1}{1 - (\frac{2}{5})}\right) = \frac{10}{3}$$

$$15. \frac{4}{(4n-3)(4n+1)} = \frac{1}{4n-3} - \frac{1}{4n+1} \Rightarrow s_n = \left(1 - \frac{1}{5}\right) + \left(\frac{1}{5} - \frac{1}{9}\right) + \left(\frac{1}{9} - \frac{1}{13}\right) + \dots + \left(\frac{1}{4n-7} - \frac{1}{4n-3}\right)$$

$$+ \left(\frac{1}{4n-3} - \frac{1}{4n+1}\right) = 1 - \frac{1}{4n+1} \Rightarrow \lim_{n \rightarrow \infty} s_n = \lim_{n \rightarrow \infty} \left(1 - \frac{1}{4n+1}\right) = 1$$

$$16. \frac{6}{(2n-1)(2n+1)} = \frac{A}{2n-1} + \frac{B}{2n+1} = \frac{A(2n+1) + B(2n-1)}{(2n-1)(2n+1)} \Rightarrow A(2n+1) + B(2n-1) = 6$$

$$\Rightarrow (2A + 2B)n + (A - B) = 6 \Rightarrow \begin{cases} 2A + 2B = 0 \\ A - B = 6 \end{cases} \Rightarrow \begin{cases} A + B = 0 \\ A - B = 6 \end{cases} \Rightarrow 2A = 6 \Rightarrow A = 3 \text{ and } B = -3. \text{ Hence,}$$

$$\sum_{n=1}^k \frac{6}{(2n-1)(2n+1)} = 3 \sum_{n=1}^k \left(\frac{1}{2n-1} - \frac{1}{2n+1}\right) = 3 \left(\frac{1}{1} - \frac{1}{3} + \frac{1}{3} - \frac{1}{5} + \frac{1}{5} - \frac{1}{7} + \dots - \frac{1}{2(k-1)+1} + \frac{1}{2k-1} - \frac{1}{2k+1}\right)$$

$$= 3 \left(1 - \frac{1}{2k+1}\right) \Rightarrow \text{the sum is } \lim_{k \rightarrow \infty} 3 \left(1 - \frac{1}{2k+1}\right) = 3$$

$$17. \frac{40n}{(2n-1)^2(2n+1)^2} = \frac{A}{(2n-1)} + \frac{B}{(2n-1)^2} + \frac{C}{(2n+1)} + \frac{D}{(2n+1)^2}$$

$$= \frac{A(2n-1)(2n+1)^2 + B(2n+1)^2 + C(2n+1)(2n-1)^2 + D(2n-1)^2}{(2n-1)^2(2n+1)^2}$$

$$\Rightarrow A(2n-1)(2n+1)^2 + B(2n+1)^2 + C(2n+1)(2n-1)^2 + D(2n-1)^2 = 40n$$

$$\Rightarrow A(8n^3 + 4n^2 - 2n - 1) + B(4n^2 + 4n + 1) + C(8n^3 - 4n^2 - 2n + 1) + D(4n^2 - 4n + 1) = 40n$$

$$\Rightarrow (8A + 8C)n^3 + (4A + 4B - 4C + 4D)n^2 + (-2A + 4B - 2C - 4D)n + (-A + B + C + D) = 40n$$

$$\Rightarrow \begin{cases} 8A + 8C = 0 \\ 4A + 4B - 4C + 4D = 0 \\ -2A + 4B - 2C - 4D = 40 \\ -A + B + C + D = 0 \end{cases} \Rightarrow \begin{cases} 8A + 8C = 0 \\ A + B - C + D = 0 \\ -A + 2B - C - 2D = 20 \\ -A + B + C + D = 0 \end{cases} \Rightarrow \begin{cases} B + D = 0 \\ 2B - 2D = 20 \end{cases} \Rightarrow 4B = 20 \Rightarrow B = 5$$

$$\text{and } D = -5 \Rightarrow \begin{cases} A + C = 0 \\ -A + 5 + C - 5 = 0 \end{cases} \Rightarrow C = 0 \text{ and } A = 0. \text{ Hence, } \sum_{n=1}^k \left[\frac{40n}{(2n-1)^2(2n+1)^2}\right]$$

$$= 5 \sum_{n=1}^k \left[\frac{1}{(2n-1)^2} - \frac{1}{(2n+1)^2} \right] = 5 \left(\frac{1}{1} - \frac{1}{9} + \frac{1}{9} - \frac{1}{25} + \frac{1}{25} - \dots - \frac{1}{(2k-1)^2} + \frac{1}{(2k-1)^2} - \frac{1}{(2k+1)^2} \right)$$

$$= 5 \left(1 - \frac{1}{(2k+1)^2} \right) \Rightarrow \text{the sum is } \lim_{n \rightarrow \infty} 5 \left(1 - \frac{1}{(2k+1)^2} \right) = 5$$

$$18. \frac{2n+1}{n^2(n+1)^2} = \frac{1}{n^2} - \frac{1}{(n+1)^2} \Rightarrow s_n = \left(1 - \frac{1}{4} \right) + \left(\frac{1}{4} - \frac{1}{9} \right) + \left(\frac{1}{9} - \frac{1}{16} \right) + \dots + \left[\frac{1}{(n-1)^2} - \frac{1}{n^2} \right] + \left[\frac{1}{n^2} - \frac{1}{(n+1)^2} \right]$$

$$\Rightarrow \lim_{n \rightarrow \infty} s_n = \lim_{n \rightarrow \infty} \left[1 - \frac{1}{(n+1)^2} \right] = 1$$

$$19. s_n = \left(1 - \frac{1}{\sqrt{2}} \right) + \left(\frac{1}{\sqrt{2}} - \frac{1}{\sqrt{3}} \right) + \left(\frac{1}{\sqrt{3}} - \frac{1}{\sqrt{4}} \right) + \dots + \left(\frac{1}{\sqrt{n-1}} - \frac{1}{\sqrt{n}} \right) + \left(\frac{1}{\sqrt{n}} - \frac{1}{\sqrt{n+1}} \right) = 1 - \frac{1}{\sqrt{n+1}}$$

$$\Rightarrow \lim_{n \rightarrow \infty} s_n = \lim_{n \rightarrow \infty} \left(1 - \frac{1}{\sqrt{n+1}} \right) = 1$$

$$20. s_n = \left(\frac{1}{2} - \frac{1}{2^{1/2}} \right) + \left(\frac{1}{2^{1/2}} - \frac{1}{2^{1/3}} \right) + \left(\frac{1}{2^{1/3}} - \frac{1}{2^{1/4}} \right) + \dots + \left(\frac{1}{2^{1/(n-1)}} - \frac{1}{2^{1/n}} \right) + \left(\frac{1}{2^{1/n}} - \frac{1}{2^{1/(n+1)}} \right) = \frac{1}{2} - \frac{1}{2^{1/(n+1)}}$$

$$\Rightarrow \lim_{n \rightarrow \infty} s_n = \frac{1}{2} - \frac{1}{1} = -\frac{1}{2}$$

$$21. s_n = \left(\frac{1}{\ln 3} - \frac{1}{\ln 2} \right) + \left(\frac{1}{\ln 4} - \frac{1}{\ln 3} \right) + \left(\frac{1}{\ln 5} - \frac{1}{\ln 4} \right) + \dots + \left(\frac{1}{\ln(n+1)} - \frac{1}{\ln n} \right) + \left(\frac{1}{\ln(n+2)} - \frac{1}{\ln(n+1)} \right)$$

$$= -\frac{1}{\ln 2} + \frac{1}{\ln(n+2)} \Rightarrow \lim_{n \rightarrow \infty} s_n = -\frac{1}{\ln 2}$$

$$22. s_n = [\tan^{-1}(1) - \tan^{-1}(2)] + [\tan^{-1}(2) - \tan^{-1}(3)] + \dots + [\tan^{-1}(n-1) - \tan^{-1}(n)]$$

$$+ [\tan^{-1}(n) - \tan^{-1}(n+1)] = \tan^{-1}(1) - \tan^{-1}(n+1) \Rightarrow \lim_{n \rightarrow \infty} s_n = \tan^{-1}(1) - \frac{\pi}{2} = \frac{\pi}{4} - \frac{\pi}{2} = -\frac{\pi}{4}$$

$$23. \text{convergent geometric series with sum } \frac{1}{1 - \left(\frac{1}{\sqrt{2}}\right)} = \frac{\sqrt{2}}{\sqrt{2}-1} = 2 + \sqrt{2}$$

$$24. \text{divergent geometric series with } |r| = \sqrt{2} > 1 \qquad 25. \text{convergent geometric series with sum } \frac{\left(\frac{3}{2}\right)}{1 - \left(-\frac{1}{2}\right)} = 1$$

$$26. \lim_{n \rightarrow \infty} (-1)^{n+1} n \neq 0 \Rightarrow \text{diverges} \qquad 27. \lim_{n \rightarrow \infty} \cos(n\pi) = \lim_{n \rightarrow \infty} (-1)^n \neq 0 \Rightarrow \text{diverges}$$

$$28. \cos(n\pi) = (-1)^n \Rightarrow \text{convergent geometric series with sum } \frac{1}{1 - \left(-\frac{1}{3}\right)} = \frac{5}{6}$$

$$29. \text{convergent geometric series with sum } \frac{1}{1 - \left(\frac{1}{e^2}\right)} = \frac{e^2}{e^2-1}$$

$$30. \lim_{n \rightarrow \infty} \ln \frac{1}{n} = -\infty \neq 0 \Rightarrow \text{diverges}$$

$$31. \text{convergent geometric series with sum } \frac{2}{1 - \left(\frac{1}{10}\right)} - 2 = \frac{20}{9} - \frac{18}{9} = \frac{2}{9}$$

$$32. \text{convergent geometric series with sum } \frac{1}{1 - \left(\frac{1}{x}\right)} = \frac{x}{x-1}$$

$$33. \text{difference of two geometric series with sum } \frac{1}{1 - \left(\frac{2}{3}\right)} - \frac{1}{1 - \left(\frac{1}{3}\right)} = 3 - \frac{3}{2} = \frac{3}{2}$$

$$34. \lim_{n \rightarrow \infty} \left(1 - \frac{1}{n} \right)^n = \lim_{n \rightarrow \infty} \left(1 + \frac{-1}{n} \right)^n = e^{-1} \neq 0 \Rightarrow \text{diverges}$$

$$35. \lim_{n \rightarrow \infty} \frac{n!}{1000^n} = \infty \neq 0 \Rightarrow \text{diverges}$$

$$36. \lim_{n \rightarrow \infty} \frac{n^n}{n!} = \lim_{n \rightarrow \infty} \frac{n \cdot n \cdots n}{1 \cdot 2 \cdots n} > \lim_{n \rightarrow \infty} n = \infty \Rightarrow \text{diverges}$$

$$37. \sum_{n=1}^{\infty} \ln\left(\frac{n}{n+1}\right) = \sum_{n=1}^{\infty} [\ln(n) - \ln(n+1)] \Rightarrow s_n = [\ln(1) - \ln(2)] + [\ln(2) - \ln(3)] + [\ln(3) - \ln(4)] + \dots \\ + [\ln(n-1) - \ln(n)] + [\ln(n) - \ln(n+1)] = \ln(1) - \ln(n+1) = -\ln(n+1) \Rightarrow \lim_{n \rightarrow \infty} s_n = -\infty, \Rightarrow \text{diverges}$$

$$38. \lim_{n \rightarrow \infty} a_n = \lim_{n \rightarrow \infty} \ln\left(\frac{n}{2n+1}\right) = \ln\left(\frac{1}{2}\right) \neq 0 \Rightarrow \text{diverges}$$

$$39. \text{convergent geometric series with sum } \frac{1}{1 - \left(\frac{e}{\pi}\right)} = \frac{\pi}{\pi - e}$$

$$40. \text{divergent geometric series with } |r| = \frac{e^\pi}{\pi^e} \approx \frac{23.141}{22.459} > 1$$

$$41. \sum_{n=0}^{\infty} (-1)^n x^n = \sum_{n=0}^{\infty} (-x)^n; a = 1, r = -x; \text{converges to } \frac{1}{1 - (-x)} = \frac{1}{1+x} \text{ for } |x| < 1$$

$$42. \sum_{n=0}^{\infty} (-1)^n x^{2n} = \sum_{n=0}^{\infty} (-x^2)^n; a = 1, r = -x^2; \text{converges to } \frac{1}{1+x^2} \text{ for } |x| < 1$$

$$43. a = 3, r = \frac{x-1}{2}; \text{converges to } \frac{3}{1 - \left(\frac{x-1}{2}\right)} = \frac{6}{3-x} \text{ for } -1 < \frac{x-1}{2} < 1 \text{ or } -1 < x < 3$$

$$44. \sum_{n=0}^{\infty} \frac{(-1)^n}{2} \left(\frac{1}{3+\sin x}\right)^n = \sum_{n=0}^{\infty} \frac{1}{2} \left(\frac{-1}{3+\sin x}\right)^n; a = \frac{1}{2}, r = \frac{-1}{3+\sin x}; \text{converges to } \frac{\left(\frac{1}{2}\right)}{1 - \left(\frac{-1}{3+\sin x}\right)} \\ = \frac{3+\sin x}{2(4+\sin x)} = \frac{3+\sin x}{8+2\sin x} \text{ for all } x \text{ (since } \frac{1}{4} \leq \frac{1}{3+\sin x} \leq \frac{1}{2} \text{ for all } x)$$

$$45. a = 1, r = 2x; \text{converges to } \frac{1}{1-2x} \text{ for } |2x| < 1 \text{ or } |x| < \frac{1}{2}$$

$$46. a = 1, r = -\frac{1}{x^2}; \text{converges to } \frac{1}{1 - \left(\frac{-1}{x^2}\right)} = \frac{x^2}{x^2+1} \text{ for } \left|\frac{1}{x^2}\right| < 1 \text{ or } |x| > 1.$$

$$47. a = 1, r = -(x+1)^n; \text{converges to } \frac{1}{1+(x+1)} = \frac{1}{2+x} \text{ for } |x+1| < 1 \text{ or } -2 < x < 0$$

$$48. a = 1, r = \frac{3-x}{2}; \text{converges to } \frac{1}{1 - \left(\frac{3-x}{2}\right)} = \frac{2}{x-1} \text{ for } \left|\frac{3-x}{2}\right| < 1 \text{ or } 1 < x < 5$$

$$49. a = 1, r = \sin x; \text{converges to } \frac{1}{1 - \sin x} \text{ for } x \neq (2k+1)\frac{\pi}{2}, k \text{ an integer}$$

$$50. a = 1, r = \ln x; \text{converges to } \frac{1}{1 - \ln x} \text{ for } |\ln x| < 1 \text{ or } e^{-1} < x < e$$

$$51. 0.\overline{23} = \sum_{n=0}^{\infty} \frac{23}{100} \left(\frac{1}{10^2}\right)^n = \frac{\left(\frac{23}{100}\right)}{1 - \left(\frac{1}{100}\right)} = \frac{23}{99}$$

$$52. 0.\overline{234} = \sum_{n=0}^{\infty} \frac{234}{1000} \left(\frac{1}{10^3}\right)^n = \frac{\left(\frac{234}{1000}\right)}{1 - \left(\frac{1}{1000}\right)} = \frac{234}{999}$$

$$53. 0.\overline{7} = \sum_{n=0}^{\infty} \frac{7}{10} \left(\frac{1}{10}\right)^n = \frac{\left(\frac{7}{10}\right)}{1 - \left(\frac{1}{10}\right)} = \frac{7}{9}$$

$$54. 0.\overline{d} = \sum_{n=0}^{\infty} \frac{d}{10} \left(\frac{1}{10}\right)^n = \frac{\left(\frac{d}{10}\right)}{1 - \left(\frac{1}{10}\right)} = \frac{d}{9}$$

$$55. 0.0\overline{6} = \sum_{n=0}^{\infty} \left(\frac{1}{10}\right) \left(\frac{6}{10}\right) \left(\frac{1}{10}\right)^n = \frac{\left(\frac{6}{100}\right)}{1 - \left(\frac{1}{10}\right)} = \frac{6}{90} = \frac{1}{15}$$

$$56. 1.\overline{414} = 1 + \sum_{n=0}^{\infty} \frac{414}{1000} \left(\frac{1}{10^3}\right)^n = 1 + \frac{\left(\frac{414}{1000}\right)}{1 - \left(\frac{1}{1000}\right)} = 1 + \frac{414}{999} = \frac{1413}{999}$$

$$57. 1.24\overline{123} = \frac{124}{100} + \sum_{n=0}^{\infty} \frac{123}{10^3} \left(\frac{1}{10^3}\right)^n = \frac{124}{100} + \frac{\left(\frac{123}{10^3}\right)}{1 - \left(\frac{1}{10^3}\right)} = \frac{124}{100} + \frac{123}{10^3 - 10^2} = \frac{124}{100} + \frac{123}{99,900} = \frac{123,999}{99,900} = \frac{41,333}{33,300}$$

$$58. 3.\overline{142857} = 3 + \sum_{n=0}^{\infty} \frac{142,857}{10^6} \left(\frac{1}{10^6}\right)^n = 3 + \frac{\left(\frac{142,857}{10^6}\right)}{1 - \left(\frac{1}{10^6}\right)} = 3 + \frac{142,857}{10^6 - 1} = \frac{3,142,854}{999,999} = \frac{116,402}{37,037}$$

$$59. \text{(a) } \sum_{n=-2}^{\infty} \frac{1}{(n+4)(n+5)} \qquad \text{(b) } \sum_{n=0}^{\infty} \frac{1}{(n+2)(n+3)} \qquad \text{(c) } \sum_{n=5}^{\infty} \frac{1}{(n-3)(n-2)}$$

$$60. \text{(a) } \sum_{n=-1}^{\infty} \frac{5}{(n+2)(n+3)} \qquad \text{(b) } \sum_{n=3}^{\infty} \frac{5}{(n-2)(n-1)} \qquad \text{(c) } \sum_{n=20}^{\infty} \frac{5}{(n-19)(n-18)}$$

$$61. \text{(a) one example is } \frac{1}{2} + \frac{1}{4} + \frac{1}{8} + \frac{1}{16} + \dots = \frac{\left(\frac{1}{2}\right)}{1 - \left(\frac{1}{2}\right)} = 1$$

$$\text{(b) one example is } -\frac{3}{2} - \frac{3}{4} - \frac{3}{8} - \frac{3}{16} - \dots = \frac{\left(-\frac{3}{2}\right)}{1 - \left(\frac{1}{2}\right)} = -3$$

$$\text{(c) one example is } 1 - \frac{1}{2} - \frac{1}{4} - \frac{1}{8} - \frac{1}{16} - \dots; \text{ the series } \frac{k}{2} + \frac{k}{4} + \frac{k}{8} + \dots = \frac{\left(\frac{k}{2}\right)}{1 - \left(\frac{1}{2}\right)} = k \text{ where } k \text{ is any positive or negative number.}$$

$$62. \text{The series } \sum_{n=0}^{\infty} k\left(\frac{1}{2}\right)^{n+1} \text{ is a geometric series whose sum is } \frac{\left(\frac{k}{2}\right)}{1 - \left(\frac{1}{2}\right)} = k \text{ where } k \text{ can be any positive or negative number.}$$

$$63. \text{Let } a_n = b_n = \left(\frac{1}{2}\right)^n. \text{ Then } \sum_{n=1}^{\infty} a_n = \sum_{n=1}^{\infty} b_n = \sum_{n=1}^{\infty} \left(\frac{1}{2}\right)^n = 1, \text{ while } \sum_{n=1}^{\infty} \left(\frac{a_n}{b_n}\right) = \sum_{n=1}^{\infty} (1) \text{ diverges.}$$

$$64. \text{Let } a_n = b_n = \left(\frac{1}{2}\right)^n. \text{ Then } \sum_{n=1}^{\infty} a_n = \sum_{n=1}^{\infty} b_n = \sum_{n=1}^{\infty} \left(\frac{1}{2}\right)^n = 1, \text{ while } \sum_{n=1}^{\infty} (a_n b_n) = \sum_{n=1}^{\infty} \left(\frac{1}{4}\right)^n = \frac{1}{3} \neq AB.$$

$$65. \text{Let } a_n = \left(\frac{1}{4}\right)^n \text{ and } b_n = \left(\frac{1}{2}\right)^n. \text{ Then } A = \sum_{n=1}^{\infty} a_n = \frac{1}{3}, B = \sum_{n=1}^{\infty} b_n = 1 \text{ and } \sum_{n=1}^{\infty} \left(\frac{a_n}{b_n}\right) = \sum_{n=1}^{\infty} \left(\frac{1}{2}\right)^n = 1 \neq \frac{A}{B}.$$

$$66. \text{Yes: } \sum \left(\frac{1}{a_n}\right) \text{ diverges. The reasoning: } \sum a_n \text{ converges} \Rightarrow a_n \rightarrow 0 \Rightarrow \frac{1}{a_n} \rightarrow \infty \Rightarrow \sum \left(\frac{1}{a_n}\right) \text{ diverges by the } n\text{th-Term Test.}$$

67. Since the sum of a finite number of terms is finite, adding or subtracting a finite number of terms from a series that diverges does not change the divergence of the series.

$$68. \text{Let } A_n = a_1 + a_2 + \dots + a_n \text{ and } \lim_{n \rightarrow \infty} A_n = A. \text{ Assume } \sum (a_n + b_n) \text{ converges to } S. \text{ Let}$$

$$S_n = (a_1 + b_1) + (a_2 + b_2) + \dots + (a_n + b_n) \Rightarrow S_n = (a_1 + a_2 + \dots + a_n) + (b_1 + b_2 + \dots + b_n)$$

$$\Rightarrow b_1 + b_2 + \dots + b_n = S_n - A_n \Rightarrow \lim_{n \rightarrow \infty} (b_1 + b_2 + \dots + b_n) = S - A \Rightarrow \sum b_n \text{ converges. This}$$

contradicts the assumption that $\sum b_n$ diverges; therefore, $\sum (a_n + b_n)$ diverges.

69. (a) $\frac{2}{1-r} = 5 \Rightarrow \frac{2}{5} = 1-r \Rightarrow r = \frac{3}{5}; 2 + 2\left(\frac{3}{5}\right) + 2\left(\frac{3}{5}\right)^2 + \dots$

(b) $\frac{\left(\frac{13}{2}\right)}{1-r} = 5 \Rightarrow \frac{13}{10} = 1-r \Rightarrow r = -\frac{3}{10}; \frac{13}{2} - \frac{13}{2}\left(\frac{3}{10}\right) + \frac{13}{2}\left(\frac{3}{10}\right)^2 - \frac{13}{2}\left(\frac{3}{10}\right)^3 + \dots$

70. $1 + e^b + e^{2b} + \dots = \frac{1}{1-e^b} = 9 \Rightarrow \frac{1}{9} = 1 - e^b \Rightarrow e^b = \frac{8}{9} \Rightarrow b = \ln\left(\frac{8}{9}\right)$

71. $s_n = 1 + 2r + r^2 + 2r^3 + r^4 + 2r^5 + \dots + r^{2n} + 2r^{2n+1}, n = 0, 1, \dots$

$\Rightarrow s_n = (1 + r^2 + r^4 + \dots + r^{2n}) + (2r + 2r^3 + 2r^5 + \dots + 2r^{2n+1}) \Rightarrow \lim_{n \rightarrow \infty} s_n = \frac{1}{1-r^2} + \frac{2r}{1-r^2}$
 $= \frac{1+2r}{1-r^2}, \text{ if } |r^2| < 1 \text{ or } |r| < 1$

72. $L - s_n = \frac{a}{1-r} - \frac{a(1-r^n)}{1-r} = \frac{ar^n}{1-r}$

73. distance = $4 + 2\left[(4)\left(\frac{3}{4}\right) + (4)\left(\frac{3}{4}\right)^2 + \dots\right] = 4 + 2\left(\frac{3}{1-\left(\frac{3}{4}\right)}\right) = 28 \text{ m}$

74. time = $\sqrt{\frac{4}{4.9}} + 2\sqrt{\left(\frac{4}{4.9}\right)\left(\frac{3}{4}\right)} + 2\sqrt{\left(\frac{4}{4.9}\right)\left(\frac{3}{4}\right)^2} + 2\sqrt{\left(\frac{4}{4.9}\right)\left(\frac{3}{4}\right)^3} + \dots = \sqrt{\frac{4}{4.9}} + 2\sqrt{\frac{4}{4.9}}\left[\sqrt{\frac{3}{4}} + \sqrt{\left(\frac{3}{4}\right)^2} + \dots\right]$
 $= \frac{2}{\sqrt{4.9}} + \left(\frac{4}{\sqrt{4.9}}\right)\left[\frac{\sqrt{\frac{3}{4}}}{1-\sqrt{\frac{3}{4}}}\right] = \frac{2}{\sqrt{4.9}} + \left(\frac{4}{\sqrt{4.9}}\right)\left(\frac{\sqrt{3}}{2-\sqrt{3}}\right) = \frac{(4-2\sqrt{3})+4\sqrt{3}}{\sqrt{4.9}(2-\sqrt{3})} = \frac{4+2\sqrt{3}}{\sqrt{4.9}(2-\sqrt{3})} \approx 12.58 \text{ sec}$

75. area = $2^2 + (\sqrt{2})^2 + (1)^2 + \left(\frac{1}{\sqrt{2}}\right)^2 + \dots = 4 + 2 + 1 + \frac{1}{2} + \dots = \frac{4}{1-\frac{1}{2}} = 8 \text{ m}^2$

76. area = $2\left[\frac{\pi\left(\frac{1}{2}\right)^2}{2}\right] + 4\left[\frac{\pi\left(\frac{1}{4}\right)^2}{2}\right] + 8\left[\frac{\pi\left(\frac{1}{8}\right)^2}{2}\right] + \dots = \pi\left(\frac{1}{4} + \frac{1}{8} + \frac{1}{16} + \dots\right) = \pi\left(\frac{\frac{1}{4}}{1-\frac{1}{2}}\right) = \frac{\pi}{2}$

77. (a) $L_1 = 3, L_2 = 3\left(\frac{4}{3}\right), L_3 = 3\left(\frac{4}{3}\right)^2, \dots, L_n = 3\left(\frac{4}{3}\right)^{n-1} \Rightarrow \lim_{n \rightarrow \infty} L_n = \lim_{n \rightarrow \infty} 3\left(\frac{4}{3}\right)^{n-1} = \infty$

(b) Using the fact that the area of an equilateral triangle of side length s is $\frac{\sqrt{3}}{4}s^2$, we see that $A_1 = \frac{\sqrt{3}}{4}$,

$A_2 = A_1 + 3\left(\frac{\sqrt{3}}{4}\right)\left(\frac{1}{3}\right)^2 = \frac{\sqrt{3}}{4} + \frac{\sqrt{3}}{12}, A_3 = A_2 + 3(4)\left(\frac{\sqrt{3}}{4}\right)\left(\frac{1}{3^2}\right)^2 = \frac{\sqrt{3}}{4} + \frac{\sqrt{3}}{12} + \frac{\sqrt{3}}{27},$

$A_4 = A_3 + 3(4)^2\left(\frac{\sqrt{3}}{4}\right)\left(\frac{1}{3^3}\right)^2, A_5 = A_4 + 3(4)^3\left(\frac{\sqrt{3}}{4}\right)\left(\frac{1}{3^4}\right)^2, \dots,$

$A_n = \frac{\sqrt{3}}{4} + \sum_{k=2}^n 3(4)^{k-2}\left(\frac{\sqrt{3}}{4}\right)\left(\frac{1}{3^2}\right)^{k-1} = \frac{\sqrt{3}}{4} + \sum_{k=2}^n 3\sqrt{3}(4)^{k-3}\left(\frac{1}{9}\right)^{k-1} = \frac{\sqrt{3}}{4} + 3\sqrt{3}\left(\sum_{k=2}^n \frac{4^{k-3}}{9^{k-1}}\right).$

$\lim_{n \rightarrow \infty} A_n = \lim_{n \rightarrow \infty} \left(\frac{\sqrt{3}}{4} + 3\sqrt{3}\left(\sum_{k=2}^n \frac{4^{k-3}}{9^{k-1}}\right)\right) = \frac{\sqrt{3}}{4} + 3\sqrt{3}\left(\frac{\frac{1}{36}}{1-\frac{4}{9}}\right) = \frac{\sqrt{3}}{4} + 3\sqrt{3}\left(\frac{1}{20}\right) = \frac{2\sqrt{3}}{5}$

78. Each term of the series $\sum_{n=1}^{\infty} \frac{1}{n^2}$ represents the area of one of the squares shown in the figure, and all of the

squares lie inside the rectangle of width 1 and length $\sum_{n=0}^{\infty} \left(\frac{1}{2}\right)^n = \frac{1}{1-\frac{1}{2}} = 2$. Since the squares do not fill the

rectangle completely, and the area of the rectangle is 2, we have $\sum_{n=1}^{\infty} \frac{1}{n^2} < 2$.

11.3 THE INTEGRAL TEST

1. converges; a geometric series with $r = \frac{1}{10} < 1$

2. converges; a geometric series with $r = \frac{1}{e} < 1$

3. diverges; by the n th-Term Test for Divergence, $\lim_{n \rightarrow \infty} \frac{n}{n+1} = 1 \neq 0$
4. diverges by the Integral Test; $\int_1^n \frac{5}{x+1} dx = 5 \ln(n+1) - 5 \ln 2 \Rightarrow \int_1^\infty \frac{5}{x+1} dx \rightarrow \infty$
5. diverges; $\sum_{n=1}^\infty \frac{3}{\sqrt{n}} = 3 \sum_{n=1}^\infty \frac{1}{\sqrt{n}}$, which is a divergent p -series ($p = \frac{1}{2}$)
6. converges; $\sum_{n=1}^\infty \frac{-2}{n\sqrt{n}} = -2 \sum_{n=1}^\infty \frac{1}{n^{3/2}}$, which is a convergent p -series ($p = \frac{3}{2}$)
7. converges; a geometric series with $r = \frac{1}{8} < 1$
8. diverges; $\sum_{n=1}^\infty \frac{-8}{n} = -8 \sum_{n=1}^\infty \frac{1}{n}$ and since $\sum_{n=1}^\infty \frac{1}{n}$ diverges, $-8 \sum_{n=1}^\infty \frac{1}{n}$ diverges
9. diverges by the Integral Test: $\int_2^n \frac{\ln x}{x} dx = \frac{1}{2} (\ln^2 n - \ln 2) \Rightarrow \int_2^\infty \frac{\ln x}{x} dx \rightarrow \infty$
10. diverges by the Integral Test: $\int_2^\infty \frac{\ln x}{\sqrt{x}} dx$; $\left[\begin{array}{l} t = \ln x \\ dt = \frac{dx}{x} \\ dx = e^t dt \end{array} \right] \rightarrow \int_{\ln 2}^\infty te^{t/2} dt = \lim_{b \rightarrow \infty} [2te^{t/2} - 4e^{t/2}]_{\ln 2}^b$
 $= \lim_{b \rightarrow \infty} [2e^{b/2}(b-2) - 2e^{(\ln 2)/2}(\ln 2 - 2)] = \infty$
11. converges; a geometric series with $r = \frac{2}{3} < 1$
12. diverges; $\lim_{n \rightarrow \infty} \frac{5^n}{4^{n+3}} = \lim_{n \rightarrow \infty} \frac{5^n \ln 5}{4^n \ln 4} = \lim_{n \rightarrow \infty} \left(\frac{\ln 5}{\ln 4}\right) \left(\frac{5}{4}\right)^n = \infty \neq 0$
13. diverges; $\sum_{n=0}^\infty \frac{-2}{n+1} = -2 \sum_{n=0}^\infty \frac{1}{n+1}$, which diverges by the Integral Test
14. diverges by the Integral Test: $\int_1^n \frac{dx}{2x-1} = \frac{1}{2} \ln(2n-1) \rightarrow \infty$ as $n \rightarrow \infty$
15. diverges; $\lim_{n \rightarrow \infty} a_n = \lim_{n \rightarrow \infty} \frac{2^n}{n+1} = \lim_{n \rightarrow \infty} \frac{2^n \ln 2}{1} = \infty \neq 0$
16. diverges by the Integral Test: $\int_1^n \frac{dx}{\sqrt{x}(\sqrt{x}+1)}$; $\left[\begin{array}{l} u = \sqrt{x} + 1 \\ du = \frac{dx}{\sqrt{x}} \end{array} \right] \rightarrow \int_2^{\sqrt{n}+1} \frac{du}{u} = \ln(\sqrt{n}+1) - \ln 2$
 $\rightarrow \infty$ as $n \rightarrow \infty$
17. diverges; $\lim_{n \rightarrow \infty} \frac{\sqrt{n}}{\ln n} = \lim_{n \rightarrow \infty} \frac{\left(\frac{1}{2\sqrt{n}}\right)}{\left(\frac{1}{n}\right)} = \lim_{n \rightarrow \infty} \frac{\sqrt{n}}{2} = \infty \neq 0$
18. diverges; $\lim_{n \rightarrow \infty} a_n = \lim_{n \rightarrow \infty} \left(1 + \frac{1}{n}\right)^n = e \neq 0$
19. diverges; a geometric series with $r = \frac{1}{\ln 2} \approx 1.44 > 1$
20. converges; a geometric series with $r = \frac{1}{\ln 3} \approx 0.91 < 1$

21. converges by the Integral Test: $\int_3^\infty \frac{(\frac{1}{x})}{(\ln x)\sqrt{(\ln x)^2-1}} dx$; $\left[\begin{array}{l} u = \ln x \\ du = \frac{1}{x} dx \end{array} \right] \rightarrow \int_{\ln 3}^\infty \frac{1}{u\sqrt{u^2-1}} du$
 $= \lim_{b \rightarrow \infty} [\sec^{-1} |u|]_{\ln 3}^b = \lim_{b \rightarrow \infty} [\sec^{-1} b - \sec^{-1}(\ln 3)] = \lim_{b \rightarrow \infty} [\cos^{-1}(\frac{1}{b}) - \sec^{-1}(\ln 3)]$
 $= \cos^{-1}(0) - \sec^{-1}(\ln 3) = \frac{\pi}{2} - \sec^{-1}(\ln 3) \approx 1.1439$
22. converges by the Integral Test: $\int_1^\infty \frac{1}{x(1+\ln^2 x)} dx = \int_1^\infty \frac{(\frac{1}{x})}{1+(\ln x)^2} dx$; $\left[\begin{array}{l} u = \ln x \\ du = \frac{1}{x} dx \end{array} \right] \rightarrow \int_0^\infty \frac{1}{1+u^2} du$
 $= \lim_{b \rightarrow \infty} [\tan^{-1} u]_0^b = \lim_{b \rightarrow \infty} (\tan^{-1} b - \tan^{-1} 0) = \frac{\pi}{2} - 0 = \frac{\pi}{2}$
23. diverges by the nth-Term Test for divergence; $\lim_{n \rightarrow \infty} n \sin(\frac{1}{n}) = \lim_{n \rightarrow \infty} \frac{\sin(\frac{1}{n})}{(\frac{1}{n})} = \lim_{x \rightarrow 0} \frac{\sin x}{x} = 1 \neq 0$
24. diverges by the nth-Term Test for divergence; $\lim_{n \rightarrow \infty} n \tan(\frac{1}{n}) = \lim_{n \rightarrow \infty} \frac{\tan(\frac{1}{n})}{(\frac{1}{n})} = \lim_{n \rightarrow \infty} \frac{(-\frac{1}{n^2}) \sec^2(\frac{1}{n})}{(-\frac{1}{n^2})}$
 $= \lim_{n \rightarrow \infty} \sec^2(\frac{1}{n}) = \sec^2 0 = 1 \neq 0$
25. converges by the Integral Test: $\int_1^\infty \frac{e^x}{1+e^{2x}} dx$; $\left[\begin{array}{l} u = e^x \\ du = e^x dx \end{array} \right] \rightarrow \int_e^\infty \frac{1}{1+u^2} du = \lim_{n \rightarrow \infty} [\tan^{-1} u]_e^n$
 $= \lim_{b \rightarrow \infty} (\tan^{-1} b - \tan^{-1} e) = \frac{\pi}{2} - \tan^{-1} e \approx 0.35$
26. converges by the Integral Test: $\int_1^\infty \frac{2}{1+e^x} dx$; $\left[\begin{array}{l} u = e^x \\ du = e^x dx \\ dx = \frac{1}{u} du \end{array} \right] \rightarrow \int_e^\infty \frac{2}{u(1+u)} du = \int_e^\infty (\frac{2}{u} - \frac{2}{u+1}) du$
 $= \lim_{b \rightarrow \infty} [2 \ln \frac{u}{u+1}]_e^b = \lim_{b \rightarrow \infty} 2 \ln(\frac{b}{b+1}) - 2 \ln(\frac{e}{e+1}) = 2 \ln 1 - 2 \ln(\frac{e}{e+1}) = -2 \ln(\frac{e}{e+1}) \approx 0.63$
27. converges by the Integral Test: $\int_1^\infty \frac{8 \tan^{-1} x}{1+x^2} dx$; $\left[\begin{array}{l} u = \tan^{-1} x \\ du = \frac{dx}{1+x^2} \end{array} \right] \rightarrow \int_{\pi/4}^{\pi/2} 8u du = [4u^2]_{\pi/4}^{\pi/2} = 4(\frac{\pi^2}{4} - \frac{\pi^2}{16}) = \frac{3\pi^2}{4}$
28. diverges by the Integral Test: $\int_1^\infty \frac{x}{x^2+1} dx$; $\left[\begin{array}{l} u = x^2+1 \\ du = 2x dx \end{array} \right] \rightarrow \frac{1}{2} \int_2^\infty \frac{du}{u} = \lim_{b \rightarrow \infty} [\frac{1}{2} \ln u]_2^b$
 $= \lim_{b \rightarrow \infty} \frac{1}{2} (\ln b - \ln 2) = \infty$
29. converges by the Integral Test: $\int_1^\infty \operatorname{sech} x dx = 2 \lim_{b \rightarrow \infty} \int_1^b \frac{e^x}{1+(e^x)^2} dx = 2 \lim_{b \rightarrow \infty} [\tan^{-1} e^x]_1^b$
 $= 2 \lim_{b \rightarrow \infty} (\tan^{-1} e^b - \tan^{-1} e) = \pi - 2 \tan^{-1} e \approx 0.71$
30. converges by the Integral Test: $\int_1^\infty \operatorname{sech}^2 x dx = \lim_{b \rightarrow \infty} \int_1^b \operatorname{sech}^2 x dx = \lim_{b \rightarrow \infty} [\tanh x]_1^b = \lim_{b \rightarrow \infty} (\tanh b - \tanh 1)$
 $= 1 - \tanh 1 \approx 0.76$
31. $\int_1^\infty (\frac{a}{x+2} - \frac{1}{x+4}) dx = \lim_{b \rightarrow \infty} [a \ln |x+2| - \ln |x+4|]_1^b = \lim_{b \rightarrow \infty} \ln \frac{(b+2)^a}{b+4} - \ln(\frac{3^a}{5})$;
 $\lim_{b \rightarrow \infty} \frac{(b+2)^a}{b+4} = a \lim_{b \rightarrow \infty} (b+2)^{a-1} = \begin{cases} \infty, & a > 1 \\ 1, & a = 1 \end{cases} \Rightarrow$ the series converges to $\ln(\frac{5}{3})$ if $a = 1$ and diverges to ∞ if $a > 1$. If $a < 1$, the terms of the series eventually become negative and the Integral Test does not apply. From that point on, however, the series behaves like a negative multiple of the harmonic series, and so it diverges.

$$32. \int_3^\infty \left(\frac{1}{x-1} - \frac{2a}{x+1} \right) dx = \lim_{b \rightarrow \infty} \left[\ln \left| \frac{x-1}{(x+1)^{2a}} \right| \right]_3^b = \lim_{b \rightarrow \infty} \ln \frac{b-1}{(b+1)^{2a}} - \ln \left(\frac{2}{4^{2a}} \right); \lim_{b \rightarrow \infty} \frac{b-1}{(b+1)^{2a}}$$

$$= \lim_{b \rightarrow \infty} \frac{1}{2a(b+1)^{2a-1}} = \begin{cases} 1, & a = \frac{1}{2} \\ \infty, & a < \frac{1}{2} \end{cases} \Rightarrow \text{the series converges to } \ln \left(\frac{4}{2} \right) = \ln 2 \text{ if } a = \frac{1}{2} \text{ and diverges to } \infty \text{ if}$$

if $a < \frac{1}{2}$. If $a > \frac{1}{2}$, the terms of the series eventually become negative and the Integral Test does not apply. From that point on, however, the series behaves like a negative multiple of the harmonic series, and so it diverges.

33. (a)

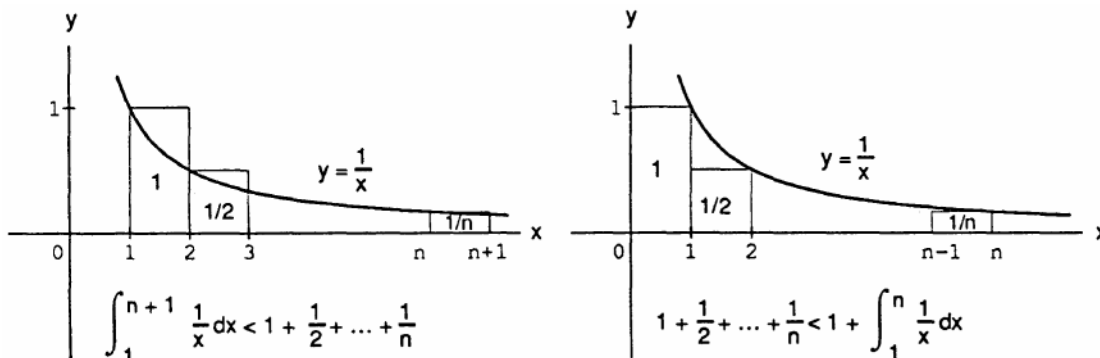

(b) There are $(13)(365)(24)(60)(60)(10^9)$ seconds in 13 billion years; by part (a) $s_n \leq 1 + \ln n$ where $n = (13)(365)(24)(60)(60)(10^9) \Rightarrow s_n \leq 1 + \ln ((13)(365)(24)(60)(60)(10^9))$
 $= 1 + \ln(13) + \ln(365) + \ln(24) + 2 \ln(60) + 9 \ln(10) \approx 41.55$

34. No, because $\sum_{n=1}^\infty \frac{1}{nx} = \frac{1}{x} \sum_{n=1}^\infty \frac{1}{n}$ and $\sum_{n=1}^\infty \frac{1}{n}$ diverges

35. Yes. If $\sum_{n=1}^\infty a_n$ is a divergent series of positive numbers, then $\left(\frac{1}{2}\right) \sum_{n=1}^\infty a_n = \sum_{n=1}^\infty \left(\frac{a_n}{2}\right)$ also diverges and $\frac{a_n}{2} < a_n$.

There is no “smallest” divergent series of positive numbers: for any divergent series $\sum_{n=1}^\infty a_n$ of positive numbers $\sum_{n=1}^\infty \left(\frac{a_n}{2}\right)$ has smaller terms and still diverges.

36. No, if $\sum_{n=1}^\infty a_n$ is a convergent series of positive numbers, then $2 \sum_{n=1}^\infty a_n = \sum_{n=1}^\infty 2a_n$ also converges, and $2a_n \geq a_n$.

There is no “largest” convergent series of positive numbers.

37. Let $A_n = \sum_{k=1}^n a_k$ and $B_n = \sum_{k=1}^n 2^k a_{(2^k)}$, where $\{a_k\}$ is a nonincreasing sequence of positive terms converging to

0. Note that $\{A_n\}$ and $\{B_n\}$ are nondecreasing sequences of positive terms. Now,

$$B_n = 2a_2 + 4a_4 + 8a_8 + \dots + 2^n a_{(2^n)} = 2a_2 + (2a_4 + 2a_4) + (2a_8 + 2a_8 + 2a_8 + 2a_8) + \dots$$

$$+ \underbrace{(2a_{(2^n)} + 2a_{(2^n)} + \dots + 2a_{(2^n)})}_{2^{n-1} \text{ terms}} \leq 2a_1 + 2a_2 + (2a_3 + 2a_4) + (2a_5 + 2a_6 + 2a_7 + 2a_8) + \dots$$

$$+ (2a_{(2^{n-1})} + 2a_{(2^{n-1}+1)} + \dots + 2a_{(2^n)}) = 2A_{(2^n)} \leq 2 \sum_{k=1}^\infty a_k. \text{ Therefore if } \sum a_k \text{ converges,}$$

then $\{B_n\}$ is bounded above $\Rightarrow \sum 2^k a_{(2^k)}$ converges. Conversely,

$$A_n = a_1 + (a_2 + a_3) + (a_4 + a_5 + a_6 + a_7) + \dots + a_n < a_1 + 2a_2 + 4a_4 + \dots + 2^n a_{(2^n)} = a_1 + B_n < a_1 + \sum_{k=1}^\infty 2^k a_{(2^k)}.$$

Therefore, if $\sum_{k=1}^{\infty} 2^k a_{(2^k)}$ converges, then $\{A_n\}$ is bounded above and hence converges.

38. (a) $a_{(2^n)} = \frac{1}{2^n \ln(2^n)} = \frac{1}{2^n \cdot n \ln 2} \Rightarrow \sum_{n=2}^{\infty} 2^n a_{(2^n)} = \sum_{n=2}^{\infty} 2^n \frac{1}{2^n \cdot n \ln 2} = \frac{1}{\ln 2} \sum_{n=2}^{\infty} \frac{1}{n}$, which diverges
 $\Rightarrow \sum_{n=2}^{\infty} \frac{1}{n \ln n}$ diverges.

(b) $a_{(2^n)} = \frac{1}{2^{np}} \Rightarrow \sum_{n=1}^{\infty} 2^n a_{(2^n)} = \sum_{n=1}^{\infty} 2^n \cdot \frac{1}{2^{np}} = \sum_{n=1}^{\infty} \frac{1}{(2^n)^{p-1}} = \sum_{n=1}^{\infty} \left(\frac{1}{2^{p-1}}\right)^n$, a geometric series that converges if $\frac{1}{2^{p-1}} < 1$ or $p > 1$, but diverges if $p \leq 1$.

39. (a) $\int_2^{\infty} \frac{dx}{x(\ln x)^p}$; $\left[\begin{array}{l} u = \ln x \\ du = \frac{dx}{x} \end{array} \right] \rightarrow \int_{\ln 2}^{\infty} u^{-p} du = \lim_{b \rightarrow \infty} \left[\frac{u^{-p+1}}{-p+1} \right]_{\ln 2}^b = \lim_{b \rightarrow \infty} \left(\frac{1}{1-p} \right) [b^{-p+1} - (\ln 2)^{-p+1}]$
 $= \begin{cases} \frac{1}{p-1} (\ln 2)^{-p+1}, p > 1 \\ \infty, p < 1 \end{cases} \Rightarrow$ the improper integral converges if $p > 1$ and diverges

if $p < 1$. For $p = 1$: $\int_2^{\infty} \frac{dx}{x \ln x} = \lim_{b \rightarrow \infty} [\ln(\ln x)]_2^b = \lim_{b \rightarrow \infty} [\ln(\ln b) - \ln(\ln 2)] = \infty$, so the improper integral diverges if $p = 1$.

(b) Since the series and the integral converge or diverge together, $\sum_{n=2}^{\infty} \frac{1}{n(\ln n)^p}$ converges if and only if $p > 1$.

40. (a) $p = 1 \Rightarrow$ the series diverges

(b) $p = 1.01 \Rightarrow$ the series converges

(c) $\sum_{n=2}^{\infty} \frac{1}{n(\ln n^3)} = \frac{1}{3} \sum_{n=2}^{\infty} \frac{1}{n(\ln n)}$; $p = 1 \Rightarrow$ the series diverges

(d) $p = 3 \Rightarrow$ the series converges

41. (a) From Fig. 11.8 in the text with $f(x) = \frac{1}{x}$ and $a_k = \frac{1}{k}$, we have $\int_1^{n+1} \frac{1}{x} dx \leq 1 + \frac{1}{2} + \frac{1}{3} + \dots + \frac{1}{n}$
 $\leq 1 + \int_1^n f(x) dx \Rightarrow \ln(n+1) \leq 1 + \frac{1}{2} + \frac{1}{3} + \dots + \frac{1}{n} \leq 1 + \ln n \Rightarrow 0 \leq \ln(n+1) - \ln n$
 $\leq \left(1 + \frac{1}{2} + \frac{1}{3} + \dots + \frac{1}{n}\right) - \ln n \leq 1$. Therefore the sequence $\left\{\left(1 + \frac{1}{2} + \frac{1}{3} + \dots + \frac{1}{n}\right) - \ln n\right\}$ is bounded above by 1 and below by 0.

(b) From the graph in Fig. 11.8(a) with $f(x) = \frac{1}{x}$, $\frac{1}{n+1} < \int_n^{n+1} \frac{1}{x} dx = \ln(n+1) - \ln n$
 $\Rightarrow 0 > \frac{1}{n+1} - [\ln(n+1) - \ln n] = \left(1 + \frac{1}{2} + \frac{1}{3} + \dots + \frac{1}{n+1} - \ln(n+1)\right) - \left(1 + \frac{1}{2} + \frac{1}{3} + \dots + \frac{1}{n} - \ln n\right)$.

If we define $a_n = 1 + \frac{1}{2} + \frac{1}{3} + \dots + \frac{1}{n} - \ln n$, then $0 > a_{n+1} - a_n \Rightarrow a_{n+1} < a_n \Rightarrow \{a_n\}$ is a decreasing sequence of nonnegative terms.

42. $e^{-x^2} \leq e^{-x}$ for $x \geq 1$, and $\int_1^{\infty} e^{-x} dx = \lim_{b \rightarrow \infty} [-e^{-x}]_1^b = \lim_{b \rightarrow \infty} (-e^{-b} + e^{-1}) = e^{-1} \Rightarrow \int_1^{\infty} e^{-x^2} dx$ converges by the Comparison Test for improper integrals $\Rightarrow \sum_{n=0}^{\infty} e^{-n^2} = 1 + \sum_{n=1}^{\infty} e^{-n^2}$ converges by the Integral Test.

11.4 COMPARISON TESTS

1. diverges by the Limit Comparison Test (part 1) when compared with $\sum_{n=1}^{\infty} \frac{1}{\sqrt{n}}$, a divergent p-series:

$$\lim_{n \rightarrow \infty} \frac{\left(\frac{1}{2\sqrt{n} + \sqrt[3]{n}}\right)}{\left(\frac{1}{\sqrt{n}}\right)} = \lim_{n \rightarrow \infty} \frac{\sqrt{n}}{2\sqrt{n} + \sqrt[3]{n}} = \lim_{n \rightarrow \infty} \left(\frac{1}{2 + n^{-1/6}}\right) = \frac{1}{2}$$

2. diverges by the Direct Comparison Test since $n + n + n > n + \sqrt{n} + 0 \Rightarrow \frac{3}{n + \sqrt{n}} > \frac{1}{n}$, which is the n th term of the divergent series $\sum_{n=1}^{\infty} \frac{1}{n}$ or use Limit Comparison Test with $b_n = \frac{1}{n}$
3. converges by the Direct Comparison Test; $\frac{\sin^2 n}{2^n} \leq \frac{1}{2^n}$, which is the n th term of a convergent geometric series
4. converges by the Direct Comparison Test; $\frac{1 + \cos n}{n^2} \leq \frac{2}{n^2}$ and the p -series $\sum \frac{1}{n^2}$ converges
5. diverges since $\lim_{n \rightarrow \infty} \frac{2n}{3n-1} = \frac{2}{3} \neq 0$

6. converges by the Limit Comparison Test (part 1) with $\frac{1}{n^{3/2}}$, the n th term of a convergent p -series:

$$\lim_{n \rightarrow \infty} \frac{\left(\frac{n+1}{n^2 \sqrt{n}}\right)}{\left(\frac{1}{n^{3/2}}\right)} = \lim_{n \rightarrow \infty} \left(\frac{n+1}{n}\right) = 1$$

7. converges by the Direct Comparison Test; $\left(\frac{n}{3n+1}\right)^n < \left(\frac{n}{3n}\right)^n = \left(\frac{1}{3}\right)^n$, the n th term of a convergent geometric series

8. converges by the Limit Comparison Test (part 1) with $\frac{1}{n^{3/2}}$, the n th term of a convergent p -series:

$$\lim_{n \rightarrow \infty} \frac{\left(\frac{1}{n^{3/2}}\right)}{\left(\frac{1}{\sqrt{n^3+2}}\right)} = \lim_{n \rightarrow \infty} \sqrt{\frac{n^3+2}{n^3}} = \lim_{n \rightarrow \infty} \sqrt{1 + \frac{2}{n^3}} = 1$$

9. diverges by the Direct Comparison Test; $n > \ln n \Rightarrow \ln n > \ln \ln n \Rightarrow \frac{1}{n} < \frac{1}{\ln n} < \frac{1}{\ln(\ln n)}$ and $\sum_{n=3}^{\infty} \frac{1}{n}$ diverges

10. diverges by the Limit Comparison Test (part 3) when compared with $\sum_{n=2}^{\infty} \frac{1}{n}$, a divergent p -series:

$$\lim_{n \rightarrow \infty} \frac{\left(\frac{1}{(\ln n)^2}\right)}{\left(\frac{1}{n}\right)} = \lim_{n \rightarrow \infty} \frac{n}{(\ln n)^2} = \lim_{n \rightarrow \infty} \frac{1}{2(\ln n)\left(\frac{1}{n}\right)} = \frac{1}{2} \lim_{n \rightarrow \infty} \frac{n}{\ln n} = \frac{1}{2} \lim_{n \rightarrow \infty} \left(\frac{1}{\frac{1}{n}}\right) = \frac{1}{2} \lim_{n \rightarrow \infty} n = \infty$$

11. converges by the Limit Comparison Test (part 2) when compared with $\sum_{n=1}^{\infty} \frac{1}{n^2}$, a convergent p -series:

$$\lim_{n \rightarrow \infty} \frac{\left[\frac{(\ln n)^2}{n^3}\right]}{\left(\frac{1}{n^2}\right)} = \lim_{n \rightarrow \infty} \frac{(\ln n)^2}{n} = \lim_{n \rightarrow \infty} \frac{2(\ln n)\left(\frac{1}{n}\right)}{1} = 2 \lim_{n \rightarrow \infty} \frac{\ln n}{n} = 0$$

12. converges by the Limit Comparison Test (part 2) when compared with $\sum_{n=1}^{\infty} \frac{1}{n^2}$, a convergent p -series:

$$\begin{aligned} \lim_{n \rightarrow \infty} \frac{\left[\frac{(\ln n)^3}{n^3}\right]}{\left(\frac{1}{n^2}\right)} &= \lim_{n \rightarrow \infty} \frac{(\ln n)^3}{n} = \lim_{n \rightarrow \infty} \frac{3(\ln n)^2\left(\frac{1}{n}\right)}{1} = 3 \lim_{n \rightarrow \infty} \frac{(\ln n)^2}{n} = 3 \lim_{n \rightarrow \infty} \frac{2(\ln n)\left(\frac{1}{n}\right)}{1} = 6 \lim_{n \rightarrow \infty} \frac{\ln n}{n} \\ &= 6 \cdot 0 = 0 \end{aligned}$$

13. diverges by the Limit Comparison Test (part 3) with $\frac{1}{n}$, the n th term of the divergent harmonic series:

$$\lim_{n \rightarrow \infty} \frac{\left[\frac{1}{\sqrt{n} \ln n}\right]}{\left(\frac{1}{n}\right)} = \lim_{n \rightarrow \infty} \frac{\sqrt{n}}{\ln n} = \lim_{n \rightarrow \infty} \frac{\left(\frac{1}{2\sqrt{n}}\right)}{\left(\frac{1}{n}\right)} = \lim_{n \rightarrow \infty} \frac{\sqrt{n}}{2} = \infty$$

14. converges by the Limit Comparison Test (part 2) with $\frac{1}{n^{3/4}}$, the nth term of a convergent p-series:

$$\lim_{n \rightarrow \infty} \frac{\left[\frac{(\ln n)^2}{n^{3/2}}\right]}{\left(\frac{1}{n^{3/4}}\right)} = \lim_{n \rightarrow \infty} \frac{(\ln n)^2}{n^{1/4}} = \lim_{n \rightarrow \infty} \frac{\left(\frac{2 \ln n}{n}\right)}{\left(\frac{1}{4n^{3/4}}\right)} = 8 \lim_{n \rightarrow \infty} \frac{\ln n}{n^{1/4}} = 8 \lim_{n \rightarrow \infty} \frac{\left(\frac{1}{n}\right)}{\left(\frac{1}{4n^{3/4}}\right)} = 32 \lim_{n \rightarrow \infty} \frac{1}{n^{1/4}} = 32 \cdot 0 = 0$$

15. diverges by the Limit Comparison Test (part 3) with $\frac{1}{n}$, the nth term of the divergent harmonic series:

$$\lim_{n \rightarrow \infty} \frac{\left(\frac{1}{1 + \ln n}\right)}{\left(\frac{1}{n}\right)} = \lim_{n \rightarrow \infty} \frac{n}{1 + \ln n} = \lim_{n \rightarrow \infty} \frac{1}{\left(\frac{1}{n}\right)} = \lim_{n \rightarrow \infty} n = \infty$$

16. diverges by the Limit Comparison Test (part 3) with $\frac{1}{n}$, the nth term of the divergent harmonic series:

$$\lim_{n \rightarrow \infty} \frac{\left(\frac{1}{(1 + \ln n)^2}\right)}{\left(\frac{1}{n}\right)} = \lim_{n \rightarrow \infty} \frac{n}{(1 + \ln n)^2} = \lim_{n \rightarrow \infty} \frac{1}{\left[\frac{2(1 + \ln n)}{n}\right]} = \lim_{n \rightarrow \infty} \frac{n}{2(1 + \ln n)} = \lim_{n \rightarrow \infty} \frac{1}{\left(\frac{2}{n}\right)} = \lim_{n \rightarrow \infty} \frac{n}{2} = \infty$$

17. diverges by the Integral Test: $\int_2^{\infty} \frac{\ln(x+1)}{x+1} dx = \int_{\ln 3}^{\infty} u du = \lim_{b \rightarrow \infty} \left[\frac{1}{2} u^2\right]_{\ln 3}^b = \lim_{b \rightarrow \infty} \frac{1}{2} (b^2 - \ln^2 3) = \infty$

18. diverges by the Limit Comparison Test (part 3) with $\frac{1}{n}$, the nth term of the divergent harmonic series:

$$\lim_{n \rightarrow \infty} \frac{\left(\frac{1}{1 + \ln^2 n}\right)}{\left(\frac{1}{n}\right)} = \lim_{n \rightarrow \infty} \frac{n}{1 + \ln^2 n} = \lim_{n \rightarrow \infty} \frac{1}{\left(\frac{2 \ln n}{n}\right)} = \lim_{n \rightarrow \infty} \frac{n}{2 \ln n} = \lim_{n \rightarrow \infty} \frac{1}{\left(\frac{2}{n}\right)} = \lim_{n \rightarrow \infty} \frac{n}{2} = \infty$$

19. converges by the Direct Comparison Test with $\frac{1}{n^{3/2}}$, the nth term of a convergent p-series: $n^2 - 1 > n$ for $n \geq 2 \Rightarrow n^2(n^2 - 1) > n^3 \Rightarrow n\sqrt{n^2 - 1} > n^{3/2} \Rightarrow \frac{1}{n^{3/2}} > \frac{1}{n\sqrt{n^2 - 1}}$ or use Limit Comparison Test with $\frac{1}{n^2}$.

20. converges by the Direct Comparison Test with $\frac{1}{n^{3/2}}$, the nth term of a convergent p-series: $n^2 + 1 > n^2 \Rightarrow n^2 + 1 > \sqrt{n}n^{3/2} \Rightarrow \frac{n^2 + 1}{\sqrt{n}} > n^{3/2} \Rightarrow \frac{\sqrt{n}}{n^2 + 1} < \frac{1}{n^{3/2}}$ or use Limit Comparison Test with $\frac{1}{n^{3/2}}$.

21. converges because $\sum_{n=1}^{\infty} \frac{1-n}{n2^n} = \sum_{n=1}^{\infty} \frac{1}{n2^n} + \sum_{n=1}^{\infty} \frac{-1}{2^n}$ which is the sum of two convergent series:

$\sum_{n=1}^{\infty} \frac{1}{n2^n}$ converges by the Direct Comparison Test since $\frac{1}{n2^n} < \frac{1}{2^n}$, and $\sum_{n=1}^{\infty} \frac{-1}{2^n}$ is a convergent geometric series

22. converges by the Direct Comparison Test: $\sum_{n=1}^{\infty} \frac{n+2^n}{n^2 2^n} = \sum_{n=1}^{\infty} \left(\frac{1}{n2^n} + \frac{1}{n^2}\right)$ and $\frac{1}{n2^n} + \frac{1}{n^2} \leq \frac{1}{2^n} + \frac{1}{n^2}$, the sum of the nth terms of a convergent geometric series and a convergent p-series

23. converges by the Direct Comparison Test: $\frac{1}{3^{n-1} + 1} < \frac{1}{3^{n-1}}$, which is the nth term of a convergent geometric series

24. diverges; $\lim_{n \rightarrow \infty} \left(\frac{3^{n-1} + 1}{3^n}\right) = \lim_{n \rightarrow \infty} \left(\frac{1}{3} + \frac{1}{3^n}\right) = \frac{1}{3} \neq 0$

25. diverges by the Limit Comparison Test (part 1) with $\frac{1}{n}$, the nth term of the divergent harmonic series:

$$\lim_{n \rightarrow \infty} \frac{\left(\frac{\sin \frac{1}{n}}{\frac{1}{n}}\right)}{\left(\frac{1}{n}\right)} = \lim_{x \rightarrow 0} \frac{\sin x}{x} = 1$$

26. diverges by the Limit Comparison Test (part 1) with $\frac{1}{n}$, the n th term of the divergent harmonic series:

$$\lim_{n \rightarrow \infty} \frac{\left(\frac{\tan \frac{1}{n}}{\frac{1}{n}}\right)}{\left(\frac{1}{n}\right)} = \lim_{n \rightarrow \infty} \left(\frac{1}{\cos \frac{1}{n}}\right) \left(\frac{\sin \frac{1}{n}}{\frac{1}{n}}\right) = \lim_{x \rightarrow 0} \left(\frac{1}{\cos x}\right) \left(\frac{\sin x}{x}\right) = 1 \cdot 1 = 1$$

27. converges by the Limit Comparison Test (part 1) with $\frac{1}{n^2}$, the n th term of a convergent p -series:

$$\lim_{n \rightarrow \infty} \frac{\left(\frac{10n+1}{n(n+1)(n+2)}\right)}{\left(\frac{1}{n^2}\right)} = \lim_{n \rightarrow \infty} \frac{10n^2+n}{n^2+3n+2} = \lim_{n \rightarrow \infty} \frac{20n+1}{2n+3} = \lim_{n \rightarrow \infty} \frac{20}{2} = 10$$

28. converges by the Limit Comparison Test (part 1) with $\frac{1}{n^2}$, the n th term of a convergent p -series:

$$\lim_{n \rightarrow \infty} \frac{\left(\frac{5n^3-3n}{n^2(n-2)(n^2+5)}\right)}{\left(\frac{1}{n^2}\right)} = \lim_{n \rightarrow \infty} \frac{5n^3-3n}{n^3-2n^2+5n-10} = \lim_{n \rightarrow \infty} \frac{15n^2-3}{3n^2-4n+5} = \lim_{n \rightarrow \infty} \frac{30n}{6n-4} = 5$$

29. converges by the Direct Comparison Test: $\frac{\tan^{-1} n}{n^{1.1}} < \frac{\pi}{n^{1.1}}$ and $\sum_{n=1}^{\infty} \frac{\pi}{n^{1.1}} = \frac{\pi}{2} \sum_{n=1}^{\infty} \frac{1}{n^{1.1}}$ is the product of a convergent p -series and a nonzero constant

30. converges by the Direct Comparison Test: $\sec^{-1} n < \frac{\pi}{2} \Rightarrow \frac{\sec^{-1} n}{n^{1.3}} < \frac{(\frac{\pi}{2})}{n^{1.3}}$ and $\sum_{n=1}^{\infty} \frac{(\frac{\pi}{2})}{n^{1.3}} = \frac{\pi}{2} \sum_{n=1}^{\infty} \frac{1}{n^{1.3}}$ is the product of a convergent p -series and a nonzero constant

31. converges by the Limit Comparison Test (part 1) with $\frac{1}{n^2}$: $\lim_{n \rightarrow \infty} \frac{\left(\frac{\coth n}{n^2}\right)}{\left(\frac{1}{n^2}\right)} = \lim_{n \rightarrow \infty} \coth n = \lim_{n \rightarrow \infty} \frac{e^n + e^{-n}}{e^n - e^{-n}}$
 $= \lim_{n \rightarrow \infty} \frac{1 + e^{-2n}}{1 - e^{-2n}} = 1$

32. converges by the Limit Comparison Test (part 1) with $\frac{1}{n^2}$: $\lim_{n \rightarrow \infty} \frac{\left(\frac{\tanh n}{n^2}\right)}{\left(\frac{1}{n^2}\right)} = \lim_{n \rightarrow \infty} \tanh n = \lim_{n \rightarrow \infty} \frac{e^n - e^{-n}}{e^n + e^{-n}}$
 $= \lim_{n \rightarrow \infty} \frac{1 - e^{-2n}}{1 + e^{-2n}} = 1$

33. diverges by the Limit Comparison Test (part 1) with $\frac{1}{n}$: $\lim_{n \rightarrow \infty} \frac{\left(\frac{1}{n\sqrt[n]{n}}\right)}{\left(\frac{1}{n}\right)} = \lim_{n \rightarrow \infty} \frac{1}{\sqrt[n]{n}} = 1$.

34. converges by the Limit Comparison Test (part 1) with $\frac{1}{n^2}$: $\lim_{n \rightarrow \infty} \frac{\left(\frac{\sqrt[n]{n}}{n^2}\right)}{\left(\frac{1}{n^2}\right)} = \lim_{n \rightarrow \infty} \sqrt[n]{n} = 1$

35. $\frac{1}{1+2+3+\dots+n} = \frac{1}{\frac{n(n+1)}{2}} = \frac{2}{n(n+1)}$. The series converges by the Limit Comparison Test (part 1) with $\frac{1}{n^2}$:

$$\lim_{n \rightarrow \infty} \frac{\left(\frac{2}{n(n+1)}\right)}{\left(\frac{1}{n^2}\right)} = \lim_{n \rightarrow \infty} \frac{2n^2}{n^2+n} = \lim_{n \rightarrow \infty} \frac{4n}{2n+1} = \lim_{n \rightarrow \infty} \frac{4}{2} = 2.$$

36. $\frac{1}{1+2^2+3^2+\dots+n^2} = \frac{1}{\frac{n(n+1)(2n+1)}{6}} = \frac{6}{n(n+1)(2n+1)} \leq \frac{6}{n^3} \Rightarrow$ the series converges by the Direct Comparison Test

37. (a) If $\lim_{n \rightarrow \infty} \frac{a_n}{b_n} = 0$, then there exists an integer N such that for all $n > N$, $\left|\frac{a_n}{b_n} - 0\right| < 1 \Rightarrow -1 < \frac{a_n}{b_n} < 1 \Rightarrow a_n < b_n$. Thus, if $\sum b_n$ converges, then $\sum a_n$ converges by the Direct Comparison Test.

(b) If $\lim_{n \rightarrow \infty} \frac{a_n}{b_n} = \infty$, then there exists an integer N such that for all $n > N$, $\frac{a_n}{b_n} > 1 \Rightarrow a_n > b_n$. Thus, if $\sum b_n$ diverges, then $\sum a_n$ diverges by the Direct Comparison Test.

38. Yes, $\sum_{n=1}^{\infty} \frac{a_n}{n}$ converges by the Direct Comparison Test because $\frac{a_n}{n} < a_n$

39. $\lim_{n \rightarrow \infty} \frac{a_n}{b_n} = \infty \Rightarrow$ there exists an integer N such that for all $n > N$, $\frac{a_n}{b_n} > 1 \Rightarrow a_n > b_n$. If $\sum a_n$ converges, then $\sum b_n$ converges by the Direct Comparison Test

40. $\sum a_n$ converges $\Rightarrow \lim_{n \rightarrow \infty} a_n = 0 \Rightarrow$ there exists an integer N such that for all $n > N$, $0 \leq a_n < 1 \Rightarrow a_n^2 < a_n \Rightarrow \sum a_n^2$ converges by the Direct Comparison Test

41. Example CAS commands:

Maple:

```
a := n -> 1./n^3/sin(n)^2;
s := k -> sum( a(n), n=1..k );           # (a)
limit( s(k), k=infinity );
pts := [seq( [k,s(k)], k=1..100 )];     # (b)
plot( pts, style=point, title="#41(b) (Section 11.4) );
pts := [seq( [k,s(k)], k=1..200 )];     # (c)
plot( pts, style=point, title="#41(c) (Section 11.4) );
pts := [seq( [k,s(k)], k=1..400 )];     # (d)
plot( pts, style=point, title="#41(d) (Section 11.4) );
evalf( 355/113 );
```

Mathematica:

```
Clear[a, n, s, k, p]
a[n_]:= 1 / ( n^3 Sin[n]^2 )
s[k_]= Sum[ a[n], {n, 1, k}]
points[p_]:= Table[{k, N[s[k]]}, {k, 1, p}]
points[100]
ListPlot[points[100]]
points[200]
ListPlot[points[200]]
points[400]
ListPlot[points[400], PlotRange -> All]
```

To investigate what is happening around $k = 355$, you could do the following.

```
N[355/113]
N[ $\pi - 355/113$ ]
Sin[355]/N
a[355]/N
N[s[354]]
N[s[355]]
N[s[356]]
```

11.5 THE RATIO AND ROOT TESTS

1. converges by the Ratio Test: $\lim_{n \rightarrow \infty} \frac{a_{n+1}}{a_n} = \lim_{n \rightarrow \infty} \frac{\left[\frac{(n+1)\sqrt{2}}{2^{n+1}} \right]}{\left[\frac{n\sqrt{2}}{2^n} \right]} = \lim_{n \rightarrow \infty} \frac{(n+1)\sqrt{2}}{2^{n+1}} \cdot \frac{2^n}{n\sqrt{2}}$
 $= \lim_{n \rightarrow \infty} \left(1 + \frac{1}{n}\right) \sqrt{2} \left(\frac{1}{2}\right) = \frac{1}{2} < 1$
2. converges by the Ratio Test: $\lim_{n \rightarrow \infty} \frac{a_{n+1}}{a_n} = \lim_{n \rightarrow \infty} \frac{\left(\frac{(n+1)^2}{e^{n+1}}\right)}{\left(\frac{n^2}{e^n}\right)} = \lim_{n \rightarrow \infty} \frac{(n+1)^2}{e^{n+1}} \cdot \frac{e^n}{n^2} = \lim_{n \rightarrow \infty} \left(1 + \frac{1}{n}\right)^2 \left(\frac{1}{e}\right) = \frac{1}{e} < 1$
3. diverges by the Ratio Test: $\lim_{n \rightarrow \infty} \frac{a_{n+1}}{a_n} = \lim_{n \rightarrow \infty} \frac{\left(\frac{(n+1)!}{e^{n+1}}\right)}{\left(\frac{n!}{e^n}\right)} = \lim_{n \rightarrow \infty} \frac{(n+1)!}{e^{n+1}} \cdot \frac{e^n}{n!} = \lim_{n \rightarrow \infty} \frac{n+1}{e} = \infty$
4. diverges by the Ratio Test: $\lim_{n \rightarrow \infty} \frac{a_{n+1}}{a_n} = \lim_{n \rightarrow \infty} \frac{\left(\frac{(n+1)!}{10^{n+1}}\right)}{\left(\frac{n!}{10^n}\right)} = \lim_{n \rightarrow \infty} \frac{(n+1)!}{10^{n+1}} \cdot \frac{10^n}{n!} = \lim_{n \rightarrow \infty} \frac{n+1}{10} = \infty$
5. converges by the Ratio Test: $\lim_{n \rightarrow \infty} \frac{a_{n+1}}{a_n} = \lim_{n \rightarrow \infty} \frac{\left(\frac{(n+1)^{10}}{10^{n+1}}\right)}{\left(\frac{n^{10}}{10^n}\right)} = \lim_{n \rightarrow \infty} \frac{(n+1)^{10}}{10^{n+1}} \cdot \frac{10^n}{n^{10}} = \lim_{n \rightarrow \infty} \left(1 + \frac{1}{n}\right)^{10} \left(\frac{1}{10}\right)$
 $= \frac{1}{10} < 1$
6. diverges; $\lim_{n \rightarrow \infty} a_n = \lim_{n \rightarrow \infty} \left(\frac{n-2}{n}\right)^n = \lim_{n \rightarrow \infty} \left(1 + \frac{-2}{n}\right)^n = e^{-2} \neq 0$
7. converges by the Direct Comparison Test: $\frac{2+(-1)^n}{(1.25)^n} = \left(\frac{4}{5}\right)^n [2 + (-1)^n] \leq \left(\frac{4}{5}\right)^n (3)$ which is the n^{th} term of a convergent geometric series
8. converges; a geometric series with $|r| = \left|-\frac{2}{3}\right| < 1$
9. diverges; $\lim_{n \rightarrow \infty} a_n = \lim_{n \rightarrow \infty} \left(1 - \frac{3}{n}\right)^n = \lim_{n \rightarrow \infty} \left(1 + \frac{-3}{n}\right)^n = e^{-3} \approx 0.05 \neq 0$
10. diverges; $\lim_{n \rightarrow \infty} a_n = \lim_{n \rightarrow \infty} \left(1 - \frac{1}{3n}\right)^n = \lim_{n \rightarrow \infty} \left(1 + \frac{\left(-\frac{1}{3}\right)}{n}\right)^n = e^{-1/3} \approx 0.72 \neq 0$
11. converges by the Direct Comparison Test: $\frac{\ln n}{n^3} < \frac{n}{n^3} = \frac{1}{n^2}$ for $n \geq 2$, the n^{th} term of a convergent p -series.
12. converges by the n^{th} -Root Test: $\lim_{n \rightarrow \infty} \sqrt[n]{a_n} = \lim_{n \rightarrow \infty} \sqrt[n]{\frac{(\ln n)^n}{n^n}} = \lim_{n \rightarrow \infty} \frac{((\ln n)^n)^{1/n}}{(n^n)^{1/n}} = \lim_{n \rightarrow \infty} \frac{\ln n}{n}$
 $= \lim_{n \rightarrow \infty} \frac{\left(\frac{1}{n}\right)}{1} = 0 < 1$
13. diverges by the Direct Comparison Test: $\frac{1}{n} - \frac{1}{n^2} = \frac{n-1}{n^2} > \frac{1}{2} \left(\frac{1}{n}\right)$ for $n > 2$ or by the Limit Comparison Test (part 1) with $\frac{1}{n}$.
14. converges by the n^{th} -Root Test: $\lim_{n \rightarrow \infty} \sqrt[n]{a_n} = \lim_{n \rightarrow \infty} \sqrt[n]{\left(\frac{1}{n} - \frac{1}{n^2}\right)^n} = \lim_{n \rightarrow \infty} \left(\left(\frac{1}{n} - \frac{1}{n^2}\right)^n\right)^{1/n}$
 $= \lim_{n \rightarrow \infty} \left(\frac{1}{n} - \frac{1}{n^2}\right) = 0 < 1$

15. diverges by the Direct Comparison Test: $\frac{\ln n}{n} > \frac{1}{n}$ for $n \geq 3$
16. converges by the Ratio Test: $\lim_{n \rightarrow \infty} \frac{a_{n+1}}{a_n} = \lim_{n \rightarrow \infty} \frac{(n+1) \ln(n+1)}{2^{n+1}} \cdot \frac{2^n}{n \ln(n)} = \frac{1}{2} < 1$
17. converges by the Ratio Test: $\lim_{n \rightarrow \infty} \frac{a_{n+1}}{a_n} = \lim_{n \rightarrow \infty} \frac{(n+2)(n+3)}{(n+1)!} \cdot \frac{n!}{(n+1)(n+2)} = 0 < 1$
18. converges by the Ratio Test: $\lim_{n \rightarrow \infty} \frac{a_{n+1}}{a_n} = \lim_{n \rightarrow \infty} \frac{(n+1)^3}{e^{n+1}} \cdot \frac{e^n}{n^3} = \frac{1}{e} < 1$
19. converges by the Ratio Test: $\lim_{n \rightarrow \infty} \frac{a_{n+1}}{a_n} = \lim_{n \rightarrow \infty} \frac{(n+4)!}{3!(n+1)!3^{n+1}} \cdot \frac{3!n!3^n}{(n+3)!} = \lim_{n \rightarrow \infty} \frac{n+4}{3(n+1)} = \frac{1}{3} < 1$
20. converges by the Ratio Test: $\lim_{n \rightarrow \infty} \frac{a_{n+1}}{a_n} = \lim_{n \rightarrow \infty} \frac{(n+1)2^{n+1}(n+2)!}{3^{n+1}(n+1)!} \cdot \frac{3^n n!}{n2^n(n+1)!}$
 $= \lim_{n \rightarrow \infty} \left(\frac{n+1}{n}\right) \left(\frac{2}{3}\right) \left(\frac{n+2}{n+1}\right) = \frac{2}{3} < 1$
21. converges by the Ratio Test: $\lim_{n \rightarrow \infty} \frac{a_{n+1}}{a_n} = \lim_{n \rightarrow \infty} \frac{(n+1)!}{(2n+3)!} \cdot \frac{(2n+1)!}{n!} = \lim_{n \rightarrow \infty} \frac{n+1}{(2n+3)(2n+2)} = 0 < 1$
22. converges by the Ratio Test: $\lim_{n \rightarrow \infty} \frac{a_{n+1}}{a_n} = \lim_{n \rightarrow \infty} \frac{(n+1)!}{(n+1)^{n+1}} \cdot \frac{n^n}{n!} = \lim_{n \rightarrow \infty} \left(\frac{n}{n+1}\right)^n = \lim_{n \rightarrow \infty} \frac{1}{\left(\frac{n+1}{n}\right)^n}$
 $= \lim_{n \rightarrow \infty} \frac{1}{\left(1 + \frac{1}{n}\right)^n} = \frac{1}{e} < 1$
23. converges by the Root Test: $\lim_{n \rightarrow \infty} \sqrt[n]{a_n} = \lim_{n \rightarrow \infty} \sqrt[n]{\frac{n}{(\ln n)^n}} = \lim_{n \rightarrow \infty} \frac{\sqrt[n]{n}}{\ln n} = \lim_{n \rightarrow \infty} \frac{1}{\ln n} = 0 < 1$
24. converges by the Root Test: $\lim_{n \rightarrow \infty} \sqrt[n]{a_n} = \lim_{n \rightarrow \infty} \sqrt[n]{\frac{n}{(\ln n)^{n/2}}} = \lim_{n \rightarrow \infty} \frac{\sqrt[n]{n}}{\sqrt{\ln n}} = \frac{\lim_{n \rightarrow \infty} \sqrt[n]{n}}{\lim_{n \rightarrow \infty} \sqrt{\ln n}} = 0 < 1$
 $\left(\lim_{n \rightarrow \infty} \sqrt[n]{n} = 1\right)$
25. converges by the Direct Comparison Test: $\frac{n! \ln n}{n(n+2)!} = \frac{\ln n}{n(n+1)(n+2)} < \frac{n}{n(n+1)(n+2)} = \frac{1}{(n+1)(n+2)} < \frac{1}{n^2}$
 which is the n th-term of a convergent p -series
26. diverges by the Ratio Test: $\lim_{n \rightarrow \infty} \frac{a_{n+1}}{a_n} = \lim_{n \rightarrow \infty} \frac{3^{n+1}}{(n+1)^2 2^{n+1}} \cdot \frac{n^2 2^n}{3^n} = \lim_{n \rightarrow \infty} \frac{n^2}{(n+1)^3} \left(\frac{3}{2}\right) = \frac{3}{2} > 1$
27. converges by the Ratio Test: $\lim_{n \rightarrow \infty} \frac{a_{n+1}}{a_n} = \lim_{n \rightarrow \infty} \frac{\left(\frac{1+\sin n}{n}\right) a_n}{a_n} = 0 < 1$
28. converges by the Ratio Test: $\lim_{n \rightarrow \infty} \frac{a_{n+1}}{a_n} = \lim_{n \rightarrow \infty} \frac{\left(\frac{1+\tan^{-1} n}{n}\right) a_n}{a_n} = \lim_{n \rightarrow \infty} \frac{1+\tan^{-1} n}{n} = 0$ since the numerator approaches $1 + \frac{\pi}{2}$ while the denominator tends to ∞
29. diverges by the Ratio Test: $\lim_{n \rightarrow \infty} \frac{a_{n+1}}{a_n} = \lim_{n \rightarrow \infty} \frac{\left(\frac{3n-1}{2n+1}\right) a_n}{a_n} = \lim_{n \rightarrow \infty} \frac{3n-1}{2n+1} = \frac{3}{2} > 1$
30. diverges; $a_{n+1} = \frac{n}{n+1} a_n \Rightarrow a_{n+1} = \left(\frac{n}{n+1}\right) \left(\frac{n-1}{n}\right) a_{n-1} \Rightarrow a_{n+1} = \left(\frac{n}{n+1}\right) \left(\frac{n-1}{n}\right) \left(\frac{n-2}{n-1}\right) a_{n-2}$
 $\Rightarrow a_{n+1} = \left(\frac{n}{n+1}\right) \left(\frac{n-1}{n}\right) \left(\frac{n-2}{n-1}\right) \cdots \left(\frac{1}{2}\right) a_1 \Rightarrow a_{n+1} = \frac{a_1}{n+1} \Rightarrow a_{n+1} = \frac{3}{n+1}$, which is a constant times the general term of the diverging harmonic series
31. converges by the Ratio Test: $\lim_{n \rightarrow \infty} \frac{a_{n+1}}{a_n} = \lim_{n \rightarrow \infty} \frac{\left(\frac{2}{n}\right) a_n}{a_n} = \lim_{n \rightarrow \infty} \frac{2}{n} = 0 < 1$

32. converges by the Ratio Test: $\lim_{n \rightarrow \infty} \frac{a_{n+1}}{a_n} = \lim_{n \rightarrow \infty} \frac{\left(\frac{\sqrt[n]{n}}{2}\right)^{a_n}}{a_n} = \lim_{n \rightarrow \infty} \frac{\sqrt[n]{n}}{2} = \frac{1}{2} < 1$

33. converges by the Ratio Test: $\lim_{n \rightarrow \infty} \frac{a_{n+1}}{a_n} = \lim_{n \rightarrow \infty} \frac{\left(\frac{1+\ln n}{n}\right)^{a_n}}{a_n} = \lim_{n \rightarrow \infty} \frac{1+\ln n}{n} = \lim_{n \rightarrow \infty} \frac{1}{n} = 0 < 1$

34. $\frac{n+\ln n}{n+10} > 0$ and $a_1 = \frac{1}{2} \Rightarrow a_n > 0$; $\ln n > 10$ for $n > e^{10} \Rightarrow n + \ln n > n + 10 \Rightarrow \frac{n+\ln n}{n+10} > 1$
 $\Rightarrow a_{n+1} = \frac{n+\ln n}{n+10} a_n > a_n$; thus $a_{n+1} > a_n \geq \frac{1}{2} \Rightarrow \lim_{n \rightarrow \infty} a_n \neq 0$, so the series diverges by the nth-Term Test

35. diverges by the nth-Term Test: $a_1 = \frac{1}{3}$, $a_2 = \sqrt{\frac{1}{3}}$, $a_3 = \sqrt[3]{\sqrt{\frac{1}{3}}} = \sqrt[6]{\frac{1}{3}}$, $a_4 = \sqrt[4]{\sqrt[3]{\sqrt{\frac{1}{3}}}} = \sqrt[12]{\frac{1}{3}}$, ... ,
 $a_n = \sqrt[n]{\frac{1}{3}} \Rightarrow \lim_{n \rightarrow \infty} a_n = 1$ because $\left\{\sqrt[n]{\frac{1}{3}}\right\}$ is a subsequence of $\left\{\sqrt[n]{\frac{1}{3}}\right\}$ whose limit is 1 by Table 8.1

36. converges by the Direct Comparison Test: $a_1 = \frac{1}{2}$, $a_2 = \left(\frac{1}{2}\right)^2$, $a_3 = \left(\left(\frac{1}{2}\right)^2\right)^3 = \left(\frac{1}{2}\right)^6$, $a_4 = \left(\left(\frac{1}{2}\right)^6\right)^4 = \left(\frac{1}{2}\right)^{24}$, ...
 $\Rightarrow a_n = \left(\frac{1}{2}\right)^{n!} < \left(\frac{1}{2}\right)^n$ which is the nth-term of a convergent geometric series

37. converges by the Ratio Test: $\lim_{n \rightarrow \infty} \frac{a_{n+1}}{a_n} = \lim_{n \rightarrow \infty} \frac{2^{n+1}(n+1)(n+1)! \cdot (2n)!}{(2n+2)! \cdot 2^{2n} n!} = \lim_{n \rightarrow \infty} \frac{2(n+1)(n+1)}{(2n+2)(2n+1)}$
 $= \lim_{n \rightarrow \infty} \frac{n+1}{2n+1} = \frac{1}{2} < 1$

38. diverges by the Ratio Test: $\lim_{n \rightarrow \infty} \frac{a_{n+1}}{a_n} = \lim_{n \rightarrow \infty} \frac{(3n+3)!}{(n+1)!(n+2)!(n+3)!} \cdot \frac{n!(n+1)!(n+2)!}{(3n)!}$
 $= \lim_{n \rightarrow \infty} \frac{(3n+3)(3+2)(3n+1)}{(n+1)(n+2)(n+3)} = \lim_{n \rightarrow \infty} 3 \left(\frac{3n+2}{n+2}\right) \left(\frac{3n+1}{n+3}\right) = 3 \cdot 3 \cdot 3 = 27 > 1$

39. diverges by the Root Test: $\lim_{n \rightarrow \infty} \sqrt[n]{a_n} = \lim_{n \rightarrow \infty} \sqrt[n]{\frac{(n!)^n}{(n^n)^2}} = \lim_{n \rightarrow \infty} \frac{n!}{n^2} = \infty > 1$

40. converges by the Root Test: $\lim_{n \rightarrow \infty} \sqrt[n]{\frac{(n!)^n}{n^{n^2}}} = \lim_{n \rightarrow \infty} \sqrt[n]{\frac{(n!)^n}{(n^n)^2}} = \lim_{n \rightarrow \infty} \frac{n!}{n^2} = \lim_{n \rightarrow \infty} \left(\frac{1}{n}\right) \left(\frac{2}{n}\right) \left(\frac{3}{n}\right) \cdots \left(\frac{n-1}{n}\right) \left(\frac{n}{n}\right)$
 $\leq \lim_{n \rightarrow \infty} \frac{1}{n} = 0 < 1$

41. converges by the Root Test: $\lim_{n \rightarrow \infty} \sqrt[n]{a_n} = \lim_{n \rightarrow \infty} \sqrt[n]{\frac{n^n}{2n^2}} = \lim_{n \rightarrow \infty} \frac{n}{2^n} = \lim_{n \rightarrow \infty} \frac{1}{2^{n \ln 2}} = 0 < 1$

42. diverges by the Root Test: $\lim_{n \rightarrow \infty} \sqrt[n]{a_n} = \lim_{n \rightarrow \infty} \sqrt[n]{\frac{n^n}{(2^n)^2}} = \lim_{n \rightarrow \infty} \frac{n}{4} = \infty > 1$

43. converges by the Ratio Test: $\lim_{n \rightarrow \infty} \frac{a_{n+1}}{a_n} = \lim_{n \rightarrow \infty} \frac{1 \cdot 3 \cdots (2n-1)(2n+1)}{4^{n+1} 2^{n+1} (n+1)!} \cdot \frac{4^n 2^n n!}{1 \cdot 3 \cdots (2n-1)}$
 $= \lim_{n \rightarrow \infty} \frac{2n+1}{(4 \cdot 2)(n+1)} = \frac{1}{4} < 1$

44. converges by the Ratio Test: $a_n = \frac{1 \cdot 3 \cdots (2n-1)}{(2 \cdot 4 \cdots 2n)(3^n+1)} = \frac{1 \cdot 2 \cdot 3 \cdot 4 \cdots (2n-1)(2n)}{(2 \cdot 4 \cdots 2n)^2 (3^n+1)} = \frac{(2n)!}{(2^n n!)^2 (3^n+1)}$
 $\Rightarrow \lim_{n \rightarrow \infty} \frac{(2n+2)!}{[2^{n+1}(n+1)!]^2 (3^{n+1}+1)} \cdot \frac{(2n)!}{(2n)!} = \lim_{n \rightarrow \infty} \frac{(2n+1)(2n+2)(3^n+1)}{2^2(n+1)^2 (3^{n+1}+1)}$
 $= \lim_{n \rightarrow \infty} \left(\frac{4n^2+6n+2}{4n^2+8n+4}\right) \left(\frac{1+3^{-n}}{3+3^{-n}}\right) = 1 \cdot \frac{1}{3} = \frac{1}{3} < 1$

45. Ratio: $\lim_{n \rightarrow \infty} \frac{a_{n+1}}{a_n} = \lim_{n \rightarrow \infty} \frac{1}{(n+1)^p} \cdot \frac{n^p}{1} = \lim_{n \rightarrow \infty} \left(\frac{n}{n+1}\right)^p = 1^p = 1 \Rightarrow$ no conclusion

Root: $\lim_{n \rightarrow \infty} \sqrt[n]{a_n} = \lim_{n \rightarrow \infty} \sqrt[n]{\frac{1}{n^p}} = \lim_{n \rightarrow \infty} \frac{1}{(\sqrt[n]{n})^p} = \frac{1}{(1)^p} = 1 \Rightarrow$ no conclusion

$$46. \text{ Ratio: } \lim_{n \rightarrow \infty} \frac{a_{n+1}}{a_n} = \lim_{n \rightarrow \infty} \frac{1}{(\ln(n+1))^p} \cdot \frac{(\ln n)^p}{1} = \left[\lim_{n \rightarrow \infty} \frac{\ln n}{\ln(n+1)} \right]^p = \left[\lim_{n \rightarrow \infty} \frac{\left(\frac{1}{n}\right)}{\left(\frac{1}{n+1}\right)} \right]^p = \left(\lim_{n \rightarrow \infty} \frac{n+1}{n} \right)^p = (1)^p = 1 \Rightarrow \text{no conclusion}$$

$$\text{Root: } \lim_{n \rightarrow \infty} \sqrt[n]{a_n} = \lim_{n \rightarrow \infty} \sqrt[n]{\frac{1}{(\ln n)^p}} = \frac{1}{\left(\lim_{n \rightarrow \infty} (\ln n)^{1/n} \right)^p}; \text{ let } f(n) = (\ln n)^{1/n}, \text{ then } \ln f(n) = \frac{\ln(\ln n)}{n}$$

$$\Rightarrow \lim_{n \rightarrow \infty} \ln f(n) = \lim_{n \rightarrow \infty} \frac{\ln(\ln n)}{n} = \lim_{n \rightarrow \infty} \frac{\left(\frac{1}{n \ln n}\right)}{1} = \lim_{n \rightarrow \infty} \frac{1}{n \ln n} = 0 \Rightarrow \lim_{n \rightarrow \infty} (\ln n)^{1/n} = e^0 = 1$$

$$\Rightarrow \lim_{n \rightarrow \infty} \sqrt[n]{a_n} = \frac{1}{(1)^p} = 1 \Rightarrow \text{no conclusion}$$

$$47. a_n \leq \frac{n}{2^n} \text{ for every } n \text{ and the series } \sum_{n=1}^{\infty} \frac{n}{2^n} \text{ converges by the Ratio Test since } \lim_{n \rightarrow \infty} \frac{(n+1)}{2^{n+1}} \cdot \frac{2^n}{n} = \frac{1}{2} < 1$$

$$\Rightarrow \sum_{n=1}^{\infty} a_n \text{ converges by the Direct Comparison Test}$$

11.6 ALTERNATING SERIES, ABSOLUTE AND CONDITIONAL CONVERGENCE

- converges absolutely \Rightarrow converges by the Absolute Convergence Test since $\sum_{n=1}^{\infty} |a_n| = \sum_{n=1}^{\infty} \frac{1}{n^2}$ which is a convergent p-series
- converges absolutely \Rightarrow converges by the Absolute Convergence Test since $\sum_{n=1}^{\infty} |a_n| = \sum_{n=1}^{\infty} \frac{1}{n^{3/2}}$ which is a convergent p-series
- diverges by the nth-Term Test since for $n > 10 \Rightarrow \frac{n}{10} > 1 \Rightarrow \lim_{n \rightarrow \infty} \left(\frac{n}{10}\right)^n \neq 0 \Rightarrow \sum_{n=1}^{\infty} (-1)^{n+1} \left(\frac{n}{10}\right)^n$ diverges
- diverges by the nth-Term Test since $\lim_{n \rightarrow \infty} \frac{10^n}{n^{10}} = \lim_{n \rightarrow \infty} \frac{10^n (\ln 10)^{10}}{10!} = \infty$ (after 10 applications of L'Hôpital's rule)
- converges by the Alternating Series Test because $f(x) = \ln x$ is an increasing function of $x \Rightarrow \frac{1}{\ln x}$ is decreasing $\Rightarrow u_n \geq u_{n+1}$ for $n \geq 1$; also $u_n \geq 0$ for $n \geq 1$ and $\lim_{n \rightarrow \infty} \frac{1}{\ln n} = 0$
- converges by the Alternating Series Test since $f(x) = \frac{\ln x}{x} \Rightarrow f'(x) = \frac{1 - \ln x}{x^2} < 0$ when $x > e \Rightarrow f(x)$ is decreasing $\Rightarrow u_n \geq u_{n+1}$; also $u_n \geq 0$ for $n \geq 1$ and $\lim_{n \rightarrow \infty} u_n = \lim_{n \rightarrow \infty} \frac{\ln n}{n} = \lim_{n \rightarrow \infty} \frac{\left(\frac{1}{n}\right)}{1} = 0$
- diverges by the nth-Term Test since $\lim_{n \rightarrow \infty} \frac{\ln n}{\ln n^2} = \lim_{n \rightarrow \infty} \frac{\ln n}{2 \ln n} = \lim_{n \rightarrow \infty} \frac{1}{2} = \frac{1}{2} \neq 0$
- converges by the Alternating Series Test since $f(x) = \ln(1 + x^{-1}) \Rightarrow f'(x) = \frac{-1}{x(x+1)} < 0$ for $x > 0 \Rightarrow f(x)$ is decreasing $\Rightarrow u_n \geq u_{n+1}$; also $u_n \geq 0$ for $n \geq 1$ and $\lim_{n \rightarrow \infty} u_n = \lim_{n \rightarrow \infty} \ln\left(1 + \frac{1}{n}\right) = \ln\left(\lim_{n \rightarrow \infty} \left(1 + \frac{1}{n}\right)\right) = \ln 1 = 0$
- converges by the Alternating Series Test since $f(x) = \frac{\sqrt{x}+1}{x+1} \Rightarrow f'(x) = \frac{1-x-2\sqrt{x}}{2\sqrt{x}(x+1)^2} < 0 \Rightarrow f(x)$ is decreasing $\Rightarrow u_n \geq u_{n+1}$; also $u_n \geq 0$ for $n \geq 1$ and $\lim_{n \rightarrow \infty} u_n = \lim_{n \rightarrow \infty} \frac{\sqrt{n}+1}{n+1} = 0$
- diverges by the nth-Term Test since $\lim_{n \rightarrow \infty} \frac{3\sqrt{n+1}}{\sqrt{n+1}} = \lim_{n \rightarrow \infty} \frac{3\sqrt{1+\frac{1}{n}}}{1+\left(\frac{1}{\sqrt{n}}\right)} = 3 \neq 0$

11. converges absolutely since $\sum_{n=1}^{\infty} |a_n| = \sum_{n=1}^{\infty} \left(\frac{1}{10}\right)^n$ a convergent geometric series
12. converges absolutely by the Direct Comparison Test since $\left|\frac{(-1)^{n+1}(0.1)^n}{n}\right| = \frac{1}{(10)^{n+1}} < \left(\frac{1}{10}\right)^n$ which is the n th term of a convergent geometric series
13. converges conditionally since $\frac{1}{\sqrt{n}} > \frac{1}{\sqrt{n+1}} > 0$ and $\lim_{n \rightarrow \infty} \frac{1}{\sqrt{n}} = 0 \Rightarrow$ convergence; but $\sum_{n=1}^{\infty} |a_n| = \sum_{n=1}^{\infty} \frac{1}{n^{1/2}}$ is a divergent p -series
14. converges conditionally since $\frac{1}{1+\sqrt{n}} > \frac{1}{1+\sqrt{n+1}} > 0$ and $\lim_{n \rightarrow \infty} \frac{1}{1+\sqrt{n}} = 0 \Rightarrow$ convergence; but $\sum_{n=1}^{\infty} |a_n| = \sum_{n=1}^{\infty} \frac{1}{1+\sqrt{n}}$ is a divergent series since $\frac{1}{1+\sqrt{n}} \geq \frac{1}{2\sqrt{n}}$ and $\sum_{n=1}^{\infty} \frac{1}{n^{1/2}}$ is a divergent p -series
15. converges absolutely since $\sum_{n=1}^{\infty} |a_n| = \sum_{n=1}^{\infty} \frac{n}{n^3+1}$ and $\frac{n}{n^3+1} < \frac{1}{n^2}$ which is the n th-term of a converging p -series
16. diverges by the n th-Term Test since $\lim_{n \rightarrow \infty} \frac{n!}{2^n} = \infty$
17. converges conditionally since $\frac{1}{n+3} > \frac{1}{(n+1)+3} > 0$ and $\lim_{n \rightarrow \infty} \frac{1}{n+3} = 0 \Rightarrow$ convergence; but $\sum_{n=1}^{\infty} |a_n| = \sum_{n=1}^{\infty} \frac{1}{n+3}$ diverges because $\frac{1}{n+3} \geq \frac{1}{4n}$ and $\sum_{n=1}^{\infty} \frac{1}{n}$ is a divergent series
18. converges absolutely because the series $\sum_{n=1}^{\infty} \left|\frac{\sin n}{n^2}\right|$ converges by the Direct Comparison Test since $\left|\frac{\sin n}{n^2}\right| \leq \frac{1}{n^2}$
19. diverges by the n th-Term Test since $\lim_{n \rightarrow \infty} \frac{3+n}{5+n} = 1 \neq 0$
20. converges conditionally since $f(x) = \ln x$ is an increasing function of $x \Rightarrow \frac{1}{3 \ln x} = \frac{1}{\ln(x^3)}$ is decreasing
 $\Rightarrow \frac{1}{3 \ln n} > \frac{1}{3 \ln(n+1)} > 0$ for $n \geq 2$ and $\lim_{n \rightarrow \infty} \frac{1}{3 \ln n} = 0 \Rightarrow$ convergence; but $\sum_{n=2}^{\infty} |a_n| = \sum_{n=2}^{\infty} \frac{1}{\ln(n^3)}$
 $= \sum_{n=2}^{\infty} \frac{1}{3 \ln n}$ diverges because $\frac{1}{3 \ln n} > \frac{1}{3n}$ and $\sum_{n=2}^{\infty} \frac{1}{n}$ diverges
21. converges conditionally since $f(x) = \frac{1}{x^2} + \frac{1}{x} \Rightarrow f'(x) = -\left(\frac{2}{x^3} + \frac{1}{x^2}\right) < 0 \Rightarrow f(x)$ is decreasing and hence $u_n > u_{n+1} > 0$ for $n \geq 1$ and $\lim_{n \rightarrow \infty} \left(\frac{1}{n^2} + \frac{1}{n}\right) = 0 \Rightarrow$ convergence; but $\sum_{n=1}^{\infty} |a_n| = \sum_{n=1}^{\infty} \frac{1+n}{n^2}$
 $= \sum_{n=1}^{\infty} \frac{1}{n^2} + \sum_{n=1}^{\infty} \frac{1}{n}$ is the sum of a convergent and divergent series, and hence diverges
22. converges absolutely by the Direct Comparison Test since $\left|\frac{(-2)^{n+1}}{n+5^n}\right| = \frac{2^{n+1}}{n+5^n} < 2\left(\frac{2}{5}\right)^n$ which is the n th term of a convergent geometric series
23. converges absolutely by the Ratio Test: $\lim_{n \rightarrow \infty} \left(\frac{u_{n+1}}{u_n}\right) = \lim_{n \rightarrow \infty} \left[\frac{(n+1)^2 \left(\frac{2}{3}\right)^{n+1}}{n^2 \left(\frac{2}{3}\right)^n}\right] = \frac{2}{3} < 1$
24. diverges by the n th-Term Test since $\lim_{n \rightarrow \infty} a_n = \lim_{n \rightarrow \infty} 10^{1/n} = 1 \neq 0$

25. converges absolutely by the Integral Test since $\int_1^\infty (\tan^{-1} x) \left(\frac{1}{1+x^2}\right) dx = \lim_{b \rightarrow \infty} \left[\frac{(\tan^{-1} x)^2}{2}\right]_1^b$
 $= \lim_{b \rightarrow \infty} \left[(\tan^{-1} b)^2 - (\tan^{-1} 1)^2\right] = \frac{1}{2} \left[\left(\frac{\pi}{2}\right)^2 - \left(\frac{\pi}{4}\right)^2\right] = \frac{3\pi^2}{32}$
26. converges conditionally since $f(x) = \frac{1}{x \ln x} \Rightarrow f'(x) = -\frac{[\ln(x)+1]}{(x \ln x)^2} < 0 \Rightarrow f(x)$ is decreasing
 $\Rightarrow u_n > u_{n+1} > 0$ for $n \geq 2$ and $\lim_{n \rightarrow \infty} \frac{1}{n \ln n} = 0 \Rightarrow$ convergence; but by the Integral Test,
 $\int_2^\infty \frac{dx}{x \ln x} = \lim_{b \rightarrow \infty} \int_2^b \left(\frac{\frac{1}{x}}{\ln x}\right) dx = \lim_{b \rightarrow \infty} [\ln(\ln x)]_2^b = \lim_{b \rightarrow \infty} [\ln(\ln b) - \ln(\ln 2)] = \infty$
 $\Rightarrow \sum_{n=1}^\infty |a_n| = \sum_{n=1}^\infty \frac{1}{n \ln n}$ diverges
27. diverges by the n th-Term Test since $\lim_{n \rightarrow \infty} \frac{n}{n+1} = 1 \neq 0$
28. converges conditionally since $f(x) = \frac{\ln x}{x - \ln x} \Rightarrow f'(x) = \frac{\left(\frac{1}{x}\right)(x - \ln x) - (\ln x)\left(1 - \frac{1}{x}\right)}{(x - \ln x)^2}$
 $= \frac{1 - \left(\frac{\ln x}{x}\right) - \ln x + \left(\frac{\ln x}{x}\right)}{(x - \ln x)^2} = \frac{1 - \ln x}{(x - \ln x)^2} < 0 \Rightarrow u_n \geq u_{n+1} > 0$ when $n > e$ and $\lim_{n \rightarrow \infty} \frac{\ln n}{n - \ln n}$
 $= \lim_{n \rightarrow \infty} \frac{\left(\frac{1}{n}\right)}{1 - \left(\frac{1}{n}\right)} = 0 \Rightarrow$ convergence; but $n - \ln n < n \Rightarrow \frac{1}{n - \ln n} > \frac{1}{n} \Rightarrow \frac{\ln n}{n - \ln n} > \frac{1}{n}$ so that
 $\sum_{n=1}^\infty |a_n| = \sum_{n=1}^\infty \frac{\ln n}{n - \ln n}$ diverges by the Direct Comparison Test
29. converges absolutely by the Ratio Test: $\lim_{n \rightarrow \infty} \left(\frac{u_{n+1}}{u_n}\right) = \lim_{n \rightarrow \infty} \frac{(100)^{n+1}}{(n+1)!} \cdot \frac{n!}{(100)^n} = \lim_{n \rightarrow \infty} \frac{100}{n+1} = 0 < 1$
30. converges absolutely since $\sum_{n=1}^\infty |a_n| = \sum_{n=1}^\infty \left(\frac{1}{5}\right)^n$ is a convergent geometric series
31. converges absolutely by the Direct Comparison Test since $\sum_{n=1}^\infty |a_n| = \sum_{n=1}^\infty \frac{1}{n^2 + 2n + 1}$ and
 $\frac{1}{n^2 + 2n + 1} < \frac{1}{n^2}$ which is the n th-term of a convergent p -series
32. converges absolutely since $\sum_{n=1}^\infty |a_n| = \sum_{n=1}^\infty \left(\frac{\ln n}{\ln n^2}\right)^n = \sum_{n=1}^\infty \left(\frac{\ln n}{2 \ln n}\right)^n = \sum_{n=1}^\infty \left(\frac{1}{2}\right)^n$ is a convergent
 geometric series
33. converges absolutely since $\sum_{n=1}^\infty |a_n| = \sum_{n=1}^\infty \left|\frac{(-1)^n}{n\sqrt{n}}\right| = \sum_{n=1}^\infty \frac{1}{n^{3/2}}$ is a convergent p -series
34. converges conditionally since $\sum_{n=1}^\infty \frac{\cos n\pi}{n} = \sum_{n=1}^\infty \frac{(-1)^n}{n}$ is the convergent alternating harmonic series, but
 $\sum_{n=1}^\infty |a_n| = \sum_{n=1}^\infty \frac{1}{n}$ diverges
35. converges absolutely by the Root Test: $\lim_{n \rightarrow \infty} \sqrt[n]{|a_n|} = \lim_{n \rightarrow \infty} \left(\frac{(n+1)^n}{(2n)^n}\right)^{1/n} = \lim_{n \rightarrow \infty} \frac{n+1}{2n} = \frac{1}{2} < 1$
36. converges absolutely by the Ratio Test: $\lim_{n \rightarrow \infty} \left|\frac{a_{n+1}}{a_n}\right| = \lim_{n \rightarrow \infty} \frac{(n+1)!^2}{(2n+2)!} \cdot \frac{(2n)!}{(n!)^2} = \lim_{n \rightarrow \infty} \frac{(n+1)^2}{(2n+2)(2n+1)} = \frac{1}{4} < 1$

37. diverges by the nth-Term Test since $\lim_{n \rightarrow \infty} |a_n| = \lim_{n \rightarrow \infty} \frac{(2n)!}{2^n n! n} = \lim_{n \rightarrow \infty} \frac{(n+1)(n+2) \cdots (2n)}{2^n}$
 $= \lim_{n \rightarrow \infty} \frac{(n+1)(n+2) \cdots (n+(n-1))}{2^{n-1}} > \lim_{n \rightarrow \infty} \left(\frac{n+1}{2}\right)^{n-1} = \infty \neq 0$

38. converges absolutely by the Ratio Test: $\lim_{n \rightarrow \infty} \left| \frac{a_{n+1}}{a_n} \right| = \lim_{n \rightarrow \infty} \frac{(n+1)!(n+1)! 3^{n+1}}{(2n+3)!} \cdot \frac{(2n+1)!}{n! n! 3^n}$
 $= \lim_{n \rightarrow \infty} \frac{(n+1)^2 3}{(2n+2)(2n+3)} = \frac{3}{4} < 1$

39. converges conditionally since $\frac{\sqrt{n+1}-\sqrt{n}}{1} \cdot \frac{\sqrt{n+1}+\sqrt{n}}{\sqrt{n+1}+\sqrt{n}} = \frac{1}{\sqrt{n+1}+\sqrt{n}}$ and $\left\{ \frac{1}{\sqrt{n+1}+\sqrt{n}} \right\}$ is a decreasing sequence of positive terms which converges to 0 $\Rightarrow \sum_{n=1}^{\infty} \frac{(-1)^n}{\sqrt{n+1}+\sqrt{n}}$ converges; but

$\sum_{n=1}^{\infty} |a_n| = \sum_{n=1}^{\infty} \frac{1}{\sqrt{n+1}+\sqrt{n}}$ diverges by the Limit Comparison Test (part 1) with $\frac{1}{\sqrt{n}}$; a divergent p-series:

$\lim_{n \rightarrow \infty} \left(\frac{\frac{1}{\sqrt{n+1}+\sqrt{n}}}{\frac{1}{\sqrt{n}}} \right) = \lim_{n \rightarrow \infty} \frac{\sqrt{n}}{\sqrt{n+1}+\sqrt{n}} = \lim_{n \rightarrow \infty} \frac{1}{\sqrt{1+\frac{1}{n}}+1} = \frac{1}{2}$

40. diverges by the nth-Term Test since $\lim_{n \rightarrow \infty} (\sqrt{n^2+n}-n) = \lim_{n \rightarrow \infty} (\sqrt{n^2+n}-n) \cdot \left(\frac{\sqrt{n^2+n+n}}{\sqrt{n^2+n+n}} \right)$
 $= \lim_{n \rightarrow \infty} \frac{n}{\sqrt{n^2+n+n}} = \lim_{n \rightarrow \infty} \frac{1}{\sqrt{1+\frac{1}{n}}+1} = \frac{1}{2} \neq 0$

41. diverges by the nth-Term Test since $\lim_{n \rightarrow \infty} (\sqrt{n+\sqrt{n}}-\sqrt{n}) = \lim_{n \rightarrow \infty} \left[(\sqrt{n+\sqrt{n}}-\sqrt{n}) \left(\frac{\sqrt{n+\sqrt{n}}+\sqrt{n}}{\sqrt{n+\sqrt{n}}+\sqrt{n}} \right) \right]$
 $= \lim_{n \rightarrow \infty} \frac{\sqrt{n}}{\sqrt{n+\sqrt{n}}+\sqrt{n}} = \lim_{n \rightarrow \infty} \frac{1}{\sqrt{1+\frac{1}{\sqrt{n}}}+1} = \frac{1}{2} \neq 0$

42. converges conditionally since $\left\{ \frac{1}{\sqrt{n}+\sqrt{n+1}} \right\}$ is a decreasing sequence of positive terms converging to 0

$\Rightarrow \sum_{n=1}^{\infty} \frac{(-1)^n}{\sqrt{n}+\sqrt{n+1}}$ converges; but $\lim_{n \rightarrow \infty} \frac{\left(\frac{1}{\sqrt{n}+\sqrt{n+1}} \right)}{\left(\frac{1}{\sqrt{n}} \right)} = \lim_{n \rightarrow \infty} \frac{\sqrt{n}}{\sqrt{n}+\sqrt{n+1}} = \lim_{n \rightarrow \infty} \frac{1}{1+\sqrt{1+\frac{1}{n}}} = \frac{1}{2}$

so that $\sum_{n=1}^{\infty} \frac{1}{\sqrt{n}+\sqrt{n+1}}$ diverges by the Limit Comparison Test with $\sum_{n=1}^{\infty} \frac{1}{\sqrt{n}}$ which is a divergent p-series

43. converges absolutely by the Direct Comparison Test since $\operatorname{sech}(n) = \frac{2}{e^n+e^{-n}} = \frac{2e^n}{e^{2n}+1} < \frac{2e^n}{e^{2n}} = \frac{2}{e^n}$ which is the nth term of a convergent geometric series

44. converges absolutely by the Limit Comparison Test (part 1): $\sum_{n=1}^{\infty} |a_n| = \sum_{n=1}^{\infty} \frac{2}{e^n-e^{-n}}$

Apply the Limit Comparison Test with $\frac{1}{e^n}$, the n-th term of a convergent geometric series:

$\lim_{n \rightarrow \infty} \left(\frac{\frac{2}{e^n-e^{-n}}}{\frac{1}{e^n}} \right) = \lim_{n \rightarrow \infty} \frac{2e^n}{e^n-e^{-n}} = \lim_{n \rightarrow \infty} \frac{2}{1-e^{-2n}} = 2$

45. $|\text{error}| < \left| (-1)^6 \left(\frac{1}{5} \right) \right| = 0.2$

46. $|\text{error}| < \left| (-1)^6 \left(\frac{1}{10^6} \right) \right| = 0.00001$

47. $|\text{error}| < \left| (-1)^6 \frac{(0.01)^5}{5} \right| = 2 \times 10^{-11}$

48. $|\text{error}| < |(-1)^4 t^4| = t^4 < 1$

49. $\frac{1}{(2n)!} < \frac{5}{10^6} \Rightarrow (2n)! > \frac{10^6}{5} = 200,000 \Rightarrow n \geq 5 \Rightarrow 1 - \frac{1}{2!} + \frac{1}{4!} - \frac{1}{6!} + \frac{1}{8!} \approx 0.54030$

$$50. \frac{1}{n!} < \frac{5}{10^n} \Rightarrow \frac{10^6}{5} < n! \Rightarrow n \geq 9 \Rightarrow 1 - 1 + \frac{1}{2!} - \frac{1}{3!} + \frac{1}{4!} - \frac{1}{5!} + \frac{1}{6!} - \frac{1}{7!} + \frac{1}{8!} \approx 0.367881944$$

$$51. (a) a_n \geq a_{n+1} \text{ fails since } \frac{1}{3} < \frac{1}{2}$$

(b) Since $\sum_{n=1}^{\infty} |a_n| = \sum_{n=1}^{\infty} \left[\left(\frac{1}{3}\right)^n + \left(\frac{1}{2}\right)^n \right] = \sum_{n=1}^{\infty} \left(\frac{1}{3}\right)^n + \sum_{n=1}^{\infty} \left(\frac{1}{2}\right)^n$ is the sum of two absolutely convergent series, we can rearrange the terms of the original series to find its sum:

$$\left(\frac{1}{3} + \frac{1}{9} + \frac{1}{27} + \dots\right) - \left(\frac{1}{2} + \frac{1}{4} + \frac{1}{8} + \dots\right) = \frac{\left(\frac{1}{3}\right)}{1 - \left(\frac{1}{3}\right)} - \frac{\left(\frac{1}{2}\right)}{1 - \left(\frac{1}{2}\right)} = \frac{1}{2} - 1 = -\frac{1}{2}$$

$$52. s_{20} = 1 - \frac{1}{2} + \frac{1}{3} - \frac{1}{4} + \dots + \frac{1}{19} - \frac{1}{20} \approx 0.6687714032 \Rightarrow s_{20} + \frac{1}{2} \cdot \frac{1}{21} \approx 0.692580927$$

$$53. \text{The unused terms are } \sum_{j=n+1}^{\infty} (-1)^{j+1} a_j = (-1)^{n+1} (a_{n+1} - a_{n+2}) + (-1)^{n+3} (a_{n+3} - a_{n+4}) + \dots$$

$= (-1)^{n+1} [(a_{n+1} - a_{n+2}) + (a_{n+3} - a_{n+4}) + \dots]$. Each grouped term is positive, so the remainder has the same sign as $(-1)^{n+1}$, which is the sign of the first unused term.

$$54. s_n = \frac{1}{1 \cdot 2} + \frac{1}{2 \cdot 3} + \frac{1}{3 \cdot 4} + \dots + \frac{1}{n(n+1)} = \sum_{k=1}^n \frac{1}{k(k+1)} = \sum_{k=1}^n \left(\frac{1}{k} - \frac{1}{k+1}\right)$$

$$= \left(1 - \frac{1}{2}\right) + \left(\frac{1}{2} - \frac{1}{3}\right) + \left(\frac{1}{3} - \frac{1}{4}\right) + \left(\frac{1}{4} - \frac{1}{5}\right) + \dots + \left(\frac{1}{n} - \frac{1}{n+1}\right)$$

which are the first $2n$ terms of the first series, hence the two series are the same. Yes, for

$$s_n = \sum_{k=1}^n \left(\frac{1}{k} - \frac{1}{k+1}\right) = \left(1 - \frac{1}{2}\right) + \left(\frac{1}{2} - \frac{1}{3}\right) + \left(\frac{1}{3} - \frac{1}{4}\right) + \left(\frac{1}{4} - \frac{1}{5}\right) + \dots + \left(\frac{1}{n-1} - \frac{1}{n}\right) + \left(\frac{1}{n} - \frac{1}{n+1}\right) = 1 - \frac{1}{n+1}$$

$$\Rightarrow \lim_{n \rightarrow \infty} s_n = \lim_{n \rightarrow \infty} \left(1 - \frac{1}{n+1}\right) = 1 \Rightarrow \text{both series converge to 1. The sum of the first } 2n + 1 \text{ terms of the first series is } \left(1 - \frac{1}{n+1}\right) + \frac{1}{n+1} = 1. \text{ Their sum is } \lim_{n \rightarrow \infty} s_n = \lim_{n \rightarrow \infty} \left(1 - \frac{1}{n+1}\right) = 1.$$

55. Theorem 16 states that $\sum_{n=1}^{\infty} |a_n|$ converges $\Rightarrow \sum_{n=1}^{\infty} a_n$ converges. But this is equivalent to $\sum_{n=1}^{\infty} a_n$ diverges $\Rightarrow \sum_{n=1}^{\infty} |a_n|$ diverges.

56. $|a_1 + a_2 + \dots + a_n| \leq |a_1| + |a_2| + \dots + |a_n|$ for all n ; then $\sum_{n=1}^{\infty} |a_n|$ converges $\Rightarrow \sum_{n=1}^{\infty} a_n$ converges and these imply that $\left| \sum_{n=1}^{\infty} a_n \right| \leq \sum_{n=1}^{\infty} |a_n|$

57. (a) $\sum_{n=1}^{\infty} |a_n + b_n|$ converges by the Direct Comparison Test since $|a_n + b_n| \leq |a_n| + |b_n|$ and hence $\sum_{n=1}^{\infty} (a_n + b_n)$ converges absolutely

(b) $\sum_{n=1}^{\infty} |b_n|$ converges $\Rightarrow \sum_{n=1}^{\infty} -b_n$ converges absolutely; since $\sum_{n=1}^{\infty} a_n$ converges absolutely and $\sum_{n=1}^{\infty} -b_n$ converges absolutely, we have $\sum_{n=1}^{\infty} [a_n + (-b_n)] = \sum_{n=1}^{\infty} (a_n - b_n)$ converges absolutely by part (a)

(c) $\sum_{n=1}^{\infty} |a_n|$ converges $\Rightarrow |k| \sum_{n=1}^{\infty} |a_n| = \sum_{n=1}^{\infty} |ka_n|$ converges $\Rightarrow \sum_{n=1}^{\infty} ka_n$ converges absolutely

58. If $a_n = b_n = (-1)^n \frac{1}{\sqrt{n}}$, then $\sum_{n=1}^{\infty} (-1)^n \frac{1}{\sqrt{n}}$ converges, but $\sum_{n=1}^{\infty} a_n b_n = \sum_{n=1}^{\infty} \frac{1}{n}$ diverges

$$59. s_1 = -\frac{1}{2}, s_2 = -\frac{1}{2} + 1 = \frac{1}{2},$$

$$s_3 = -\frac{1}{2} + 1 - \frac{1}{4} - \frac{1}{6} - \frac{1}{8} - \frac{1}{10} - \frac{1}{12} - \frac{1}{14} - \frac{1}{16} - \frac{1}{18} - \frac{1}{20} - \frac{1}{22} \approx -0.5099,$$

$$s_4 = s_3 + \frac{1}{3} \approx -0.1766,$$

$$s_5 = s_4 - \frac{1}{24} - \frac{1}{26} - \frac{1}{28} - \frac{1}{30} - \frac{1}{32} - \frac{1}{34} - \frac{1}{36} - \frac{1}{38} - \frac{1}{40} - \frac{1}{42} - \frac{1}{44} \approx -0.512,$$

$$s_6 = s_5 + \frac{1}{5} \approx -0.312,$$

$$s_7 = s_6 - \frac{1}{46} - \frac{1}{48} - \frac{1}{50} - \frac{1}{52} - \frac{1}{54} - \frac{1}{56} - \frac{1}{58} - \frac{1}{60} - \frac{1}{62} - \frac{1}{64} - \frac{1}{66} \approx -0.51106$$

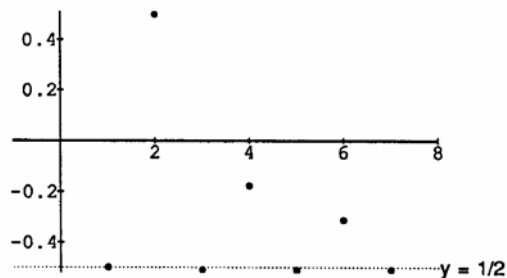

60. (a) Since $\sum |a_n|$ converges, say to M , for $\epsilon > 0$ there is an integer N_1 such that $\left| \sum_{n=1}^{N_1-1} |a_n| - M \right| < \frac{\epsilon}{2}$
- $$\Leftrightarrow \left| \sum_{n=1}^{N_1-1} |a_n| - \left(\sum_{n=1}^{N_1-1} |a_n| + \sum_{n=N_1}^{\infty} |a_n| \right) \right| < \frac{\epsilon}{2} \Leftrightarrow \left| - \sum_{n=N_1}^{\infty} |a_n| \right| < \frac{\epsilon}{2} \Leftrightarrow \sum_{n=N_1}^{\infty} |a_n| < \frac{\epsilon}{2}.$$
- Also, $\sum a_n$ converges to $L \Leftrightarrow$ for $\epsilon > 0$ there is an integer N_2 (which we can choose greater than or equal to N_1) such that $|s_{N_2} - L| < \frac{\epsilon}{2}$. Therefore, $\sum_{n=N_1}^{\infty} |a_n| < \frac{\epsilon}{2}$ and $|s_{N_2} - L| < \frac{\epsilon}{2}$.

- (b) The series $\sum |a_n|$ converges absolutely, say to M . Thus, there exists N_1 such that $\left| \sum_{n=1}^k |a_n| - M \right| < \epsilon$ whenever $k > N_1$. Now all of the terms in the sequence $\{|b_n|\}$ appear in $\{|a_n|\}$. Sum together all of the terms in $\{|b_n|\}$, in order, until you include all of the terms $\{|a_n|\}_{n=1}^{N_1}$, and let N_2 be the largest index in the sum $\sum_{n=1}^{N_2} |b_n|$ so obtained. Then $\left| \sum_{n=1}^{N_2} |b_n| - M \right| < \epsilon$ as well $\Rightarrow \sum_{n=1}^{\infty} |b_n|$ converges to M .

61. (a) If $\sum_{n=1}^{\infty} |a_n|$ converges, then $\sum_{n=1}^{\infty} a_n$ converges and $\frac{1}{2} \sum_{n=1}^{\infty} a_n + \frac{1}{2} \sum_{n=1}^{\infty} |a_n| = \sum_{n=1}^{\infty} \frac{a_n + |a_n|}{2}$ converges where $b_n = \frac{a_n + |a_n|}{2} = \begin{cases} a_n, & \text{if } a_n \geq 0 \\ 0, & \text{if } a_n < 0 \end{cases}$.
- (b) If $\sum_{n=1}^{\infty} |a_n|$ converges, then $\sum_{n=1}^{\infty} a_n$ converges and $\frac{1}{2} \sum_{n=1}^{\infty} a_n - \frac{1}{2} \sum_{n=1}^{\infty} |a_n| = \sum_{n=1}^{\infty} \frac{a_n - |a_n|}{2}$ converges where $c_n = \frac{a_n - |a_n|}{2} = \begin{cases} 0, & \text{if } a_n \geq 0 \\ a_n, & \text{if } a_n < 0 \end{cases}$.

62. The terms in this conditionally convergent series were not added in the order given.

63. Here is an example figure when $N = 5$. Notice that $u_3 > u_2 > u_1$ and $u_3 > u_5 > u_4$, but $u_n \geq u_{n+1}$ for $n \geq 5$.

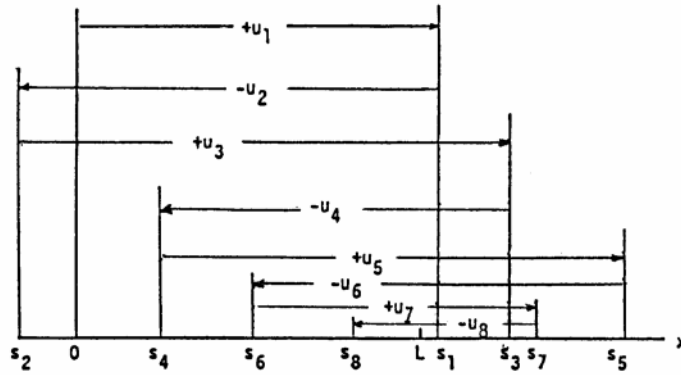

11.7 POWER SERIES

- $\lim_{n \rightarrow \infty} \left| \frac{u_{n+1}}{u_n} \right| < 1 \Rightarrow \lim_{n \rightarrow \infty} \left| \frac{x^{n+1}}{x^n} \right| < 1 \Rightarrow |x| < 1 \Rightarrow -1 < x < 1$; when $x = -1$ we have $\sum_{n=1}^{\infty} (-1)^n$, a divergent series; when $x = 1$ we have $\sum_{n=1}^{\infty} 1$, a divergent series
 - the radius is 1; the interval of convergence is $-1 < x < 1$
 - the interval of absolute convergence is $-1 < x < 1$
 - there are no values for which the series converges conditionally
- $\lim_{n \rightarrow \infty} \left| \frac{u_{n+1}}{u_n} \right| < 1 \Rightarrow \lim_{n \rightarrow \infty} \left| \frac{(x+5)^{n+1}}{(x+5)^n} \right| < 1 \Rightarrow |x+5| < 1 \Rightarrow -6 < x < -4$; when $x = -6$ we have $\sum_{n=1}^{\infty} (-1)^n$, a divergent series; when $x = -4$ we have $\sum_{n=1}^{\infty} 1$, a divergent series
 - the radius is 1; the interval of convergence is $-6 < x < -4$
 - the interval of absolute convergence is $-6 < x < -4$
 - there are no values for which the series converges conditionally
- $\lim_{n \rightarrow \infty} \left| \frac{u_{n+1}}{u_n} \right| < 1 \Rightarrow \lim_{n \rightarrow \infty} \left| \frac{(4x+1)^{n+1}}{(4x+1)^n} \right| < 1 \Rightarrow |4x+1| < 1 \Rightarrow -1 < 4x+1 < 1 \Rightarrow -\frac{1}{2} < x < 0$; when $x = -\frac{1}{2}$ we have $\sum_{n=1}^{\infty} (-1)^n (-1)^n = \sum_{n=1}^{\infty} (-1)^{2n} = \sum_{n=1}^{\infty} 1^n$, a divergent series; when $x = 0$ we have $\sum_{n=1}^{\infty} (-1)^n (1)^n = \sum_{n=1}^{\infty} (-1)^n$, a divergent series
 - the radius is $\frac{1}{4}$; the interval of convergence is $-\frac{1}{2} < x < 0$
 - the interval of absolute convergence is $-\frac{1}{2} < x < 0$
 - there are no values for which the series converges conditionally
- $\lim_{n \rightarrow \infty} \left| \frac{u_{n+1}}{u_n} \right| < 1 \Rightarrow \lim_{n \rightarrow \infty} \left| \frac{(3x-2)^{n+1}}{n+1} \cdot \frac{n}{(3x-2)^n} \right| < 1 \Rightarrow |3x-2| \lim_{n \rightarrow \infty} \left(\frac{n}{n+1} \right) < 1 \Rightarrow |3x-2| < 1$
 $\Rightarrow -1 < 3x-2 < 1 \Rightarrow \frac{1}{3} < x < 1$; when $x = \frac{1}{3}$ we have $\sum_{n=1}^{\infty} \frac{(-1)^n}{n}$ which is the alternating harmonic series and is conditionally convergent; when $x = 1$ we have $\sum_{n=1}^{\infty} \frac{1}{n}$, the divergent harmonic series
 - the radius is $\frac{1}{3}$; the interval of convergence is $\frac{1}{3} \leq x < 1$
 - the interval of absolute convergence is $\frac{1}{3} < x < 1$
 - the series converges conditionally at $x = \frac{1}{3}$

5. $\lim_{n \rightarrow \infty} \left| \frac{u_{n+1}}{u_n} \right| < 1 \Rightarrow \lim_{n \rightarrow \infty} \left| \frac{(x-2)^{n+1}}{10^{n+1}} \cdot \frac{10^n}{(x-2)^n} \right| < 1 \Rightarrow \frac{|x-2|}{10} < 1 \Rightarrow |x-2| < 10 \Rightarrow -10 < x-2 < 10$
 $\Rightarrow -8 < x < 12$; when $x = -8$ we have $\sum_{n=1}^{\infty} (-1)^n$, a divergent series; when $x = 12$ we have $\sum_{n=1}^{\infty} 1$, a divergent series
 (a) the radius is 10; the interval of convergence is $-8 < x < 12$
 (b) the interval of absolute convergence is $-8 < x < 12$
 (c) there are no values for which the series converges conditionally
6. $\lim_{n \rightarrow \infty} \left| \frac{u_{n+1}}{u_n} \right| < 1 \Rightarrow \lim_{n \rightarrow \infty} \left| \frac{(2x)^{n+1}}{(2x)^n} \right| < 1 \Rightarrow \lim_{n \rightarrow \infty} |2x| < 1 \Rightarrow |2x| < 1 \Rightarrow -\frac{1}{2} < x < \frac{1}{2}$; when $x = -\frac{1}{2}$ we have $\sum_{n=1}^{\infty} (-1)^n$, a divergent series; when $x = \frac{1}{2}$ we have $\sum_{n=1}^{\infty} 1$, a divergent series
 (a) the radius is $\frac{1}{2}$; the interval of convergence is $-\frac{1}{2} < x < \frac{1}{2}$
 (b) the interval of absolute convergence is $-\frac{1}{2} < x < \frac{1}{2}$
 (c) there are no values for which the series converges conditionally
7. $\lim_{n \rightarrow \infty} \left| \frac{u_{n+1}}{u_n} \right| < 1 \Rightarrow \lim_{n \rightarrow \infty} \left| \frac{(n+1)x^{n+1}}{(n+3)} \cdot \frac{(n+2)}{nx^n} \right| < 1 \Rightarrow |x| \lim_{n \rightarrow \infty} \frac{(n+1)(n+2)}{(n+3)(n)} < 1 \Rightarrow |x| < 1$
 $\Rightarrow -1 < x < 1$; when $x = -1$ we have $\sum_{n=1}^{\infty} (-1)^n \frac{n}{n+2}$, a divergent series by the n th-term Test; when $x = 1$ we have $\sum_{n=1}^{\infty} \frac{n}{n+2}$, a divergent series
 (a) the radius is 1; the interval of convergence is $-1 < x < 1$
 (b) the interval of absolute convergence is $-1 < x < 1$
 (c) there are no values for which the series converges conditionally
8. $\lim_{n \rightarrow \infty} \left| \frac{u_{n+1}}{u_n} \right| < 1 \Rightarrow \lim_{n \rightarrow \infty} \left| \frac{(x+2)^{n+1}}{n+1} \cdot \frac{n}{(x+2)^n} \right| < 1 \Rightarrow |x+2| \lim_{n \rightarrow \infty} \left(\frac{n}{n+1} \right) < 1 \Rightarrow |x+2| < 1$
 $\Rightarrow -1 < x+2 < 1 \Rightarrow -3 < x < -1$; when $x = -3$ we have $\sum_{n=1}^{\infty} \frac{1}{n}$, a divergent series; when $x = -1$ we have $\sum_{n=1}^{\infty} \frac{(-1)^n}{n}$, a convergent series
 (a) the radius is 1; the interval of convergence is $-3 < x \leq -1$
 (b) the interval of absolute convergence is $-3 < x < -1$
 (c) the series converges conditionally at $x = -1$
9. $\lim_{n \rightarrow \infty} \left| \frac{u_{n+1}}{u_n} \right| < 1 \Rightarrow \lim_{n \rightarrow \infty} \left| \frac{x^{n+1}}{(n+1)\sqrt{n+1} 3^{n+1}} \cdot \frac{n\sqrt{n} 3^n}{x^n} \right| < 1 \Rightarrow \frac{|x|}{3} \left(\lim_{n \rightarrow \infty} \frac{n}{n+1} \right) \left(\sqrt{\lim_{n \rightarrow \infty} \frac{n}{n+1}} \right) < 1$
 $\Rightarrow \frac{|x|}{3} (1)(1) < 1 \Rightarrow |x| < 3 \Rightarrow -3 < x < 3$; when $x = -3$ we have $\sum_{n=1}^{\infty} \frac{(-1)^n}{n^{3/2}}$, an absolutely convergent series;
 when $x = 3$ we have $\sum_{n=1}^{\infty} \frac{1}{n^{3/2}}$, a convergent p -series
 (a) the radius is 3; the interval of convergence is $-3 \leq x \leq 3$
 (b) the interval of absolute convergence is $-3 \leq x \leq 3$
 (c) there are no values for which the series converges conditionally
10. $\lim_{n \rightarrow \infty} \left| \frac{u_{n+1}}{u_n} \right| < 1 \Rightarrow \lim_{n \rightarrow \infty} \left| \frac{(x-1)^{n+1}}{\sqrt{n+1}} \cdot \frac{\sqrt{n}}{(x-1)^n} \right| < 1 \Rightarrow |x-1| \sqrt{\lim_{n \rightarrow \infty} \frac{n}{n+1}} < 1 \Rightarrow |x-1| < 1$
 $\Rightarrow -1 < x-1 < 1 \Rightarrow 0 < x < 2$; when $x = 0$ we have $\sum_{n=1}^{\infty} \frac{(-1)^n}{n^{1/2}}$, a conditionally convergent series; when $x = 2$

we have $\sum_{n=1}^{\infty} \frac{1}{n^{1/2}}$, a divergent series

- (a) the radius is 1; the interval of convergence is $0 \leq x < 2$
- (b) the interval of absolute convergence is $0 < x < 2$
- (c) the series converges conditionally at $x = 0$

$$11. \lim_{n \rightarrow \infty} \left| \frac{u_{n+1}}{u_n} \right| < 1 \Rightarrow \lim_{n \rightarrow \infty} \left| \frac{x^{n+1}}{(n+1)!} \cdot \frac{n!}{x^n} \right| < 1 \Rightarrow |x| \lim_{n \rightarrow \infty} \left(\frac{1}{n+1} \right) < 1 \text{ for all } x$$

- (a) the radius is ∞ ; the series converges for all x
- (b) the series converges absolutely for all x
- (c) there are no values for which the series converges conditionally

$$12. \lim_{n \rightarrow \infty} \left| \frac{u_{n+1}}{u_n} \right| < 1 \Rightarrow \lim_{n \rightarrow \infty} \left| \frac{3^{n+1} x^{n+1}}{(n+1)!} \cdot \frac{n!}{3^n x^n} \right| < 1 \Rightarrow 3|x| \lim_{n \rightarrow \infty} \left(\frac{1}{n+1} \right) < 1 \text{ for all } x$$

- (a) the radius is ∞ ; the series converges for all x
- (b) the series converges absolutely for all x
- (c) there are no values for which the series converges conditionally

$$13. \lim_{n \rightarrow \infty} \left| \frac{u_{n+1}}{u_n} \right| < 1 \Rightarrow \lim_{n \rightarrow \infty} \left| \frac{x^{2n+3}}{(n+1)!} \cdot \frac{n!}{x^{2n+1}} \right| < 1 \Rightarrow x^2 \lim_{n \rightarrow \infty} \left(\frac{1}{n+1} \right) < 1 \text{ for all } x$$

- (a) the radius is ∞ ; the series converges for all x
- (b) the series converges absolutely for all x
- (c) there are no values for which the series converges conditionally

$$14. \lim_{n \rightarrow \infty} \left| \frac{u_{n+1}}{u_n} \right| < 1 \Rightarrow \lim_{n \rightarrow \infty} \left| \frac{(2x+3)^{2n+3}}{(n+1)!} \cdot \frac{n!}{(2x+3)^{2n+1}} \right| < 1 \Rightarrow (2x+3)^2 \lim_{n \rightarrow \infty} \left(\frac{1}{n+1} \right) < 1 \text{ for all } x$$

- (a) the radius is ∞ ; the series converges for all x
- (b) the series converges absolutely for all x
- (c) there are no values for which the series converges conditionally

$$15. \lim_{n \rightarrow \infty} \left| \frac{u_{n+1}}{u_n} \right| < 1 \Rightarrow \lim_{n \rightarrow \infty} \left| \frac{x^{n+1}}{\sqrt{(n+1)^2+3}} \cdot \frac{\sqrt{n^2+3}}{x^n} \right| < 1 \Rightarrow |x| \sqrt{\lim_{n \rightarrow \infty} \frac{n^2+3}{n^2+2n+4}} < 1 \Rightarrow |x| < 1$$

$\Rightarrow -1 < x < 1$; when $x = -1$ we have $\sum_{n=1}^{\infty} \frac{(-1)^n}{\sqrt{n^2+3}}$, a conditionally convergent series; when $x = 1$ we have

$\sum_{n=1}^{\infty} \frac{1}{\sqrt{n^2+3}}$, a divergent series

- (a) the radius is 1; the interval of convergence is $-1 \leq x < 1$
- (b) the interval of absolute convergence is $-1 < x < 1$
- (c) the series converges conditionally at $x = -1$

$$16. \lim_{n \rightarrow \infty} \left| \frac{u_{n+1}}{u_n} \right| < 1 \Rightarrow \lim_{n \rightarrow \infty} \left| \frac{x^{n+1}}{\sqrt{(n+1)^2+3}} \cdot \frac{\sqrt{n^2+3}}{x^n} \right| < 1 \Rightarrow |x| \sqrt{\lim_{n \rightarrow \infty} \frac{n^2+3}{n^2+2n+4}} < 1 \Rightarrow |x| < 1$$

$\Rightarrow -1 < x < 1$; when $x = -1$ we have $\sum_{n=1}^{\infty} \frac{1}{\sqrt{n^2+3}}$, a divergent series; when $x = 1$ we have $\sum_{n=1}^{\infty} \frac{(-1)^n}{\sqrt{n^2+3}}$,

a conditionally convergent series

- (a) the radius is 1; the interval of convergence is $-1 < x \leq 1$
- (b) the interval of absolute convergence is $-1 < x < 1$
- (c) the series converges conditionally at $x = 1$

$$17. \lim_{n \rightarrow \infty} \left| \frac{u_{n+1}}{u_n} \right| < 1 \Rightarrow \lim_{n \rightarrow \infty} \left| \frac{(n+1)(x+3)^{n+1}}{5^{n+1}} \cdot \frac{5^n}{n(x+3)^n} \right| < 1 \Rightarrow \frac{|x+3|}{5} \lim_{n \rightarrow \infty} \left(\frac{n+1}{n} \right) < 1 \Rightarrow \frac{|x+3|}{5} < 1$$

$\Rightarrow |x + 3| < 5 \Rightarrow -5 < x + 3 < 5 \Rightarrow -8 < x < 2$; when $x = -8$ we have $\sum_{n=1}^{\infty} \frac{n(-5)^n}{5^n} = \sum_{n=1}^{\infty} (-1)^n n$, a divergent

series; when $x = 2$ we have $\sum_{n=1}^{\infty} \frac{n5^n}{5^n} = \sum_{n=1}^{\infty} n$, a divergent series

- (a) the radius is 5; the interval of convergence is $-8 < x < 2$
 (b) the interval of absolute convergence is $-8 < x < 2$
 (c) there are no values for which the series converges conditionally

18. $\lim_{n \rightarrow \infty} \left| \frac{u_{n+1}}{u_n} \right| < 1 \Rightarrow \lim_{n \rightarrow \infty} \left| \frac{(n+1)x^{n+1}}{4^{n+1}(n^2+2n+2)} \cdot \frac{4^n(n^2+1)}{nx^n} \right| < 1 \Rightarrow \frac{|x|}{4} \lim_{n \rightarrow \infty} \left| \frac{(n+1)(n^2+1)}{n(n^2+2n+2)} \right| < 1 \Rightarrow |x| < 4$
 $\Rightarrow -4 < x < 4$; when $x = -4$ we have $\sum_{n=1}^{\infty} \frac{n(-1)^n}{n^2+1}$, a conditionally convergent series; when $x = 4$ we have

$\sum_{n=1}^{\infty} \frac{n}{n^2+1}$, a divergent series

- (a) the radius is 4; the interval of convergence is $-4 \leq x < 4$
 (b) the interval of absolute convergence is $-4 < x < 4$
 (c) the series converges conditionally at $x = -4$

19. $\lim_{n \rightarrow \infty} \left| \frac{u_{n+1}}{u_n} \right| < 1 \Rightarrow \lim_{n \rightarrow \infty} \left| \frac{\sqrt{n+1}x^{n+1}}{3^{n+1}} \cdot \frac{3^n}{\sqrt{n}x^n} \right| < 1 \Rightarrow \frac{|x|}{3} \sqrt{\lim_{n \rightarrow \infty} \left(\frac{n+1}{n} \right)} < 1 \Rightarrow \frac{|x|}{3} < 1 \Rightarrow |x| < 3$
 $\Rightarrow -3 < x < 3$; when $x = -3$ we have $\sum_{n=1}^{\infty} (-1)^n \sqrt{n}$, a divergent series; when $x = 3$ we have

$\sum_{n=1}^{\infty} \sqrt{n}$, a divergent series

- (a) the radius is 3; the interval of convergence is $-3 < x < 3$
 (b) the interval of absolute convergence is $-3 < x < 3$
 (c) there are no values for which the series converges conditionally

20. $\lim_{n \rightarrow \infty} \left| \frac{u_{n+1}}{u_n} \right| < 1 \Rightarrow \lim_{n \rightarrow \infty} \left| \frac{\sqrt[n+1]{n+1} (2x+5)^{n+1}}{\sqrt[n]{n} (2x+5)^n} \right| < 1 \Rightarrow |2x+5| \lim_{n \rightarrow \infty} \left(\frac{\sqrt[n+1]{n+1}}{\sqrt[n]{n}} \right) < 1$
 $\Rightarrow |2x+5| \left(\lim_{n \rightarrow \infty} \frac{\sqrt[n]{t}}{\sqrt[n]{n}} \right) < 1 \Rightarrow |2x+5| < 1 \Rightarrow -1 < 2x+5 < 1 \Rightarrow -3 < x < -2$; when $x = -3$ we have

$\sum_{n=1}^{\infty} (-1)^n \sqrt[n]{n}$, a divergent series since $\lim_{n \rightarrow \infty} \sqrt[n]{n} = 1$; when $x = -2$ we have $\sum_{n=1}^{\infty} \sqrt[n]{n}$, a divergent series

- (a) the radius is $\frac{1}{2}$; the interval of convergence is $-3 < x < -2$
 (b) the interval of absolute convergence is $-3 < x < -2$
 (c) there are no values for which the series converges conditionally

21. $\lim_{n \rightarrow \infty} \left| \frac{u_{n+1}}{u_n} \right| < 1 \Rightarrow \lim_{n \rightarrow \infty} \left| \frac{\left(1 + \frac{1}{n+1}\right)^{n+1} x^{n+1}}{\left(1 + \frac{1}{n}\right)^n x^n} \right| < 1 \Rightarrow |x| \left(\lim_{n \rightarrow \infty} \frac{\left(1 + \frac{1}{t}\right)^t}{\left(1 + \frac{1}{n}\right)^n} \right) < 1 \Rightarrow |x| \left(\frac{e}{e} \right) < 1 \Rightarrow |x| < 1$
 $\Rightarrow -1 < x < 1$; when $x = -1$ we have $\sum_{n=1}^{\infty} (-1)^n \left(1 + \frac{1}{n}\right)^n$, a divergent series by the n th-Term Test since

$\lim_{n \rightarrow \infty} \left(1 + \frac{1}{n}\right)^n = e \neq 0$; when $x = 1$ we have $\sum_{n=1}^{\infty} \left(1 + \frac{1}{n}\right)^n$, a divergent series

- (a) the radius is 1; the interval of convergence is $-1 < x < 1$
 (b) the interval of absolute convergence is $-1 < x < 1$
 (c) there are no values for which the series converges conditionally

22. $\lim_{n \rightarrow \infty} \left| \frac{u_{n+1}}{u_n} \right| < 1 \Rightarrow \lim_{n \rightarrow \infty} \left| \frac{\ln(n+1)x^{n+1}}{x^n \ln n} \right| < 1 \Rightarrow |x| \lim_{n \rightarrow \infty} \left| \frac{\left(\frac{1}{n+1}\right)}{\left(\frac{1}{n}\right)} \right| < 1 \Rightarrow |x| \lim_{n \rightarrow \infty} \left(\frac{-n}{n+1} \right) < 1 \Rightarrow |x| < 1$

$\Rightarrow -1 < x < 1$; when $x = -1$ we have $\sum_{n=1}^{\infty} (-1)^n \ln n$, a divergent series by the n th-Term Test since

$\lim_{n \rightarrow \infty} \ln n \neq 0$; when $x = 1$ we have $\sum_{n=1}^{\infty} \ln n$, a divergent series

- (a) the radius is 1; the interval of convergence is $-1 < x < 1$
- (b) the interval of absolute convergence is $-1 < x < 1$
- (c) there are no values for which the series converges conditionally

$$23. \lim_{n \rightarrow \infty} \left| \frac{u_{n+1}}{u_n} \right| < 1 \Rightarrow \lim_{n \rightarrow \infty} \left| \frac{(n+1)^{n+1} x^{n+1}}{n^n x^n} \right| < 1 \Rightarrow |x| \left(\lim_{n \rightarrow \infty} \left(1 + \frac{1}{n}\right)^n \right) \left(\lim_{n \rightarrow \infty} (n+1) \right) < 1$$

$$\Rightarrow e|x| \lim_{n \rightarrow \infty} (n+1) < 1 \Rightarrow \text{only } x = 0 \text{ satisfies this inequality}$$

- (a) the radius is 0; the series converges only for $x = 0$
- (b) the series converges absolutely only for $x = 0$
- (c) there are no values for which the series converges conditionally

$$24. \lim_{n \rightarrow \infty} \left| \frac{u_{n+1}}{u_n} \right| < 1 \Rightarrow \lim_{n \rightarrow \infty} \left| \frac{(n+1)! (x-4)^{n+1}}{n! (x-4)^n} \right| < 1 \Rightarrow |x-4| \lim_{n \rightarrow \infty} (n+1) < 1 \Rightarrow \text{only } x = 4 \text{ satisfies this inequality}$$

- (a) the radius is 0; the series converges only for $x = 4$
- (b) the series converges absolutely only for $x = 4$
- (c) there are no values for which the series converges conditionally

$$25. \lim_{n \rightarrow \infty} \left| \frac{u_{n+1}}{u_n} \right| < 1 \Rightarrow \lim_{n \rightarrow \infty} \left| \frac{(x+2)^{n+1}}{(n+1)2^{n+1}} \cdot \frac{n2^n}{(x+2)^n} \right| < 1 \Rightarrow \frac{|x+2|}{2} \lim_{n \rightarrow \infty} \left(\frac{n}{n+1} \right) < 1 \Rightarrow \frac{|x+2|}{2} < 1 \Rightarrow |x+2| < 2$$

$$\Rightarrow -2 < x+2 < 2 \Rightarrow -4 < x < 0; \text{ when } x = -4 \text{ we have } \sum_{n=1}^{\infty} \frac{-1}{n}, \text{ a divergent series; when } x = 0 \text{ we have}$$

$\sum_{n=1}^{\infty} \frac{(-1)^{n+1}}{n}$, the alternating harmonic series which converges conditionally

- (a) the radius is 2; the interval of convergence is $-4 < x \leq 0$
- (b) the interval of absolute convergence is $-4 < x < 0$
- (c) the series converges conditionally at $x = 0$

$$26. \lim_{n \rightarrow \infty} \left| \frac{u_{n+1}}{u_n} \right| < 1 \Rightarrow \lim_{n \rightarrow \infty} \left| \frac{(-2)^{n+1} (n+2) (x-1)^{n+1}}{(-2)^n (n+1) (x-1)^n} \right| < 1 \Rightarrow 2|x-1| \lim_{n \rightarrow \infty} \left(\frac{n+2}{n+1} \right) < 1 \Rightarrow 2|x-1| < 1$$

$$\Rightarrow |x-1| < \frac{1}{2} \Rightarrow -\frac{1}{2} < x-1 < \frac{1}{2} \Rightarrow \frac{1}{2} < x < \frac{3}{2}; \text{ when } x = \frac{1}{2} \text{ we have } \sum_{n=1}^{\infty} (n+1), \text{ a divergent series; when } x = \frac{3}{2}$$

we have $\sum_{n=1}^{\infty} (-1)^n (n+1)$, a divergent series

- (a) the radius is $\frac{1}{2}$; the interval of convergence is $\frac{1}{2} < x < \frac{3}{2}$
- (b) the interval of absolute convergence is $\frac{1}{2} < x < \frac{3}{2}$
- (c) there are no values for which the series converges conditionally

$$27. \lim_{n \rightarrow \infty} \left| \frac{u_{n+1}}{u_n} \right| < 1 \Rightarrow \lim_{n \rightarrow \infty} \left| \frac{x^{n+1}}{(n+1)(\ln(n+1))^2} \cdot \frac{n(\ln n)^2}{x^n} \right| < 1 \Rightarrow |x| \left(\lim_{n \rightarrow \infty} \frac{n}{n+1} \right) \left(\lim_{n \rightarrow \infty} \frac{\ln n}{\ln(n+1)} \right)^2 < 1$$

$$\Rightarrow |x| (1) \left(\lim_{n \rightarrow \infty} \left(\frac{\frac{1}{n}}{\frac{1}{n+1}} \right) \right)^2 < 1 \Rightarrow |x| \left(\lim_{n \rightarrow \infty} \frac{n+1}{n} \right)^2 < 1 \Rightarrow |x| < 1 \Rightarrow -1 < x < 1; \text{ when } x = -1 \text{ we have}$$

$\sum_{n=1}^{\infty} \frac{(-1)^n}{n(\ln n)^2}$ which converges absolutely; when $x = 1$ we have $\sum_{n=1}^{\infty} \frac{1}{n(\ln n)^2}$ which converges

- (a) the radius is 1; the interval of convergence is $-1 \leq x \leq 1$
- (b) the interval of absolute convergence is $-1 \leq x \leq 1$
- (c) there are no values for which the series converges conditionally

$$28. \lim_{n \rightarrow \infty} \left| \frac{u_{n+1}}{u_n} \right| < 1 \Rightarrow \lim_{n \rightarrow \infty} \left| \frac{x^{n+1}}{(n+1) \ln(n+1)} \cdot \frac{n \ln(n)}{x^n} \right| < 1 \Rightarrow |x| \left(\lim_{n \rightarrow \infty} \frac{n}{n+1} \right) \left(\lim_{n \rightarrow \infty} \frac{\ln(n)}{\ln(n+1)} \right) < 1$$

$$\Rightarrow |x|(1)(1) < 1 \Rightarrow |x| < 1 \Rightarrow -1 < x < 1; \text{ when } x = -1 \text{ we have } \sum_{n=2}^{\infty} \frac{(-1)^n}{n \ln n}, \text{ a convergent alternating series;}$$

when $x = 1$ we have $\sum_{n=2}^{\infty} \frac{1}{n \ln n}$ which diverges by Exercise 38, Section 11.3

- (a) the radius is 1; the interval of convergence is $-1 \leq x < 1$
 (b) the interval of absolute convergence is $-1 < x < 1$
 (c) the series converges conditionally at $x = -1$

$$29. \lim_{n \rightarrow \infty} \left| \frac{u_{n+1}}{u_n} \right| < 1 \Rightarrow \lim_{n \rightarrow \infty} \left| \frac{(4x-5)^{2n+3}}{(n+1)^{3/2}} \cdot \frac{n^{3/2}}{(4x-5)^{2n+1}} \right| < 1 \Rightarrow (4x-5)^2 \left(\lim_{n \rightarrow \infty} \frac{n}{n+1} \right)^{3/2} < 1 \Rightarrow (4x-5)^2 < 1$$

$$\Rightarrow |4x-5| < 1 \Rightarrow -1 < 4x-5 < 1 \Rightarrow 1 < x < \frac{3}{2}; \text{ when } x = 1 \text{ we have } \sum_{n=1}^{\infty} \frac{(-1)^{2n+1}}{n^{3/2}} = \sum_{n=1}^{\infty} \frac{-1}{n^{3/2}} \text{ which is}$$

absolutely convergent; when $x = \frac{3}{2}$ we have $\sum_{n=1}^{\infty} \frac{(1)^{2n+1}}{n^{3/2}}$, a convergent p-series

- (a) the radius is $\frac{1}{4}$; the interval of convergence is $1 \leq x \leq \frac{3}{2}$
 (b) the interval of absolute convergence is $1 \leq x \leq \frac{3}{2}$
 (c) there are no values for which the series converges conditionally

$$30. \lim_{n \rightarrow \infty} \left| \frac{u_{n+1}}{u_n} \right| < 1 \Rightarrow \lim_{n \rightarrow \infty} \left| \frac{(3x+1)^{n+2}}{2n+4} \cdot \frac{2n+2}{(3x+1)^{n+1}} \right| < 1 \Rightarrow |3x+1| \lim_{n \rightarrow \infty} \left(\frac{2n+2}{2n+4} \right) < 1 \Rightarrow |3x+1| < 1$$

$$\Rightarrow -1 < 3x+1 < 1 \Rightarrow -\frac{2}{3} < x < 0; \text{ when } x = -\frac{2}{3} \text{ we have } \sum_{n=1}^{\infty} \frac{(-1)^{n+1}}{2n+1}, \text{ a conditionally convergent series;}$$

when $x = 0$ we have $\sum_{n=1}^{\infty} \frac{(1)^{n+1}}{2n+1} = \sum_{n=1}^{\infty} \frac{1}{2n+1}$, a divergent series

- (a) the radius is $\frac{1}{3}$; the interval of convergence is $-\frac{2}{3} \leq x < 0$
 (b) the interval of absolute convergence is $-\frac{2}{3} < x < 0$
 (c) the series converges conditionally at $x = -\frac{2}{3}$

$$31. \lim_{n \rightarrow \infty} \left| \frac{u_{n+1}}{u_n} \right| < 1 \Rightarrow \lim_{n \rightarrow \infty} \left| \frac{(x+\pi)^{n+1}}{\sqrt{n+1}} \cdot \frac{\sqrt{n}}{(x+\pi)^n} \right| < 1 \Rightarrow |x+\pi| \lim_{n \rightarrow \infty} \left| \sqrt{\frac{n}{n+1}} \right| < 1$$

$$\Rightarrow |x+\pi| \sqrt{\lim_{n \rightarrow \infty} \left(\frac{n}{n+1} \right)} < 1 \Rightarrow |x+\pi| < 1 \Rightarrow -1 < x+\pi < 1 \Rightarrow -1-\pi < x < 1-\pi;$$

when $x = -1 - \pi$ we have $\sum_{n=1}^{\infty} \frac{(-1)^n}{\sqrt{n}} = \sum_{n=1}^{\infty} \frac{(-1)^n}{n^{1/2}}$, a conditionally convergent series; when $x = 1 - \pi$ we have

$\sum_{n=1}^{\infty} \frac{1^n}{\sqrt{n}} = \sum_{n=1}^{\infty} \frac{1}{n^{1/2}}$, a divergent p-series

- (a) the radius is 1; the interval of convergence is $(-1 - \pi) \leq x < (1 - \pi)$
 (b) the interval of absolute convergence is $-1 - \pi < x < 1 - \pi$
 (c) the series converges conditionally at $x = -1 - \pi$

$$32. \lim_{n \rightarrow \infty} \left| \frac{u_{n+1}}{u_n} \right| < 1 \Rightarrow \lim_{n \rightarrow \infty} \left| \frac{(x-\sqrt{2})^{2n+3}}{2^{n+1}} \cdot \frac{2^n}{(x-\sqrt{2})^{2n+1}} \right| < 1 \Rightarrow \frac{(x-\sqrt{2})^2}{2} \lim_{n \rightarrow \infty} |1| < 1$$

$$\Rightarrow \frac{(x-\sqrt{2})^2}{2} < 1 \Rightarrow (x-\sqrt{2})^2 < 2 \Rightarrow |x-\sqrt{2}| < \sqrt{2} \Rightarrow -\sqrt{2} < x-\sqrt{2} < \sqrt{2} \Rightarrow 0 < x < 2\sqrt{2}; \text{ when}$$

$x = 0$ we have $\sum_{n=1}^{\infty} \frac{(-\sqrt{2})^{2n+1}}{2^n} = -\sum_{n=1}^{\infty} \frac{2^{n+1/2}}{2^n} = -\sum_{n=1}^{\infty} \sqrt{2}$ which diverges since $\lim_{n \rightarrow \infty} a_n \neq 0$; when $x = 2\sqrt{2}$

we have $\sum_{n=1}^{\infty} \frac{(\sqrt{2})^{2n+1}}{2^n} = \sum_{n=1}^{\infty} \frac{2^{n+1/2}}{2^n} = \sum_{n=1}^{\infty} \sqrt{2}$, a divergent series

- (a) the radius is $\sqrt{2}$; the interval of convergence is $0 < x < 2\sqrt{2}$
 (b) the interval of absolute convergence is $0 < x < 2\sqrt{2}$
 (c) there are no values for which the series converges conditionally

$$33. \lim_{n \rightarrow \infty} \left| \frac{u_{n+1}}{u_n} \right| < 1 \Rightarrow \lim_{n \rightarrow \infty} \left| \frac{(x-1)^{2n+2}}{4^{n+1}} \cdot \frac{4^n}{(x-1)^{2n}} \right| < 1 \Rightarrow \frac{(x-1)^2}{4} \lim_{n \rightarrow \infty} |1| < 1 \Rightarrow (x-1)^2 < 4 \Rightarrow |x-1| < 2$$

$$\Rightarrow -2 < x-1 < 2 \Rightarrow -1 < x < 3; \text{ at } x = -1 \text{ we have } \sum_{n=0}^{\infty} \frac{(-2)^{2n}}{4^n} = \sum_{n=0}^{\infty} \frac{4^n}{4^n} = \sum_{n=0}^{\infty} 1, \text{ which diverges; at } x = 3$$

we have $\sum_{n=0}^{\infty} \frac{2^{2n}}{4^n} = \sum_{n=0}^{\infty} \frac{4^n}{4^n} = \sum_{n=0}^{\infty} 1$, a divergent series; the interval of convergence is $-1 < x < 3$; the series

$\sum_{n=0}^{\infty} \frac{(x-1)^{2n}}{4^n} = \sum_{n=0}^{\infty} \left(\left(\frac{x-1}{2} \right)^2 \right)^n$ is a convergent geometric series when $-1 < x < 3$ and the sum is

$$\frac{1}{1 - \left(\frac{x-1}{2} \right)^2} = \frac{1}{\left[\frac{4 - (x-1)^2}{4} \right]} = \frac{4}{4 - x^2 + 2x - 1} = \frac{4}{3 + 2x - x^2}$$

$$34. \lim_{n \rightarrow \infty} \left| \frac{u_{n+1}}{u_n} \right| < 1 \Rightarrow \lim_{n \rightarrow \infty} \left| \frac{(x+1)^{2n+2}}{9^{n+1}} \cdot \frac{9^n}{(x+1)^{2n}} \right| < 1 \Rightarrow \frac{(x+1)^2}{9} \lim_{n \rightarrow \infty} |1| < 1 \Rightarrow (x+1)^2 < 9 \Rightarrow |x+1| < 3$$

$$\Rightarrow -3 < x+1 < 3 \Rightarrow -4 < x < 2; \text{ when } x = -4 \text{ we have } \sum_{n=0}^{\infty} \frac{(-3)^{2n}}{9^n} = \sum_{n=0}^{\infty} 1 \text{ which diverges; at } x = 2 \text{ we have}$$

$\sum_{n=0}^{\infty} \frac{3^{2n}}{9^n} = \sum_{n=0}^{\infty} 1$ which also diverges; the interval of convergence is $-4 < x < 2$; the series

$\sum_{n=0}^{\infty} \frac{(x+1)^{2n}}{9^n} = \sum_{n=0}^{\infty} \left(\left(\frac{x+1}{3} \right)^2 \right)^n$ is a convergent geometric series when $-4 < x < 2$ and the sum is

$$\frac{1}{1 - \left(\frac{x+1}{3} \right)^2} = \frac{1}{\left[\frac{9 - (x+1)^2}{9} \right]} = \frac{9}{9 - x^2 - 2x - 1} = \frac{9}{8 - 2x - x^2}$$

$$35. \lim_{n \rightarrow \infty} \left| \frac{u_{n+1}}{u_n} \right| < 1 \Rightarrow \lim_{n \rightarrow \infty} \left| \frac{(\sqrt{x}-2)^{n+1}}{2^{n+1}} \cdot \frac{2^n}{(\sqrt{x}-2)^n} \right| < 1 \Rightarrow |\sqrt{x}-2| < 2 \Rightarrow -2 < \sqrt{x}-2 < 2 \Rightarrow 0 < \sqrt{x} < 4$$

$$\Rightarrow 0 < x < 16; \text{ when } x = 0 \text{ we have } \sum_{n=0}^{\infty} (-1)^n, \text{ a divergent series; when } x = 16 \text{ we have } \sum_{n=0}^{\infty} (1)^n, \text{ a divergent}$$

series; the interval of convergence is $0 < x < 16$; the series $\sum_{n=0}^{\infty} \left(\frac{\sqrt{x}-2}{2} \right)^n$ is a convergent geometric series when

$0 < x < 16$ and its sum is $\frac{1}{1 - \left(\frac{\sqrt{x}-2}{2} \right)} = \frac{1}{\left(\frac{2 - \sqrt{x} + 2}{2} \right)} = \frac{2}{4 - \sqrt{x}}$

$$36. \lim_{n \rightarrow \infty} \left| \frac{u_{n+1}}{u_n} \right| < 1 \Rightarrow \lim_{n \rightarrow \infty} \left| \frac{(\ln x)^{n+1}}{(\ln x)^n} \right| < 1 \Rightarrow |\ln x| < 1 \Rightarrow -1 < \ln x < 1 \Rightarrow e^{-1} < x < e; \text{ when } x = e^{-1} \text{ or } e \text{ we}$$

$$\text{obtain the series } \sum_{n=0}^{\infty} 1^n \text{ and } \sum_{n=0}^{\infty} (-1)^n \text{ which both diverge; the interval of convergence is } e^{-1} < x < e;$$

$\sum_{n=0}^{\infty} (\ln x)^n = \frac{1}{1 - \ln x}$ when $e^{-1} < x < e$

$$37. \lim_{n \rightarrow \infty} \left| \frac{u_{n+1}}{u_n} \right| < 1 \Rightarrow \lim_{n \rightarrow \infty} \left| \left(\frac{x^2+1}{3} \right)^{n+1} \cdot \left(\frac{3}{x^2+1} \right)^n \right| < 1 \Rightarrow \frac{(x^2+1)}{3} \lim_{n \rightarrow \infty} |1| < 1 \Rightarrow \frac{x^2+1}{3} < 1 \Rightarrow x^2 < 2$$

$\Rightarrow |x| < \sqrt{2} \Rightarrow -\sqrt{2} < x < \sqrt{2}$; at $x = \pm \sqrt{2}$ we have $\sum_{n=0}^{\infty} (1)^n$ which diverges; the interval of convergence is

$-\sqrt{2} < x < \sqrt{2}$; the series $\sum_{n=0}^{\infty} \left(\frac{x^2+1}{3} \right)^n$ is a convergent geometric series when $-\sqrt{2} < x < \sqrt{2}$ and its sum is

$$\frac{1}{1 - \left(\frac{x^2+1}{3} \right)} = \frac{1}{\left(\frac{3 - x^2 - 1}{3} \right)} = \frac{3}{2 - x^2}$$

38. $\lim_{n \rightarrow \infty} \left| \frac{u_{n+1}}{u_n} \right| < 1 \Rightarrow \lim_{n \rightarrow \infty} \left| \frac{(x^2-1)^{n+1}}{2^{n+1}} \cdot \frac{2^n}{(x^2+1)^n} \right| < 1 \Rightarrow |x^2-1| < 2 \Rightarrow -\sqrt{3} < x < \sqrt{3}$; when $x = \pm \sqrt{3}$ we have $\sum_{n=0}^{\infty} 1^n$, a divergent series; the interval of convergence is $-\sqrt{3} < x < \sqrt{3}$; the series $\sum_{n=0}^{\infty} \left(\frac{x^2-1}{2}\right)^n$ is a convergent geometric series when $-\sqrt{3} < x < \sqrt{3}$ and its sum is $\frac{1}{1-\left(\frac{x^2-1}{2}\right)} = \frac{1}{\left(\frac{2-(x^2-1)}{2}\right)} = \frac{2}{3-x^2}$

39. $\lim_{n \rightarrow \infty} \left| \frac{(x-3)^{n+1}}{2^{n+1}} \cdot \frac{2^n}{(x-3)^n} \right| < 1 \Rightarrow |x-3| < 2 \Rightarrow 1 < x < 5$; when $x = 1$ we have $\sum_{n=1}^{\infty} (1)^n$ which diverges; when $x = 5$ we have $\sum_{n=1}^{\infty} (-1)^n$ which also diverges; the interval of convergence is $1 < x < 5$; the sum of this convergent geometric series is $\frac{1}{1-\left(\frac{x-3}{2}\right)} = \frac{2}{x-1}$. If $f(x) = 1 - \frac{1}{2}(x-3) + \frac{1}{4}(x-3)^2 + \dots + \left(-\frac{1}{2}\right)^n(x-3)^n + \dots = \frac{2}{x-1}$ then $f'(x) = -\frac{1}{2} + \frac{1}{2}(x-3) + \dots + \left(-\frac{1}{2}\right)^n n(x-3)^{n-1} + \dots$ is convergent when $1 < x < 5$, and diverges when $x = 1$ or 5 . The sum for $f'(x)$ is $\frac{-2}{(x-1)^2}$, the derivative of $\frac{2}{x-1}$.

40. If $f(x) = 1 - \frac{1}{2}(x-3) + \frac{1}{4}(x-3)^2 + \dots + \left(-\frac{1}{2}\right)^n(x-3)^n + \dots = \frac{2}{x-1}$ then $\int f(x) dx = x - \frac{(x-3)^2}{4} + \frac{(x-3)^3}{12} + \dots + \left(-\frac{1}{2}\right)^n \frac{(x-3)^{n+1}}{n+1} + \dots$. At $x = 1$ the series $\sum_{n=1}^{\infty} \frac{-2}{n+1}$ diverges; at $x = 5$ the series $\sum_{n=1}^{\infty} \frac{(-1)^n 2}{n+1}$ converges. Therefore the interval of convergence is $1 < x \leq 5$ and the sum is $2 \ln|x-1| + (3 - \ln 4)$, since $\int \frac{2}{x-1} dx = 2 \ln|x-1| + C$, where $C = 3 - \ln 4$ when $x = 3$.

41. (a) Differentiate the series for $\sin x$ to get $\cos x = 1 - \frac{3x^2}{3!} + \frac{5x^4}{5!} - \frac{7x^6}{7!} + \frac{9x^8}{9!} - \frac{11x^{10}}{11!} + \dots = 1 - \frac{x^2}{2!} + \frac{x^4}{4!} - \frac{x^6}{6!} + \frac{x^8}{8!} - \frac{x^{10}}{10!} + \dots$. The series converges for all values of x since $\lim_{n \rightarrow \infty} \left| \frac{x^{2n+2}}{(2n+2)!} \cdot \frac{(2n)!}{x^{2n}} \right| = x^2 \lim_{n \rightarrow \infty} \left(\frac{1}{(2n+1)(2n+2)} \right) = 0 < 1$ for all x .

(b) $\sin 2x = 2x - \frac{2^3 x^3}{3!} + \frac{2^5 x^5}{5!} - \frac{2^7 x^7}{7!} + \frac{2^9 x^9}{9!} - \frac{2^{11} x^{11}}{11!} + \dots = 2x - \frac{8x^3}{3!} + \frac{32x^5}{5!} - \frac{128x^7}{7!} + \frac{512x^9}{9!} - \frac{2048x^{11}}{11!} + \dots$

(c) $2 \sin x \cos x = 2 \left[(0 \cdot 1) + (0 \cdot 0 + 1 \cdot 1)x + (0 \cdot \frac{-1}{2} + 1 \cdot 0 + 0 \cdot 1)x^2 + (0 \cdot 0 - 1 \cdot \frac{1}{2} + 0 \cdot 0 - 1 \cdot \frac{1}{3!})x^3 + (0 \cdot \frac{1}{4!} + 1 \cdot 0 - 0 \cdot \frac{1}{2} - 0 \cdot \frac{1}{3!} + 0 \cdot 1)x^4 + (0 \cdot 0 + 1 \cdot \frac{1}{4!} + 0 \cdot 0 + \frac{1}{2} \cdot \frac{1}{3!} + 0 \cdot 0 + 1 \cdot \frac{1}{5!})x^5 + (0 \cdot \frac{1}{6!} + 1 \cdot 0 + 0 \cdot \frac{1}{4!} + 0 \cdot \frac{1}{3!} + 0 \cdot \frac{1}{2} + 0 \cdot \frac{1}{5!} + 0 \cdot 1)x^6 + \dots \right] = 2 \left[x - \frac{4x^3}{3!} + \frac{16x^5}{5!} - \dots \right] = 2x - \frac{2^3 x^3}{3!} + \frac{2^5 x^5}{5!} - \frac{2^7 x^7}{7!} + \frac{2^9 x^9}{9!} - \frac{2^{11} x^{11}}{11!} + \dots$

42. (a) $\frac{d}{dx}(e^x) = 1 + \frac{2x}{2!} + \frac{3x^2}{3!} + \frac{4x^3}{4!} + \frac{5x^4}{5!} + \dots = 1 + x + \frac{x^2}{2!} + \frac{x^3}{3!} + \frac{x^4}{4!} + \dots = e^x$; thus the derivative of e^x is e^x itself

(b) $\int e^x dx = e^x + C = x + \frac{x^2}{2} + \frac{x^3}{3!} + \frac{x^4}{4!} + \frac{x^5}{5!} + \dots + C$, which is the general antiderivative of e^x

(c) $e^{-x} = 1 - x + \frac{x^2}{2!} - \frac{x^3}{3!} + \frac{x^4}{4!} - \frac{x^5}{5!} + \dots$; $e^{-x} \cdot e^x = 1 \cdot 1 + (1 \cdot 1 - 1 \cdot 1)x + (1 \cdot \frac{1}{2!} - 1 \cdot 1 + \frac{1}{2!} \cdot 1)x^2 + (1 \cdot \frac{1}{3!} - 1 \cdot \frac{1}{2!} + \frac{1}{2!} \cdot 1 - \frac{1}{3!} \cdot 1 + \frac{1}{4!} \cdot 1)x^3 + (1 \cdot \frac{1}{5!} - 1 \cdot \frac{1}{4!} + \frac{1}{4!} \cdot \frac{1}{3!} - \frac{1}{3!} \cdot \frac{1}{2!} + \frac{1}{4!} \cdot 1 - \frac{1}{5!} \cdot 1)x^5 + \dots = 1 + 0 + 0 + 0 + 0 + 0 + \dots$

43. (a) $\ln|\sec x| + C = \int \tan x dx = \int \left(x + \frac{x^3}{3} + \frac{2x^5}{15} + \frac{17x^7}{315} + \frac{62x^9}{2835} + \dots \right) dx = \frac{x^2}{2} + \frac{x^4}{12} + \frac{x^6}{45} + \frac{17x^8}{2520} + \frac{31x^{10}}{14,175} + \dots + C$; $x = 0 \Rightarrow C = 0 \Rightarrow \ln|\sec x| = \frac{x^2}{2} + \frac{x^4}{12} + \frac{x^6}{45} + \frac{17x^8}{2520} + \frac{31x^{10}}{14,175} + \dots$, converges when $-\frac{\pi}{2} < x < \frac{\pi}{2}$

(b) $\sec^2 x = \frac{d(\tan x)}{dx} = \frac{d}{dx} \left(x + \frac{x^3}{3} + \frac{2x^5}{15} + \frac{17x^7}{315} + \frac{62x^9}{2835} + \dots \right) = 1 + x^2 + \frac{2x^4}{3} + \frac{17x^6}{45} + \frac{62x^8}{315} + \dots$, converges when $-\frac{\pi}{2} < x < \frac{\pi}{2}$

$$\begin{aligned}
 \text{(c) } \sec^2 x &= (\sec x)(\sec x) = \left(1 + \frac{x^2}{2} + \frac{5x^4}{24} + \frac{61x^6}{720} + \dots\right) \left(1 + \frac{x^2}{2} + \frac{5x^4}{24} + \frac{61x^6}{720} + \dots\right) \\
 &= 1 + \left(\frac{1}{2} + \frac{1}{2}\right)x^2 + \left(\frac{5}{24} + \frac{1}{4} + \frac{5}{24}\right)x^4 + \left(\frac{61}{720} + \frac{5}{48} + \frac{5}{48} + \frac{61}{720}\right)x^6 + \dots \\
 &= 1 + x^2 + \frac{2x^4}{3} + \frac{17x^6}{45} + \frac{62x^8}{315} + \dots, \quad -\frac{\pi}{2} < x < \frac{\pi}{2}
 \end{aligned}$$

$$\begin{aligned}
 44. \text{ (a) } \ln |\sec x + \tan x| + C &= \int \sec x \, dx = \int \left(1 + \frac{x^2}{2} + \frac{5x^4}{24} + \frac{61x^6}{720} + \dots\right) dx \\
 &= x + \frac{x^3}{6} + \frac{x^5}{24} + \frac{61x^7}{5040} + \frac{277x^9}{72,576} + \dots + C; \quad x = 0 \Rightarrow C = 0 \Rightarrow \ln |\sec x + \tan x| \\
 &= x + \frac{x^3}{6} + \frac{x^5}{24} + \frac{61x^7}{5040} + \frac{277x^9}{72,576} + \dots, \text{ converges when } -\frac{\pi}{2} < x < \frac{\pi}{2}
 \end{aligned}$$

$$\text{(b) } \sec x \tan x = \frac{d(\sec x)}{dx} = \frac{d}{dx} \left(1 + \frac{x^2}{2} + \frac{5x^4}{24} + \frac{61x^6}{720} + \dots\right) = x + \frac{5x^3}{6} + \frac{61x^5}{120} + \frac{277x^7}{1008} + \dots, \text{ converges} \\
 \text{when } -\frac{\pi}{2} < x < \frac{\pi}{2}$$

$$\begin{aligned}
 \text{(c) } (\sec x)(\tan x) &= \left(1 + \frac{x^2}{2} + \frac{5x^4}{24} + \frac{61x^6}{720} + \dots\right) \left(x + \frac{x^3}{3} + \frac{2x^5}{15} + \frac{17x^7}{315} + \dots\right) \\
 &= x + \left(\frac{1}{3} + \frac{1}{2}\right)x^3 + \left(\frac{2}{15} + \frac{1}{6} + \frac{5}{24}\right)x^5 + \left(\frac{17}{315} + \frac{1}{15} + \frac{5}{72} + \frac{61}{720}\right)x^7 + \dots = x + \frac{5x^3}{6} + \frac{61x^5}{120} + \frac{277x^7}{1008} + \dots, \\
 &-\frac{\pi}{2} < x < \frac{\pi}{2}
 \end{aligned}$$

$$\begin{aligned}
 45. \text{ (a) } \text{ If } f(x) &= \sum_{n=0}^{\infty} a_n x^n, \text{ then } f^{(k)}(x) = \sum_{n=k}^{\infty} n(n-1)(n-2)\cdots(n-k+1)a_n x^{n-k} \text{ and } f^{(k)}(0) = k!a_k \\
 &\Rightarrow a_k = \frac{f^{(k)}(0)}{k!}; \text{ likewise if } f(x) = \sum_{n=0}^{\infty} b_n x^n, \text{ then } b_k = \frac{f^{(k)}(0)}{k!} \Rightarrow a_k = b_k \text{ for every nonnegative integer } k
 \end{aligned}$$

$$\text{(b) If } f(x) = \sum_{n=0}^{\infty} a_n x^n = 0 \text{ for all } x, \text{ then } f^{(k)}(x) = 0 \text{ for all } x \Rightarrow \text{from part (a) that } a_k = 0 \text{ for every} \\
 \text{nonnegative integer } k$$

$$\begin{aligned}
 46. \frac{1}{1-x} &= 1 + x + x^2 + x^3 + x^4 + \dots \Rightarrow x \left[\frac{1}{(1-x)^2}\right] = x(1 + 2x + 3x^2 + 4x^3 + \dots) \Rightarrow \frac{x}{(1-x)^2} \\
 &= x + 2x^2 + 3x^3 + 4x^4 + \dots \Rightarrow x \left[\frac{1+x}{(1-x)^3}\right] = x(1 + 4x + 9x^2 + 16x^3 + \dots) \Rightarrow \frac{x+x^2}{(1-x)^3} \\
 &= x + 4x^2 + 9x^3 + 16x^4 + \dots \Rightarrow \frac{\left(\frac{1}{2} + \frac{1}{4}\right)}{\left(\frac{1}{8}\right)} = \frac{1}{2} + \frac{4}{4} + \frac{9}{8} + \frac{16}{16} + \dots \Rightarrow \sum_{n=1}^{\infty} \frac{n^2}{2^n} = 6
 \end{aligned}$$

47. The series $\sum_{n=1}^{\infty} \frac{x^n}{n}$ converges conditionally at the left-hand endpoint of its interval of convergence $[-1, 1)$; the series $\sum_{n=1}^{\infty} \frac{x^n}{(n^2)}$ converges absolutely at the left-hand endpoint of its interval of convergence $[-1, 1]$

48. Answers will vary. For instance:

$$\text{(a) } \sum_{n=1}^{\infty} \left(\frac{x}{3}\right)^n \qquad \text{(b) } \sum_{n=1}^{\infty} (x+1)^n \qquad \text{(c) } \sum_{n=1}^{\infty} \left(\frac{x-3}{2}\right)^n$$

11.8 TAYLOR AND MACLAURIN SERIES

- $f(x) = \ln x, f'(x) = \frac{1}{x}, f''(x) = -\frac{1}{x^2}, f'''(x) = \frac{2}{x^3}; f(1) = \ln 1 = 0, f'(1) = 1, f''(1) = -1, f'''(1) = 2 \Rightarrow P_0(x) = 0,$
 $P_1(x) = (x-1), P_2(x) = (x-1) - \frac{1}{2}(x-1)^2, P_3(x) = (x-1) - \frac{1}{2}(x-1)^2 + \frac{1}{3}(x-1)^3$
- $f(x) = \ln(1+x), f'(x) = \frac{1}{1+x} = (1+x)^{-1}, f''(x) = -(1+x)^{-2}, f'''(x) = 2(1+x)^{-3}; f(0) = \ln 1 = 0,$
 $f'(0) = \frac{1}{1} = 1, f''(0) = -(1)^{-2} = -1, f'''(0) = 2(1)^{-3} = 2 \Rightarrow P_0(x) = 0, P_1(x) = x, P_2(x) = x - \frac{x^2}{2}, P_3(x)$
 $= x - \frac{x^2}{2} + \frac{x^3}{3}$

3. $f(x) = \frac{1}{x} = x^{-1}$, $f'(x) = -x^{-2}$, $f''(x) = 2x^{-3}$, $f'''(x) = -6x^{-4}$; $f(2) = \frac{1}{2}$, $f'(2) = -\frac{1}{4}$, $f''(2) = \frac{1}{4}$, $f'''(x) = -\frac{3}{8}$
 $\Rightarrow P_0(x) = \frac{1}{2}$, $P_1(x) = \frac{1}{2} - \frac{1}{4}(x-2)$, $P_2(x) = \frac{1}{2} - \frac{1}{4}(x-2) + \frac{1}{8}(x-2)^2$,
 $P_3(x) = \frac{1}{2} - \frac{1}{4}(x-2) + \frac{1}{8}(x-2)^2 - \frac{1}{16}(x-2)^3$
4. $f(x) = (x+2)^{-1}$, $f'(x) = -(x+2)^{-2}$, $f''(x) = 2(x+2)^{-3}$, $f'''(x) = -6(x+2)^{-4}$; $f(0) = (2)^{-1} = \frac{1}{2}$, $f'(0) = -(2)^{-2} = -\frac{1}{4}$, $f''(0) = 2(2)^{-3} = \frac{1}{4}$, $f'''(0) = -6(2)^{-4} = -\frac{3}{8} \Rightarrow P_0(x) = \frac{1}{2}$, $P_1(x) = \frac{1}{2} - \frac{x}{4}$, $P_2(x) = \frac{1}{2} - \frac{x}{4} + \frac{x^2}{8}$,
 $P_3(x) = \frac{1}{2} - \frac{x}{4} + \frac{x^2}{8} - \frac{x^3}{16}$
5. $f(x) = \sin x$, $f'(x) = \cos x$, $f''(x) = -\sin x$, $f'''(x) = -\cos x$; $f\left(\frac{\pi}{4}\right) = \sin \frac{\pi}{4} = \frac{\sqrt{2}}{2}$, $f'\left(\frac{\pi}{4}\right) = \cos \frac{\pi}{4} = \frac{\sqrt{2}}{2}$,
 $f''\left(\frac{\pi}{4}\right) = -\sin \frac{\pi}{4} = -\frac{\sqrt{2}}{2}$, $f'''\left(\frac{\pi}{4}\right) = -\cos \frac{\pi}{4} = -\frac{\sqrt{2}}{2} \Rightarrow P_0 = \frac{\sqrt{2}}{2}$, $P_1(x) = \frac{\sqrt{2}}{2} + \frac{\sqrt{2}}{2}\left(x - \frac{\pi}{4}\right)$,
 $P_2(x) = \frac{\sqrt{2}}{2} + \frac{\sqrt{2}}{2}\left(x - \frac{\pi}{4}\right) - \frac{\sqrt{2}}{4}\left(x - \frac{\pi}{4}\right)^2$, $P_3(x) = \frac{\sqrt{2}}{2} + \frac{\sqrt{2}}{2}\left(x - \frac{\pi}{4}\right) - \frac{\sqrt{2}}{4}\left(x - \frac{\pi}{4}\right)^2 + \frac{\sqrt{2}}{12}\left(x - \frac{\pi}{4}\right)^3$
6. $f(x) = \cos x$, $f'(x) = -\sin x$, $f''(x) = -\cos x$, $f'''(x) = \sin x$; $f\left(\frac{\pi}{4}\right) = \cos \frac{\pi}{4} = \frac{1}{\sqrt{2}}$,
 $f'\left(\frac{\pi}{4}\right) = -\sin \frac{\pi}{4} = -\frac{1}{\sqrt{2}}$, $f''\left(\frac{\pi}{4}\right) = -\cos \frac{\pi}{4} = -\frac{1}{\sqrt{2}}$, $f'''\left(\frac{\pi}{4}\right) = \sin \frac{\pi}{4} = \frac{1}{\sqrt{2}} \Rightarrow P_0(x) = \frac{1}{\sqrt{2}}$,
 $P_1(x) = \frac{1}{\sqrt{2}} - \frac{1}{\sqrt{2}}\left(x - \frac{\pi}{4}\right)$, $P_2(x) = \frac{1}{\sqrt{2}} - \frac{1}{\sqrt{2}}\left(x - \frac{\pi}{4}\right) - \frac{1}{2\sqrt{2}}\left(x - \frac{\pi}{4}\right)^2$,
 $P_3(x) = \frac{1}{\sqrt{2}} - \frac{1}{\sqrt{2}}\left(x - \frac{\pi}{4}\right) - \frac{1}{2\sqrt{2}}\left(x - \frac{\pi}{4}\right)^2 + \frac{1}{6\sqrt{2}}\left(x - \frac{\pi}{4}\right)^3$
7. $f(x) = \sqrt{x} = x^{1/2}$, $f'(x) = \left(\frac{1}{2}\right)x^{-1/2}$, $f''(x) = \left(-\frac{1}{4}\right)x^{-3/2}$, $f'''(x) = \left(\frac{3}{8}\right)x^{-5/2}$; $f(4) = \sqrt{4} = 2$,
 $f'(4) = \left(\frac{1}{2}\right)4^{-1/2} = \frac{1}{4}$, $f''(4) = \left(-\frac{1}{4}\right)4^{-3/2} = -\frac{1}{32}$, $f'''(4) = \left(\frac{3}{8}\right)4^{-5/2} = \frac{3}{256} \Rightarrow P_0(x) = 2$, $P_1(x) = 2 + \frac{1}{4}(x-4)$,
 $P_2(x) = 2 + \frac{1}{4}(x-4) - \frac{1}{64}(x-4)^2$, $P_3(x) = 2 + \frac{1}{4}(x-4) - \frac{1}{64}(x-4)^2 + \frac{1}{512}(x-4)^3$
8. $f(x) = (x+4)^{1/2}$, $f'(x) = \left(\frac{1}{2}\right)(x+4)^{-1/2}$, $f''(x) = \left(-\frac{1}{4}\right)(x+4)^{-3/2}$, $f'''(x) = \left(\frac{3}{8}\right)(x+4)^{-5/2}$; $f(0) = (4)^{1/2} = 2$,
 $f'(0) = \left(\frac{1}{2}\right)(4)^{-1/2} = \frac{1}{4}$, $f''(0) = \left(-\frac{1}{4}\right)(4)^{-3/2} = -\frac{1}{32}$, $f'''(0) = \left(\frac{3}{8}\right)(4)^{-5/2} = \frac{3}{256} \Rightarrow P_0(x) = 2$,
 $P_1(x) = 2 + \frac{1}{4}x$, $P_2(x) = 2 + \frac{1}{4}x - \frac{1}{64}x^2$, $P_3(x) = 2 + \frac{1}{4}x - \frac{1}{64}x^2 + \frac{1}{512}x^3$
9. $e^x = \sum_{n=0}^{\infty} \frac{x^n}{n!} \Rightarrow e^{-x} = \sum_{n=0}^{\infty} \frac{(-x)^n}{n!} = 1 - x + \frac{x^2}{2!} - \frac{x^3}{3!} + \frac{x^4}{4!} - \dots$
10. $e^x = \sum_{n=0}^{\infty} \frac{x^n}{n!} \Rightarrow e^{x/2} = \sum_{n=0}^{\infty} \frac{\left(\frac{x}{2}\right)^n}{n!} = 1 + \frac{x}{2} + \frac{x^2}{4 \cdot 2!} + \frac{x^3}{2^3 \cdot 3!} + \frac{x^4}{2^4 \cdot 4!} + \dots$
11. $f(x) = (1+x)^{-1} \Rightarrow f'(x) = -(1+x)^{-2}$, $f''(x) = 2(1+x)^{-3}$, $f'''(x) = -3!(1+x)^{-4} \Rightarrow \dots f^{(k)}(x) = (-1)^k k!(1+x)^{-k-1}$; $f(0) = 1$, $f'(0) = -1$, $f''(0) = 2$, $f'''(0) = -3!$, \dots , $f^{(k)}(0) = (-1)^k k!$
 $\Rightarrow \frac{1}{1+x} = 1 - x + x^2 - x^3 + \dots = \sum_{n=0}^{\infty} (-x)^n = \sum_{n=0}^{\infty} (-1)^n x^n$
12. $f(x) = (1-x)^{-1} \Rightarrow f'(x) = (1-x)^{-2}$, $f''(x) = 2(1-x)^{-3}$, $f'''(x) = 3!(1-x)^{-4} \Rightarrow \dots f^{(k)}(x) = k!(1-x)^{-k-1}$; $f(0) = 1$, $f'(0) = 1$, $f''(0) = 2$, $f'''(0) = 3!$, \dots , $f^{(k)}(0) = k!$
 $\Rightarrow \frac{1}{1-x} = 1 + x + x^2 + x^3 + \dots = \sum_{n=0}^{\infty} x^n$
13. $\sin x = \sum_{n=0}^{\infty} \frac{(-1)^n x^{2n+1}}{(2n+1)!} \Rightarrow \sin 3x = \sum_{n=0}^{\infty} \frac{(-1)^n (3x)^{2n+1}}{(2n+1)!} = \sum_{n=0}^{\infty} \frac{(-1)^n 3^{2n+1} x^{2n+1}}{(2n+1)!} = 3x - \frac{3^3 x^3}{3!} + \frac{3^5 x^5}{5!} - \dots$

$$14. \sin x = \sum_{n=0}^{\infty} \frac{(-1)^n x^{2n+1}}{(2n+1)!} \Rightarrow \sin \frac{x}{2} = \sum_{n=0}^{\infty} \frac{(-1)^n \left(\frac{x}{2}\right)^{2n+1}}{(2n+1)!} = \sum_{n=0}^{\infty} \frac{(-1)^n x^{2n+1}}{2^{2n+1}(2n+1)!} = \frac{x}{2} - \frac{x^3}{2^3 \cdot 3!} + \frac{x^5}{2^5 \cdot 5!} + \dots$$

$$15. 7 \cos(-x) = 7 \cos x = 7 \sum_{n=0}^{\infty} \frac{(-1)^n x^{2n}}{(2n)!} = 7 - \frac{7x^2}{2!} + \frac{7x^4}{4!} - \frac{7x^6}{6!} + \dots, \text{ since the cosine is an even function}$$

$$16. \cos x = \sum_{n=0}^{\infty} \frac{(-1)^n x^{2n}}{(2n)!} \Rightarrow 5 \cos \pi x = 5 \sum_{n=0}^{\infty} \frac{(-1)^n (\pi x)^{2n}}{(2n)!} = 5 - \frac{5\pi^2 x^2}{2!} + \frac{5\pi^4 x^4}{4!} - \frac{5\pi^6 x^6}{6!} + \dots$$

$$17. \cosh x = \frac{e^x + e^{-x}}{2} = \frac{1}{2} \left[\left(1 + x^2 + \frac{x^2}{2!} + \frac{x^3}{3!} + \frac{x^4}{4!} + \dots \right) + \left(1 - x + \frac{x^2}{2!} - \frac{x^3}{3!} + \frac{x^4}{4!} - \dots \right) \right] = 1 + \frac{x^2}{2!} + \frac{x^4}{4!} + \frac{x^6}{6!} + \dots$$

$$= \sum_{n=0}^{\infty} \frac{x^{2n}}{(2n)!}$$

$$18. \sinh x = \frac{e^x - e^{-x}}{2} = \frac{1}{2} \left[\left(1 + x + \frac{x^2}{2!} + \frac{x^3}{3!} + \frac{x^4}{4!} + \dots \right) - \left(1 - x + \frac{x^2}{2!} - \frac{x^3}{3!} + \frac{x^4}{4!} - \dots \right) \right] = x + \frac{x^3}{3!} + \frac{x^5}{5!} + \frac{x^6}{6!} + \dots$$

$$= \sum_{n=0}^{\infty} \frac{x^{2n+1}}{(2n+1)!}$$

$$19. f(x) = x^4 - 2x^3 - 5x + 4 \Rightarrow f'(x) = 4x^3 - 6x^2 - 5, f''(x) = 12x^2 - 12x, f'''(x) = 24x - 12, f^{(4)}(x) = 24$$

$$\Rightarrow f^{(n)}(x) = 0 \text{ if } n \geq 5; f(0) = 4, f'(0) = -5, f''(0) = 0, f'''(0) = -12, f^{(4)}(0) = 24, f^{(n)}(0) = 0 \text{ if } n \geq 5$$

$$\Rightarrow x^4 - 2x^3 - 5x + 4 = 4 - 5x - \frac{12}{3!}x^3 + \frac{24}{4!}x^4 = x^4 - 2x^3 - 5x + 4 \text{ itself}$$

$$20. f(x) = (x+1)^2 \Rightarrow f'(x) = 2(x+1); f''(x) = 2 \Rightarrow f^{(n)}(x) = 0 \text{ if } n \geq 3; f(0) = 1, f'(0) = 2, f''(0) = 2, f^{(n)}(0) = 0 \text{ if } n \geq 3$$

$$\Rightarrow (x+1)^2 = 1 + 2x + \frac{2}{2!}x^2 = 1 + 2x + x^2$$

$$21. f(x) = x^3 - 2x + 4 \Rightarrow f'(x) = 3x^2 - 2, f''(x) = 6x, f'''(x) = 6 \Rightarrow f^{(n)}(x) = 0 \text{ if } n \geq 4; f(2) = 8, f'(2) = 10,$$

$$f''(2) = 12, f'''(2) = 6, f^{(n)}(2) = 0 \text{ if } n \geq 4 \Rightarrow x^3 - 2x + 4 = 8 + 10(x-2) + \frac{12}{2!}(x-2)^2 + \frac{6}{3!}(x-2)^3$$

$$= 8 + 10(x-2) + 6(x-2)^2 + (x-2)^3$$

$$22. f(x) = 2x^3 + x^2 + 3x - 8 \Rightarrow f'(x) = 6x^2 + 2x + 3, f''(x) = 12x + 2, f'''(x) = 12 \Rightarrow f^{(n)}(x) = 0 \text{ if } n \geq 4; f(1) = -2,$$

$$f'(1) = 11, f''(1) = 14, f'''(1) = 12, f^{(n)}(1) = 0 \text{ if } n \geq 4 \Rightarrow 2x^3 + x^2 + 3x - 8$$

$$= -2 + 11(x-1) + \frac{14}{2!}(x-1)^2 + \frac{12}{3!}(x-1)^3 = -2 + 11(x-1) + 7(x-1)^2 + 2(x-1)^3$$

$$23. f(x) = x^4 + x^2 + 1 \Rightarrow f'(x) = 4x^3 + 2x, f''(x) = 12x^2 + 2, f'''(x) = 24x, f^{(4)}(x) = 24, f^{(n)}(x) = 0 \text{ if } n \geq 5;$$

$$f(-2) = 21, f'(-2) = -36, f''(-2) = 50, f'''(-2) = -48, f^{(4)}(-2) = 24, f^{(n)}(-2) = 0 \text{ if } n \geq 5 \Rightarrow x^4 + x^2 + 1$$

$$= 21 - 36(x+2) + \frac{50}{2!}(x+2)^2 - \frac{48}{3!}(x+2)^3 + \frac{24}{4!}(x+2)^4 = 21 - 36(x+2) + 25(x+2)^2 - 8(x+2)^3 + (x+2)^4$$

$$24. f(x) = 3x^5 - x^4 + 2x^3 + x^2 - 2 \Rightarrow f'(x) = 15x^4 - 4x^3 + 6x^2 + 2x, f''(x) = 60x^3 - 12x^2 + 12x + 2,$$

$$f'''(x) = 180x^2 - 24x + 12, f^{(4)}(x) = 360x - 24, f^{(5)}(x) = 360, f^{(n)}(x) = 0 \text{ if } n \geq 6; f(-1) = -7,$$

$$f'(-1) = 23, f''(-1) = -82, f'''(-1) = 216, f^{(4)}(-1) = -384, f^{(5)}(-1) = 360, f^{(n)}(-1) = 0 \text{ if } n \geq 6$$

$$\Rightarrow 3x^5 - x^4 + 2x^3 + x^2 - 2 = -7 + 23(x+1) - \frac{82}{2!}(x+1)^2 + \frac{216}{3!}(x+1)^3 - \frac{384}{4!}(x+1)^4 + \frac{360}{5!}(x+1)^5$$

$$= -7 + 23(x+1) - 41(x+1)^2 + 36(x+1)^3 - 16(x+1)^4 + 3(x+1)^5$$

$$25. f(x) = x^{-2} \Rightarrow f'(x) = -2x^{-3}, f''(x) = 3!x^{-4}, f'''(x) = -4!x^{-5} \Rightarrow f^{(n)}(x) = (-1)^n(n+1)!x^{-n-2};$$

$$f(1) = 1, f'(1) = -2, f''(1) = 3!, f'''(1) = -4!, f^{(n)}(1) = (-1)^n(n+1)! \Rightarrow \frac{1}{x^2}$$

$$= 1 - 2(x-1) + 3(x-1)^2 - 4(x-1)^3 + \dots = \sum_{n=0}^{\infty} (-1)^n(n+1)(x-1)^n$$

$$26. f(x) = \frac{x}{1-x} \Rightarrow f'(x) = (1-x)^{-2}, f''(x) = 2(1-x)^{-3}, f'''(x) = 3!(1-x)^{-4} \Rightarrow f^{(n)}(x) = n!(1-x)^{-n-1};$$

$$f(0) = 0, f'(0) = 1, f''(0) = 2, f'''(0) = 3! \Rightarrow \frac{x}{1-x} = x + x^2 + x^3 + \dots = \sum_{n=0}^{\infty} x^{n+1}$$

$$27. f(x) = e^x \Rightarrow f'(x) = e^x, f''(x) = e^x \Rightarrow f^{(n)}(x) = e^x; f(2) = e^2, f'(2) = e^2, \dots, f^{(n)}(2) = e^2$$

$$\Rightarrow e^x = e^2 + e^2(x-2) + \frac{e^2}{2!}(x-2)^2 + \frac{e^2}{3!}(x-2)^3 + \dots = \sum_{n=0}^{\infty} \frac{e^2}{n!}(x-2)^n$$

$$28. f(x) = 2^x \Rightarrow f'(x) = 2^x \ln 2, f''(x) = 2^x (\ln 2)^2, f'''(x) = 2^x (\ln 2)^3 \Rightarrow f^{(n)}(x) = 2^x (\ln 2)^n; f(1) = 2, f'(1) = 2 \ln 2,$$

$$f''(1) = 2(\ln 2)^2, f'''(1) = 2(\ln 2)^3, \dots, f^{(n)}(1) = 2(\ln 2)^n$$

$$\Rightarrow 2^x = 2 + (2 \ln 2)(x-1) + \frac{2(\ln 2)^2}{2!}(x-1)^2 + \frac{2(\ln 2)^3}{3!}(x-1)^3 + \dots = \sum_{n=0}^{\infty} \frac{2(\ln 2)^n (x-1)^n}{n!}$$

$$29. \text{ If } e^x = \sum_{n=0}^{\infty} \frac{f^{(n)}(a)}{n!} (x-a)^n \text{ and } f(x) = e^x, \text{ we have } f^{(n)}(a) = e^a \text{ for all } n = 0, 1, 2, 3, \dots$$

$$\Rightarrow e^x = e^a \left[\frac{(x-a)^0}{0!} + \frac{(x-a)^1}{1!} + \frac{(x-a)^2}{2!} + \dots \right] = e^a \left[1 + (x-a) + \frac{(x-a)^2}{2!} + \dots \right] \text{ at } x = a$$

$$30. f(x) = e^x \Rightarrow f^{(n)}(x) = e^x \text{ for all } n \Rightarrow f^{(n)}(1) = e \text{ for all } n = 0, 1, 2, \dots$$

$$\Rightarrow e^x = e + e(x-1) + \frac{e}{2!}(x-1)^2 + \frac{e}{3!}(x-1)^3 + \dots = e \left[1 + (x-1) + \frac{(x-1)^2}{2!} + \frac{(x-1)^3}{3!} + \dots \right]$$

$$31. f(x) = f(a) + f'(a)(x-a) + \frac{f''(a)}{2!}(x-a)^2 + \frac{f'''(a)}{3!}(x-a)^3 + \dots \Rightarrow f'(x)$$

$$= f'(a) + f''(a)(x-a) + \frac{f'''(a)}{3!} 3(x-a)^2 + \dots \Rightarrow f''(x) = f''(a) + f'''(a)(x-a) + \frac{f^{(4)}(a)}{4!} 4 \cdot 3(x-a)^2 + \dots$$

$$\Rightarrow f^{(n)}(x) = f^{(n)}(a) + f^{(n+1)}(a)(x-a) + \frac{f^{(n+2)}(a)}{2}(x-a)^2 + \dots$$

$$\Rightarrow f(a) = f(a) + 0, f'(a) = f'(a) + 0, \dots, f^{(n)}(a) = f^{(n)}(a) + 0$$

$$32. E(x) = f(x) - b_0 - b_1(x-a) - b_2(x-a)^2 - b_3(x-a)^3 - \dots - b_n(x-a)^n$$

$$\Rightarrow 0 = E(a) = f(a) - b_0 \Rightarrow b_0 = f(a); \text{ from condition (b),}$$

$$\lim_{x \rightarrow a} \frac{f(x) - f(a) - b_1(x-a) - b_2(x-a)^2 - b_3(x-a)^3 - \dots - b_n(x-a)^n}{(x-a)^n} = 0$$

$$\Rightarrow \lim_{x \rightarrow a} \frac{f'(x) - b_1 - 2b_2(x-a) - 3b_3(x-a)^2 - \dots - nb_n(x-a)^{n-1}}{n(x-a)^{n-1}} = 0$$

$$\Rightarrow b_1 = f'(a) \Rightarrow \lim_{x \rightarrow a} \frac{f''(x) - 2b_2 - 3!b_3(x-a) - \dots - n(n-1)b_n(x-a)^{n-2}}{n(n-1)(x-a)^{n-2}} = 0$$

$$\Rightarrow b_2 = \frac{1}{2} f''(a) \Rightarrow \lim_{x \rightarrow a} \frac{f'''(x) - 3!b_3 - \dots - n(n-1)(n-2)b_n(x-a)^{n-3}}{n(n-1)(n-2)(x-a)^{n-3}} = 0$$

$$= b_3 = \frac{1}{3!} f'''(a) \Rightarrow \lim_{x \rightarrow a} \frac{f^{(n)}(x) - n!b_n}{n!} = 0 \Rightarrow b_n = \frac{1}{n!} f^{(n)}(a); \text{ therefore,}$$

$$g(x) = f(a) + f'(a)(x-a) + \frac{f''(a)}{2!}(x-a)^2 + \dots + \frac{f^{(n)}(a)}{n!}(x-a)^n = P_n(x)$$

$$33. f(x) = \ln(\cos x) \Rightarrow f'(x) = -\tan x \text{ and } f''(x) = -\sec^2 x; f(0) = 0, f'(0) = 0, f''(0) = -1$$

$$\Rightarrow L(x) = 0 \text{ and } Q(x) = -\frac{x^2}{2}$$

$$34. f(x) = e^{\sin x} \Rightarrow f'(x) = (\cos x)e^{\sin x} \text{ and } f''(x) = (-\sin x)e^{\sin x} + (\cos x)^2 e^{\sin x}; f(0) = 1, f'(0) = 1,$$

$$f''(0) = 1 \Rightarrow L(x) = 1 + x \text{ and } Q(x) = 1 + x + \frac{x^2}{2}$$

$$35. f(x) = (1-x^2)^{-1/2} \Rightarrow f'(x) = x(1-x^2)^{-3/2} \text{ and } f''(x) = (1-x^2)^{-3/2} + 3x^2(1-x^2)^{-5/2}; f(0) = 1,$$

$$f'(0) = 0, f''(0) = 1 \Rightarrow L(x) = 1 \text{ and } Q(x) = 1 + \frac{x^2}{2}$$

$$36. f(x) = \cosh x \Rightarrow f'(x) = \sinh x \text{ and } f''(x) = \cosh x; f(0) = 1, f'(0) = 0, f''(0) = 1 \Rightarrow L(x) = 1 \text{ and } Q(x) = 1 + \frac{x^2}{2}$$

$$37. f(x) = \sin x \Rightarrow f'(x) = \cos x \text{ and } f''(x) = -\sin x; f(0) = 0, f'(0) = 1, f''(0) = 0 \Rightarrow L(x) = x \text{ and } Q(x) = x$$

$$38. f(x) = \tan x \Rightarrow f'(x) = \sec^2 x \text{ and } f''(x) = 2 \sec^2 x \tan x; f(0) = 0, f'(0) = 1, f'' = 0 \Rightarrow L(x) = x \text{ and } Q(x) = x$$

11.9 CONVERGENCE OF TAYLOR SERIES; ERROR ESTIMATES

$$1. e^x = 1 + x + \frac{x^2}{2!} + \dots = \sum_{n=0}^{\infty} \frac{x^n}{n!} \Rightarrow e^{-5x} = 1 + (-5x) + \frac{(-5x)^2}{2!} + \dots = 1 - 5x + \frac{5^2 x^2}{2!} - \frac{5^3 x^3}{3!} + \dots = \sum_{n=0}^{\infty} \frac{(-1)^n 5^n x^n}{n!}$$

$$2. e^x = 1 + x + \frac{x^2}{2!} + \dots = \sum_{n=0}^{\infty} \frac{x^n}{n!} \Rightarrow e^{-x/2} = 1 + \left(\frac{-x}{2}\right) + \frac{\left(\frac{-x}{2}\right)^2}{2!} + \dots = 1 - \frac{x}{2} + \frac{x^2}{2^2 2!} - \frac{x^3}{2^3 3!} + \dots$$

$$= \sum_{n=0}^{\infty} \frac{(-1)^n x^n}{2^n n!}$$

$$3. \sin x = x - \frac{x^3}{3!} + \frac{x^5}{5!} - \dots = \sum_{n=0}^{\infty} \frac{(-1)^n x^{2n+1}}{(2n+1)!} \Rightarrow 5 \sin(-x) = 5 \left[(-x) - \frac{(-x)^3}{3!} + \frac{(-x)^5}{5!} - \dots \right]$$

$$= \sum_{n=0}^{\infty} \frac{5(-1)^{n+1} x^{2n+1}}{(2n+1)!}$$

$$4. \sin x = x - \frac{x^3}{3!} + \frac{x^5}{5!} - \dots = \sum_{n=0}^{\infty} \frac{(-1)^n x^{2n+1}}{(2n+1)!} \Rightarrow \sin \frac{\pi x}{2} = \frac{\pi x}{2} - \frac{\left(\frac{\pi x}{2}\right)^3}{3!} + \frac{\left(\frac{\pi x}{2}\right)^5}{5!} - \frac{\left(\frac{\pi x}{2}\right)^7}{7!} + \dots$$

$$= \sum_{n=0}^{\infty} \frac{(-1)^n \pi^{2n+1} x^{2n+1}}{2^{2n+1} (2n+1)!}$$

$$5. \cos x = \sum_{n=0}^{\infty} \frac{(-1)^n x^{2n}}{(2n)!} \Rightarrow \cos \sqrt{x+1} = \sum_{n=0}^{\infty} \frac{(-1)^n \left[(x+1)^{1/2}\right]^{2n}}{(2n)!} = \sum_{n=0}^{\infty} \frac{(-1)^n (x+1)^n}{(2n)!} = 1 - \frac{x+1}{2!} + \frac{(x+1)^2}{4!} - \frac{(x+1)^3}{6!} + \dots$$

$$6. \cos x = \sum_{n=0}^{\infty} \frac{(-1)^n x^{2n}}{(2n)!} \Rightarrow \cos \left(\frac{x^{3/2}}{\sqrt{2}}\right) = \cos \left(\left(\frac{x^3}{2}\right)^{1/2}\right) = \sum_{n=0}^{\infty} \frac{(-1)^n \left(\left(\frac{x^3}{2}\right)^{1/2}\right)^{2n}}{(2n)!} = \sum_{n=0}^{\infty} \frac{(-1)^n x^{3n}}{2^n (2n)!}$$

$$= 1 - \frac{x^3}{2 \cdot 2!} + \frac{x^6}{2^2 \cdot 4!} - \frac{x^9}{2^3 \cdot 6!} + \dots$$

$$7. e^x = \sum_{n=0}^{\infty} \frac{x^n}{n!} \Rightarrow x e^x = x \left(\sum_{n=0}^{\infty} \frac{x^n}{n!} \right) = \sum_{n=0}^{\infty} \frac{x^{n+1}}{n!} = x + x^2 + \frac{x^3}{2!} + \frac{x^4}{3!} + \frac{x^5}{4!} + \dots$$

$$8. \sin x = \sum_{n=0}^{\infty} \frac{(-1)^n x^{2n+1}}{(2n+1)!} \Rightarrow x^2 \sin x = x^2 \left(\sum_{n=0}^{\infty} \frac{(-1)^n x^{2n+1}}{(2n+1)!} \right) = \sum_{n=0}^{\infty} \frac{(-1)^n x^{2n+3}}{(2n+1)!} = x^3 - \frac{x^5}{3!} + \frac{x^7}{5!} - \frac{x^9}{7!} + \dots$$

$$9. \cos x = \sum_{n=0}^{\infty} \frac{(-1)^n x^{2n}}{(2n)!} \Rightarrow \frac{x^2}{2} - 1 + \cos x = \frac{x^2}{2} - 1 + \sum_{n=0}^{\infty} \frac{(-1)^n x^{2n}}{(2n)!} = \frac{x^2}{2} - 1 + 1 - \frac{x^2}{2} + \frac{x^4}{4!} - \frac{x^6}{6!} + \frac{x^8}{8!} - \frac{x^{10}}{10!} + \dots$$

$$= \frac{x^4}{4!} - \frac{x^6}{6!} + \frac{x^8}{8!} - \frac{x^{10}}{10!} + \dots = \sum_{n=2}^{\infty} \frac{(-1)^n x^{2n}}{(2n)!}$$

$$10. \sin x = \sum_{n=0}^{\infty} \frac{(-1)^n x^{2n+1}}{(2n+1)!} \Rightarrow \sin x - x + \frac{x^3}{3!} = \left(\sum_{n=0}^{\infty} \frac{(-1)^n x^{2n+1}}{(2n+1)!} \right) - x + \frac{x^3}{3!}$$

$$= \left(x - \frac{x^3}{3!} + \frac{x^5}{5!} - \frac{x^7}{7!} + \frac{x^9}{9!} - \frac{x^{11}}{11!} + \dots \right) - x + \frac{x^3}{3!} = \frac{x^5}{5!} - \frac{x^7}{7!} + \frac{x^9}{9!} - \frac{x^{11}}{11!} + \dots = \sum_{n=2}^{\infty} \frac{(-1)^n x^{2n+1}}{(2n+1)!}$$

$$11. \cos x = \sum_{n=0}^{\infty} \frac{(-1)^n x^{2n}}{(2n)!} \Rightarrow x \cos \pi x = x \sum_{n=0}^{\infty} \frac{(-1)^n (\pi x)^{2n}}{(2n)!} = \sum_{n=0}^{\infty} \frac{(-1)^n \pi^{2n} x^{2n+1}}{(2n)!} = x - \frac{\pi^2 x^3}{2!} + \frac{\pi^4 x^5}{4!} - \frac{\pi^6 x^7}{6!} + \dots$$

$$12. \cos x = \sum_{n=0}^{\infty} \frac{(-1)^n x^{2n}}{(2n)!} \Rightarrow x^2 \cos(x^2) = x^2 \sum_{n=0}^{\infty} \frac{(-1)^n (x^2)^{2n}}{(2n)!} = \sum_{n=0}^{\infty} \frac{(-1)^n x^{4n+2}}{(2n)!} = x^2 - \frac{x^6}{2!} + \frac{x^{10}}{4!} - \frac{x^{14}}{6!} + \dots$$

$$13. \cos^2 x = \frac{1}{2} + \frac{\cos 2x}{2} = \frac{1}{2} + \frac{1}{2} \sum_{n=0}^{\infty} \frac{(-1)^n (2x)^{2n}}{(2n)!} = \frac{1}{2} + \frac{1}{2} \left[1 - \frac{(2x)^2}{2!} + \frac{(2x)^4}{4!} - \frac{(2x)^6}{6!} + \frac{(2x)^8}{8!} - \dots \right]$$

$$= 1 - \frac{(2x)^2}{2 \cdot 2!} + \frac{(2x)^4}{2 \cdot 4!} - \frac{(2x)^6}{2 \cdot 6!} + \frac{(2x)^8}{2 \cdot 8!} - \dots = 1 + \sum_{n=1}^{\infty} \frac{(-1)^n (2x)^{2n}}{2 \cdot (2n)!} = 1 + \sum_{n=1}^{\infty} \frac{(-1)^n 2^{2n-1} x^{2n}}{(2n)!}$$

$$14. \sin^2 x = \left(\frac{1 - \cos 2x}{2} \right) = \frac{1}{2} - \frac{1}{2} \cos 2x = \frac{1}{2} - \frac{1}{2} \left(1 - \frac{(2x)^2}{2!} + \frac{(2x)^4}{4!} - \frac{(2x)^6}{6!} + \dots \right) = \frac{(2x)^2}{2 \cdot 2!} - \frac{(2x)^4}{2 \cdot 4!} + \frac{(2x)^6}{2 \cdot 6!} - \dots$$

$$= \sum_{n=1}^{\infty} \frac{(-1)^{n+1} (2x)^{2n}}{2 \cdot (2n)!} = \sum_{n=1}^{\infty} \frac{(-1)^n 2^{2n-1} x^{2n}}{(2n)!}$$

$$15. \frac{x^2}{1-2x} = x^2 \left(\frac{1}{1-2x} \right) = x^2 \sum_{n=0}^{\infty} (2x)^n = \sum_{n=0}^{\infty} 2^n x^{n+2} = x^2 + 2x^3 + 2^2 x^4 + 2^3 x^5 + \dots$$

$$16. x \ln(1+2x) = x \sum_{n=1}^{\infty} \frac{(-1)^{n-1} (2x)^n}{n} = \sum_{n=1}^{\infty} \frac{(-1)^{n-1} 2^n x^{n+1}}{n} = 2x^2 - \frac{2^2 x^3}{2} + \frac{2^3 x^4}{4} - \frac{2^4 x^5}{5} + \dots$$

$$17. \frac{1}{1-x} = \sum_{n=0}^{\infty} x^n = 1 + x + x^2 + x^3 + \dots \Rightarrow \frac{d}{dx} \left(\frac{1}{1-x} \right) = \frac{1}{(1-x)^2} = 1 + 2x + 3x^2 + \dots = \sum_{n=1}^{\infty} n x^{n-1}$$

$$= \sum_{n=0}^{\infty} (n+1) x^n$$

$$18. \frac{2}{(1-x)^3} = \frac{d^2}{dx^2} \left(\frac{1}{1-x} \right) = \frac{d}{dx} \left(\frac{1}{(1-x)^2} \right) = \frac{d}{dx} (1 + 2x + 3x^2 + \dots) = 2 + 6x + 12x^2 + \dots = \sum_{n=2}^{\infty} n(n-1) x^{n-2}$$

$$= \sum_{n=0}^{\infty} (n+2)(n+1) x^n$$

$$19. \text{By the Alternating Series Estimation Theorem, the error is less than } \frac{|x|^5}{5!} \Rightarrow |x|^5 < (5!) (5 \times 10^{-4})$$

$$\Rightarrow |x|^5 < 600 \times 10^{-4} \Rightarrow |x| < \sqrt[5]{6 \times 10^{-2}} \approx 0.56968$$

20. If $\cos x = 1 - \frac{x^2}{2}$ and $|x| < 0.5$, then the error is less than $\left| \frac{(-5)^4}{24} \right| = 0.0026$, by Alternating Series Estimation Theorem; since the next term in the series is positive, the approximation $1 - \frac{x^2}{2}$ is too small, by the Alternating Series Estimation Theorem

21. If $\sin x = x$ and $|x| < 10^{-3}$, then the error is less than $\frac{(10^{-3})^3}{3!} \approx 1.67 \times 10^{-10}$, by Alternating Series Estimation Theorem; The Alternating Series Estimation Theorem says $R_2(x)$ has the same sign as $-\frac{x^3}{3!}$. Moreover, $x < \sin x$

$$\Rightarrow 0 < \sin x - x = R_2(x) \Rightarrow x < 0 \Rightarrow -10^{-3} < x < 0.$$

$$22. \sqrt{1+x} = 1 + \frac{x}{2} - \frac{x^2}{8} + \frac{x^3}{16} - \dots. \text{ By the Alternating Series Estimation Theorem the } |\text{error}| < \left| \frac{-x^2}{8} \right| < \frac{(0.01)^2}{8}$$

$$= 1.25 \times 10^{-5}$$

$$23. |R_2(x)| = \left| \frac{e^c x^3}{3!} \right| < \frac{3^{(0.1)}(0.1)^3}{3!} < 1.87 \times 10^{-4}, \text{ where } c \text{ is between } 0 \text{ and } x$$

$$24. |R_2(x)| = \left| \frac{e^c x^3}{3!} \right| < \frac{(0.1)^3}{3!} = 1.67 \times 10^{-4}, \text{ where } c \text{ is between } 0 \text{ and } x$$

25. $|R_4(x)| < \left| \frac{\cosh c}{5!} x^5 \right| = \left| \frac{e^c + e^{-c}}{2} \frac{x^5}{5!} \right| < \frac{1.65 + \frac{1}{1.65}}{2} \cdot \frac{(0.5)^5}{5!} = (1.13) \frac{(0.5)^5}{5!} \approx 0.000294$

26. If we approximate e^h with $1 + h$ and $0 \leq h \leq 0.01$, then $|\text{error}| < \left| \frac{e^{0.01} h^2}{2} \right| \leq \frac{e^{0.01} h \cdot h}{2} \leq \left(\frac{e^{0.01}(0.01)}{2} \right) h = 0.00505h < 0.006h = (0.6\%)h$, where c is between 0 and h .

27. $|R_1| = \left| \frac{1}{(1+c)^2} \frac{x^2}{2!} \right| < \frac{x^2}{2} = \left| \frac{x}{2} \right| |x| < .01 |x| = (1\%) |x| \Rightarrow \left| \frac{x}{2} \right| < .01 \Rightarrow 0 < |x| < .02$

28. $\tan^{-1} x = x - \frac{x^3}{3} + \frac{x^5}{5} - \frac{x^7}{7} + \dots \Rightarrow \frac{\pi}{4} = \tan^{-1} 1 = 1 - \frac{1}{3} + \frac{1}{5} - \frac{1}{7} + \dots$; $|\text{error}| < \frac{1}{2n+1} < .01 \Rightarrow 2n + 1 > 100 \Rightarrow n > 49$

29. (a) $\sin x = x - \frac{x^3}{3!} + \frac{x^5}{5!} - \frac{x^7}{7!} + \dots \Rightarrow \frac{\sin x}{x} = 1 - \frac{x^2}{3!} + \frac{x^4}{5!} - \frac{x^6}{7!} + \dots$, $s_1 = 1$ and $s_2 = 1 - \frac{x^2}{6}$; if L is the sum of the series representing $\frac{\sin x}{x}$, then by the Alternating Series Estimation Theorem, $L - s_1 = \frac{\sin x}{x} - 1 < 0$ and $L - s_2 = \frac{\sin x}{x} - \left(1 - \frac{x^2}{6} \right) > 0$. Therefore $1 - \frac{x^2}{6} < \frac{\sin x}{x} < 1$

(b) The graph of $y = \frac{\sin x}{x}$, $x \neq 0$, is bounded below by the graph of $y = 1 - \frac{x^2}{6}$ and above by the graph of $y = 1$ as derived in part (a).

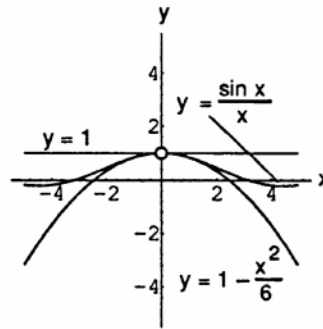

30. (a) $\cos x = 1 - \frac{x^2}{2!} + \frac{x^4}{4!} - \frac{x^6}{6!} + \dots \Rightarrow 1 - \cos x = \frac{x^2}{2!} - \frac{x^4}{4!} + \frac{x^6}{6!} - \frac{x^8}{8!} + \dots \Rightarrow \frac{1 - \cos x}{x^2} = \frac{1}{2} - \frac{x^2}{4!} + \frac{x^4}{6!} - \frac{x^6}{8!} + \dots$; if L is the sum of the series representing $\frac{1 - \cos x}{x^2}$, then by the Alternating Series Estimation Theorem $L - s_1 = \frac{1 - \cos x}{x^2} - \frac{1}{2} < 0$ and $\frac{1 - \cos x}{x^2} - \left(\frac{1}{2} - \frac{x^2}{24} \right) > 0$. Therefore $\frac{1}{2} - \frac{x^2}{24} < \frac{1 - \cos x}{x^2} < \frac{1}{2}$.

(b) The graph of $y = \frac{1 - \cos x}{x^2}$ is bounded below by the graph of $y = \frac{1}{2} - \frac{x^2}{24}$ and above by the graph of $y = \frac{1}{2}$ as indicated in part (a).

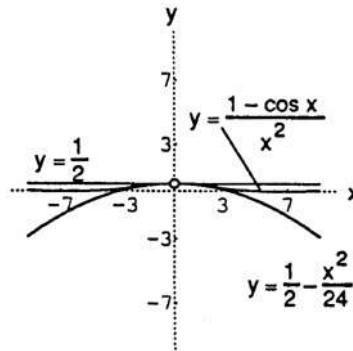

31. $\sin x$ when $x = 0.1$; the sum is $\sin(0.1) \approx 0.099833417$

32. $\cos x$ when $x = \frac{\pi}{4}$; the sum is $\cos\left(\frac{\pi}{4}\right) = \frac{1}{\sqrt{2}} \approx 0.707106781$

33. $\tan^{-1} x$ when $x = \frac{\pi}{3}$; the sum is $\tan^{-1}\left(\frac{\pi}{3}\right) \approx 0.808448$

34. $\ln(1 + x)$ when $x = \pi$; the sum is $\ln(1 + \pi) \approx 1.421080$

$$35. e^x \sin x = 0 + x + x^2 + x^3 \left(-\frac{1}{3!} + \frac{1}{2!}\right) + x^4 \left(-\frac{1}{3!} + \frac{1}{3!}\right) + x^5 \left(\frac{1}{5!} - \frac{1}{2!} \frac{1}{3!} + \frac{1}{4!}\right) + x^6 \left(\frac{1}{5!} - \frac{1}{3!} \frac{1}{3!} + \frac{1}{5!}\right) + \dots$$

$$= x + x^2 + \frac{1}{3} x^3 - \frac{1}{30} x^5 - \frac{1}{90} x^6 + \dots$$

$$36. e^x \cos x = 1 + x + x^2 \left(-\frac{1}{2!} + \frac{1}{2!}\right) + x^3 \left(-\frac{1}{2!} + \frac{1}{3!}\right) + x^4 \left(\frac{1}{4!} - \frac{1}{2!} \frac{1}{2!} + \frac{1}{4!}\right) + x^5 \left(\frac{1}{4!} - \frac{1}{2!} \frac{1}{3!} + \frac{1}{5!}\right) + \dots$$

$$= 1 + x - \frac{1}{3} x^3 - \frac{1}{6} x^4 - \frac{1}{30} x^5 + \dots$$

$$37. \sin^2 x = \left(\frac{1 - \cos 2x}{2}\right) = \frac{1}{2} - \frac{1}{2} \cos 2x = \frac{1}{2} - \frac{1}{2} \left(1 - \frac{(2x)^2}{2!} + \frac{(2x)^4}{4!} - \frac{(2x)^6}{6!} + \dots\right) = \frac{2x^2}{2!} - \frac{2^3 x^4}{4!} + \frac{2^5 x^6}{6!} - \dots$$

$$\Rightarrow \frac{d}{dx} (\sin^2 x) = \frac{d}{dx} \left(\frac{2x^2}{2!} - \frac{2^3 x^4}{4!} + \frac{2^5 x^6}{6!} - \dots\right) = 2x - \frac{(2x)^3}{3!} + \frac{(2x)^5}{5!} - \frac{(2x)^7}{7!} + \dots \Rightarrow 2 \sin x \cos x$$

$$= 2x - \frac{(2x)^3}{3!} + \frac{(2x)^5}{5!} - \frac{(2x)^7}{7!} + \dots = \sin 2x, \text{ which checks}$$

$$38. \cos^2 x = \cos 2x + \sin^2 x = \left(1 - \frac{(2x)^2}{2!} + \frac{(2x)^4}{4!} - \frac{(2x)^6}{6!} + \frac{(2x)^8}{8!} + \dots\right) + \left(\frac{2x^2}{2!} - \frac{2^3 x^4}{4!} + \frac{2^5 x^6}{6!} - \frac{2^7 x^8}{8!} + \dots\right)$$

$$= 1 - \frac{2x^2}{2!} + \frac{2^3 x^4}{4!} - \frac{2^5 x^6}{6!} + \dots = 1 - x^2 + \frac{1}{3} x^4 - \frac{2}{45} x^6 + \frac{1}{315} x^8 - \dots$$

39. A special case of Taylor's Theorem is $f(b) = f(a) + f'(c)(b - a)$, where c is between a and $b \Rightarrow f(b) - f(a) = f'(c)(b - a)$, the Mean Value Theorem.

40. If $f(x)$ is twice differentiable and at $x = a$ there is a point of inflection, then $f''(a) = 0$. Therefore, $L(x) = Q(x) = f(a) + f'(a)(x - a)$.

41. (a) $f'' \leq 0$, $f'(a) = 0$ and $x = a$ interior to the interval $I \Rightarrow f(x) - f(a) = \frac{f''(c_2)}{2} (x - a)^2 \leq 0$ throughout I
 $\Rightarrow f(x) \leq f(a)$ throughout $I \Rightarrow f$ has a local maximum at $x = a$

(b) similar reasoning gives $f(x) - f(a) = \frac{f''(c_2)}{2} (x - a)^2 \geq 0$ throughout $I \Rightarrow f(x) \geq f(a)$ throughout $I \Rightarrow f$ has a local minimum at $x = a$

$$42. f(x) = (1 - x)^{-1} \Rightarrow f'(x) = (1 - x)^{-2} \Rightarrow f''(x) = 2(1 - x)^{-3} \Rightarrow f^{(3)}(x) = 6(1 - x)^{-4}$$

$$\Rightarrow f^{(4)}(x) = 24(1 - x)^{-5}; \text{ therefore } \frac{1}{1-x} \approx 1 + x + x^2 + x^3. |x| < 0.1 \Rightarrow \frac{10}{11} < \frac{1}{1-x} < \frac{10}{9} \Rightarrow \left|\frac{1}{(1-x)^5}\right| < \left(\frac{10}{9}\right)^5$$

$$\Rightarrow \left|\frac{x^4}{(1-x)^5}\right| < x^4 \left(\frac{10}{9}\right)^5 \Rightarrow \text{the error } e_3 \leq \left|\frac{\max f^{(4)}(x) x^4}{4!}\right| < (0.1)^4 \left(\frac{10}{9}\right)^5 = 0.00016935 < 0.00017, \text{ since } \left|\frac{f^{(4)}(x)}{4!}\right| = \left|\frac{1}{(1-x)^5}\right|.$$

$$43. (a) f(x) = (1 + x)^k \Rightarrow f'(x) = k(1 + x)^{k-1} \Rightarrow f''(x) = k(k-1)(1 + x)^{k-2}; f(0) = 1, f'(0) = k, \text{ and } f''(0) = k(k-1)$$

$$\Rightarrow Q(x) = 1 + kx + \frac{k(k-1)}{2} x^2$$

$$(b) |R_2(x)| = \left|\frac{3 \cdot 2 \cdot 1}{3!} x^3\right| < \frac{1}{100} \Rightarrow |x^3| < \frac{1}{100} \Rightarrow 0 < x < \frac{1}{100^{1/3}} \text{ or } 0 < x < .21544$$

44. (a) Let $P = x + \pi \Rightarrow |x| = |P - \pi| < .5 \times 10^{-n}$ since P approximates π accurate to n decimals. Then,
 $P + \sin P = (\pi + x) + \sin(\pi + x) = (\pi + x) - \sin x = \pi + (x - \sin x) \Rightarrow |(P + \sin P) - \pi|$
 $= |x - \sin x| \leq \frac{|x|^3}{3!} < \frac{0.125}{3!} \times 10^{-3n} < .5 \times 10^{-3n} \Rightarrow P + \sin P$ gives an approximation to π correct to $3n$ decimals.

45. If $f(x) = \sum_{n=0}^{\infty} a_n x^n$, then $f^{(k)}(x) = \sum_{n=k}^{\infty} n(n-1)(n-2)\cdots(n-k+1)a_n x^{n-k}$ and $f^{(k)}(0) = k! a_k$
 $\Rightarrow a_k = \frac{f^{(k)}(0)}{k!}$ for k a nonnegative integer. Therefore, the coefficients of $f(x)$ are identical with the corresponding coefficients in the Maclaurin series of $f(x)$ and the statement follows.

46. Note: f even $\Rightarrow f(-x) = f(x) \Rightarrow -f'(-x) = f'(x) \Rightarrow f'(-x) = -f'(x) \Rightarrow f'$ odd;
 f odd $\Rightarrow f(-x) = -f(x) \Rightarrow -f'(-x) = -f'(x) \Rightarrow f'(-x) = f'(x) \Rightarrow f'$ even;
 also, f odd $\Rightarrow f(-0) = f(0) \Rightarrow 2f(0) = 0 \Rightarrow f(0) = 0$

- (a) If $f(x)$ is even, then any odd-order derivative is odd and equal to 0 at $x = 0$. Therefore, $a_1 = a_3 = a_5 = \dots = 0$; that is, the Maclaurin series for f contains only even powers.
- (b) If $f(x)$ is odd, then any even-order derivative is odd and equal to 0 at $x = 0$. Therefore, $a_0 = a_2 = a_4 = \dots = 0$; that is, the Maclaurin series for f contains only odd powers.

47. (a) Suppose $f(x)$ is a continuous periodic function with period p . Let x_0 be an arbitrary real number. Then f assumes a minimum m_1 and a maximum m_2 in the interval $[x_0, x_0 + p]$; i.e., $m_1 \leq f(x) \leq m_2$ for all x in $[x_0, x_0 + p]$. Since f is periodic it has exactly the same values on all other intervals $[x_0 + p, x_0 + 2p]$, $[x_0 + 2p, x_0 + 3p]$, \dots , and $[x_0 - p, x_0]$, $[x_0 - 2p, x_0 - p]$, \dots , and so forth. That is, for all real numbers $-\infty < x < \infty$ we have $m_1 \leq f(x) \leq m_2$. Now choose $M = \max\{|m_1|, |m_2|\}$. Then $-M \leq -|m_1| \leq m_1 \leq f(x) \leq m_2 \leq |m_2| \leq M \Rightarrow |f(x)| \leq M$ for all x .
- (b) The dominate term in the n th order Taylor polynomial generated by $\cos x$ about $x = a$ is $\frac{\sin(a)}{n!} (x - a)^n$ or $\frac{\cos(a)}{n!} (x - a)^n$. In both cases, as $|x|$ increases the absolute value of these dominate terms tends to ∞ , causing the graph of $P_n(x)$ to move away from $\cos x$.

48. (b) $\tan^{-1} x = x - \frac{x^3}{3} + \frac{x^5}{5} - \dots \Rightarrow \frac{x - \tan^{-1} x}{x^3}$
 $= \frac{1}{3} - \frac{x^2}{5} + \dots$; from the Alternating Series
 Estimation Theorem, $\frac{x - \tan^{-1} x}{x^3} - \frac{1}{3} < 0$
 $\Rightarrow \frac{x - \tan^{-1} x}{x^3} - \left(\frac{1}{3} - \frac{x^2}{5}\right) > 0 \Rightarrow \frac{1}{3} < \frac{x - \tan^{-1} x}{x^3}$
 $< \frac{1}{3} - \frac{x^2}{5}$; therefore, the $\lim_{x \rightarrow 0} \frac{x - \tan^{-1} x}{x^3} = \frac{1}{3}$

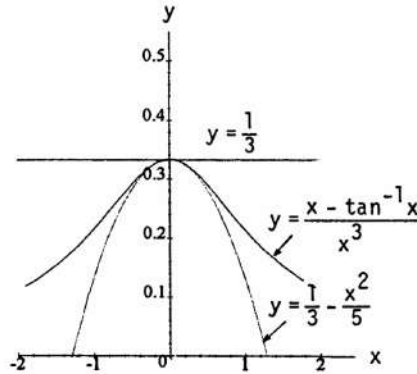

49. (a) $e^{-i\pi} = \cos(-\pi) + i \sin(-\pi) = -1 + i(0) = -1$
 (b) $e^{i\pi/4} = \cos\left(\frac{\pi}{4}\right) + i \sin\left(\frac{\pi}{4}\right) = \frac{1}{\sqrt{2}} + \frac{i}{\sqrt{2}} = \left(\frac{1}{\sqrt{2}}\right)(1 + i)$
 (c) $e^{-i\pi/2} = \cos\left(-\frac{\pi}{2}\right) + i \sin\left(-\frac{\pi}{2}\right) = 0 + i(-1) = -i$
50. $e^{i\theta} = \cos \theta + i \sin \theta \Rightarrow e^{-i\theta} = e^{i(-\theta)} = \cos(-\theta) + i \sin(-\theta) = \cos \theta - i \sin \theta$;
 $e^{i\theta} + e^{-i\theta} = \cos \theta + i \sin \theta + \cos \theta - i \sin \theta = 2 \cos \theta \Rightarrow \cos \theta = \frac{e^{i\theta} + e^{-i\theta}}{2}$;
 $e^{i\theta} - e^{-i\theta} = \cos \theta + i \sin \theta - (\cos \theta - i \sin \theta) = 2i \sin \theta \Rightarrow \sin \theta = \frac{e^{i\theta} - e^{-i\theta}}{2i}$

51. $e^x = 1 + x + \frac{x^2}{2!} + \frac{x^3}{3!} + \frac{x^4}{4!} + \dots \Rightarrow e^{i\theta} = 1 + i\theta + \frac{(i\theta)^2}{2!} + \frac{(i\theta)^3}{3!} + \frac{(i\theta)^4}{4!} + \dots$ and
 $e^{-i\theta} = 1 - i\theta + \frac{(-i\theta)^2}{2!} + \frac{(-i\theta)^3}{3!} + \frac{(-i\theta)^4}{4!} + \dots = 1 - i\theta + \frac{(i\theta)^2}{2!} - \frac{(i\theta)^3}{3!} + \frac{(i\theta)^4}{4!} - \dots$
 $\Rightarrow \frac{e^{i\theta} + e^{-i\theta}}{2} = \frac{\left(1 + i\theta + \frac{(i\theta)^2}{2!} + \frac{(i\theta)^3}{3!} + \frac{(i\theta)^4}{4!} + \dots\right) + \left(1 - i\theta + \frac{(i\theta)^2}{2!} - \frac{(i\theta)^3}{3!} + \frac{(i\theta)^4}{4!} - \dots\right)}{2}$
 $= 1 - \frac{\theta^2}{2!} + \frac{\theta^4}{4!} - \frac{\theta^6}{6!} + \dots = \cos \theta$;
 $\frac{e^{i\theta} - e^{-i\theta}}{2i} = \frac{\left(1 + i\theta + \frac{(i\theta)^2}{2!} + \frac{(i\theta)^3}{3!} + \frac{(i\theta)^4}{4!} + \dots\right) - \left(1 - i\theta + \frac{(i\theta)^2}{2!} - \frac{(i\theta)^3}{3!} + \frac{(i\theta)^4}{4!} - \dots\right)}{2i}$
 $= \theta - \frac{\theta^3}{3!} + \frac{\theta^5}{5!} - \frac{\theta^7}{7!} + \dots = \sin \theta$

52. $e^{i\theta} = \cos \theta + i \sin \theta \Rightarrow e^{-i\theta} = e^{i(-\theta)} = \cos(-\theta) + i \sin(-\theta) = \cos \theta - i \sin \theta$
 (a) $e^{i\theta} + e^{-i\theta} = (\cos \theta + i \sin \theta) + (\cos \theta - i \sin \theta) = 2 \cos \theta \Rightarrow \cos \theta = \frac{e^{i\theta} + e^{-i\theta}}{2} = \cosh i\theta$

$$(b) e^{i\theta} - e^{-i\theta} = (\cos \theta + i \sin \theta) - (\cos \theta - i \sin \theta) = 2i \sin \theta \Rightarrow i \sin \theta = \frac{e^{i\theta} - e^{-i\theta}}{2} = \sinh i\theta$$

53. $e^x \sin x = \left(1 + x + \frac{x^2}{2!} + \frac{x^3}{3!} + \frac{x^4}{4!} + \dots\right) \left(x - \frac{x^3}{3!} + \frac{x^5}{5!} - \frac{x^7}{7!} + \dots\right)$
 $= (1)x + (1)x^2 + \left(-\frac{1}{6} + \frac{1}{2}\right)x^3 + \left(-\frac{1}{6} + \frac{1}{6}\right)x^4 + \left(\frac{1}{120} - \frac{1}{12} + \frac{1}{24}\right)x^5 + \dots = x + x^2 + \frac{1}{3}x^3 - \frac{1}{30}x^5 + \dots$;
 $e^x \cdot e^{ix} = e^{(1+i)x} = e^x (\cos x + i \sin x) = e^x \cos x + i (e^x \sin x) \Rightarrow e^x \sin x$ is the series of the imaginary part
of $e^{(1+i)x}$ which we calculate next; $e^{(1+i)x} = \sum_{n=0}^{\infty} \frac{(x+ix)^n}{n!} = 1 + (x+ix) + \frac{(x+ix)^2}{2!} + \frac{(x+ix)^3}{3!} + \frac{(x+ix)^4}{4!} + \dots$
 $= 1 + x + ix + \frac{1}{2!}(2ix^2) + \frac{1}{3!}(2ix^3 - 2x^3) + \frac{1}{4!}(-4x^4) + \frac{1}{5!}(-4x^5 - 4ix^5) + \frac{1}{6!}(-8ix^6) + \dots \Rightarrow$ the imaginary part
of $e^{(1+i)x}$ is $x + \frac{2}{2!}x^2 + \frac{2}{3!}x^3 - \frac{4}{5!}x^5 - \frac{8}{6!}x^6 + \dots = x + x^2 + \frac{1}{3}x^3 - \frac{1}{30}x^5 - \frac{1}{90}x^6 + \dots$ in agreement with our
product calculation. The series for $e^x \sin x$ converges for all values of x .

54. $\frac{d}{dx} (e^{(a+ib)x}) = \frac{d}{dx} [e^{ax}(\cos bx + i \sin bx)] = ae^{ax}(\cos bx + i \sin bx) + e^{ax}(-b \sin bx + bi \cos bx)$
 $= ae^{ax}(\cos bx + i \sin bx) + bie^{ax}(\cos bx + i \sin bx) = ae^{(a+ib)x} + ibe^{(a+ib)x} = (a + ib)e^{(a+ib)x}$

55. (a) $e^{i\theta_1} e^{i\theta_2} = (\cos \theta_1 + i \sin \theta_1)(\cos \theta_2 + i \sin \theta_2) = (\cos \theta_1 \cos \theta_2 - \sin \theta_1 \sin \theta_2) + i(\sin \theta_1 \cos \theta_2 + \sin \theta_2 \cos \theta_1)$
 $= \cos(\theta_1 + \theta_2) + i \sin(\theta_1 + \theta_2) = e^{i(\theta_1 + \theta_2)}$

(b) $e^{-i\theta} = \cos(-\theta) + i \sin(-\theta) = \cos \theta - i \sin \theta = (\cos \theta - i \sin \theta) \left(\frac{\cos \theta + i \sin \theta}{\cos \theta + i \sin \theta}\right) = \frac{1}{\cos \theta + i \sin \theta} = \frac{1}{e^{i\theta}}$

56. $\frac{a-bi}{a^2+b^2} e^{(a+bi)x} + C_1 + iC_2 = \left(\frac{a-bi}{a^2+b^2}\right) e^{ax}(\cos bx + i \sin bx) + C_1 + iC_2$
 $= \frac{e^{ax}}{a^2+b^2} (a \cos bx + ia \sin bx - ib \cos bx + b \sin bx) + C_1 + iC_2$
 $= \frac{e^{ax}}{a^2+b^2} [(a \cos bx + b \sin bx) + (a \sin bx - b \cos bx)i] + C_1 + iC_2$
 $= \frac{e^{ax}(a \cos bx + b \sin bx)}{a^2+b^2} + C_1 + \frac{ie^{ax}(a \sin bx - b \cos bx)}{a^2+b^2} + iC_2;$

$e^{(a+bi)x} = e^{ax} e^{ibx} = e^{ax}(\cos bx + i \sin bx) = e^{ax} \cos bx + ie^{ax} \sin bx$, so that given

$\int e^{(a+bi)x} dx = \frac{a-bi}{a^2+b^2} e^{(a+bi)x} + C_1 + iC_2$ we conclude that $\int e^{ax} \cos bx dx = \frac{e^{ax}(a \cos bx + b \sin bx)}{a^2+b^2} + C_1$

and $\int e^{ax} \sin bx dx = \frac{e^{ax}(a \sin bx - b \cos bx)}{a^2+b^2} + C_2$

57-62. Example CAS commands:

Maple:

f := x -> 1/sqrt(1+x);

x0 := -3/4;

x1 := 3/4;

Step 1:

plot(f(x), x=x0..x1, title="Step 1: #57 (Section 11.9)");

Step 2:

P1 := unapply(TaylorApproximation(f(x), x = 0, order=1), x);

P2 := unapply(TaylorApproximation(f(x), x = 0, order=2), x);

P3 := unapply(TaylorApproximation(f(x), x = 0, order=3), x);

Step 3:

D2f := D(D(f));

D3f := D(D(D(f)));

D4f := D(D(D(D(f))));

plot([D2f(x),D3f(x),D4f(x)], x=x0..x1, thickness=[0,2,4], color=[red,blue,green], title="Step 3: #57 (Section 11.9)");

c1 := x0;

M1 := abs(D2f(c1));

c2 := x0;

M2 := abs(D3f(c2));

```

c3 := x0;
M3 := abs( D4f(c3) );
# Step 4:
R1 := unapply( abs(M1/2!*(x-0)^2), x );
R2 := unapply( abs(M2/3!*(x-0)^3), x );
R3 := unapply( abs(M3/4!*(x-0)^4), x );
plot( [R1(x),R2(x),R3(x)], x=x0..x1, thickness=[0,2,4], color=[red,blue,green], title="Step 4: #57 (Section 11.9)" );
# Step 5:
E1 := unapply( abs(f(x)-P1(x)), x );
E2 := unapply( abs(f(x)-P2(x)), x );
E3 := unapply( abs(f(x)-P3(x)), x );
plot( [E1(x),E2(x),E3(x),R1(x),R2(x),R3(x)], x=x0..x1, thickness=[0,2,4], color=[red,blue,green],
      linestyle=[1,1,1,3,3,3], title="Step 5: #57 (Section 11.9)" );
# Step 6:
TaylorApproximation( f(x), view=[x0..x1,DEFAULT], x=0, output=animation, order=1..3 );
L1 := fsolve( abs(f(x)-P1(x))=0.01, x=x0/2 );          # (a)
R1 := fsolve( abs(f(x)-P1(x))=0.01, x=x1/2 );
L2 := fsolve( abs(f(x)-P2(x))=0.01, x=x0/2 );
R2 := fsolve( abs(f(x)-P2(x))=0.01, x=x1/2 );
L3 := fsolve( abs(f(x)-P3(x))=0.01, x=x0/2 );
R3 := fsolve( abs(f(x)-P3(x))=0.01, x=x1/2 );
plot( [E1(x),E2(x),E3(x),0.01], x=min(L1,L2,L3)..max(R1,R2,R3), thickness=[0,2,4,0], linestyle=[0,0,0,2],
      color=[red,blue,green,black], view=[DEFAULT,0..0.01], title="#57(a) (Section 11.9)" );
abs( f(x) - P[1](x) ) <= evalf( E1(x0) );          # (b)
abs( f(x) - P[2](x) ) <= evalf( E2(x0) );
abs( f(x) - P[3](x) ) <= evalf( E3(x0) );

```

Mathematica: (assigned function and values for a, b, c, and n may vary)

```

Clear[x, f, c]
f[x_]= (1 + x)^(3/2)
{a, b}= {-1/2, 2};
pf=Plot[ f[x], {x, a, b}];
poly1[x_]=Series[f[x], {x,0,1}]/Normal
poly2[x_]=Series[f[x], {x,0,2}]/Normal
poly3[x_]=Series[f[x], {x,0,3}]/Normal
Plot[{f[x], poly1[x], poly2[x], poly3[x]}, {x, a, b},
     PlotStyle -> {RGBColor[1,0,0], RGBColor[0,1,0], RGBColor[0,0,1], RGBColor[0,.5,.5]}];

```

The above defines the approximations. The following analyzes the derivatives to determine their maximum values.

```

f'[c]
Plot[f'[x], {x, a, b}];
f''[c]
Plot[f''[x], {x, a, b}];
f'''[c]
Plot[f'''[x], {x, a, b}];

```

Noting the upper bound for each of the above derivatives occurs at $x = a$, the upper bounds m_1 , m_2 , and m_3 can be defined and bounds for remainders viewed as functions of x .

```

m1=f'[a]
m2=f''[a]
m3=f'''[a]
r1[x_]=m1 x^2 /2!

```

Plot[r1[x], {x, a, b}];

r2[x_]:=m2 x³ /3!

Plot[r2[x], {x, a, b}];

r3[x_]:=m3 x⁴ /4!

Plot[r3[x], {x, a, b}];

A three dimensional look at the error functions, allowing both c and x to vary can also be viewed. Recall that c must be a value between 0 and x, so some points on the surfaces where c is not in that interval are meaningless.

Plot3D[f''[c] x² /2!, {x, a, b}, {c, a, b}, PlotRange → All]

Plot3D[f'''[c] x³ /3!, {x, a, b}, {c, a, b}, PlotRange → All]

Plot3D[f''''[c] x⁴ /4!, {x, a, b}, {c, a, b}, PlotRange → All]

11.10 APPLICATIONS OF POWER SERIES

1. $(1+x)^{1/2} = 1 + \frac{1}{2}x + \frac{(\frac{1}{2})(-\frac{1}{2})x^2}{2!} + \frac{(\frac{1}{2})(-\frac{1}{2})(-\frac{3}{2})x^3}{3!} + \dots = 1 + \frac{1}{2}x - \frac{1}{8}x^2 + \frac{1}{16}x^3 - \dots$
2. $(1+x)^{1/3} = 1 + \frac{1}{3}x + \frac{(\frac{1}{3})(-\frac{2}{3})x^2}{2!} + \frac{(\frac{1}{3})(-\frac{2}{3})(-\frac{5}{3})x^3}{3!} + \dots = 1 + \frac{1}{3}x - \frac{1}{9}x^2 + \frac{5}{81}x^3 - \dots$
3. $(1-x)^{-1/2} = 1 - \frac{1}{2}(-x) + \frac{(-\frac{1}{2})(-\frac{3}{2})(-x)^2}{2!} + \frac{(-\frac{1}{2})(-\frac{3}{2})(-\frac{5}{2})(-x)^3}{3!} + \dots = 1 + \frac{1}{2}x + \frac{3}{8}x^2 + \frac{5}{16}x^3 + \dots$
4. $(1-2x)^{1/2} = 1 + \frac{1}{2}(-2x) + \frac{(\frac{1}{2})(-\frac{1}{2})(-2x)^2}{2!} + \frac{(\frac{1}{2})(-\frac{1}{2})(-\frac{3}{2})(-2x)^3}{3!} + \dots = 1 - x - \frac{1}{2}x^2 - \frac{1}{2}x^3 - \dots$
5. $(1+\frac{x}{2})^{-2} = 1 - 2(\frac{x}{2}) + \frac{(-2)(-3)(\frac{x}{2})^2}{2!} + \frac{(-2)(-3)(-4)(\frac{x}{2})^3}{3!} + \dots = 1 - x + \frac{3}{4}x^2 - \frac{1}{2}x^3$
6. $(1-\frac{x}{2})^{-2} = 1 - 2(-\frac{x}{2}) + \frac{(-2)(-3)(-\frac{x}{2})^2}{2!} + \frac{(-2)(-3)(-4)(-\frac{x}{2})^3}{3!} + \dots = 1 + x + \frac{3}{4}x^2 + \frac{1}{2}x^3 + \dots$
7. $(1+x^3)^{-1/2} = 1 - \frac{1}{2}x^3 + \frac{(-\frac{1}{2})(-\frac{3}{2})(x^3)^2}{2!} + \frac{(-\frac{1}{2})(-\frac{3}{2})(-\frac{5}{2})(x^3)^3}{3!} + \dots = 1 - \frac{1}{2}x^3 + \frac{3}{8}x^6 - \frac{5}{16}x^9 + \dots$
8. $(1+x^2)^{-1/3} = 1 - \frac{1}{3}x^2 + \frac{(-\frac{1}{3})(-\frac{4}{3})(x^2)^2}{2!} + \frac{(-\frac{1}{3})(-\frac{4}{3})(-\frac{7}{3})(x^2)^3}{3!} + \dots = 1 - \frac{1}{3}x^2 + \frac{2}{9}x^4 - \frac{14}{81}x^6 + \dots$
9. $(1+\frac{1}{x})^{1/2} = 1 + \frac{1}{2}(\frac{1}{x}) + \frac{(\frac{1}{2})(-\frac{1}{2})(\frac{1}{x})^2}{2!} + \frac{(\frac{1}{2})(-\frac{1}{2})(-\frac{3}{2})(\frac{1}{x})^3}{3!} + \dots = 1 + \frac{1}{2x} - \frac{1}{8x^2} + \frac{1}{16x^3} + \dots$
10. $(1-\frac{2}{x})^{1/3} = 1 + \frac{1}{3}(-\frac{2}{x}) + \frac{(\frac{1}{3})(-\frac{2}{3})(-\frac{2}{x})^2}{2!} + \frac{(\frac{1}{3})(-\frac{2}{3})(-\frac{5}{3})(-\frac{2}{x})^3}{3!} + \dots = 1 - \frac{2}{3x} - \frac{4}{9x^2} - \frac{40}{81x^3} - \dots$
11. $(1+x)^4 = 1 + 4x + \frac{(4)(3)x^2}{2!} + \frac{(4)(3)(2)x^3}{3!} + \frac{(4)(3)(2)x^4}{4!} = 1 + 4x + 6x^2 + 4x^3 + x^4$
12. $(1+x^2)^3 = 1 + 3x^2 + \frac{(3)(2)(x^2)^2}{2!} + \frac{(3)(2)(1)(x^2)^3}{3!} = 1 + 3x^2 + 3x^4 + x^6$
13. $(1-2x)^3 = 1 + 3(-2x) + \frac{(3)(2)(-2x)^2}{2!} + \frac{(3)(2)(1)(-2x)^3}{3!} = 1 - 6x + 12x^2 - 8x^3$
14. $(1-\frac{x}{2})^4 = 1 + 4(-\frac{x}{2}) + \frac{(4)(3)(-\frac{x}{2})^2}{2!} + \frac{(4)(3)(2)(-\frac{x}{2})^3}{3!} + \frac{(4)(3)(2)(1)(-\frac{x}{2})^4}{4!} = 1 - 2x + \frac{3}{2}x^2 - \frac{1}{2}x^3 + \frac{1}{16}x^4$
15. Assume the solution has the form $y = a_0 + a_1x + a_2x^2 + \dots + a_{n-1}x^{n-1} + a_nx^n + \dots$
 $\Rightarrow \frac{dy}{dx} = a_1 + 2a_2x + \dots + na_nx^{n-1} + \dots$

$$\begin{aligned} \Rightarrow \frac{dy}{dx} + y &= (a_1 + a_0) + (2a_2 + a_1)x + (3a_3 + a_2)x^2 + \dots + (na_n + a_{n-1})x^{n-1} + \dots = 0 \\ \Rightarrow a_1 + a_0 &= 0, 2a_2 + a_1 = 0, 3a_3 + a_2 = 0 \text{ and in general } na_n + a_{n-1} = 0. \text{ Since } y = 1 \text{ when } x = 0 \text{ we have} \\ a_0 &= 1. \text{ Therefore } a_1 = -1, a_2 = \frac{-a_1}{2 \cdot 1} = \frac{1}{2}, a_3 = \frac{-a_2}{3} = -\frac{1}{3 \cdot 2}, \dots, a_n = \frac{-a_{n-1}}{n} = \frac{(-1)^n}{n!} \\ \Rightarrow y &= 1 - x + \frac{1}{2}x^2 - \frac{1}{3!}x^3 + \dots + \frac{(-1)^n}{n!}x^n + \dots = \sum_{n=0}^{\infty} \frac{(-1)^n x^n}{n!} = e^{-x} \end{aligned}$$

16. Assume the solution has the form $y = a_0 + a_1x + a_2x^2 + \dots + a_{n-1}x^{n-1} + a_nx^n + \dots$

$$\begin{aligned} \Rightarrow \frac{dy}{dx} &= a_1 + 2a_2x + \dots + na_nx^{n-1} + \dots \\ \Rightarrow \frac{dy}{dx} - 2y &= (a_1 - 2a_0) + (2a_2 - 2a_1)x + (3a_3 - 2a_2)x^2 + \dots + (na_n - 2a_{n-1})x^{n-1} + \dots = 0 \\ \Rightarrow a_1 - 2a_0 &= 0, 2a_2 - 2a_1 = 0, 3a_3 - 2a_2 = 0 \text{ and in general } na_n - 2a_{n-1} = 0. \text{ Since } y = 1 \text{ when } x = 0 \text{ we have} \\ a_0 &= 1. \text{ Therefore } a_1 = 2a_0 = 2(1) = 2, a_2 = \frac{2}{2}a_1 = \frac{2}{2}(2) = \frac{2^2}{2}, a_3 = \frac{2}{3}a_2 = \frac{2}{3}\left(\frac{2^2}{2}\right) = \frac{2^3}{3 \cdot 2}, \dots, \\ a_n &= \left(\frac{2}{n}\right)a_{n-1} = \left(\frac{2}{n}\right)\left(\frac{2^{n-1}}{n-1}\right)a_{n-2} = \frac{2^n}{n!} \Rightarrow y = 1 + 2x + \frac{2^2}{2}x^2 + \frac{2^3}{3!}x^3 + \dots + \frac{2^n}{n!}x^n + \dots \\ &= 1 + (2x) + \frac{(2x)^2}{2!} + \frac{(2x)^3}{3!} + \dots + \frac{(2x)^n}{n!} + \dots = \sum_{n=0}^{\infty} \frac{(2x)^n}{n!} = e^{2x} \end{aligned}$$

17. Assume the solution has the form $y = a_0 + a_1x + a_2x^2 + \dots + a_{n-1}x^{n-1} + a_nx^n + \dots$

$$\begin{aligned} \Rightarrow \frac{dy}{dx} &= a_1 + 2a_2x + \dots + na_nx^{n-1} + \dots \\ \Rightarrow \frac{dy}{dx} - y &= (a_1 - a_0) + (2a_2 - a_1)x + (3a_3 - a_2)x^2 + \dots + (na_n - a_{n-1})x^{n-1} + \dots = 1 \\ \Rightarrow a_1 - a_0 &= 1, 2a_2 - a_1 = 0, 3a_3 - a_2 = 0 \text{ and in general } na_n - a_{n-1} = 0. \text{ Since } y = 0 \text{ when } x = 0 \text{ we have} \\ a_0 &= 0. \text{ Therefore } a_1 = 1, a_2 = \frac{a_1}{2} = \frac{1}{2}, a_3 = \frac{a_2}{3} = \frac{1}{3 \cdot 2}, a_4 = \frac{a_3}{4} = \frac{1}{4 \cdot 3 \cdot 2}, \dots, a_n = \frac{a_{n-1}}{n} = \frac{1}{n!} \\ \Rightarrow y &= 0 + 1x + \frac{1}{2}x^2 + \frac{1}{3 \cdot 2}x^3 + \frac{1}{4 \cdot 3 \cdot 2}x^4 + \dots + \frac{1}{n!}x^n + \dots \\ &= \left(1 + 1x + \frac{1}{2}x^2 + \frac{1}{3 \cdot 2}x^3 + \frac{1}{4 \cdot 3 \cdot 2}x^4 + \dots + \frac{1}{n!}x^n + \dots\right) - 1 = \sum_{n=0}^{\infty} \frac{x^n}{n!} - 1 = e^x - 1 \end{aligned}$$

18. Assume the solution has the form $y = a_0 + a_1x + a_2x^2 + \dots + a_{n-1}x^{n-1} + a_nx^n + \dots$

$$\begin{aligned} \Rightarrow \frac{dy}{dx} &= a_1 + 2a_2x + \dots + na_nx^{n-1} + \dots \\ \Rightarrow \frac{dy}{dx} + y &= (a_1 + a_0) + (2a_2 + a_1)x + (3a_3 + a_2)x^2 + \dots + (na_n + a_{n-1})x^{n-1} + \dots = 1 \\ \Rightarrow a_1 + a_0 &= 1, 2a_2 + a_1 = 0, 3a_3 + a_2 = 0 \text{ and in general } na_n + a_{n-1} = 0. \text{ Since } y = 2 \text{ when } x = 0 \text{ we have} \\ a_0 &= 2. \text{ Therefore } a_1 = 1 - a_0 = -1, a_2 = \frac{-a_1}{2 \cdot 1} = \frac{1}{2}, a_3 = \frac{-a_2}{3} = -\frac{1}{3 \cdot 2}, \dots, a_n = \frac{-a_{n-1}}{n} = \frac{(-1)^n}{n!} \\ \Rightarrow y &= 2 - x + \frac{1}{2}x^2 - \frac{1}{3 \cdot 2}x^3 + \dots + \frac{(-1)^n}{n!}x^n + \dots = 1 + \left(1 - x + \frac{1}{2}x^2 - \frac{1}{3 \cdot 2}x^3 + \dots + \frac{(-1)^n}{n!}x^n + \dots\right) \\ &= 1 + \sum_{n=0}^{\infty} \frac{(-1)^n x^n}{n!} = 1 + e^{-x} \end{aligned}$$

19. Assume the solution has the form $y = a_0 + a_1x + a_2x^2 + \dots + a_{n-1}x^{n-1} + a_nx^n + \dots$

$$\begin{aligned} \Rightarrow \frac{dy}{dx} &= a_1 + 2a_2x + \dots + na_nx^{n-1} + \dots \\ \Rightarrow \frac{dy}{dx} - y &= (a_1 - a_0) + (2a_2 - a_1)x + (3a_3 - a_2)x^2 + \dots + (na_n - a_{n-1})x^{n-1} + \dots = x \\ \Rightarrow a_1 - a_0 &= 0, 2a_2 - a_1 = 1, 3a_3 - a_2 = 0 \text{ and in general } na_n - a_{n-1} = 0. \text{ Since } y = 0 \text{ when } x = 0 \text{ we have} \\ a_0 &= 0. \text{ Therefore } a_1 = 0, a_2 = \frac{1 + a_1}{2} = \frac{1}{2}, a_3 = \frac{a_2}{3} = \frac{1}{3 \cdot 2}, a_4 = \frac{a_3}{4} = \frac{1}{4 \cdot 3 \cdot 2}, \dots, a_n = \frac{a_{n-1}}{n} = \frac{1}{n!} \\ \Rightarrow y &= 0 + 0x + \frac{1}{2}x^2 + \frac{1}{3 \cdot 2}x^3 + \frac{1}{4 \cdot 3 \cdot 2}x^4 + \dots + \frac{1}{n!}x^n + \dots \\ &= \left(1 + 1x + \frac{1}{2}x^2 + \frac{1}{3 \cdot 2}x^3 + \frac{1}{4 \cdot 3 \cdot 2}x^4 + \dots + \frac{1}{n!}x^n + \dots\right) - 1 - x = \sum_{n=0}^{\infty} \frac{x^n}{n!} - 1 - x = e^x - x - 1 \end{aligned}$$

20. Assume the solution has the form $y = a_0 + a_1x + a_2x^2 + \dots + a_{n-1}x^{n-1} + a_nx^n + \dots$

$$\begin{aligned} \Rightarrow \frac{dy}{dx} &= a_1 + 2a_2x + \dots + na_nx^{n-1} + \dots \\ \Rightarrow \frac{dy}{dx} + y &= (a_1 + a_0) + (2a_2 + a_1)x + (3a_3 + a_2)x^2 + \dots + (na_n + a_{n-1})x^{n-1} + \dots = 2x \\ \Rightarrow a_1 + a_0 &= 0, 2a_2 + a_1 = 2, 3a_3 + a_2 = 0 \text{ and in general } na_n + a_{n-1} = 0. \text{ Since } y = -1 \text{ when } x = 0 \text{ we have} \end{aligned}$$

$$\begin{aligned}
a_0 &= -1. \text{ Therefore } a_1 = 1, a_2 = \frac{2-a_1}{2} = \frac{1}{2}, a_3 = \frac{-a_2}{3} = -\frac{1}{3 \cdot 2}, \dots, a_n = \frac{-a_{n-1}}{n} = \frac{(-1)^n}{n!} \\
&\Rightarrow y = -1 + 1x + \frac{1}{2}x^2 - \frac{1}{3 \cdot 2}x^3 + \dots + \frac{(-1)^n}{n!}x^n + \dots \\
&= \left(1 - 1x + \frac{1}{2}x^2 - \frac{1}{3 \cdot 2}x^3 + \dots + \frac{(-1)^n}{n!}x^n + \dots\right) - 2 + 2x = \sum_{n=0}^{\infty} \frac{(-1)^n x^n}{n!} - 2 + 2x = e^{-x} + 2x - 2
\end{aligned}$$

21. $y' - xy = a_1 + (2a_2 - a_0)x + (3a_3 - a_1)x + \dots + (na_n - a_{n-2})x^{n-1} + \dots = 0 \Rightarrow a_1 = 0, 2a_2 - a_0 = 0, 3a_3 - a_1 = 0,$
 $4a_4 - a_2 = 0$ and in general $na_n - a_{n-2} = 0$. Since $y = 1$ when $x = 0$, we have $a_0 = 1$. Therefore $a_2 = \frac{a_0}{2} = \frac{1}{2},$
 $a_3 = \frac{a_1}{3} = 0, a_4 = \frac{a_2}{4} = \frac{1}{2 \cdot 4}, a_5 = \frac{a_3}{5} = 0, \dots, a_{2n} = \frac{1}{2 \cdot 4 \cdot 6 \cdot \dots \cdot 2n}$ and $a_{2n+1} = 0$

$$\Rightarrow y = 1 + \frac{1}{2}x^2 + \frac{1}{2 \cdot 4}x^4 + \frac{1}{2 \cdot 4 \cdot 6}x^6 + \dots + \frac{1}{2 \cdot 4 \cdot 6 \cdot \dots \cdot 2n}x^{2n} + \dots = \sum_{n=0}^{\infty} \frac{x^{2n}}{2^n n!} = \sum_{n=0}^{\infty} \frac{\left(\frac{x^2}{2}\right)^n}{n!} = e^{x^2/2}$$

22. $y' - x^2y = a_1 + 2a_2x + (3a_3 - a_0)x^2 + (4a_4 - a_1)x^3 + \dots + (na_n - a_{n-3})x^{n-1} + \dots = 0 \Rightarrow a_1 = 0, a_2 = 0,$
 $3a_3 - a_0 = 0, 4a_4 - a_1 = 0$ and in general $na_n - a_{n-3} = 0$. Since $y = 1$ when $x = 0$, we have $a_0 = 1$. Therefore
 $a_3 = \frac{a_0}{3} = \frac{1}{3}, a_4 = \frac{a_1}{4} = 0, a_5 = \frac{a_2}{5} = 0, a_6 = \frac{a_3}{6} = \frac{1}{3 \cdot 6}, \dots, a_{3n} = \frac{1}{3 \cdot 6 \cdot 9 \cdot \dots \cdot 3n}, a_{3n+1} = 0$ and $a_{3n+2} = 0$

$$\Rightarrow y = 1 + \frac{1}{3}x^3 + \frac{1}{3 \cdot 6}x^6 + \frac{1}{3 \cdot 6 \cdot 9}x^9 + \dots + \frac{1}{3 \cdot 6 \cdot 9 \cdot \dots \cdot 3n}x^{3n} + \dots = \sum_{n=0}^{\infty} \frac{x^{3n}}{3^n n!} = \sum_{n=0}^{\infty} \frac{\left(\frac{x^3}{3}\right)^n}{n!} = e^{x^3/3}$$

23. $(1-x)y' - y = (a_1 - a_0) + (2a_2 - a_1 - a_1)x + (3a_3 - 2a_2 - a_2)x^2 + (4a_4 - 3a_3 - a_3)x^3 + \dots$
 $+ (na_n - (n-1)a_{n-1} - a_{n-1})x^{n-1} + \dots = 0 \Rightarrow a_1 - a_0 = 0, 2a_2 - 2a_1 = 0, 3a_3 - 3a_2 = 0$ and in
 general $(na_n - na_{n-1}) = 0$. Since $y = 2$ when $x = 0$, we have $a_0 = 2$. Therefore

$$a_1 = 2, a_2 = 2, \dots, a_n = 2 \Rightarrow y = 2 + 2x + 2x^2 + \dots = \sum_{n=0}^{\infty} 2x^n = \frac{2}{1-x}$$

24. $(1+x^2)y' + 2xy = a_1 + (2a_2 + 2a_0)x + (3a_3 + 2a_1 + a_1)x^2 + (4a_4 + 2a_2 + 2a_2)x^3 + \dots + (na_n + na_{n-2})x^{n-1} + \dots$
 $= 0 \Rightarrow a_1 = 0, 2a_2 + 2a_0 = 0, 3a_3 + 3a_1 = 0, 4a_4 + 4a_2 = 0$ and in general $na_n + na_{n-2} = 0$. Since $y = 3$ when
 $x = 0$, we have $a_0 = 3$. Therefore $a_2 = -3, a_3 = 0, a_4 = 3, \dots, a_{2n+1} = 0, a_{2n} = (-1)^n 3$

$$\Rightarrow y = 3 - 3x^2 + 3x^4 - \dots = \sum_{n=0}^{\infty} 3(-1)^n x^{2n} = \sum_{n=0}^{\infty} 3(-x^2)^n = \frac{3}{1+x^2}$$

25. $y = a_0 + a_1x + a_2x^2 + \dots + a_nx^n + \dots \Rightarrow y'' = 2a_2 + 3 \cdot 2a_3x + \dots + n(n-1)a_nx^{n-2} + \dots \Rightarrow y'' - y$
 $= (2a_2 - a_0) + (3 \cdot 2a_3 - a_1)x + (4 \cdot 3a_4 - a_2)x^2 + \dots + (n(n-1)a_n - a_{n-2})x^{n-2} + \dots = 0 \Rightarrow 2a_2 - a_0 = 0,$
 $3 \cdot 2a_3 - a_1 = 0, 4 \cdot 3a_4 - a_2 = 0$ and in general $n(n-1)a_n - a_{n-2} = 0$. Since $y' = 1$ and $y = 0$ when $x = 0$,
 we have $a_0 = 0$ and $a_1 = 1$. Therefore $a_2 = 0, a_3 = \frac{1}{3 \cdot 2}, a_4 = 0, a_5 = \frac{1}{5 \cdot 4 \cdot 3 \cdot 2}, \dots, a_{2n+1} = \frac{1}{(2n+1)!}$ and
 $a_{2n} = 0 \Rightarrow y = x + \frac{1}{3!}x^3 + \frac{1}{5!}x^5 + \dots = \sum_{n=0}^{\infty} \frac{x^{2n+1}}{(2n+1)!} = \sinh x$

26. $y = a_0 + a_1x + a_2x^2 + \dots + a_nx^n + \dots \Rightarrow y'' = 2a_2 + 3 \cdot 2a_3x + \dots + n(n-1)a_nx^{n-2} + \dots \Rightarrow y'' + y$
 $= (2a_2 + a_0) + (3 \cdot 2a_3 + a_1)x + (4 \cdot 3a_4 + a_2)x^2 + \dots + (n(n-1)a_n + a_{n-2})x^{n-2} + \dots = 0 \Rightarrow 2a_2 + a_0 = 0,$
 $3 \cdot 2a_3 + a_1 = 0, 4 \cdot 3a_4 + a_2 = 0$ and in general $n(n-1)a_n + a_{n-2} = 0$. Since $y' = 0$ and $y = 1$ when $x = 0$,
 we have $a_0 = 1$ and $a_1 = 0$. Therefore $a_2 = -\frac{1}{2}, a_3 = 0, a_4 = \frac{1}{4 \cdot 3 \cdot 2}, a_5 = 0, \dots, a_{2n+1} = 0$ and $a_{2n} = \frac{(-1)^n}{(2n)!}$

$$\Rightarrow y = 1 - \frac{1}{2}x^2 + \frac{1}{4!}x^4 - \dots = \sum_{n=0}^{\infty} \frac{(-1)^n x^{2n}}{(2n)!} = \cos x$$

27. $y = a_0 + a_1x + a_2x^2 + \dots + a_nx^n + \dots \Rightarrow y'' = 2a_2 + 3 \cdot 2a_3x + \dots + n(n-1)a_nx^{n-2} + \dots \Rightarrow y'' + y$
 $= (2a_2 + a_0) + (3 \cdot 2a_3 + a_1)x + (4 \cdot 3a_4 + a_2)x^2 + \dots + (n(n-1)a_n + a_{n-2})x^{n-2} + \dots = x \Rightarrow 2a_2 + a_0 = 0,$
 $3 \cdot 2a_3 + a_1 = 1, 4 \cdot 3a_4 + a_2 = 0$ and in general $n(n-1)a_n + a_{n-2} = 0$. Since $y' = 1$ and $y = 2$ when $x = 0$,
 we have $a_0 = 2$ and $a_1 = 1$. Therefore $a_2 = -1, a_3 = 0, a_4 = \frac{1}{4 \cdot 3}, a_5 = 0, \dots, a_{2n} = -2 \cdot \frac{(-1)^{n+1}}{(2n)!}$ and

$$a_{2n+1} = 0 \Rightarrow y = 2 + x - x^2 + 2 \cdot \frac{x^4}{4!} + \dots = 2 + x - 2 \sum_{n=1}^{\infty} \frac{(-1)^{n+1} x^{2n}}{(2n)!} = x + \cos 2x$$

28. $y = a_0 + a_1x + a_2x^2 + \dots + a_nx^n + \dots \Rightarrow y'' = 2a_2 + 3 \cdot 2a_3x + \dots + n(n-1)a_nx^{n-2} + \dots \Rightarrow y'' - y$
 $= (2a_2 - a_0) + (3 \cdot 2a_3 - a_1)x + (4 \cdot 3a_4 - a_2)x^2 + \dots + (n(n-1)a_n - a_{n-2})x^{n-2} + \dots = x \Rightarrow 2a_2 - a_0 = 0,$
 $3 \cdot 2a_3 - a_1 = 1, 4 \cdot 3a_4 - a_2 = 0$ and in general $n(n-1)a_n - a_{n-2} = 0$. Since $y' = 2$ and $y = -1$ when $x = 0$,
 we have $a_0 = -1$ and $a_1 = 2$. Therefore $a_2 = \frac{-1}{2}, a_3 = \frac{1}{2}, a_4 = \frac{-1}{2 \cdot 3 \cdot 4}, a_5 = \frac{1}{5 \cdot 4 \cdot 2} = \frac{3}{5!}, \dots, a_{2n} = \frac{-1}{(2n)!}$

and $a_{2n+1} = \frac{3}{(2n+1)!} \Rightarrow y = -1 + 2x - \frac{1}{2}x^2 + \frac{3}{3!}x^3 - \dots = -1 + 2x - \sum_{n=1}^{\infty} \frac{x^{2n}}{(2n)!} + \sum_{n=1}^{\infty} \frac{3x^{2n+1}}{(2n+1)!}$

29. $y = a_0 + a_1(x-2) + a_2(x-2)^2 + \dots + a_n(x-2)^n + \dots$
 $\Rightarrow y'' = 2a_2 + 3 \cdot 2a_3(x-2) + \dots + n(n-1)a_n(x-2)^{n-2} + \dots \Rightarrow y'' - y$
 $= (2a_2 - a_0) + (3 \cdot 2a_3 - a_1)(x-2) + (4 \cdot 3a_4 - a_2)(x-2)^2 + \dots + (n(n-1)a_n - a_{n-2})(x-2)^{n-2} + \dots = -x$
 $= -(x-2) - 2 \Rightarrow 2a_2 - a_0 = -2, 3 \cdot 2a_3 - a_1 = -1,$ and $n(n-1)a_n - a_{n-2} = 0$ for $n > 3$. Since $y = 0$ when $x = 2$,
 we have $a_0 = 0$, and since $y' = -2$ when $x = 2$, we have $a_1 = -2$. Therefore $a_2 = -1, a_3 = -\frac{1}{2}, a_4 = \frac{1}{4 \cdot 3}(-1) = \frac{-2}{4 \cdot 3 \cdot 2 \cdot 1},$
 $a_5 = \frac{1}{5 \cdot 4}(-\frac{1}{2}) = \frac{-3}{5 \cdot 4 \cdot 3 \cdot 2 \cdot 1}, \dots, a_{2n} = \frac{-2}{(2n)!},$ and $a_{2n+1} = \frac{-3}{(2n+1)!}$. Since $a_1 = -2$, we have $a_1(x-2) = (-2)(x-2)$ and
 $(-2)(x-2) = (-3+1)(x-2) = (-3)(x-2) + (1)(x-2) = x-2-3(x-2).$
 $\Rightarrow y = x-2-3(x-2) - \frac{2}{2!}(x-2)^2 - \frac{3}{3!}(x-2)^3 - \frac{2}{4!}(x-2)^4 - \frac{3}{5!}(x-2)^5 - \dots$
 $\Rightarrow y = x-2 - \frac{2}{2!}(x-2)^2 - \frac{2}{4!}(x-2)^4 - \dots - 3(x-2)x - \frac{3}{3!}(x-2)^3 - \frac{3}{5!}(x-2)^5 - \dots$
 $\Rightarrow y = x - 2 \sum_{n=0}^{\infty} \frac{(x-2)^{2n}}{(2n)!} - 3 \sum_{n=0}^{\infty} \frac{(x-2)^{2n+1}}{(2n+1)!}$

30. $y'' - x^2y = 2a_2 + 6a_3x + (4 \cdot 3a_4 - a_0)x^2 + \dots + (n(n-1)a_n - a_{n-4})x^{n-2} + \dots = 0 \Rightarrow 2a_2 = 0, 6a_3 = 0,$
 $4 \cdot 3a_4 - a_0 = 0, 5 \cdot 4a_5 - a_1 = 0,$ and in general $n(n-1)a_n - a_{n-4} = 0$. Since $y' = b$ and $y = a$ when $x = 0$,
 we have $a_0 = a, a_1 = b, a_2 = 0, a_3 = 0, a_4 = \frac{a}{3 \cdot 4}, a_5 = \frac{b}{4 \cdot 5}, a_6 = 0, a_7 = 0, a_8 = \frac{a}{3 \cdot 4 \cdot 7 \cdot 8}, a_9 = \frac{b}{4 \cdot 5 \cdot 8 \cdot 9}$
 $\Rightarrow y = a + bx + \frac{a}{3 \cdot 4}x^4 + \frac{b}{4 \cdot 5}x^5 + \frac{a}{3 \cdot 4 \cdot 7 \cdot 8}x^8 + \frac{b}{4 \cdot 5 \cdot 8 \cdot 9}x^9 + \dots$

31. $y'' + x^2y = 2a_2 + 6a_3x + (4 \cdot 3a_4 + a_0)x^2 + \dots + (n(n-1)a_n + a_{n-4})x^{n-2} + \dots = x \Rightarrow 2a_2 = 0, 6a_3 = 1,$
 $4 \cdot 3a_4 + a_0 = 0, 5 \cdot 4a_5 + a_1 = 0,$ and in general $n(n-1)a_n + a_{n-4} = 0$. Since $y' = b$ and $y = a$ when $x = 0$,
 we have $a_0 = a$ and $a_1 = b$. Therefore $a_2 = 0, a_3 = \frac{1}{2 \cdot 3}, a_4 = -\frac{a}{3 \cdot 4}, a_5 = -\frac{b}{4 \cdot 5}, a_6 = 0, a_7 = \frac{-1}{2 \cdot 3 \cdot 6 \cdot 7}$
 $\Rightarrow y = a + bx + \frac{1}{2 \cdot 3}x^3 - \frac{a}{3 \cdot 4}x^4 - \frac{b}{4 \cdot 5}x^5 - \frac{1}{2 \cdot 3 \cdot 6 \cdot 7}x^7 + \frac{ax^8}{3 \cdot 4 \cdot 7 \cdot 8} + \frac{bx^9}{4 \cdot 5 \cdot 8 \cdot 9} + \dots$

32. $y'' - 2y' + y = (2a_2 - 2a_1 + a_0) + (2 \cdot 3a_3 - 4a_2 + a_1)x + (3 \cdot 4a_4 - 2 \cdot 3a_3 + a_2)x^2 + \dots$
 $+ ((n-1)a_n - 2(n-1)a_{n-1} + a_{n-2})x^{n-2} + \dots = 0 \Rightarrow 2a_2 - 2a_1 + a_0 = 0, 2 \cdot 3a_3 - 4a_2 + a_1 = 0,$
 $3 \cdot 4a_4 - 2 \cdot 3a_3 + a_2 = 0$ and in general $(n-1)a_n - 2(n-1)a_{n-1} + a_{n-2} = 0$. Since $y' = 1$ and $y = 0$ when
 when $x = 0$, we have $a_0 = 0$ and $a_1 = 1$. Therefore $a_2 = 1, a_3 = \frac{1}{2}, a_4 = \frac{1}{6}, a_5 = \frac{1}{24}$ and $a_n = \frac{1}{(n-1)!}$
 $\Rightarrow y = x + x^2 + \frac{1}{2}x^3 + \frac{1}{6}x^4 + \frac{1}{24}x^5 + \dots = \sum_{n=1}^{\infty} \frac{x^n}{(n-1)!} = \sum_{n=0}^{\infty} \frac{x^{n+1}}{n!} = x \sum_{n=0}^{\infty} \frac{x^n}{n!} = xe^x$

33. $\int_0^{0.2} \sin x^2 dx = \int_0^{0.2} \left(x^2 - \frac{x^6}{3!} + \frac{x^{10}}{5!} - \dots\right) dx = \left[\frac{x^3}{3} - \frac{x^7}{7 \cdot 3!} + \dots\right]_0^{0.2} \approx \left[\frac{x^3}{3}\right]_0^{0.2} \approx 0.00267$ with error
 $|E| \leq \frac{(2)^7}{7 \cdot 3!} \approx 0.0000003$

34. $\int_0^{0.2} \frac{e^{-x}-1}{x} dx = \int_0^{0.2} \frac{1}{x} \left(1 - x + \frac{x^2}{2!} - \frac{x^3}{3!} + \frac{x^4}{4!} - \dots - 1\right) dx = \int_0^{0.2} \left(-1 + \frac{x}{2} - \frac{x^2}{6} + \frac{x^3}{24} - \dots\right) dx$
 $= \left[-x + \frac{x^2}{4} - \frac{x^3}{18} + \dots\right]_0^{0.2} \approx -0.19044$ with error $|E| \leq \frac{(0.2)^4}{96} \approx 0.00002$

35. $\int_0^{0.1} \frac{1}{\sqrt{1+x^4}} dx = \int_0^{0.1} \left(1 - \frac{x^4}{2} + \frac{3x^8}{8} - \dots\right) dx = \left[x - \frac{x^5}{10} + \dots\right]_0^{0.1} \approx [x]_0^{0.1} \approx 0.1$ with error
 $|E| \leq \frac{(0.1)^5}{10} = 0.000001$
36. $\int_0^{0.25} \sqrt[3]{1+x^2} dx = \int_0^{0.25} \left(1 + \frac{x^2}{3} - \frac{x^4}{9} + \dots\right) dx = \left[x + \frac{x^3}{9} - \frac{x^5}{45} + \dots\right]_0^{0.25} \approx \left[x + \frac{x^3}{9}\right]_0^{0.25} \approx 0.25174$ with error
 $|E| \leq \frac{(0.25)^5}{45} \approx 0.0000217$
37. $\int_0^{0.1} \frac{\sin x}{x} dx = \int_0^{0.1} \left(1 - \frac{x^2}{3!} + \frac{x^4}{5!} - \frac{x^6}{7!} + \dots\right) dx = \left[x - \frac{x^3}{3 \cdot 3!} + \frac{x^5}{5 \cdot 5!} - \frac{x^7}{7 \cdot 7!} + \dots\right]_0^{0.1} \approx \left[x - \frac{x^3}{3 \cdot 3!} + \frac{x^5}{5 \cdot 5!}\right]_0^{0.1}$
 ≈ 0.0999444611 , $|E| \leq \frac{(0.1)^7}{7 \cdot 7!} \approx 2.8 \times 10^{-12}$
38. $\int_0^{0.1} \exp(-x^2) dx = \int_0^{0.1} \left(1 - x^2 + \frac{x^4}{2!} - \frac{x^6}{3!} + \frac{x^8}{4!} - \dots\right) dx = \left[x - \frac{x^3}{3} + \frac{x^5}{10} + \frac{x^7}{42} + \dots\right]_0^{0.1} \approx \left[x - \frac{x^3}{3} + \frac{x^5}{10} - \frac{x^7}{42}\right]_0^{0.1}$
 ≈ 0.0996676643 , $|E| \leq \frac{(0.1)^9}{216} \approx 4.6 \times 10^{-12}$
39. $(1+x^4)^{1/2} = (1)^{1/2} + \frac{\binom{1/2}{1}}{1} (1)^{-1/2} (x^4) + \frac{\binom{1/2}{2} \binom{-1/2}{1}}{2!} (1)^{-3/2} (x^4)^2 + \frac{\binom{1/2}{3} \binom{-1/2}{2} \binom{-3/2}{1}}{3!} (1)^{-5/2} (x^4)^3$
 $+ \frac{\binom{1/2}{4} \binom{-1/2}{3} \binom{-5/2}{2}}{4!} (1)^{-7/2} (x^4)^4 + \dots = 1 + \frac{x^4}{2} - \frac{x^8}{8} + \frac{x^{12}}{16} - \frac{5x^{16}}{128} + \dots$
 $\Rightarrow \int_0^{0.1} \left(1 + \frac{x^4}{2} - \frac{x^8}{8} + \frac{x^{12}}{16} - \frac{5x^{16}}{128} + \dots\right) dx \approx \left[x + \frac{x^5}{10}\right]_0^{0.1} \approx 0.100001$, $|E| \leq \frac{(0.1)^9}{72} \approx 1.39 \times 10^{-11}$
40. $\int_0^1 \left(\frac{1-\cos x}{x^2}\right) dx = \int_0^1 \left(\frac{1}{2} - \frac{x^2}{4!} + \frac{x^4}{6!} - \frac{x^6}{8!} + \frac{x^8}{10!} - \dots\right) dx \approx \left[\frac{x}{2} - \frac{x^3}{3 \cdot 4!} + \frac{x^5}{5 \cdot 6!} - \frac{x^7}{7 \cdot 8!} + \frac{x^9}{9 \cdot 10!}\right]_0^1$
 ≈ 0.4863853764 , $|E| \leq \frac{1}{11 \cdot 12!} \approx 1.9 \times 10^{-10}$
41. $\int_0^1 \cos t^2 dt = \int_0^1 \left(1 - \frac{t^4}{2} + \frac{t^8}{4!} - \frac{t^{12}}{6!} + \dots\right) dt = \left[t - \frac{t^5}{10} + \frac{t^9}{9 \cdot 4!} - \frac{t^{13}}{13 \cdot 6!} + \dots\right]_0^1 \Rightarrow |\text{error}| < \frac{1}{13 \cdot 6!} \approx .00011$
42. $\int_0^1 \cos \sqrt{t} dt = \int_0^1 \left(1 - \frac{t}{2} + \frac{t^2}{4!} - \frac{t^3}{6!} + \frac{t^4}{8!} - \dots\right) dt = \left[t - \frac{t^2}{4} + \frac{t^3}{3 \cdot 4!} - \frac{t^4}{4 \cdot 6!} + \frac{t^5}{5 \cdot 8!} - \dots\right]_0^1$
 $\Rightarrow |\text{error}| < \frac{1}{5 \cdot 8!} \approx 0.000004960$
43. $F(x) = \int_0^x \left(t^2 - \frac{t^6}{3!} + \frac{t^{10}}{5!} - \frac{t^{14}}{7!} + \dots\right) dt = \left[\frac{t^3}{3} - \frac{t^7}{7 \cdot 3!} + \frac{t^{11}}{11 \cdot 5!} - \frac{t^{15}}{15 \cdot 7!} + \dots\right]_0^x \approx \frac{x^3}{3} - \frac{x^7}{7 \cdot 3!} + \frac{x^{11}}{11 \cdot 5!}$
 $\Rightarrow |\text{error}| < \frac{1}{15 \cdot 7!} \approx 0.000013$
44. $F(x) = \int_0^x \left(t^2 - t^4 + \frac{t^6}{2!} - \frac{t^8}{3!} + \frac{t^{10}}{4!} - \frac{t^{12}}{5!} + \dots\right) dt = \left[\frac{t^3}{3} - \frac{t^5}{5} + \frac{t^7}{7 \cdot 2!} - \frac{t^9}{9 \cdot 3!} + \frac{t^{11}}{11 \cdot 4!} - \frac{t^{13}}{13 \cdot 5!} + \dots\right]_0^x$
 $\approx \frac{x^3}{3} - \frac{x^5}{5} + \frac{x^7}{7 \cdot 2!} - \frac{x^9}{9 \cdot 3!} + \frac{x^{11}}{11 \cdot 4!} \Rightarrow |\text{error}| < \frac{1}{13 \cdot 5!} \approx 0.00064$
45. (a) $F(x) = \int_0^x \left(t - \frac{t^3}{3} + \frac{t^5}{5} - \frac{t^7}{7} + \dots\right) dt = \left[\frac{t^2}{2} - \frac{t^4}{12} + \frac{t^6}{30} - \dots\right]_0^x \approx \frac{x^2}{2} - \frac{x^4}{12} \Rightarrow |\text{error}| < \frac{(0.5)^6}{30} \approx .00052$
 (b) $|\text{error}| < \frac{1}{33 \cdot 34} \approx .00089$ when $F(x) \approx \frac{x^2}{2} - \frac{x^4}{3 \cdot 4} + \frac{x^6}{5 \cdot 6} - \frac{x^8}{7 \cdot 8} + \dots + (-1)^{15} \frac{x^{32}}{31 \cdot 32}$
46. (a) $F(x) = \int_0^x \left(1 - \frac{t}{2} + \frac{t^2}{3} - \frac{t^3}{4} + \dots\right) dt = \left[t - \frac{t^2}{2 \cdot 2} + \frac{t^3}{3 \cdot 3} - \frac{t^4}{4 \cdot 4} + \frac{t^5}{5 \cdot 5} - \dots\right]_0^x \approx x - \frac{x^2}{2^2} + \frac{x^3}{3^2} - \frac{x^4}{4^2} + \frac{x^5}{5^2}$
 $\Rightarrow |\text{error}| < \frac{(0.5)^6}{6^2} \approx .00043$
 (b) $|\text{error}| < \frac{1}{32^2} \approx .00097$ when $F(x) \approx x - \frac{x^2}{2^2} + \frac{x^3}{3^2} - \frac{x^4}{4^2} + \dots + (-1)^{31} \frac{x^{31}}{31^2}$

47. $\frac{1}{x^2}(e^x - (1+x)) = \frac{1}{x^2}\left(\left(1+x+\frac{x^2}{2}+\frac{x^3}{3!}+\dots\right) - 1-x\right) = \frac{1}{2} + \frac{x}{3!} + \frac{x^2}{4!} + \dots \Rightarrow \lim_{x \rightarrow 0} \frac{e^x - (1+x)}{x^2}$
 $= \lim_{x \rightarrow 0} \left(\frac{1}{2} + \frac{x}{3!} + \frac{x^2}{4!} + \dots\right) = \frac{1}{2}$
48. $\frac{1}{x}(e^x - e^{-x}) = \frac{1}{x}\left[\left(1+x+\frac{x^2}{2!}+\frac{x^3}{3!}+\frac{x^4}{4!}+\dots\right) - \left(1-x+\frac{x^2}{2!}-\frac{x^3}{3!}+\frac{x^4}{4!}-\dots\right)\right] = \frac{1}{x}\left(2x+\frac{2x^3}{3!}+\frac{2x^5}{5!}+\frac{2x^7}{7!}+\dots\right)$
 $= 2 + \frac{2x^2}{3!} + \frac{2x^4}{5!} + \frac{2x^6}{7!} + \dots \Rightarrow \lim_{x \rightarrow 0} \frac{e^x - e^{-x}}{x} = \lim_{x \rightarrow \infty} \left(2 + \frac{2x^2}{3!} + \frac{2x^4}{5!} + \frac{2x^6}{7!} + \dots\right) = 2$
49. $\frac{1}{t^4}\left(1 - \cos t - \frac{t^2}{2}\right) = \frac{1}{t^4}\left[1 - \frac{t^2}{2} - \left(1 - \frac{t^2}{2} + \frac{t^4}{4!} - \frac{t^6}{6!} + \dots\right)\right] = -\frac{1}{4!} + \frac{t^2}{6!} - \frac{t^4}{8!} + \dots \Rightarrow \lim_{t \rightarrow 0} \frac{1 - \cos t - \left(\frac{t^2}{2}\right)}{t^4}$
 $= \lim_{t \rightarrow 0} \left(-\frac{1}{4!} + \frac{t^2}{6!} - \frac{t^4}{8!} + \dots\right) = -\frac{1}{24}$
50. $\frac{1}{\theta^6}\left(-\theta + \frac{\theta^3}{6} + \sin \theta\right) = \frac{1}{\theta^6}\left(-\theta + \frac{\theta^3}{6} + \theta - \frac{\theta^3}{3!} + \frac{\theta^5}{5!} - \dots\right) = \frac{1}{5!} - \frac{\theta^2}{7!} + \frac{\theta^4}{9!} - \dots \Rightarrow \lim_{\theta \rightarrow 0} \frac{\sin \theta - \theta + \left(\frac{\theta^3}{6}\right)}{\theta^6}$
 $= \lim_{\theta \rightarrow 0} \left(\frac{1}{5!} - \frac{\theta^2}{7!} + \frac{\theta^4}{9!} - \dots\right) = \frac{1}{120}$
51. $\frac{1}{y^3}(y - \tan^{-1} y) = \frac{1}{y^3}\left[y - \left(y - \frac{y^3}{3} + \frac{y^5}{5} - \dots\right)\right] = \frac{1}{3} - \frac{y^2}{5} + \frac{y^4}{7} - \dots \Rightarrow \lim_{y \rightarrow 0} \frac{y - \tan^{-1} y}{y^3} = \lim_{y \rightarrow 0} \left(\frac{1}{3} - \frac{y^2}{5} + \frac{y^4}{7} - \dots\right)$
 $= \frac{1}{3}$
52. $\frac{\tan^{-1} y - \sin y}{y^3 \cos y} = \frac{\left(y - \frac{y^3}{3} + \frac{y^5}{5} - \dots\right) - \left(y - \frac{y^3}{3!} + \frac{y^5}{5!} - \dots\right)}{y^3 \cos y} = \frac{\left(-\frac{y^3}{6} + \frac{23y^5}{5!} - \dots\right)}{y^3 \cos y} = \frac{\left(-\frac{1}{6} + \frac{23y^2}{5!} - \dots\right)}{\cos y}$
 $\Rightarrow \lim_{y \rightarrow 0} \frac{\tan^{-1} y - \sin y}{y^3 \cos y} = \lim_{y \rightarrow 0} \frac{\left(-\frac{1}{6} + \frac{23y^2}{5!} - \dots\right)}{\cos y} = -\frac{1}{6}$
53. $x^2\left(-1 + e^{-1/x^2}\right) = x^2\left(-1 + 1 - \frac{1}{x^2} + \frac{1}{2x^4} - \frac{1}{6x^6} + \dots\right) = -1 + \frac{1}{2x^2} - \frac{1}{6x^4} + \dots \Rightarrow \lim_{x \rightarrow \infty} x^2\left(e^{-1/x^2} - 1\right)$
 $= \lim_{x \rightarrow \infty} \left(-1 + \frac{1}{2x^2} - \frac{1}{6x^4} + \dots\right) = -1$
54. $(x+1)\sin\left(\frac{1}{x+1}\right) = (x+1)\left(\frac{1}{x+1} - \frac{1}{3!(x+1)^3} + \frac{1}{5!(x+1)^5} - \dots\right) = 1 - \frac{1}{3!(x+1)^2} + \frac{1}{5!(x+1)^4} - \dots$
 $\Rightarrow \lim_{x \rightarrow \infty} (x+1)\sin\left(\frac{1}{x+1}\right) = \lim_{x \rightarrow \infty} \left(1 - \frac{1}{3!(x+1)^2} + \frac{1}{5!(x+1)^4} - \dots\right) = 1$
55. $\frac{\ln(1+x^2)}{1-\cos x} = \frac{\left(x^2 - \frac{x^4}{2} + \frac{x^6}{3} - \dots\right)}{1 - \left(1 - \frac{x^2}{2!} + \frac{x^4}{4!} - \dots\right)} = \frac{\left(1 - \frac{x^2}{2} + \frac{x^4}{3} - \dots\right)}{\left(\frac{1}{2!} - \frac{x^2}{4!} + \dots\right)} \Rightarrow \lim_{x \rightarrow 0} \frac{\ln(1+x^2)}{1-\cos x} = \lim_{x \rightarrow 0} \frac{\left(1 - \frac{x^2}{2} + \frac{x^4}{3} - \dots\right)}{\left(\frac{1}{2!} - \frac{x^2}{4!} + \dots\right)} = 2! = 2$
56. $\frac{x^2-4}{\ln(x-1)} = \frac{(x-2)(x+2)}{\left[(x-2) - \frac{(x-2)^2}{2} + \frac{(x-2)^3}{3} - \dots\right]} = \frac{x+2}{\left[1 - \frac{x-2}{2} + \frac{(x-2)^2}{3} - \dots\right]} \Rightarrow \lim_{x \rightarrow 2} \frac{x^2-4}{\ln(x-1)}$
 $= \lim_{x \rightarrow 2} \frac{x+2}{\left[1 - \frac{x-2}{2} + \frac{(x-2)^2}{3} - \dots\right]} = 4$
57. $\ln\left(\frac{1+x}{1-x}\right) = \ln(1+x) - \ln(1-x) = \left(x - \frac{x^2}{2} + \frac{x^3}{3} - \frac{x^4}{4} + \dots\right) - \left(-x - \frac{x^2}{2} - \frac{x^3}{3} - \frac{x^4}{4} - \dots\right) = 2\left(x + \frac{x^3}{3} + \frac{x^5}{5} + \dots\right)$
58. $\ln(1+x) = x - \frac{x^2}{2} + \frac{x^3}{3} - \frac{x^4}{4} + \dots + \frac{(-1)^{n-1}x^n}{n} + \dots \Rightarrow |\text{error}| = \left|\frac{(-1)^{n-1}x^n}{n}\right| = \frac{1}{n10^n}$ when $x = 0.1$;
 $\frac{1}{n10^n} < \frac{1}{10^8} \Rightarrow n10^n > 10^8$ when $n \geq 8 \Rightarrow 7$ terms

59. $\tan^{-1} x = x - \frac{x^3}{3} + \frac{x^5}{5} - \frac{x^7}{7} + \frac{x^9}{9} - \dots + \frac{(-1)^{n-1}x^{2n-1}}{2n-1} + \dots \Rightarrow |\text{error}| = \left| \frac{(-1)^{n-1}x^{2n-1}}{2n-1} \right| = \frac{1}{2n-1}$ when $x = 1$;
 $\frac{1}{2n-1} < \frac{1}{10^3} \Rightarrow n > \frac{1001}{2} = 500.5 \Rightarrow$ the first term not used is the 501st \Rightarrow we must use 500 terms

60. $\tan^{-1} x = x - \frac{x^3}{3} + \frac{x^5}{5} - \frac{x^7}{7} + \frac{x^9}{9} - \dots + \frac{(-1)^{n-1}x^{2n-1}}{2n-1} + \dots$ and $\lim_{n \rightarrow \infty} \left| \frac{x^{2n+1}}{2n+1} \cdot \frac{2n-1}{x^{2n-1}} \right| = x^2 \lim_{n \rightarrow \infty} \left| \frac{2n-1}{2n+1} \right| = x^2$
 $\Rightarrow \tan^{-1} x$ converges for $|x| < 1$; when $x = -1$ we have $\sum_{n=1}^{\infty} \frac{(-1)^n}{2n-1}$ which is a convergent series; when $x = 1$
 we have $\sum_{n=1}^{\infty} \frac{(-1)^{n-1}}{2n-1}$ which is a convergent series \Rightarrow the series representing $\tan^{-1} x$ diverges for $|x| > 1$

61. $\tan^{-1} x = x - \frac{x^3}{3} + \frac{x^5}{5} - \frac{x^7}{7} + \frac{x^9}{9} - \dots + \frac{(-1)^{n-1}x^{2n-1}}{2n-1} + \dots$ and when the series representing $48 \tan^{-1} \left(\frac{1}{18}\right)$ has an error less than $\frac{1}{3} \cdot 10^{-6}$, then the series representing the sum $48 \tan^{-1} \left(\frac{1}{18}\right) + 32 \tan^{-1} \left(\frac{1}{57}\right) - 20 \tan^{-1} \left(\frac{1}{239}\right)$ also has an error of magnitude less than 10^{-6} ; thus
 $|\text{error}| = 48 \frac{\left(\frac{1}{18}\right)^{2n-1}}{2n-1} < \frac{1}{3 \cdot 10^6} \Rightarrow n \geq 4$ using a calculator $\Rightarrow 4$ terms

62. $\ln(\sec x) = \int_0^x \tan t \, dt = \int_0^x \left(t + \frac{t^3}{3} + \frac{2t^5}{15} + \dots \right) dt \approx \frac{x^2}{2} + \frac{x^4}{12} + \frac{x^6}{45} + \dots$

63. (a) $(1 - x^2)^{-1/2} \approx 1 + \frac{x^2}{2} + \frac{3x^4}{8} + \frac{5x^6}{16} \Rightarrow \sin^{-1} x \approx x + \frac{x^3}{6} + \frac{3x^5}{40} + \frac{5x^7}{112}$; Using the Ratio Test:
 $\lim_{n \rightarrow \infty} \left| \frac{1 \cdot 3 \cdot 5 \cdot \dots \cdot (2n-1)(2n+1)x^{2n+3}}{2 \cdot 4 \cdot 6 \cdot \dots \cdot (2n)(2n+2)(2n+3)} \cdot \frac{2 \cdot 4 \cdot 6 \cdot \dots \cdot (2n)(2n+1)}{1 \cdot 3 \cdot 5 \cdot \dots \cdot (2n-1)x^{2n+1}} \right| < 1 \Rightarrow x^2 \lim_{n \rightarrow \infty} \left| \frac{(2n+1)(2n+1)}{(2n+2)(2n+3)} \right| < 1$
 $\Rightarrow |x| < 1 \Rightarrow$ the radius of convergence is 1. See Exercise 69.

(b) $\frac{d}{dx} (\cos^{-1} x) = -(1 - x^2)^{-1/2} \Rightarrow \cos^{-1} x = \frac{\pi}{2} - \sin^{-1} x \approx \frac{\pi}{2} - \left(x + \frac{x^3}{6} + \frac{3x^5}{40} + \frac{5x^7}{112} \right) \approx \frac{\pi}{2} - x - \frac{x^3}{6} - \frac{3x^5}{40} - \frac{5x^7}{112}$

64. (a) $(1 + t^2)^{-1/2} \approx (1)^{-1/2} + \left(-\frac{1}{2}\right)(1)^{-3/2}(t^2) + \frac{\left(-\frac{1}{2}\right)\left(-\frac{3}{2}\right)(1)^{-5/2}(t^2)^2}{2!} + \frac{\left(-\frac{1}{2}\right)\left(-\frac{3}{2}\right)\left(-\frac{5}{2}\right)(1)^{-7/2}(t^2)^3}{3!}$
 $= 1 - \frac{t^2}{2} + \frac{3t^4}{2^2 \cdot 2!} - \frac{3 \cdot 5t^6}{2^3 \cdot 3!} \Rightarrow \sinh^{-1} x \approx \int_0^x \left(1 - \frac{t^2}{2} + \frac{3t^4}{8} - \frac{5t^6}{16} \right) dt = x - \frac{x^3}{6} + \frac{3x^5}{40} - \frac{5x^7}{112}$

(b) $\sinh^{-1} \left(\frac{1}{4}\right) \approx \frac{1}{4} - \frac{1}{384} + \frac{3}{40,960} = 0.24746908$; the error is less than the absolute value of the first unused term, $\frac{5x^7}{112}$, evaluated at $t = \frac{1}{4}$ since the series is alternating $\Rightarrow |\text{error}| < \frac{5\left(\frac{1}{4}\right)^7}{112} \approx 2.725 \times 10^{-6}$

65. $\frac{-1}{1+x} = -\frac{1}{1-(-x)} = -1 + x - x^2 + x^3 - \dots \Rightarrow \frac{d}{dx} \left(\frac{-1}{1+x}\right) = \frac{1}{1+x^2} = \frac{d}{dx} (-1 + x - x^2 + x^3 - \dots)$
 $= 1 - 2x + 3x^2 - 4x^3 + \dots$

66. $\frac{1}{1-x^2} = 1 + x^2 + x^4 + x^6 + \dots \Rightarrow \frac{d}{dx} \left(\frac{1}{1-x^2}\right) = \frac{2x}{(1-x^2)^2} = \frac{d}{dx} (1 + x^2 + x^4 + x^6 + \dots) = 2x + 4x^3 + 6x^5 + \dots$

67. Wallis' formula gives the approximation $\pi \approx 4 \left[\frac{2 \cdot 4 \cdot 6 \cdot 8 \cdot \dots \cdot (2n-2) \cdot (2n)}{3 \cdot 3 \cdot 5 \cdot 5 \cdot 7 \cdot 7 \cdot \dots \cdot (2n-1) \cdot (2n-1)} \right]$ to produce the table

n	$\sim \pi$
10	3.221088998
20	3.181104886
30	3.167880758
80	3.151425420
90	3.150331383
93	3.150049112
94	3.149959030
95	3.149870848
100	3.149456425

At $n = 1929$ we obtain the first approximation accurate to 3 decimals: 3.141999845. At $n = 30,000$ we still do not obtain accuracy to 4 decimals: 3.141617732, so the convergence to π is very slow. Here is a Maple CAS procedure to produce these approximations:

```

pie :=
proc(n)
local i,j;
a(2) := evalf(8/9);
for i from 3 to n do a(i) := evalf(2*(2*i-2)*i/(2*i-1)^2*a(i-1)) od;
[[j,4*a(j)] $ (j = n-5 .. n)]
end

```

$$\begin{aligned}
68. \quad \ln 1 &= 0; \ln 2 = \ln \frac{1 + \left(\frac{1}{3}\right)}{1 - \left(\frac{1}{3}\right)} \approx 2 \left(\frac{1}{3} + \frac{\left(\frac{1}{3}\right)^3}{3} + \frac{\left(\frac{1}{3}\right)^5}{5} + \frac{\left(\frac{1}{3}\right)^7}{7} \right) \approx 0.69314; \ln 3 = \ln 2 + \ln \left(\frac{3}{2}\right) = \ln 2 + \ln \frac{1 + \left(\frac{1}{3}\right)}{1 - \left(\frac{1}{3}\right)} \\
&\approx \ln 2 + 2 \left(\frac{1}{3} + \frac{\left(\frac{1}{3}\right)^3}{3} + \frac{\left(\frac{1}{3}\right)^5}{5} + \frac{\left(\frac{1}{3}\right)^7}{7} \right) \approx 1.09861; \ln 4 = 2 \ln 2 \approx 1.38628; \ln 5 = \ln 4 + \ln \left(\frac{5}{4}\right) = \ln 4 + \ln \frac{1 + \left(\frac{1}{9}\right)}{1 - \left(\frac{1}{9}\right)} \\
&\approx 1.60943; \ln 6 = \ln 2 + \ln 3 \approx 1.79175; \ln 7 = \ln 6 + \ln \left(\frac{7}{6}\right) = \ln 6 + \ln \frac{1 + \left(\frac{1}{13}\right)}{1 - \left(\frac{1}{13}\right)} \approx 1.94591; \ln 8 = 3 \ln 2 \\
&\approx 2.07944; \ln 9 = 2 \ln 3 \approx 2.19722; \ln 10 = \ln 2 + \ln 5 \approx 2.30258
\end{aligned}$$

$$\begin{aligned}
69. \quad (1 - x^2)^{-1/2} &= (1 + (-x^2))^{-1/2} = (1)^{-1/2} + \left(-\frac{1}{2}\right)(1)^{-3/2}(-x^2) + \frac{\left(-\frac{1}{2}\right)\left(-\frac{3}{2}\right)(1)^{-5/2}(-x^2)^2}{2!} \\
&+ \frac{\left(-\frac{1}{2}\right)\left(-\frac{3}{2}\right)\left(-\frac{5}{2}\right)(1)^{-7/2}(-x^2)^3}{3!} + \dots = 1 + \frac{x^2}{2} + \frac{1 \cdot 3x^4}{2^2 \cdot 2!} + \frac{1 \cdot 3 \cdot 5x^6}{2^3 \cdot 3!} + \dots = 1 + \sum_{n=1}^{\infty} \frac{1 \cdot 3 \cdot 5 \cdots (2n-1)x^{2n}}{2^n \cdot n!} \\
\Rightarrow \sin^{-1} x &= \int_0^x (1 - t^2)^{-1/2} dt = \int_0^x \left(1 + \sum_{n=1}^{\infty} \frac{1 \cdot 3 \cdot 5 \cdots (2n-1)t^{2n}}{2^n \cdot n!} \right) dt = x + \sum_{n=1}^{\infty} \frac{1 \cdot 3 \cdot 5 \cdots (2n-1)x^{2n+1}}{2 \cdot 4 \cdots (2n)(2n+1)},
\end{aligned}$$

where $|x| < 1$

$$\begin{aligned}
70. \quad [\tan^{-1} t]_x^{\infty} &= \frac{\pi}{2} - \tan^{-1} x = \int_x^{\infty} \frac{dt}{1+t^2} = \int_x^{\infty} \left[\frac{\left(\frac{1}{t^2}\right)}{1 + \left(\frac{1}{t^2}\right)} \right] dt = \int_x^{\infty} \frac{1}{t^2} \left(1 - \frac{1}{t^2} + \frac{1}{t^4} - \frac{1}{t^6} + \dots \right) dt \\
&= \int_x^{\infty} \left(\frac{1}{t^2} - \frac{1}{t^4} + \frac{1}{t^6} - \frac{1}{t^8} + \dots \right) dt = \lim_{b \rightarrow \infty} \left[-\frac{1}{t} + \frac{1}{3t^3} - \frac{1}{5t^5} + \frac{1}{7t^7} - \dots \right]_x^b = \frac{1}{x} - \frac{1}{3x^3} + \frac{1}{5x^5} - \frac{1}{7x^7} + \dots \\
\Rightarrow \tan^{-1} x &= \frac{\pi}{2} - \frac{1}{x} + \frac{1}{3x^3} - \frac{1}{5x^5} + \dots, \quad x > 1; [\tan^{-1} t]_{-\infty}^x = \tan^{-1} x + \frac{\pi}{2} = \int_{-\infty}^x \frac{dt}{1+t^2} \\
&= \lim_{b \rightarrow -\infty} \left[-\frac{1}{t} + \frac{1}{3t^3} - \frac{1}{5t^5} + \frac{1}{7t^7} - \dots \right]_b^x = -\frac{1}{x} + \frac{1}{3x^3} - \frac{1}{5x^5} + \frac{1}{7x^7} - \dots \Rightarrow \tan^{-1} x = -\frac{\pi}{2} - \frac{1}{x} + \frac{1}{3x^3} - \frac{1}{5x^5} + \dots, \\
&x < -1
\end{aligned}$$

$$71. \quad (a) \quad \tan(\tan^{-1}(n+1)) - \tan^{-1}(n-1) = \frac{\tan(\tan^{-1}(n+1)) - \tan(\tan^{-1}(n-1))}{1 + \tan(\tan^{-1}(n+1))\tan(\tan^{-1}(n-1))} = \frac{(n+1) - (n-1)}{1 + (n+1)(n-1)} = \frac{2}{n^2}$$

$$\begin{aligned}
(b) \quad \sum_{n=1}^N \tan^{-1} \left(\frac{2}{n^2} \right) &= \sum_{n=1}^N [\tan^{-1}(n+1) - \tan^{-1}(n-1)] = (\tan^{-1} 2 - \tan^{-1} 0) + (\tan^{-1} 3 - \tan^{-1} 1) \\
&+ (\tan^{-1} 4 - \tan^{-1} 2) + \dots + (\tan^{-1}(N+1) - \tan^{-1}(N-1)) = \tan^{-1}(N+1) + \tan^{-1} N - \frac{\pi}{4}
\end{aligned}$$

$$(c) \quad \sum_{n=1}^{\infty} \tan^{-1} \left(\frac{2}{n^2} \right) = \lim_{N \rightarrow \infty} [\tan^{-1}(N+1) + \tan^{-1} N - \frac{\pi}{4}] = \frac{\pi}{2} + \frac{\pi}{2} - \frac{\pi}{4} = \frac{3\pi}{4}$$

11.11 FOURIER SERIES

$$1. \quad a_0 = \frac{1}{2\pi} \int_0^{2\pi} 1 \, dx = 1, \quad a_k = \frac{1}{\pi} \int_0^{2\pi} \cos kx \, dx = \frac{1}{\pi} \left[\frac{\sin kx}{k} \right]_0^{2\pi} = 0, \quad b_k = \frac{1}{\pi} \int_0^{2\pi} \sin kx \, dx = \frac{1}{\pi} \left[-\frac{\cos kx}{k} \right]_0^{2\pi} = 0.$$

Thus, the Fourier series for $f(x)$ is 1.

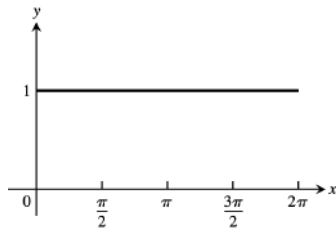

$$2. \quad a_0 = \frac{1}{2\pi} \left[\int_0^\pi 1 \, dx + \int_\pi^{2\pi} -1 \, dx \right] = 0, \quad a_k = \frac{1}{\pi} \left[\int_0^\pi \cos kx \, dx - \int_\pi^{2\pi} \cos kx \, dx \right] = \frac{1}{\pi} \left[\frac{\sin kx}{k} \Big|_0^\pi - \frac{\sin kx}{k} \Big|_\pi^{2\pi} \right] = 0,$$

$$b_k = \frac{1}{\pi} \left[\int_0^\pi \sin kx \, dx - \int_\pi^{2\pi} \sin kx \, dx \right] = \frac{1}{\pi} \left[-\frac{\cos kx}{k} \Big|_0^\pi + \frac{\cos kx}{k} \Big|_\pi^{2\pi} \right] = \frac{1}{k\pi} [(-\cos k\pi + 1) + (\cos 2k\pi - \cos k\pi)]$$

$$= \frac{1}{k\pi} (2 - 2 \cos k\pi) = \begin{cases} \frac{4}{k\pi}, & k \text{ odd} \\ 0, & k \text{ even} \end{cases}.$$

Thus, the Fourier series for $f(x)$ is $\frac{4}{\pi} \left[\sin x + \frac{\sin 3x}{3} + \frac{\sin 5x}{5} + \dots \right]$.

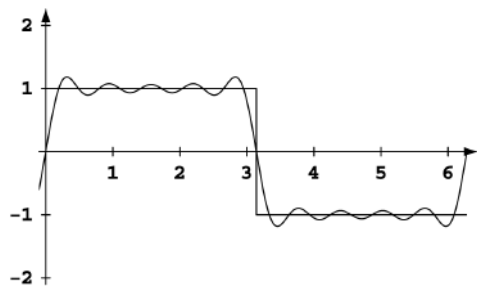

$$3. \quad a_0 = \frac{1}{2\pi} \left[\int_0^\pi x \, dx + \int_\pi^{2\pi} (x - 2\pi) \, dx \right] = \frac{1}{2\pi} \left[\frac{1}{2}\pi^2 + \frac{1}{2}(4\pi^2 - \pi^2) - 2\pi^2 \right] = 0. \quad \text{Note,}$$

$$\int_\pi^{2\pi} (x - 2\pi) \cos kx \, dx = -\int_0^\pi u \cos ku \, du \quad (\text{Let } u = 2\pi - x). \quad \text{So } a_k = \frac{1}{\pi} \left[\int_0^\pi x \cos kx \, dx + \int_\pi^{2\pi} (x - 2\pi) \cos kx \, dx \right] = 0.$$

Note, $\int_\pi^{2\pi} (x - 2\pi) \sin kx \, dx = \int_0^\pi u \sin ku \, du$ (Let $u = 2\pi - x$). So $b_k = \frac{1}{\pi} \left[\int_0^\pi x \sin kx \, dx + \int_\pi^{2\pi} (x - 2\pi) \sin kx \, dx \right]$

$$= \frac{2}{\pi} \int_0^\pi x \sin kx \, dx = \frac{2}{\pi} \left[-\frac{x}{k} \cos kx + \frac{1}{k^2} \sin kx \right]_0^\pi = -\frac{2}{k} \cos k\pi = \frac{2}{k} (-1)^{k+1}.$$

Thus, the Fourier series for $f(x)$ is $\sum_{k=1}^{\infty} (-1)^{k+1} \frac{2 \sin kx}{k}$.

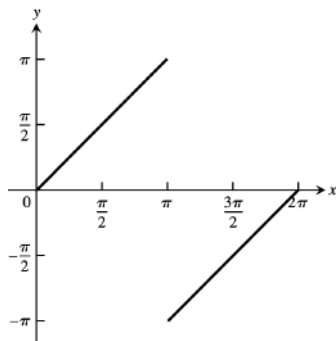

$$4. \quad a_0 = \frac{1}{2\pi} \int_0^{2\pi} f(x) \, dx = \frac{1}{2\pi} \int_0^\pi x^2 \, dx = \frac{1}{6}\pi^2, \quad a_k = \frac{1}{\pi} \int_0^{2\pi} f(x) \cos kx \, dx = \frac{1}{\pi} \int_0^\pi x^2 \cos kx \, dx$$

$$= \frac{1}{\pi} \left[\left(\frac{x^2}{k} - \frac{2x}{k^2} \right) \sin kx + \frac{2}{k^2} x \cos kx \right]_0^\pi = \frac{2}{k^2} \cos k\pi = (-1)^k \left(\frac{2}{k^2} \right), \quad b_k = \frac{1}{\pi} \int_0^{2\pi} f(x) \sin kx \, dx = \frac{1}{\pi} \int_0^\pi x^2 \sin kx \, dx =$$

$$= \frac{1}{\pi} \left[\left(\frac{2}{k^3} - \frac{x^2}{k} \right) \cos kx + \frac{2x}{k^2} \sin kx \right]_0^\pi = \frac{1}{\pi} \left[\left(\frac{2}{k^3} - \frac{\pi^2}{k} \right) (-1)^k - \frac{2}{k^3} \right] = \frac{1}{\pi} \left[\left((-1)^k - 1 \right) \frac{2}{k^3} \right] - \frac{\pi}{k} (-1)^k$$

$$= \begin{cases} -\frac{4}{\pi k^3} + \frac{\pi}{k}, & k \text{ odd} \\ -\frac{\pi}{k}, & k \text{ even} \end{cases}$$

Thus, the Fourier series for $f(x)$ is $\frac{1}{6}\pi^2 - 2 \cos x + \left(\frac{\pi^2-4}{\pi}\right) \sin x + \frac{1}{2} \cos 2x - \frac{\pi}{2} \sin 2x - \frac{2}{9} \cos 3x + \left(\frac{9\pi^2-4}{27\pi}\right) \sin 3x + \dots$

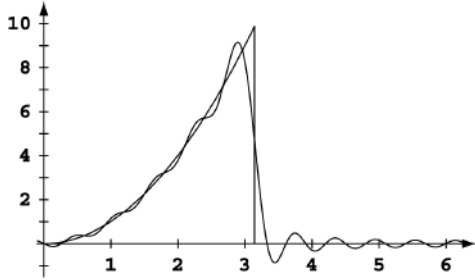

$$5. \quad a_0 = \frac{1}{2\pi} \int_0^{2\pi} e^x dx = \frac{1}{2\pi} (e^{2\pi} - 1), \quad a_k = \frac{1}{\pi} \int_0^{2\pi} e^x \cos kx dx = \frac{1}{\pi} \left[\frac{e^x}{1+k^2} (\cos kx + k \sin kx) \right]_0^{2\pi} = \frac{e^{2\pi} - 1}{\pi(1+k^2)},$$

$$b_k = \frac{1}{\pi} \int_0^{2\pi} e^x \sin kx dx = \frac{1}{\pi} \left[\frac{e^x}{1+k^2} (\sin kx - k \cos kx) \right]_0^{2\pi} = \frac{k(1 - e^{2\pi})}{\pi(1+k^2)}.$$

Thus, the Fourier series for $f(x)$ is $\frac{1}{2\pi} (e^{2\pi} - 1) + \frac{e^{2\pi} - 1}{\pi} \sum_{k=1}^{\infty} \left(\frac{\cos kx}{1+k^2} - \frac{k \sin kx}{1+k^2} \right)$.

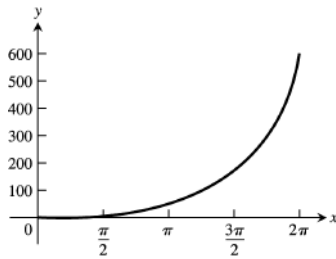

$$6. \quad a_0 = \frac{1}{2\pi} \int_0^{2\pi} f(x) dx = \frac{1}{2\pi} \int_0^{\pi} e^x dx = \frac{e^{\pi} - 1}{2\pi}, \quad a_k = \frac{1}{\pi} \int_0^{2\pi} f(x) \cos kx dx = \frac{1}{\pi} \int_0^{\pi} e^x \cos kx dx = \frac{1}{\pi} \left[\frac{e^x}{1+k^2} (\cos kx + k \sin kx) \right]_0^{\pi}$$

$$= \frac{1}{\pi(1+k^2)} [e^{\pi}(-1)^k - 1] = \begin{cases} \frac{-(1+e^{\pi})}{\pi(1+k^2)}, & k \text{ odd} \\ \frac{e^{\pi}-1}{\pi(1+k^2)}, & k \text{ even} \end{cases} . \quad b_k = \frac{1}{\pi} \int_0^{2\pi} f(x) \sin kx dx = \frac{1}{\pi} \int_0^{\pi} e^x \sin kx dx$$

$$= \frac{1}{\pi} \left[\frac{e^x}{1+k^2} (\sin kx - k \cos kx) \right]_0^{\pi} = \frac{-k}{\pi(1+k^2)} [e^{\pi}(-1)^k - 1] = \begin{cases} \frac{k(1+e^{\pi})}{\pi(1+k^2)}, & k \text{ odd} \\ \frac{1-e^{\pi}}{\pi(1+k^2)}, & k \text{ even} \end{cases} .$$

Thus, the Fourier series for $f(x)$ is

$$\frac{e^{\pi}-1}{2\pi} - \frac{(1+e^{\pi})}{2\pi} \cos x + \frac{(1+e^{\pi})}{2\pi} \sin x + \frac{e^{\pi}-1}{5\pi} \cos 2x + \frac{2(1-e^{\pi})}{5\pi} \sin 2x - \frac{(1+e^{\pi})}{10\pi} \cos 3x + \frac{3(1+e^{\pi})}{10\pi} \sin 3x + \dots$$

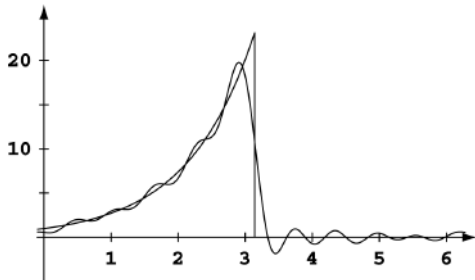

$$7. \quad a_0 = \frac{1}{2\pi} \int_0^{2\pi} f(x) dx = \frac{1}{2\pi} \int_0^{2\pi} \cos x dx = 0, \quad a_k = \frac{1}{\pi} \int_0^{2\pi} \cos x \cos kx dx = \begin{cases} \frac{1}{\pi} \left[\frac{\sin(k-1)x}{2(k-1)} + \frac{\sin(k+1)x}{2(k+1)} \right]_0^{2\pi}, & k \neq 1 \\ \frac{1}{\pi} \left[\frac{1}{2}x + \frac{1}{4} \sin 2x \right]_0^{2\pi}, & k = 1 \end{cases}$$

$$= \begin{cases} 0, & k \neq 1 \\ \frac{1}{2}, & k = 1 \end{cases}$$

$$b_k = \frac{1}{\pi} \int_0^{2\pi} \cos x \sin kx \, dx = \begin{cases} -\frac{1}{\pi} \left[\frac{\cos(k-1)x}{2(k-1)} + \frac{\cos(k+1)x}{2(k+1)} \right]_0^\pi, & k \neq 1 \\ -\frac{1}{4\pi} \cos 2x \Big|_0^\pi, & k = 1 \end{cases} = \begin{cases} 0, & k \text{ odd} \\ \frac{2k}{\pi(k^2-1)}, & k \text{ even} \end{cases}$$

Thus, the Fourier series for $f(x)$ is $\frac{1}{2}\cos x + \sum_{k \text{ even}} \frac{2k}{\pi(k^2-1)} \sin kx$.

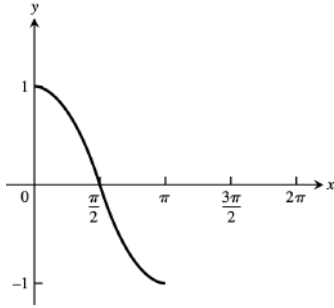

$$8. \quad a_0 = \frac{1}{2\pi} \int_0^{2\pi} f(x) \, dx = \frac{1}{2\pi} \left[\int_0^\pi 2 \, dx + \int_\pi^{2\pi} -x \, dx \right] = 1 - \frac{3}{4}\pi, \quad a_k = \frac{1}{\pi} \int_0^{2\pi} f(x) \cos kx \, dx$$

$$= \frac{1}{\pi} \left[\int_0^\pi 2 \cos kx \, dx + \int_\pi^{2\pi} -x \cos kx \, dx \right] = -\frac{1}{\pi} \left[\frac{\cos kx}{k^2} + \frac{x \sin kx}{k} \right]_0^{2\pi} = \frac{-1 + (-1)^k}{\pi k^2} = \begin{cases} -\frac{2}{\pi k^2}, & k \text{ odd} \\ 0, & k \text{ even} \end{cases}$$

$$b_k = \frac{1}{\pi} \int_0^{2\pi} f(x) \sin kx \, dx = \frac{1}{\pi} \left[\int_0^\pi 2 \sin kx \, dx + \int_\pi^{2\pi} -x \sin kx \, dx \right] = \frac{1}{\pi} \left[-\frac{2}{k} \cos kx \Big|_0^\pi + \left(\frac{x \cos kx}{k} - \frac{\sin kx}{k^2} \right) \Big|_\pi^{2\pi} \right]$$

$$= \begin{cases} \frac{1}{k} \left(\frac{4}{\pi} + 3 \right), & k \text{ odd} \\ \frac{1}{k}, & k \text{ even} \end{cases}$$

Thus, the Fourier series for $f(x)$ is $1 - \frac{3}{4}\pi - \frac{2}{\pi} \cos x + \left(\frac{4}{\pi} + 3 \right) \sin x + \frac{1}{2} \sin 2x - \frac{2}{9\pi} \cos 3x + \frac{1}{3} \left(\frac{4}{\pi} + 3 \right) \sin 3x + \dots$

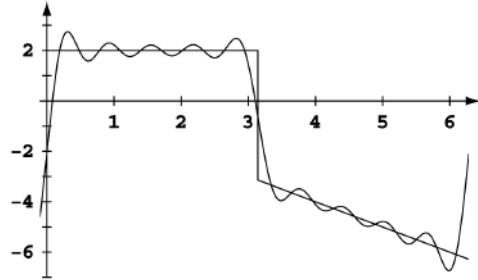

$$9. \quad \int_0^{2\pi} \cos px \, dx = \frac{1}{p} \sin px \Big|_0^{2\pi} = 0 \text{ if } p \neq 0.$$

$$10. \quad \int_0^{2\pi} \sin px \, dx = -\frac{1}{p} \cos px \Big|_0^{2\pi} = -\frac{1}{p} [1 - 1] = 0 \text{ if } p \neq 0.$$

$$11. \quad \int_0^{2\pi} \cos px \cos qx \, dx = \int_0^{2\pi} \frac{1}{2} [\cos(p+q)x + \cos(p-q)x] \, dx = \frac{1}{2} \left[\frac{1}{p+q} \sin(p+q)x + \frac{1}{p-q} \sin(p-q)x \right]_0^{2\pi} = 0 \text{ if } p \neq q.$$

$$\text{If } p = q \text{ then } \int_0^{2\pi} \cos px \cos qx \, dx = \int_0^{2\pi} \cos^2 px \, dx = \int_0^{2\pi} \frac{1}{2} (1 + \cos 2px) \, dx = \frac{1}{2} \left(x + \frac{1}{2p} \sin 2px \right) \Big|_0^{2\pi} = \pi.$$

$$12. \quad \int_0^{2\pi} \sin px \sin qx \, dx = \int_0^{2\pi} \frac{1}{2} [\cos(p-q)x - \cos(p+q)x] \, dx = \frac{1}{2} \left[\frac{1}{p-q} \sin(p-q)x - \frac{1}{p+q} \sin(p+q)x \right]_0^{2\pi} = 0 \text{ if } p \neq q.$$

$$\text{If } p = q \text{ then } \int_0^{2\pi} \sin px \sin qx \, dx = \int_0^{2\pi} \sin^2 px \, dx = \int_0^{2\pi} \frac{1}{2} (1 - \cos 2px) \, dx = \frac{1}{2} \left(x - \frac{1}{2p} \sin 2px \right) \Big|_0^{2\pi} = \pi.$$

$$\begin{aligned}
 13. \int_0^{2\pi} \sin px \cos qx \, dx &= \int_0^{2\pi} \frac{1}{2} [\sin(p+q)x + \sin(p-q)x] \, dx = -\frac{1}{2} \left[\frac{1}{p+q} \cos(p+q)x + \frac{1}{p-q} \cos(p-q)x \right]_0^{2\pi} \\
 &= -\frac{1}{2} \left[(1-1) \frac{1}{p+q} + (1-1) \frac{1}{p-q} \right] = 0. \text{ If } p = q \text{ then } \int_0^{2\pi} \sin px \cos qx \, dx = \int_0^{2\pi} \sin px \cos px \, dx = \int_0^{2\pi} \frac{1}{2} \sin 2px \, dx \\
 &= -\frac{1}{4\pi} \cos 2px \Big|_0^{2\pi} = -\frac{1}{4\pi} (1-1) = 0.
 \end{aligned}$$

14. Yes. Note that if f is continuous at c , then the expression $\frac{f(c^+) + f(c^-)}{2} = f(c)$ since $f(c^+) = \lim_{x \rightarrow c^+} f(x) = f(c)$ and $f(c^-) = \lim_{x \rightarrow c^-} f(x) = f(c)$. Now since the sum of two piecewise continuous functions on $[0, 2\pi]$ is also continuous on $[0, 2\pi]$, the function $f + g$ satisfies the hypothesis of Theorem 24, and so its Fourier series converges to $\frac{(f+g)(c^+) + (f+g)(c^-)}{2}$ for $0 < c < 2\pi$. Let $s_f(x)$ denote the Fourier series for $f(x)$. Then for any c in the interval $(0, 2\pi)$

$$\begin{aligned}
 s_{f+g}(c) &= \frac{(f+g)(c^+) + (f+g)(c^-)}{2} = \frac{1}{2} \left[\lim_{x \rightarrow c^+} (f+g)(x) + \lim_{x \rightarrow c^-} (f+g)(x) \right] = \frac{1}{2} \left[\lim_{x \rightarrow c^+} f(x) + \lim_{x \rightarrow c^+} g(x) + \lim_{x \rightarrow c^-} f(x) + \lim_{x \rightarrow c^-} g(x) \right] \\
 &= \frac{1}{2} [(f(c^+) + g(c^+)) + (f(c^-) + g(c^-))] = s_f(c) + s_g(c), \text{ since } f \text{ and } g \text{ satisfy the hypothesis of Theorem 24.}
 \end{aligned}$$

15. (a) $f(x)$ is piecewise continuous on $[0, 2\pi]$ and $f'(x) = 1$ for all $x \neq \pi \Rightarrow f'(x)$ is piecewise continuous on $[0, 2\pi]$. Then by Theorem 24, the Fourier series for $f(x)$ converges to $f(x)$ for all $x \neq \pi$ and converges to $\frac{1}{2}(f(\pi^+) + f(\pi^-)) = \frac{1}{2}(-\pi + \pi) = 0$ at $x = \pi$.

(b) The Fourier series for $f(x)$ is $\sum_{k=1}^{\infty} (-1)^{k+1} \frac{2 \sin kx}{k}$. If we differentiate this series term by term we get the series

$$\sum_{k=1}^{\infty} (-1)^{k+1} 2 \cos kx, \text{ which diverges by the } n^{\text{th}} \text{ term test for divergence for any } x \text{ since } \lim_{k \rightarrow \infty} (-1)^{k+1} 2 \cos kx \neq 0.$$

16. Since the Fourier series is discontinuous at $x = \pi$, by Theorem 24, the Fourier series will converge to $\frac{f(\pi^+) + f(\pi^-)}{2}$. Thus, at $x = \pi$ we have $\frac{f(\pi^+) + f(\pi^-)}{2} = \frac{1}{6}\pi^2 - 2 \cos x + \left(\frac{\pi^2 - 4}{\pi}\right) \sin x + \frac{1}{2} \cos 2x - \frac{\pi}{2} \sin 2x - \frac{2}{9} \cos 3x + \left(\frac{9\pi^2 - 4}{27\pi}\right) \sin 3x + \dots$

$$\begin{aligned}
 \Rightarrow \frac{0 + \pi^2}{2} &= \frac{1}{6}\pi^2 - 2 \cos \pi + \left(\frac{\pi^2 - 4}{\pi}\right) \sin \pi + \frac{1}{2} \cos 2\pi - \frac{\pi}{2} \sin 2\pi - \frac{2}{9} \cos 3\pi + \left(\frac{9\pi^2 - 4}{27\pi}\right) \sin 3\pi + \dots \\
 \Rightarrow \frac{0 + \pi^2}{2} &= \frac{1}{6}\pi^2 + 2 + \frac{1}{2} + \frac{2}{9} + \dots = \frac{1}{6}\pi^2 + 2\left(1 + \frac{1}{4} + \frac{1}{9} + \dots\right) = \frac{1}{6}\pi^2 + 2 \sum_{n=1}^{\infty} \frac{1}{n^2} \Rightarrow \frac{\pi^2}{2} = \frac{\pi^2}{6} + 2 \sum_{n=1}^{\infty} \frac{1}{n^2} \\
 \frac{\pi^2}{2} - \frac{\pi^2}{6} &= 2 \sum_{n=1}^{\infty} \frac{1}{n^2} \Rightarrow \frac{\pi^2}{3} = 2 \sum_{n=1}^{\infty} \frac{1}{n^2} \Rightarrow \frac{\pi^2}{6} = \sum_{n=1}^{\infty} \frac{1}{n^2}.
 \end{aligned}$$

CHAPTER 11 PRACTICE EXERCISES

1. converges to 1, since $\lim_{n \rightarrow \infty} a_n = \lim_{n \rightarrow \infty} \left(1 + \frac{(-1)^n}{n}\right) = 1$
2. converges to 0, since $0 \leq a_n \leq \frac{2}{\sqrt{n}}$, $\lim_{n \rightarrow \infty} 0 = 0$, $\lim_{n \rightarrow \infty} \frac{2}{\sqrt{n}} = 0$ using the Sandwich Theorem for Sequences
3. converges to -1 , since $\lim_{n \rightarrow \infty} a_n = \lim_{n \rightarrow \infty} \left(\frac{1-2^n}{2^n}\right) = \lim_{n \rightarrow \infty} \left(\frac{1}{2^n} - 1\right) = -1$
4. converges to 1, since $\lim_{n \rightarrow \infty} a_n = \lim_{n \rightarrow \infty} [1 + (0.9)^n] = 1 + 0 = 1$
5. diverges, since $\left\{\sin \frac{n\pi}{2}\right\} = \{0, 1, 0, -1, 0, 1, \dots\}$
6. converges to 0, since $\{\sin n\pi\} = \{0, 0, 0, \dots\}$
7. converges to 0, since $\lim_{n \rightarrow \infty} a_n = \lim_{n \rightarrow \infty} \frac{\ln n^2}{n} = 2 \lim_{n \rightarrow \infty} \frac{\left(\frac{1}{n}\right)}{1} = 0$

8. converges to 0, since $\lim_{n \rightarrow \infty} a_n = \lim_{n \rightarrow \infty} \frac{\ln(2n+1)}{n} = \lim_{n \rightarrow \infty} \frac{\left(\frac{2}{2n+1}\right)}{1} = 0$
9. converges to 1, since $\lim_{n \rightarrow \infty} a_n = \lim_{n \rightarrow \infty} \left(\frac{n+\ln n}{n}\right) = \lim_{n \rightarrow \infty} \frac{1+\left(\frac{1}{n}\right)}{1} = 1$
10. converges to 0, since $\lim_{n \rightarrow \infty} a_n = \lim_{n \rightarrow \infty} \frac{\ln(2n^3+1)}{n} = \lim_{n \rightarrow \infty} \frac{\left(\frac{6n^2}{2n^3+1}\right)}{1} = \lim_{n \rightarrow \infty} \frac{12n}{6n^2} = \lim_{n \rightarrow \infty} \frac{2}{n} = 0$
11. converges to e^{-5} , since $\lim_{n \rightarrow \infty} a_n = \lim_{n \rightarrow \infty} \left(\frac{n-5}{n}\right)^n = \lim_{n \rightarrow \infty} \left(1 + \frac{(-5)}{n}\right)^n = e^{-5}$ by Theorem 5
12. converges to $\frac{1}{e}$, since $\lim_{n \rightarrow \infty} a_n = \lim_{n \rightarrow \infty} \left(1 + \frac{1}{n}\right)^{-n} = \lim_{n \rightarrow \infty} \frac{1}{\left(1 + \frac{1}{n}\right)^n} = \frac{1}{e}$ by Theorem 5
13. converges to 3, since $\lim_{n \rightarrow \infty} a_n = \lim_{n \rightarrow \infty} \left(\frac{3n}{n}\right)^{1/n} = \lim_{n \rightarrow \infty} \frac{3}{n^{1/n}} = \frac{3}{1} = 3$ by Theorem 5
14. converges to 1, since $\lim_{n \rightarrow \infty} a_n = \lim_{n \rightarrow \infty} \left(\frac{3}{n}\right)^{1/n} = \lim_{n \rightarrow \infty} \frac{3^{1/n}}{n^{1/n}} = \frac{1}{1} = 1$ by Theorem 5
15. converges to $\ln 2$, since $\lim_{n \rightarrow \infty} a_n = \lim_{n \rightarrow \infty} n(2^{1/n} - 1) = \lim_{n \rightarrow \infty} \frac{2^{1/n} - 1}{\left(\frac{1}{n}\right)} = \lim_{n \rightarrow \infty} \frac{\left[\frac{(-2^{1/n} \ln 2)}{n^2}\right]}{\left(\frac{-1}{n^2}\right)} = \lim_{n \rightarrow \infty} 2^{1/n} \ln 2 = 2^0 \cdot \ln 2 = \ln 2$
16. converges to 1, since $\lim_{n \rightarrow \infty} a_n = \lim_{n \rightarrow \infty} \sqrt[n]{2n+1} = \lim_{n \rightarrow \infty} \exp\left(\frac{\ln(2n+1)}{n}\right) = \lim_{n \rightarrow \infty} \exp\left(\frac{2}{1}\right) = e^0 = 1$
17. diverges, since $\lim_{n \rightarrow \infty} a_n = \lim_{n \rightarrow \infty} \frac{(n+1)!}{n!} = \lim_{n \rightarrow \infty} (n+1) = \infty$
18. converges to 0, since $\lim_{n \rightarrow \infty} a_n = \lim_{n \rightarrow \infty} \frac{(-4)^n}{n!} = 0$ by Theorem 5
19. $\frac{1}{(2n-3)(2n-1)} = \frac{\left(\frac{1}{2}\right)}{2n-3} - \frac{\left(\frac{1}{2}\right)}{2n-1} \Rightarrow s_n = \left[\frac{\left(\frac{1}{2}\right)}{3} - \frac{\left(\frac{1}{2}\right)}{5}\right] + \left[\frac{\left(\frac{1}{2}\right)}{5} - \frac{\left(\frac{1}{2}\right)}{7}\right] + \dots + \left[\frac{\left(\frac{1}{2}\right)}{2n-3} - \frac{\left(\frac{1}{2}\right)}{2n-1}\right] = \frac{\left(\frac{1}{2}\right)}{3} - \frac{\left(\frac{1}{2}\right)}{2n-1}$
 $\Rightarrow \lim_{n \rightarrow \infty} s_n = \lim_{n \rightarrow \infty} \left[\frac{1}{6} - \frac{\left(\frac{1}{2}\right)}{2n-1}\right] = \frac{1}{6}$
20. $\frac{-2}{n(n+1)} = \frac{-2}{n} + \frac{2}{n+1} \Rightarrow s_n = \left(\frac{-2}{2} + \frac{2}{3}\right) + \left(\frac{-2}{3} + \frac{2}{4}\right) + \dots + \left(\frac{-2}{n} + \frac{2}{n+1}\right) = -\frac{2}{2} + \frac{2}{n+1} \Rightarrow \lim_{n \rightarrow \infty} s_n = \lim_{n \rightarrow \infty} \left(-1 + \frac{2}{n+1}\right) = -1$
21. $\frac{9}{(3n-1)(3n+2)} = \frac{3}{3n-1} - \frac{3}{3n+2} \Rightarrow s_n = \left(\frac{3}{2} - \frac{3}{5}\right) + \left(\frac{3}{5} - \frac{3}{8}\right) + \left(\frac{3}{8} - \frac{3}{11}\right) + \dots + \left(\frac{3}{3n-1} - \frac{3}{3n+2}\right) = \frac{3}{2} - \frac{3}{3n+2} \Rightarrow \lim_{n \rightarrow \infty} s_n = \lim_{n \rightarrow \infty} \left(\frac{3}{2} - \frac{3}{3n+2}\right) = \frac{3}{2}$
22. $\frac{-8}{(4n-3)(4n+1)} = \frac{-2}{4n-3} + \frac{2}{4n+1} \Rightarrow s_n = \left(\frac{-2}{9} + \frac{2}{13}\right) + \left(\frac{-2}{13} + \frac{2}{17}\right) + \left(\frac{-2}{17} + \frac{2}{21}\right) + \dots + \left(\frac{-2}{4n-3} + \frac{2}{4n+1}\right) = -\frac{2}{9} + \frac{2}{4n+1} \Rightarrow \lim_{n \rightarrow \infty} s_n = \lim_{n \rightarrow \infty} \left(-\frac{2}{9} + \frac{2}{4n+1}\right) = -\frac{2}{9}$
23. $\sum_{n=0}^{\infty} e^{-n} = \sum_{n=0}^{\infty} \frac{1}{e^n}$, a convergent geometric series with $r = \frac{1}{e}$ and $a = 1 \Rightarrow$ the sum is $\frac{1}{1 - \left(\frac{1}{e}\right)} = \frac{e}{e-1}$

24. $\sum_{n=1}^{\infty} (-1)^n \frac{3}{4^n} = \sum_{n=0}^{\infty} \left(-\frac{3}{4}\right) \left(\frac{-1}{4}\right)^n$ a convergent geometric series with $r = -\frac{1}{4}$ and $a = \frac{-3}{4} \Rightarrow$ the sum is $\frac{(-\frac{3}{4})}{1 - (-\frac{1}{4})} = -\frac{3}{5}$
25. diverges, a p-series with $p = \frac{1}{2}$
26. $\sum_{n=1}^{\infty} \frac{-5}{n} = -5 \sum_{n=1}^{\infty} \frac{1}{n}$, diverges since it is a nonzero multiple of the divergent harmonic series
27. Since $f(x) = \frac{1}{x^{1/2}} \Rightarrow f'(x) = -\frac{1}{2x^{3/2}} < 0 \Rightarrow f(x)$ is decreasing $\Rightarrow a_{n+1} < a_n$, and $\lim_{n \rightarrow \infty} a_n = \lim_{n \rightarrow \infty} \frac{1}{\sqrt{n}} = 0$, the series $\sum_{n=1}^{\infty} \frac{(-1)^n}{\sqrt{n}}$ converges by the Alternating Series Test. Since $\sum_{n=1}^{\infty} \frac{1}{\sqrt{n}}$ diverges, the given series converges conditionally.
28. converges absolutely by the Direct Comparison Test since $\frac{1}{2n^3} < \frac{1}{n^3}$ for $n \geq 1$, which is the n th term of a convergent p-series
29. The given series does not converge absolutely by the Direct Comparison Test since $\frac{1}{\ln(n+1)} > \frac{1}{n+1}$, which is the n th term of a divergent series. Since $f(x) = \frac{1}{\ln(x+1)} \Rightarrow f'(x) = -\frac{1}{(\ln(x+1))^2(x+1)} < 0 \Rightarrow f(x)$ is decreasing $\Rightarrow a_{n+1} < a_n$, and $\lim_{n \rightarrow \infty} a_n = \lim_{n \rightarrow \infty} \frac{1}{\ln(n+1)} = 0$, the given series converges conditionally by the Alternating Series Test.
30. $\int_2^{\infty} \frac{1}{x(\ln x)^2} dx = \lim_{b \rightarrow \infty} \int_2^b \frac{1}{x(\ln x)^2} dx = \lim_{b \rightarrow \infty} [-(\ln x)^{-1}]_2^b = -\lim_{b \rightarrow \infty} \left(\frac{1}{\ln b} - \frac{1}{\ln 2}\right) = \frac{1}{\ln 2} \Rightarrow$ the series converges absolutely by the Integral Test
31. converges absolutely by the Direct Comparison Test since $\frac{\ln n}{n^3} < \frac{n}{n^3} = \frac{1}{n^2}$, the n th term of a convergent p-series
32. diverges by the Direct Comparison Test for $e^n > n \Rightarrow \ln(e^n) > \ln n \Rightarrow n^n > \ln n \Rightarrow \ln n^n > \ln(\ln n) \Rightarrow n \ln n > \ln(\ln n) \Rightarrow \frac{\ln n}{\ln(\ln n)} > \frac{1}{n}$, the n th term of the divergent harmonic series
33. $\lim_{n \rightarrow \infty} \frac{\left(\frac{1}{n\sqrt{n^2+1}}\right)}{\left(\frac{1}{n^2}\right)} = \sqrt{\lim_{n \rightarrow \infty} \frac{n^2}{n^2+1}} = \sqrt{1} = 1 \Rightarrow$ converges absolutely by the Limit Comparison Test
34. Since $f(x) = \frac{3x^2}{x^3+1} \Rightarrow f'(x) = \frac{3x(2-x^3)}{(x^3+1)^2} < 0$ when $x \geq 2 \Rightarrow a_{n+1} < a_n$ for $n \geq 2$ and $\lim_{n \rightarrow \infty} \frac{3n^2}{n^3+1} = 0$, the series converges by the Alternating Series Test. The series does not converge absolutely: By the Limit Comparison Test, $\lim_{n \rightarrow \infty} \frac{\left(\frac{3n^2}{n^3+1}\right)}{\left(\frac{1}{n}\right)} = \lim_{n \rightarrow \infty} \frac{3n^3}{n^3+1} = 3$. Therefore the convergence is conditional.
35. converges absolutely by the Ratio Test since $\lim_{n \rightarrow \infty} \left[\frac{n+2}{(n+1)!} \cdot \frac{n!}{n+1} \right] = \lim_{n \rightarrow \infty} \frac{n+2}{(n+1)^2} = 0 < 1$
36. diverges since $\lim_{n \rightarrow \infty} a_n = \lim_{n \rightarrow \infty} \frac{(-1)^n(n^2+1)}{2n^2+n-1}$ does not exist
37. converges absolutely by the Ratio Test since $\lim_{n \rightarrow \infty} \left[\frac{3^{n+1}}{(n+1)!} \cdot \frac{n!}{3^n} \right] = \lim_{n \rightarrow \infty} \frac{3}{n+1} = 0 < 1$

38. converges absolutely by the Root Test since $\lim_{n \rightarrow \infty} \sqrt[n]{a_n} = \lim_{n \rightarrow \infty} \sqrt[n]{\frac{2^n 3^n}{n^n}} = \lim_{n \rightarrow \infty} \frac{6}{n} = 0 < 1$

39. converges absolutely by the Limit Comparison Test since $\lim_{n \rightarrow \infty} \frac{\left(\frac{1}{n^{3/2}}\right)}{\left(\frac{1}{\sqrt{n(n+1)(n+2)}}\right)} = \sqrt{\lim_{n \rightarrow \infty} \frac{n(n+1)(n+2)}{n^3}} = 1$

40. converges absolutely by the Limit Comparison Test since $\lim_{n \rightarrow \infty} \frac{\left(\frac{1}{n^2}\right)}{\left(\frac{1}{n\sqrt{n^2-1}}\right)} = \sqrt{\lim_{n \rightarrow \infty} \frac{n^2(n^2-1)}{n^4}} = 1$

41. $\lim_{n \rightarrow \infty} \left| \frac{u_{n+1}}{u_n} \right| < 1 \Rightarrow \lim_{n \rightarrow \infty} \left| \frac{(x+4)^{n+1}}{(n+1)3^{n+1}} \cdot \frac{n3^n}{(x+4)^n} \right| < 1 \Rightarrow \frac{|x+4|}{3} \lim_{n \rightarrow \infty} \left(\frac{n}{n+1} \right) < 1 \Rightarrow \frac{|x+4|}{3} < 1$
 $\Rightarrow |x+4| < 3 \Rightarrow -3 < x+4 < 3 \Rightarrow -7 < x < -1$; at $x = -7$ we have $\sum_{n=1}^{\infty} \frac{(-1)^n 3^n}{n3^n} = \sum_{n=1}^{\infty} \frac{(-1)^n}{n}$, the alternating harmonic series, which converges conditionally; at $x = -1$ we have $\sum_{n=1}^{\infty} \frac{3^n}{n3^n} = \sum_{n=1}^{\infty} \frac{1}{n}$, the divergent harmonic series

(a) the radius is 3; the interval of convergence is $-7 \leq x < -1$

(b) the interval of absolute convergence is $-7 < x < -1$

(c) the series converges conditionally at $x = -7$

42. $\lim_{n \rightarrow \infty} \left| \frac{u_{n+1}}{u_n} \right| < 1 \Rightarrow \lim_{n \rightarrow \infty} \left| \frac{(x-1)^{2n}}{(2n+1)!} \cdot \frac{(2n-1)!}{(x-1)^{2n-2}} \right| < 1 \Rightarrow (x-1)^2 \lim_{n \rightarrow \infty} \frac{1}{(2n)(2n+1)} = 0 < 1$, which holds for all x

(a) the radius is ∞ ; the series converges for all x

(b) the series converges absolutely for all x

(c) there are no values for which the series converges conditionally

43. $\lim_{n \rightarrow \infty} \left| \frac{u_{n+1}}{u_n} \right| < 1 \Rightarrow \lim_{n \rightarrow \infty} \left| \frac{(3x-1)^{n+1}}{(2n+1)^2} \cdot \frac{n^2}{(3x-1)^n} \right| < 1 \Rightarrow |3x-1| \lim_{n \rightarrow \infty} \frac{n^2}{(n+1)^2} < 1 \Rightarrow |3x-1| < 1$
 $\Rightarrow -1 < 3x-1 < 1 \Rightarrow 0 < 3x < 2 \Rightarrow 0 < x < \frac{2}{3}$; at $x = 0$ we have $\sum_{n=1}^{\infty} \frac{(-1)^{n-1}(-1)^n}{n^2} = \sum_{n=1}^{\infty} \frac{(-1)^{2n-1}}{n^2}$
 $= -\sum_{n=1}^{\infty} \frac{1}{n^2}$, a nonzero constant multiple of a convergent p -series, which is absolutely convergent; at $x = \frac{2}{3}$ we

have $\sum_{n=1}^{\infty} \frac{(-1)^{n-1}(1)^n}{n^2} = \sum_{n=1}^{\infty} \frac{(-1)^{n-1}}{n^2}$, which converges absolutely

(a) the radius is $\frac{1}{3}$; the interval of convergence is $0 \leq x \leq \frac{2}{3}$

(b) the interval of absolute convergence is $0 \leq x \leq \frac{2}{3}$

(c) there are no values for which the series converges conditionally

44. $\lim_{n \rightarrow \infty} \left| \frac{u_{n+1}}{u_n} \right| < 1 \Rightarrow \lim_{n \rightarrow \infty} \left| \frac{n+2}{2n+3} \cdot \frac{(2x+1)^{n+1}}{2^{n+1}} \cdot \frac{2n+1}{n+1} \cdot \frac{2^n}{(2x+1)^n} \right| < 1 \Rightarrow \frac{|2x+1|}{2} \lim_{n \rightarrow \infty} \left| \frac{n+2}{2n+3} \cdot \frac{2n+1}{n+1} \right| < 1$
 $\Rightarrow \frac{|2x+1|}{2} (1) < 1 \Rightarrow |2x+1| < 2 \Rightarrow -2 < 2x+1 < 2 \Rightarrow -3 < 2x < 1 \Rightarrow -\frac{3}{2} < x < \frac{1}{2}$; at $x = -\frac{3}{2}$ we have
 $\sum_{n=1}^{\infty} \frac{n+1}{2n+1} \cdot \frac{(-2)^n}{2^n} = \sum_{n=1}^{\infty} \frac{(-1)^n(n+1)}{2n+1}$ which diverges by the n th-Term Test for Divergence since
 $\lim_{n \rightarrow \infty} \left(\frac{n+1}{2n+1} \right) = \frac{1}{2} \neq 0$; at $x = \frac{1}{2}$ we have $\sum_{n=1}^{\infty} \frac{n+1}{2n+1} \cdot \frac{2^n}{2^n} = \sum_{n=1}^{\infty} \frac{n+1}{2n+1}$, which diverges by the n th-

Term Test

(a) the radius is 1; the interval of convergence is $-\frac{3}{2} < x < \frac{1}{2}$

(b) the interval of absolute convergence is $-\frac{3}{2} < x < \frac{1}{2}$

(c) there are no values for which the series converges conditionally

$$45. \lim_{n \rightarrow \infty} \left| \frac{u_{n+1}}{u_n} \right| < 1 \Rightarrow \lim_{n \rightarrow \infty} \left| \frac{x^{n+1}}{(n+1)^{n+1}} \cdot \frac{n^n}{x^n} \right| < 1 \Rightarrow |x| \lim_{n \rightarrow \infty} \left| \left(\frac{n}{n+1} \right)^n \left(\frac{1}{n+1} \right) \right| < 1 \Rightarrow \frac{|x|}{e} \lim_{n \rightarrow \infty} \left(\frac{1}{n+1} \right) < 1$$

$$\Rightarrow \frac{|x|}{e} \cdot 0 < 1, \text{ which holds for all } x$$

- (a) the radius is ∞ ; the series converges for all x
 (b) the series converges absolutely for all x
 (c) there are no values for which the series converges conditionally

$$46. \lim_{n \rightarrow \infty} \left| \frac{u_{n+1}}{u_n} \right| < 1 \Rightarrow \lim_{n \rightarrow \infty} \left| \frac{x^{n+1}}{\sqrt{n+1}} \cdot \frac{\sqrt{n}}{x^n} \right| < 1 \Rightarrow |x| \lim_{n \rightarrow \infty} \sqrt{\frac{n}{n+1}} < 1 \Rightarrow |x| < 1; \text{ when } x = -1 \text{ we have}$$

$$\sum_{n=1}^{\infty} \frac{(-1)^n}{\sqrt{n}}, \text{ which converges by the Alternating Series Test; when } x = 1 \text{ we have } \sum_{n=1}^{\infty} \frac{1}{\sqrt{n}}, \text{ a divergent}$$

p-series

- (a) the radius is 1; the interval of convergence is $-1 \leq x < 1$
 (b) the interval of absolute convergence is $-1 < x < 1$
 (c) the series converges conditionally at $x = -1$

$$47. \lim_{n \rightarrow \infty} \left| \frac{u_{n+1}}{u_n} \right| < 1 \Rightarrow \lim_{n \rightarrow \infty} \left| \frac{(n+2)x^{2n+3}}{3^{n+1}} \cdot \frac{3^n}{(n+1)x^{2n+1}} \right| < 1 \Rightarrow \frac{x^2}{3} \lim_{n \rightarrow \infty} \left(\frac{n+2}{n+1} \right) < 1 \Rightarrow -\sqrt{3} < x < \sqrt{3};$$

the series $\sum_{n=1}^{\infty} -\frac{n+1}{\sqrt{3}}$ and $\sum_{n=1}^{\infty} \frac{n+1}{\sqrt{3}}$, obtained with $x = \pm\sqrt{3}$, both diverge

- (a) the radius is $\sqrt{3}$; the interval of convergence is $-\sqrt{3} < x < \sqrt{3}$
 (b) the interval of absolute convergence is $-\sqrt{3} < x < \sqrt{3}$
 (c) there are no values for which the series converges conditionally

$$48. \lim_{n \rightarrow \infty} \left| \frac{u_{n+1}}{u_n} \right| < 1 \Rightarrow \lim_{n \rightarrow \infty} \left| \frac{(x-1)x^{2n+3}}{2n+3} \cdot \frac{2n+1}{(x-1)^{2n+1}} \right| < 1 \Rightarrow (x-1)^2 \lim_{n \rightarrow \infty} \left(\frac{2n+1}{2n+3} \right) < 1 \Rightarrow (x-1)^2(1) < 1$$

$$\Rightarrow (x-1)^2 < 1 \Rightarrow |x-1| < 1 \Rightarrow -1 < x-1 < 1 \Rightarrow 0 < x < 2; \text{ at } x = 0 \text{ we have } \sum_{n=1}^{\infty} \frac{(-1)^n (-1)^{2n+1}}{2n+1}$$

$$= \sum_{n=1}^{\infty} \frac{(-1)^{3n+1}}{2n+1} = \sum_{n=1}^{\infty} \frac{(-1)^{n-1}}{2n+1} \text{ which converges conditionally by the Alternating Series Test and the fact}$$

$$\text{that } \sum_{n=1}^{\infty} \frac{1}{2n+1} \text{ diverges; at } x = 2 \text{ we have } \sum_{n=1}^{\infty} \frac{(-1)^n (1)^{2n+1}}{2n+1} = \sum_{n=1}^{\infty} \frac{(-1)^n}{2n+1}, \text{ which also converges}$$

conditionally

- (a) the radius is 1; the interval of convergence is $0 \leq x \leq 2$
 (b) the interval of absolute convergence is $0 < x < 2$
 (c) the series converges conditionally at $x = 0$ and $x = 2$

$$49. \lim_{n \rightarrow \infty} \left| \frac{u_{n+1}}{u_n} \right| < 1 \Rightarrow \lim_{n \rightarrow \infty} \left| \frac{\operatorname{csch}(n+1)x^{n+1}}{\operatorname{csch}(n)x^n} \right| < 1 \Rightarrow |x| \lim_{n \rightarrow \infty} \left| \frac{\left(\frac{2}{e^{n+1} - e^{-n-1}} \right)}{\left(\frac{2}{e^n - e^{-n}} \right)} \right| < 1$$

$$\Rightarrow |x| \lim_{n \rightarrow \infty} \left| \frac{e^{-1} - e^{-2n-1}}{1 - e^{-2n-2}} \right| < 1 \Rightarrow \frac{|x|}{e} < 1 \Rightarrow -e < x < e; \text{ the series } \sum_{n=1}^{\infty} (\pm e)^n \operatorname{csch} n, \text{ obtained with } x = \pm e,$$

both diverge since $\lim_{n \rightarrow \infty} (\pm e)^n \operatorname{csch} n \neq 0$

- (a) the radius is e ; the interval of convergence is $-e < x < e$
 (b) the interval of absolute convergence is $-e < x < e$
 (c) there are no values for which the series converges conditionally

$$50. \lim_{n \rightarrow \infty} \left| \frac{u_{n+1}}{u_n} \right| < 1 \Rightarrow \lim_{n \rightarrow \infty} \left| \frac{x^{n+1} \coth(n+1)}{x^n \coth(n)} \right| < 1 \Rightarrow |x| \lim_{n \rightarrow \infty} \left| \frac{1 + e^{-2n-2}}{1 - e^{-2n-2}} \cdot \frac{1 - e^{-2n}}{1 + e^{-2n}} \right| < 1 \Rightarrow |x| < 1$$

$$\Rightarrow -1 < x < 1; \text{ the series } \sum_{n=1}^{\infty} (\pm 1)^n \coth n, \text{ obtained with } x = \pm 1, \text{ both diverge since } \lim_{n \rightarrow \infty} (\pm 1)^n \coth n \neq 0$$

- (a) the radius is 1; the interval of convergence is $-1 < x < 1$
 (b) the interval of absolute convergence is $-1 < x < 1$

(c) there are no values for which the series converges conditionally

51. The given series has the form $1 - x + x^2 - x^3 + \dots + (-x)^n + \dots = \frac{1}{1+x}$, where $x = \frac{1}{4}$; the sum is $\frac{1}{1+(\frac{1}{4})} = \frac{4}{5}$ 52. The given series has the form $x - \frac{x^2}{2} + \frac{x^3}{3} - \dots + (-1)^{n-1} \frac{x^n}{n} + \dots = \ln(1+x)$, where $x = \frac{2}{3}$; the sum is $\ln\left(\frac{5}{3}\right) \approx 0.510825624$ 53. The given series has the form $x - \frac{x^3}{3!} + \frac{x^5}{5!} - \dots + (-1)^n \frac{x^{2n+1}}{(2n+1)!} + \dots = \sin x$, where $x = \pi$; the sum is $\sin \pi = 0$ 54. The given series has the form $1 - \frac{x^2}{2!} + \frac{x^4}{4!} - \dots + (-1)^n \frac{x^{2n}}{(2n)!} + \dots = \cos x$, where $x = \frac{\pi}{3}$; the sum is $\cos \frac{\pi}{3} = \frac{1}{2}$ 55. The given series has the form $1 + x + \frac{x^2}{2!} + \frac{x^3}{3!} + \dots + \frac{x^n}{n!} + \dots = e^x$, where $x = \ln 2$; the sum is $e^{\ln(2)} = 2$ 56. The given series has the form $x - \frac{x^3}{3} + \frac{x^5}{5} - \dots + (-1)^n \frac{x^{2n-1}}{(2n-1)} + \dots = \tan^{-1} x$, where $x = \frac{1}{\sqrt{3}}$; the sum is $\tan^{-1}\left(\frac{1}{\sqrt{3}}\right) = \frac{\pi}{6}$ 57. Consider $\frac{1}{1-2x}$ as the sum of a convergent geometric series with $a = 1$ and $r = 2x \Rightarrow \frac{1}{1-2x} = 1 + (2x) + (2x)^2 + (2x)^3 + \dots = \sum_{n=0}^{\infty} (2x)^n = \sum_{n=0}^{\infty} 2^n x^n$ where $|2x| < 1 \Rightarrow |x| < \frac{1}{2}$ 58. Consider $\frac{1}{1+x^3}$ as the sum of a convergent geometric series with $a = 1$ and $r = -x^3 \Rightarrow \frac{1}{1+x^3} = \frac{1}{1-(-x^3)} = 1 + (-x^3) + (-x^3)^2 + (-x^3)^3 + \dots = \sum_{n=0}^{\infty} (-1)^n x^{3n}$ where $| -x^3 | < 1 \Rightarrow |x^3| < 1 \Rightarrow |x| < 1$

59. $\sin x = \sum_{n=0}^{\infty} \frac{(-1)^n x^{2n+1}}{(2n+1)!} \Rightarrow \sin \pi x = \sum_{n=0}^{\infty} \frac{(-1)^n (\pi x)^{2n+1}}{(2n+1)!} = \sum_{n=0}^{\infty} \frac{(-1)^n \pi^{2n+1} x^{2n+1}}{(2n+1)!}$

60. $\sin x = \sum_{n=0}^{\infty} \frac{(-1)^n x^{2n+1}}{(2n+1)!} \Rightarrow \sin \frac{2x}{3} = \sum_{n=0}^{\infty} \frac{(-1)^n \left(\frac{2x}{3}\right)^{2n+1}}{(2n+1)!} = \sum_{n=0}^{\infty} \frac{(-1)^n 2^{2n+1} x^{2n+1}}{3^{2n+1} (2n+1)!}$

61. $\cos x = \sum_{n=0}^{\infty} \frac{(-1)^n x^{2n}}{(2n)!} \Rightarrow \cos(x^{5/2}) = \sum_{n=0}^{\infty} \frac{(-1)^n (x^{5/2})^{2n}}{(2n)!} = \sum_{n=0}^{\infty} \frac{(-1)^n x^{5n}}{(2n)!}$

62. $\cos x = \sum_{n=0}^{\infty} \frac{(-1)^n x^{2n}}{(2n)!} \Rightarrow \cos \sqrt{5x} = \cos((5x)^{1/2}) = \sum_{n=0}^{\infty} \frac{(-1)^n ((5x)^{1/2})^{2n}}{(2n)!} = \sum_{n=0}^{\infty} \frac{(-1)^n 5^n x^n}{(2n)!}$

63. $e^x = \sum_{n=0}^{\infty} \frac{x^n}{n!} \Rightarrow e^{(\pi x/2)} = \sum_{n=0}^{\infty} \frac{(\frac{\pi x}{2})^n}{n!} = \sum_{n=0}^{\infty} \frac{\pi^n x^n}{2^n n!}$

64. $e^x = \sum_{n=0}^{\infty} \frac{x^n}{n!} \Rightarrow e^{-x^2} = \sum_{n=0}^{\infty} \frac{(-x^2)^n}{n!} = \sum_{n=0}^{\infty} \frac{(-1)^n x^{2n}}{n!}$

65. $f(x) = \sqrt{3+x^2} = (3+x^2)^{1/2} \Rightarrow f'(x) = x(3+x^2)^{-1/2} \Rightarrow f''(x) = -x^2(3+x^2)^{-3/2} + (3+x^2)^{-1/2}$
 $\Rightarrow f'''(x) = 3x^3(3+x^2)^{-5/2} - 3x(3+x^2)^{-3/2}$; $f(-1) = 2$, $f'(-1) = -\frac{1}{2}$, $f''(-1) = -\frac{1}{8} + \frac{1}{2} = \frac{3}{8}$,
 $f'''(-1) = -\frac{3}{32} + \frac{3}{8} = \frac{9}{32} \Rightarrow \sqrt{3+x^2} = 2 - \frac{(x+1)}{2 \cdot 1!} + \frac{3(x+1)^2}{2^2 \cdot 2!} + \frac{9(x+1)^3}{2^3 \cdot 3!} + \dots$

66. $f(x) = \frac{1}{1-x} = (1-x)^{-1} \Rightarrow f'(x) = (1-x)^{-2} \Rightarrow f''(x) = 2(1-x)^{-3} \Rightarrow f'''(x) = 6(1-x)^{-4}$; $f(2) = -1, f'(2) = 1,$
 $f''(2) = -2, f'''(2) = 6 \Rightarrow \frac{1}{1-x} = -1 + (x-2) - (x-2)^2 + (x-2)^3 - \dots$

67. $f(x) = \frac{1}{x+1} = (x+1)^{-1} \Rightarrow f'(x) = -(x+1)^{-2} \Rightarrow f''(x) = 2(x+1)^{-3} \Rightarrow f'''(x) = -6(x+1)^{-4}$; $f(3) = \frac{1}{4},$
 $f'(3) = -\frac{1}{4^2}, f''(3) = \frac{2}{4^3}, f'''(3) = -\frac{6}{4^4} \Rightarrow \frac{1}{x+1} = \frac{1}{4} - \frac{1}{4^2}(x-3) + \frac{1}{4^3}(x-3)^2 - \frac{1}{4^4}(x-3)^3 + \dots$

68. $f(x) = \frac{1}{x} = x^{-1} \Rightarrow f'(x) = -x^{-2} \Rightarrow f''(x) = 2x^{-3} \Rightarrow f'''(x) = -6x^{-4}$; $f(a) = \frac{1}{a}, f'(a) = -\frac{1}{a^2}, f''(a) = \frac{2}{a^3},$
 $f'''(a) = -\frac{6}{a^4} \Rightarrow \frac{1}{x} = \frac{1}{a} - \frac{1}{a^2}(x-a) + \frac{1}{a^3}(x-a)^2 - \frac{1}{a^4}(x-a)^3 + \dots$

69. Assume the solution has the form $y = a_0 + a_1x + a_2x^2 + \dots + a_{n-1}x^{n-1} + a_nx^n + \dots$
 $\Rightarrow \frac{dy}{dx} = a_1 + 2a_2x + \dots + na_nx^{n-1} + \dots \Rightarrow \frac{dy}{dx} + y$
 $= (a_1 + a_0) + (2a_2 + a_1)x + (3a_3 + a_2)x^2 + \dots + (na_n + a_{n-1})x^{n-1} + \dots = 0 \Rightarrow a_1 + a_0 = 0, 2a_2 + a_1 = 0,$
 $3a_3 + a_2 = 0$ and in general $na_n + a_{n-1} = 0$. Since $y = -1$ when $x = 0$ we have $a_0 = -1$. Therefore $a_1 = 1,$
 $a_2 = \frac{-a_1}{2 \cdot 1} = -\frac{1}{2}, a_3 = \frac{-a_2}{3} = \frac{1}{3 \cdot 2}, a_4 = \frac{-a_3}{4} = -\frac{1}{4 \cdot 3 \cdot 2}, \dots, a_n = \frac{-a_{n-1}}{n} = \frac{-1}{n} \frac{(-1)^{n-1}}{(n-1)!} = \frac{(-1)^{n+1}}{n!}$
 $\Rightarrow y = -1 + x - \frac{1}{2}x^2 + \frac{1}{3 \cdot 2}x^3 - \dots + \frac{(-1)^{n+1}}{n!}x^n + \dots = -\sum_{n=0}^{\infty} \frac{(-1)^n x^n}{n!} = -e^{-x}$

70. Assume the solution has the form $y = a_0 + a_1x + a_2x^2 + \dots + a_{n-1}x^{n-1} + a_nx^n + \dots$
 $\Rightarrow \frac{dy}{dx} = a_1 + 2a_2x + \dots + na_nx^{n-1} + \dots \Rightarrow \frac{dy}{dx} - y$
 $= (a_1 - a_0) + (2a_2 - a_1)x + (3a_3 - a_2)x^2 + \dots + (na_n - a_{n-1})x^{n-1} + \dots = 0 \Rightarrow a_1 - a_0 = 0, 2a_2 - a_1 = 0,$
 $3a_3 - a_2 = 0$ and in general $na_n - a_{n-1} = 0$. Since $y = -3$ when $x = 0$ we have $a_0 = -3$. Therefore $a_1 = -3,$
 $a_2 = \frac{a_1}{2} = \frac{-3}{2}, a_3 = \frac{a_2}{3} = \frac{-3}{3 \cdot 2}, a_n = \frac{a_{n-1}}{n} = \frac{-3}{n!} \Rightarrow y = -3 - 3x - \frac{3}{2 \cdot 1}x^2 - \frac{3}{3 \cdot 2}x^3 - \dots - \frac{3}{n!}x^n + \dots$
 $= -3 \left(1 + x + \frac{x^2}{2!} + \frac{x^3}{3!} + \dots + \frac{x^n}{n!} + \dots \right) = -3 \sum_{n=0}^{\infty} \frac{x^n}{n!} = -3e^x$

71. Assume the solution has the form $y = a_0 + a_1x + a_2x^2 + \dots + a_{n-1}x^{n-1} + a_nx^n + \dots$
 $\Rightarrow \frac{dy}{dx} = a_1 + 2a_2x + \dots + na_nx^{n-1} + \dots \Rightarrow \frac{dy}{dx} + 2y$
 $= (a_1 + 2a_0) + (2a_2 + 2a_1)x + (3a_3 + 2a_2)x^2 + \dots + (na_n + 2a_{n-1})x^{n-1} + \dots = 0$. Since $y = 3$ when $x = 0$ we
have $a_0 = 3$. Therefore $a_1 = -2a_0 = -2(3) = -3(2), a_2 = -\frac{2}{2}a_1 = -\frac{2}{2}(-2 \cdot 3) = 3 \left(\frac{2^2}{2} \right), a_3 = -\frac{2}{3}a_2$
 $= -\frac{2}{3} \left[3 \left(\frac{2^2}{2} \right) \right] = -3 \left(\frac{2^3}{3 \cdot 2} \right), \dots, a_n = \left(-\frac{2}{n} \right) a_{n-1} = \left(-\frac{2}{n} \right) \left(3 \left(\frac{(-1)^{n-1} 2^{n-1}}{(n-1)!} \right) \right) = 3 \left(\frac{(-1)^n 2^n}{n!} \right)$
 $\Rightarrow y = 3 - 3(2x) + 3 \left(\frac{2^2}{2} \right) x^2 - 3 \left(\frac{2^3}{3 \cdot 2} \right) x^3 + \dots + 3 \frac{(-1)^n 2^n}{n!} x^n + \dots$
 $= 3 \left[1 - (2x) + \frac{(2x)^2}{2!} - \frac{(2x)^3}{3!} + \dots + \frac{(-1)^n (2x)^n}{n!} + \dots \right] = 3 \sum_{n=0}^{\infty} \frac{(-1)^n (2x)^n}{n!} = 3e^{-2x}$

72. Assume the solution has the form $y = a_0 + a_1x + a_2x^2 + \dots + a_{n-1}x^{n-1} + a_nx^n + \dots$
 $\Rightarrow \frac{dy}{dx} = a_1 + 2a_2x + \dots + na_nx^{n-1} + \dots \Rightarrow \frac{dy}{dx} + y$
 $= (a_1 + a_0) + (2a_2 + a_1)x + (3a_3 + a_2)x^2 + \dots + (na_n + a_{n-1})x^{n-1} + \dots = 1 \Rightarrow a_1 + a_0 = 1, 2a_2 + a_1 = 0,$
 $3a_3 + a_2 = 0$ and in general $na_n + a_{n-1} = 0$ for $n > 1$. Since $y = 0$ when $x = 0$ we have $a_0 = 0$. Therefore
 $a_1 = 1 - a_0 = 1, a_2 = \frac{-a_1}{2 \cdot 1} = -\frac{1}{2}, a_3 = \frac{-a_2}{3} = \frac{1}{3 \cdot 2}, a_4 = \frac{-a_3}{4} = -\frac{1}{4 \cdot 3 \cdot 2}, \dots, a_n$
 $= \frac{-a_{n-1}}{n} = \left(\frac{-1}{n} \right) \frac{(-1)^{n-1}}{(n-1)!} = \frac{(-1)^{n+1}}{n!} \Rightarrow y = 0 + x - \frac{1}{2}x^2 + \frac{1}{3 \cdot 2}x^3 - \dots + \frac{(-1)^{n+1}}{n!}x^n + \dots$
 $= -1 \left[1 - x + \frac{1}{2}x^2 - \frac{1}{3 \cdot 2}x^3 + \dots + \frac{(-1)^n}{n!}x^n + \dots \right] + 1 = -\sum_{n=0}^{\infty} \frac{(-1)^n x^n}{n!} + 1 = 1 - e^{-x}$

73. Assume the solution has the form $y = a_0 + a_1x + a_2x^2 + \dots + a_{n-1}x^{n-1} + a_nx^n + \dots$
 $\Rightarrow \frac{dy}{dx} = a_1 + 2a_2x + \dots + na_nx^{n-1} + \dots \Rightarrow \frac{dy}{dx} - y$
 $= (a_1 - a_0) + (2a_2 - a_1)x + (3a_3 - a_2)x^2 + \dots + (na_n - a_{n-1})x^{n-1} + \dots = 3x \Rightarrow a_1 - a_0 = 0, 2a_2 - a_1 = 3,$

$$\begin{aligned}
3a_3 - a_2 &= 0 \text{ and in general } na_n - a_{n-1} = 0 \text{ for } n > 2. \text{ Since } y = -1 \text{ when } x = 0 \text{ we have } a_0 = -1. \text{ Therefore} \\
a_1 &= -1, a_2 = \frac{3+a_1}{2} = \frac{2}{2}, a_3 = \frac{a_2}{3} = \frac{2}{3 \cdot 2}, a_4 = \frac{a_3}{4} = \frac{2}{4 \cdot 3 \cdot 2}, \dots, a_n = \frac{a_{n-1}}{n} = \frac{2}{n!} \\
&\Rightarrow y = -1 - x + \left(\frac{2}{2}\right)x^2 + \frac{2}{3 \cdot 2}x^3 + \frac{2}{4 \cdot 3 \cdot 2}x^4 + \dots + \frac{2}{n!}x^n + \dots \\
&= 2\left(1 + x + \frac{1}{2}x^2 + \frac{1}{3 \cdot 2}x^3 + \frac{1}{4 \cdot 3 \cdot 2}x^4 + \dots + \frac{1}{n!}x^n + \dots\right) - 3 - 3x = 2\sum_{n=0}^{\infty} \frac{x^n}{n!} - 3 - 3x = 2e^x - 3x - 3
\end{aligned}$$

74. Assume the solution has the form $y = a_0 + a_1x + a_2x^2 + \dots + a_{n-1}x^{n-1} + a_nx^n + \dots$

$$\begin{aligned}
&\Rightarrow \frac{dy}{dx} = a_1 + 2a_2x + \dots + na_nx^{n-1} + \dots \Rightarrow \frac{dy}{dx} + y \\
&= (a_1 + a_0) + (2a_2 + a_1)x + (3a_3 + a_2)x^2 + \dots + (na_n + a_{n-1})x^{n-1} + \dots = x \Rightarrow a_1 + a_0 = 0, 2a_2 + a_1 = 1, \\
&3a_3 + a_2 = 0 \text{ and in general } na_n + a_{n-1} = 0 \text{ for } n > 2. \text{ Since } y = 0 \text{ when } x = 0 \text{ we have } a_0 = 0. \text{ Therefore} \\
a_1 &= 0, a_2 = \frac{1-a_1}{2} = \frac{1}{2}, a_3 = \frac{-a_2}{3} = -\frac{1}{3 \cdot 2}, \dots, a_n = \frac{-a_{n-1}}{n} = \frac{(-1)^n}{n!} \\
&\Rightarrow y = 0 - 0x + \frac{1}{2}x^2 - \frac{1}{3 \cdot 2}x^3 + \dots + \frac{(-1)^n}{n!}x^n + \dots = \left(1 - x + \frac{1}{2}x^2 - \frac{1}{3 \cdot 2}x^3 + \dots + \frac{(-1)^n}{n!}x^n + \dots\right) - 1 + x \\
&= \sum_{n=0}^{\infty} \frac{(-1)^n x^n}{n!} - 1 + x = e^{-x} + x - 1
\end{aligned}$$

75. Assume the solution has the form $y = a_0 + a_1x + a_2x^2 + \dots + a_{n-1}x^{n-1} + a_nx^n + \dots$

$$\begin{aligned}
&\Rightarrow \frac{dy}{dx} = a_1 + 2a_2x + \dots + na_nx^{n-1} + \dots \Rightarrow \frac{dy}{dx} - y \\
&= (a_1 - a_0) + (2a_2 - a_1)x + (3a_3 - a_2)x^2 + \dots + (na_n - a_{n-1})x^{n-1} + \dots = x \Rightarrow a_1 - a_0 = 0, 2a_2 - a_1 = 1, \\
&3a_3 - a_2 = 0 \text{ and in general } na_n - a_{n-1} = 0 \text{ for } n > 2. \text{ Since } y = 1 \text{ when } x = 0 \text{ we have } a_0 = 1. \text{ Therefore} \\
a_1 &= 1, a_2 = \frac{1+a_1}{2} = \frac{2}{2}, a_3 = \frac{a_2}{3} = \frac{2}{3 \cdot 2}, a_4 = \frac{a_3}{4} = \frac{2}{4 \cdot 3 \cdot 2}, \dots, a_n = \frac{a_{n-1}}{n} = \frac{2}{n!} \\
&\Rightarrow y = 1 + x + \left(\frac{2}{2}\right)x^2 + \frac{2}{3 \cdot 2}x^3 + \frac{2}{4 \cdot 3 \cdot 2}x^4 + \dots + \frac{2}{n!}x^n + \dots \\
&= 2\left(1 + x + \frac{1}{2}x^2 + \frac{1}{3 \cdot 2}x^3 + \frac{1}{4 \cdot 3 \cdot 2}x^4 + \dots + \frac{1}{n!}x^n + \dots\right) - 1 - x = 2\sum_{n=0}^{\infty} \frac{x^n}{n!} - 1 - x = 2e^x - x - 1
\end{aligned}$$

76. Assume the solution has the form $y = a_0 + a_1x + a_2x^2 + \dots + a_{n-1}x^{n-1} + a_nx^n + \dots$

$$\begin{aligned}
&\Rightarrow \frac{dy}{dx} = a_1 + 2a_2x + \dots + na_nx^{n-1} + \dots \Rightarrow \frac{dy}{dx} - y \\
&= (a_1 - a_0) + (2a_2 - a_1)x + (3a_3 - a_2)x^2 + \dots + (na_n - a_{n-1})x^{n-1} + \dots = -x \Rightarrow a_1 - a_0 = 0, 2a_2 - a_1 = -1, \\
&3a_3 - a_2 = 0 \text{ and in general } na_n - a_{n-1} = 0 \text{ for } n > 2. \text{ Since } y = 2 \text{ when } x = 0 \text{ we have } a_0 = 2. \text{ Therefore} \\
a_1 &= 2, a_2 = \frac{-1+a_1}{2} = \frac{1}{2}, a_3 = \frac{a_2}{3} = \frac{1}{3 \cdot 2}, a_4 = \frac{a_3}{4} = \frac{1}{4 \cdot 3 \cdot 2}, \dots, a_n = \frac{a_{n-1}}{n} = \frac{1}{n!} \\
&\Rightarrow y = 2 + 2x + \frac{1}{2}x^2 + \frac{1}{3 \cdot 2}x^3 + \frac{1}{4 \cdot 3 \cdot 2}x^4 + \dots + \frac{1}{n!}x^n + \dots \\
&= \left(1 + x + \frac{1}{2}x^2 + \frac{1}{3 \cdot 2}x^3 + \frac{1}{4 \cdot 3 \cdot 2}x^4 + \dots + \frac{1}{n!}x^n + \dots\right) + 1 + x = \sum_{n=0}^{\infty} \frac{x^n}{n!} + 1 + x = e^x + x + 1
\end{aligned}$$

77. $\int_0^{1/2} \exp(-x^3) dx = \int_0^{1/2} \left(1 - x^3 + \frac{x^6}{2!} - \frac{x^9}{3!} + \frac{x^{12}}{4!} + \dots\right) dx = \left[x - \frac{x^4}{4} + \frac{x^7}{7 \cdot 2!} - \frac{x^{10}}{10 \cdot 3!} + \frac{x^{13}}{13 \cdot 4!} - \dots\right]_0^{1/2}$

$$\approx \frac{1}{2} - \frac{1}{2^4 \cdot 4} + \frac{1}{2^7 \cdot 7 \cdot 2!} - \frac{1}{2^{10} \cdot 10 \cdot 3!} + \frac{1}{2^{13} \cdot 13 \cdot 4!} - \frac{1}{2^{16} \cdot 16 \cdot 5!} \approx 0.484917143$$

78. $\int_0^1 x \sin(x^3) dx = \int_0^1 x \left(x^3 - \frac{x^9}{3!} + \frac{x^{15}}{5!} - \frac{x^{21}}{7!} + \frac{x^{27}}{9!} + \dots\right) dx = \int_0^1 \left(x^4 - \frac{x^{10}}{3!} + \frac{x^{16}}{5!} - \frac{x^{22}}{7!} + \frac{x^{28}}{9!} - \dots\right) dx$

$$= \left[\frac{x^5}{5} - \frac{x^{11}}{11 \cdot 3!} + \frac{x^{17}}{17 \cdot 5!} - \frac{x^{23}}{23 \cdot 7!} + \frac{x^{29}}{29 \cdot 9!} - \dots\right]_0^1 \approx 0.185330149$$

79. $\int_1^{1/2} \frac{\tan^{-1}x}{x} dx = \int_1^{1/2} \left(1 - \frac{x^2}{3} + \frac{x^4}{5} - \frac{x^6}{7} + \frac{x^8}{9} - \frac{x^{10}}{11} + \dots\right) dx = \left[x - \frac{x^3}{9} + \frac{x^5}{25} - \frac{x^7}{49} + \frac{x^9}{81} - \frac{x^{11}}{121} + \dots\right]_0^{1/2}$

$$\approx \frac{1}{2} - \frac{1}{9 \cdot 2^3} + \frac{1}{5^2 \cdot 2^5} - \frac{1}{7^2 \cdot 2^7} + \frac{1}{9^2 \cdot 2^9} - \frac{1}{11^2 \cdot 2^{11}} + \frac{1}{13^2 \cdot 2^{13}} - \frac{1}{15^2 \cdot 2^{15}} + \frac{1}{17^2 \cdot 2^{17}} - \frac{1}{19^2 \cdot 2^{19}} + \frac{1}{21^2 \cdot 2^{21}}$$

$$\approx 0.4872223583$$

$$80. \int_0^{1/64} \frac{\tan^{-1} x}{\sqrt{x}} dx = \int_0^{1/64} \frac{1}{\sqrt{x}} \left(x - \frac{x^3}{3} + \frac{x^5}{5} - \frac{x^7}{7} + \dots \right) dx = \int_0^{1/64} \left(x^{1/2} - \frac{1}{3} x^{5/2} + \frac{1}{5} x^{9/2} - \frac{1}{7} x^{13/2} + \dots \right) dx$$

$$= \left[\frac{2}{3} x^{3/2} - \frac{2}{21} x^{7/2} + \frac{2}{55} x^{11/2} - \frac{2}{105} x^{15/2} + \dots \right]_0^{1/64} = \left(\frac{2}{3 \cdot 8^3} - \frac{2}{21 \cdot 8^7} + \frac{2}{55 \cdot 8^{11}} - \frac{2}{105 \cdot 8^{15}} + \dots \right) \approx 0.0013020379$$

$$81. \lim_{x \rightarrow 0} \frac{7 \sin x}{e^{2x} - 1} = \lim_{x \rightarrow 0} \frac{7 \left(x - \frac{x^3}{3!} + \frac{x^5}{5!} - \dots \right)}{\left(2x + \frac{2^2 x^2}{2!} + \frac{2^3 x^3}{3!} + \dots \right)} = \lim_{x \rightarrow 0} \frac{7 \left(1 - \frac{x^2}{3!} + \frac{x^4}{5!} - \dots \right)}{\left(2 + \frac{2^2 x}{2!} + \frac{2^3 x^2}{3!} + \dots \right)} = \frac{7}{2}$$

$$82. \lim_{\theta \rightarrow 0} \frac{e^\theta - e^{-\theta} - 2\theta}{\theta - \sin \theta} = \lim_{\theta \rightarrow 0} \frac{\left(1 + \theta + \frac{\theta^2}{2!} + \frac{\theta^3}{3!} + \dots \right) - \left(1 - \theta + \frac{\theta^2}{2!} - \frac{\theta^3}{3!} + \dots \right) - 2\theta}{\theta - \left(\theta - \frac{\theta^3}{3!} + \frac{\theta^5}{5!} - \dots \right)} = \lim_{\theta \rightarrow 0} \frac{2 \left(\frac{\theta^3}{3!} + \frac{\theta^5}{5!} + \dots \right)}{\left(\frac{\theta^3}{3!} - \frac{\theta^5}{5!} + \dots \right)}$$

$$= \lim_{\theta \rightarrow 0} \frac{2 \left(\frac{1}{3!} + \frac{\theta^2}{5!} + \dots \right)}{\left(\frac{1}{3!} - \frac{\theta^2}{5!} + \dots \right)} = 2$$

$$83. \lim_{t \rightarrow 0} \left(\frac{1}{2 - 2 \cos t} - \frac{1}{t^2} \right) = \lim_{t \rightarrow 0} \frac{t^2 - 2 + 2 \cos t}{2t^2(1 - \cos t)} = \lim_{t \rightarrow 0} \frac{t^2 - 2 + 2 \left(1 - \frac{t^2}{2} + \frac{t^4}{4!} - \dots \right)}{2t^2 \left(1 - 1 + \frac{t^2}{2} - \frac{t^4}{4!} + \dots \right)} = \lim_{t \rightarrow 0} \frac{2 \left(\frac{t^4}{4!} - \frac{t^6}{6!} + \dots \right)}{\left(t^4 - \frac{2t^6}{4!} + \dots \right)}$$

$$= \lim_{t \rightarrow 0} \frac{2 \left(\frac{1}{4!} - \frac{t^2}{6!} + \dots \right)}{\left(1 - \frac{2t^2}{4!} + \dots \right)} = \frac{1}{12}$$

$$84. \lim_{h \rightarrow 0} \frac{\left(\frac{\sin h}{h} \right) - \cos h}{h^2} = \lim_{h \rightarrow 0} \frac{\left(1 - \frac{h^2}{3!} + \frac{h^4}{5!} - \dots \right) - \left(1 - \frac{h^2}{2!} + \frac{h^4}{4!} - \dots \right)}{h^2}$$

$$= \lim_{h \rightarrow 0} \frac{\left(\frac{h^2}{2!} - \frac{h^2}{3!} + \frac{h^4}{5!} - \frac{h^4}{4!} + \frac{h^6}{6!} - \frac{h^6}{7!} + \dots \right)}{h^2} = \lim_{h \rightarrow 0} \left(\frac{1}{2!} - \frac{1}{3!} + \frac{h^2}{5!} - \frac{h^2}{4!} + \frac{h^4}{6!} - \frac{h^4}{7!} + \dots \right) = \frac{1}{3}$$

$$85. \lim_{z \rightarrow 0} \frac{1 - \cos^2 z}{\ln(1 - z) + \sin z} = \lim_{z \rightarrow 0} \frac{1 - \left(1 - z^2 + \frac{z^4}{3} - \dots \right)}{\left(-z - \frac{z^2}{2} - \frac{z^3}{3} - \dots \right) + \left(z - \frac{z^3}{3!} + \frac{z^5}{5!} - \dots \right)} = \lim_{z \rightarrow 0} \frac{\left(z^2 - \frac{z^4}{3} + \dots \right)}{\left(-\frac{z^2}{2} - \frac{2z^3}{3} - \frac{z^4}{4} - \dots \right)}$$

$$= \lim_{z \rightarrow 0} \frac{\left(1 - \frac{z^2}{3} + \dots \right)}{\left(-\frac{1}{2} - \frac{2z}{3} - \frac{z^2}{4} - \dots \right)} = -2$$

$$86. \lim_{y \rightarrow 0} \frac{y^2}{\cos y - \cosh y} = \lim_{y \rightarrow 0} \frac{y^2}{\left(1 - \frac{y^2}{2} + \frac{y^4}{4!} - \frac{y^6}{6!} + \dots \right) - \left(1 + \frac{y^2}{2!} + \frac{y^4}{4!} + \frac{y^6}{6!} + \dots \right)} = \lim_{y \rightarrow 0} \frac{y^2}{\left(-\frac{2y^2}{2} - \frac{2y^6}{6!} - \dots \right)}$$

$$= \lim_{y \rightarrow 0} \frac{1}{\left(-1 - \frac{2y^4}{6!} - \dots \right)} = -1$$

$$87. \lim_{x \rightarrow 0} \left(\frac{\sin 3x}{x^3} + \frac{r}{x^2} + s \right) = \lim_{x \rightarrow 0} \left[\frac{\left(3x - \frac{(3x)^3}{6} + \frac{(3x)^5}{120} - \dots \right)}{x^3} + \frac{r}{x^2} + s \right] = \lim_{x \rightarrow 0} \left(\frac{3}{x^2} - \frac{9}{2} + \frac{81x^2}{40} + \dots + \frac{r}{x^2} + s \right) = 0$$

$$\Rightarrow \frac{r}{x^2} + \frac{3}{x^2} = 0 \text{ and } s - \frac{9}{2} = 0 \Rightarrow r = -3 \text{ and } s = \frac{9}{2}$$

$$88. (a) \csc x \approx \frac{1}{x} + \frac{x}{6} \Rightarrow \csc x \approx \frac{6+x^2}{6x} \Rightarrow \sin x \approx \frac{6x}{6+x^2}$$

(b) The approximation $\sin x \approx \frac{6x}{6+x^2}$ is better than $\sin x \approx x$.

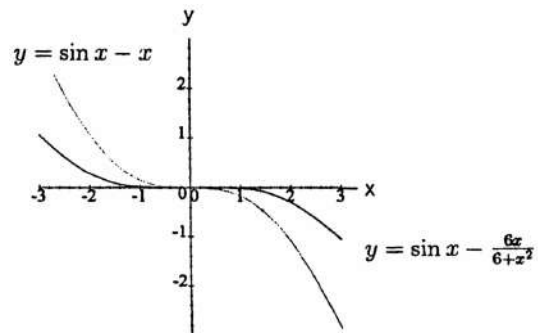

$$89. (a) \sum_{n=1}^{\infty} \left(\sin \frac{1}{2n} - \sin \frac{1}{2n+1} \right) = \left(\sin \frac{1}{2} - \sin \frac{1}{3} \right) + \left(\sin \frac{1}{4} - \sin \frac{1}{5} \right) + \left(\sin \frac{1}{6} - \sin \frac{1}{7} \right) + \dots + \left(\sin \frac{1}{2n} - \sin \frac{1}{2n+1} \right) \\ + \dots = \sum_{n=2}^{\infty} (-1)^n \sin \frac{1}{n}; f(x) = \sin \frac{1}{x} \Rightarrow f'(x) = \frac{-\cos(\frac{1}{x})}{x^2} < 0 \text{ if } x \geq 2 \Rightarrow \sin \frac{1}{n+1} < \sin \frac{1}{n}, \text{ and}$$

$${}_n \lim_{\infty} \sin \frac{1}{n} = 0 \Rightarrow \sum_{n=2}^{\infty} (-1)^n \sin \frac{1}{n} \text{ converges by the Alternating Series Test}$$

$$(b) |\text{error}| < \left| \sin \frac{1}{42} \right| \approx 0.02381 \text{ and the sum is an underestimate because the remainder is positive}$$

$$90. (a) \sum_{n=1}^{\infty} \left(\tan \frac{1}{2n} - \tan \frac{1}{2n+1} \right) = \sum_{n=2}^{\infty} (-1)^n \tan \frac{1}{n} \text{ (see Exercise 89); } f(x) = \tan \frac{1}{x} \Rightarrow f'(x) = \frac{-\sec^2(\frac{1}{x})}{x^2} < 0 \\ \Rightarrow \tan \frac{1}{n+1} < \tan \frac{1}{n}, \text{ and } {}_n \lim_{\infty} \tan \frac{1}{n} = 0 \Rightarrow \sum_{n=2}^{\infty} (-1)^n \tan \frac{1}{n} \text{ converges by the Alternating Series}$$

Test

$$(b) |\text{error}| < \left| \tan \frac{1}{42} \right| \approx 0.02382 \text{ and the sum is an underestimate because the remainder is positive}$$

$$91. {}_n \lim_{\infty} \left| \frac{2 \cdot 5 \cdot 8 \cdots (3n-1)(3n+2)x^{n+1}}{2 \cdot 4 \cdot 6 \cdots (2n)(2n+2)} \cdot \frac{2 \cdot 4 \cdot 6 \cdots (2n)}{2 \cdot 5 \cdot 8 \cdots (3n-1)x^n} \right| < 1 \Rightarrow |x| {}_n \lim_{\infty} \left| \frac{3n+2}{2n+2} \right| < 1 \Rightarrow |x| < \frac{2}{3} \\ \Rightarrow \text{the radius of convergence is } \frac{2}{3}$$

$$92. {}_n \lim_{\infty} \left| \frac{3 \cdot 5 \cdot 7 \cdots (2n+1)(2n+3)(x-1)^{n+1}}{4 \cdot 9 \cdot 14 \cdots (5n-1)(5n+4)} \cdot \frac{4 \cdot 9 \cdot 14 \cdots (5n-1)}{3 \cdot 5 \cdot 7 \cdots (2n+1)x^n} \right| < 1 \Rightarrow |x| {}_n \lim_{\infty} \left| \frac{2n+3}{5n+4} \right| < 1 \Rightarrow |x| < \frac{5}{2} \\ \Rightarrow \text{the radius of convergence is } \frac{5}{2}$$

$$93. \sum_{k=2}^n \ln \left(1 - \frac{1}{k^2} \right) = \sum_{k=2}^n \left[\ln \left(1 + \frac{1}{k} \right) + \ln \left(1 - \frac{1}{k} \right) \right] = \sum_{k=2}^n [\ln(k+1) - \ln k + \ln(k-1) - \ln k] \\ = [\ln 3 - \ln 2 + \ln 1 - \ln 2] + [\ln 4 - \ln 3 + \ln 2 - \ln 3] + [\ln 5 - \ln 4 + \ln 3 - \ln 4] + [\ln 6 - \ln 5 + \ln 4 - \ln 5] \\ + \dots + [\ln(n+1) - \ln n + \ln(n-1) - \ln n] = [\ln 1 - \ln 2] + [\ln(n+1) - \ln n] \quad \text{after cancellation} \\ \Rightarrow \sum_{k=2}^n \ln \left(1 - \frac{1}{k^2} \right) = \ln \left(\frac{n+1}{2n} \right) \Rightarrow \sum_{k=2}^{\infty} \ln \left(1 - \frac{1}{k^2} \right) = {}_n \lim_{\infty} \ln \left(\frac{n+1}{2n} \right) = \ln \frac{1}{2} \text{ is the sum}$$

$$94. \sum_{k=2}^n \frac{1}{k^2-1} = \frac{1}{2} \sum_{k=2}^n \left(\frac{1}{k-1} - \frac{1}{k+1} \right) = \frac{1}{2} \left[\left(\frac{1}{1} - \frac{1}{3} \right) + \left(\frac{1}{2} - \frac{1}{4} \right) + \left(\frac{1}{3} - \frac{1}{5} \right) + \left(\frac{1}{4} - \frac{1}{6} \right) + \dots + \left(\frac{1}{n-2} - \frac{1}{n} \right) \right. \\ \left. + \left(\frac{1}{n-1} - \frac{1}{n+1} \right) \right] = \frac{1}{2} \left(\frac{1}{1} + \frac{1}{2} - \frac{1}{n} - \frac{1}{n+1} \right) = \frac{1}{2} \left(\frac{3}{2} - \frac{1}{n} - \frac{1}{n+1} \right) = \frac{1}{2} \left[\frac{3n(n+1) - 2(n+1) - 2n}{2n(n+1)} \right] = \frac{3n^2 - n - 2}{4n(n+1)} \\ \Rightarrow \sum_{k=2}^{\infty} \frac{1}{k^2-1} = {}_n \lim_{\infty} \frac{1}{2} \left(\frac{3}{2} - \frac{1}{n} - \frac{1}{n+1} \right) = \frac{3}{4}$$

$$95. (a) {}_n \lim_{\infty} \left| \frac{1 \cdot 4 \cdot 7 \cdots (3n-2)(3n+1)x^{3n+3}}{(3n+3)!} \cdot \frac{(3n)!}{1 \cdot 4 \cdot 7 \cdots (3n-2)x^{3n}} \right| < 1 \Rightarrow |x^3| {}_n \lim_{\infty} \frac{(3n+1)}{(3n+1)(3n+2)(3n+3)} \\ = |x^3| \cdot 0 < 1 \Rightarrow \text{the radius of convergence is } \infty$$

$$(b) y = 1 + \sum_{n=1}^{\infty} \frac{1 \cdot 4 \cdot 7 \cdots (3n-2)}{(3n)!} x^{3n} \Rightarrow \frac{dy}{dx} = \sum_{n=1}^{\infty} \frac{1 \cdot 4 \cdot 7 \cdots (3n-2)}{(3n-1)!} x^{3n-1} \\ \Rightarrow \frac{d^2y}{dx^2} = \sum_{n=1}^{\infty} \frac{1 \cdot 4 \cdot 7 \cdots (3n-2)}{(3n-2)!} x^{3n-2} = x + \sum_{n=2}^{\infty} \frac{1 \cdot 4 \cdot 7 \cdots (3n-5)}{(3n-3)!} x^{3n-2} \\ = x \left(1 + \sum_{n=1}^{\infty} \frac{1 \cdot 4 \cdot 7 \cdots (3n-2)}{(3n)!} x^{3n} \right) = xy + 0 \Rightarrow a = 1 \text{ and } b = 0$$

$$96. (a) \frac{x^2}{1+x} = \frac{x^2}{1-(-x)} = x^2 + x^2(-x) + x^2(-x)^2 + x^2(-x)^3 + \dots = x^2 - x^3 + x^4 - x^5 + \dots = \sum_{n=2}^{\infty} (-1)^n x^n \text{ which} \\ \text{converges absolutely for } |x| < 1$$

$$(b) x = 1 \Rightarrow \sum_{n=2}^{\infty} (-1)^n x^n = \sum_{n=2}^{\infty} (-1)^n \text{ which diverges}$$

97. Yes, the series $\sum_{n=1}^{\infty} a_n b_n$ converges as we now show. Since $\sum_{n=1}^{\infty} a_n$ converges it follows that $a_n \rightarrow 0 \Rightarrow a_n < 1$
for $n > \text{some index } N \Rightarrow a_n b_n < b_n$ for $n > N \Rightarrow \sum_{n=1}^{\infty} a_n b_n$ converges by the Direct Comparison Test with $\sum_{n=1}^{\infty} b_n$
98. No, the series $\sum_{n=1}^{\infty} a_n b_n$ might diverge (as it would if a_n and b_n both equaled n) or it might converge (as it would if a_n and b_n both equaled $\frac{1}{n}$).
99. $\sum_{n=1}^{\infty} (x_{n+1} - x_n) = \lim_{n \rightarrow \infty} \sum_{k=1}^n (x_{k+1} - x_k) = \lim_{n \rightarrow \infty} (x_{n+1} - x_1) = \lim_{n \rightarrow \infty} (x_{n+1}) - x_1 \Rightarrow$ both the series and sequence must either converge or diverge.
100. It converges by the Limit Comparison Test since $\lim_{n \rightarrow \infty} \frac{\left(\frac{a_n}{1+a_n}\right)}{a_n} = \lim_{n \rightarrow \infty} \frac{1}{1+a_n} = 1$ because $\sum_{n=1}^{\infty} a_n$ converges and so $a_n \rightarrow 0$.
101. Newton's method gives $x_{n+1} = x_n - \frac{(x_n-1)^{40}}{40(x_n-1)^{39}} = \frac{39}{40}x_n + \frac{1}{40}$, and if the sequence $\{x_n\}$ has the limit L , then $L = \frac{39}{40}L + \frac{1}{40} \Rightarrow L = 1$ and $\{x_n\}$ converges since $\left| \frac{f(x)f''(x)}{[f'(x)]^2} \right| = \frac{39}{40} < 1$
102. $\sum_{n=1}^{\infty} \frac{a_n}{n} = a_1 + \frac{a_2}{2} + \frac{a_3}{3} + \frac{a_4}{4} + \dots \geq a_1 + \left(\frac{1}{2}\right)a_2 + \left(\frac{1}{3} + \frac{1}{4}\right)a_4 + \left(\frac{1}{5} + \frac{1}{6} + \frac{1}{7} + \frac{1}{8}\right)a_8$
 $+ \left(\frac{1}{9} + \frac{1}{10} + \frac{1}{11} + \dots + \frac{1}{16}\right)a_{16} + \dots \geq \frac{1}{2}(a_2 + a_4 + a_8 + a_{16} + \dots)$ which is a divergent series
103. $a_n = \frac{1}{\ln n}$ for $n \geq 2 \Rightarrow a_2 \geq a_3 \geq a_4 \geq \dots$, and $\frac{1}{\ln 2} + \frac{1}{\ln 4} + \frac{1}{\ln 8} + \dots = \frac{1}{\ln 2} + \frac{1}{2 \ln 2} + \frac{1}{3 \ln 2} + \dots$
 $= \frac{1}{\ln 2} \left(1 + \frac{1}{2} + \frac{1}{3} + \dots\right)$ which diverges so that $1 + \sum_{n=2}^{\infty} \frac{1}{n \ln n}$ diverges by the Integral Test.
104. (a) $T = \frac{\left(\frac{1}{2}\right)}{2} \left(0 + 2 \left(\frac{1}{2}\right)^2 e^{1/2} + e\right) = \frac{1}{8} e^{1/2} + \frac{1}{4} e \approx 0.885660616$
(b) $x^2 e^x = x^2 \left(1 + x + \frac{x^2}{2} + \dots\right) = x^2 + x^3 + \frac{x^4}{2} + \dots \Rightarrow \int_0^1 \left(x^2 + x^3 + \frac{x^4}{2}\right) dx = \left[\frac{x^3}{3} + \frac{x^4}{4} + \frac{x^5}{10}\right]_0^1 = \frac{41}{60} = 0.6833\bar{3}$
(c) If the second derivative is positive, the curve is concave upward and the polygonal line segments used in the trapezoidal rule lie above the curve. The trapezoidal approximation is therefore greater than the actual area under the graph.
(d) All terms in the Maclaurin series are positive. If we truncate the series, we are omitting positive terms and hence the estimate is too small.
(e) $\int_0^1 x^2 e^x dx = [x^2 e^x - 2x e^x + 2e^x]_0^1 = e - 2e + 2e - 2 = e - 2 \approx 0.7182818285$
105. $a_0 = \frac{1}{2\pi} \int_0^{2\pi} f(x) dx = \frac{1}{2\pi} \int_{\pi}^{2\pi} 1 dx = \frac{1}{2}$, $a_k = \frac{1}{\pi} \int_0^{2\pi} f(x) \cos kx dx = \frac{1}{\pi} \int_{\pi}^{2\pi} \cos kx dx = 0$,
 $b_k = \frac{1}{\pi} \int_0^{2\pi} f(x) \sin kx dx = \frac{1}{\pi} \int_{\pi}^{2\pi} \sin kx dx = -\frac{\cos kx}{\pi k} \Big|_{\pi}^{2\pi} = -\frac{1}{\pi k} (1 - (-1)^k) = \begin{cases} -\frac{2}{\pi k}, & k \text{ odd} \\ 0, & k \text{ even} \end{cases}$
Thus, the Fourier series of $f(x)$ is $\frac{1}{2} - \sum_{k \text{ odd}} \frac{2}{\pi k} \sin kx$

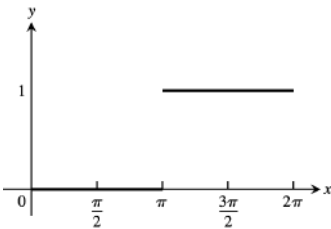

$$106. \quad a_0 = \frac{1}{2\pi} \left[\int_0^\pi x \, dx + \int_\pi^{2\pi} 1 \, dx \right] = \frac{1}{2} + \frac{1}{4}\pi, \quad a_k = \frac{1}{\pi} \left[\int_0^\pi x \cos kx \, dx + \int_\pi^{2\pi} \cos kx \, dx \right] = \frac{1}{\pi} \left[\frac{\cos kx}{k^2} + \frac{x \sin kx}{k} \right]_0^\pi$$

$$= \frac{1}{\pi k^2} \left((-1)^k - 1 \right) = \begin{cases} -\frac{2}{\pi k^2}, & k \text{ odd} \\ 0, & k \text{ even} \end{cases}.$$

$$b_k = \frac{1}{\pi} \left[\int_0^\pi x \sin kx \, dx + \int_\pi^{2\pi} \sin kx \, dx \right] = \frac{1}{\pi} \left[\frac{\sin kx}{k^2} - \frac{x \cos kx}{k} \right]_0^\pi - \frac{\cos kx}{\pi k} \Big|_\pi^{2\pi} = \frac{(-1)^{k+1}}{k} - \frac{1}{\pi k} \left(1 - (-1)^k \right)$$

$$= \begin{cases} \frac{1}{k} \left(1 - \frac{2}{\pi} \right), & k \text{ odd} \\ -\frac{1}{k}, & k \text{ even} \end{cases}.$$

Thus, the Fourier series of $f(x)$ is $\frac{1}{2} + \frac{1}{4}\pi - \frac{2}{\pi} \cos x + \left(1 - \frac{2}{\pi} \right) \sin x - \frac{1}{2} \sin 2x - \frac{2}{9\pi} \cos 3x + \frac{1}{3} \left(1 - \frac{2}{\pi} \right) \sin 3x + \dots$

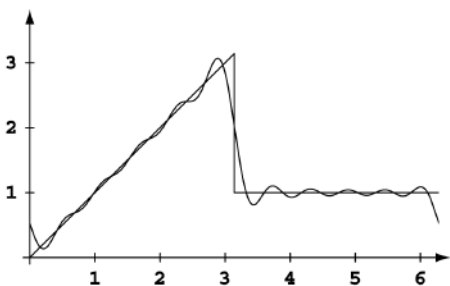

$$107. \quad a_0 = \frac{1}{2\pi} \left[\int_0^\pi (\pi - x) \, dx + \int_\pi^{2\pi} (x - 2\pi) \, dx \right] = \frac{1}{2\pi} \left[\int_0^\pi (\pi - x) \, dx - \int_0^\pi (\pi - u) \, du \right] = 0$$

where we used the substitution $u = x - \pi$ in the second integral. We have $a_k = \frac{1}{\pi} \left[\int_0^\pi (\pi - x) \cos kx \, dx + \int_\pi^{2\pi} (x - 2\pi) \cos kx \, dx \right]$. Using

the substitution $u = x - \pi$ in the second integral gives $\int_\pi^{2\pi} (x - 2\pi) \cos kx \, dx = \int_0^\pi -(\pi - u) \cos(ku + k\pi) \, du$

$$= \begin{cases} \int_0^\pi (\pi - u) \cos ku \, du, & k \text{ odd} \\ \int_0^\pi -(\pi - u) \cos ku \, du, & k \text{ even} \end{cases}.$$

$$\text{Thus, } a_k = \begin{cases} \frac{2}{\pi} \int_0^\pi (\pi - x) \cos kx \, dx, & k \text{ odd} \\ 0, & k \text{ even} \end{cases}.$$

Now, since k is odd, letting $v = \pi - x \Rightarrow \frac{2}{\pi} \int_0^\pi (\pi - x) \cos kx \, dx = -\frac{2}{\pi} \int_0^\pi v \cos kv \, dv = -\frac{2}{\pi} \left(-\frac{2}{k^2} \right) = \frac{4}{\pi k^2}$, k odd. (See

Exercise 106). So, $a_k = \begin{cases} \frac{4}{\pi k^2}, & k \text{ odd} \\ 0, & k \text{ even} \end{cases}$.

$$\text{Using similar techniques we see that } b_k = \begin{cases} \frac{2}{\pi} \int_0^\pi (\pi - u) \sin ku \, du, & k \text{ odd} \\ 0, & k \text{ even} \end{cases} = \begin{cases} \frac{2}{k}, & k \text{ odd} \\ 0, & k \text{ even} \end{cases}.$$

Thus, the Fourier series of $f(x)$ is $\sum_{k \text{ odd}} \left(\frac{4}{\pi k^2} \cos kx + \frac{2}{k} \sin kx \right)$.

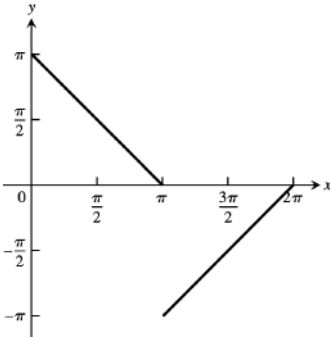

108. $a_0 = \frac{1}{2\pi} \int_0^{2\pi} |\sin x| dx = \frac{1}{\pi} \int_0^\pi \sin x dx = \frac{2}{\pi}$. We have $a_k = \frac{1}{\pi} \int_0^{2\pi} |\sin x| \cos kx dx$
 $= \frac{1}{\pi} \left[\int_0^\pi \sin x \cos kx dx - \int_\pi^{2\pi} \sin x \cos kx dx \right]$. Using techniques similar to those used in Exercise 107, we find
 $a_k = \begin{cases} 0, & k \text{ odd} \\ \frac{2}{\pi} \int_0^\pi \sin x \cos kx dx, & k \text{ even} \end{cases} = \begin{cases} 0, & k \text{ odd} \\ \frac{-4}{(k^2-1)\pi}, & k \text{ even} \end{cases}$
 $b_k = \frac{1}{\pi} \int_0^{2\pi} |\sin x| \sin kx dx = \frac{1}{\pi} \left[\int_0^\pi \sin x \sin kx dx - \int_\pi^{2\pi} \sin x \sin kx dx \right] = \begin{cases} 0, & k \text{ odd} \\ \frac{2}{\pi} \int_0^\pi \sin x \sin kx dx, & k \text{ even} \end{cases} = 0$
 for all k .
 Thus, the Fourier series of $f(x)$ is $\frac{2}{\pi} + \sum_{k \text{ even}} \left(\frac{-4}{(k^2-1)\pi} \cos kx \right)$.

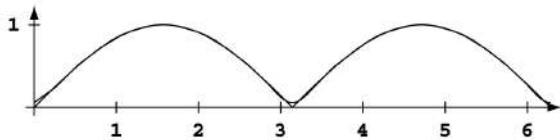

CHAPTER 11 ADDITIONAL AND ADVANCED EXERCISES

- converges since $\frac{1}{(3n-2)^{(2n+1)/2}} < \frac{1}{(3n-2)^{3/2}}$ and $\sum_{n=1}^{\infty} \frac{1}{(3n-2)^{3/2}}$ converges by the Limit Comparison Test:

$$\lim_{n \rightarrow \infty} \frac{\left(\frac{1}{(3n-2)^{3/2}}\right)}{\left(\frac{1}{(3n-2)^{3/2}}\right)} = \lim_{n \rightarrow \infty} (3n-2)^{3/2} = 3^{3/2}$$
- converges by the Integral Test: $\int_1^{\infty} (\tan^{-1} x)^2 \frac{dx}{x^2+1} = \lim_{b \rightarrow \infty} \left[\frac{(\tan^{-1} x)^3}{3} \right]_1^b = \lim_{b \rightarrow \infty} \left[\frac{(\tan^{-1} b)^3}{3} - \frac{\pi^3}{192} \right]$
 $= \left(\frac{\pi^3}{24} - \frac{\pi^3}{192} \right) = \frac{7\pi^3}{192}$
- diverges by the n th-Term Test since $\lim_{n \rightarrow \infty} a_n = \lim_{n \rightarrow \infty} (-1)^n \tanh n = \lim_{b \rightarrow \infty} (-1)^n \left(\frac{1-e^{-2n}}{1+e^{-2n}} \right) = \lim_{n \rightarrow \infty} (-1)^n$
 does not exist
- converges by the Direct Comparison Test: $n! < n^n \Rightarrow \ln(n!) < n \ln(n) \Rightarrow \frac{\ln(n!)}{\ln(n)} < n$
 $\Rightarrow \log_n(n!) < n \Rightarrow \frac{\log_n(n!)}{n^2} < \frac{1}{n^2}$, which is the n th-term of a convergent p -series
- converges by the Direct Comparison Test: $a_1 = 1 = \frac{12}{(1)(3)(2)^2}$, $a_2 = \frac{1 \cdot 2}{3 \cdot 4} = \frac{12}{(2)(4)(3)^2}$, $a_3 = \left(\frac{2 \cdot 3}{4 \cdot 5}\right) \left(\frac{1 \cdot 2}{3 \cdot 4}\right)$
 $= \frac{12}{(3)(5)(4)^2}$, $a_4 = \left(\frac{3 \cdot 4}{5 \cdot 6}\right) \left(\frac{2 \cdot 3}{4 \cdot 5}\right) \left(\frac{1 \cdot 2}{3 \cdot 4}\right) = \frac{12}{(4)(6)(5)^2}, \dots \Rightarrow 1 + \sum_{n=1}^{\infty} \frac{12}{(n+1)(n+3)(n+2)^2}$ represents the

given series and $\frac{12}{(n+1)(n+3)(n+2)^2} < \frac{12}{n^4}$, which is the n th-term of a convergent p -series

6. converges by the Ratio Test: $\lim_{n \rightarrow \infty} \frac{a_{n+1}}{a_n} = \lim_{n \rightarrow \infty} \frac{n}{(n-1)(n+1)} = 0 < 1$
7. diverges by the n th-Term Test since if $a_n \rightarrow L$ as $n \rightarrow \infty$, then $L = \frac{1}{1+L} \Rightarrow L^2 + L - 1 = 0 \Rightarrow L = \frac{-1 \pm \sqrt{5}}{2} \neq 0$
8. Split the given series into $\sum_{n=1}^{\infty} \frac{1}{3^{2n+1}}$ and $\sum_{n=1}^{\infty} \frac{2n}{3^{2n}}$; the first subseries is a convergent geometric series and the second converges by the Root Test: $\lim_{n \rightarrow \infty} \sqrt[n]{\frac{2n}{3^{2n}}} = \lim_{n \rightarrow \infty} \frac{\sqrt[n]{2} \cdot \sqrt[n]{n}}{9} = \frac{1 \cdot 1}{9} = \frac{1}{9} < 1$
9. $f(x) = \cos x$ with $a = \frac{\pi}{3} \Rightarrow f\left(\frac{\pi}{3}\right) = 0.5, f'\left(\frac{\pi}{3}\right) = -\frac{\sqrt{3}}{2}, f''\left(\frac{\pi}{3}\right) = -0.5, f'''\left(\frac{\pi}{3}\right) = \frac{\sqrt{3}}{2}, f^{(4)}\left(\frac{\pi}{3}\right) = 0.5$;
 $\cos x = \frac{1}{2} - \frac{\sqrt{3}}{2}\left(x - \frac{\pi}{3}\right) - \frac{1}{4}\left(x - \frac{\pi}{3}\right)^2 + \frac{\sqrt{3}}{12}\left(x - \frac{\pi}{3}\right)^3 + \dots$
10. $f(x) = \sin x$ with $a = 2\pi \Rightarrow f(2\pi) = 0, f'(2\pi) = 1, f''(2\pi) = 0, f'''(2\pi) = -1, f^{(4)}(2\pi) = 0, f^{(5)}(2\pi) = 1, f^{(6)}(2\pi) = 0, f^{(7)}(2\pi) = -1$; $\sin x = (x - 2\pi) - \frac{(x - 2\pi)^3}{3!} + \frac{(x - 2\pi)^5}{5!} - \frac{(x - 2\pi)^7}{7!} + \dots$
11. $e^x = 1 + x + \frac{x^2}{2!} + \frac{x^3}{3!} + \dots$ with $a = 0$
12. $f(x) = \ln x$ with $a = 1 \Rightarrow f(1) = 0, f'(1) = 1, f''(1) = -1, f'''(1) = 2, f^{(4)}(1) = -6$;
 $\ln x = (x - 1) - \frac{(x-1)^2}{2} + \frac{(x-1)^3}{3} - \frac{(x-1)^4}{4} + \dots$
13. $f(x) = \cos x$ with $a = 22\pi \Rightarrow f(22\pi) = 1, f'(22\pi) = 0, f''(22\pi) = -1, f'''(22\pi) = 0, f^{(4)}(22\pi) = 1, f^{(5)}(22\pi) = 0, f^{(6)}(22\pi) = -1$; $\cos x = 1 - \frac{1}{2}(x - 22\pi)^2 + \frac{1}{4!}(x - 22\pi)^4 - \frac{1}{6!}(x - 22\pi)^6 + \dots$
14. $f(x) = \tan^{-1} x$ with $a = 1 \Rightarrow f(1) = \frac{\pi}{4}, f'(1) = \frac{1}{2}, f''(1) = -\frac{1}{2}, f'''(1) = \frac{1}{2}$;
 $\tan^{-1} x = \frac{\pi}{4} + \frac{(x-1)}{2} - \frac{(x-1)^2}{4} + \frac{(x-1)^3}{12} + \dots$
15. Yes, the sequence converges: $c_n = (a^n + b^n)^{1/n} \Rightarrow c_n = b \left(\left(\frac{a}{b}\right)^n + 1 \right)^{1/n} \Rightarrow \lim_{n \rightarrow \infty} c_n = \ln b + \lim_{n \rightarrow \infty} \frac{\ln\left(\left(\frac{a}{b}\right)^n + 1\right)}{n}$
 $= \ln b + \lim_{n \rightarrow \infty} \frac{\left(\frac{a}{b}\right)^n \ln\left(\frac{a}{b}\right)}{\left(\frac{a}{b}\right)^n + 1} = \ln b + \frac{0 \cdot \ln\left(\frac{a}{b}\right)}{0+1} = \ln b$ since $0 < a < b$. Thus, $\lim_{n \rightarrow \infty} c_n = e^{\ln b} = b$.
16. $1 + \frac{2}{10} + \frac{3}{10^2} + \frac{7}{10^3} + \frac{2}{10^4} + \frac{3}{10^5} + \frac{7}{10^6} + \dots = 1 + \sum_{n=1}^{\infty} \frac{2}{10^{3n-2}} + \sum_{n=1}^{\infty} \frac{3}{10^{3n-1}} + \sum_{n=1}^{\infty} \frac{7}{10^{3n}}$
 $= 1 + \sum_{n=0}^{\infty} \frac{2}{10^{3n+1}} + \sum_{n=0}^{\infty} \frac{3}{10^{3n+2}} + \sum_{n=0}^{\infty} \frac{7}{10^{3n+3}} = 1 + \frac{\left(\frac{2}{10}\right)}{1 - \left(\frac{1}{10}\right)^3} + \frac{\left(\frac{3}{10^2}\right)}{1 - \left(\frac{1}{10}\right)^3} + \frac{\left(\frac{7}{10^3}\right)}{1 - \left(\frac{1}{10}\right)^3}$
 $= 1 + \frac{200}{999} + \frac{30}{999} + \frac{7}{999} = \frac{999+237}{999} = \frac{412}{333}$
17. $s_n = \sum_{k=0}^{n-1} \int_k^{k+1} \frac{dx}{1+x^2} \Rightarrow s_n = \int_0^1 \frac{dx}{1+x^2} + \int_1^2 \frac{dx}{1+x^2} + \dots + \int_{n-1}^n \frac{dx}{1+x^2} \Rightarrow s_n = \int_0^n \frac{dx}{1+x^2}$
 $\Rightarrow \lim_{n \rightarrow \infty} s_n = \lim_{n \rightarrow \infty} (\tan^{-1} n - \tan^{-1} 0) = \frac{\pi}{2}$
18. $\lim_{n \rightarrow \infty} \left| \frac{u_{n+1}}{u_n} \right| = \lim_{n \rightarrow \infty} \left| \frac{(n+1)x^{n+1}}{(n+2)(2x+1)^{n+1}} \cdot \frac{(n+1)(2x+1)^n}{nx^n} \right| = \lim_{n \rightarrow \infty} \left| \frac{x}{2x+1} \cdot \frac{(n+1)^2}{n(n+2)} \right| = \left| \frac{x}{2x+1} \right| < 1$
 $\Rightarrow |x| < |2x+1|$; if $x > 0, |x| < |2x+1| \Rightarrow x < 2x+1 \Rightarrow x > -1$; if $-\frac{1}{2} < x < 0, |x| < |2x+1|$
 $\Rightarrow -x < 2x+1 \Rightarrow 3x > -1 \Rightarrow x > -\frac{1}{3}$; if $x < -\frac{1}{2}, |x| < |2x+1| \Rightarrow -x < -2x-1 \Rightarrow x < -1$. Therefore,

the series converges absolutely for $x < -1$ and $x > -\frac{1}{3}$.

19. (a) Each A_{n+1} fits into the corresponding upper triangular region, whose vertices are:

$(n, f(n) - f(n+1))$, $(n+1, f(n+1))$ and $(n, f(n))$ along the line whose slope is $f(n+1) - f(n)$.

All the A_n 's fit into the first upper triangular region whose area is $\frac{f(1)-f(2)}{2} \Rightarrow \sum_{n=1}^{\infty} A_n < \frac{f(1)-f(2)}{2}$

(b) If $A_k = \frac{f(k+1)+f(k)}{2} - \int_k^{k+1} f(x) dx$, then

$$\sum_{k=1}^{n-1} A_k = \frac{f(1)+f(2)+f(2)+f(3)+f(3)+\dots+f(n-1)+f(n)}{2} - \int_1^2 f(x) dx - \int_2^3 f(x) dx - \dots - \int_{n-1}^n f(x) dx$$

$$= \frac{f(1)+f(n)}{2} + \sum_{k=2}^{n-1} f(k) - \int_1^n f(x) dx \Rightarrow \sum_{k=1}^{n-1} A_k = \sum_{k=1}^n f(k) - \frac{f(1)+f(n)}{2} - \int_1^n f(x) dx < \frac{f(1)-f(2)}{2}, \text{ from}$$

part (a). The sequence $\left\{ \sum_{k=1}^{n-1} A_k \right\}$ is bounded above and increasing, so it converges and the limit in question must exist.

(c) Let $L = \lim_{n \rightarrow \infty} \left[\sum_{k=1}^n f(k) - \int_1^n f(x) dx - \frac{1}{2}(f(1) + f(n)) \right]$, which exists by part (b). Since f is positive and

decreasing $\lim_{n \rightarrow \infty} f(n) = M \geq 0$ exists. Thus $\lim_{n \rightarrow \infty} \left[\sum_{k=1}^n f(k) - \int_1^n f(x) dx \right] = L + \frac{1}{2}(f(1) + M)$.

20. The number of triangles removed at stage n is 3^{n-1} ; the side length at stage n is $\frac{b}{2^{n-1}}$; the area of a triangle at stage n is $\frac{\sqrt{3}}{4} \left(\frac{b}{2^{n-1}} \right)^2$.

$$(a) \frac{\sqrt{3}}{4} b^2 + 3 \frac{\sqrt{3}}{4} \left(\frac{b^2}{2^2} \right) + 3^2 \frac{\sqrt{3}}{4} \left(\frac{b^2}{2^4} \right) + 3^3 \frac{\sqrt{3}}{4} \left(\frac{b^2}{2^6} \right) + \dots = \frac{\sqrt{3}}{4} b^2 \sum_{n=0}^{\infty} \frac{3^n}{2^{2n}} = \frac{\sqrt{3}}{4} b^2 \sum_{n=0}^{\infty} \left(\frac{3}{4} \right)^n$$

$$(b) \text{ a geometric series with sum } \frac{\left(\frac{\sqrt{3}}{4} b^2 \right)}{1 - \left(\frac{3}{4} \right)} = \sqrt{3} b^2$$

(c) No; for instance, the three vertices of the original triangle are not removed. However the total area removed is $\sqrt{3}b^2$ which equals the area of the original triangle. Thus the set of points not removed has area 0.

21. (a) No, the limit does not appear to depend on the value of the constant a

(b) Yes, the limit depends on the value of b

$$(c) s = \left(1 - \frac{\cos\left(\frac{a}{n}\right)}{n} \right)^n \Rightarrow \ln s = \frac{\ln\left(1 - \frac{\cos\left(\frac{a}{n}\right)}{n}\right)}{\left(\frac{1}{n}\right)} \Rightarrow \lim_{n \rightarrow \infty} \ln s = \frac{\left(\frac{1}{1 - \cos\left(\frac{a}{n}\right)}\right) \left(\frac{-\frac{a}{n} \sin\left(\frac{a}{n}\right) + \cos\left(\frac{a}{n}\right)}{n^2}\right)}{\left(-\frac{1}{n^2}\right)}$$

$$= \lim_{n \rightarrow \infty} \frac{\frac{a}{n} \sin\left(\frac{a}{n}\right) - \cos\left(\frac{a}{n}\right)}{1 - \cos\left(\frac{a}{n}\right)} = \frac{0-1}{1-0} = -1 \Rightarrow \lim_{n \rightarrow \infty} s = e^{-1} \approx 0.3678794412; \text{ similarly,}$$

$$\lim_{n \rightarrow \infty} \left(1 - \frac{\cos\left(\frac{a}{n}\right)}{bn} \right)^n = e^{-1/b}$$

22. $\sum_{n=1}^{\infty} a_n$ converges $\Rightarrow \lim_{n \rightarrow \infty} a_n = 0$; $\lim_{n \rightarrow \infty} \left[\left(\frac{1+\sin a_n}{2} \right)^n \right]^{1/n} = \lim_{n \rightarrow \infty} \left(\frac{1+\sin a_n}{2} \right) = \frac{1+\sin\left(\lim_{n \rightarrow \infty} a_n\right)}{2} = \frac{1+\sin 0}{2} = \frac{1}{2} \Rightarrow$ the series converges by the n th-Root Test

$$23. \lim_{n \rightarrow \infty} \left| \frac{u_{n+1}}{u_n} \right| < 1 \Rightarrow \lim_{n \rightarrow \infty} \left| \frac{b^{n+1}x^{n+1}}{\ln(n+1)} \cdot \frac{\ln n}{b^n x^n} \right| < 1 \Rightarrow |bx| < 1 \Rightarrow -\frac{1}{b} < x < \frac{1}{b} = 5 \Rightarrow b = \pm \frac{1}{5}$$

24. A polynomial has only a finite number of nonzero terms in its Taylor series, but the functions $\sin x$, $\ln x$ and e^x have infinitely many nonzero terms in their Taylor expansions.

$$25. \lim_{x \rightarrow 0} \frac{\sin(ax) - \sin x - x}{x^3} = \lim_{x \rightarrow 0} \frac{(ax - \frac{a^3 x^3}{3!} + \dots) - (x - \frac{x^3}{3!} + \dots) - x}{x^3}$$

$$= \lim_{x \rightarrow 0} \left[\frac{a-2}{x^2} - \frac{a^3}{3!} + \frac{1}{3!} - \left(\frac{a^5}{5!} - \frac{1}{5!} \right) x^2 + \dots \right] \text{ is finite if } a-2=0 \Rightarrow a=2;$$

$$\lim_{x \rightarrow 0} \frac{\sin 2x - \sin x - x}{x^3} = -\frac{2^3}{3!} + \frac{1}{3!} = -\frac{7}{6}$$

$$26. \lim_{x \rightarrow 0} \frac{\cos ax - b}{2x^2} = -1 \Rightarrow \lim_{x \rightarrow 0} \frac{(1 - \frac{a^2 x^2}{2} + \frac{a^4 x^4}{4!} - \dots) - b}{2x^2} = -1 \Rightarrow \lim_{x \rightarrow 0} \left(\frac{1-b}{2x^2} - \frac{a^2}{4} + \frac{a^2 x^2}{48} - \dots \right) = -1$$

$$\Rightarrow b = 1 \text{ and } a = \pm 2$$

$$27. (a) \frac{u_n}{u_{n+1}} = \frac{(n+1)^2}{n^2} = 1 + \frac{2}{n} + \frac{1}{n^2} \Rightarrow C = 2 > 1 \text{ and } \sum_{n=1}^{\infty} \frac{1}{n^2} \text{ converges}$$

$$(b) \frac{u_n}{u_{n+1}} = \frac{n+1}{n} = 1 + \frac{1}{n} + \frac{0}{n^2} \Rightarrow C = 1 \leq 1 \text{ and } \sum_{n=1}^{\infty} \frac{1}{n} \text{ diverges}$$

$$28. \frac{u_n}{u_{n+1}} = \frac{2n(2n+1)}{(2n-1)^2} = \frac{4n^2+2n}{4n^2-4n+1} = 1 + \frac{(\frac{6}{4})}{4n^2-4n+1} + \frac{5}{4n^2-4n+1} = 1 + \frac{(\frac{3}{2})}{n} + \frac{\left[\frac{5n^2}{(4n^2-4n+1)} \right]}{n^2} \text{ after long division}$$

$$\Rightarrow C = \frac{3}{2} > 1 \text{ and } |f(n)| = \frac{5n^2}{4n^2-4n+1} = \frac{5}{(4-\frac{4}{n}+\frac{1}{n^2})} \leq 5 \Rightarrow \sum_{n=1}^{\infty} u_n \text{ converges by Raabe's Test}$$

$$29. (a) \sum_{n=1}^{\infty} a_n = L \Rightarrow a_n^2 \leq a_n \sum_{n=1}^{\infty} a_n = a_n L \Rightarrow \sum_{n=1}^{\infty} a_n^2 \text{ converges by the Direct Comparison Test}$$

$$(b) \text{ converges by the Limit Comparison Test: } \lim_{n \rightarrow \infty} \frac{(\frac{a_n}{1-a_n})}{a_n} = \lim_{n \rightarrow \infty} \frac{1}{1-a_n} = 1 \text{ since } \sum_{n=1}^{\infty} a_n \text{ converges and}$$

$$\text{therefore } \lim_{x \rightarrow \infty} a_n = 0$$

$$30. \text{ If } 0 < a_n < 1 \text{ then } |\ln(1-a_n)| = -\ln(1-a_n) = a_n + \frac{a_n^2}{2} + \frac{a_n^3}{3} + \dots < a_n + a_n^2 + a_n^3 + \dots = \frac{a_n}{1-a_n},$$

$$\text{ a positive term of a convergent series, by the Limit Comparison Test and Exercise 29b}$$

$$31. (1-x)^{-1} = 1 + \sum_{n=1}^{\infty} x^n \text{ where } |x| < 1 \Rightarrow \frac{1}{(1-x)^2} = \frac{d}{dx} (1-x)^{-1} = \sum_{n=1}^{\infty} n x^{n-1} \text{ and when } x = \frac{1}{2} \text{ we have}$$

$$4 = 1 + 2\left(\frac{1}{2}\right) + 3\left(\frac{1}{2}\right)^2 + 4\left(\frac{1}{2}\right)^3 + \dots + n\left(\frac{1}{2}\right)^{n-1} + \dots$$

$$32. (a) \sum_{n=1}^{\infty} x^{n+1} = \frac{x^2}{1-x} \Rightarrow \sum_{n=1}^{\infty} (n+1)x^n = \frac{2x-x^2}{(1-x)^2} \Rightarrow \sum_{n=1}^{\infty} n(n+1)x^{n-1} = \frac{2}{(1-x)^3} \Rightarrow \sum_{n=1}^{\infty} n(n+1)x^n = \frac{2x}{(1-x)^3}$$

$$\Rightarrow \sum_{n=1}^{\infty} \frac{n(n+1)}{x^n} = \frac{\frac{2}{x}}{\left(1-\frac{1}{x}\right)^3} = \frac{2x^2}{(x-1)^3}, |x| > 1$$

$$(b) x = \sum_{n=1}^{\infty} \frac{n(n+1)}{x^n} \Rightarrow x = \frac{2x^2}{(x-1)^3} \Rightarrow x^3 - 3x^2 + x - 1 = 0 \Rightarrow x = 1 + \left(1 + \frac{\sqrt{57}}{9}\right)^{1/3} + \left(1 - \frac{\sqrt{57}}{9}\right)^{1/3}$$

$$\approx 2.769292, \text{ using a CAS or calculator}$$

$$33. \text{ The sequence } \{x_n\} \text{ converges to } \frac{\pi}{2} \text{ from below so } \epsilon_n = \frac{\pi}{2} - x_n > 0 \text{ for each } n. \text{ By the Alternating Series Estimation Theorem } \epsilon_{n+1} \approx \frac{1}{3!} (\epsilon_n)^3 \text{ with } |\text{error}| < \frac{1}{5!} (\epsilon_n)^5, \text{ and since the remainder is negative this is an overestimate } \Rightarrow 0 < \epsilon_{n+1} < \frac{1}{6} (\epsilon_n)^3.$$

$$34. \text{ Yes, the series } \sum_{n=1}^{\infty} \ln(1+a_n) \text{ converges by the Direct Comparison Test: } 1+a_n < 1+a_n + \frac{a_n^2}{2!} + \frac{a_n^3}{3!} + \dots$$

$$\Rightarrow 1+a_n < e^{a_n} \Rightarrow \ln(1+a_n) < a_n$$

35. (a) $\frac{1}{(1-x)^2} = \frac{d}{dx} \left(\frac{1}{1-x} \right) = \frac{d}{dx} (1 + x + x^2 + x^3 + \dots) = 1 + 2x + 3x^2 + 4x^3 + \dots = \sum_{n=1}^{\infty} nx^{n-1}$
- (b) from part (a) we have $\sum_{n=1}^{\infty} n \left(\frac{5}{6}\right)^{n-1} \left(\frac{1}{6}\right) = \left(\frac{1}{6}\right) \left[\frac{1}{1-\left(\frac{5}{6}\right)} \right]^2 = 6$
- (c) from part (a) we have $\sum_{n=1}^{\infty} np^{n-1}q = \frac{q}{(1-p)^2} = \frac{q}{q^2} = \frac{1}{q}$
36. (a) $\sum_{k=1}^{\infty} p_k = \sum_{k=1}^{\infty} 2^{-k} = \frac{(\frac{1}{2})}{1-(\frac{1}{2})} = 1$ and $E(x) = \sum_{k=1}^{\infty} kp_k = \sum_{k=1}^{\infty} k2^{-k} = \frac{1}{2} \sum_{k=1}^{\infty} k2^{1-k} = \left(\frac{1}{2}\right) \frac{1}{\left[1-\left(\frac{1}{2}\right)\right]^2} = 2$
by Exercise 35(a)
- (b) $\sum_{k=1}^{\infty} p_k = \sum_{k=1}^{\infty} \frac{5^{k-1}}{6^k} = \frac{1}{5} \sum_{k=1}^{\infty} \left(\frac{5}{6}\right)^k = \left(\frac{1}{5}\right) \left[\frac{\left(\frac{5}{6}\right)}{1-\left(\frac{5}{6}\right)} \right] = 1$ and $E(x) = \sum_{k=1}^{\infty} kp_k = \sum_{k=1}^{\infty} k \frac{5^{k-1}}{6^k} = \frac{1}{6} \sum_{k=1}^{\infty} k \left(\frac{5}{6}\right)^{k-1}$
 $= \left(\frac{1}{6}\right) \frac{1}{\left[1-\left(\frac{5}{6}\right)\right]^2} = 6$
- (c) $\sum_{k=1}^{\infty} p_k = \sum_{k=1}^{\infty} \frac{1}{k(k+1)} = \sum_{k=1}^{\infty} \left(\frac{1}{k} - \frac{1}{k+1}\right) = \lim_{k \rightarrow \infty} \left(1 - \frac{1}{k+1}\right) = 1$ and $E(x) = \sum_{k=1}^{\infty} kp_k = \sum_{k=1}^{\infty} k \left(\frac{1}{k(k+1)}\right)$
 $= \sum_{k=1}^{\infty} \frac{1}{k+1}$, a divergent series so that $E(x)$ does not exist
37. (a) $R_n = C_0 e^{-kt_0} + C_0 e^{-2kt_0} + \dots + C_0 e^{-nkt_0} = \frac{C_0 e^{-kt_0} (1 - e^{-nkt_0})}{1 - e^{-kt_0}} \Rightarrow R = \lim_{n \rightarrow \infty} R_n = \frac{C_0 e^{-kt_0}}{1 - e^{-kt_0}} = \frac{C_0}{e^{kt_0} - 1}$
- (b) $R_n = \frac{e^{-1}(1 - e^{-n})}{1 - e^{-1}} \Rightarrow R_1 = e^{-1} \approx 0.36787944$ and $R_{10} = \frac{e^{-1}(1 - e^{-10})}{1 - e^{-1}} \approx 0.58195028$;
 $R = \frac{1}{e-1} \approx 0.58197671$; $R - R_{10} \approx 0.00002643 \Rightarrow \frac{R - R_{10}}{R} < 0.0001$
- (c) $R_n = \frac{e^{-1}(1 - e^{-1n})}{1 - e^{-1}}$, $\frac{R}{2} = \frac{1}{2} \left(\frac{1}{e-1}\right) \approx 4.7541659$; $R_n > \frac{R}{2} \Rightarrow \frac{1 - e^{-1n}}{1 - e^{-1}} > \left(\frac{1}{2}\right) \left(\frac{1}{e-1}\right)$
 $\Rightarrow 1 - e^{-n/10} > \frac{1}{2} \Rightarrow e^{-n/10} < \frac{1}{2} \Rightarrow -\frac{n}{10} < \ln\left(\frac{1}{2}\right) \Rightarrow \frac{n}{10} > -\ln\left(\frac{1}{2}\right) \Rightarrow n > 6.93 \Rightarrow n = 7$
38. (a) $R = \frac{C_0}{e^{kt_0} - 1} \Rightarrow R e^{kt_0} = R + C_0 = C_H \Rightarrow e^{kt_0} = \frac{C_H}{C_0} \Rightarrow t_0 = \frac{1}{k} \ln\left(\frac{C_H}{C_0}\right)$
- (b) $t_0 = \frac{1}{0.05} \ln e = 20$ hrs
- (c) Give an initial dose that produces a concentration of 2 mg/ml followed every $t_0 = \frac{1}{0.02} \ln\left(\frac{2}{0.5}\right) \approx 69.31$ hrs
by a dose that raises the concentration by 1.5 mg/ml
- (d) $t_0 = \frac{1}{0.2} \ln\left(\frac{0.1}{0.03}\right) = 5 \ln\left(\frac{10}{3}\right) \approx 6$ hrs
39. The convergence of $\sum_{n=1}^{\infty} |a_n|$ implies that $\lim_{n \rightarrow \infty} |a_n| = 0$. Let $N > 0$ be such that $|a_n| < \frac{1}{2} \Rightarrow 1 - |a_n| > \frac{1}{2}$
 $\Rightarrow \frac{|a_n|}{1 - |a_n|} < 2|a_n|$ for all $n > N$. Now $|\ln(1 + a_n)| = \left| a_n - \frac{a_n^2}{2} + \frac{a_n^3}{3} - \frac{a_n^4}{4} + \dots \right| \leq |a_n| + \left| \frac{a_n^2}{2} \right| + \left| \frac{a_n^3}{3} \right| + \left| \frac{a_n^4}{4} \right| + \dots$
 $< |a_n| + |a_n|^2 + |a_n|^3 + |a_n|^4 + \dots = \frac{|a_n|}{1 - |a_n|} < 2|a_n|$. Therefore $\sum_{n=1}^{\infty} \ln(1 + a_n)$ converges by the Direct
Comparison Test since $\sum_{n=1}^{\infty} |a_n|$ converges.
40. $\sum_{n=3}^{\infty} \frac{1}{n \ln n (\ln(\ln n))^p}$ converges if $p > 1$ and diverges otherwise by the Integral Test: when $p = 1$ we have
 $\lim_{b \rightarrow \infty} \int_3^b \frac{dx}{x \ln x (\ln(\ln x))} = \lim_{b \rightarrow \infty} [\ln(\ln(\ln x))]_3^b = \infty$; when $p \neq 1$ we have $\lim_{b \rightarrow \infty} \int_3^b \frac{dx}{x \ln x (\ln(\ln x))^p}$
 $= \lim_{b \rightarrow \infty} \left[\frac{(\ln(\ln x))^{-p+1}}{1-p} \right]_3^b = \begin{cases} \frac{(\ln(\ln 3))^{-p+1}}{1-p}, & \text{if } p > 1 \\ \infty, & \text{if } p < 1 \end{cases}$

41. (a) $s_{2n+1} = \frac{c_1}{1} + \frac{c_2}{2} + \frac{c_3}{3} + \dots + \frac{c_{2n+1}}{2n+1} = \frac{t_1}{1} + \frac{t_2-t_1}{2} + \frac{t_3-t_2}{3} + \dots + \frac{t_{2n+1}-t_{2n}}{2n+1}$
 $= t_1 \left(1 - \frac{1}{2}\right) + t_2 \left(\frac{1}{2} - \frac{1}{3}\right) + \dots + t_{2n} \left(\frac{1}{2n} - \frac{1}{2n+1}\right) + \frac{t_{2n+1}}{2n+1} = \sum_{k=1}^{2n} \frac{t_k}{k(k+1)} + \frac{t_{2n+1}}{2n+1}.$
- (b) $\{c_n\} = \{(-1)^n\} \Rightarrow \sum_{n=1}^{\infty} \frac{(-1)^n}{n}$ converges
- (c) $\{c_n\} = \{1, -1, -1, 1, 1, -1, -1, 1, 1, \dots\} \Rightarrow$ the series $1 - \frac{1}{2} - \frac{1}{3} + \frac{1}{4} + \frac{1}{5} - \frac{1}{6} - \frac{1}{7} + \dots$ converges
42. (a) $(1 - t + t^2 - t^3 + \dots + (-1)^n t^n)(1 + t) = 1 - t + t^2 - t^3 + \dots + (-1)^n t^n + t - t^2 + t^3 - t^4 + \dots + (-1)^n t^{n+1}$
 $= 1 + (-1)^n t^{n+1} \Rightarrow 1 - t + t^2 - t^3 + \dots + (-1)^n t^n - \frac{(-1)^n t^{n+1}}{1+t} = \frac{1}{1+t}$
- (b) $\int_0^x \frac{1}{1+t} dt = \int_0^x \left[1 - t + t^2 + \dots + (-1)^n t^n + \frac{(-1)^{n+1} t^{n+1}}{1+t}\right] dt \Rightarrow [\ln |1+t|]_0^x$
 $= \left[t - \frac{t^2}{2} + \frac{t^3}{3} + \dots + \frac{(-1)^n t^{n+1}}{n+1}\right]_0^x + \int_0^x \frac{(-1)^{n+1} t^{n+1}}{n+1} dt \Rightarrow \ln |1+x|$
 $= x - \frac{x^2}{2} + \frac{x^3}{3} - \dots + \frac{(-1)^n x^{n+1}}{n+1} + R_{n+1},$ where $R_{n+1} = \int_0^x \frac{(-1)^{n+1} t^{n+1}}{n+1} dt$
- (c) $x > 0$ and $R_{n+1} = (-1)^{n+1} \int_0^x \frac{t^{n+1}}{1+t} dt \Rightarrow |R_{n+1}| = \int_0^x \frac{t^{n+1}}{1+t} dt \leq \int_0^x t^{n+1} dt = \frac{x^{n+2}}{n+2}$
- (d) $-1 < x < 0$ and $R_{n+1} = (-1)^{n+1} \int_0^x \frac{t^{n+1}}{1+t} dt \Rightarrow |R_{n+1}| = \left| \int_0^x \frac{t^{n+1}}{1+t} dt \right| \leq \int_0^x \left| \frac{t^{n+1}}{1+t} \right| dt$
 $\leq \int_0^x \frac{|t|^{n+1}}{1-|x|} dx = \frac{|x|^{n+2}}{(1-|x|)(n+2)}$ since $|1+t| \geq 1-|x|$
- (e) From part (d) we have $|R_{n+1}| \leq \frac{|x|^{n+2}}{(1-|x|)(n+2)} \Rightarrow$ the given series converges since
 $\lim_{n \rightarrow \infty} \frac{|x|^{n+2}}{(1-|x|)(n+2)} = 0 \Rightarrow |R_{n+1}| \rightarrow 0$ when $|x| < 1$. If $x = 1$, by part (c) $|R_{n+1}| \leq \frac{|x|^{n+2}}{n+2} = \frac{1}{n+2} \rightarrow 0$.
 Thus the given series converges to $\ln(1+x)$ for $-1 < x \leq 1$.

CHAPTER 12 VECTORS AND THE GEOMETRY OF SPACE

12.1 THREE-DIMENSIONAL COORDINATE SYSTEMS

- The line through the point $(2, 3, 0)$ parallel to the z -axis
- The line through the point $(-1, 0, 0)$ parallel to the y -axis
- The x -axis
- The line through the point $(1, 0, 0)$ parallel to the z -axis
- The circle $x^2 + y^2 = 4$ in the xy -plane
- The circle $x^2 + y^2 = 4$ in the plane $z = -2$
- The circle $x^2 + z^2 = 4$ in the xz -plane
- The circle $y^2 + z^2 = 1$ in the yz -plane
- The circle $y^2 + z^2 = 1$ in the yz -plane
- The circle $x^2 + z^2 = 9$ in the plane $y = -4$
- The circle $x^2 + y^2 = 16$ in the xy -plane
- The circle $x^2 + z^2 = 3$ in the xz -plane
- The first quadrant of the xy -plane
 - The fourth quadrant of the xy -plane
- The slab bounded by the planes $x = 0$ and $x = 1$
 - The square column bounded by the planes $x = 0, x = 1, y = 0, y = 1$
 - The unit cube in the first octant having one vertex at the origin
- The solid ball of radius 1 centered at the origin
 - The exterior of the sphere of radius 1 centered at the origin
- The circumference and interior of the circle $x^2 + y^2 = 1$ in the xy -plane
 - The circumference and interior of the circle $x^2 + y^2 = 1$ in the plane $z = 3$
 - A solid cylindrical column of radius 1 whose axis is the z -axis
- The closed upper hemisphere of radius 1 centered at the origin
 - The solid upper hemisphere of radius 1 centered at the origin
- The line $y = x$ in the xy -plane
 - The plane $y = x$ consisting of all points of the form (x, x, z)

780 Chapter 12 Vectors and the Geometry of Space

19. (a) $x = 3$

(b) $y = -1$

(c) $z = -2$

20. (a) $x = 3$

(b) $y = -1$

(c) $z = 2$

21. (a) $z = 1$

(b) $x = 3$

(c) $y = -1$

22. (a) $x^2 + y^2 = 4, z = 0$

(b) $y^2 + z^2 = 4, x = 0$

(c) $x^2 + z^2 = 4, y = 0$

23. (a) $x^2 + (y - 2)^2 = 4, z = 0$

(b) $(y - 2)^2 + z^2 = 4, x = 0$

(c) $x^2 + z^2 = 4, y = 2$

24. (a) $(x + 3)^2 + (y - 4)^2 = 1, z = 1$

(b) $(y - 4)^2 + (z - 1)^2 = 1, x = -3$

(c) $(x + 3)^2 + (z - 1)^2 = 1, y = 4$

25. (a) $y = 3, z = -1$

(b) $x = 1, z = -1$

(c) $x = 1, y = 3$

26. $\sqrt{x^2 + y^2 + z^2} = \sqrt{x^2 + (y - 2)^2 + z^2} \Rightarrow x^2 + y^2 + z^2 = x^2 + (y - 2)^2 + z^2 \Rightarrow y^2 = y^2 - 4y + 4 \Rightarrow y = 1$

27. $x^2 + y^2 + z^2 = 25, z = 3 \Rightarrow x^2 + y^2 = 16$ in the plane $z = 3$

28. $x^2 + y^2 + (z - 1)^2 = 4$ and $x^2 + y^2 + (z + 1)^2 = 4 \Rightarrow x^2 + y^2 + (z - 1)^2 = x^2 + y^2 + (z + 1)^2 \Rightarrow z = 0, x^2 + y^2 = 3$

29. $0 \leq z \leq 1$

30. $0 \leq x \leq 2, 0 \leq y \leq 2, 0 \leq z \leq 2$

31. $z \leq 0$

32. $z = \sqrt{1 - x^2 - y^2}$

33. (a) $(x - 1)^2 + (y - 1)^2 + (z - 1)^2 < 1$

(b) $(x - 1)^2 + (y - 1)^2 + (z - 1)^2 > 1$

34. $1 \leq x^2 + y^2 + z^2 \leq 4$

35. $|P_1P_2| = \sqrt{(3 - 1)^2 + (3 - 1)^2 + (0 - 1)^2} = \sqrt{9} = 3$

36. $|P_1P_2| = \sqrt{(2 + 1)^2 + (5 - 1)^2 + (0 - 5)^2} = \sqrt{50} = 5\sqrt{2}$

37. $|P_1P_2| = \sqrt{(4 - 1)^2 + (-2 - 4)^2 + (7 - 5)^2} = \sqrt{49} = 7$

38. $|P_1P_2| = \sqrt{(2 - 3)^2 + (3 - 4)^2 + (4 - 5)^2} = \sqrt{3}$

39. $|P_1P_2| = \sqrt{(2 - 0)^2 + (-2 - 0)^2 + (-2 - 0)^2} = \sqrt{3 \cdot 4} = 2\sqrt{3}$

40. $|P_1P_2| = \sqrt{(0 - 5)^2 + (0 - 3)^2 + (0 + 2)^2} = \sqrt{38}$

41. center $(-2, 0, 2)$, radius $2\sqrt{2}$

42. center $(-\frac{1}{2}, -\frac{1}{2}, -\frac{1}{2})$, radius $\frac{\sqrt{21}}{2}$

43. center $(\sqrt{2}, \sqrt{2}, -\sqrt{2})$, radius $\sqrt{2}$

44. center $(0, -\frac{1}{3}, \frac{1}{3})$, radius $\frac{\sqrt{29}}{3}$

45. $(x - 1)^2 + (y - 2)^2 + (z - 3)^2 = 14$

46. $x^2 + (y + 1)^2 + (z - 5)^2 = 4$

47. $(x + 2)^2 + y^2 + z^2 = 3$

48. $x^2 + (y + 7)^2 + z^2 = 49$

49. $x^2 + y^2 + z^2 + 4x - 4z = 0 \Rightarrow (x^2 + 4x + 4) + y^2 + (z^2 - 4z + 4) = 4 + 4$

$$\Rightarrow (x + 2)^2 + (y - 0)^2 + (z - 2)^2 = (\sqrt{8})^2 \Rightarrow \text{the center is at } (-2, 0, 2) \text{ and the radius is } \sqrt{8}$$

50. $x^2 + y^2 + z^2 - 6y + 8z = 0 \Rightarrow x^2 + (y^2 - 6y + 9) + (z^2 + 8z + 16) = 9 + 16 \Rightarrow (x - 0)^2 + (y - 3)^2 + (z + 4)^2 = 5^2$

$$\Rightarrow \text{the center is at } (0, 3, -4) \text{ and the radius is } 5$$

51. $2x^2 + 2y^2 + 2z^2 + x + y + z = 9 \Rightarrow x^2 + \frac{1}{2}x + y^2 + \frac{1}{2}y + z^2 + \frac{1}{2}z = \frac{9}{2}$

$$\Rightarrow (x^2 + \frac{1}{2}x + \frac{1}{16}) + (y^2 + \frac{1}{2}y + \frac{1}{16}) + (z^2 + \frac{1}{2}z + \frac{1}{16}) = \frac{9}{2} + \frac{3}{16} \Rightarrow (x + \frac{1}{4})^2 + (y + \frac{1}{4})^2 + (z + \frac{1}{4})^2 = (\frac{5\sqrt{3}}{4})^2$$

$$\Rightarrow \text{the center is at } (-\frac{1}{4}, -\frac{1}{4}, -\frac{1}{4}) \text{ and the radius is } \frac{5\sqrt{3}}{4}$$

52. $3x^2 + 3y^2 + 3z^2 + 2y - 2z = 9 \Rightarrow x^2 + y^2 + \frac{2}{3}y + z^2 - \frac{2}{3}z = 3 \Rightarrow x^2 + (y^2 + \frac{2}{3}y + \frac{1}{9}) + (z^2 - \frac{2}{3}z + \frac{1}{9}) = 3 + \frac{2}{9}$

$$\Rightarrow (x - 0)^2 + (y + \frac{1}{3})^2 + (z - \frac{1}{3})^2 = (\frac{\sqrt{29}}{3})^2 \Rightarrow \text{the center is at } (0, -\frac{1}{3}, \frac{1}{3}) \text{ and the radius is } \frac{\sqrt{29}}{3}$$

53. (a) the distance between (x, y, z) and $(x, 0, 0)$ is $\sqrt{y^2 + z^2}$

(b) the distance between (x, y, z) and $(0, y, 0)$ is $\sqrt{x^2 + z^2}$

(c) the distance between (x, y, z) and $(0, 0, z)$ is $\sqrt{x^2 + y^2}$

54. (a) the distance between (x, y, z) and $(x, y, 0)$ is z

(b) the distance between (x, y, z) and $(0, y, z)$ is x

(c) the distance between (x, y, z) and $(x, 0, z)$ is y

55. $|AB| = \sqrt{(1 - (-1))^2 + (-1 - 2)^2 + (3 - 1)^2} = \sqrt{4 + 9 + 4} = \sqrt{17}$

$$|BC| = \sqrt{(3 - 1)^2 + (4 - (-1))^2 + (5 - 3)^2} = \sqrt{4 + 25 + 4} = \sqrt{33}$$

$$|CA| = \sqrt{(-1 - 3)^2 + (2 - 4)^2 + (1 - 5)^2} = \sqrt{16 + 4 + 16} = \sqrt{36} = 6$$

Thus the perimeter of triangle ABC is $\sqrt{17} + \sqrt{33} + 6$.

56. $|PA| = \sqrt{(2 - 3)^2 + (-1 - 1)^2 + (3 - 2)^2} = \sqrt{1 + 4 + 1} = \sqrt{6}$

$$|PB| = \sqrt{(4 - 3)^2 + (3 - 1)^2 + (1 - 2)^2} = \sqrt{1 + 4 + 1} = \sqrt{6}$$

Thus P is equidistant from A and B.

12.2 VECTORS

1. (a) $\langle 3(3), 3(-2) \rangle = \langle 9, -6 \rangle$

(b) $\sqrt{9^2 + (-6)^2} = \sqrt{117} = 3\sqrt{13}$

2. (a) $\langle -2(-2), -2(5) \rangle = \langle 4, -10 \rangle$

(b) $\sqrt{4^2 + (-10)^2} = \sqrt{116} = 2\sqrt{29}$

3. (a) $\langle 3 + (-2), -2 + 5 \rangle = \langle 1, 3 \rangle$

(b) $\sqrt{1^2 + 3^2} = \sqrt{10}$

4. (a) $\langle 3 - (-2), -2 - 5 \rangle = \langle 5, -7 \rangle$

(b) $\sqrt{5^2 + (-7)^2} = \sqrt{74}$

5. (a) $2\mathbf{u} = \langle 2(3), 2(-2) \rangle = \langle 6, -4 \rangle$
 $3\mathbf{v} = \langle 3(-2), 3(5) \rangle = \langle -6, 15 \rangle$
 $2\mathbf{u} - 3\mathbf{v} = \langle 6 - (-6), -4 - 15 \rangle = \langle 12, -19 \rangle$
 (b) $\sqrt{12^2 + (-19)^2} = \sqrt{505}$
6. (a) $-2\mathbf{u} = \langle -2(3), -2(-2) \rangle = \langle -6, 4 \rangle$
 $5\mathbf{v} = \langle 5(-2), 5(5) \rangle = \langle -10, 25 \rangle$
 $-2\mathbf{u} + 5\mathbf{v} = \langle -6 + (-10), 4 + 25 \rangle = \langle -16, 29 \rangle$
 (b) $\sqrt{(-16)^2 + 29^2} = \sqrt{1097}$
7. (a) $\frac{3}{5}\mathbf{u} = \langle \frac{3}{5}(3), \frac{3}{5}(-2) \rangle = \langle \frac{9}{5}, -\frac{6}{5} \rangle$
 $\frac{4}{5}\mathbf{v} = \langle \frac{4}{5}(-2), \frac{4}{5}(5) \rangle = \langle -\frac{8}{5}, 4 \rangle$
 $\frac{3}{5}\mathbf{u} + \frac{4}{5}\mathbf{v} = \langle \frac{9}{5} + (-\frac{8}{5}), -\frac{6}{5} + 4 \rangle = \langle \frac{1}{5}, \frac{14}{5} \rangle$
 (b) $\sqrt{(\frac{1}{5})^2 + (\frac{14}{5})^2} = \frac{\sqrt{197}}{5}$
8. (a) $-\frac{5}{13}\mathbf{u} = \langle -\frac{5}{13}(3), -\frac{5}{13}(-2) \rangle = \langle -\frac{15}{13}, \frac{10}{13} \rangle$
 $\frac{12}{13}\mathbf{v} = \langle \frac{12}{13}(-2), \frac{12}{13}(5) \rangle = \langle -\frac{24}{13}, \frac{60}{13} \rangle$
 $-\frac{5}{13}\mathbf{u} + \frac{12}{13}\mathbf{v} = \langle -\frac{15}{13} + (-\frac{24}{13}), \frac{10}{13} + \frac{60}{13} \rangle = \langle -3, \frac{70}{13} \rangle$
 (b) $\sqrt{(-3)^2 + (\frac{70}{13})^2} = \frac{\sqrt{6421}}{13}$
9. $\langle 2 - 1, -1 - 3 \rangle = \langle 1, -4 \rangle$
10. $\langle \frac{2+(-4)}{2} - 0, \frac{-1+3}{2} - 0 \rangle = \langle -1, 1 \rangle$
11. $\langle 0 - 2, 0 - 3 \rangle = \langle -2, -3 \rangle$
12. $\vec{AB} = \langle 2 - 1, 0 - (-1) \rangle = \langle 1, 1 \rangle$, $\vec{CD} = \langle -2 - (-1), 2 - 3 \rangle = \langle -1, -1 \rangle$, $\vec{AB} + \vec{CD} = \langle 0, 0 \rangle$
13. $\langle \cos \frac{2\pi}{3}, \sin \frac{2\pi}{3} \rangle = \langle -\frac{1}{2}, \frac{\sqrt{3}}{2} \rangle$
14. $\langle \cos (-\frac{3\pi}{4}), \sin (-\frac{3\pi}{4}) \rangle = \langle -\frac{1}{\sqrt{2}}, -\frac{1}{\sqrt{2}} \rangle$
15. This is the unit vector which makes an angle of $120^\circ + 90^\circ = 210^\circ$ with the positive x-axis;
 $\langle \cos 210^\circ, \sin 210^\circ \rangle = \langle -\frac{\sqrt{3}}{2}, -\frac{1}{2} \rangle$
16. $\langle \cos 135^\circ, \sin 135^\circ \rangle = \langle -\frac{1}{\sqrt{2}}, \frac{1}{\sqrt{2}} \rangle$
17. $\vec{P_1P_2} = (2 - 5)\mathbf{i} + (9 - 7)\mathbf{j} + (-2 - (-1))\mathbf{k} = -3\mathbf{i} + 2\mathbf{j} - \mathbf{k}$
18. $\vec{P_1P_2} = (-3 - 1)\mathbf{i} + (0 - 2)\mathbf{j} + (5 - 0)\mathbf{k} = -4\mathbf{i} - 2\mathbf{j} + 5\mathbf{k}$
19. $\vec{AB} = (-10 - (-7))\mathbf{i} + (8 - (-8))\mathbf{j} + (1 - 1)\mathbf{k} = -3\mathbf{i} + 16\mathbf{j}$
20. $\vec{AB} = (-1 - 1)\mathbf{i} + (4 - 0)\mathbf{j} + (5 - 3)\mathbf{k} = -2\mathbf{i} + 4\mathbf{j} + 2\mathbf{k}$
21. $5\mathbf{u} - \mathbf{v} = 5\langle 1, 1, -1 \rangle - \langle 2, 0, 3 \rangle = \langle 5, 5, -5 \rangle - \langle 2, 0, 3 \rangle = \langle 5 - 2, 5 - 0, -5 - 3 \rangle = \langle 3, 5, -8 \rangle = 3\mathbf{i} + 5\mathbf{j} - 8\mathbf{k}$
22. $-2\mathbf{u} + 3\mathbf{v} = -2\langle -1, 0, 2 \rangle + 3\langle 1, 1, 1 \rangle = \langle 2, 0, -4 \rangle + \langle 3, 3, 3 \rangle = \langle 5, 3, -1 \rangle = 5\mathbf{i} + 3\mathbf{j} - \mathbf{k}$

23. The vector \mathbf{v} is horizontal and 1 in. long. The vectors \mathbf{u} and \mathbf{w} are $\frac{1}{16}$ in. long. \mathbf{w} is vertical and \mathbf{u} makes a 45° angle with the horizontal. All vectors must be drawn to scale.

(a)

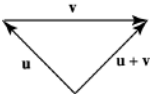

(b)

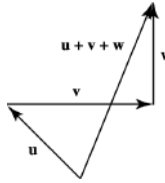

(c)

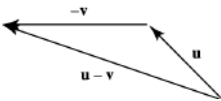

(d)

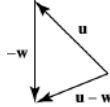

24. The angle between the vectors is 120° and vector \mathbf{u} is horizontal. They are all 1 in. long. Draw to scale.

(a)

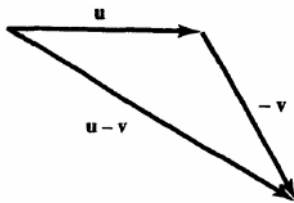

(b)

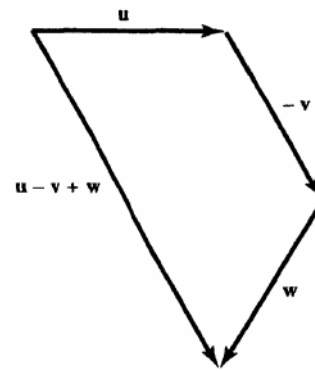

(c)

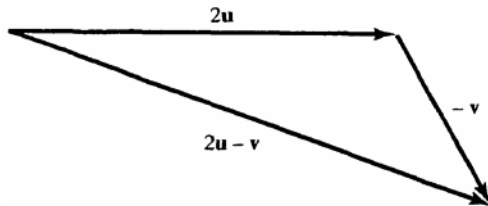

(d)

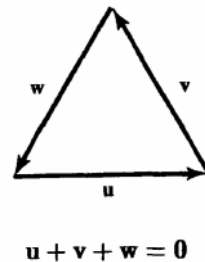

25. length = $|2\mathbf{i} + \mathbf{j} - 2\mathbf{k}| = \sqrt{2^2 + 1^2 + (-2)^2} = 3$, the direction is $\frac{2}{3}\mathbf{i} + \frac{1}{3}\mathbf{j} - \frac{2}{3}\mathbf{k} \Rightarrow 2\mathbf{i} + \mathbf{j} - 2\mathbf{k} = 3\left(\frac{2}{3}\mathbf{i} + \frac{1}{3}\mathbf{j} - \frac{2}{3}\mathbf{k}\right)$

26. length = $|9\mathbf{i} - 2\mathbf{j} + 6\mathbf{k}| = \sqrt{81 + 4 + 36} = 11$, the direction is $\frac{9}{11}\mathbf{i} - \frac{2}{11}\mathbf{j} + \frac{6}{11}\mathbf{k} \Rightarrow 9\mathbf{i} - 2\mathbf{j} + 6\mathbf{k} = 11\left(\frac{9}{11}\mathbf{i} - \frac{2}{11}\mathbf{j} + \frac{6}{11}\mathbf{k}\right)$

27. length = $|5\mathbf{k}| = \sqrt{25} = 5$, the direction is $\mathbf{k} \Rightarrow 5\mathbf{k} = 5(\mathbf{k})$

28. length = $|\frac{3}{5}\mathbf{i} + \frac{4}{5}\mathbf{k}| = \sqrt{\frac{9}{25} + \frac{16}{25}} = 1$, the direction is $\frac{3}{5}\mathbf{i} + \frac{4}{5}\mathbf{k} \Rightarrow \frac{3}{5}\mathbf{i} + \frac{4}{5}\mathbf{k} = 1\left(\frac{3}{5}\mathbf{i} + \frac{4}{5}\mathbf{k}\right)$

29. length = $|\frac{1}{\sqrt{6}}\mathbf{i} - \frac{1}{\sqrt{6}}\mathbf{j} - \frac{1}{\sqrt{6}}\mathbf{k}| = \sqrt{3\left(\frac{1}{\sqrt{6}}\right)^2} = \sqrt{\frac{1}{2}}$, the direction is $\frac{1}{\sqrt{3}}\mathbf{i} - \frac{1}{\sqrt{3}}\mathbf{j} - \frac{1}{\sqrt{3}}\mathbf{k} \Rightarrow \frac{1}{\sqrt{6}}\mathbf{i} - \frac{1}{\sqrt{6}}\mathbf{j} - \frac{1}{\sqrt{6}}\mathbf{k} = \sqrt{\frac{1}{2}}\left(\frac{1}{\sqrt{3}}\mathbf{i} - \frac{1}{\sqrt{3}}\mathbf{j} - \frac{1}{\sqrt{3}}\mathbf{k}\right)$

30. $\text{length} = \left| \frac{1}{\sqrt{3}}\mathbf{i} + \frac{1}{\sqrt{3}}\mathbf{j} + \frac{1}{\sqrt{3}}\mathbf{k} \right| = \sqrt{3 \left(\frac{1}{\sqrt{3}} \right)^2} = 1$, the direction is $\frac{1}{\sqrt{3}}\mathbf{i} + \frac{1}{\sqrt{3}}\mathbf{j} + \frac{1}{\sqrt{3}}\mathbf{k}$
 $\Rightarrow \frac{1}{\sqrt{3}}\mathbf{i} + \frac{1}{\sqrt{3}}\mathbf{j} + \frac{1}{\sqrt{3}}\mathbf{k} = 1 \left(\frac{1}{\sqrt{3}}\mathbf{i} + \frac{1}{\sqrt{3}}\mathbf{j} + \frac{1}{\sqrt{3}}\mathbf{k} \right)$

31. (a) $2\mathbf{i}$ (b) $-\sqrt{3}\mathbf{k}$ (c) $\frac{3}{10}\mathbf{j} + \frac{2}{5}\mathbf{k}$ (d) $6\mathbf{i} - 2\mathbf{j} + 3\mathbf{k}$

32. (a) $-7\mathbf{j}$ (b) $-\frac{3\sqrt{2}}{5}\mathbf{i} - \frac{4\sqrt{2}}{5}\mathbf{k}$ (c) $\frac{1}{4}\mathbf{i} - \frac{1}{3}\mathbf{j} - \mathbf{k}$ (d) $\frac{a}{\sqrt{2}}\mathbf{i} + \frac{a}{\sqrt{3}}\mathbf{j} - \frac{a}{\sqrt{6}}\mathbf{k}$

33. $|\mathbf{v}| = \sqrt{12^2 + 5^2} = \sqrt{169} = 13$; $\frac{\mathbf{v}}{|\mathbf{v}|} = \frac{1}{13}\mathbf{v} = \frac{1}{13}(12\mathbf{i} - 5\mathbf{k}) \Rightarrow$ the desired vector is $\frac{7}{13}(12\mathbf{i} - 5\mathbf{k})$

34. $|\mathbf{v}| = \sqrt{\frac{1}{4} + \frac{1}{4} + \frac{1}{4}} = \frac{\sqrt{3}}{2}$; $\frac{\mathbf{v}}{|\mathbf{v}|} = \frac{1}{\sqrt{3}}\mathbf{i} - \frac{1}{\sqrt{3}}\mathbf{j} - \frac{1}{\sqrt{3}}\mathbf{k} \Rightarrow$ the desired vector is $-3 \left(\frac{1}{\sqrt{3}}\mathbf{i} - \frac{1}{\sqrt{3}}\mathbf{j} - \frac{1}{\sqrt{3}}\mathbf{k} \right)$
 $= -\sqrt{3}\mathbf{i} + \sqrt{3}\mathbf{j} + \sqrt{3}\mathbf{k}$

35. (a) $3\mathbf{i} + 4\mathbf{j} - 5\mathbf{k} = 5\sqrt{2} \left(\frac{3}{5\sqrt{2}}\mathbf{i} + \frac{4}{5\sqrt{2}}\mathbf{j} - \frac{1}{\sqrt{2}}\mathbf{k} \right) \Rightarrow$ the direction is $\frac{3}{5\sqrt{2}}\mathbf{i} + \frac{4}{5\sqrt{2}}\mathbf{j} - \frac{1}{\sqrt{2}}\mathbf{k}$
 (b) the midpoint is $\left(\frac{1}{2}, 3, \frac{5}{2} \right)$

36. (a) $3\mathbf{i} - 6\mathbf{j} + 2\mathbf{k} = 7 \left(\frac{3}{7}\mathbf{i} - \frac{6}{7}\mathbf{j} + \frac{2}{7}\mathbf{k} \right) \Rightarrow$ the direction is $\frac{3}{7}\mathbf{i} - \frac{6}{7}\mathbf{j} + \frac{2}{7}\mathbf{k}$
 (b) the midpoint is $\left(\frac{5}{2}, 1, 6 \right)$

37. (a) $-\mathbf{i} - \mathbf{j} - \mathbf{k} = \sqrt{3} \left(-\frac{1}{\sqrt{3}}\mathbf{i} - \frac{1}{\sqrt{3}}\mathbf{j} - \frac{1}{\sqrt{3}}\mathbf{k} \right) \Rightarrow$ the direction is $-\frac{1}{\sqrt{3}}\mathbf{i} - \frac{1}{\sqrt{3}}\mathbf{j} - \frac{1}{\sqrt{3}}\mathbf{k}$
 (b) the midpoint is $\left(\frac{5}{2}, \frac{7}{2}, \frac{9}{2} \right)$

38. (a) $2\mathbf{i} - 2\mathbf{j} - 2\mathbf{k} = 2\sqrt{3} \left(\frac{1}{\sqrt{3}}\mathbf{i} - \frac{1}{\sqrt{3}}\mathbf{j} - \frac{1}{\sqrt{3}}\mathbf{k} \right) \Rightarrow$ the direction is $\frac{1}{\sqrt{3}}\mathbf{i} - \frac{1}{\sqrt{3}}\mathbf{j} - \frac{1}{\sqrt{3}}\mathbf{k}$
 (b) the midpoint is $(1, -1, -1)$

39. $\vec{AB} = (5 - a)\mathbf{i} + (1 - b)\mathbf{j} + (3 - c)\mathbf{k} = \mathbf{i} + 4\mathbf{j} - 2\mathbf{k} \Rightarrow 5 - a = 1, 1 - b = 4, \text{ and } 3 - c = -2 \Rightarrow a = 4, b = -3, \text{ and } c = 5 \Rightarrow$ A is the point $(4, -3, 5)$

40. $\vec{AB} = (a + 2)\mathbf{i} + (b + 3)\mathbf{j} + (c - 6)\mathbf{k} = -7\mathbf{i} + 3\mathbf{j} + 8\mathbf{k} \Rightarrow a + 2 = -7, b + 3 = 3, \text{ and } c - 6 = 8 \Rightarrow a = -9, b = 0, \text{ and } c = 14 \Rightarrow$ B is the point $(-9, 0, 14)$

41. $2\mathbf{i} + \mathbf{j} = a(\mathbf{i} + \mathbf{j}) + b(\mathbf{i} - \mathbf{j}) = (a + b)\mathbf{i} + (a - b)\mathbf{j} \Rightarrow a + b = 2 \text{ and } a - b = 1 \Rightarrow 2a = 3 \Rightarrow a = \frac{3}{2} \text{ and } b = a - 1 = \frac{1}{2}$

42. $\mathbf{i} - 2\mathbf{j} = a(2\mathbf{i} + 3\mathbf{j}) + b(\mathbf{i} + \mathbf{j}) = (2a + b)\mathbf{i} + (3a + b)\mathbf{j} \Rightarrow 2a + b = 1 \text{ and } 3a + b = -2 \Rightarrow a = -3 \text{ and } b = 1 - 2a = 7 \Rightarrow \mathbf{u}_1 = a(2\mathbf{i} + 3\mathbf{j}) = -6\mathbf{i} - 9\mathbf{j} \text{ and } \mathbf{u}_2 = b(\mathbf{i} + \mathbf{j}) = 7\mathbf{i} + 7\mathbf{j}$

43. If $|x|$ is the magnitude of the x-component, then $\cos 30^\circ = \frac{|x|}{|F|} \Rightarrow |x| = |F| \cos 30^\circ = (10) \left(\frac{\sqrt{3}}{2} \right) = 5\sqrt{3} \text{ lb}$
 $\Rightarrow \mathbf{F}_x = 5\sqrt{3}\mathbf{i}$;

if $|y|$ is the magnitude of the y-component, then $\sin 30^\circ = \frac{|y|}{|F|} \Rightarrow |y| = |F| \sin 30^\circ = (10) \left(\frac{1}{2} \right) = 5 \text{ lb} \Rightarrow \mathbf{F}_y = 5\mathbf{j}$.

44. If $|x|$ is the magnitude of the x-component, then $\cos 45^\circ = \frac{|x|}{|F|} \Rightarrow |x| = |F| \cos 45^\circ = (12) \left(\frac{\sqrt{2}}{2}\right) = 6\sqrt{2}$ lb
 $\Rightarrow \mathbf{F}_x = -6\sqrt{2}\mathbf{i}$ (the negative sign is indicated by the diagram)
 if $|y|$ is the magnitude of the y-component, then $\sin 45^\circ = \frac{|y|}{|F|} \Rightarrow |y| = |F| \sin 45^\circ = (12) \left(\frac{\sqrt{2}}{2}\right) = 6\sqrt{2}$ lb
 $\Rightarrow \mathbf{F}_y = -6\sqrt{2}\mathbf{j}$ (the negative sign is indicated by the diagram)

45. 25° west of north is $90^\circ + 25^\circ = 115^\circ$ north of east. $800\langle \cos 115^\circ, \sin 115^\circ \rangle \approx \langle -338.095, 725.046 \rangle$

46. 10° east of south is $270^\circ + 10^\circ = 280^\circ$ "north" of east. $600\langle \cos 280^\circ, \sin 280^\circ \rangle \approx \langle 104.189, -590.885 \rangle$

47. (a) The tree is located at the tip of the vector $\vec{OP} = (5 \cos 60^\circ)\mathbf{i} + (5 \sin 60^\circ)\mathbf{j} = \frac{5}{2}\mathbf{i} + \frac{5\sqrt{3}}{2}\mathbf{j} \Rightarrow P = \left(\frac{5}{2}, \frac{5\sqrt{3}}{2}\right)$

(b) The telephone pole is located at the point Q, which is the tip of the vector $\vec{OP} + \vec{PQ}$
 $= \left(\frac{5}{2}\mathbf{i} + \frac{5\sqrt{3}}{2}\mathbf{j}\right) + (10 \cos 315^\circ)\mathbf{i} + (10 \sin 315^\circ)\mathbf{j} = \left(\frac{5}{2} + \frac{10\sqrt{2}}{2}\right)\mathbf{i} + \left(\frac{5\sqrt{3}}{2} - \frac{10\sqrt{2}}{2}\right)\mathbf{j}$
 $\Rightarrow Q = \left(\frac{5+10\sqrt{2}}{2}, \frac{5\sqrt{3}-10\sqrt{2}}{2}\right)$

48. Let $t = \frac{q}{p+q}$ and $s = \frac{p}{p+q}$. Choose T on \vec{OP}_1 so that \vec{TQ} is parallel to \vec{OP}_2 , so that $\triangle TP_1Q$ is similar to $\triangle OP_1P_2$. Then $\frac{|OT|}{|OP_1|} = t \Rightarrow \vec{OT} = t\vec{OP}_1$ so that $T = (tx_1, ty_1, tz_1)$.

Also, $\frac{|TQ|}{|OP_2|} = s \Rightarrow \vec{TQ} = s\vec{OP}_2 = s\langle x_2, y_2, z_2 \rangle$.

Letting $Q = (x, y, z)$, we have that

$$\vec{TQ} = \langle x - tx_1, y - ty_1, z - tz_1 \rangle = s\langle x_2, y_2, z_2 \rangle$$

Thus $x = tx_1 + sx_2, y = ty_1 + sy_2, z = tz_1 + sz_2$.

(Note that if Q is the midpoint, then $\frac{p}{q} = 1$ and $t = s = \frac{1}{2}$)

so that $x = \frac{1}{2}x_1 + \frac{1}{2}x_2 = \frac{x_1+x_2}{2}, y = \frac{y_1+y_2}{2}, z = \frac{z_1+z_2}{2}$ so that this result agrees with the midpoint formula.)

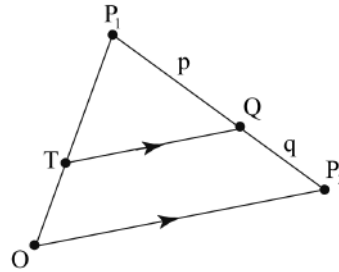

49. (a) the midpoint of AB is $M\left(\frac{5}{2}, \frac{5}{2}, 0\right)$ and $\vec{CM} = \left(\frac{5}{2} - 1\right)\mathbf{i} + \left(\frac{5}{2} - 1\right)\mathbf{j} + (0 - 3)\mathbf{k} = \frac{3}{2}\mathbf{i} + \frac{3}{2}\mathbf{j} - 3\mathbf{k}$
 (b) the desired vector is $\left(\frac{2}{3}\right)\vec{CM} = \frac{2}{3}\left(\frac{3}{2}\mathbf{i} + \frac{3}{2}\mathbf{j} - 3\mathbf{k}\right) = \mathbf{i} + \mathbf{j} - 2\mathbf{k}$
 (c) the vector whose sum is the vector from the origin to C and the result of part (b) will terminate at the center of mass \Rightarrow the terminal point of $(\mathbf{i} + \mathbf{j} + 3\mathbf{k}) + (\mathbf{i} + \mathbf{j} - 2\mathbf{k}) = 2\mathbf{i} + 2\mathbf{j} + \mathbf{k}$ is the point $(2, 2, 1)$, which is the location of the center of mass

50. The midpoint of AB is $M\left(\frac{3}{2}, 0, \frac{5}{2}\right)$ and $\left(\frac{2}{3}\right)\vec{CM} = \frac{2}{3}\left[\left(\frac{3}{2} + 1\right)\mathbf{i} + (0 - 2)\mathbf{j} + \left(\frac{5}{2} + 1\right)\mathbf{k}\right] = \frac{2}{3}\left(\frac{5}{2}\mathbf{i} - 2\mathbf{j} + \frac{7}{2}\mathbf{k}\right)$
 $= \frac{5}{3}\mathbf{i} - \frac{4}{3}\mathbf{j} + \frac{7}{3}\mathbf{k}$. The terminal point of $\left(\frac{5}{3}\mathbf{i} - \frac{4}{3}\mathbf{j} + \frac{7}{3}\mathbf{k}\right) + \vec{OC} = \left(\frac{5}{3}\mathbf{i} - \frac{4}{3}\mathbf{j} + \frac{7}{3}\mathbf{k}\right) + (-\mathbf{i} + 2\mathbf{j} - \mathbf{k})$
 $= \frac{2}{3}\mathbf{i} + \frac{2}{3}\mathbf{j} + \frac{4}{3}\mathbf{k}$ is the point $\left(\frac{2}{3}, \frac{2}{3}, \frac{4}{3}\right)$ which is the location of the intersection of the medians.

51. Without loss of generality we identify the vertices of the quadrilateral such that $A(0, 0, 0), B(x_b, 0, 0), C(x_c, y_c, 0)$ and $D(x_d, y_d, z_d) \Rightarrow$ the midpoint of AB is $M_{AB}\left(\frac{x_b}{2}, 0, 0\right)$, the midpoint of BC is $M_{BC}\left(\frac{x_b+x_c}{2}, \frac{y_c}{2}, 0\right)$, the midpoint of CD is $M_{CD}\left(\frac{x_c+x_d}{2}, \frac{y_c+y_d}{2}, \frac{z_d}{2}\right)$ and the midpoint of AD is $M_{AD}\left(\frac{x_d}{2}, \frac{y_d}{2}, \frac{z_d}{2}\right) \Rightarrow$ the midpoint of $M_{AB}M_{CD}$ is $\left(\frac{\frac{x_b}{2} + \frac{x_c+x_d}{2}}{2}, \frac{y_c+y_d}{4}, \frac{z_d}{4}\right)$ which is the same as the midpoint of $M_{AD}M_{BC} = \left(\frac{\frac{x_b+x_c}{2} + \frac{x_d}{2}}{2}, \frac{y_c+y_d}{4}, \frac{z_d}{4}\right)$.

52. Let $V_1, V_2, V_3, \dots, V_n$ be the vertices of a regular n -sided polygon and \mathbf{v}_i denote the vector from the center to V_i for $i = 1, 2, 3, \dots, n$. If $\mathbf{S} = \sum_{i=1}^n \mathbf{v}_i$ and the polygon is rotated through an angle of $\frac{i(2\pi)}{n}$ where

$i = 1, 2, 3, \dots, n$, then \mathbf{S} would remain the same. Since the vector \mathbf{S} does not change with these rotations we conclude that $\mathbf{S} = \mathbf{0}$.

53. Without loss of generality we can coordinatize the vertices of the triangle such that $A(0, 0)$, $B(b, 0)$ and $C(x_c, y_c) \Rightarrow a$ is located at $(\frac{b+x_c}{2}, \frac{y_c}{2})$, b is at $(\frac{x_c}{2}, \frac{y_c}{2})$ and c is at $(\frac{b}{2}, 0)$. Therefore, $\vec{Aa} = (\frac{b}{2} + \frac{x_c}{2})\mathbf{i} + (\frac{y_c}{2})\mathbf{j}$, $\vec{Bb} = (\frac{x_c}{2} - b)\mathbf{i} + (\frac{y_c}{2})\mathbf{j}$, and $\vec{Cc} = (\frac{b}{2} - x_c)\mathbf{i} + (-y_c)\mathbf{j} \Rightarrow \vec{Aa} + \vec{Bb} + \vec{Cc} = \mathbf{0}$.

54. Let \mathbf{u} be any unit vector in the plane. If \mathbf{u} is positioned so that its initial point is at the origin and terminal point is at (x, y) , then \mathbf{u} makes an angle θ with \mathbf{i} , measured in the counter-clockwise direction. Since $|\mathbf{u}| = 1$, we have that $x = \cos \theta$ and $y = \sin \theta$. Thus $\mathbf{u} = \cos \theta \mathbf{i} + \sin \theta \mathbf{j}$. Since \mathbf{u} was assumed to be any unit vector in the plane, this holds for every unit vector in the plane.

12.3 THE DOT PRODUCT

NOTE: In Exercises 1-8 below we calculate $\text{proj}_{\mathbf{v}} \mathbf{u}$ as the vector $(\frac{|\mathbf{u}| \cos \theta}{|\mathbf{v}|}) \mathbf{v}$, so the scalar multiplier of \mathbf{v} is the number in column 5 divided by the number in column 2.

	$\mathbf{v} \cdot \mathbf{u}$	$ \mathbf{v} $	$ \mathbf{u} $	$\cos \theta$	$ \mathbf{u} \cos \theta$	$\text{proj}_{\mathbf{v}} \mathbf{u}$
1.	-25	5	5	-1	-5	$-2\mathbf{i} + 4\mathbf{j} - \sqrt{5}\mathbf{k}$
2.	3	1	13	$\frac{3}{13}$	3	$3(\frac{3}{5}\mathbf{i} + \frac{4}{5}\mathbf{k})$
3.	25	15	5	$\frac{1}{3}$	$\frac{5}{3}$	$\frac{1}{9}(10\mathbf{i} + 11\mathbf{j} - 2\mathbf{k})$
4.	13	15	3	$\frac{13}{45}$	$\frac{13}{15}$	$\frac{13}{225}(2\mathbf{i} + 10\mathbf{j} - 11\mathbf{k})$
5.	2	$\sqrt{34}$	$\sqrt{3}$	$\frac{2}{\sqrt{3}\sqrt{34}}$	$\frac{2}{\sqrt{34}}$	$\frac{1}{17}(5\mathbf{j} - 3\mathbf{k})$
6.	$\sqrt{3} - \sqrt{2}$	$\sqrt{2}$	3	$\frac{\sqrt{3} - \sqrt{2}}{3\sqrt{2}}$	$\frac{\sqrt{3} - \sqrt{2}}{\sqrt{2}}$	$\frac{\sqrt{3} - \sqrt{2}}{2}(-\mathbf{i} + \mathbf{j})$
7.	$10 + \sqrt{17}$	$\sqrt{26}$	$\sqrt{21}$	$\frac{10 + \sqrt{17}}{\sqrt{546}}$	$\frac{10 + \sqrt{17}}{\sqrt{26}}$	$\frac{10 + \sqrt{17}}{\sqrt{26}}(-5\mathbf{i} + \mathbf{j})$
8.	$\frac{1}{6}$	$\frac{\sqrt{30}}{6}$	$\frac{\sqrt{30}}{6}$	$\frac{1}{5}$	$\frac{1}{\sqrt{30}}$	$\frac{1}{5}\langle \frac{1}{\sqrt{2}}, \frac{1}{\sqrt{3}} \rangle$
9.	$\theta = \cos^{-1}\left(\frac{\mathbf{u} \cdot \mathbf{v}}{ \mathbf{u} \mathbf{v} }\right) = \cos^{-1}\left(\frac{(2)(1) + (1)(2) + (0)(-1)}{\sqrt{2^2 + 1^2 + 0^2}\sqrt{1^2 + 2^2 + (-1)^2}}\right) = \cos^{-1}\left(\frac{4}{\sqrt{5}\sqrt{6}}\right) = \cos^{-1}\left(\frac{4}{\sqrt{30}}\right) \approx 0.75 \text{ rad}$					
10.	$\theta = \cos^{-1}\left(\frac{\mathbf{u} \cdot \mathbf{v}}{ \mathbf{u} \mathbf{v} }\right) = \cos^{-1}\left(\frac{(2)(3) + (-2)(0) + (1)(4)}{\sqrt{2^2 + (-2)^2 + 1^2}\sqrt{3^2 + 0^2 + 4^2}}\right) = \cos^{-1}\left(\frac{10}{\sqrt{9}\sqrt{25}}\right) = \cos^{-1}\left(\frac{2}{3}\right) \approx 0.84 \text{ rad}$					
11.	$\theta = \cos^{-1}\left(\frac{\mathbf{u} \cdot \mathbf{v}}{ \mathbf{u} \mathbf{v} }\right) = \cos^{-1}\left(\frac{(\sqrt{3})(\sqrt{3}) + (-7)(1) + (0)(-2)}{\sqrt{(\sqrt{3})^2 + (-7)^2 + 0^2}\sqrt{(\sqrt{3})^2 + (1)^2 + (-2)^2}}\right) = \cos^{-1}\left(\frac{3-7}{\sqrt{52}\sqrt{8}}\right)$					

$$= \cos^{-1} \left(\frac{-1}{\sqrt{26}} \right) \approx 1.77 \text{ rad}$$

$$\begin{aligned} 12. \theta &= \cos^{-1} \left(\frac{\mathbf{u} \cdot \mathbf{v}}{|\mathbf{u}| |\mathbf{v}|} \right) = \cos^{-1} \left(\frac{(1)(-1) + (\sqrt{2})(1) + (-\sqrt{2})(1)}{\sqrt{(1)^2 + (\sqrt{2})^2 + (-\sqrt{2})^2} \sqrt{(-1)^2 + (1)^2 + (1)^2}} \right) = \cos^{-1} \left(\frac{-1}{\sqrt{5}\sqrt{3}} \right) \\ &= \cos^{-1} \left(\frac{-1}{\sqrt{15}} \right) \approx 1.83 \text{ rad} \end{aligned}$$

$$13. \vec{AB} = \langle 3, 1 \rangle, \vec{BC} = \langle -1, -3 \rangle, \text{ and } \vec{AC} = \langle 2, -2 \rangle. \vec{BA} = \langle -3, -1 \rangle, \vec{CB} = \langle 1, 3 \rangle, \vec{CA} = \langle -2, 2 \rangle.$$

$$|\vec{AB}| = |\vec{BA}| = \sqrt{10}, |\vec{BC}| = |\vec{CB}| = \sqrt{10}, |\vec{AC}| = |\vec{CA}| = 2\sqrt{2},$$

$$\text{Angle at A} = \cos^{-1} \left(\frac{\vec{AB} \cdot \vec{AC}}{|\vec{AB}| |\vec{AC}|} \right) = \cos^{-1} \left(\frac{3(2) + 1(-2)}{(\sqrt{10})(2\sqrt{2})} \right) = \cos^{-1} \left(\frac{1}{\sqrt{5}} \right) \approx 63.435^\circ$$

$$\text{Angle at B} = \cos^{-1} \left(\frac{\vec{BC} \cdot \vec{BA}}{|\vec{BC}| |\vec{BA}|} \right) = \cos^{-1} \left(\frac{(-1)(-3) + (-3)(-1)}{(\sqrt{10})(\sqrt{10})} \right) = \cos^{-1} \left(\frac{3}{5} \right) \approx 53.130^\circ, \text{ and}$$

$$\text{Angle at C} = \cos^{-1} \left(\frac{\vec{CB} \cdot \vec{CA}}{|\vec{CB}| |\vec{CA}|} \right) = \cos^{-1} \left(\frac{1(-2) + 3(2)}{(\sqrt{10})(2\sqrt{2})} \right) = \cos^{-1} \left(\frac{1}{\sqrt{5}} \right) \approx 63.435^\circ$$

$$14. \vec{AC} = \langle 2, 4 \rangle \text{ and } \vec{BD} = \langle 4, -2 \rangle. \vec{AC} \cdot \vec{BD} = 2(4) + 4(-2) = 0, \text{ so the angle measures are all } 90^\circ.$$

$$15. (a) \cos \alpha = \frac{\mathbf{i} \cdot \mathbf{v}}{|\mathbf{i}| |\mathbf{v}|} = \frac{a}{|\mathbf{v}|}, \cos \beta = \frac{\mathbf{j} \cdot \mathbf{v}}{|\mathbf{j}| |\mathbf{v}|} = \frac{b}{|\mathbf{v}|}, \cos \gamma = \frac{\mathbf{k} \cdot \mathbf{v}}{|\mathbf{k}| |\mathbf{v}|} = \frac{c}{|\mathbf{v}|} \text{ and}$$

$$\cos^2 \alpha + \cos^2 \beta + \cos^2 \gamma = \left(\frac{a}{|\mathbf{v}|} \right)^2 + \left(\frac{b}{|\mathbf{v}|} \right)^2 + \left(\frac{c}{|\mathbf{v}|} \right)^2 = \frac{a^2 + b^2 + c^2}{|\mathbf{v}|^2} = \frac{|\mathbf{v}|^2}{|\mathbf{v}|^2} = 1$$

$$(b) |\mathbf{v}| = 1 \Rightarrow \cos \alpha = \frac{a}{|\mathbf{v}|} = a, \cos \beta = \frac{b}{|\mathbf{v}|} = b \text{ and } \cos \gamma = \frac{c}{|\mathbf{v}|} = c \text{ are the direction cosines of } \mathbf{v}$$

$$16. \mathbf{u} = 10\mathbf{i} + 2\mathbf{k} \text{ is parallel to the pipe in the north direction and } \mathbf{v} = 10\mathbf{j} + \mathbf{k} \text{ is parallel to the pipe in the east direction. The angle between the two pipes is } \theta = \cos^{-1} \left(\frac{\mathbf{u} \cdot \mathbf{v}}{|\mathbf{u}| |\mathbf{v}|} \right) = \cos^{-1} \left(\frac{2}{\sqrt{104}\sqrt{101}} \right) \approx 1.55 \text{ rad} \approx 88.88^\circ.$$

$$17. \mathbf{u} = \left(\frac{\mathbf{v} \cdot \mathbf{u}}{\mathbf{v} \cdot \mathbf{v}} \mathbf{v} \right) + \left(\mathbf{u} - \frac{\mathbf{v} \cdot \mathbf{u}}{\mathbf{v} \cdot \mathbf{v}} \mathbf{v} \right) = \frac{3}{2}(\mathbf{i} + \mathbf{j}) + [(3\mathbf{j} + 4\mathbf{k}) - \frac{3}{2}(\mathbf{i} + \mathbf{j})] = \left(\frac{3}{2}\mathbf{i} + \frac{3}{2}\mathbf{j} \right) + \left(-\frac{3}{2}\mathbf{i} + \frac{3}{2}\mathbf{j} + 4\mathbf{k} \right), \text{ where}$$

$$\mathbf{v} \cdot \mathbf{u} = 3 \text{ and } \mathbf{v} \cdot \mathbf{v} = 2$$

$$18. \mathbf{u} = \left(\frac{\mathbf{v} \cdot \mathbf{u}}{\mathbf{v} \cdot \mathbf{v}} \mathbf{v} \right) + \left(\mathbf{u} - \frac{\mathbf{v} \cdot \mathbf{u}}{\mathbf{v} \cdot \mathbf{v}} \mathbf{v} \right) = \frac{1}{2}\mathbf{v} + \left(\mathbf{u} - \frac{1}{2}\mathbf{v} \right) = \frac{1}{2}(\mathbf{i} + \mathbf{j}) + [(\mathbf{j} + \mathbf{k}) - \frac{1}{2}(\mathbf{i} + \mathbf{j})] = \left(\frac{1}{2}\mathbf{i} + \frac{1}{2}\mathbf{j} \right) + \left(-\frac{1}{2}\mathbf{i} + \frac{1}{2}\mathbf{j} + \mathbf{k} \right),$$

$$\text{where } \mathbf{v} \cdot \mathbf{u} = 1 \text{ and } \mathbf{v} \cdot \mathbf{v} = 2$$

$$19. \mathbf{u} = \left(\frac{\mathbf{v} \cdot \mathbf{u}}{\mathbf{v} \cdot \mathbf{v}} \mathbf{v} \right) + \left(\mathbf{u} - \frac{\mathbf{v} \cdot \mathbf{u}}{\mathbf{v} \cdot \mathbf{v}} \mathbf{v} \right) = \frac{14}{3}(\mathbf{i} + 2\mathbf{j} - \mathbf{k}) + [(8\mathbf{i} + 4\mathbf{j} - 12\mathbf{k}) - \left(\frac{14}{3}\mathbf{i} + \frac{28}{3}\mathbf{j} - \frac{14}{3}\mathbf{k} \right)]$$

$$= \left(\frac{14}{3}\mathbf{i} + \frac{28}{3}\mathbf{j} - \frac{14}{3}\mathbf{k} \right) + \left(\frac{10}{3}\mathbf{i} - \frac{16}{3}\mathbf{j} - \frac{22}{3}\mathbf{k} \right), \text{ where } \mathbf{v} \cdot \mathbf{u} = 28 \text{ and } \mathbf{v} \cdot \mathbf{v} = 6$$

$$20. \mathbf{u} = \left(\frac{\mathbf{v} \cdot \mathbf{u}}{\mathbf{v} \cdot \mathbf{v}} \mathbf{v} \right) + \left(\mathbf{u} - \frac{\mathbf{v} \cdot \mathbf{u}}{\mathbf{v} \cdot \mathbf{v}} \mathbf{v} \right) = \frac{1}{1}(\mathbf{A}) + [(\mathbf{i} + \mathbf{j} + \mathbf{k}) - \left(\frac{1}{1} \right) \mathbf{A}] = (\mathbf{i}) + (\mathbf{j} + \mathbf{k}), \text{ where } \mathbf{v} \cdot \mathbf{u} = 1 \text{ and } \mathbf{v} \cdot \mathbf{v} = 1; \text{ yes}$$

$$21. \text{The sum of two vectors of equal length is always orthogonal to their difference, as we can see from the equation}$$

$$(\mathbf{v}_1 + \mathbf{v}_2) \cdot (\mathbf{v}_1 - \mathbf{v}_2) = \mathbf{v}_1 \cdot \mathbf{v}_1 + \mathbf{v}_2 \cdot \mathbf{v}_1 - \mathbf{v}_1 \cdot \mathbf{v}_2 - \mathbf{v}_2 \cdot \mathbf{v}_2 = |\mathbf{v}_1|^2 - |\mathbf{v}_2|^2 = 0$$

$$22. \vec{CA} \cdot \vec{CB} = (-\mathbf{v} + (-\mathbf{u})) \cdot (-\mathbf{v} + \mathbf{u}) = \mathbf{v} \cdot \mathbf{v} - \mathbf{v} \cdot \mathbf{u} + \mathbf{u} \cdot \mathbf{v} - \mathbf{u} \cdot \mathbf{u} = |\mathbf{v}|^2 - |\mathbf{u}|^2 = 0 \text{ because } |\mathbf{u}| = |\mathbf{v}| \text{ since both equal the radius of the circle. Therefore, } \vec{CA} \text{ and } \vec{CB} \text{ are orthogonal.}$$

23. Let \mathbf{u} and \mathbf{v} be the sides of a rhombus \Rightarrow the diagonals are $\mathbf{d}_1 = \mathbf{u} + \mathbf{v}$ and $\mathbf{d}_2 = -\mathbf{u} + \mathbf{v}$
 $\Rightarrow \mathbf{d}_1 \cdot \mathbf{d}_2 = (\mathbf{u} + \mathbf{v}) \cdot (-\mathbf{u} + \mathbf{v}) = -\mathbf{u} \cdot \mathbf{u} + \mathbf{u} \cdot \mathbf{v} - \mathbf{v} \cdot \mathbf{u} + \mathbf{v} \cdot \mathbf{v} = |\mathbf{v}|^2 - |\mathbf{u}|^2 = 0$ because $|\mathbf{u}| = |\mathbf{v}|$, since a rhombus has equal sides.
24. Suppose the diagonals of a rectangle are perpendicular, and let \mathbf{u} and \mathbf{v} be the sides of a rectangle \Rightarrow the diagonals are $\mathbf{d}_1 = \mathbf{u} + \mathbf{v}$ and $\mathbf{d}_2 = -\mathbf{u} + \mathbf{v}$. Since the diagonals are perpendicular we have $\mathbf{d}_1 \cdot \mathbf{d}_2 = 0$
 $\Leftrightarrow (\mathbf{u} + \mathbf{v}) \cdot (-\mathbf{u} + \mathbf{v}) = -\mathbf{u} \cdot \mathbf{u} + \mathbf{u} \cdot \mathbf{v} - \mathbf{v} \cdot \mathbf{u} + \mathbf{v} \cdot \mathbf{v} = 0 \Leftrightarrow |\mathbf{v}|^2 - |\mathbf{u}|^2 = 0 \Leftrightarrow (|\mathbf{v}| + |\mathbf{u}|)(|\mathbf{v}| - |\mathbf{u}|) = 0$
 $\Leftrightarrow (|\mathbf{v}| + |\mathbf{u}|) = 0$ which is not possible, or $(|\mathbf{v}| - |\mathbf{u}|) = 0$ which is equivalent to $|\mathbf{v}| = |\mathbf{u}| \Rightarrow$ the rectangle is a square.
25. Clearly the diagonals of a rectangle are equal in length. What is not as obvious is the statement that equal diagonals happen only in a rectangle. We show this is true by letting the adjacent sides of a parallelogram be the vectors $(v_1\mathbf{i} + v_2\mathbf{j})$ and $(u_1\mathbf{i} + u_2\mathbf{j})$. The equal diagonals of the parallelogram are $\mathbf{d}_1 = (v_1\mathbf{i} + v_2\mathbf{j}) + (u_1\mathbf{i} + u_2\mathbf{j})$ and $\mathbf{d}_2 = (v_1\mathbf{i} + v_2\mathbf{j}) - (u_1\mathbf{i} + u_2\mathbf{j})$. Hence $|\mathbf{d}_1| = |\mathbf{d}_2| = |(v_1\mathbf{i} + v_2\mathbf{j}) + (u_1\mathbf{i} + u_2\mathbf{j})|$
 $= |(v_1\mathbf{i} + v_2\mathbf{j}) - (u_1\mathbf{i} + u_2\mathbf{j})| \Rightarrow |(v_1 + u_1)\mathbf{i} + (v_2 + u_2)\mathbf{j}| = |(v_1 - u_1)\mathbf{i} + (v_2 - u_2)\mathbf{j}|$
 $\Rightarrow \sqrt{(v_1 + u_1)^2 + (v_2 + u_2)^2} = \sqrt{(v_1 - u_1)^2 + (v_2 - u_2)^2} \Rightarrow v_1^2 + 2v_1u_1 + u_1^2 + v_2^2 + 2v_2u_2 + u_2^2$
 $= v_1^2 - 2v_1u_1 + u_1^2 + v_2^2 - 2v_2u_2 + u_2^2 \Rightarrow 2(v_1u_1 + v_2u_2) = -2(v_1u_1 + v_2u_2) \Rightarrow v_1u_1 + v_2u_2 = 0$
 $\Rightarrow (v_1\mathbf{i} + v_2\mathbf{j}) \cdot (u_1\mathbf{i} + u_2\mathbf{j}) = 0 \Rightarrow$ the vectors $(v_1\mathbf{i} + v_2\mathbf{j})$ and $(u_1\mathbf{i} + u_2\mathbf{j})$ are perpendicular and the parallelogram must be a rectangle.
26. If $|\mathbf{u}| = |\mathbf{v}|$ and $\mathbf{u} + \mathbf{v}$ is the indicated diagonal, then $(\mathbf{u} + \mathbf{v}) \cdot \mathbf{u} = \mathbf{u} \cdot \mathbf{u} + \mathbf{v} \cdot \mathbf{u} = |\mathbf{u}|^2 + \mathbf{v} \cdot \mathbf{u} = \mathbf{u} \cdot \mathbf{v} + |\mathbf{v}|^2$
 $= \mathbf{u} \cdot \mathbf{v} + \mathbf{v} \cdot \mathbf{v} = (\mathbf{u} + \mathbf{v}) \cdot \mathbf{v} \Rightarrow$ the angle $\cos^{-1}\left(\frac{(\mathbf{u} + \mathbf{v}) \cdot \mathbf{u}}{|\mathbf{u} + \mathbf{v}| |\mathbf{u}|}\right)$ between the diagonal and \mathbf{u} and the angle $\cos^{-1}\left(\frac{(\mathbf{u} + \mathbf{v}) \cdot \mathbf{v}}{|\mathbf{u} + \mathbf{v}| |\mathbf{v}|}\right)$ between the diagonal and \mathbf{v} are equal because the inverse cosine function is one-to-one. Therefore, the diagonal bisects the angle between \mathbf{u} and \mathbf{v} .
27. horizontal component: $1200 \cos(8^\circ) \approx 1188$ ft/s; vertical component: $1200 \sin(8^\circ) \approx 167$ ft/s
28. $|\mathbf{w}| \cos(33^\circ - 15^\circ) = 2.5$ lb, so $|\mathbf{w}| = \frac{2.5 \text{ lb}}{\cos 18^\circ}$. Then $\mathbf{w} = \frac{2.5 \text{ lb}}{\cos 18^\circ} \langle \cos 33^\circ, \sin 33^\circ \rangle \approx \langle 2.205, 1.432 \rangle$
29. (a) Since $|\cos \theta| \leq 1$, we have $|\mathbf{u} \cdot \mathbf{v}| = |\mathbf{u}| |\mathbf{v}| |\cos \theta| \leq |\mathbf{u}| |\mathbf{v}| (1) = |\mathbf{u}| |\mathbf{v}|$.
 (b) We have equality precisely when $|\cos \theta| = 1$ or when one or both of \mathbf{u} and \mathbf{v} is $\mathbf{0}$. In the case of nonzero vectors, we have equality when $\theta = 0$ or π , i.e., when the vectors are parallel.
30. $(x\mathbf{i} + y\mathbf{j}) \cdot \mathbf{v} = |x\mathbf{i} + y\mathbf{j}| |\mathbf{v}| \cos \theta \leq 0$ when $\frac{\pi}{2} \leq \theta \leq \pi$. This means (x, y) has to be a point whose position vector makes an angle with \mathbf{v} that is a right angle or bigger.

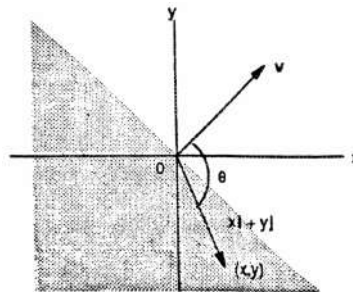

31. $\mathbf{v} \cdot \mathbf{u}_1 = (a\mathbf{u}_1 + b\mathbf{u}_2) \cdot \mathbf{u}_1 = a\mathbf{u}_1 \cdot \mathbf{u}_1 + b\mathbf{u}_2 \cdot \mathbf{u}_1 = a|\mathbf{u}_1|^2 + b(\mathbf{u}_2 \cdot \mathbf{u}_1) = a(1)^2 + b(0) = a$

32. No, \mathbf{v}_1 need not equal \mathbf{v}_2 . For example, $\mathbf{i} + \mathbf{j} \neq \mathbf{i} + 2\mathbf{j}$ but $\mathbf{i} \cdot (\mathbf{i} + \mathbf{j}) = \mathbf{i} \cdot \mathbf{i} + \mathbf{i} \cdot \mathbf{j} = 1 + 0 = 1$ and $\mathbf{i} \cdot (\mathbf{i} + 2\mathbf{j}) = \mathbf{i} \cdot \mathbf{i} + 2\mathbf{i} \cdot \mathbf{j} = 1 + 2 \cdot 0 = 1$.

33. $P(x_1, y_1) = P(x_1, \frac{c}{b} - \frac{a}{b}x_1)$ and $Q(x_2, y_2) = Q(x_2, \frac{c}{b} - \frac{a}{b}x_2)$ are any two points P and Q on the line with $b \neq 0$
 $\Rightarrow \vec{PQ} = (x_2 - x_1)\mathbf{i} + \frac{a}{b}(x_1 - x_2)\mathbf{j} \Rightarrow \vec{PQ} \cdot \mathbf{v} = [(x_2 - x_1)\mathbf{i} + \frac{a}{b}(x_1 - x_2)\mathbf{j}] \cdot (a\mathbf{i} + b\mathbf{j}) = a(x_2 - x_1) + b(\frac{a}{b})(x_1 - x_2)$
 $= 0 \Rightarrow \mathbf{v}$ is perpendicular to \vec{PQ} for $b \neq 0$. If $b = 0$, then $\mathbf{v} = a\mathbf{i}$ is perpendicular to the vertical line $ax = c$.
 Alternatively, the slope of \mathbf{v} is $\frac{b}{a}$ and the slope of the line $ax + by = c$ is $-\frac{a}{b}$, so the slopes are negative reciprocals \Rightarrow the vector \mathbf{v} and the line are perpendicular.

34. The slope of \mathbf{v} is $\frac{b}{a}$ and the slope of $bx - ay = c$ is $\frac{b}{a}$, provided that $a \neq 0$. If $a = 0$, then $\mathbf{v} = b\mathbf{j}$ is parallel to the vertical line $bx = c$. In either case, the vector \mathbf{v} is parallel to the line $ax - by = c$.

35. $\mathbf{v} = \mathbf{i} + 2\mathbf{j}$ is perpendicular to the line $x + 2y = c$;
 $P(2, 1)$ on the line $\Rightarrow 2 + 2 = c \Rightarrow x + 2y = 4$

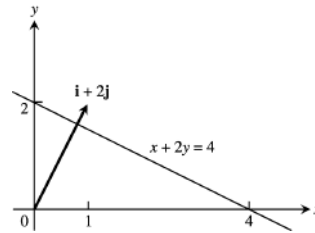

36. $\mathbf{v} = -2\mathbf{i} - \mathbf{j}$ is perpendicular to the line $-2x - y = c$;
 $P(-1, 2)$ on the line $\Rightarrow (-2)(-1) - 2 = c$
 $\Rightarrow -2x - y = 0$

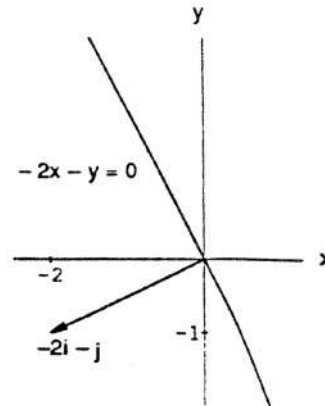

37. $\mathbf{v} = -2\mathbf{i} + \mathbf{j}$ is perpendicular to the line $-2x + y = c$;
 $P(-2, -7)$ on the line $\Rightarrow (-2)(-2) - 7 = c$
 $\Rightarrow -2x + y = -3$

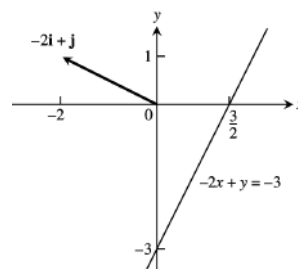

38. $\mathbf{v} = 2\mathbf{i} - 3\mathbf{j}$ is perpendicular to the line $2x - 3y = c$;
 $P(11, 10)$ on the line $\Rightarrow (2)(11) - (3)(10) = c$
 $\Rightarrow 2x - 3y = -8$

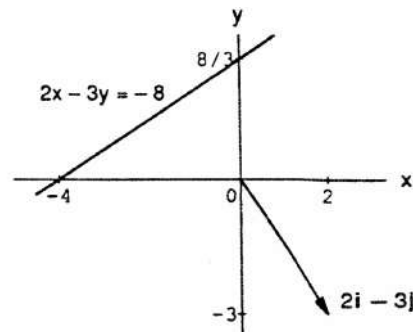

39. $\mathbf{v} = \mathbf{i} - \mathbf{j}$ is parallel to the line $-x - y = c$;
 $P(-2, 1)$ on the line $\Rightarrow -(-2) - 1 = c \Rightarrow -x - y = 1$
 or $x + y = -1$.

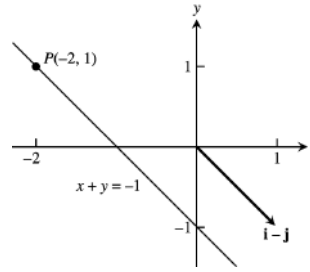

40. $\mathbf{v} = 2\mathbf{i} + 3\mathbf{j}$ is parallel to the line $3x - 2y = c$;
 $P(0, -2)$ on the line $\Rightarrow 0 - 2(-2) = c \Rightarrow 3x - 2y = 4$

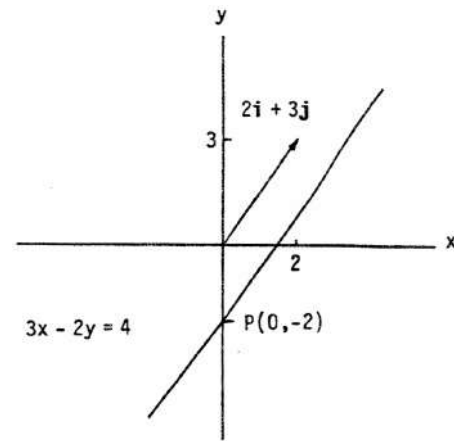

41. $\mathbf{v} = -\mathbf{i} - 2\mathbf{j}$ is parallel to the line $-2x + y = c$;
 $P(1, 2)$ on the line $\Rightarrow -2(1) + 2 = c \Rightarrow -2x - y = 0$
 or $2x - y = 0$.

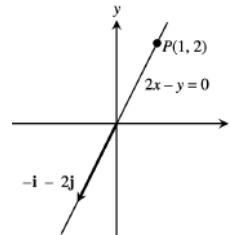

42. $\mathbf{v} = 3\mathbf{i} - 2\mathbf{j}$ is parallel to the line $-2x - 3y = c$;
 $P(1, 3)$ on the line $\Rightarrow (-2)(1) - (3)(3) = c$
 $\Rightarrow -2x - 3y = -11$ or $2x + 3y = 11$

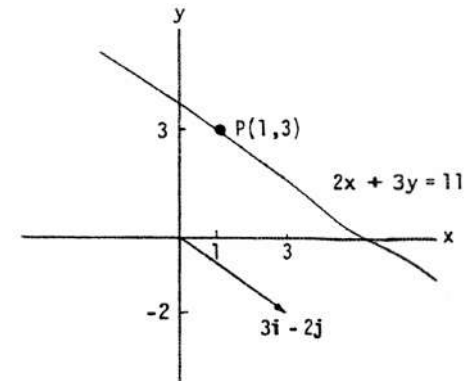

43. $P(0, 0), Q(1, 1)$ and $\mathbf{F} = 5\mathbf{j} \Rightarrow \vec{PQ} = \mathbf{i} + \mathbf{j}$ and $\mathbf{W} = \mathbf{F} \cdot \vec{PQ} = (5\mathbf{j}) \cdot (\mathbf{i} + \mathbf{j}) = 5 \text{ N} \cdot \text{m} = 5 \text{ J}$
44. $\mathbf{W} = |\mathbf{F}| (\text{distance}) \cos \theta = (602,148 \text{ N})(605 \text{ km})(\cos 0) = 364,299,540 \text{ N} \cdot \text{km} = (364,299,540)(1000) \text{ N} \cdot \text{m}$
 $= 3.6429954 \times 10^{11} \text{ J}$
45. $\mathbf{W} = |\mathbf{F}| |\vec{PQ}| \cos \theta = (200)(20)(\cos 30^\circ) = 2000\sqrt{3} = 3464.10 \text{ N} \cdot \text{m} = 3464.10 \text{ J}$

$$46. \mathbf{W} = |\mathbf{F}| \left| \vec{PQ} \right| \cos \theta = (1000)(5280)(\cos 60^\circ) = 2,640,000 \text{ ft} \cdot \text{lb}$$

In Exercises 47-52 we use the fact that $\mathbf{n} = a\mathbf{i} + b\mathbf{j}$ is normal to the line $ax + by = c$.

$$47. \mathbf{n}_1 = 3\mathbf{i} + \mathbf{j} \text{ and } \mathbf{n}_2 = 2\mathbf{i} - \mathbf{j} \Rightarrow \theta = \cos^{-1} \left(\frac{\mathbf{n}_1 \cdot \mathbf{n}_2}{|\mathbf{n}_1| |\mathbf{n}_2|} \right) = \cos^{-1} \left(\frac{6-1}{\sqrt{10}\sqrt{5}} \right) = \cos^{-1} \left(\frac{1}{\sqrt{2}} \right) = \frac{\pi}{4}$$

$$48. \mathbf{n}_1 = -\sqrt{3}\mathbf{i} + \mathbf{j} \text{ and } \mathbf{n}_2 = \sqrt{3}\mathbf{i} + \mathbf{j} \Rightarrow \theta = \cos^{-1} \left(\frac{\mathbf{n}_1 \cdot \mathbf{n}_2}{|\mathbf{n}_1| |\mathbf{n}_2|} \right) = \cos^{-1} \left(\frac{-3+1}{\sqrt{4}\sqrt{4}} \right) = \cos^{-1} \left(-\frac{1}{2} \right) = \frac{2\pi}{3}$$

$$49. \mathbf{n}_1 = \sqrt{3}\mathbf{i} - \mathbf{j} \text{ and } \mathbf{n}_2 = \mathbf{i} - \sqrt{3}\mathbf{j} \Rightarrow \theta = \cos^{-1} \left(\frac{\mathbf{n}_1 \cdot \mathbf{n}_2}{|\mathbf{n}_1| |\mathbf{n}_2|} \right) = \cos^{-1} \left(\frac{\sqrt{3}+\sqrt{3}}{\sqrt{4}\sqrt{4}} \right) = \cos^{-1} \left(\frac{\sqrt{3}}{2} \right) = \frac{\pi}{6}$$

$$50. \mathbf{n}_1 = \mathbf{i} + \sqrt{3}\mathbf{j} \text{ and } \mathbf{n}_2 = (1 - \sqrt{3})\mathbf{i} + (1 + \sqrt{3})\mathbf{j} \Rightarrow \theta = \cos^{-1} \left(\frac{\mathbf{n}_1 \cdot \mathbf{n}_2}{|\mathbf{n}_1| |\mathbf{n}_2|} \right) \\ = \cos^{-1} \left(\frac{1 - \sqrt{3} + \sqrt{3} + 3}{\sqrt{1+3}\sqrt{1-2\sqrt{3}+3+1+2\sqrt{3}+3}} \right) = \cos^{-1} \left(\frac{4}{2\sqrt{8}} \right) = \cos^{-1} \left(\frac{1}{\sqrt{2}} \right) = \frac{\pi}{4}$$

$$51. \mathbf{n}_1 = 3\mathbf{i} - 4\mathbf{j} \text{ and } \mathbf{n}_2 = \mathbf{i} - \mathbf{j} \Rightarrow \theta = \cos^{-1} \left(\frac{\mathbf{n}_1 \cdot \mathbf{n}_2}{|\mathbf{n}_1| |\mathbf{n}_2|} \right) = \cos^{-1} \left(\frac{3+4}{\sqrt{25}\sqrt{2}} \right) = \cos^{-1} \left(\frac{7}{5\sqrt{2}} \right) \approx 0.14 \text{ rad}$$

$$52. \mathbf{n}_1 = 12\mathbf{i} + 5\mathbf{j} \text{ and } \mathbf{n}_2 = 2\mathbf{i} - 2\mathbf{j} \Rightarrow \theta = \cos^{-1} \left(\frac{\mathbf{n}_1 \cdot \mathbf{n}_2}{|\mathbf{n}_1| |\mathbf{n}_2|} \right) = \cos^{-1} \left(\frac{24-10}{\sqrt{169}\sqrt{8}} \right) = \cos^{-1} \left(\frac{14}{26\sqrt{2}} \right) \approx 1.18 \text{ rad}$$

53. The angle between the corresponding normals is equal to the angle between the corresponding tangents. The points of intersection are $\left(-\frac{\sqrt{3}}{2}, \frac{3}{4}\right)$ and $\left(\frac{\sqrt{3}}{2}, \frac{3}{4}\right)$. At $\left(-\frac{\sqrt{3}}{2}, \frac{3}{4}\right)$ the tangent line for $f(x) = x^2$ is $y - \frac{3}{4} = f' \left(-\frac{\sqrt{3}}{2}\right) \left(x - \left(-\frac{\sqrt{3}}{2}\right)\right) \Rightarrow y = -\sqrt{3} \left(x + \frac{\sqrt{3}}{2}\right) + \frac{3}{4} \Rightarrow y = -\sqrt{3}x - \frac{3}{4}$, and the tangent line for $f(x) = \left(\frac{3}{2}\right) - x^2$ is $y - \frac{3}{4} = f' \left(-\frac{\sqrt{3}}{2}\right) \left(x - \left(-\frac{\sqrt{3}}{2}\right)\right) \Rightarrow y = \sqrt{3} \left(x + \frac{\sqrt{3}}{2}\right) + \frac{3}{4} = \sqrt{3}x + \frac{9}{4}$. The corresponding normals are $\mathbf{n}_1 = \sqrt{3}\mathbf{i} + \mathbf{j}$ and $\mathbf{n}_2 = -\sqrt{3}\mathbf{i} + \mathbf{j}$. The angle at $\left(-\frac{\sqrt{3}}{2}, \frac{3}{4}\right)$ is $\theta = \cos^{-1} \left(\frac{\mathbf{n}_1 \cdot \mathbf{n}_2}{|\mathbf{n}_1| |\mathbf{n}_2|} \right) = \cos^{-1} \left(\frac{-3+1}{\sqrt{4}\sqrt{4}} \right) = \cos^{-1} \left(-\frac{1}{2} \right) = \frac{2\pi}{3}$, the angle is $\frac{\pi}{3}$ and $\frac{2\pi}{3}$. At $\left(\frac{\sqrt{3}}{2}, \frac{3}{4}\right)$ the tangent line for $f(x) = x^2$ is $y = \sqrt{3} \left(x + \frac{\sqrt{3}}{2}\right) + \frac{3}{4} = \sqrt{3}x + \frac{9}{4}$ and the tangent line for $f(x) = \frac{3}{2} - x^2$ is $y = -\sqrt{3} \left(x + \frac{\sqrt{3}}{2}\right) + \frac{3}{4} = -\sqrt{3}x - \frac{3}{4}$. The corresponding normals are $\mathbf{n}_1 = -\sqrt{3}\mathbf{i} + \mathbf{j}$ and $\mathbf{n}_2 = \sqrt{3}\mathbf{i} + \mathbf{j}$. The angle at $\left(\frac{\sqrt{3}}{2}, \frac{3}{4}\right)$ is $\theta = \cos^{-1} \left(\frac{\mathbf{n}_1 \cdot \mathbf{n}_2}{|\mathbf{n}_1| |\mathbf{n}_2|} \right) = \cos^{-1} \left(\frac{-3+1}{\sqrt{4}\sqrt{4}} \right) = \cos^{-1} \left(-\frac{1}{2} \right) = \frac{2\pi}{3}$, the angle is $\frac{\pi}{3}$ and $\frac{2\pi}{3}$.

54. The points of intersection are $\left(0, \frac{\sqrt{3}}{2}\right)$ and $\left(0, -\frac{\sqrt{3}}{2}\right)$. The curve $x = \frac{3}{4} - y^2$ has derivative $\frac{dy}{dx} = -\frac{1}{2y} \Rightarrow$ the tangent line at $\left(0, \frac{\sqrt{3}}{2}\right)$ is $y - \frac{\sqrt{3}}{2} = -\frac{1}{\sqrt{3}}(x - 0) \Rightarrow \mathbf{n}_1 = \frac{1}{\sqrt{3}}\mathbf{i} + \mathbf{j}$ is normal to the curve at that point. The curve $x = y^2 - \frac{3}{4}$ has derivative $\frac{dy}{dx} = \frac{1}{2y} \Rightarrow$ the tangent line at $\left(0, \frac{\sqrt{3}}{2}\right)$ is $y - \frac{\sqrt{3}}{2} = \frac{1}{\sqrt{3}}(x - 0) \Rightarrow \mathbf{n}_2 = -\frac{1}{\sqrt{3}}\mathbf{i} + \mathbf{j}$ is normal to the curve. The angle between the curves is $\theta = \cos^{-1} \left(\frac{\mathbf{n}_1 \cdot \mathbf{n}_2}{|\mathbf{n}_1| |\mathbf{n}_2|} \right) = \cos^{-1} \left(\frac{-\frac{1}{3}+1}{\sqrt{\frac{1}{3}+1}\sqrt{\frac{1}{3}+1}} \right) = \cos^{-1} \left(\frac{\frac{2}{3}}{\left(\frac{2}{3}\right)} \right) = \cos^{-1} \left(\frac{1}{2} \right) = \frac{\pi}{3}$ and $\frac{2\pi}{3}$. Because of symmetry the angles between the curves at the two points of intersection are the same.

55. The curves intersect when $y = x^3 = (y^2)^3 = y^6 \Rightarrow y = 0$ or $y = 1$. The points of intersection are $(0, 0)$ and $(1, 1)$. Note that $y \geq 0$ since $y = y^6$. At $(0, 0)$ the tangent line for $y = x^3$ is $y = 0$ and the tangent line for

$y = \sqrt{x}$ is $x = 0$. Therefore, the angle of intersection at $(0, 0)$ is $\frac{\pi}{2}$. At $(1, 1)$ the tangent line for $y = x^3$ is $y = 3x - 2$ and the tangent line for $y = \sqrt{x}$ is $y = \frac{1}{2}x + \frac{1}{2}$. The corresponding normal vectors are $\mathbf{n}_1 = -3\mathbf{i} + \mathbf{j}$ and $\mathbf{n}_2 = -\frac{1}{2}\mathbf{i} + \mathbf{j} \Rightarrow \theta = \cos^{-1}\left(\frac{\mathbf{n}_1 \cdot \mathbf{n}_2}{|\mathbf{n}_1||\mathbf{n}_2|}\right) = \cos^{-1}\left(\frac{1}{\sqrt{2}}\right) = \frac{\pi}{4}$, the angle is $\frac{\pi}{4}$ and $\frac{3\pi}{4}$.

56. The points of intersection for the curves $y = -x^2$ and $y = \sqrt[3]{x}$ are $(0, 0)$ and $(-1, -1)$. At $(0, 0)$ the tangent line for $y = -x^2$ is $y = 0$ and the tangent line for $y = \sqrt[3]{x}$ is $x = 0$. Therefore, the angle of intersection at $(0, 0)$ is $\frac{\pi}{2}$. At $(-1, -1)$ the tangent line for $y = -x^2$ is $y = 2x + 1$ and the tangent line for $y = \sqrt[3]{x}$ is $y = \frac{1}{3}x - \frac{2}{3}$. The corresponding normal vectors are $\mathbf{n}_1 = 2\mathbf{i} - \mathbf{j}$ and $\mathbf{n}_2 = \frac{1}{3}\mathbf{i} - \mathbf{j} \Rightarrow \theta = \cos^{-1}\left(\frac{\mathbf{n}_1 \cdot \mathbf{n}_2}{|\mathbf{n}_1||\mathbf{n}_2|}\right) = \cos^{-1}\left(\frac{\frac{2}{3} + 1}{\sqrt{5}\sqrt{\frac{1}{9} + 1}}\right) = \cos^{-1}\left(\frac{\frac{5}{3}}{\sqrt{5}\sqrt{10}}\right) = \cos^{-1}\left(\frac{1}{\sqrt{2}}\right) = \frac{\pi}{4}$, the angle is $\frac{\pi}{4}$ and $\frac{3\pi}{4}$.

12.4 THE CROSS PRODUCT

$$1. \mathbf{u} \times \mathbf{v} = \begin{vmatrix} \mathbf{i} & \mathbf{j} & \mathbf{k} \\ 2 & -2 & -1 \\ 1 & 0 & -1 \end{vmatrix} = 3\left(\frac{2}{3}\mathbf{i} + \frac{1}{3}\mathbf{j} + \frac{2}{3}\mathbf{k}\right) \Rightarrow \text{length} = 3 \text{ and the direction is } \frac{2}{3}\mathbf{i} + \frac{1}{3}\mathbf{j} + \frac{2}{3}\mathbf{k};$$

$$\mathbf{v} \times \mathbf{u} = -(\mathbf{u} \times \mathbf{v}) = -3\left(\frac{2}{3}\mathbf{i} + \frac{1}{3}\mathbf{j} + \frac{2}{3}\mathbf{k}\right) \Rightarrow \text{length} = 3 \text{ and the direction is } -\frac{2}{3}\mathbf{i} - \frac{1}{3}\mathbf{j} - \frac{2}{3}\mathbf{k}$$

$$2. \mathbf{u} \times \mathbf{v} = \begin{vmatrix} \mathbf{i} & \mathbf{j} & \mathbf{k} \\ 2 & 3 & 0 \\ -1 & 1 & 0 \end{vmatrix} = 5(\mathbf{k}) \Rightarrow \text{length} = 5 \text{ and the direction is } \mathbf{k}$$

$$\mathbf{v} \times \mathbf{u} = -(\mathbf{u} \times \mathbf{v}) = -5(\mathbf{k}) \Rightarrow \text{length} = 5 \text{ and the direction is } -\mathbf{k}$$

$$3. \mathbf{u} \times \mathbf{v} = \begin{vmatrix} \mathbf{i} & \mathbf{j} & \mathbf{k} \\ 2 & -2 & 4 \\ -1 & 1 & -2 \end{vmatrix} = \mathbf{0} \Rightarrow \text{length} = 0 \text{ and has no direction}$$

$$\mathbf{v} \times \mathbf{u} = -(\mathbf{u} \times \mathbf{v}) = \mathbf{0} \Rightarrow \text{length} = 0 \text{ and has no direction}$$

$$4. \mathbf{u} \times \mathbf{v} = \begin{vmatrix} \mathbf{i} & \mathbf{j} & \mathbf{k} \\ 1 & 1 & -1 \\ 0 & 0 & 0 \end{vmatrix} = \mathbf{0} \Rightarrow \text{length} = 0 \text{ and has no direction}$$

$$\mathbf{v} \times \mathbf{u} = -(\mathbf{u} \times \mathbf{v}) = \mathbf{0} \Rightarrow \text{length} = 0 \text{ and has no direction}$$

$$5. \mathbf{u} \times \mathbf{v} = \begin{vmatrix} \mathbf{i} & \mathbf{j} & \mathbf{k} \\ 2 & 0 & 0 \\ 0 & -3 & 0 \end{vmatrix} = -6(\mathbf{k}) \Rightarrow \text{length} = 6 \text{ and the direction is } -\mathbf{k}$$

$$\mathbf{v} \times \mathbf{u} = -(\mathbf{u} \times \mathbf{v}) = 6(\mathbf{k}) \Rightarrow \text{length} = 6 \text{ and the direction is } \mathbf{k}$$

$$6. \mathbf{u} \times \mathbf{v} = (\mathbf{i} \times \mathbf{j}) \times (\mathbf{j} \times \mathbf{k}) = \mathbf{k} \times \mathbf{i} = \begin{vmatrix} \mathbf{i} & \mathbf{j} & \mathbf{k} \\ 0 & 0 & 1 \\ 1 & 0 & 0 \end{vmatrix} = \mathbf{j} \Rightarrow \text{length} = 1 \text{ and the direction is } \mathbf{j}$$

$$\mathbf{v} \times \mathbf{u} = -(\mathbf{u} \times \mathbf{v}) = -\mathbf{j} \Rightarrow \text{length} = 1 \text{ and the direction is } -\mathbf{j}$$

$$7. \mathbf{u} \times \mathbf{v} = \begin{vmatrix} \mathbf{i} & \mathbf{j} & \mathbf{k} \\ -8 & -2 & -4 \\ 2 & 2 & 1 \end{vmatrix} = 6\mathbf{i} - 12\mathbf{k} \Rightarrow \text{length} = 6\sqrt{5} \text{ and the direction is } \frac{1}{\sqrt{5}}\mathbf{i} - \frac{2}{\sqrt{5}}\mathbf{k}$$

$$\mathbf{v} \times \mathbf{u} = -(\mathbf{u} \times \mathbf{v}) = -(6\mathbf{i} - 12\mathbf{k}) \Rightarrow \text{length} = 6\sqrt{5} \text{ and the direction is } -\frac{1}{\sqrt{5}}\mathbf{i} + \frac{2}{\sqrt{5}}\mathbf{k}$$

$$8. \mathbf{u} \times \mathbf{v} = \begin{vmatrix} \mathbf{i} & \mathbf{j} & \mathbf{k} \\ \frac{3}{2} & -\frac{1}{2} & 1 \\ 1 & 1 & 2 \end{vmatrix} = -2\mathbf{i} - 2\mathbf{j} + 2\mathbf{k} \Rightarrow \text{length} = 2\sqrt{3} \text{ and the direction is } -\frac{1}{\sqrt{3}}\mathbf{i} - \frac{1}{\sqrt{3}}\mathbf{j} + \frac{1}{\sqrt{3}}\mathbf{k}$$

$$\mathbf{v} \times \mathbf{u} = -(\mathbf{u} \times \mathbf{v}) = -(-2\mathbf{i} - 2\mathbf{j} + 2\mathbf{k}) \Rightarrow \text{length} = 2\sqrt{3} \text{ and the direction is } \frac{1}{\sqrt{3}}\mathbf{i} + \frac{1}{\sqrt{3}}\mathbf{j} - \frac{1}{\sqrt{3}}\mathbf{k}$$

$$9. \mathbf{u} \times \mathbf{v} = \begin{vmatrix} \mathbf{i} & \mathbf{j} & \mathbf{k} \\ 1 & 0 & 0 \\ 0 & 1 & 0 \end{vmatrix} = \mathbf{k}$$

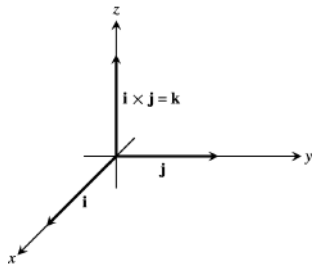

$$10. \mathbf{u} \times \mathbf{v} = \begin{vmatrix} \mathbf{i} & \mathbf{j} & \mathbf{k} \\ 1 & 0 & -1 \\ 0 & 1 & 0 \end{vmatrix} = \mathbf{i} + \mathbf{k}$$

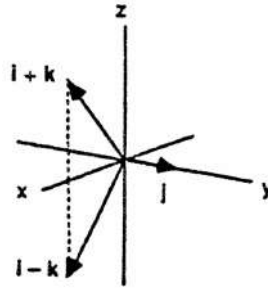

$$11. \mathbf{u} \times \mathbf{v} = \begin{vmatrix} \mathbf{i} & \mathbf{j} & \mathbf{k} \\ 1 & 0 & -1 \\ 0 & 1 & 1 \end{vmatrix} = \mathbf{i} - \mathbf{j} + \mathbf{k}$$

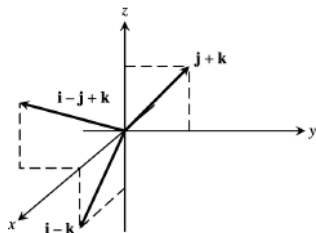

$$12. \mathbf{u} \times \mathbf{v} = \begin{vmatrix} \mathbf{i} & \mathbf{j} & \mathbf{k} \\ 2 & -1 & 0 \\ 1 & 2 & 0 \end{vmatrix} = 5\mathbf{k}$$

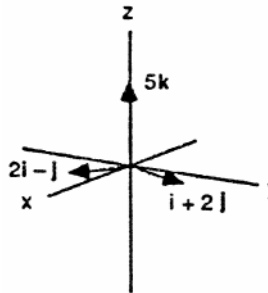

$$13. \mathbf{u} \times \mathbf{v} = \begin{vmatrix} \mathbf{i} & \mathbf{j} & \mathbf{k} \\ 1 & 1 & 0 \\ 1 & -1 & 0 \end{vmatrix} = -2\mathbf{k}$$

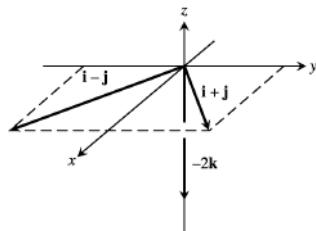

$$14. \mathbf{u} \times \mathbf{v} = \begin{vmatrix} \mathbf{i} & \mathbf{j} & \mathbf{k} \\ 0 & 1 & 2 \\ 1 & 0 & 0 \end{vmatrix} = 2\mathbf{j} - \mathbf{k}$$

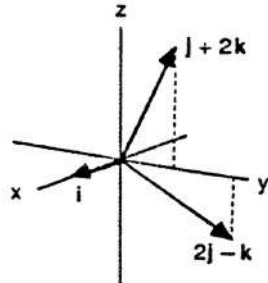

$$15. (a) \vec{PQ} \times \vec{PR} = \begin{vmatrix} \mathbf{i} & \mathbf{j} & \mathbf{k} \\ 1 & 1 & -3 \\ -1 & 3 & -1 \end{vmatrix} = 8\mathbf{i} + 4\mathbf{j} + 4\mathbf{k} \Rightarrow \text{Area} = \frac{1}{2} |\vec{PQ} \times \vec{PR}| = \frac{1}{2} \sqrt{64 + 16 + 16} = 2\sqrt{6}$$

$$(b) \mathbf{u} = \pm \frac{\vec{PQ} \times \vec{PR}}{|\vec{PQ} \times \vec{PR}|} = \pm \frac{1}{\sqrt{6}} (2\mathbf{i} + \mathbf{j} + \mathbf{k})$$

$$16. (a) \vec{PQ} \times \vec{PR} = \begin{vmatrix} \mathbf{i} & \mathbf{j} & \mathbf{k} \\ 1 & 0 & 2 \\ 2 & -2 & 0 \end{vmatrix} = 4\mathbf{i} + 4\mathbf{j} - 2\mathbf{k} \Rightarrow \text{Area} = \frac{1}{2} |\vec{PQ} \times \vec{PR}| = \frac{1}{2} \sqrt{16 + 16 + 4} = 3$$

$$(b) \mathbf{u} = \pm \frac{\vec{PQ} \times \vec{PR}}{|\vec{PQ} \times \vec{PR}|} = \pm \frac{1}{3} (2\mathbf{i} + 2\mathbf{j} - \mathbf{k})$$

$$17. (a) \vec{PQ} \times \vec{PR} = \begin{vmatrix} \mathbf{i} & \mathbf{j} & \mathbf{k} \\ 1 & 1 & 1 \\ 1 & 1 & 0 \end{vmatrix} = -\mathbf{i} + \mathbf{j} \Rightarrow \text{Area} = \frac{1}{2} |\vec{PQ} \times \vec{PR}| = \frac{1}{2} \sqrt{1 + 1} = \frac{\sqrt{2}}{2}$$

$$(b) \mathbf{u} = \pm \frac{\vec{PQ} \times \vec{PR}}{|\vec{PQ} \times \vec{PR}|} = \pm \frac{1}{\sqrt{2}} (-\mathbf{i} + \mathbf{j}) = \pm \frac{1}{\sqrt{2}} (\mathbf{i} - \mathbf{j})$$

$$18. (a) \vec{PQ} \times \vec{PR} = \begin{vmatrix} \mathbf{i} & \mathbf{j} & \mathbf{k} \\ 2 & -1 & -1 \\ 1 & 0 & -2 \end{vmatrix} = 2\mathbf{i} + 3\mathbf{j} + \mathbf{k} \Rightarrow \text{Area} = \frac{1}{2} |\vec{PQ} \times \vec{PR}| = \frac{1}{2} \sqrt{4 + 9 + 1} = \frac{\sqrt{14}}{2}$$

$$(b) \mathbf{u} = \pm \frac{\vec{PQ} \times \vec{PR}}{|\vec{PQ} \times \vec{PR}|} = \pm \frac{1}{\sqrt{14}} (2\mathbf{i} + 3\mathbf{j} + \mathbf{k})$$

$$19. \text{ If } \mathbf{u} = a_1\mathbf{i} + a_2\mathbf{j} + a_3\mathbf{k}, \mathbf{v} = b_1\mathbf{i} + b_2\mathbf{j} + b_3\mathbf{k}, \text{ and } \mathbf{w} = c_1\mathbf{i} + c_2\mathbf{j} + c_3\mathbf{k}, \text{ then } \mathbf{u} \cdot (\mathbf{v} \times \mathbf{w}) = \begin{vmatrix} a_1 & a_2 & a_3 \\ b_1 & b_2 & b_3 \\ c_1 & c_2 & c_3 \end{vmatrix},$$

$$\mathbf{v} \cdot (\mathbf{w} \times \mathbf{u}) = \begin{vmatrix} b_1 & b_2 & b_3 \\ c_1 & c_2 & c_3 \\ a_1 & a_2 & a_3 \end{vmatrix} \text{ and } \mathbf{w} \cdot (\mathbf{u} \times \mathbf{v}) = \begin{vmatrix} c_1 & c_2 & c_3 \\ a_1 & a_2 & a_3 \\ b_1 & b_2 & b_3 \end{vmatrix} \text{ which all have the same value, since the}$$

interchanging of two pair of rows in a determinant does not change its value \Rightarrow the volume is

$$|(\mathbf{u} \times \mathbf{v}) \cdot \mathbf{w}| = \text{abs} \begin{vmatrix} 2 & 0 & 0 \\ 0 & 2 & 0 \\ 0 & 0 & 2 \end{vmatrix} = 8$$

$$20. |(\mathbf{u} \times \mathbf{v}) \cdot \mathbf{w}| = \text{abs} \begin{vmatrix} 1 & -1 & 1 \\ 2 & 1 & -2 \\ -1 & 2 & -1 \end{vmatrix} = 4 \text{ (for details about verification, see Exercise 19)}$$

$$21. |(\mathbf{u} \times \mathbf{v}) \cdot \mathbf{w}| = \text{abs} \begin{vmatrix} 2 & 1 & 0 \\ 2 & -1 & 1 \\ 1 & 0 & 2 \end{vmatrix} = |-7| = 7 \text{ (for details about verification, see Exercise 19)}$$

$$22. |(\mathbf{u} \times \mathbf{v}) \cdot \mathbf{w}| = \text{abs} \begin{vmatrix} 1 & 1 & -2 \\ -1 & 0 & -1 \\ 2 & 4 & -2 \end{vmatrix} = 8 \text{ (for details about verification, see Exercise 19)}$$

$$23. (a) \mathbf{u} \cdot \mathbf{v} = -6, \mathbf{u} \cdot \mathbf{w} = -81, \mathbf{v} \cdot \mathbf{w} = 18 \Rightarrow \text{none}$$

$$(b) \mathbf{u} \times \mathbf{v} = \begin{vmatrix} \mathbf{i} & \mathbf{j} & \mathbf{k} \\ 5 & -1 & 1 \\ 0 & 1 & -5 \end{vmatrix} \neq \mathbf{0}, \mathbf{u} \times \mathbf{w} = \begin{vmatrix} \mathbf{i} & \mathbf{j} & \mathbf{k} \\ 5 & -1 & 1 \\ -15 & 3 & -3 \end{vmatrix} = \mathbf{0}, \mathbf{v} \times \mathbf{w} = \begin{vmatrix} \mathbf{i} & \mathbf{j} & \mathbf{k} \\ 0 & 1 & -5 \\ -15 & 3 & -3 \end{vmatrix} \neq \mathbf{0}$$

$\Rightarrow \mathbf{u}$ and \mathbf{w} are parallel

$$24. (a) \mathbf{u} \cdot \mathbf{v} = 0, \mathbf{u} \times \mathbf{w} = \mathbf{0}, \mathbf{u} \cdot \mathbf{r} = -3\pi, \mathbf{v} \cdot \mathbf{w} = 0, \mathbf{v} \cdot \mathbf{r} = 0, \mathbf{w} \cdot \mathbf{r} = 0 \Rightarrow \mathbf{u} \perp \mathbf{v}, \mathbf{u} \perp \mathbf{w}, \mathbf{v} \perp \mathbf{w}, \mathbf{v} \perp \mathbf{r} \text{ and } \mathbf{w} \perp \mathbf{r}$$

$$(b) \mathbf{u} \times \mathbf{v} = \begin{vmatrix} \mathbf{i} & \mathbf{j} & \mathbf{k} \\ 1 & 2 & -1 \\ -1 & 1 & 1 \end{vmatrix} \neq \mathbf{0}, \mathbf{u} \times \mathbf{w} = \begin{vmatrix} \mathbf{i} & \mathbf{j} & \mathbf{k} \\ 1 & 2 & -1 \\ 1 & 0 & 1 \end{vmatrix} \neq \mathbf{0}, \mathbf{u} \times \mathbf{r} = \begin{vmatrix} \mathbf{i} & \mathbf{j} & \mathbf{k} \\ 1 & 2 & -1 \\ -\frac{\pi}{2} & -\pi & \frac{\pi}{2} \end{vmatrix} = \mathbf{0}$$

$$\mathbf{v} \times \mathbf{w} = \begin{vmatrix} \mathbf{i} & \mathbf{j} & \mathbf{k} \\ -1 & 1 & 1 \\ 1 & 0 & 1 \end{vmatrix} \neq \mathbf{0}, \mathbf{v} \times \mathbf{r} = \begin{vmatrix} \mathbf{i} & \mathbf{j} & \mathbf{k} \\ -1 & 1 & 1 \\ -\frac{\pi}{2} & -\pi & \frac{\pi}{2} \end{vmatrix} \neq \mathbf{0}, \mathbf{w} \times \mathbf{r} = \begin{vmatrix} \mathbf{i} & \mathbf{j} & \mathbf{k} \\ 1 & 0 & 1 \\ -\frac{\pi}{2} & -\pi & \frac{\pi}{2} \end{vmatrix} \neq \mathbf{0}$$

$\Rightarrow \mathbf{u}$ and \mathbf{r} are parallel

$$25. |\vec{PQ} \times \mathbf{F}| = |\vec{PQ}| |\mathbf{F}| \sin(60^\circ) = \frac{2}{3} \cdot 30 \cdot \frac{\sqrt{3}}{2} \text{ ft} \cdot \text{lb} = 10\sqrt{3} \text{ ft} \cdot \text{lb}$$

$$26. |\vec{PQ} \times \mathbf{F}| = |\vec{PQ}| |\mathbf{F}| \sin(135^\circ) = \frac{2}{3} \cdot 30 \cdot \frac{\sqrt{2}}{2} \text{ ft} \cdot \text{lb} = 10\sqrt{2} \text{ ft} \cdot \text{lb}$$

$$27. (a) \text{ true, } |\mathbf{u}| = \sqrt{a_1^2 + a_2^2 + a_3^2} = \sqrt{\mathbf{u} \cdot \mathbf{u}}$$

$$(b) \text{ not always true, } \mathbf{u} \cdot \mathbf{u} = |\mathbf{u}|^2$$

$$(c) \text{ true, } \mathbf{u} \times \mathbf{0} = \begin{vmatrix} \mathbf{i} & \mathbf{j} & \mathbf{k} \\ a_1 & a_2 & a_3 \\ 0 & 0 & 0 \end{vmatrix} = 0\mathbf{i} + 0\mathbf{j} + 0\mathbf{k} = \mathbf{0} \text{ and } \mathbf{0} \times \mathbf{u} = \begin{vmatrix} \mathbf{i} & \mathbf{j} & \mathbf{k} \\ 0 & 0 & 0 \\ a_1 & a_2 & a_3 \end{vmatrix} = 0\mathbf{i} + 0\mathbf{j} + 0\mathbf{k} = \mathbf{0}$$

$$(d) \text{ true, } \mathbf{u} \times (-\mathbf{u}) = \begin{vmatrix} \mathbf{i} & \mathbf{j} & \mathbf{k} \\ a_1 & a_2 & a_3 \\ -a_1 & -a_2 & -a_3 \end{vmatrix} = (-a_2a_3 + a_2a_3)\mathbf{i} - (-a_1a_3 + a_1a_3)\mathbf{j} + (-a_1a_2 + a_1a_2)\mathbf{k} = \mathbf{0}$$

$$(e) \text{ not always true, } \mathbf{i} \times \mathbf{j} = \mathbf{k} \neq -\mathbf{k} = \mathbf{j} \times \mathbf{i} \text{ for example}$$

$$(f) \text{ true, distributive property of the cross product}$$

$$(g) \text{ true, } (\mathbf{u} \times \mathbf{v}) \cdot \mathbf{v} = \mathbf{u} \cdot (\mathbf{v} \times \mathbf{v}) = \mathbf{u} \cdot \mathbf{0} = 0$$

$$(h) \text{ true, the volume of a parallelepiped with } \mathbf{u}, \mathbf{v}, \text{ and } \mathbf{w} \text{ along the three edges is } (\mathbf{u} \times \mathbf{v}) \cdot \mathbf{w} = (\mathbf{v} \times \mathbf{w}) \cdot \mathbf{u} = \mathbf{u} \cdot (\mathbf{v} \times \mathbf{w}),$$

since the dot product is commutative.

$$28. (a) \text{ true, } \mathbf{u} \cdot \mathbf{v} = a_1b_1 + a_2b_2 + a_3b_3 = b_1a_1 + b_2a_2 + b_3a_3 = \mathbf{v} \cdot \mathbf{u}$$

$$(b) \text{ true, } \mathbf{u} \times \mathbf{v} = \begin{vmatrix} \mathbf{i} & \mathbf{j} & \mathbf{k} \\ a_1 & a_2 & a_3 \\ b_1 & b_2 & b_3 \end{vmatrix} = - \begin{vmatrix} \mathbf{i} & \mathbf{j} & \mathbf{k} \\ b_1 & b_2 & b_3 \\ a_1 & a_2 & a_3 \end{vmatrix} = -(\mathbf{v} \times \mathbf{u})$$

$$(c) \text{ true, } (-\mathbf{u}) \times \mathbf{v} = \begin{vmatrix} \mathbf{i} & \mathbf{j} & \mathbf{k} \\ -a_1 & -a_2 & -a_3 \\ b_1 & b_2 & b_3 \end{vmatrix} = - \begin{vmatrix} \mathbf{i} & \mathbf{j} & \mathbf{k} \\ a_1 & a_2 & a_3 \\ b_1 & b_2 & b_3 \end{vmatrix} = -(\mathbf{u} \times \mathbf{v})$$

$$(d) \text{ true, } (c\mathbf{u}) \cdot \mathbf{v} = (ca_1)b_1 + (ca_2)b_2 + (ca_3)b_3 = a_1(cb_1) + a_2(cb_2) + a_3(cb_3) = \mathbf{u} \cdot (c\mathbf{v}) = c(a_1b_1 + a_2b_2 + a_3b_3) = c(\mathbf{u} \cdot \mathbf{v})$$

$$(e) \text{ true, } c(\mathbf{u} \times \mathbf{v}) = c \begin{vmatrix} \mathbf{i} & \mathbf{j} & \mathbf{k} \\ a_1 & a_2 & a_3 \\ b_1 & b_2 & b_3 \end{vmatrix} = \begin{vmatrix} \mathbf{i} & \mathbf{j} & \mathbf{k} \\ ca_1 & ca_2 & ca_3 \\ b_1 & b_2 & b_3 \end{vmatrix} = (c\mathbf{u}) \times \mathbf{v} = \begin{vmatrix} \mathbf{i} & \mathbf{j} & \mathbf{k} \\ a_1 & a_2 & a_3 \\ cb_1 & cb_2 & cb_3 \end{vmatrix} = \mathbf{u} \times (c\mathbf{v})$$

$$(f) \text{ true, } \mathbf{u} \cdot \mathbf{u} = a_1^2 + a_2^2 + a_3^2 = (\sqrt{a_1^2 + a_2^2 + a_3^2})^2 = |\mathbf{u}|^2$$

$$(g) \text{ true, } (\mathbf{u} \times \mathbf{u}) \cdot \mathbf{u} = \mathbf{0} \cdot \mathbf{u} = 0$$

$$(h) \text{ true, } \mathbf{u} \times \mathbf{v} \perp \mathbf{u} \text{ and } \mathbf{u} \times \mathbf{v} \perp \mathbf{v} \Rightarrow (\mathbf{u} \times \mathbf{v}) \cdot \mathbf{u} = \mathbf{v} \cdot (\mathbf{u} \times \mathbf{v}) = 0$$

$$29. (a) \text{ proj } \mathbf{u} = \left(\frac{\mathbf{u} \cdot \mathbf{v}}{|\mathbf{v}|} \right) \mathbf{v} \quad (b) \pm (\mathbf{u} \times \mathbf{v}) \quad (c) \pm ((\mathbf{u} \times \mathbf{v}) \times \mathbf{w}) \quad (d) |(\mathbf{u} \times \mathbf{v}) \cdot \mathbf{w}|$$

$$30. (a) (\mathbf{u} \times \mathbf{v}) \times (\mathbf{u} \times \mathbf{w})$$

$$(b) (\mathbf{u} + \mathbf{v}) \times (\mathbf{u} - \mathbf{v}) = (\mathbf{u} + \mathbf{v}) \times \mathbf{u} - (\mathbf{u} + \mathbf{v}) \times \mathbf{v} = \mathbf{u} \times \mathbf{u} + \mathbf{v} \times \mathbf{u} - \mathbf{u} \times \mathbf{v} - \mathbf{v} \times \mathbf{v} = \mathbf{0} + \mathbf{v} \times \mathbf{u} - \mathbf{u} \times \mathbf{v} - \mathbf{0} = 2(\mathbf{v} \times \mathbf{u}), \text{ or simply } \mathbf{u} \times \mathbf{v}$$

$$(c) |\mathbf{u}| \frac{\mathbf{v}}{|\mathbf{v}|} \quad (d) |\mathbf{u} \times \mathbf{w}|$$

31. (a) yes, $\mathbf{u} \times \mathbf{v}$ and \mathbf{w} are both vectors
 (b) no, \mathbf{u} is a vector but $\mathbf{v} \cdot \mathbf{w}$ is a scalar
 (c) yes, \mathbf{u} and $\mathbf{u} \times \mathbf{w}$ are both vectors
 (d) no, \mathbf{u} is a vector but $\mathbf{v} \cdot \mathbf{w}$ is a scalar
32. $(\mathbf{u} \times \mathbf{v}) \times \mathbf{w}$ is perpendicular to $\mathbf{u} \times \mathbf{v}$, and $\mathbf{u} \times \mathbf{v}$ is perpendicular to both \mathbf{u} and $\mathbf{v} \Rightarrow (\mathbf{u} \times \mathbf{v}) \times \mathbf{w}$ is parallel to a vector in the plane of \mathbf{u} and \mathbf{v} which means it lies in the plane determined by \mathbf{u} and \mathbf{v} . The situation is degenerate if \mathbf{u} and \mathbf{v} are parallel so $\mathbf{u} \times \mathbf{v} = \mathbf{0}$ and the vectors do not determine a plane. Similar reasoning shows that $\mathbf{u} \times (\mathbf{v} \times \mathbf{w})$ lies in the plane of \mathbf{v} and \mathbf{w} provided \mathbf{v} and \mathbf{w} are nonparallel.
33. No, \mathbf{v} need not equal \mathbf{w} . For example, $\mathbf{i} + \mathbf{j} \neq -\mathbf{i} + \mathbf{j}$, but $\mathbf{i} \times (\mathbf{i} + \mathbf{j}) = \mathbf{i} \times \mathbf{i} + \mathbf{i} \times \mathbf{j} = \mathbf{0} + \mathbf{k} = \mathbf{k}$ and $\mathbf{i} \times (-\mathbf{i} + \mathbf{j}) = -\mathbf{i} \times \mathbf{i} + \mathbf{i} \times \mathbf{j} = \mathbf{0} + \mathbf{k} = \mathbf{k}$.
34. Yes. If $\mathbf{u} \times \mathbf{v} = \mathbf{u} \times \mathbf{w}$ and $\mathbf{u} \cdot \mathbf{v} = \mathbf{u} \cdot \mathbf{w}$, then $\mathbf{u} \times (\mathbf{v} - \mathbf{w}) = \mathbf{0}$ and $\mathbf{u} \cdot (\mathbf{v} - \mathbf{w}) = 0$. Suppose now that $\mathbf{v} \neq \mathbf{w}$. Then $\mathbf{u} \times (\mathbf{v} - \mathbf{w}) = \mathbf{0}$ implies that $\mathbf{v} - \mathbf{w} = k\mathbf{u}$ for some real number $k \neq 0$. This in turn implies that $\mathbf{u} \cdot (\mathbf{v} - \mathbf{w}) = \mathbf{u} \cdot (k\mathbf{u}) = k|\mathbf{u}|^2 = 0$, which implies that $\mathbf{u} = \mathbf{0}$. Since $\mathbf{u} \neq \mathbf{0}$, it cannot be true that $\mathbf{v} \neq \mathbf{w}$, so $\mathbf{v} = \mathbf{w}$.

$$35. \vec{AB} = -\mathbf{i} + \mathbf{j} \text{ and } \vec{AD} = -\mathbf{i} - \mathbf{j} \Rightarrow \vec{AB} \times \vec{AD} = \begin{vmatrix} \mathbf{i} & \mathbf{j} & \mathbf{k} \\ -1 & 1 & 0 \\ -1 & -1 & 0 \end{vmatrix} = 2\mathbf{k} \Rightarrow \text{area} = |\vec{AB} \times \vec{AD}| = 2$$

$$36. \vec{AB} = 7\mathbf{i} + 3\mathbf{j} \text{ and } \vec{AD} = 2\mathbf{i} + 5\mathbf{j} \Rightarrow \vec{AB} \times \vec{AD} = \begin{vmatrix} \mathbf{i} & \mathbf{j} & \mathbf{k} \\ 7 & 3 & 0 \\ 2 & 5 & 0 \end{vmatrix} = 29\mathbf{k} \Rightarrow \text{area} = |\vec{AB} \times \vec{AD}| = 29$$

$$37. \vec{AB} = 3\mathbf{i} - 2\mathbf{j} \text{ and } \vec{AD} = 5\mathbf{i} + \mathbf{j} \Rightarrow \vec{AB} \times \vec{AD} = \begin{vmatrix} \mathbf{i} & \mathbf{j} & \mathbf{k} \\ 3 & -2 & 0 \\ 5 & 1 & 0 \end{vmatrix} = 13\mathbf{k} \Rightarrow \text{area} = |\vec{AB} \times \vec{AD}| = 13$$

$$38. \vec{AB} = 7\mathbf{i} - 4\mathbf{j} \text{ and } \vec{AD} = 2\mathbf{i} + 5\mathbf{j} \Rightarrow \vec{AB} \times \vec{AD} = \begin{vmatrix} \mathbf{i} & \mathbf{j} & \mathbf{k} \\ 7 & -4 & 0 \\ 2 & 5 & 0 \end{vmatrix} = 43\mathbf{k} \Rightarrow \text{area} = |\vec{AB} \times \vec{AD}| = 43$$

$$39. \vec{AB} = -2\mathbf{i} + 3\mathbf{j} \text{ and } \vec{AC} = 3\mathbf{i} + \mathbf{j} \Rightarrow \vec{AB} \times \vec{AC} = \begin{vmatrix} \mathbf{i} & \mathbf{j} & \mathbf{k} \\ -2 & 3 & 0 \\ 3 & 1 & 0 \end{vmatrix} = -11\mathbf{k} \Rightarrow \text{area} = \frac{1}{2} |\vec{AB} \times \vec{AC}| = \frac{11}{2}$$

$$40. \vec{AB} = 4\mathbf{i} + 4\mathbf{j} \text{ and } \vec{AC} = 3\mathbf{i} + 2\mathbf{j} \Rightarrow \vec{AB} \times \vec{AC} = \begin{vmatrix} \mathbf{i} & \mathbf{j} & \mathbf{k} \\ 4 & 4 & 0 \\ 3 & 2 & 0 \end{vmatrix} = -4\mathbf{k} \Rightarrow \text{area} = \frac{1}{2} |\vec{AB} \times \vec{AC}| = 2$$

$$41. \vec{AB} = 6\mathbf{i} - 5\mathbf{j} \text{ and } \vec{AC} = 11\mathbf{i} - 5\mathbf{j} \Rightarrow \vec{AB} \times \vec{AC} = \begin{vmatrix} \mathbf{i} & \mathbf{j} & \mathbf{k} \\ 6 & -5 & 0 \\ 11 & -5 & 0 \end{vmatrix} = 25\mathbf{k} \Rightarrow \text{area} = \frac{1}{2} |\vec{AB} \times \vec{AC}| = \frac{25}{2}$$

$$42. \vec{AB} = 16\mathbf{i} - 5\mathbf{j} \text{ and } \vec{AC} = 4\mathbf{i} + 4\mathbf{j} \Rightarrow \vec{AB} \times \vec{AC} = \begin{vmatrix} \mathbf{i} & \mathbf{j} & \mathbf{k} \\ 16 & -5 & 0 \\ 4 & 4 & 0 \end{vmatrix} = 84\mathbf{k} \Rightarrow \text{area} = \frac{1}{2} |\vec{AB} \times \vec{AC}| = 42$$

43. If $\mathbf{A} = a_1\mathbf{i} + a_2\mathbf{j}$ and $\mathbf{B} = b_1\mathbf{i} + b_2\mathbf{j}$, then $\mathbf{A} \times \mathbf{B} = \begin{vmatrix} \mathbf{i} & \mathbf{j} & \mathbf{k} \\ a_1 & a_2 & 0 \\ b_1 & b_2 & 0 \end{vmatrix} = \begin{vmatrix} a_1 & a_2 \\ b_1 & b_2 \end{vmatrix} \mathbf{k}$ and the triangle's area is $\frac{1}{2} |\mathbf{A} \times \mathbf{B}| = \pm \frac{1}{2} \begin{vmatrix} a_1 & a_2 \\ b_1 & b_2 \end{vmatrix}$. The applicable sign is (+) if the acute angle from \mathbf{A} to \mathbf{B} runs counterclockwise in the xy -plane, and (-) if it runs clockwise, because the area must be a nonnegative number.

44. If $\mathbf{A} = a_1\mathbf{i} + a_2\mathbf{j}$, $\mathbf{B} = b_1\mathbf{i} + b_2\mathbf{j}$, and $\mathbf{C} = c_1\mathbf{i} + c_2\mathbf{j}$, then the area of the triangle is $\frac{1}{2} |\vec{\mathbf{AB}} \times \vec{\mathbf{AC}}|$. Now,

$$\begin{aligned} \vec{\mathbf{AB}} \times \vec{\mathbf{AC}} &= \begin{vmatrix} \mathbf{i} & \mathbf{j} & \mathbf{k} \\ b_1 - a_1 & b_2 - a_2 & 0 \\ c_1 - a_1 & c_2 - a_2 & 0 \end{vmatrix} = \begin{vmatrix} b_1 - a_1 & b_2 - a_2 \\ c_1 - a_1 & c_2 - a_2 \end{vmatrix} \mathbf{k} \Rightarrow \frac{1}{2} |\vec{\mathbf{AB}} \times \vec{\mathbf{AC}}| \\ &= \frac{1}{2} |(b_1 - a_1)(c_2 - a_2) - (c_1 - a_1)(b_2 - a_2)| = \frac{1}{2} |a_1(b_2 - c_2) + a_2(c_1 - b_1) + (b_1c_2 - c_1b_2)| \\ &= \pm \frac{1}{2} \begin{vmatrix} a_1 & a_2 & 1 \\ b_1 & b_2 & 1 \\ c_1 & c_2 & 1 \end{vmatrix}. \text{ The applicable sign ensures the area formula gives a nonnegative number.} \end{aligned}$$

12.5 LINES AND PLANES IN SPACE

- The direction $\mathbf{i} + \mathbf{j} + \mathbf{k}$ and $P(3, -4, -1) \Rightarrow x = 3 + t, y = -4 + t, z = -1 + t$
- The direction $\vec{\mathbf{PQ}} = -2\mathbf{i} - 2\mathbf{j} + 2\mathbf{k}$ and $P(1, 2, -1) \Rightarrow x = 1 - 2t, y = 2 - 2t, z = -1 + 2t$
- The direction $\vec{\mathbf{PQ}} = 5\mathbf{i} + 5\mathbf{j} - 5\mathbf{k}$ and $P(-2, 0, 3) \Rightarrow x = -2 + 5t, y = 5t, z = 3 - 5t$
- The direction $\vec{\mathbf{PQ}} = -\mathbf{j} - \mathbf{k}$ and $P(1, 2, 0) \Rightarrow x = 1, y = 2 - t, z = -t$
- The direction $2\mathbf{j} + \mathbf{k}$ and $P(0, 0, 0) \Rightarrow x = 0, y = 2t, z = t$
- The direction $2\mathbf{i} - \mathbf{j} + 3\mathbf{k}$ and $P(3, -2, 1) \Rightarrow x = 3 + 2t, y = -2 - t, z = 1 + 3t$
- The direction \mathbf{k} and $P(1, 1, 1) \Rightarrow x = 1, y = 1, z = 1 + t$
- The direction $3\mathbf{i} + 7\mathbf{j} - 5\mathbf{k}$ and $P(2, 4, 5) \Rightarrow x = 2 + 3t, y = 4 + 7t, z = 5 - 5t$
- The direction $\mathbf{i} + 2\mathbf{j} + 2\mathbf{k}$ and $P(0, -7, 0) \Rightarrow x = t, y = -7 + 2t, z = 2t$
- The direction is $\mathbf{A} \times \mathbf{B} = \begin{vmatrix} \mathbf{i} & \mathbf{j} & \mathbf{k} \\ 1 & 2 & 3 \\ 3 & 4 & 5 \end{vmatrix} = -2\mathbf{i} + 4\mathbf{j} - 2\mathbf{k}$ and $P(2, 3, 0) \Rightarrow x = 2 - 2t, y = 3 + 4t, z = -2t$
- The direction \mathbf{i} and $P(0, 0, 0) \Rightarrow x = t, y = 0, z = 0$
- The direction \mathbf{k} and $P(0, 0, 0) \Rightarrow x = 0, y = 0, z = t$

13. The direction $\vec{PQ} = \mathbf{i} + \mathbf{j} + \frac{3}{2}\mathbf{k}$ and $P(0, 0, 0) \Rightarrow x = t,$
 $y = t, z = \frac{3}{2}t,$ where $0 \leq t \leq 1$

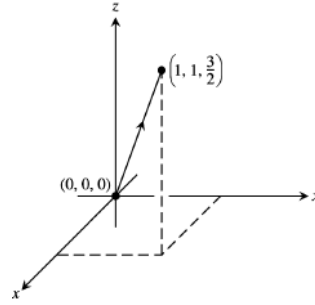

14. The direction $\vec{PQ} = \mathbf{i}$ and $P(0, 0, 0) \Rightarrow x = t, y = 0, z = 0,$
 where $0 \leq t \leq 1$

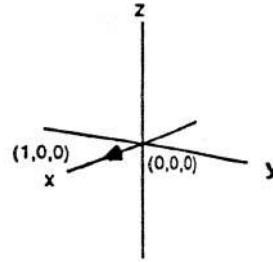

15. The direction $\vec{PQ} = \mathbf{j}$ and $P(1, 1, 0) \Rightarrow x = 1, y = 1 + t,$
 $z = 0,$ where $-1 \leq t \leq 0$

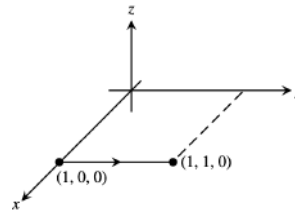

16. The direction $\vec{PQ} = \mathbf{k}$ and $P(1, 1, 0) \Rightarrow x = 1, y = 1, z = t,$
 where $0 \leq t \leq 1$

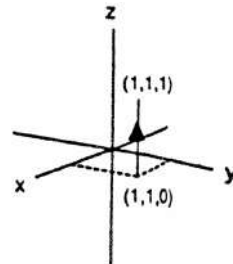

17. The direction $\vec{PQ} = -2\mathbf{j}$ and $P(0, 1, 1) \Rightarrow x = 0,$
 $y = 1 - 2t, z = 1,$ where $0 \leq t \leq 1$

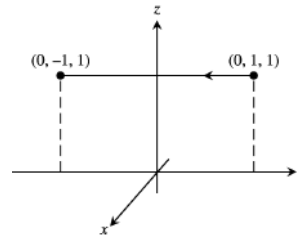

18. The direction $\vec{PQ} = 3\mathbf{i} - 2\mathbf{j}$ and $P(0, 2, 0) \Rightarrow x = 3t,$
 $y = 2 - 2t, z = 0,$ where $0 \leq t \leq 1$

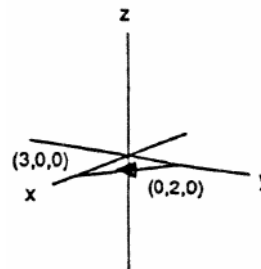

19. The direction $\vec{PQ} = -2\mathbf{i} + 2\mathbf{j} - 2\mathbf{k}$ and $P(2, 0, 2)$
 $\Rightarrow x = 2 - 2t, y = 2t, z = 2 - 2t$, where $0 \leq t \leq 1$

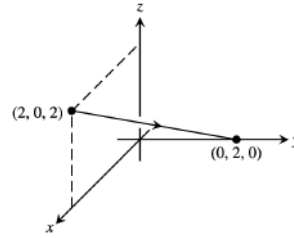

20. The direction $\vec{PQ} = -\mathbf{i} + 3\mathbf{j} + \mathbf{k}$ and $P(1, 0, -1)$
 $\Rightarrow x = 1 - t, y = 3t, z = -1 + t$, where $0 \leq t \leq 1$

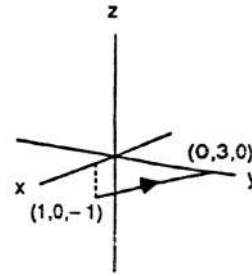

21. $3(x - 0) + (-2)(y - 2) + (-1)(z + 1) = 0 \Rightarrow 3x - 2y - z = -3$

22. $3(x - 1) + (1)(y + 1) + (1)(z - 3) = 0 \Rightarrow 3x + y + z = 5$

23. $\vec{PQ} = \mathbf{i} - \mathbf{j} + 3\mathbf{k}, \vec{PS} = -\mathbf{i} - 3\mathbf{j} + 2\mathbf{k} \Rightarrow \vec{PQ} \times \vec{PS} = \begin{vmatrix} \mathbf{i} & \mathbf{j} & \mathbf{k} \\ 1 & -1 & 3 \\ -1 & -3 & 2 \end{vmatrix} = 7\mathbf{i} - 5\mathbf{j} - 4\mathbf{k}$ is normal to the plane
 $\Rightarrow 7(x - 2) + (-5)(y - 0) + (-4)(z - 2) = 0 \Rightarrow 7x - 5y - 4z = 6$

24. $\vec{PQ} = -\mathbf{i} + \mathbf{j} + 2\mathbf{k}, \vec{PS} = -3\mathbf{i} + 2\mathbf{j} + 3\mathbf{k} \Rightarrow \vec{PQ} \times \vec{PS} = \begin{vmatrix} \mathbf{i} & \mathbf{j} & \mathbf{k} \\ -1 & 1 & 2 \\ -3 & 2 & 3 \end{vmatrix} = -\mathbf{i} - 3\mathbf{j} + \mathbf{k}$ is normal to the plane
 $\Rightarrow (-1)(x - 1) + (-3)(y - 5) + (1)(z - 7) = 0 \Rightarrow x + 3y - z = 9$

25. $\mathbf{n} = \mathbf{i} + 3\mathbf{j} + 4\mathbf{k}, P(2, 4, 5) = (1)(x - 2) + (3)(y - 4) + (4)(z - 5) = 0 \Rightarrow x + 3y + 4z = 34$

26. $\mathbf{n} = \mathbf{i} - 2\mathbf{j} + \mathbf{k}, P(1, -2, 1) = (1)(x - 1) + (-2)(y + 2) + (1)(z - 1) = 0 \Rightarrow x - 2y + z = 6$

27. $\begin{cases} x = 2t + 1 = s + 2 \\ y = 3t + 2 = 2s + 4 \end{cases} \Rightarrow \begin{cases} 2t - s = 1 \\ 3t - 2s = 2 \end{cases} \Rightarrow \begin{cases} 4t - 2s = 2 \\ 3t - 2s = 2 \end{cases} \Rightarrow t = 0 \text{ and } s = -1; \text{ then } z = 4t + 3 = -4s - 1$
 $\Rightarrow 4(0) + 3 = (-4)(-1) - 1$ is satisfied \Rightarrow the lines do intersect when $t = 0$ and $s = -1 \Rightarrow$ the point of intersection is $x = 1, y = 2$, and $z = 3$ or $P(1, 2, 3)$. A vector normal to the plane determined by these lines is

$$\mathbf{n}_1 \times \mathbf{n}_2 = \begin{vmatrix} \mathbf{i} & \mathbf{j} & \mathbf{k} \\ 2 & 3 & 4 \\ 1 & 2 & -4 \end{vmatrix} = -20\mathbf{i} + 12\mathbf{j} + \mathbf{k}, \text{ where } \mathbf{n}_1 \text{ and } \mathbf{n}_2 \text{ are directions of the lines} \Rightarrow \text{the plane}$$

containing the lines is represented by $(-20)(x - 1) + (12)(y - 2) + (1)(z - 3) = 0 \Rightarrow -20x + 12y + z = 7$.

28. $\begin{cases} x = t = 2s + 2 \\ y = -t + 2 = s + 3 \end{cases} \Rightarrow \begin{cases} t - 2s = 2 \\ -t - s = 1 \end{cases} \Rightarrow s = -1 \text{ and } t = 0; \text{ then } z = t + 1 = 5s + 6 \Rightarrow 0 + 1 = 5(-1) + 6$
 is satisfied \Rightarrow the lines do intersect when $s = -1$ and $t = 0 \Rightarrow$ the point of intersection is $x = 0, y = 2$ and $z = 1$

or $P(0, 2, 1)$. A vector normal to the plane determined by these lines is $\mathbf{n}_1 \times \mathbf{n}_2 = \begin{vmatrix} \mathbf{i} & \mathbf{j} & \mathbf{k} \\ 1 & -1 & 1 \\ 2 & 1 & 5 \end{vmatrix}$

$= -6\mathbf{i} - 3\mathbf{j} + 3\mathbf{k}$, where \mathbf{n}_1 and \mathbf{n}_2 are directions of the lines \Rightarrow the plane containing the lines is represented by $(-6)(x - 0) + (-3)(y - 2) + (3)(z - 1) = 0 \Rightarrow 6x + 3y - 3z = 3$.

29. The cross product of $\mathbf{i} + \mathbf{j} - \mathbf{k}$ and $-4\mathbf{i} + 2\mathbf{j} - 2\mathbf{k}$ has the same direction as the normal to the plane

$$\Rightarrow \mathbf{n} = \begin{vmatrix} \mathbf{i} & \mathbf{j} & \mathbf{k} \\ 1 & 1 & -1 \\ -4 & 2 & -2 \end{vmatrix} = 6\mathbf{j} + 6\mathbf{k}. \text{ Select a point on either line, such as } P(-1, 2, 1). \text{ Since the lines are given}$$

to intersect, the desired plane is $0(x + 1) + 6(y - 2) + 6(z - 1) = 0 \Rightarrow 6y + 6z = 18 \Rightarrow y + z = 3$.

30. The cross product of $\mathbf{i} - 3\mathbf{j} - \mathbf{k}$ and $\mathbf{i} + \mathbf{j} + \mathbf{k}$ has the same direction as the normal to the plane

$$\mathbf{n} = \begin{vmatrix} \mathbf{i} & \mathbf{j} & \mathbf{k} \\ 1 & -3 & -1 \\ 1 & 1 & 1 \end{vmatrix} = -2\mathbf{i} - 2\mathbf{j} + 4\mathbf{k}. \text{ Select a point on either line, such as } P(0, 3, -2). \text{ Since the lines are}$$

given to intersect, the desired plane is $(-2)(x - 0) + (-2)(y - 3) + (4)(z + 2) = 0 \Rightarrow -2x - 2y + 4z = -14$
 $\Rightarrow x + y - 2z = 7$.

$$31. \mathbf{n}_1 \times \mathbf{n}_2 = \begin{vmatrix} \mathbf{i} & \mathbf{j} & \mathbf{k} \\ 2 & 1 & -1 \\ 1 & 2 & 1 \end{vmatrix} = 3\mathbf{i} - 3\mathbf{j} + 3\mathbf{k} \text{ is a vector in the direction of the line of intersection of the planes}$$

$\Rightarrow 3(x - 2) + (-3)(y - 1) + 3(z + 1) = 0 \Rightarrow 3x - 3y + 3z = 0 \Rightarrow x - y + z = 0$ is the desired plane containing $P_0(2, 1, -1)$

$$32. \text{ A vector normal to the desired plane is } \vec{P_1P_2} \times \mathbf{n} = \begin{vmatrix} \mathbf{i} & \mathbf{j} & \mathbf{k} \\ 2 & 0 & -2 \\ 4 & -1 & 2 \end{vmatrix} = -2\mathbf{i} - 12\mathbf{j} - 2\mathbf{k}; \text{ choosing } P_1(1, 2, 3) \text{ as a}$$

point on the plane $\Rightarrow (-2)(x - 1) + (-12)(y - 2) + (-2)(z - 3) = 0 \Rightarrow -2x - 12y - 2z = -32 \Rightarrow x + 6y + z = 16$ is the desired plane

$$33. S(0, 0, 12), P(0, 0, 0) \text{ and } \mathbf{v} = 4\mathbf{i} - 2\mathbf{j} + 2\mathbf{k} \Rightarrow \vec{PS} \times \mathbf{v} = \begin{vmatrix} \mathbf{i} & \mathbf{j} & \mathbf{k} \\ 0 & 0 & 12 \\ 4 & -2 & 2 \end{vmatrix} = 24\mathbf{i} + 48\mathbf{j} = 24(\mathbf{i} + 2\mathbf{j})$$

$$\Rightarrow d = \frac{|\vec{PS} \times \mathbf{v}|}{|\mathbf{v}|} = \frac{24\sqrt{1+4}}{\sqrt{16+4+4}} = \frac{24\sqrt{5}}{\sqrt{24}} = \sqrt{5 \cdot 24} = 2\sqrt{30} \text{ is the distance from } S \text{ to the line}$$

$$34. S(0, 0, 0), P(5, 5, -3) \text{ and } \mathbf{v} = 3\mathbf{i} + 4\mathbf{j} - 5\mathbf{k} \Rightarrow \vec{PS} \times \mathbf{v} = \begin{vmatrix} \mathbf{i} & \mathbf{j} & \mathbf{k} \\ -5 & -5 & 3 \\ 3 & 4 & -5 \end{vmatrix} = 13\mathbf{i} - 16\mathbf{j} - 5\mathbf{k}$$

$$\Rightarrow d = \frac{|\vec{PS} \times \mathbf{v}|}{|\mathbf{v}|} = \frac{\sqrt{169+256+25}}{\sqrt{9+16+25}} = \frac{\sqrt{450}}{\sqrt{50}} = \sqrt{9} = 3 \text{ is the distance from } S \text{ to the line}$$

$$35. S(2, 1, 3), P(2, 1, 3) \text{ and } \mathbf{v} = 2\mathbf{i} + 6\mathbf{j} \Rightarrow \vec{PS} \times \mathbf{v} = \mathbf{0} \Rightarrow d = \frac{|\vec{PS} \times \mathbf{v}|}{|\mathbf{v}|} = \frac{0}{\sqrt{40}} = 0 \text{ is the distance from } S \text{ to the line}$$

(i.e., the point S lies on the line)

$$36. S(2, 1, -1), P(0, 1, 0) \text{ and } \mathbf{v} = 2\mathbf{i} + 2\mathbf{j} + 2\mathbf{k} \Rightarrow \vec{PS} \times \mathbf{v} = \begin{vmatrix} \mathbf{i} & \mathbf{j} & \mathbf{k} \\ 2 & 0 & -1 \\ 2 & 2 & 2 \end{vmatrix} = 2\mathbf{i} - 6\mathbf{j} + 4\mathbf{k}$$

$$\Rightarrow d = \frac{|\vec{PS} \times \mathbf{v}|}{|\mathbf{v}|} = \frac{\sqrt{4+36+16}}{\sqrt{4+4+4}} = \frac{\sqrt{56}}{\sqrt{12}} = \sqrt{\frac{14}{3}} \text{ is the distance from } S \text{ to the line}$$

$$37. S(3, -1, 4), P(4, 3, -5) \text{ and } \mathbf{v} = -\mathbf{i} + 2\mathbf{j} + 3\mathbf{k} \Rightarrow \vec{PS} \times \mathbf{v} = \begin{vmatrix} \mathbf{i} & \mathbf{j} & \mathbf{k} \\ -1 & -4 & 9 \\ -1 & 2 & 3 \end{vmatrix} = -30\mathbf{i} - 6\mathbf{j} - 6\mathbf{k}$$

$$\Rightarrow d = \frac{|\vec{PS} \times \mathbf{v}|}{|\mathbf{v}|} = \frac{\sqrt{900+36+36}}{\sqrt{1+4+9}} = \frac{\sqrt{972}}{\sqrt{14}} = \frac{\sqrt{486}}{\sqrt{7}} = \frac{\sqrt{81 \cdot 6}}{\sqrt{7}} = \frac{9\sqrt{42}}{7} \text{ is the distance from } S \text{ to the line}$$

$$38. S(-1, 4, 3), P(10, -3, 0) \text{ and } \mathbf{v} = 4\mathbf{i} + 4\mathbf{k} \Rightarrow \vec{PS} \times \mathbf{v} = \begin{vmatrix} \mathbf{i} & \mathbf{j} & \mathbf{k} \\ -11 & 7 & 3 \\ 4 & 0 & 4 \end{vmatrix} = 28\mathbf{i} + 56\mathbf{j} - 28\mathbf{k} = 28(\mathbf{i} + 2\mathbf{j} - \mathbf{k})$$

$$\Rightarrow d = \frac{|\vec{PS} \times \mathbf{v}|}{|\mathbf{v}|} = \frac{28\sqrt{1+4+1}}{4\sqrt{1+1}} = 7\sqrt{3} \text{ is the distance from } S \text{ to the line}$$

$$39. S(2, -3, 4), x + 2y + 2z = 13 \text{ and } P(13, 0, 0) \text{ is on the plane} \Rightarrow \vec{PS} = -11\mathbf{i} - 3\mathbf{j} + 4\mathbf{k} \text{ and } \mathbf{n} = \mathbf{i} + 2\mathbf{j} + 2\mathbf{k}$$

$$\Rightarrow d = \left| \vec{PS} \cdot \frac{\mathbf{n}}{|\mathbf{n}|} \right| = \left| \frac{-11-6+8}{\sqrt{1+4+4}} \right| = \left| \frac{-9}{\sqrt{9}} \right| = 3$$

$$40. S(0, 0, 0), 3x + 2y + 6z = 6 \text{ and } P(2, 0, 0) \text{ is on the plane} \Rightarrow \vec{PS} = -2\mathbf{i} \text{ and } \mathbf{n} = 3\mathbf{i} + 2\mathbf{j} + 6\mathbf{k}$$

$$\Rightarrow d = \left| \vec{PS} \cdot \frac{\mathbf{n}}{|\mathbf{n}|} \right| = \left| \frac{-6}{\sqrt{9+4+36}} \right| = \frac{6}{\sqrt{49}} = \frac{6}{7}$$

$$41. S(0, 1, 1), 4y + 3z = -12 \text{ and } P(0, -3, 0) \text{ is on the plane} \Rightarrow \vec{PS} = 4\mathbf{j} + \mathbf{k} \text{ and } \mathbf{n} = 4\mathbf{j} + 3\mathbf{k}$$

$$\Rightarrow d = \left| \vec{PS} \cdot \frac{\mathbf{n}}{|\mathbf{n}|} \right| = \left| \frac{16+3}{\sqrt{16+9}} \right| = \frac{19}{5}$$

$$42. S(2, 2, 3), 2x + y + 2z = 4 \text{ and } P(2, 0, 0) \text{ is on the plane} \Rightarrow \vec{PS} = 2\mathbf{j} + 3\mathbf{k} \text{ and } \mathbf{n} = 2\mathbf{i} + \mathbf{j} + 2\mathbf{k}$$

$$\Rightarrow d = \left| \vec{PS} \cdot \frac{\mathbf{n}}{|\mathbf{n}|} \right| = \left| \frac{2+6}{\sqrt{4+1+4}} \right| = \frac{8}{3}$$

$$43. S(0, -1, 0), 2x + y + 2z = 4 \text{ and } P(2, 0, 0) \text{ is on the plane} \Rightarrow \vec{PS} = -2\mathbf{i} - \mathbf{j} \text{ and } \mathbf{n} = 2\mathbf{i} + \mathbf{j} + 2\mathbf{k}$$

$$\Rightarrow d = \left| \vec{PS} \cdot \frac{\mathbf{n}}{|\mathbf{n}|} \right| = \left| \frac{-4-1+0}{\sqrt{4+1+4}} \right| = \frac{5}{3}$$

$$44. S(1, 0, -1), -4x + y + z = 4 \text{ and } P(-1, 0, 0) \text{ is on the plane} \Rightarrow \vec{PS} = 2\mathbf{i} - \mathbf{k} \text{ and } \mathbf{n} = -4\mathbf{i} + \mathbf{j} + \mathbf{k}$$

$$\Rightarrow d = \left| \vec{PS} \cdot \frac{\mathbf{n}}{|\mathbf{n}|} \right| = \left| \frac{-8-1}{\sqrt{16+1+1}} \right| = \frac{9}{\sqrt{18}} = \frac{3\sqrt{2}}{2}$$

$$45. \text{The point } P(1, 0, 0) \text{ is on the first plane and } S(10, 0, 0) \text{ is a point on the second plane} \Rightarrow \vec{PS} = 9\mathbf{i}, \text{ and}$$

$$\mathbf{n} = \mathbf{i} + 2\mathbf{j} + 6\mathbf{k} \text{ is normal to the first plane} \Rightarrow \text{the distance from } S \text{ to the first plane is } d = \left| \vec{PS} \cdot \frac{\mathbf{n}}{|\mathbf{n}|} \right|$$

$$= \left| \frac{9}{\sqrt{1+4+36}} \right| = \frac{9}{\sqrt{41}}, \text{ which is also the distance between the planes.}$$

$$46. \text{The line is parallel to the plane since } \mathbf{v} \cdot \mathbf{n} = (\mathbf{i} + \mathbf{j} - \frac{1}{2}\mathbf{k}) \cdot (\mathbf{i} + 2\mathbf{j} + 6\mathbf{k}) = 1 + 2 - 3 = 0. \text{ Also the point}$$

$$S(1, 0, 0) \text{ when } t = -1 \text{ lies on the line, and the point } P(10, 0, 0) \text{ lies on the plane} \Rightarrow \vec{PS} = -9\mathbf{i}. \text{ The distance}$$

$$\text{from } S \text{ to the plane is } d = \left| \vec{PS} \cdot \frac{\mathbf{n}}{|\mathbf{n}|} \right| = \left| \frac{-9}{\sqrt{1+4+36}} \right| = \frac{9}{\sqrt{41}}, \text{ which is also the distance from the line to the}$$

$$\text{plane.}$$

$$47. \mathbf{n}_1 = \mathbf{i} + \mathbf{j} \text{ and } \mathbf{n}_2 = 2\mathbf{i} + \mathbf{j} - 2\mathbf{k} \Rightarrow \theta = \cos^{-1} \left(\frac{\mathbf{n}_1 \cdot \mathbf{n}_2}{|\mathbf{n}_1| |\mathbf{n}_2|} \right) = \cos^{-1} \left(\frac{2+1}{\sqrt{2}\sqrt{9}} \right) = \cos^{-1} \left(\frac{1}{\sqrt{2}} \right) = \frac{\pi}{4}$$

802 Chapter 12 Vectors and the Geometry of Space

48. $\mathbf{n}_1 = 5\mathbf{i} + \mathbf{j} - \mathbf{k}$ and $\mathbf{n}_2 = \mathbf{i} - 2\mathbf{j} + 3\mathbf{k} \Rightarrow \theta = \cos^{-1} \left(\frac{\mathbf{n}_1 \cdot \mathbf{n}_2}{|\mathbf{n}_1| |\mathbf{n}_2|} \right) = \cos^{-1} \left(\frac{5-2-3}{\sqrt{27}\sqrt{14}} \right) = \cos^{-1}(0) = \frac{\pi}{2}$

49. $\mathbf{n}_1 = 2\mathbf{i} + 2\mathbf{j} + 2\mathbf{k}$ and $\mathbf{n}_2 = 2\mathbf{i} - 2\mathbf{j} - \mathbf{k} \Rightarrow \theta = \cos^{-1} \left(\frac{\mathbf{n}_1 \cdot \mathbf{n}_2}{|\mathbf{n}_1| |\mathbf{n}_2|} \right) = \cos^{-1} \left(\frac{4-4-2}{\sqrt{12}\sqrt{9}} \right) = \cos^{-1} \left(\frac{-1}{3\sqrt{3}} \right) \approx 1.76$ rad

50. $\mathbf{n}_1 = \mathbf{i} + \mathbf{j} + \mathbf{k}$ and $\mathbf{n}_2 = \mathbf{k} \Rightarrow \theta = \cos^{-1} \left(\frac{\mathbf{n}_1 \cdot \mathbf{n}_2}{|\mathbf{n}_1| |\mathbf{n}_2|} \right) = \cos^{-1} \left(\frac{1}{\sqrt{3}\sqrt{1}} \right) \approx 0.96$ rad

51. $\mathbf{n}_1 = 2\mathbf{i} + 2\mathbf{j} - \mathbf{k}$ and $\mathbf{n}_2 = \mathbf{i} + 2\mathbf{j} + \mathbf{k} \Rightarrow \theta = \cos^{-1} \left(\frac{\mathbf{n}_1 \cdot \mathbf{n}_2}{|\mathbf{n}_1| |\mathbf{n}_2|} \right) = \cos^{-1} \left(\frac{2+4-1}{\sqrt{9}\sqrt{6}} \right) = \cos^{-1} \left(\frac{5}{3\sqrt{6}} \right) \approx 0.82$ rad

52. $\mathbf{n}_1 = 4\mathbf{j} + 3\mathbf{k}$ and $\mathbf{n}_2 = 3\mathbf{i} + 2\mathbf{j} + 6\mathbf{k} \Rightarrow \theta = \cos^{-1} \left(\frac{\mathbf{n}_1 \cdot \mathbf{n}_2}{|\mathbf{n}_1| |\mathbf{n}_2|} \right) = \cos^{-1} \left(\frac{8+18}{\sqrt{25}\sqrt{49}} \right) = \cos^{-1} \left(\frac{26}{35} \right) \approx 0.73$ rad

53. $2x - y + 3z = 6 \Rightarrow 2(1-t) - (3t) + 3(1+t) = 6 \Rightarrow -2t + 5 = 6 \Rightarrow t = -\frac{1}{2} \Rightarrow x = \frac{3}{2}, y = -\frac{3}{2}$ and $z = \frac{1}{2} \Rightarrow \left(\frac{3}{2}, -\frac{3}{2}, \frac{1}{2} \right)$ is the point

54. $6x + 3y - 4z = -12 \Rightarrow 6(2) + 3(3+2t) - 4(-2-2t) = -12 \Rightarrow 14t + 29 = -12 \Rightarrow t = -\frac{41}{14} \Rightarrow x = 2, y = 3 - \frac{41}{7}$, and $z = -2 + \frac{41}{7} \Rightarrow \left(2, -\frac{20}{7}, \frac{27}{7} \right)$ is the point

55. $x + y + z = 2 \Rightarrow (1+2t) + (1+5t) + (3t) = 2 \Rightarrow 10t + 2 = 2 \Rightarrow t = 0 \Rightarrow x = 1, y = 1$ and $z = 0 \Rightarrow (1, 1, 0)$ is the point

56. $2x - 3z = 7 \Rightarrow 2(-1+3t) - 3(5t) = 7 \Rightarrow -9t - 2 = 7 \Rightarrow t = -1 \Rightarrow x = -1 - 3, y = -2$ and $z = -5 \Rightarrow (-4, -2, -5)$ is the point

57. $\mathbf{n}_1 = \mathbf{i} + \mathbf{j} + \mathbf{k}$ and $\mathbf{n}_2 = \mathbf{i} + \mathbf{j} \Rightarrow \mathbf{n}_1 \times \mathbf{n}_2 = \begin{vmatrix} \mathbf{i} & \mathbf{j} & \mathbf{k} \\ 1 & 1 & 1 \\ 1 & 1 & 0 \end{vmatrix} = -\mathbf{i} + \mathbf{j}$, the direction of the desired line; $(1, 1, -1)$

is on both planes \Rightarrow the desired line is $x = 1 - t, y = 1 + t, z = -1$

58. $\mathbf{n}_1 = 3\mathbf{i} - 6\mathbf{j} - 2\mathbf{k}$ and $\mathbf{n}_2 = 2\mathbf{i} + \mathbf{j} - 2\mathbf{k} \Rightarrow \mathbf{n}_1 \times \mathbf{n}_2 = \begin{vmatrix} \mathbf{i} & \mathbf{j} & \mathbf{k} \\ 3 & -6 & -2 \\ 2 & 1 & -2 \end{vmatrix} = 14\mathbf{i} + 2\mathbf{j} + 15\mathbf{k}$, the direction of the

desired line; $(1, 0, 0)$ is on both planes \Rightarrow the desired line is $x = 1 + 14t, y = 2t, z = 15t$

59. $\mathbf{n}_1 = \mathbf{i} - 2\mathbf{j} + 4\mathbf{k}$ and $\mathbf{n}_2 = \mathbf{i} + \mathbf{j} - 2\mathbf{k} \Rightarrow \mathbf{n}_1 \times \mathbf{n}_2 = \begin{vmatrix} \mathbf{i} & \mathbf{j} & \mathbf{k} \\ 1 & -2 & 4 \\ 1 & 1 & -2 \end{vmatrix} = 6\mathbf{j} + 3\mathbf{k}$, the direction of the

desired line; $(4, 3, 1)$ is on both planes \Rightarrow the desired line is $x = 4, y = 3 + 6t, z = 1 + 3t$

60. $\mathbf{n}_1 = 5\mathbf{i} - 2\mathbf{j}$ and $\mathbf{n}_2 = 4\mathbf{j} - 5\mathbf{k} \Rightarrow \mathbf{n}_1 \times \mathbf{n}_2 = \begin{vmatrix} \mathbf{i} & \mathbf{j} & \mathbf{k} \\ 5 & -2 & 0 \\ 0 & 4 & -5 \end{vmatrix} = 10\mathbf{i} + 25\mathbf{j} + 20\mathbf{k}$, the direction of the

desired line; $(1, -3, 1)$ is on both planes \Rightarrow the desired line is $x = 1 + 10t, y = -3 + 25t, z = 1 + 20t$

61. L1 & L2: $x = 3 + 2t = 1 + 4s$ and $y = -1 + 4t = 1 + 2s \Rightarrow \begin{cases} 2t - 4s = -2 \\ 4t - 2s = 2 \end{cases} \Rightarrow \begin{cases} 2t - 4s = -2 \\ 2t - s = 1 \end{cases}$
 $\Rightarrow -3s = -3 \Rightarrow s = 1$ and $t = 1 \Rightarrow$ on L1, $z = 1$ and on L2, $z = 1 \Rightarrow$ L1 and L2 intersect at $(5, 3, 1)$.

L2 & L3: The direction of L2 is $\frac{1}{6}(4\mathbf{i} + 2\mathbf{j} + 4\mathbf{k}) = \frac{1}{3}(2\mathbf{i} + \mathbf{j} + 2\mathbf{k})$ which is the same as the direction $\frac{1}{3}(2\mathbf{i} + \mathbf{j} + 2\mathbf{k})$ of L3; hence L2 and L3 are parallel.

L1 & L3: $x = 3 + 2t = 3 + 2r$ and $y = -1 + 4t = 2 + r \Rightarrow \begin{cases} 2t - 2r = 0 \\ 4t - r = 3 \end{cases} \Rightarrow \begin{cases} t - r = 0 \\ 4t - r = 3 \end{cases} \Rightarrow 3t = 3$

$\Rightarrow t = 1$ and $r = 1 \Rightarrow$ on L1, $z = 2$ while on L3, $z = 0 \Rightarrow$ L1 and L2 do not intersect. The direction of L1 is $\frac{1}{\sqrt{21}}(2\mathbf{i} + 4\mathbf{j} - \mathbf{k})$ while the direction of L3 is $\frac{1}{3}(2\mathbf{i} + \mathbf{j} + 2\mathbf{k})$ and neither is a multiple of the other; hence L1 and L3 are skew.

62. L1 & L2: $x = 1 + 2t = 2 - s$ and $y = -1 - t = 3s \Rightarrow \begin{cases} 2t + s = 1 \\ -t - 3s = 1 \end{cases} \Rightarrow -5s = 3 \Rightarrow s = -\frac{3}{5}$ and $t = \frac{4}{5} \Rightarrow$ on L1,

$z = \frac{12}{5}$ while on L2, $z = 1 - \frac{3}{5} = \frac{2}{5} \Rightarrow$ L1 and L2 do not intersect. The direction of L1 is $\frac{1}{\sqrt{14}}(2\mathbf{i} - \mathbf{j} + 3\mathbf{k})$

while the direction of L2 is $\frac{1}{\sqrt{11}}(-\mathbf{i} + 3\mathbf{j} + \mathbf{k})$ and neither is a multiple of the other; hence, L1 and L2 are skew.

L2 & L3: $x = 2 - s = 5 + 2r$ and $y = 3s = 1 - r \Rightarrow \begin{cases} -s - 2r = 3 \\ 3s + r = 1 \end{cases} \Rightarrow 5s = 5 \Rightarrow s = 1$ and $r = -2 \Rightarrow$ on L2,

$z = 2$ and on L3, $z = 2 \Rightarrow$ L2 and L3 intersect at $(1, 3, 2)$.

L1 & L3: L1 and L3 have the same direction $\frac{1}{\sqrt{14}}(2\mathbf{i} - \mathbf{j} + 3\mathbf{k})$; hence L1 and L3 are parallel.

63. $x = 2 + 2t, y = -4 - t, z = 7 + 3t; x = -2 - t, y = -2 + \frac{1}{2}t, z = 1 - \frac{3}{2}t$

64. $1(x - 4) - 2(y - 1) + 1(z - 5) = 0 \Rightarrow x - 4 - 2y + 2 + z - 5 = 0 \Rightarrow x - 2y + z = 7;$
 $-\sqrt{2}(x - 3) + 2\sqrt{2}(y + 2) - \sqrt{2}(z - 0) = 0 \Rightarrow -\sqrt{2}x + 2\sqrt{2}y - \sqrt{2}z = -7\sqrt{2}$

65. $x = 0 \Rightarrow t = -\frac{1}{2}, y = -\frac{1}{2}, z = -\frac{3}{2} \Rightarrow (0, -\frac{1}{2}, -\frac{3}{2}); y = 0 \Rightarrow t = -1, x = -1, z = -3 \Rightarrow (-1, 0, -3); z = 0 \Rightarrow t = 0, x = 1, y = -1 \Rightarrow (1, -1, 0)$

66. The line contains $(0, 0, 3)$ and $(\sqrt{3}, 1, 3)$ because the projection of the line onto the xy -plane contains the origin and intersects the positive x -axis at a 30° angle. The direction of the line is $\sqrt{3}\mathbf{i} + \mathbf{j} + 0\mathbf{k} \Rightarrow$ the line in question is $x = \sqrt{3}t, y = t, z = 3$.

67. With substitution of the line into the plane we have $2(1 - 2t) + (2 + 5t) - (-3t) = 8 \Rightarrow 2 - 4t + 2 + 5t + 3t = 8 \Rightarrow 4t + 4 = 8 \Rightarrow t = 1 \Rightarrow$ the point $(-1, 7, -3)$ is contained in both the line and plane, so they are not parallel.

68. The planes are parallel when either vector $A_1\mathbf{i} + B_1\mathbf{j} + C_1\mathbf{k}$ or $A_2\mathbf{i} + B_2\mathbf{j} + C_2\mathbf{k}$ is a multiple of the other or when $|(A_1\mathbf{i} + B_1\mathbf{j} + C_1\mathbf{k}) \times (A_2\mathbf{i} + B_2\mathbf{j} + C_2\mathbf{k})| = 0$. The planes are perpendicular when their normals are perpendicular, or $(A_1\mathbf{i} + B_1\mathbf{j} + C_1\mathbf{k}) \cdot (A_2\mathbf{i} + B_2\mathbf{j} + C_2\mathbf{k}) = 0$.

69. There are many possible answers. One is found as follows: eliminate t to get $t = x - 1 = 2 - y = \frac{z-3}{2}$
 $\Rightarrow x - 1 = 2 - y$ and $2 - y = \frac{z-3}{2} \Rightarrow x + y = 3$ and $2y + z = 7$ are two such planes.

70. Since the plane passes through the origin, its general equation is of the form $Ax + By + Cz = 0$. Since it meets the plane M at a right angle, their normal vectors are perpendicular $\Rightarrow 2A + 3B + C = 0$. One choice satisfying this equation is $A = 1, B = -1$ and $C = 1 \Rightarrow x - y + z = 0$. Any plane $Ax + By + Cz = 0$ with $2A + 3B + C = 0$ will pass through the origin and be perpendicular to M .

71. The points $(a, 0, 0)$, $(0, b, 0)$ and $(0, 0, c)$ are the x , y , and z intercepts of the plane. Since a , b , and c are all nonzero, the plane must intersect all three coordinate axes and cannot pass through the origin. Thus, $\frac{x}{a} + \frac{y}{b} + \frac{z}{c} = 1$ describes all planes except those through the origin or parallel to a coordinate axis.

72. Yes. If \mathbf{v}_1 and \mathbf{v}_2 are nonzero vectors parallel to the lines, then $\mathbf{v}_1 \times \mathbf{v}_2 \neq \mathbf{0}$ is perpendicular to the lines.

73. (a) $\vec{EP} = c\vec{EP}_1 \Rightarrow -x_0\mathbf{i} + y\mathbf{j} + z\mathbf{k} = c[(x_1 - x_0)\mathbf{i} + y_1\mathbf{j} + z_1\mathbf{k}] \Rightarrow -x_0 = c(x_1 - x_0)$, $y = cy_1$ and $z = cz_1$, where c is a positive real number

(b) At $x_1 = 0 \Rightarrow c = 1 \Rightarrow y = y_1$ and $z = z_1$; at $x_1 = x_0 \Rightarrow x_0 = 0, y = 0, z = 0$; $\lim_{x_0 \rightarrow \infty} c = \lim_{x_0 \rightarrow \infty} \frac{-x_0}{x_1 - x_0} = \lim_{x_0 \rightarrow \infty} \frac{-1}{-1} = 1 \Rightarrow c \rightarrow 1$ so that $y \rightarrow y_1$ and $z \rightarrow z_1$

74. The plane which contains the triangular plane is $x + y + z = 2$. The line containing the endpoints of the line segment is $x = 1 - t, y = 2t, z = 2t$. The plane and the line intersect at $(\frac{2}{3}, \frac{2}{3}, \frac{2}{3})$. The visible section of the line segment is $\sqrt{(\frac{1}{3})^2 + (\frac{2}{3})^2 + (\frac{2}{3})^2} = 1$ unit in length. The length of the line segment is $\sqrt{1^2 + 2^2 + 2^2} = 3 \Rightarrow \frac{2}{3}$ of the line segment is hidden from view.

12.6 CYLINDERS AND QUADRIC SURFACES

- | | | |
|---------------------|-----------------------------|-----------------------------|
| 1. d, ellipsoid | 2. i, hyperboloid | 3. a, cylinder |
| 4. g, cone | 5. l, hyperbolic paraboloid | 6. e, paraboloid |
| 7. b, cylinder | 8. j, hyperboloid | 9. k, hyperbolic paraboloid |
| 10. f, paraboloid | 11. h, cone | 12. c, ellipsoid |
| 13. $x^2 + y^2 = 4$ | 14. $x^2 + z^2 = 4$ | 15. $z = y^2 - 1$ |

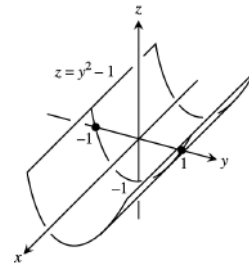
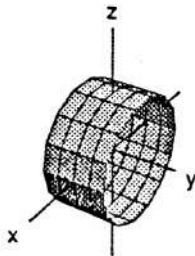
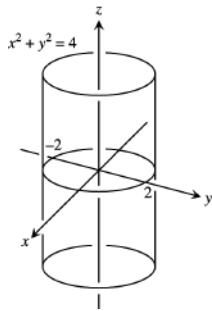

16. $x = y^2$

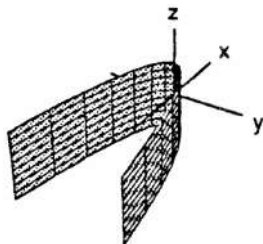

17. $x^2 + 4z^2 = 16$

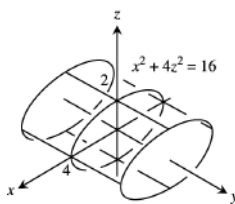

18. $4x^2 + y^2 = 36$

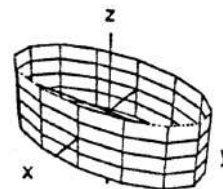

19. $z^2 - y^2 = 1$

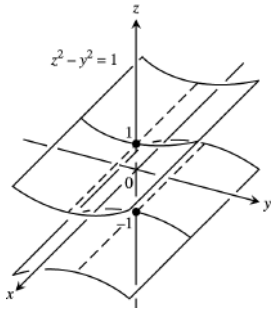

20. $yz = 1$

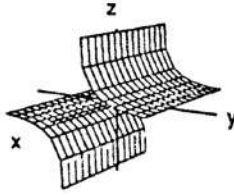

21. $9x^2 + y^2 + z^2 = 9$

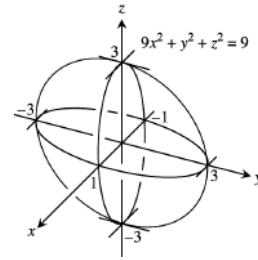

22. $4x^2 + 4y^2 + z^2 = 16$

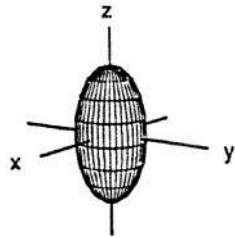

23. $4x^2 + 9y^2 + 4z^2 = 36$

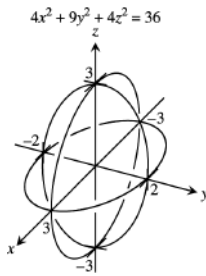

24. $9x^2 + 4y^2 + 36z^2 = 36$

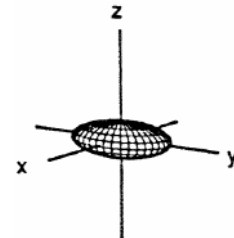

25. $x^2 + 4y^2 = z$

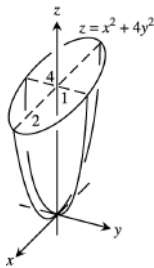

26. $z = x^2 + 9y^2$

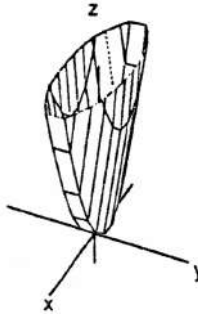

27. $z = 8 - x^2 - y^2$

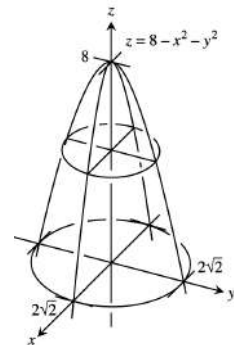

28. $z = 18 - x^2 - 9y^2$

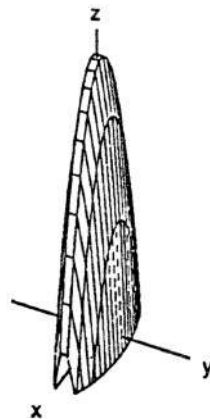

29. $x = 4 - 4y^2 - z^2$

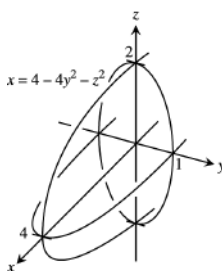

30. $y = 1 - x^2 - z^2$

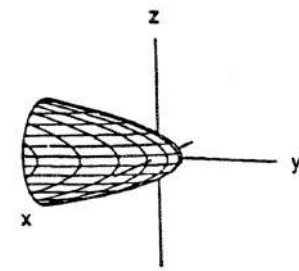

31. $x^2 + y^2 = z^2$

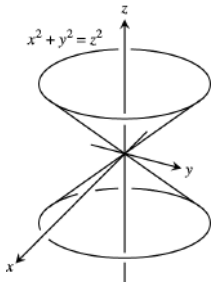

32. $y^2 + z^2 = x^2$

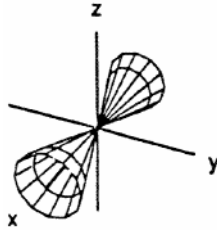

33. $4x^2 + 9z^2 = 9y^2$

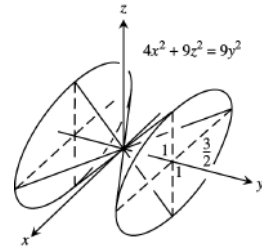

34. $9x^2 + 4y^2 = 36z^2$

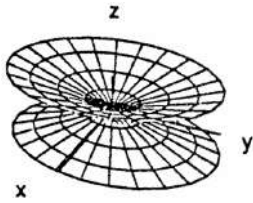

35. $x^2 + y^2 - z^2 = 1$

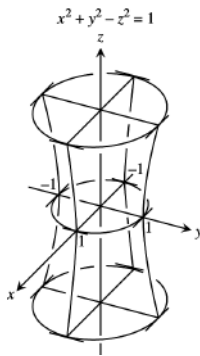

36. $y^2 + z^2 - x^2 = 1$

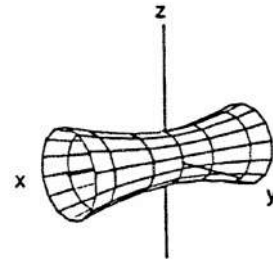

37. $\frac{y^2}{4} + \frac{z^2}{9} - \frac{x^2}{4} = 1$

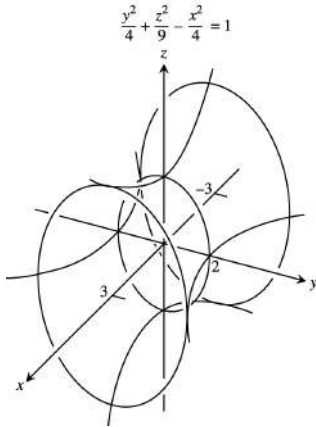

38. $\frac{x^2}{4} + \frac{y^2}{4} - \frac{z^2}{9} = 1$

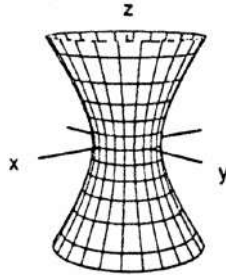

39. $z^2 - x^2 - y^2 = 1$

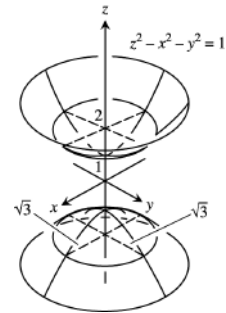

40. $\frac{y^2}{4} - \frac{x^2}{4} - z^2 = 1$

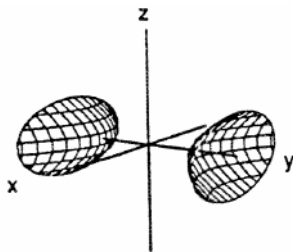

41. $x^2 - y^2 - \frac{z^2}{4} = 1$

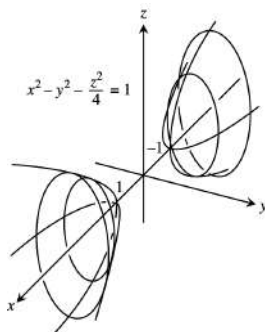

42. $\frac{x^2}{4} - y^2 - \frac{z^2}{4} = 1$

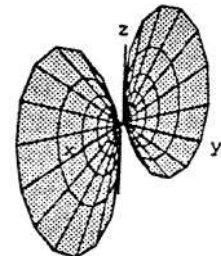

43. $y^2 - x^2 = z$

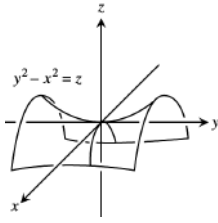

44. $x^2 = y^2 = z$

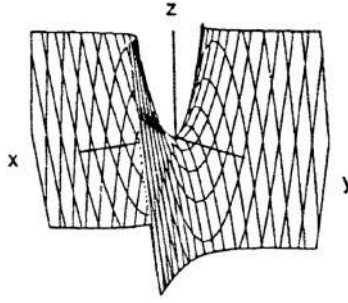

45. $x^2 + y^2 + z^2 = 4$

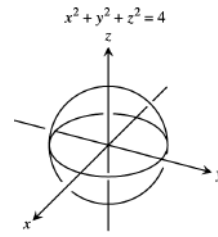

46. $4x^2 + 4y^2 = z^2$

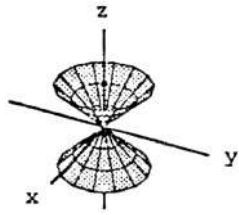

47. $z = 1 + y^2 - x^2$

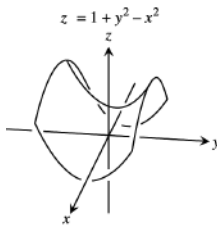

48. $y^2 - z^2 = 4$

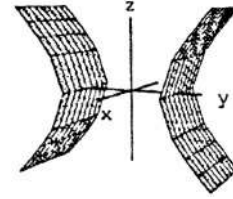

49. $y = -(x^2 + z^2)$

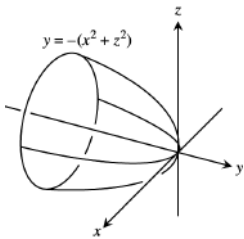

50. $z^2 - 4x^2 - 4y^2 = 4$

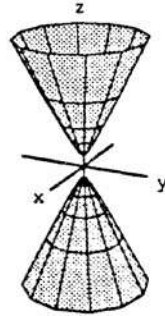

51. $16x^2 + 4y^2 = 1$

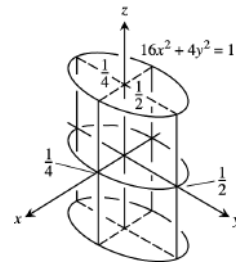

52. $z = x^2 + y^2 + 1$

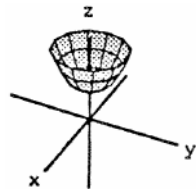

53. $x^2 + y^2 - z^2 = 4$

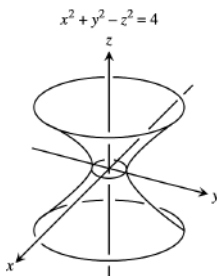

54. $x = 4 - y^2$

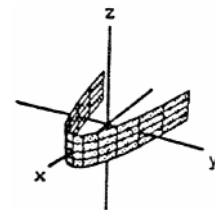

55. $x^2 + z^2 = y$

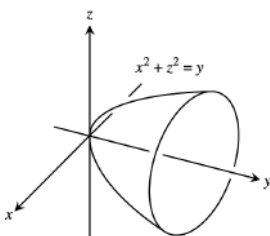

56. $z^2 - \frac{x^2}{4} - y^2 = 1$

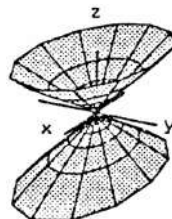

57. $x^2 + z^2 = 1$

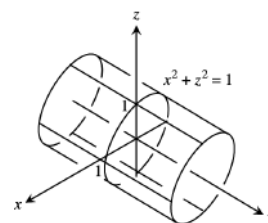

58. $4x^2 + 4y^2 + z^2 = 4$

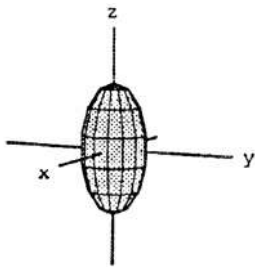

59. $16y^2 + 9z^2 = 4x^2$

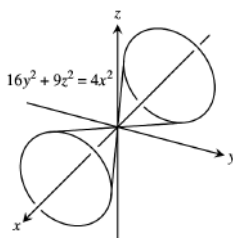

60. $z = x^2 - y^2$

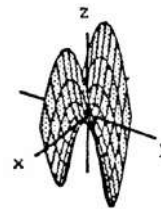

61. $9x^2 + 4y^2 + z^2 = 36$

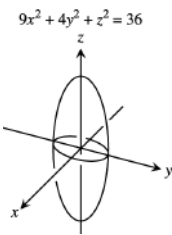

62. $4x^2 + 9z^2 = y^2$

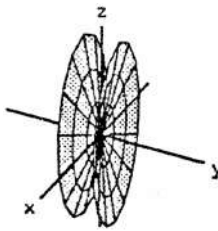

63. $x^2 + y^2 - 16z^2 = 16$

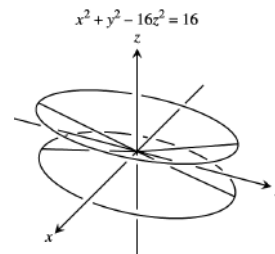

64. $z^2 + 4y^2 = 9$

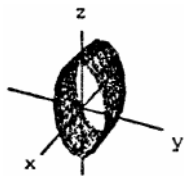

65. $z = -(x^2 + y^2)$

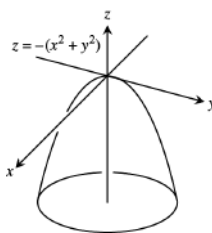

66. $y^2 - x^2 - z^2 = 1$

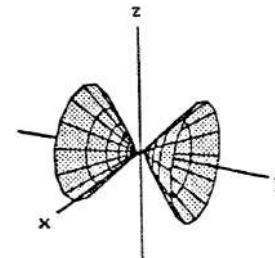

67. $x^2 - 4y^2 = 1$

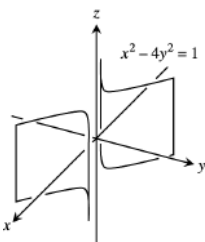

68. $z = 4x^2 + y^2 - 4$

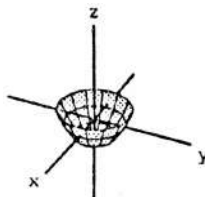

69. $4y^2 + z^2 - 4x^2 = 4$

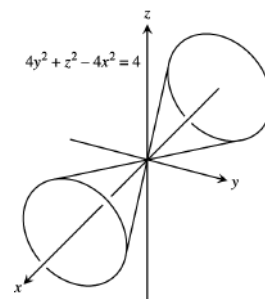

70. $z = 1 - x^2$

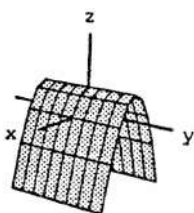

71. $x^2 + y^2 = z$

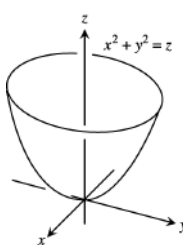

72. $\frac{x^2}{4} + y^2 - z^2 = 1$

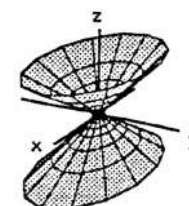

73. $yz = 1$

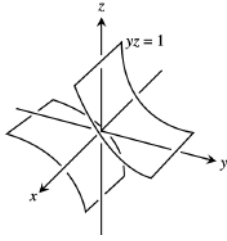

74. $36x^2 + 9y^2 + 4z^2 = 36$

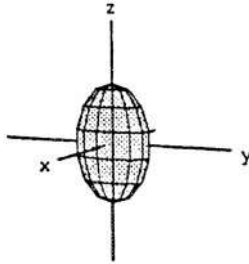

75. $9x^2 + 16y^2 = 4z^2$

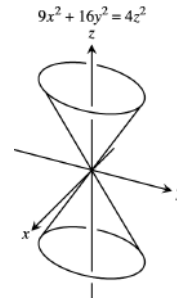

76. $4z^2 - x^2 - y^2 = 4$

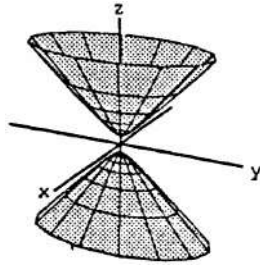

77. (a) If $x^2 + \frac{y^2}{4} + \frac{z^2}{9} = 1$ and $z = c$, then $x^2 + \frac{y^2}{4} = \frac{9-c^2}{9} \Rightarrow \frac{x^2}{\left(\frac{9-c^2}{9}\right)} + \frac{y^2}{\left[\frac{4(9-c^2)}{9}\right]} = 1 \Rightarrow A = ab\pi$
 $= \pi \left(\frac{\sqrt{9-c^2}}{3} \right) \left(\frac{2\sqrt{9-c^2}}{3} \right) = \frac{2\pi(9-c^2)}{9}$

(b) From part (a), each slice has the area $\frac{2\pi(9-z^2)}{9}$, where $-3 \leq z \leq 3$. Thus $V = 2 \int_0^3 \frac{2\pi}{9} (9-z^2) dz$
 $= \frac{4\pi}{9} \int_0^3 (9-z^2) dz = \frac{4\pi}{9} \left[9z - \frac{z^3}{3} \right]_0^3 = \frac{4\pi}{9} (27-9) = 8\pi$

(c) $\frac{x^2}{a^2} + \frac{y^2}{b^2} + \frac{z^2}{c^2} = 1 \Rightarrow \frac{x^2}{\left[\frac{a^2(c^2-z^2)}{c^2}\right]} + \frac{y^2}{\left[\frac{b^2(c^2-z^2)}{c^2}\right]} = 1 \Rightarrow A = \pi \left(\frac{a\sqrt{c^2-z^2}}{c} \right) \left(\frac{b\sqrt{c^2-z^2}}{c} \right)$
 $\Rightarrow V = 2 \int_0^c \frac{\pi ab}{c^2} (c^2 - z^2) dz = \frac{2\pi ab}{c^2} \left[c^2 z - \frac{z^3}{3} \right]_0^c = \frac{2\pi ab}{c^2} \left(\frac{2}{3} c^3 \right) = \frac{4\pi abc}{3}$. Note that if $r = a = b = c$, then $V = \frac{4\pi r^3}{3}$, which is the volume of a sphere.

78. The ellipsoid has the form $\frac{x^2}{R^2} + \frac{y^2}{R^2} + \frac{z^2}{c^2} = 1$. To determine c^2 we note that the point $(0, r, h)$ lies on the surface of the barrel. Thus, $\frac{r^2}{R^2} + \frac{h^2}{c^2} = 1 \Rightarrow c^2 = \frac{h^2 R^2}{R^2 - r^2}$. We calculate the volume by the disk method:

$$V = \pi \int_{-h}^h y^2 dz. \text{ Now, } \frac{y^2}{R^2} + \frac{z^2}{c^2} = 1 \Rightarrow y^2 = R^2 \left(1 - \frac{z^2}{c^2} \right) = R^2 \left[1 - \frac{z^2(R^2 - r^2)}{h^2 R^2} \right] = R^2 - \left(\frac{R^2 - r^2}{h^2} \right) z^2$$

$$\Rightarrow V = \pi \int_{-h}^h \left[R^2 - \left(\frac{R^2 - r^2}{h^2} \right) z^2 \right] dz = \pi \left[R^2 z - \frac{1}{3} \left(\frac{R^2 - r^2}{h^2} \right) z^3 \right]_{-h}^h = 2\pi \left[R^2 h - \frac{1}{3} (R^2 - r^2) h \right] = 2\pi \left(\frac{2R^2 h}{3} + \frac{r^2 h}{3} \right)$$

$$= \frac{4}{3} \pi R^2 h + \frac{2}{3} \pi r^2 h, \text{ the volume of the barrel. If } r = R, \text{ then } V = 2\pi R^2 h \text{ which is the volume of a cylinder of radius } R \text{ and height } 2h. \text{ If } r = 0 \text{ and } h = R, \text{ then } V = \frac{4}{3} \pi R^3 \text{ which is the volume of a sphere.}$$

79. We calculate the volume by the slicing method, taking slices parallel to the xy -plane. For fixed z , $\frac{x^2}{a^2} + \frac{y^2}{b^2} = \frac{z}{c}$ gives the ellipse $\frac{x^2}{\left(\frac{az}{c}\right)} + \frac{y^2}{\left(\frac{bz^2}{c}\right)} = 1$. The area of this ellipse is $\pi \left(a\sqrt{\frac{z}{c}} \right) \left(b\sqrt{\frac{z}{c}} \right) = \frac{\pi abz}{c}$ (see Exercise 77a). Hence the volume is given by $V = \int_0^h \frac{\pi abz}{c} dz = \left[\frac{\pi abz^2}{2c} \right]_0^h = \frac{\pi abh^2}{c}$. Now the area of the elliptic base when $z = h$ is $A = \frac{\pi abh}{c}$, as determined previously. Thus, $V = \frac{\pi abh^2}{c} = \frac{1}{2} \left(\frac{\pi abh}{c} \right) h = \frac{1}{2} (\text{base})(\text{altitude})$, as claimed.

80. (a) For each fixed value of z , the hyperboloid $\frac{x^2}{a^2} + \frac{y^2}{b^2} - \frac{z^2}{c^2} = 1$ results in a cross-sectional ellipse

$$\left[\frac{x^2}{a^2(c^2+z^2)} \right] + \left[\frac{y^2}{b^2(c^2+z^2)} \right] = 1. \text{ The area of the cross-sectional ellipse (see Exercise 77a) is}$$

$$A(z) = \pi \left(\frac{a}{c} \sqrt{c^2+z^2} \right) \left(\frac{b}{c} \sqrt{c^2+z^2} \right) = \frac{\pi ab}{c^2} (c^2+z^2). \text{ The volume of the solid by the method of slices is}$$

$$V = \int_0^h A(z) dz = \int_0^h \frac{\pi ab}{c^2} (c^2+z^2) dz = \frac{\pi ab}{c^2} \left[c^2 z + \frac{1}{3} z^3 \right]_0^h = \frac{\pi ab}{c^2} (c^2 h + \frac{1}{3} h^3) = \frac{\pi abh}{3c^2} (3c^2 + h^2)$$

(b) $A_0 = A(0) = \pi ab$ and $A_h = A(h) = \frac{\pi ab}{c^2} (c^2 + h^2)$, from part (a) $\Rightarrow V = \frac{\pi abh}{3c^2} (3c^2 + h^2)$
 $= \frac{\pi abh}{3} \left(2 + 1 + \frac{h^2}{c^2} \right) = \frac{\pi abh}{3} \left(2 + \frac{c^2+h^2}{c^2} \right) = \frac{h}{3} \left[2\pi ab + \frac{\pi ab}{c^2} (c^2 + h^2) \right] = \frac{h}{3} (2A_0 + A_h)$

(c) $A_m = A\left(\frac{h}{2}\right) = \frac{\pi ab}{c^2} \left(c^2 + \frac{h^2}{4} \right) = \frac{\pi ab}{4c^2} (4c^2 + h^2) \Rightarrow \frac{h}{6} (A_0 + 4A_m + A_h)$
 $= \frac{h}{6} \left[\pi ab + \frac{\pi ab}{c^2} (4c^2 + h^2) + \frac{\pi ab}{c^2} (c^2 + h^2) \right] = \frac{\pi abh}{6c^2} (c^2 + 4c^2 + h^2 + c^2 + h^2) = \frac{\pi abh}{6c^2} (6c^2 + 2h^2)$
 $= \frac{\pi abh}{3c^2} (3c^2 + h^2) = V$ from part (a)

81. $y = y_1 \Rightarrow \frac{z}{c} = \frac{y_1^2}{b^2} - \frac{x^2}{a^2}$, a parabola in the plane $y = y_1 \Rightarrow$ vertex when $\frac{dz}{dx} = 0$ or $c \frac{dz}{dx} = -\frac{2x}{a^2} = 0 \Rightarrow x = 0$
 \Rightarrow Vertex $\left(0, y_1, \frac{cy_1^2}{b^2} \right)$; writing the parabola as $x^2 = -\frac{a^2}{c} z + \frac{a^2 y_1^2}{b^2}$ we see that $4p = -\frac{a^2}{c} \Rightarrow p = -\frac{a^2}{4c}$
 \Rightarrow Focus $\left(0, y_1, \frac{cy_1^2}{b^2} - \frac{a^2}{4c} \right)$

82. The curve has the general form $Ax^2 + By^2 + Dxy + Gx + Hy + K = 0$ which is the same form as Eq. (1) in Section 10.3 for a conic section (including the degenerate cases) in the xy -plane.

83. No, it is not mere coincidence. A plane parallel to one of the coordinate planes will set one of the variables $x, y,$ or z equal to a constant in the general equation $Ax^2 + By^2 + Cz^2 + Dxy + Eyz + Fxz + Gx + Hy + Jz + K = 0$ for a quadric surface. The resulting equation then has the general form for a conic in that parallel plane. For example, setting $y = y_1$ results in the equation $Ax^2 + Cz^2 + D'x + E'z + Fxz + Gx + Jz + K' = 0$ where $D' = Dy_1, E' = Ey_1,$ and $K' = K + By_1^2 + Hy_1$, which is the general form of a conic section in the plane $y = y_1$ by Section 10.3.

84. The trace will be a conic section. To see why, solve the plane's equation $Ax + By + Cz = 0$ for one of the variables in terms of the other two and substitute into the equation $Ax^2 + By^2 + Cz^2 + \dots + K = 0$. The result will be a second degree equation in the remaining two variables. By Section 10.3, this equation will represent a conic section. (See also the discussion in Exercises 82 and 83.)

85. $z = y^2$

86. $z = 1 - y^2$

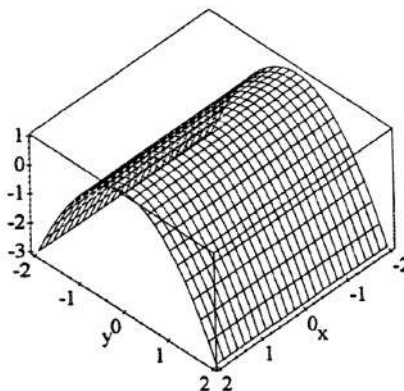
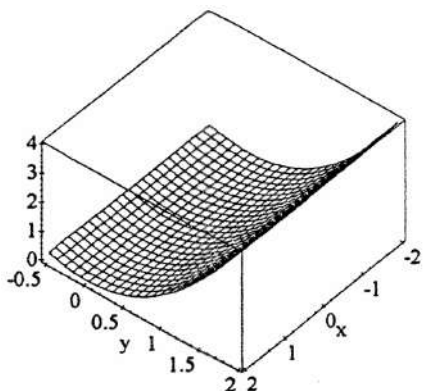

87. $z = x^2 + y^2$

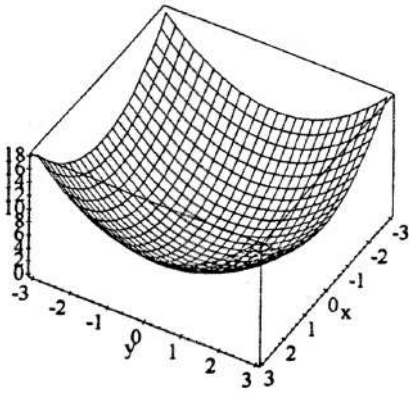

88. $z = x^2 + 2y^2$

(a)

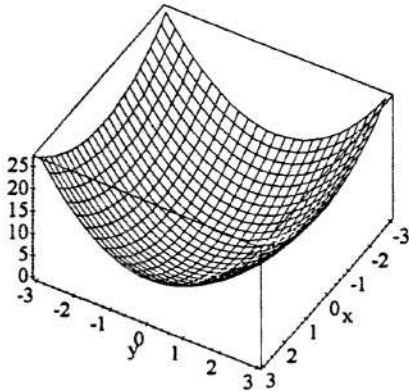

(b)

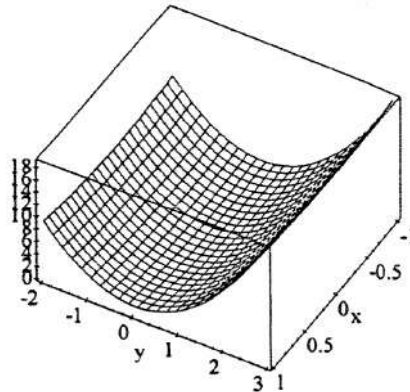

(c)

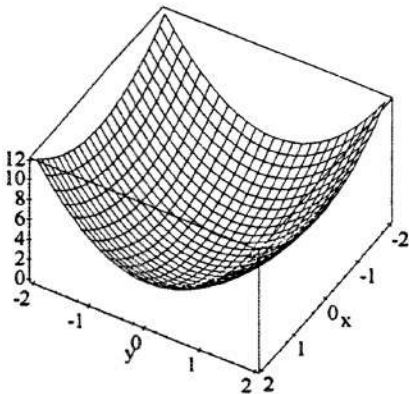

(d)

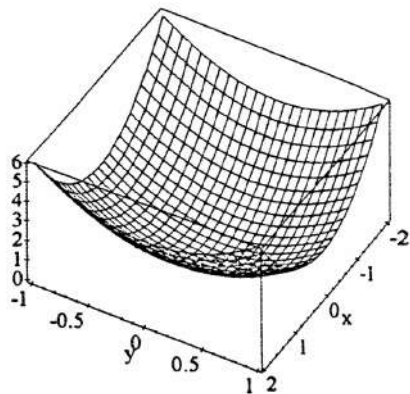

89-94. Example CAS commands:

Maple:

```
with( plots );
eq := x^2/9 + y^2/36 = 1 - z^2/25;
implicitplot3d( eq, x=-3..3, y=-6..6, z=-5..5, scaling=constrained,
                shading=zhue, axes=boxed, title="#89 (Section 12.6)" );
```

Mathematica: (functions and domains may vary):

In the following chapter, you will consider contours or level curves for surfaces in three dimensions. For the purposes of plotting the functions of two variables expressed implicitly in this section, we will call upon the function **ContourPlot3D**.

To insert the stated function, write all terms on the same side of the equal sign and the default contour equating that expression to zero will be plotted.

This built-in function requires the loading of a special graphics package.

```
<<Graphics`ContourPlot3D`
```

```
Clear[x, y, z]
```

```
ContourPlot3D[x^2/9 - y^2/16 - z^2/2 - 1, {x, -9, 9}, {y, -12, 12}, {z, -5, 5},
```

```
  Axes → True, AxesLabel → {x, y, z}, Boxed → False,
```

```
  PlotLabel → "Elliptic Hyperboloid of Two Sheets"]
```

Your identification of the plot may or may not be able to be done without considering the graph.

CHAPTER 12 PRACTICE EXERCISES

- $3\langle -3, 4 \rangle - 4\langle 2, -5 \rangle = \langle -9 - 8, 12 + 20 \rangle = \langle -17, 32 \rangle$
 - $\sqrt{17^2 + 32^2} = \sqrt{1313}$
- $\langle -3 + 2, 4 - 5 \rangle = \langle -1, -1 \rangle$
 - $\sqrt{(-1)^2 + (-1)^2} = \sqrt{2}$
- $\langle -2(-3), -2(4) \rangle = \langle 6, -8 \rangle$
 - $\sqrt{6^2 + (-8)^2} = 10$
- $\langle 5(2), 5(-5) \rangle = \langle 10, -25 \rangle$
 - $\sqrt{10^2 + (-25)^2} = \sqrt{725} = 5\sqrt{29}$
- $\frac{\pi}{6}$ radians below the negative x-axis: $\langle -\frac{\sqrt{3}}{2}, -\frac{1}{2} \rangle$ [assuming counterclockwise].
- $\langle \frac{\sqrt{3}}{2}, \frac{1}{2} \rangle$
- $2\left(\frac{1}{\sqrt{4^2+1^2}}\right)(4\mathbf{i} - \mathbf{j}) = \left(\frac{8}{\sqrt{17}}\mathbf{i} - \frac{2}{\sqrt{17}}\mathbf{j}\right)$
- $-5\left(\frac{1}{\sqrt{\left(\frac{3}{5}\right)^2 + \left(\frac{4}{5}\right)^2}}\right)\left(\frac{3}{5}\mathbf{i} + \frac{4}{5}\mathbf{j}\right) = (-3\mathbf{i} - 4\mathbf{j})$
- $\text{length} = \left|\sqrt{2}\mathbf{i} + \sqrt{2}\mathbf{j}\right| = \sqrt{2+2} = 2, \sqrt{2}\mathbf{i} + \sqrt{2}\mathbf{j} = 2\left(\frac{1}{\sqrt{2}}\mathbf{i} + \frac{1}{\sqrt{2}}\mathbf{j}\right) \Rightarrow$ the direction is $\frac{1}{\sqrt{2}}\mathbf{i} + \frac{1}{\sqrt{2}}\mathbf{j}$
- $\text{length} = |-\mathbf{i} - \mathbf{j}| = \sqrt{1+1} = \sqrt{2}, -\mathbf{i} - \mathbf{j} = \sqrt{2}\left(-\frac{1}{\sqrt{2}}\mathbf{i} - \frac{1}{\sqrt{2}}\mathbf{j}\right) \Rightarrow$ the direction is $-\frac{1}{\sqrt{2}}\mathbf{i} - \frac{1}{\sqrt{2}}\mathbf{j}$
- $t = \frac{\pi}{2} \Rightarrow \mathbf{v} = (-2 \sin \frac{\pi}{2})\mathbf{i} + (2 \cos \frac{\pi}{2})\mathbf{j} = -2\mathbf{i}; \text{length} = |-2\mathbf{i}| = \sqrt{4+0} = 2; -2\mathbf{i} = 2(-\mathbf{i}) \Rightarrow$ the direction is $-\mathbf{i}$
- $t = \ln 2 \Rightarrow \mathbf{v} = (e^{\ln 2} \cos(\ln 2) - e^{\ln 2} \sin(\ln 2))\mathbf{i} + (e^{\ln 2} \sin(\ln 2) + e^{\ln 2} \cos(\ln 2))\mathbf{j}$
 $= (2 \cos(\ln 2) - 2 \sin(\ln 2))\mathbf{i} + (2 \sin(\ln 2) + 2 \cos(\ln 2))\mathbf{j} = 2[(\cos(\ln 2) - \sin(\ln 2))\mathbf{i} + (\sin(\ln 2) + \cos(\ln 2))\mathbf{j}]$
 $\text{length} = |2[(\cos(\ln 2) - \sin(\ln 2))\mathbf{i} + (\sin(\ln 2) + \cos(\ln 2))\mathbf{j}]| = 2\sqrt{(\cos(\ln 2) - \sin(\ln 2))^2 + (\cos(\ln 2) + \sin(\ln 2))^2}$
 $= 2\sqrt{2\cos^2(\ln 2) + 2\sin^2(\ln 2)} = 2\sqrt{2};$
 $2[(\cos(\ln 2) - \sin(\ln 2))\mathbf{i} + (\sin(\ln 2) + \cos(\ln 2))\mathbf{j}] = 2\sqrt{2}\left(\frac{(\cos(\ln 2) - \sin(\ln 2))\mathbf{i} + (\sin(\ln 2) + \cos(\ln 2))\mathbf{j}}{\sqrt{2}}\right)$
 $\Rightarrow \text{direction} = \frac{(\cos(\ln 2) - \sin(\ln 2))}{\sqrt{2}}\mathbf{i} + \frac{(\sin(\ln 2) + \cos(\ln 2))}{\sqrt{2}}\mathbf{j}$
- $\text{length} = |2\mathbf{i} - 3\mathbf{j} + 6\mathbf{k}| = \sqrt{4+9+36} = 7, 2\mathbf{i} - 3\mathbf{j} + 6\mathbf{k} = 7\left(\frac{2}{7}\mathbf{i} - \frac{3}{7}\mathbf{j} + \frac{6}{7}\mathbf{k}\right) \Rightarrow$ the direction is $\frac{2}{7}\mathbf{i} - \frac{3}{7}\mathbf{j} + \frac{6}{7}\mathbf{k}$

$$14. \text{length} = |\mathbf{i} + 2\mathbf{j} - \mathbf{k}| = \sqrt{1 + 4 + 1} = \sqrt{6}, \mathbf{i} + 2\mathbf{j} - \mathbf{k} = \sqrt{6} \left(\frac{1}{\sqrt{6}}\mathbf{i} + \frac{2}{\sqrt{6}}\mathbf{j} - \frac{1}{\sqrt{6}}\mathbf{k} \right) \Rightarrow \text{the direction is}$$

$$\frac{1}{\sqrt{6}}\mathbf{i} + \frac{2}{\sqrt{6}}\mathbf{j} - \frac{1}{\sqrt{6}}\mathbf{k}$$

$$15. 2 \frac{\mathbf{v}}{|\mathbf{v}|} = 2 \cdot \frac{4\mathbf{i} - \mathbf{j} + 4\mathbf{k}}{\sqrt{4^2 + (-1)^2 + 4^2}} = 2 \cdot \frac{4\mathbf{i} - \mathbf{j} + 4\mathbf{k}}{\sqrt{33}} = \frac{8}{\sqrt{33}}\mathbf{i} - \frac{2}{\sqrt{33}}\mathbf{j} + \frac{8}{\sqrt{33}}\mathbf{k}$$

$$16. -5 \frac{\mathbf{v}}{|\mathbf{v}|} = -5 \cdot \frac{\left(\frac{3}{5}\right)\mathbf{i} + \left(\frac{4}{5}\right)\mathbf{k}}{\sqrt{\left(\frac{3}{5}\right)^2 + \left(\frac{4}{5}\right)^2}} = -5 \cdot \frac{\left(\frac{3}{5}\right)\mathbf{i} + \left(\frac{4}{5}\right)\mathbf{k}}{\sqrt{\frac{9}{25} + \frac{16}{25}}} = -3\mathbf{i} - 4\mathbf{k}$$

$$17. |\mathbf{v}| = \sqrt{1 + 1} = \sqrt{2}, |\mathbf{u}| = \sqrt{4 + 1 + 4} = 3, \mathbf{v} \cdot \mathbf{u} = 3, \mathbf{u} \cdot \mathbf{v} = 3, \mathbf{v} \times \mathbf{u} = \begin{vmatrix} \mathbf{i} & \mathbf{j} & \mathbf{k} \\ 1 & 1 & 0 \\ 2 & 1 & -2 \end{vmatrix} = -2\mathbf{i} + 2\mathbf{j} - \mathbf{k},$$

$$\mathbf{u} \times \mathbf{v} = -(\mathbf{v} \times \mathbf{u}) = 2\mathbf{i} - 2\mathbf{j} + \mathbf{k}, |\mathbf{v} \times \mathbf{u}| = \sqrt{4 + 4 + 1} = 3, \theta = \cos^{-1} \left(\frac{\mathbf{v} \cdot \mathbf{u}}{|\mathbf{v}||\mathbf{u}|} \right) = \cos^{-1} \left(\frac{1}{\sqrt{2}} \right) = \frac{\pi}{4},$$

$$|\mathbf{u}| \cos \theta = \frac{3}{\sqrt{2}}, \text{proj}_{\mathbf{v}} \mathbf{u} = \left(\frac{\mathbf{v} \cdot \mathbf{u}}{|\mathbf{v}||\mathbf{v}|} \right) \mathbf{v} = \frac{3}{2}(\mathbf{i} + \mathbf{j})$$

$$18. |\mathbf{v}| = \sqrt{1^2 + 1^2 + 2^2} = \sqrt{6}, |\mathbf{u}| = \sqrt{(-1)^2 + (-1)^2} = \sqrt{2}, \mathbf{v} \cdot \mathbf{u} = (1)(-1) + (1)(0) + (2)(-1) = -3,$$

$$\mathbf{u} \cdot \mathbf{v} = -3, \mathbf{v} \times \mathbf{u} = \begin{vmatrix} \mathbf{i} & \mathbf{j} & \mathbf{k} \\ 1 & 1 & 2 \\ -1 & 0 & -1 \end{vmatrix} = -\mathbf{i} - \mathbf{j} + \mathbf{k}, \mathbf{u} \times \mathbf{v} = -(\mathbf{v} \times \mathbf{u}) = \mathbf{i} + \mathbf{j} - \mathbf{k},$$

$$|\mathbf{v} \times \mathbf{u}| = \sqrt{(-1)^2 + (-1)^2 + 1^2} = \sqrt{3}, \theta = \cos^{-1} \left(\frac{\mathbf{v} \cdot \mathbf{u}}{|\mathbf{v}||\mathbf{u}|} \right) = \cos^{-1} \left(\frac{-3}{\sqrt{6}\sqrt{2}} \right) = \cos^{-1} \left(\frac{-3}{\sqrt{12}} \right)$$

$$= \cos^{-1} \left(-\frac{\sqrt{3}}{2} \right) = \frac{5\pi}{6}, |\mathbf{u}| \cos \theta = \sqrt{2} \cdot \left(\frac{-\sqrt{3}}{2} \right) = -\frac{\sqrt{6}}{2}, \text{proj}_{\mathbf{v}} \mathbf{u} = \left(\frac{\mathbf{v} \cdot \mathbf{u}}{|\mathbf{v}||\mathbf{v}|} \right) \mathbf{v} = \frac{-3}{6}(\mathbf{i} + \mathbf{j} + 2\mathbf{k}) = -\frac{1}{2}(\mathbf{i} + \mathbf{j} + \mathbf{k})$$

$$19. \mathbf{u} = \left(\frac{\mathbf{v} \cdot \mathbf{u}}{|\mathbf{v}||\mathbf{v}|} \right) \mathbf{v} + \left[\mathbf{u} - \left(\frac{\mathbf{v} \cdot \mathbf{u}}{|\mathbf{v}||\mathbf{v}|} \right) \mathbf{v} \right] = \frac{4}{3}(2\mathbf{i} + \mathbf{j} - \mathbf{k}) + \left[(\mathbf{i} + \mathbf{j} - 5\mathbf{k}) - \frac{4}{3}(2\mathbf{i} + \mathbf{j} - \mathbf{k}) \right] = \frac{4}{3}(2\mathbf{i} + \mathbf{j} - \mathbf{k}) - \frac{1}{3}(5\mathbf{i} + \mathbf{j} + 11\mathbf{k}),$$

where $\mathbf{v} \cdot \mathbf{u} = 8$ and $\mathbf{v} \cdot \mathbf{v} = 6$

$$20. \mathbf{u} = \left(\frac{\mathbf{v} \cdot \mathbf{u}}{|\mathbf{v}||\mathbf{v}|} \right) \mathbf{v} + \left[\mathbf{u} - \left(\frac{\mathbf{v} \cdot \mathbf{u}}{|\mathbf{v}||\mathbf{v}|} \right) \mathbf{v} \right] = -\frac{1}{3}(\mathbf{i} - 2\mathbf{j}) + \left[(\mathbf{i} + \mathbf{j} + \mathbf{k}) - \left(\frac{-1}{3} \right) (\mathbf{i} - 2\mathbf{j}) \right] = -\frac{1}{3}(\mathbf{i} - 2\mathbf{j}) + \left(\frac{4}{3}\mathbf{i} + \frac{5}{3}\mathbf{j} + \mathbf{k} \right),$$

where $\mathbf{v} \cdot \mathbf{u} = -1$ and $\mathbf{v} \cdot \mathbf{v} = 3$

$$21. \mathbf{u} \times \mathbf{v} = \begin{vmatrix} \mathbf{i} & \mathbf{j} & \mathbf{k} \\ 1 & 0 & 0 \\ 1 & 1 & 0 \end{vmatrix} = \mathbf{k}$$

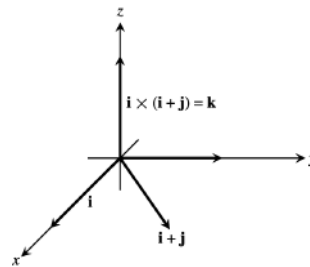

$$22. \mathbf{u} \times \mathbf{v} = \begin{vmatrix} \mathbf{i} & \mathbf{j} & \mathbf{k} \\ 1 & -1 & 0 \\ 1 & 1 & 0 \end{vmatrix} = 2\mathbf{k}$$

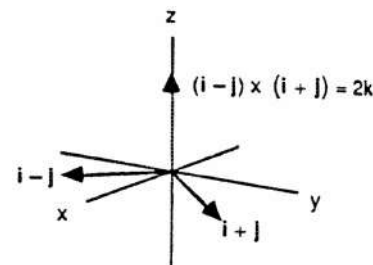

23. Let $\mathbf{v} = v_1\mathbf{i} + v_2\mathbf{j} + v_3\mathbf{k}$ and $\mathbf{w} = w_1\mathbf{i} + w_2\mathbf{j} + w_3\mathbf{k}$. Then $|\mathbf{v} - 2\mathbf{w}|^2 = |(\mathbf{v}_1\mathbf{i} + v_2\mathbf{j} + v_3\mathbf{k}) - 2(w_1\mathbf{i} + w_2\mathbf{j} + w_3\mathbf{k})|^2$
 $= |(v_1 - 2w_1)\mathbf{i} + (v_2 - 2w_2)\mathbf{j} + (v_3 - 2w_3)\mathbf{k}|^2 = (\sqrt{(v_1 - 2w_1)^2 + (v_2 - 2w_2)^2 + (v_3 - 2w_3)^2})^2$
 $= (v_1^2 + v_2^2 + v_3^2) - 4(v_1w_1 + v_2w_2 + v_3w_3) + 4(w_1^2 + w_2^2 + w_3^2) = |\mathbf{v}|^2 - 4\mathbf{v} \cdot \mathbf{w} + 4|\mathbf{w}|^2$
 $= |\mathbf{v}|^2 - 4|\mathbf{v}||\mathbf{w}|\cos\theta + 4|\mathbf{w}|^2 = 4 - 4(2)(3)\left(\cos\frac{\pi}{3}\right) + 36 = 40 - 24\left(\frac{1}{2}\right) = 40 - 12 = 28 \Rightarrow |\mathbf{v} - 2\mathbf{w}| = \sqrt{28}$
 $= 2\sqrt{7}$

24. \mathbf{u} and \mathbf{v} are parallel when $\mathbf{u} \times \mathbf{v} = \mathbf{0} \Rightarrow \begin{vmatrix} \mathbf{i} & \mathbf{j} & \mathbf{k} \\ 2 & 4 & -5 \\ -4 & -8 & a \end{vmatrix} = \mathbf{0} \Rightarrow (4a - 40)\mathbf{i} + (20 - 2a)\mathbf{j} + (0)\mathbf{k} = \mathbf{0}$
 $\Rightarrow 4a - 40 = 0$ and $20 - 2a = 0 \Rightarrow a = 10$

25. (a) area $= |\mathbf{u} \times \mathbf{v}| = \text{abs} \begin{vmatrix} \mathbf{i} & \mathbf{j} & \mathbf{k} \\ 1 & 1 & -1 \\ 2 & 1 & 1 \end{vmatrix} = |2\mathbf{i} - 3\mathbf{j} - \mathbf{k}| = \sqrt{4 + 9 + 1} = \sqrt{14}$

(b) volume $= \mathbf{u} \cdot (\mathbf{v} \times \mathbf{w}) = \begin{vmatrix} 1 & 1 & -1 \\ 2 & 1 & 1 \\ -1 & -2 & 3 \end{vmatrix} = 1(3 + 2) + 1(-1 - 6) - 1(-4 + 1) = 1$

26. (a) area $= |\mathbf{u} \times \mathbf{v}| = \text{abs} \begin{vmatrix} \mathbf{i} & \mathbf{j} & \mathbf{k} \\ 1 & 1 & 0 \\ 0 & 1 & 0 \end{vmatrix} = |\mathbf{k}| = 1$

(b) volume $= \mathbf{u} \cdot (\mathbf{v} \times \mathbf{w}) = \begin{vmatrix} 1 & 1 & 0 \\ 0 & 1 & 0 \\ 1 & 1 & 1 \end{vmatrix} = 1(1 - 0) + 1(0 - 0) + 0 = 1$

27. The desired vector is $\mathbf{n} \times \mathbf{v}$ or $\mathbf{v} \times \mathbf{n}$ since $\mathbf{n} \times \mathbf{v}$ is perpendicular to both \mathbf{n} and \mathbf{v} and, therefore, also parallel to the plane.

28. If $a = 0$ and $b \neq 0$, then the line $by = c$ and \mathbf{i} are parallel. If $a \neq 0$ and $b = 0$, then the line $ax = c$ and \mathbf{j} are parallel. If a and b are both $\neq 0$, then $ax + by = c$ contains the points $(\frac{c}{a}, 0)$ and $(0, \frac{c}{b}) \Rightarrow$ the vector $ab(\frac{c}{a}\mathbf{i} - \frac{c}{b}\mathbf{j}) = c(b\mathbf{i} - a\mathbf{j})$ and the line are parallel. Therefore, the vector $b\mathbf{i} - a\mathbf{j}$ is parallel to the line $ax + by = c$ in every case.

29. The line L passes through the point $P(0, 0, -1)$ parallel to $\mathbf{v} = -\mathbf{i} + \mathbf{j} + \mathbf{k}$. With $\overrightarrow{PS} = 2\mathbf{i} + 2\mathbf{j} + \mathbf{k}$ and

$$\overrightarrow{PS} \times \mathbf{v} = \begin{vmatrix} \mathbf{i} & \mathbf{j} & \mathbf{k} \\ 2 & 2 & 1 \\ -1 & 1 & 1 \end{vmatrix} = (2 - 1)\mathbf{i} + (-1 - 2)\mathbf{j} + (2 + 2)\mathbf{k} = \mathbf{i} - 3\mathbf{j} + 4\mathbf{k}, \text{ we find the distance}$$

$$d = \frac{|\overrightarrow{PS} \times \mathbf{v}|}{|\mathbf{v}|} = \frac{\sqrt{1+9+16}}{\sqrt{1+1+1}} = \frac{\sqrt{26}}{\sqrt{3}} = \frac{\sqrt{78}}{3}.$$

30. The line L passes through the point $P(2, 2, 0)$ parallel to $\mathbf{v} = \mathbf{i} + \mathbf{j} + \mathbf{k}$. With $\overrightarrow{PS} = -2\mathbf{i} + 2\mathbf{j} + \mathbf{k}$ and

$$\overrightarrow{PS} \times \mathbf{v} = \begin{vmatrix} \mathbf{i} & \mathbf{j} & \mathbf{k} \\ -2 & 2 & 1 \\ 1 & 1 & 1 \end{vmatrix} = (2 - 1)\mathbf{i} + (1 + 2)\mathbf{j} + (-2 - 2)\mathbf{k} = \mathbf{i} + 3\mathbf{j} - 4\mathbf{k}, \text{ we find the distance}$$

$$d = \frac{|\overrightarrow{PS} \times \mathbf{v}|}{|\mathbf{v}|} = \frac{\sqrt{1+9+16}}{\sqrt{1+1+1}} = \frac{\sqrt{26}}{\sqrt{3}} = \frac{\sqrt{78}}{3}.$$

31. Parametric equations for the line are $x = 1 - 3t$, $y = 2$, $z = 3 + 7t$.

32. The line is parallel to $\vec{PQ} = 0\mathbf{i} + \mathbf{j} - \mathbf{k}$ and contains the point $P(1, 2, 0) \Rightarrow$ parametric equations are $x = 1, y = 2 + t, z = -t$ for $0 \leq t \leq 1$.
33. The point $P(4, 0, 0)$ lies on the plane $x - y = 4$, and $\vec{PS} = (6 - 4)\mathbf{i} + 0\mathbf{j} + (-6 + 0)\mathbf{k} = 2\mathbf{i} - 6\mathbf{k}$ with $\mathbf{n} = \mathbf{i} - \mathbf{j}$
 $\Rightarrow d = \frac{|\mathbf{n} \cdot \vec{PS}|}{|\mathbf{n}|} = \left| \frac{2+0+0}{\sqrt{1+1+0}} \right| = \frac{2}{\sqrt{2}} = \sqrt{2}$.
34. The point $P(0, 0, 2)$ lies on the plane $2x + 3y + z = 2$, and $\vec{PS} = (3 - 0)\mathbf{i} + (0 - 0)\mathbf{j} + (10 + 2)\mathbf{k} = 3\mathbf{i} + 8\mathbf{k}$ with $\mathbf{n} = 2\mathbf{i} + 3\mathbf{j} + \mathbf{k} \Rightarrow d = \frac{|\mathbf{n} \cdot \vec{PS}|}{|\mathbf{n}|} = \left| \frac{6+0+8}{\sqrt{4+9+1}} \right| = \frac{14}{\sqrt{14}} = \sqrt{14}$.
35. $P(3, -2, 1)$ and $\mathbf{n} = 2\mathbf{i} + \mathbf{j} - \mathbf{k} \Rightarrow (2)(x - 3) + (1)(y - (-2)) + (1)(z - 1) = 0 \Rightarrow 2x + y + z = 5$
36. $P(-1, 6, 0)$ and $\mathbf{n} = \mathbf{i} - 2\mathbf{j} + 3\mathbf{k} \Rightarrow (1)(x - (-1)) + (-2)(y - 6) + (3)(z - 0) = 0 \Rightarrow x - 2y + 3z = -13$
37. $P(1, -1, 2), Q(2, 1, 3)$ and $R(-1, 2, -1) \Rightarrow \vec{PQ} = \mathbf{i} + 2\mathbf{j} + \mathbf{k}, \vec{PR} = -2\mathbf{i} + 3\mathbf{j} - 3\mathbf{k}$ and $\vec{PQ} \times \vec{PR}$
 $= \begin{vmatrix} \mathbf{i} & \mathbf{j} & \mathbf{k} \\ 1 & 2 & 1 \\ -2 & 3 & -3 \end{vmatrix} = -9\mathbf{i} + \mathbf{j} + 7\mathbf{k}$ is normal to the plane $\Rightarrow (-9)(x - 1) + (1)(y + 1) + (7)(z - 2) = 0$
 $\Rightarrow -9x + y + 7z = 4$
38. $P(1, 0, 0), Q(0, 1, 0)$ and $R(0, 0, 1) \Rightarrow \vec{PQ} = -\mathbf{i} + \mathbf{j}, \vec{PR} = -\mathbf{i} + \mathbf{k}$ and $\vec{PQ} \times \vec{PR}$
 $= \begin{vmatrix} \mathbf{i} & \mathbf{j} & \mathbf{k} \\ -1 & 1 & 0 \\ -1 & 0 & 1 \end{vmatrix} = \mathbf{i} + \mathbf{j} + \mathbf{k}$ is normal to the plane $\Rightarrow (1)(x - 1) + (1)(y - 0) + (1)(z - 0) = 0$
 $\Rightarrow x + y + z = 1$
39. $(0, -\frac{1}{2}, -\frac{3}{2})$, since $t = -\frac{1}{2}, y = -\frac{1}{2}$ and $z = -\frac{3}{2}$ when $x = 0$; $(-1, 0, -3)$, since $t = -1, x = -1$ and $z = -3$ when $y = 0$; $(1, -1, 0)$, since $t = 0, x = 1$ and $y = -1$ when $z = 0$
40. $x = 2t, y = -t, z = -t$ represents a line containing the origin and perpendicular to the plane $2x - y - z = 4$; this line intersects the plane $3x - 5y + 2z = 6$ when t is the solution of $3(2t) - 5(-t) + 2(-t) = 6$
 $\Rightarrow t = \frac{2}{3} \Rightarrow (\frac{4}{3}, -\frac{2}{3}, -\frac{2}{3})$ is the point of intersection
41. $\mathbf{n}_1 = \mathbf{i}$ and $\mathbf{n}_2 = \mathbf{i} + \mathbf{j} + \sqrt{2}\mathbf{k} \Rightarrow$ the desired angle is $\cos^{-1} \left(\frac{\mathbf{n}_1 \cdot \mathbf{n}_2}{|\mathbf{n}_1| |\mathbf{n}_2|} \right) = \cos^{-1} \left(\frac{1}{2} \right) = \frac{\pi}{3}$
42. $\mathbf{n}_1 = \mathbf{i} + \mathbf{j}$ and $\mathbf{n}_2 = \mathbf{j} + \mathbf{k} \Rightarrow$ the desired angle is $\cos^{-1} \left(\frac{\mathbf{n}_1 \cdot \mathbf{n}_2}{|\mathbf{n}_1| |\mathbf{n}_2|} \right) = \cos^{-1} \left(\frac{1}{2} \right) = \frac{\pi}{3}$
43. The direction of the line is $\mathbf{n}_1 \times \mathbf{n}_2 = \begin{vmatrix} \mathbf{i} & \mathbf{j} & \mathbf{k} \\ 1 & 2 & 1 \\ 1 & -1 & 2 \end{vmatrix} = 5\mathbf{i} - \mathbf{j} - 3\mathbf{k}$. Since the point $(-5, 3, 0)$ is on both planes, the desired line is $x = -5 + 5t, y = 3 - t, z = -3t$.
44. The direction of the intersection is $\mathbf{n}_1 \times \mathbf{n}_2 = \begin{vmatrix} \mathbf{i} & \mathbf{j} & \mathbf{k} \\ 1 & 2 & -2 \\ 5 & -2 & -1 \end{vmatrix} = -6\mathbf{i} - 9\mathbf{j} - 12\mathbf{k} = -3(2\mathbf{i} + 3\mathbf{j} + 4\mathbf{k})$ and is the same as the direction of the given line.

45. (a) The corresponding normals are $\mathbf{n}_1 = 3\mathbf{i} + 6\mathbf{k}$ and $\mathbf{n}_2 = 2\mathbf{i} + 2\mathbf{j} - \mathbf{k}$ and since $\mathbf{n}_1 \cdot \mathbf{n}_2 = (3)(2) + (0)(2) + (6)(-1) = 6 + 0 - 6 = 0$, we have that the planes are orthogonal
- (b) The line of intersection is parallel to $\mathbf{n}_1 \times \mathbf{n}_2 = \begin{vmatrix} \mathbf{i} & \mathbf{j} & \mathbf{k} \\ 3 & 0 & 6 \\ 2 & 2 & -1 \end{vmatrix} = -12\mathbf{i} + 15\mathbf{j} + 6\mathbf{k}$. Now to find a point in the intersection, solve $\begin{cases} 3x + 6z = 1 \\ 2x + 2y - z = 3 \end{cases} \Rightarrow \begin{cases} 3x + 6z = 1 \\ 12x + 12y - 6z = 18 \end{cases} \Rightarrow 15x + 12y = 19 \Rightarrow x = 0$ and $y = \frac{19}{12} \Rightarrow (0, \frac{19}{12}, \frac{1}{6})$ is a point on the line we seek. Therefore, the line is $x = -12t$, $y = \frac{19}{12} + 15t$ and $z = \frac{1}{6} + 6t$.
46. A vector in the direction of the plane's normal is $\mathbf{n} = \mathbf{u} \times \mathbf{v} = \begin{vmatrix} \mathbf{i} & \mathbf{j} & \mathbf{k} \\ 2 & 3 & 1 \\ 1 & -1 & 2 \end{vmatrix} = 7\mathbf{i} - 3\mathbf{j} - 5\mathbf{k}$ and $P(1, 2, 3)$ on the plane $\Rightarrow 7(x - 1) - 3(y - 2) - 5(z - 3) = 0 \Rightarrow 7x - 3y - 5z = -14$.
47. Yes; $\mathbf{v} \cdot \mathbf{n} = (2\mathbf{i} - 4\mathbf{j} + \mathbf{k}) \cdot (2\mathbf{i} + \mathbf{j} + 0\mathbf{k}) = 2 \cdot 2 - 4 \cdot 1 + 1 \cdot 0 = 0 \Rightarrow$ the vector is orthogonal to the plane's normal $\Rightarrow \mathbf{v}$ is parallel to the plane
48. $\mathbf{n} \cdot \overrightarrow{PP_0} > 0$ represents the half-space of points lying on one side of the plane in the direction which the normal \mathbf{n} points
49. A normal to the plane is $\mathbf{n} = \overrightarrow{AB} \times \overrightarrow{AC} = \begin{vmatrix} \mathbf{i} & \mathbf{j} & \mathbf{k} \\ 2 & 0 & -1 \\ 2 & -1 & 0 \end{vmatrix} = -\mathbf{i} - 2\mathbf{j} - 2\mathbf{k} \Rightarrow$ the distance is $d = \left| \frac{\overrightarrow{AP} \cdot \mathbf{n}}{\|\mathbf{n}\|} \right| = \left| \frac{(\mathbf{i} + 4\mathbf{j}) \cdot (-\mathbf{i} - 2\mathbf{j} - 2\mathbf{k})}{\sqrt{1+4+4}} \right| = \left| \frac{-1-8+0}{3} \right| = 3$
50. $P(0, 0, 0)$ lies on the plane $2x + 3y + 5z = 0$, and $\overrightarrow{PS} = 2\mathbf{i} + 2\mathbf{j} + 3\mathbf{k}$ with $\mathbf{n} = 2\mathbf{i} + 3\mathbf{j} + 5\mathbf{k} \Rightarrow d = \left| \frac{\mathbf{n} \cdot \overrightarrow{PS}}{\|\mathbf{n}\|} \right| = \left| \frac{4+6+15}{\sqrt{4+9+25}} \right| = \frac{25}{\sqrt{38}}$
51. $\mathbf{n} = 2\mathbf{i} - \mathbf{j} - \mathbf{k}$ is normal to the plane $\Rightarrow \mathbf{n} \times \mathbf{v} = \begin{vmatrix} \mathbf{i} & \mathbf{j} & \mathbf{k} \\ 2 & -1 & -1 \\ 1 & 1 & 1 \end{vmatrix} = 0\mathbf{i} - 3\mathbf{j} + 3\mathbf{k} = -3\mathbf{j} + 3\mathbf{k}$ is orthogonal to \mathbf{v} and parallel to the plane
52. The vector $\mathbf{B} \times \mathbf{C}$ is normal to the plane of \mathbf{B} and $\mathbf{C} \Rightarrow \mathbf{A} \times (\mathbf{B} \times \mathbf{C})$ is orthogonal to \mathbf{A} and parallel to the plane of \mathbf{B} and \mathbf{C} :
- $$\mathbf{B} \times \mathbf{C} = \begin{vmatrix} \mathbf{i} & \mathbf{j} & \mathbf{k} \\ 1 & 2 & 1 \\ 1 & 1 & -2 \end{vmatrix} = -5\mathbf{i} + 3\mathbf{j} - \mathbf{k} \text{ and } \mathbf{A} \times (\mathbf{B} \times \mathbf{C}) = \begin{vmatrix} \mathbf{i} & \mathbf{j} & \mathbf{k} \\ 2 & -1 & 1 \\ -5 & 3 & -1 \end{vmatrix} = -2\mathbf{i} - 3\mathbf{j} + \mathbf{k}$$
- $\Rightarrow |\mathbf{A} \times (\mathbf{B} \times \mathbf{C})| = \sqrt{4 + 9 + 1} = \sqrt{14}$ and $\mathbf{u} = \frac{1}{\sqrt{14}}(-2\mathbf{i} - 3\mathbf{j} + \mathbf{k})$ is the desired unit vector.
53. A vector parallel to the line of intersection is $\mathbf{v} = \mathbf{n}_1 \times \mathbf{n}_2 = \begin{vmatrix} \mathbf{i} & \mathbf{j} & \mathbf{k} \\ 1 & 2 & 1 \\ 1 & -1 & 2 \end{vmatrix} = 5\mathbf{i} - \mathbf{j} - 3\mathbf{k}$
- $\Rightarrow |\mathbf{v}| = \sqrt{25 + 1 + 9} = \sqrt{35} \Rightarrow 2 \left(\frac{\mathbf{v}}{|\mathbf{v}|} \right) = \frac{2}{\sqrt{35}}(5\mathbf{i} - \mathbf{j} - 3\mathbf{k})$ is the desired vector.
54. The line containing $(0, 0, 0)$ normal to the plane is represented by $x = 2t$, $y = -t$, and $z = -t$. This line intersects the plane $3x - 5y + 2z = 6$ when $3(2t) - 5(-t) + 2(-t) = 6 \Rightarrow t = \frac{2}{3} \Rightarrow$ the point is $(\frac{4}{3}, -\frac{2}{3}, -\frac{2}{3})$.

55. The line is represented by $x = 3 + 2t$, $y = 2 - t$, and $z = 1 + 2t$. It meets the plane $2x - y + 2z = -2$ when $2(3 + 2t) - (2 - t) + 2(1 + 2t) = -2 \Rightarrow t = -\frac{8}{9} \Rightarrow$ the point is $(\frac{11}{9}, \frac{26}{9}, -\frac{7}{9})$.

56. The direction of the intersection is $\mathbf{v} = \mathbf{n}_1 \times \mathbf{n}_2 = \begin{vmatrix} \mathbf{i} & \mathbf{j} & \mathbf{k} \\ 2 & 1 & -1 \\ 1 & 1 & 2 \end{vmatrix} = 3\mathbf{i} - 5\mathbf{j} + \mathbf{k} \Rightarrow \theta = \cos^{-1} \left(\frac{\mathbf{v} \cdot \mathbf{i}}{|\mathbf{v}| |\mathbf{i}|} \right)$
 $= \cos^{-1} \left(\frac{3}{\sqrt{35}} \right) \approx 59.5^\circ$

57. The intersection occurs when $(3 + 2t) + 3(2t) - t = -4 \Rightarrow t = -1 \Rightarrow$ the point is $(1, -2, -1)$. The required line must be perpendicular to both the given line and to the normal, and hence is parallel to $\begin{vmatrix} \mathbf{i} & \mathbf{j} & \mathbf{k} \\ 2 & 2 & 1 \\ 1 & 3 & -1 \end{vmatrix}$
 $= -5\mathbf{i} + 3\mathbf{j} + 4\mathbf{k} \Rightarrow$ the line is represented by $x = 1 - 5t$, $y = -2 + 3t$, and $z = -1 + 4t$.

58. If $P(a, b, c)$ is a point on the line of intersection, then P lies in both planes $\Rightarrow a - 2b + c + 3 = 0$ and $2a - b - c + 1 = 0 \Rightarrow (a - 2b + c + 3) + k(2a - b - c + 1) = 0$ for all k .

59. The vector $\vec{AB} \times \vec{CD} = \begin{vmatrix} \mathbf{i} & \mathbf{j} & \mathbf{k} \\ 3 & -2 & 4 \\ \frac{26}{5} & 0 & -\frac{26}{5} \end{vmatrix} = \frac{26}{5} (2\mathbf{i} + 7\mathbf{j} + 2\mathbf{k})$ is normal to the plane and $A(-2, 0, -3)$ lies on the plane $\Rightarrow 2(x + 2) + 7(y - 0) + 2(z - (-3)) = 0 \Rightarrow 2x + 7y + 2z + 10 = 0$ is an equation of the plane.

60. Yes; the line's direction vector is $2\mathbf{i} + 3\mathbf{j} - 5\mathbf{k}$ which is parallel to the line and also parallel to the normal $-4\mathbf{i} - 6\mathbf{j} + 10\mathbf{k}$ to the plane \Rightarrow the line is orthogonal to the plane.

61. The vector $\vec{PQ} \times \vec{PR} = \begin{vmatrix} \mathbf{i} & \mathbf{j} & \mathbf{k} \\ 2 & -1 & 3 \\ -3 & 0 & 1 \end{vmatrix} = -\mathbf{i} - 11\mathbf{j} - 3\mathbf{k}$ is normal to the plane.

(a) No, the plane is not orthogonal to $\vec{PQ} \times \vec{PR}$.

(b) No, these equations represent a line, not a plane.

(c) No, the plane $(x + 2) + 11(y - 1) - 3z = 0$ has normal $\mathbf{i} + 11\mathbf{j} - 3\mathbf{k}$ which is not parallel to $\vec{PQ} \times \vec{PR}$.

(d) No, this vector equation is equivalent to the equations $3y + 3z = 3$, $3x - 2z = -6$, and $3x + 2y = -4$
 $\Rightarrow x = -\frac{4}{3} - \frac{2}{3}t$, $y = t$, $z = 1 - t$, which represents a line, not a plane.

(e) Yes, this is a plane containing the point $R(-2, 1, 0)$ with normal $\vec{PQ} \times \vec{PR}$.

62. (a) The line through A and B is $x = 1 + t$, $y = -t$, $z = -1 + 5t$; the line through C and D must be parallel and is $L_1: x = 1 + t$, $y = 2 - t$, $z = 3 + 5t$. The line through B and C is $x = 1$, $y = 2 + 2s$, $z = 3 + 4s$; the line through A and D must be parallel and is $L_2: x = 2$, $y = -1 + 2s$, $z = 4 + 4s$. The lines L_1 and L_2 intersect at $D(2, 1, 8)$ where $t = 1$ and $s = 1$.

(b) $\cos \theta = \frac{(2\mathbf{j} + 4\mathbf{k}) \cdot (\mathbf{i} - \mathbf{j} + 5\mathbf{k})}{\sqrt{20} \sqrt{27}} = \frac{3}{\sqrt{15}}$

(c) $\left(\frac{\vec{BA} \cdot \vec{BC}}{\vec{BC} \cdot \vec{BC}} \right) \vec{BC} = \frac{18}{20} \vec{BC} = \frac{9}{5} (\mathbf{j} + 2\mathbf{k})$ where $\vec{BA} = \mathbf{i} - \mathbf{j} + 5\mathbf{k}$ and $\vec{BC} = 2\mathbf{j} + 4\mathbf{k}$

(d) $\text{area} = |(2\mathbf{j} + 4\mathbf{k}) \times (\mathbf{i} - \mathbf{j} + 5\mathbf{k})| = |14\mathbf{i} + 4\mathbf{j} - 2\mathbf{k}| = 6\sqrt{6}$

(e) From part (d), $\mathbf{n} = 14\mathbf{i} + 4\mathbf{j} - 2\mathbf{k}$ is normal to the plane $\Rightarrow 14(x - 1) + 4(y - 0) - 2(z + 1) = 0$
 $\Rightarrow 7x + 2y - z = 8$.

(f) From part (d), $\mathbf{n} = 14\mathbf{i} + 4\mathbf{j} - 2\mathbf{k} \Rightarrow$ the area of the projection on the yz -plane is $|\mathbf{n} \cdot \mathbf{i}| = 14$; the area of the projection on the xy -plane is $|\mathbf{n} \cdot \mathbf{j}| = 4$; and the area of the projection on the xz -plane is $|\mathbf{n} \cdot \mathbf{k}| = 2$.

63. $\vec{AB} = -2\mathbf{i} + \mathbf{j} + \mathbf{k}$, $\vec{CD} = \mathbf{i} + 4\mathbf{j} - \mathbf{k}$, and $\vec{AC} = 2\mathbf{i} + \mathbf{j} \Rightarrow \mathbf{n} = \begin{vmatrix} \mathbf{i} & \mathbf{j} & \mathbf{k} \\ -2 & 1 & 1 \\ 1 & 4 & -1 \end{vmatrix} = -5\mathbf{i} - \mathbf{j} - 9\mathbf{k} \Rightarrow$ the distance is

$$d = \left| \frac{(2\mathbf{i} + \mathbf{j}) \cdot (-5\mathbf{i} - \mathbf{j} - 9\mathbf{k})}{\sqrt{25 + 1 + 81}} \right| = \frac{11}{\sqrt{107}}$$

64. $\vec{AB} = -2\mathbf{i} + 4\mathbf{j} - \mathbf{k}$, $\vec{CD} = \mathbf{i} - \mathbf{j} + 2\mathbf{k}$, and $\vec{AC} = -3\mathbf{i} + 3\mathbf{j} \Rightarrow \mathbf{n} = \begin{vmatrix} \mathbf{i} & \mathbf{j} & \mathbf{k} \\ -2 & 4 & -1 \\ 1 & -1 & 2 \end{vmatrix} = 7\mathbf{i} + 3\mathbf{j} - 2\mathbf{k} \Rightarrow$ the distance

is $d = \left| \frac{(-3\mathbf{i} + 3\mathbf{j}) \cdot (7\mathbf{i} + 3\mathbf{j} - 2\mathbf{k})}{\sqrt{49 + 9 + 4}} \right| = \frac{12}{\sqrt{62}}$

65. $x^2 + y^2 + z^2 = 4$

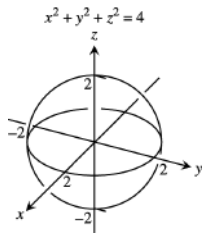

66. $x^2 + (y - 1)^2 + z^2 = 1$

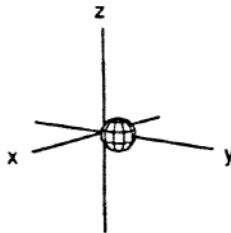

67. $4x^2 + 4y^2 + z^2 = 4$

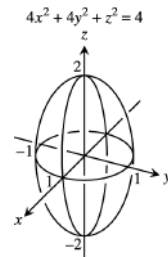

68. $36x^2 + 9y^2 + 4z^2 = 36$

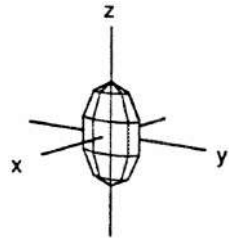

69. $z = -(x^2 + y^2)$

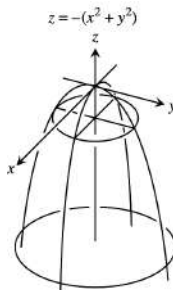

70. $y = -(x^2 + z^2)$

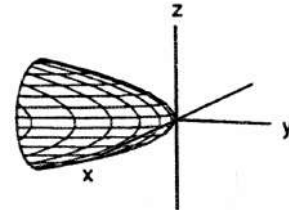

71. $x^2 + y^2 = z^2$

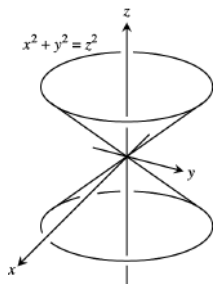

72. $x^2 + z^2 = y^2$

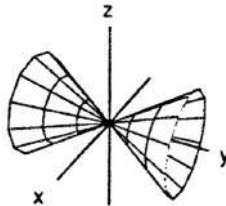

73. $x^2 + y^2 - z^2 = 4$

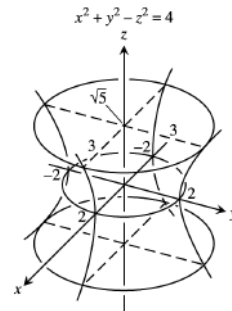

74. $4y^2 + z^2 - 4x^2 = 4$

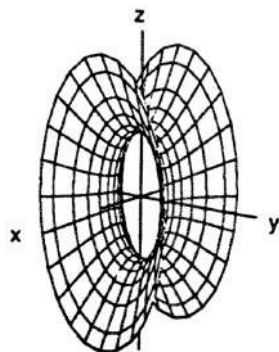

75. $y^2 - x^2 - z^2 = 1$

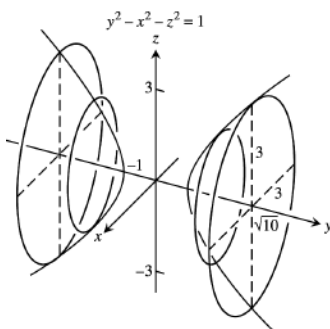

76. $z^2 - x^2 - y^2 = 1$

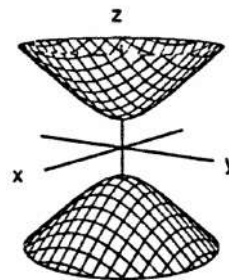
CHAPTER 12 ADDITIONAL AND ADVANCED EXERCISES

- Information from ship A indicates the submarine is now on the line $L_1: x = 4 + 2t, y = 3t, z = -\frac{1}{3}t$; information from ship B indicates the submarine is now on the line $L_2: x = 18s, y = 5 - 6s, z = -s$. The current position of the sub is $(6, 3, -\frac{1}{3})$ and occurs when the lines intersect at $t = 1$ and $s = \frac{1}{3}$. The straight line path of the submarine contains both points $P(2, -1, -\frac{1}{3})$ and $Q(6, 3, -\frac{1}{3})$; the line representing this path is $L: x = 2 + 4t, y = -1 + 4t, z = -\frac{1}{3}$. The submarine traveled the distance between P and Q in 4 minutes \Rightarrow a speed of $\frac{|\vec{PQ}|}{4} = \frac{\sqrt{32}}{4} = \sqrt{2}$ thousand ft/min. In 20 minutes the submarine will move $20\sqrt{2}$ thousand ft from Q along the line L $\Rightarrow 20\sqrt{2} = \sqrt{(2 + 4t - 6)^2 + (-1 + 4t - 3)^2 + 0^2} \Rightarrow 800 = 16(t - 1)^2 + 16(t - 1)^2 = 32(t - 1)^2 \Rightarrow (t - 1)^2 = \frac{800}{32} = 25 \Rightarrow t = 6 \Rightarrow$ the submarine will be located at $(26, 23, -\frac{1}{3})$ in 20 minutes.
- H_2 stops its flight when $6 + 110t = 446 \Rightarrow t = 4$ hours. After 6 hours, H_1 is at $P(246, 57, 9)$ while H_2 is at $(446, 13, 0)$. The distance between P and Q is $\sqrt{(246 - 446)^2 + (57 - 13)^2 + (9 - 0)^2} \approx 204.98$ miles. At 150 mph, it would take about 1.37 hours for H_1 to reach H_2 .
- Torque = $|\vec{PQ} \times \mathbf{F}| \Rightarrow 15 \text{ ft}\cdot\text{lb} = |\vec{PQ}| |\mathbf{F}| \sin \frac{\pi}{2} = \frac{3}{4} \text{ ft} \cdot |\mathbf{F}| \Rightarrow |\mathbf{F}| = 20 \text{ lb}$
- Let $\mathbf{a} = \mathbf{i} + \mathbf{j} + \mathbf{k}$ be the vector from O to A and $\mathbf{b} = \mathbf{i} + 3\mathbf{j} + 2\mathbf{k}$ be the vector from O to B. The vector \mathbf{v} orthogonal to \mathbf{a} and $\mathbf{b} \Rightarrow \mathbf{v}$ is parallel to $\mathbf{b} \times \mathbf{a}$ (since the rotation is clockwise). Now $\mathbf{b} \times \mathbf{a} = \mathbf{i} + \mathbf{j} - 2\mathbf{k}$; $\text{proj}_{\mathbf{a}} \mathbf{b} = \left(\frac{\mathbf{a} \cdot \mathbf{b}}{\mathbf{a} \cdot \mathbf{a}}\right) \mathbf{a} = 2\mathbf{i} + 2\mathbf{j} + 2\mathbf{k} \Rightarrow (2, 2, 2)$ is the center of the circular path $(1, 3, 2)$ takes \Rightarrow radius = $\sqrt{1^2 + (-1)^2 + 0^2} = \sqrt{2} \Rightarrow$ arc length per second covered by the point is $\frac{3}{2}\sqrt{2}$ units/sec = $|\mathbf{v}|$ (velocity is constant). A unit vector in the direction of \mathbf{v} is $\frac{\mathbf{b} \times \mathbf{a}}{|\mathbf{b} \times \mathbf{a}|} = \frac{1}{\sqrt{6}}\mathbf{i} + \frac{1}{\sqrt{6}}\mathbf{j} - \frac{2}{\sqrt{6}}\mathbf{k} \Rightarrow \mathbf{v} = |\mathbf{v}| \left(\frac{\mathbf{b} \times \mathbf{a}}{|\mathbf{b} \times \mathbf{a}|}\right) = \frac{3}{2}\sqrt{2} \left(\frac{1}{\sqrt{6}}\mathbf{i} + \frac{1}{\sqrt{6}}\mathbf{j} - \frac{2}{\sqrt{6}}\mathbf{k}\right) = \frac{\sqrt{3}}{2}\mathbf{i} + \frac{\sqrt{3}}{2}\mathbf{j} - \sqrt{3}\mathbf{k}$
- (a) If $P(x, y, z)$ is a point in the plane determined by the three points $P_1(x_1, y_1, z_1)$, $P_2(x_2, y_2, z_2)$ and $P_3(x_3, y_3, z_3)$, then the vectors \vec{PP}_1 , \vec{PP}_2 and \vec{PP}_3 all lie in the plane. Thus $\vec{PP}_1 \cdot (\vec{PP}_2 \times \vec{PP}_3) = 0$

$$\Rightarrow \begin{vmatrix} x_1 - x & y_1 - y & z_1 - z \\ x_2 - x & y_2 - y & z_2 - z \\ x_3 - x & y_3 - y & z_3 - z \end{vmatrix} = 0$$

by the determinant formula for the triple scalar product in Section 10.4.

(b) Subtract row 1 from rows 2, 3, and 4 and evaluate the resulting determinant (which has the same value as the given determinant) by cofactor expansion about column 4. This expansion is exactly the determinant in part (a) so we have all points $P(x, y, z)$ in the plane determined by $P_1(x_1, y_1, z_1)$, $P_2(x_2, y_2, z_2)$, and $P_3(x_3, y_3, z_3)$.

6. Let $L_1: x = a_1s + b_1, y = a_2s + b_2, z = a_3s + b_3$ and $L_2: x = c_1t + d_1, y = c_2t + d_2, z = c_3t + d_3$. If $L_1 \parallel L_2$,

$$\text{then for some } k, a_i = kc_i, i = 1, 2, 3 \text{ and the determinant } \begin{vmatrix} a_1 & c_1 & b_1 - d_1 \\ a_2 & c_2 & b_2 - d_2 \\ a_3 & c_3 & b_3 - d_3 \end{vmatrix} = \begin{vmatrix} kc_1 & c_1 & b_1 - d_1 \\ kc_2 & c_2 & b_2 - d_2 \\ kc_3 & c_3 & b_3 - d_3 \end{vmatrix} = 0,$$

since the first column is a multiple of the second column. The lines L_1 and L_2 intersect if and only if the

$$\text{system } \begin{cases} a_1s - c_1t + (b_1 - d_1) = 0 \\ a_2s - c_2t + (b_2 - d_2) = 0 \\ a_3s - c_3t + (b_3 - d_3) = 0 \end{cases} \text{ has a nontrivial solution } \Leftrightarrow \text{the determinant of the coefficients is zero.}$$

7. (a) $\vec{BD} = \vec{AD} - \vec{AB}$

(b) $\vec{AP} = \vec{AB} + \frac{1}{2}\vec{BD} = \frac{1}{2}(\vec{AB} + \vec{AD})$

(c) $\vec{AC} = \vec{AB} + \vec{AD}$, so by part (b), $\vec{AP} = \frac{1}{2}\vec{AC}$

8. Extend \vec{CD} to \vec{CG} so that $\vec{CD} = \vec{DG}$. Then $\vec{CG} = t\vec{CF} = \vec{CB} + \vec{BG}$ and $t\vec{CF} = 3\vec{CE} + \vec{CA}$, since $ACBG$ is a parallelogram. If $t\vec{CF} - 3\vec{CE} - \vec{CA} = \mathbf{0}$, then $t - 3 - 1 = 0 \Rightarrow t = 4$, since F, E , and A are collinear.

Therefore, $\vec{CG} = 4\vec{CF} \Rightarrow \vec{CD} = 2\vec{CF} \Rightarrow F$ is the midpoint of \vec{CD} .

9. If $Q(x, y)$ is a point on the line $ax + by = c$, then $P_1\vec{Q} = (x - x_1)\mathbf{i} + (y - y_1)\mathbf{j}$, and $\mathbf{n} = a\mathbf{i} + b\mathbf{j}$ is normal to the line. The distance is $|\text{proj}_{\mathbf{n}} P_1\vec{Q}| = \left| \frac{[(x - x_1)\mathbf{i} + (y - y_1)\mathbf{j}] \cdot (a\mathbf{i} + b\mathbf{j})}{\sqrt{a^2 + b^2}} \right| = \frac{|a(x - x_1) + b(y - y_1)|}{\sqrt{a^2 + b^2}}$
 $= \frac{|ax_1 + by_1 - c|}{\sqrt{a^2 + b^2}}$, since $c = ax + by$.

10. (a) Let $Q(x, y, z)$ be any point on $Ax + By + Cz - D = 0$. Let $\vec{QP}_1 = (x - x_1)\mathbf{i} + (y - y_1)\mathbf{j} + (z - z_1)\mathbf{k}$, and $\mathbf{n} = \frac{A\mathbf{i} + B\mathbf{j} + C\mathbf{k}}{\sqrt{A^2 + B^2 + C^2}}$. The distance is $|\text{proj}_{\mathbf{n}} \vec{QP}_1| = \left| ((x - x_1)\mathbf{i} + (y - y_1)\mathbf{j} + (z - z_1)\mathbf{k}) \cdot \left(\frac{A\mathbf{i} + B\mathbf{j} + C\mathbf{k}}{\sqrt{A^2 + B^2 + C^2}} \right) \right|$
 $= \frac{|Ax_1 + By_1 + Cz_1 - (Ax + By + Cz)|}{\sqrt{A^2 + B^2 + C^2}} = \frac{|Ax_1 + By_1 + Cz_1 - D|}{\sqrt{A^2 + B^2 + C^2}}$.

- (b) Since both tangent planes are parallel, one-half of the distance between them is equal to the radius of the sphere, i.e., $r = \frac{1}{2} \frac{|3 - 9|}{\sqrt{1 + 1 + 1}} = \sqrt{3}$ (see also Exercise 17a). Clearly, the points $(1, 2, 3)$ and $(-1, -2, -3)$ are on the line containing the sphere's center. Hence, the line containing the center is $x = 1 + 2t$, $y = 2 + 4t$, $z = 3 + 6t$. The distance from the plane $x + y + z - 3 = 0$ to the center is $\sqrt{3}$
 $\Rightarrow \frac{|(1 + 2t) + (2 + 4t) + (3 + 6t) - 3|}{\sqrt{1 + 1 + 1}} = \sqrt{3}$ from part (a) $\Rightarrow t = 0 \Rightarrow$ the center is at $(1, 2, 3)$. Therefore an equation of the sphere is $(x - 1)^2 + (y - 2)^2 + (z - 3)^2 = 3$.

11. (a) If (x_1, y_1, z_1) is on the plane $Ax + By + Cz = D_1$, then the distance d between the planes is

$$d = \frac{|Ax_1 + By_1 + Cz_1 - D_2|}{\sqrt{A^2 + B^2 + C^2}} = \frac{|D_1 - D_2|}{|A\mathbf{i} + B\mathbf{j} + C\mathbf{k}|}, \text{ since } Ax_1 + By_1 + Cz_1 = D_1, \text{ by Exercise 10(a).}$$

(b) $d = \frac{|12 - 6|}{\sqrt{4 + 9 + 1}} = \frac{6}{\sqrt{14}}$

(c) $\frac{|2(3) + (-1)(2) + 2(-1) + 4|}{\sqrt{14}} = \frac{|2(3) + (-1)(2) + 2(-1) - D|}{\sqrt{14}} \Rightarrow D = 8 \text{ or } -4 \Rightarrow$ the desired plane is

$$2x - y + 2z = 8$$

- (d) Choose the point $(2, 0, 1)$ on the plane. Then $\frac{|3 - D|}{\sqrt{6}} = 5 \Rightarrow D = 3 \pm 5\sqrt{6} \Rightarrow$ the desired planes are

$$x - 2y + z = 3 + 5\sqrt{6} \text{ and } x - 2y + z = 3 - 5\sqrt{6}.$$

12. Let $\mathbf{n} = \vec{AB} \times \vec{BC}$ and $D(x, y, z)$ be any point in the plane determined by A, B and C . Then the point D lies in this plane if and only if $\vec{AD} \cdot \mathbf{n} = 0 \Leftrightarrow \vec{AD} \cdot (\vec{AB} \times \vec{BC}) = 0$.

13. $\mathbf{n} = \mathbf{i} + 2\mathbf{j} + 6\mathbf{k}$ is normal to the plane $x + 2y + 6z = 6$; $\mathbf{v} \times \mathbf{n} = \begin{vmatrix} \mathbf{i} & \mathbf{j} & \mathbf{k} \\ 1 & 1 & 1 \\ 1 & 2 & 6 \end{vmatrix} = 4\mathbf{i} - 5\mathbf{j} + \mathbf{k}$ is parallel to the

plane and perpendicular to the plane of \mathbf{v} and $\mathbf{n} \Rightarrow \mathbf{w} = \mathbf{n} \times (\mathbf{v} \times \mathbf{n}) = \begin{vmatrix} \mathbf{i} & \mathbf{j} & \mathbf{k} \\ 1 & 2 & 6 \\ 4 & -5 & 1 \end{vmatrix} = 32\mathbf{i} + 23\mathbf{j} - 13\mathbf{k}$ is a

vector parallel to the plane $x + 2y + 6z = 6$ in the direction of the projection vector $\text{proj}_P \mathbf{v}$. Therefore,

$$\text{proj}_P \mathbf{v} = \text{proj}_W \mathbf{v} = \left(\mathbf{v} \cdot \frac{\mathbf{w}}{|\mathbf{w}|} \right) \frac{\mathbf{w}}{|\mathbf{w}|} = \left(\frac{\mathbf{v} \cdot \mathbf{w}}{|\mathbf{w}|^2} \right) \mathbf{w} = \left(\frac{32 + 23 - 13}{32^2 + 23^2 + 13^2} \right) \mathbf{w} = \frac{42}{1722} \mathbf{w} = \frac{1}{41} \mathbf{w} = \frac{32}{41} \mathbf{i} + \frac{23}{41} \mathbf{j} - \frac{13}{41} \mathbf{k}$$

14. $\text{proj}_z \mathbf{w} = -\text{proj}_z \mathbf{v}$ and $\mathbf{w} - \text{proj}_z \mathbf{w} = \mathbf{v} - \text{proj}_z \mathbf{v} \Rightarrow \mathbf{w} = (\mathbf{w} - \text{proj}_z \mathbf{w}) + \text{proj}_z \mathbf{w} = (\mathbf{v} - \text{proj}_z \mathbf{v}) + \text{proj}_z \mathbf{w}$
 $= \mathbf{v} - 2 \text{proj}_z \mathbf{v} = \mathbf{v} - 2 \left(\frac{\mathbf{v} \cdot \mathbf{z}}{|\mathbf{z}|^2} \right) \mathbf{z}$

15. (a) $\mathbf{u} \times \mathbf{v} = 2\mathbf{i} \times 2\mathbf{j} = 4\mathbf{k} \Rightarrow (\mathbf{u} \times \mathbf{v}) \times \mathbf{C} = \mathbf{0}$; $(\mathbf{u} \cdot \mathbf{w})\mathbf{v} - (\mathbf{v} \cdot \mathbf{w})\mathbf{u} = 0\mathbf{v} - 0\mathbf{u} = \mathbf{0}$; $\mathbf{v} \times \mathbf{w} = 4\mathbf{i} \Rightarrow \mathbf{u} \times (\mathbf{v} \times \mathbf{w}) = \mathbf{0}$;
 $(\mathbf{u} \cdot \mathbf{w})\mathbf{v} - (\mathbf{u} \cdot \mathbf{v})\mathbf{w} = 0\mathbf{v} - 0\mathbf{w} = \mathbf{0}$

(b) $\mathbf{u} \times \mathbf{v} = \begin{vmatrix} \mathbf{i} & \mathbf{j} & \mathbf{k} \\ 1 & -1 & 1 \\ 2 & 1 & -2 \end{vmatrix} = \mathbf{i} + 4\mathbf{j} + 3\mathbf{k} \Rightarrow (\mathbf{u} \times \mathbf{v}) \times \mathbf{w} = \begin{vmatrix} \mathbf{i} & \mathbf{j} & \mathbf{k} \\ 1 & 4 & 3 \\ -1 & 2 & -1 \end{vmatrix} = -10\mathbf{i} - 2\mathbf{j} + 6\mathbf{k}$;

$$(\mathbf{u} \cdot \mathbf{w})\mathbf{v} - (\mathbf{v} \cdot \mathbf{w})\mathbf{u} = -4(2\mathbf{i} + \mathbf{j} - 2\mathbf{k}) - 2(\mathbf{i} - \mathbf{j} + \mathbf{k}) = -10\mathbf{i} - 2\mathbf{j} + 6\mathbf{k};$$

$$\mathbf{v} \times \mathbf{w} = \begin{vmatrix} \mathbf{i} & \mathbf{j} & \mathbf{k} \\ 2 & 1 & -2 \\ -1 & 2 & -1 \end{vmatrix} = 3\mathbf{i} + 4\mathbf{j} + 5\mathbf{k} \Rightarrow \mathbf{u} \times (\mathbf{v} \times \mathbf{w}) = \begin{vmatrix} \mathbf{i} & \mathbf{j} & \mathbf{k} \\ 1 & -1 & 1 \\ 3 & 4 & 5 \end{vmatrix} = -9\mathbf{i} - 2\mathbf{j} + 7\mathbf{k};$$

$$(\mathbf{u} \cdot \mathbf{w})\mathbf{v} - (\mathbf{u} \cdot \mathbf{v})\mathbf{w} = -4(2\mathbf{i} + \mathbf{j} - 2\mathbf{k}) - (-1)(-\mathbf{i} + 2\mathbf{j} - \mathbf{k}) = -9\mathbf{i} - 2\mathbf{j} + 7\mathbf{k}$$

(c) $\mathbf{u} \times \mathbf{v} = \begin{vmatrix} \mathbf{i} & \mathbf{j} & \mathbf{k} \\ 2 & 1 & 0 \\ 2 & -1 & 1 \end{vmatrix} = \mathbf{i} - 2\mathbf{j} - 4\mathbf{k} \Rightarrow (\mathbf{u} \times \mathbf{v}) \times \mathbf{w} = \begin{vmatrix} \mathbf{i} & \mathbf{j} & \mathbf{k} \\ 1 & -2 & -4 \\ 1 & 0 & 2 \end{vmatrix} = -4\mathbf{i} - 6\mathbf{j} + 2\mathbf{k}$;

$$(\mathbf{u} \cdot \mathbf{w})\mathbf{v} - (\mathbf{v} \cdot \mathbf{w})\mathbf{u} = 2(2\mathbf{i} - \mathbf{j} + \mathbf{k}) - 4(2\mathbf{i} + \mathbf{j}) = -4\mathbf{i} - 6\mathbf{j} + 2\mathbf{k};$$

$$\mathbf{v} \times \mathbf{w} = \begin{vmatrix} \mathbf{i} & \mathbf{j} & \mathbf{k} \\ 2 & -1 & 1 \\ 1 & 0 & 2 \end{vmatrix} = -2\mathbf{i} - 3\mathbf{j} + \mathbf{k} \Rightarrow \mathbf{u} \times (\mathbf{v} \times \mathbf{w}) = \begin{vmatrix} \mathbf{i} & \mathbf{j} & \mathbf{k} \\ 2 & 1 & 0 \\ -2 & -3 & 1 \end{vmatrix} = \mathbf{i} - 2\mathbf{j} - 4\mathbf{k};$$

$$(\mathbf{u} \cdot \mathbf{w})\mathbf{v} - (\mathbf{u} \cdot \mathbf{v})\mathbf{w} = 2(2\mathbf{i} - \mathbf{j} + \mathbf{k}) - 3(\mathbf{i} + 2\mathbf{k}) = \mathbf{i} - 2\mathbf{j} - 4\mathbf{k}$$

(d) $\mathbf{u} \times \mathbf{v} = \begin{vmatrix} \mathbf{i} & \mathbf{j} & \mathbf{k} \\ 1 & 1 & -2 \\ -1 & 0 & -1 \end{vmatrix} = -\mathbf{i} + 3\mathbf{j} + \mathbf{k} \Rightarrow (\mathbf{u} \times \mathbf{v}) \times \mathbf{w} = \begin{vmatrix} \mathbf{i} & \mathbf{j} & \mathbf{k} \\ -1 & 3 & 1 \\ 2 & 4 & -2 \end{vmatrix} = -10\mathbf{i} - 10\mathbf{k}$;

$$(\mathbf{u} \cdot \mathbf{w})\mathbf{v} - (\mathbf{v} \cdot \mathbf{w})\mathbf{u} = 10(-\mathbf{i} - \mathbf{k}) - 0(\mathbf{i} + \mathbf{j} - 2\mathbf{k}) = -10\mathbf{i} - 10\mathbf{k};$$

$$\mathbf{v} \times \mathbf{w} = \begin{vmatrix} \mathbf{i} & \mathbf{j} & \mathbf{k} \\ -1 & 0 & -1 \\ 2 & 4 & -2 \end{vmatrix} = 4\mathbf{i} - 4\mathbf{j} - 4\mathbf{k} \Rightarrow \mathbf{u} \times (\mathbf{v} \times \mathbf{w}) = \begin{vmatrix} \mathbf{i} & \mathbf{j} & \mathbf{k} \\ 1 & 1 & -2 \\ 4 & -4 & -4 \end{vmatrix} = -12\mathbf{i} - 4\mathbf{j} - 8\mathbf{k};$$

$$(\mathbf{u} \cdot \mathbf{w})\mathbf{v} - (\mathbf{u} \cdot \mathbf{v})\mathbf{w} = 10(-\mathbf{i} - \mathbf{k}) - 1(2\mathbf{i} + 4\mathbf{j} - 2\mathbf{k}) = -12\mathbf{i} - 4\mathbf{j} - 8\mathbf{k}$$

16. (a) $\mathbf{u} \times (\mathbf{v} \times \mathbf{w}) + \mathbf{v} \times (\mathbf{w} \times \mathbf{u}) + \mathbf{w} \times (\mathbf{u} \times \mathbf{v}) = (\mathbf{u} \cdot \mathbf{w})\mathbf{v} - (\mathbf{u} \cdot \mathbf{v})\mathbf{w} + (\mathbf{v} \cdot \mathbf{u})\mathbf{w} - (\mathbf{v} \cdot \mathbf{w})\mathbf{u} + (\mathbf{w} \cdot \mathbf{v})\mathbf{u} - (\mathbf{w} \cdot \mathbf{u})\mathbf{v} = \mathbf{0}$

(b) $[\mathbf{u} \cdot (\mathbf{v} \times \mathbf{i})]\mathbf{i} + [\mathbf{u} \cdot (\mathbf{v} \times \mathbf{j})]\mathbf{j} + [\mathbf{u} \cdot (\mathbf{v} \times \mathbf{k})]\mathbf{k} = [(\mathbf{u} \times \mathbf{v}) \cdot \mathbf{i}]\mathbf{i} + [(\mathbf{u} \times \mathbf{v}) \cdot \mathbf{j}]\mathbf{j} + [(\mathbf{u} \times \mathbf{v}) \cdot \mathbf{k}]\mathbf{k} = \mathbf{u} \times \mathbf{v}$

(c) $(\mathbf{u} \times \mathbf{v}) \cdot (\mathbf{w} \times \mathbf{r}) = \mathbf{u} \cdot [\mathbf{v} \times (\mathbf{w} \times \mathbf{r})] = \mathbf{u} \cdot [(\mathbf{v} \cdot \mathbf{r})\mathbf{w} - (\mathbf{v} \cdot \mathbf{w})\mathbf{r}] = (\mathbf{u} \cdot \mathbf{w})(\mathbf{v} \cdot \mathbf{r}) - (\mathbf{u} \cdot \mathbf{r})(\mathbf{v} \cdot \mathbf{w})$

$$= \begin{vmatrix} \mathbf{u} \cdot \mathbf{w} & \mathbf{v} \cdot \mathbf{w} \\ \mathbf{u} \cdot \mathbf{r} & \mathbf{v} \cdot \mathbf{r} \end{vmatrix}$$

17. The formula is always true; $\mathbf{u} \times [\mathbf{u} \times (\mathbf{u} \times \mathbf{v})] \cdot \mathbf{w} = \mathbf{u} \times [(\mathbf{u} \cdot \mathbf{v})\mathbf{u} - (\mathbf{u} \cdot \mathbf{u})\mathbf{v}] \cdot \mathbf{w}$

$$= [(\mathbf{u} \cdot \mathbf{v})\mathbf{u} \times \mathbf{u} - (\mathbf{u} \cdot \mathbf{u})\mathbf{u} \times \mathbf{v}] \cdot \mathbf{w} = -|\mathbf{u}|^2 \mathbf{u} \times \mathbf{v} \cdot \mathbf{w} = -|\mathbf{u}|^2 \mathbf{u} \cdot \mathbf{v} \times \mathbf{w}$$

18. If $\mathbf{u} = (\cos \alpha)\mathbf{i} + (\sin \alpha)\mathbf{j}$ and $\mathbf{v} = (\cos \beta)\mathbf{i} + (\sin \beta)\mathbf{j}$, where $\beta > \alpha$, then $\mathbf{u} \times \mathbf{v} = [|\mathbf{u}| |\mathbf{v}| \sin(\beta - \alpha)] \mathbf{k}$

$$= \begin{vmatrix} \mathbf{i} & \mathbf{j} & \mathbf{k} \\ \cos \alpha & \sin \alpha & 0 \\ \cos \beta & \sin \beta & 0 \end{vmatrix} = (\cos \alpha \sin \beta - \sin \alpha \cos \beta)\mathbf{k} \Rightarrow \sin(\beta - \alpha) = \cos \alpha \sin \beta - \sin \alpha \cos \beta, \text{ since}$$

$$|\mathbf{u}| = 1 \text{ and } |\mathbf{v}| = 1.$$

19. If $\mathbf{u} = a\mathbf{i} + b\mathbf{j}$ and $\mathbf{v} = c\mathbf{i} + d\mathbf{j}$, then $\mathbf{u} \cdot \mathbf{v} = |\mathbf{u}| |\mathbf{v}| \cos \theta \Rightarrow ac + bd = \sqrt{a^2 + b^2} \sqrt{c^2 + d^2} \cos \theta$
 $\Rightarrow (ac + bd)^2 = (a^2 + b^2)(c^2 + d^2) \cos^2 \theta \Rightarrow (ac + bd)^2 \leq (a^2 + b^2)(c^2 + d^2)$, since $\cos^2 \theta \leq 1$.

20. $\mathbf{w} = \text{proj}_{\mathbf{v}} \mathbf{u} = \left(\frac{\mathbf{u} \cdot \mathbf{v}}{|\mathbf{v}|^2} \right) \mathbf{v}$ and $\mathbf{r} = \mathbf{u} - \mathbf{w} = \mathbf{u} - \left(\frac{\mathbf{u} \cdot \mathbf{v}}{|\mathbf{v}|^2} \right) \mathbf{v}$

21. $|\mathbf{u} + \mathbf{v}|^2 = (\mathbf{u} + \mathbf{v}) \cdot (\mathbf{u} + \mathbf{v}) = \mathbf{u} \cdot \mathbf{u} + 2\mathbf{u} \cdot \mathbf{v} + \mathbf{v} \cdot \mathbf{v} \leq |\mathbf{u}|^2 + 2|\mathbf{u}| |\mathbf{v}| + |\mathbf{v}|^2 = (|\mathbf{u}| + |\mathbf{v}|)^2 \Rightarrow |\mathbf{u} + \mathbf{v}| \leq |\mathbf{u}| + |\mathbf{v}|$

22. Let α denote the angle between \mathbf{w} and \mathbf{u} , and β the angle between \mathbf{w} and \mathbf{v} . Let $a = |\mathbf{u}|$ and $b = |\mathbf{v}|$. Then

$$\cos \alpha = \frac{\mathbf{w} \cdot \mathbf{u}}{|\mathbf{w}| |\mathbf{u}|} = \frac{(\mathbf{av} + \mathbf{bu}) \cdot \mathbf{u}}{|\mathbf{w}| |\mathbf{u}|} = \frac{(\mathbf{av} \cdot \mathbf{u} + \mathbf{bu} \cdot \mathbf{u})}{|\mathbf{w}| |\mathbf{u}|} = \frac{(\mathbf{av} \cdot \mathbf{u} + \mathbf{bu} \cdot \mathbf{u})}{|\mathbf{w}| |\mathbf{u}|} = \frac{(\mathbf{av} \cdot \mathbf{u} + \mathbf{ba}^2)}{|\mathbf{w}| a} = \frac{\mathbf{v} \cdot \mathbf{u} + \mathbf{ba}}{|\mathbf{w}|},$$

and likewise, $\cos \beta = \frac{\mathbf{u} \cdot \mathbf{v} + \mathbf{ba}}{|\mathbf{w}|}$. Since the angle between \mathbf{u} and \mathbf{v} is always $\leq \frac{\pi}{2}$ and $\cos \alpha = \cos \beta$, we have

that $\alpha = \beta \Rightarrow \mathbf{w}$ bisects the angle between \mathbf{u} and \mathbf{v} .

23. $(\mathbf{av} + \mathbf{bu}) \cdot (\mathbf{bu} - \mathbf{av}) = \mathbf{av} \cdot \mathbf{bu} + \mathbf{bu} \cdot \mathbf{bu} - \mathbf{av} \cdot \mathbf{av} - \mathbf{bu} \cdot \mathbf{av} = \mathbf{bu} \cdot \mathbf{av} + \mathbf{b}^2 \mathbf{u} \cdot \mathbf{u} - \mathbf{a}^2 \mathbf{v} \cdot \mathbf{v} - \mathbf{bu} \cdot \mathbf{av}$
 $= \mathbf{b}^2 \mathbf{a}^2 - \mathbf{a}^2 \mathbf{b}^2 = 0$, where $a = |\mathbf{u}|$ and $b = |\mathbf{v}|$

24. If $\mathbf{u} = a\mathbf{i} + b\mathbf{j} + c\mathbf{k}$, then $\mathbf{u} \cdot \mathbf{u} = a^2 + b^2 + c^2 \geq 0$ and $\mathbf{u} \cdot \mathbf{u} = 0$ iff $a = b = c = 0$.

25. (a) The vector from $(0, d)$ to $(kd, 0)$ is $\mathbf{r}_k = k\mathbf{d}\mathbf{i} - d\mathbf{j} \Rightarrow \frac{1}{|\mathbf{r}_k|^3} = \frac{1}{d^3(k^2 + 1)^{3/2}} \Rightarrow \frac{\mathbf{r}_k}{|\mathbf{r}_k|^3} = \frac{k\mathbf{i} - \mathbf{j}}{d^2(k^2 + 1)^{3/2}}$. The

total force on the mass $(0, d)$ due to the masses Q_k for $k = -n, -n + 1, \dots, n - 1, n$ is

$$\mathbf{F} = \frac{GMm}{d^2} (-\mathbf{j}) + \frac{GMm}{2d^2} \left(\frac{\mathbf{i} - \mathbf{j}}{\sqrt{2}} \right) + \frac{GMm}{5d^2} \left(\frac{2\mathbf{i} - \mathbf{j}}{\sqrt{5}} \right) + \dots + \frac{GMm}{(n^2 + 1)d^2} \left(\frac{n\mathbf{i} - \mathbf{j}}{\sqrt{n^2 + 1}} \right) + \frac{GMm}{2d^2} \left(\frac{-\mathbf{i} - \mathbf{j}}{\sqrt{2}} \right)$$

$$+ \frac{GMm}{5d^2} \left(\frac{-2\mathbf{i} - \mathbf{j}}{\sqrt{5}} \right) + \dots + \frac{GMm}{(n^2 + 1)d^2} \left(\frac{-n\mathbf{i} - \mathbf{j}}{\sqrt{n^2 + 1}} \right)$$

The \mathbf{i} components cancel, giving

$$\mathbf{F} = \frac{GMm}{d^2} \left(-1 - \frac{2}{2\sqrt{2}} - \frac{2}{5\sqrt{5}} - \dots - \frac{2}{(n^2 + 1)(n^2 + 1)^{1/2}} \right) \mathbf{j} \Rightarrow \text{the magnitude of the force is}$$

$$|\mathbf{F}| = \frac{GMm}{d^2} \left(1 + \sum_{i=1}^n \frac{2}{(i^2 + 1)^{3/2}} \right).$$

(b) Yes, it is finite: $\lim_{n \rightarrow \infty} |\mathbf{F}| = \frac{GMm}{d^2} \left(1 + \sum_{i=1}^{\infty} \frac{2}{(i^2 + 1)^{3/2}} \right)$ is finite since $\sum_{i=1}^{\infty} \frac{2}{(i^2 + 1)^{3/2}}$ converges.

26. (a) If $\vec{x} \cdot \vec{y} = 0$, then $\vec{x} \times (\vec{x} \times \vec{y}) = (\vec{x} \cdot \vec{y})\vec{x} - (\vec{x} \cdot \vec{x})\vec{y} = -(\vec{x} \cdot \vec{x})\vec{y}$. This means that

$$\vec{x} \oplus \vec{y} = \vec{x} + \vec{y} + \frac{1}{c^2} \cdot \frac{1}{1 + \sqrt{1 - \frac{\vec{x} \cdot \vec{x}}{c^2}}} (-(\vec{x} \cdot \vec{x}))\vec{y} = \vec{x} + \left(1 - \frac{|\vec{x}|^2}{c^2 + \sqrt{c^4 - c^2 |\vec{x}|^2}} \right) \vec{y}.$$

Since \vec{x} and \vec{y} are orthogonal, then $|\vec{x} \oplus \vec{y}|^2 = |\vec{x}|^2 + \left(1 - \frac{|\vec{x}|^2}{c^2 + \sqrt{c^4 - c^2 |\vec{x}|^2}} \right)^2 |\vec{y}|^2$. A calculation will show that

$$|\vec{x}|^2 + \left(1 - \frac{|\vec{x}|^2}{c^2 + \sqrt{c^4 - c^2 |\vec{x}|^2}} \right)^2 c^2 = c^2. \text{ Since } |\vec{y}| < c, \text{ then } |\vec{y}|^2 < c^2 \text{ so}$$

$$\left(1 - \frac{|\vec{x}|^2}{c^2 + \sqrt{c^4 - c^2 |\vec{x}|^2}} \right)^2 |\vec{y}|^2 < \left(1 - \frac{|\vec{x}|^2}{c^2 + \sqrt{c^4 - c^2 |\vec{x}|^2}} \right)^2 c^2. \text{ This means that}$$

$$|\vec{x} \oplus \vec{y}|^2 = |\vec{x}|^2 + \left(1 - \frac{|\vec{x}|^2}{c^2 + \sqrt{c^4 - c^2 |\vec{x}|^2}}\right)^2 |\vec{y}|^2 < |\vec{x}|^2 + \left(1 - \frac{|\vec{x}|^2}{c^2 + \sqrt{c^4 - c^2 |\vec{x}|^2}}\right)^2 c^2 = c^2.$$

We now have $|\vec{x} \oplus \vec{y}|^2 < c^2$, so $|\vec{x} \oplus \vec{y}| < c$.

(b) If \vec{x} and \vec{y} are parallel, then $\vec{x} \times (\vec{x} \times \vec{y}) = \vec{0}$. This gives $\vec{x} \oplus \vec{y} = \frac{\vec{x} + \vec{y}}{1 + \frac{|\vec{x}\vec{y}|}{c^2}}$.

(i) If \vec{x} and \vec{y} have the same direction, then $\vec{x} \oplus \vec{y} = \frac{\vec{x} + \vec{y}}{1 + \frac{|\vec{x}||\vec{y}|}{c^2}}$ and $|\vec{x} \oplus \vec{y}| = \frac{|\vec{x}| + |\vec{y}|}{1 + \frac{|\vec{x}||\vec{y}|}{c^2}}$.

Since $|\vec{y}| < c$, $|\vec{x}| < c$, we have $|\vec{y}| \left(1 - \frac{|\vec{x}|}{c}\right) < c \left(1 - \frac{|\vec{x}|}{c}\right) \Rightarrow |\vec{y}| - \frac{|\vec{y}||\vec{x}|}{c} < c - |\vec{x}|$

$\Rightarrow |\vec{x}| + |\vec{y}| < c + \frac{|\vec{x}||\vec{y}|}{c} = c \left(1 + \frac{|\vec{x}||\vec{y}|}{c^2}\right) \Rightarrow \frac{|\vec{x}| + |\vec{y}|}{1 + \frac{|\vec{x}||\vec{y}|}{c^2}} < c$. This means that $|\vec{x} \oplus \vec{y}| < c$.

(ii) If \vec{x} and \vec{y} have opposite directions, then $\vec{x} \cdot \vec{y} = -|\vec{x}||\vec{y}|$ and $\vec{x} \oplus \vec{y} = \frac{\vec{x} + \vec{y}}{1 - \frac{|\vec{x}||\vec{y}|}{c^2}}$.

Assume $|\vec{x}| \geq |\vec{y}|$, then $|\vec{x} \oplus \vec{y}| = \frac{|\vec{x}| - |\vec{y}|}{1 - \frac{|\vec{x}||\vec{y}|}{c^2}}$. Since $|\vec{x}| < c$, we have $|\vec{x}| \left(1 + \frac{|\vec{y}|}{c}\right) < c \left(1 + \frac{|\vec{y}|}{c}\right)$

$\Rightarrow |\vec{x}| + \frac{|\vec{x}||\vec{y}|}{c} < c + |\vec{y}| \Rightarrow |\vec{x}| - |\vec{y}| < c - \frac{|\vec{x}||\vec{y}|}{c} = c \left(1 - \frac{|\vec{x}||\vec{y}|}{c^2}\right) \Rightarrow \frac{|\vec{x}| - |\vec{y}|}{1 - \frac{|\vec{x}||\vec{y}|}{c^2}} < c$.

This means that $|\vec{x} \oplus \vec{y}| < c$. A similar argument holds if $|\vec{x}| > |\vec{y}|$.

(c) $\lim_{\infty} \vec{x} \oplus \vec{y} = \vec{x} + \vec{y}$.

NOTES:

CHAPTER 13 VECTOR-VALUED FUNCTIONS AND MOTION IN SPACE

13.1 VECTOR FUNCTIONS

1. $x = t + 1$ and $y = t^2 - 1 \Rightarrow y = (x - 1)^2 - 1 = x^2 - 2x$; $\mathbf{v} = \frac{d\mathbf{r}}{dt} = \mathbf{i} + 2t\mathbf{j} \Rightarrow \mathbf{a} = \frac{d\mathbf{v}}{dt} = 2\mathbf{j} \Rightarrow \mathbf{v} = \mathbf{i} + 2\mathbf{j}$ and $\mathbf{a} = 2\mathbf{j}$ at $t = 1$
2. $x = t^2 + 1$ and $y = 2t - 1 \Rightarrow x = \left(\frac{y+1}{2}\right)^2 + 1 \Rightarrow x = \frac{1}{4}(y+1)^2 + 1$; $\mathbf{v} = \frac{d\mathbf{r}}{dt} = 2t\mathbf{i} + 2\mathbf{j} \Rightarrow \mathbf{a} = \frac{d\mathbf{v}}{dt} = 2\mathbf{i} \Rightarrow \mathbf{v} = \mathbf{i} + 2\mathbf{j}$ and $\mathbf{a} = 2\mathbf{i}$ at $t = \frac{1}{2}$
3. $x = e^t$ and $y = \frac{2}{9}e^{2t} \Rightarrow y = \frac{2}{9}x^2$; $\mathbf{v} = \frac{d\mathbf{r}}{dt} = e^t\mathbf{i} + \frac{4}{9}e^{2t}\mathbf{j} \Rightarrow \mathbf{a} = e^t\mathbf{i} + \frac{8}{9}e^{2t}\mathbf{j} \Rightarrow \mathbf{v} = 3\mathbf{i} + 4\mathbf{j}$ and $\mathbf{a} = 3\mathbf{i} + 8\mathbf{j}$ at $t = \ln 3$
4. $x = \cos 2t$ and $y = 3 \sin 2t \Rightarrow x^2 + \frac{1}{9}y^2 = 1$; $\mathbf{v} = \frac{d\mathbf{r}}{dt} = (-2 \sin 2t)\mathbf{i} + (6 \cos 2t)\mathbf{j} \Rightarrow \mathbf{a} = \frac{d\mathbf{v}}{dt} = (-4 \cos 2t)\mathbf{i} + (-12 \sin 2t)\mathbf{j} \Rightarrow \mathbf{v} = 6\mathbf{j}$ and $\mathbf{a} = -4\mathbf{i}$ at $t = 0$

5. $\mathbf{v} = \frac{d\mathbf{r}}{dt} = (\cos t)\mathbf{i} - (\sin t)\mathbf{j}$ and $\mathbf{a} = \frac{d\mathbf{v}}{dt} = -(\sin t)\mathbf{i} - (\cos t)\mathbf{j}$
 \Rightarrow for $t = \frac{\pi}{4}$, $\mathbf{v}\left(\frac{\pi}{4}\right) = \frac{\sqrt{2}}{2}\mathbf{i} - \frac{\sqrt{2}}{2}\mathbf{j}$ and
 $\mathbf{a}\left(\frac{\pi}{4}\right) = -\frac{\sqrt{2}}{2}\mathbf{i} - \frac{\sqrt{2}}{2}\mathbf{j}$; for $t = \frac{\pi}{2}$, $\mathbf{v}\left(\frac{\pi}{2}\right) = -\mathbf{j}$ and
 $\mathbf{a}\left(\frac{\pi}{2}\right) = -\mathbf{i}$

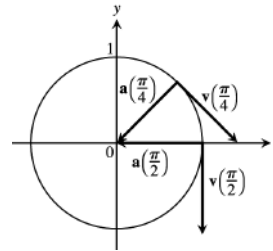

6. $\mathbf{v} = \frac{d\mathbf{r}}{dt} = (-2 \sin \frac{t}{2})\mathbf{i} + (2 \cos \frac{t}{2})\mathbf{j}$ and $\mathbf{a} = \frac{d\mathbf{v}}{dt} = (-\cos \frac{t}{2})\mathbf{i} + (-\sin \frac{t}{2})\mathbf{j} \Rightarrow$ for $t = \pi$, $\mathbf{v}(\pi) = -2\mathbf{i}$ and
 $\mathbf{a}(\pi) = -\mathbf{j}$; for $t = \frac{3\pi}{2}$, $\mathbf{v}\left(\frac{3\pi}{2}\right) = -\sqrt{2}\mathbf{i} - \sqrt{2}\mathbf{j}$ and
 $\mathbf{a}\left(\frac{3\pi}{2}\right) = \frac{\sqrt{2}}{2}\mathbf{i} - \frac{\sqrt{2}}{2}\mathbf{j}$

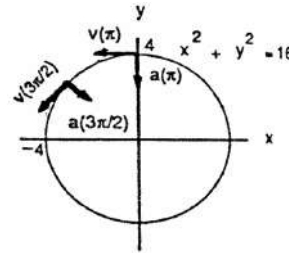

7. $\mathbf{v} = \frac{d\mathbf{r}}{dt} = (1 - \cos t)\mathbf{i} + (\sin t)\mathbf{j}$ and $\mathbf{a} = \frac{d\mathbf{v}}{dt} = (\sin t)\mathbf{i} + (\cos t)\mathbf{j} \Rightarrow$ for $t = \pi$, $\mathbf{v}(\pi) = 2\mathbf{i}$ and $\mathbf{a}(\pi) = -\mathbf{j}$;
for $t = \frac{3\pi}{2}$, $\mathbf{v}\left(\frac{3\pi}{2}\right) = \mathbf{i} - \mathbf{j}$ and $\mathbf{a}\left(\frac{3\pi}{2}\right) = -\mathbf{i}$

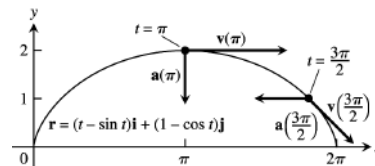

8. $\mathbf{v} = \frac{d\mathbf{r}}{dt} = \mathbf{i} + 2t\mathbf{j}$ and $\mathbf{a} = \frac{d\mathbf{v}}{dt} = 2\mathbf{j} \Rightarrow$ for $t = -1$,
 $\mathbf{v}(-1) = \mathbf{i} - 2\mathbf{j}$ and $\mathbf{a}(-1) = 2\mathbf{j}$; for $t = 0$, $\mathbf{v}(0) = \mathbf{i}$ and
 $\mathbf{a}(0) = 2\mathbf{j}$; for $t = 1$, $\mathbf{v}(1) = \mathbf{i} + 2\mathbf{j}$ and $\mathbf{a}(1) = 2\mathbf{j}$

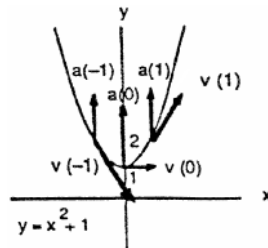

9. $\mathbf{r} = (t+1)\mathbf{i} + (t^2-1)\mathbf{j} + 2t\mathbf{k} \Rightarrow \mathbf{v} = \frac{d\mathbf{r}}{dt} = \mathbf{i} + 2t\mathbf{j} + 2\mathbf{k} \Rightarrow \mathbf{a} = \frac{d^2\mathbf{r}}{dt^2} = 2\mathbf{j}$; Speed: $|\mathbf{v}(1)| = \sqrt{1^2 + (2(1))^2 + 2^2} = 3$;
Direction: $\frac{\mathbf{v}(1)}{|\mathbf{v}(1)|} = \frac{\mathbf{i} + 2(1)\mathbf{j} + 2\mathbf{k}}{3} = \frac{1}{3}\mathbf{i} + \frac{2}{3}\mathbf{j} + \frac{2}{3}\mathbf{k} \Rightarrow \mathbf{v}(1) = 3\left(\frac{1}{3}\mathbf{i} + \frac{2}{3}\mathbf{j} + \frac{2}{3}\mathbf{k}\right)$
10. $\mathbf{r} = (1+t)\mathbf{i} + \frac{t^2}{\sqrt{2}}\mathbf{j} + \frac{t^3}{3}\mathbf{k} \Rightarrow \mathbf{v} = \frac{d\mathbf{r}}{dt} = \mathbf{i} + \frac{2t}{\sqrt{2}}\mathbf{j} + t^2\mathbf{k} \Rightarrow \mathbf{a} = \frac{d^2\mathbf{r}}{dt^2} = \frac{2}{\sqrt{2}}\mathbf{j} + 2t\mathbf{k}$; Speed: $|\mathbf{v}(1)|$
 $= \sqrt{1^2 + \left(\frac{2(1)}{\sqrt{2}}\right)^2 + (1^2)^2} = 2$; Direction: $\frac{\mathbf{v}(1)}{|\mathbf{v}(1)|} = \frac{\mathbf{i} + \frac{2(1)}{\sqrt{2}}\mathbf{j} + (1^2)\mathbf{k}}{2} = \frac{1}{2}\mathbf{i} + \frac{1}{\sqrt{2}}\mathbf{j} + \frac{1}{2}\mathbf{k} \Rightarrow \mathbf{v}(1)$
 $= 2\left(\frac{1}{2}\mathbf{i} + \frac{1}{\sqrt{2}}\mathbf{j} + \frac{1}{2}\mathbf{k}\right)$
11. $\mathbf{r} = (2\cos t)\mathbf{i} + (3\sin t)\mathbf{j} + 4t\mathbf{k} \Rightarrow \mathbf{v} = \frac{d\mathbf{r}}{dt} = (-2\sin t)\mathbf{i} + (3\cos t)\mathbf{j} + 4\mathbf{k} \Rightarrow \mathbf{a} = \frac{d^2\mathbf{r}}{dt^2} = (-2\cos t)\mathbf{i} - (3\sin t)\mathbf{j}$;
Speed: $|\mathbf{v}(\frac{\pi}{2})| = \sqrt{(-2\sin \frac{\pi}{2})^2 + (3\cos \frac{\pi}{2})^2 + 4^2} = 2\sqrt{5}$; Direction: $\frac{\mathbf{v}(\frac{\pi}{2})}{|\mathbf{v}(\frac{\pi}{2})|}$
 $= \left(-\frac{2}{2\sqrt{5}}\sin \frac{\pi}{2}\right)\mathbf{i} + \left(\frac{3}{2\sqrt{5}}\cos \frac{\pi}{2}\right)\mathbf{j} + \frac{4}{2\sqrt{5}}\mathbf{k} = -\frac{1}{\sqrt{5}}\mathbf{i} + \frac{2}{\sqrt{5}}\mathbf{k} \Rightarrow \mathbf{v}(\frac{\pi}{2}) = 2\sqrt{5}\left(-\frac{1}{\sqrt{5}}\mathbf{i} + \frac{2}{\sqrt{5}}\mathbf{k}\right)$
12. $\mathbf{r} = (\sec t)\mathbf{i} + (\tan t)\mathbf{j} + \frac{4}{3}t\mathbf{k} \Rightarrow \mathbf{v} = \frac{d\mathbf{r}}{dt} = (\sec t \tan t)\mathbf{i} + (\sec^2 t)\mathbf{j} + \frac{4}{3}\mathbf{k} \Rightarrow \mathbf{a} = \frac{d^2\mathbf{r}}{dt^2}$
 $= (\sec t \tan^2 t + \sec^3 t)\mathbf{i} + (2\sec^2 t \tan t)\mathbf{j}$; Speed: $|\mathbf{v}(\frac{\pi}{6})| = \sqrt{(\sec \frac{\pi}{6} \tan \frac{\pi}{6})^2 + (\sec^2 \frac{\pi}{6})^2 + (\frac{4}{3})^2} = 2$;
Direction: $\frac{\mathbf{v}(\frac{\pi}{6})}{|\mathbf{v}(\frac{\pi}{6})|} = \frac{(\sec \frac{\pi}{6} \tan \frac{\pi}{6})\mathbf{i} + (\sec^2 \frac{\pi}{6})\mathbf{j} + \frac{4}{3}\mathbf{k}}{2} = \frac{1}{3}\mathbf{i} + \frac{2}{3}\mathbf{j} + \frac{2}{3}\mathbf{k} \Rightarrow \mathbf{v}(\frac{\pi}{6}) = 2\left(\frac{1}{3}\mathbf{i} + \frac{2}{3}\mathbf{j} + \frac{2}{3}\mathbf{k}\right)$
13. $\mathbf{r} = (2\ln(t+1))\mathbf{i} + t^2\mathbf{j} + \frac{t^2}{2}\mathbf{k} \Rightarrow \mathbf{v} = \frac{d\mathbf{r}}{dt} = \left(\frac{2}{t+1}\right)\mathbf{i} + 2t\mathbf{j} + t\mathbf{k} \Rightarrow \mathbf{a} = \frac{d^2\mathbf{r}}{dt^2} = \left[\frac{-2}{(t+1)^2}\right]\mathbf{i} + 2\mathbf{j} + \mathbf{k}$;
Speed: $|\mathbf{v}(1)| = \sqrt{\left(\frac{2}{1+1}\right)^2 + (2(1))^2 + 1^2} = \sqrt{6}$; Direction: $\frac{\mathbf{v}(1)}{|\mathbf{v}(1)|} = \frac{\left(\frac{2}{1+1}\right)\mathbf{i} + 2(1)\mathbf{j} + (1)\mathbf{k}}{\sqrt{6}}$
 $= \frac{1}{\sqrt{6}}\mathbf{i} + \frac{2}{\sqrt{6}}\mathbf{j} + \frac{1}{\sqrt{6}}\mathbf{k} \Rightarrow \mathbf{v}(1) = \sqrt{6}\left(\frac{1}{\sqrt{6}}\mathbf{i} + \frac{2}{\sqrt{6}}\mathbf{j} + \frac{1}{\sqrt{6}}\mathbf{k}\right)$
14. $\mathbf{r} = (e^{-t})\mathbf{i} + (2\cos 3t)\mathbf{j} + (2\sin 3t)\mathbf{k} \Rightarrow \mathbf{v} = \frac{d\mathbf{r}}{dt} = (-e^{-t})\mathbf{i} - (6\sin 3t)\mathbf{j} + (6\cos 3t)\mathbf{k} \Rightarrow \mathbf{a} = \frac{d^2\mathbf{r}}{dt^2}$
 $= (e^{-t})\mathbf{i} - (18\cos 3t)\mathbf{j} - (18\sin 3t)\mathbf{k}$; Speed: $|\mathbf{v}(0)| = \sqrt{(-e^0)^2 + [-6\sin 3(0)]^2 + [6\cos 3(0)]^2} = \sqrt{37}$;
Direction: $\frac{\mathbf{v}(0)}{|\mathbf{v}(0)|} = \frac{(-e^0)\mathbf{i} - 6\sin 3(0)\mathbf{j} + 6\cos 3(0)\mathbf{k}}{\sqrt{37}} = -\frac{1}{\sqrt{37}}\mathbf{i} + \frac{6}{\sqrt{37}}\mathbf{k} \Rightarrow \mathbf{v}(0) = \sqrt{37}\left(-\frac{1}{\sqrt{37}}\mathbf{i} + \frac{6}{\sqrt{37}}\mathbf{k}\right)$
15. $\mathbf{v} = 3\mathbf{i} + \sqrt{3}\mathbf{j} + 2\mathbf{k}$ and $\mathbf{a} = 2\mathbf{k} \Rightarrow \mathbf{v}(0) = 3\mathbf{i} + \sqrt{3}\mathbf{j}$ and $\mathbf{a}(0) = 2\mathbf{k} \Rightarrow |\mathbf{v}(0)| = \sqrt{3^2 + (\sqrt{3})^2 + 0^2} = \sqrt{12}$ and
 $|\mathbf{a}(0)| = \sqrt{2^2} = 2$; $\mathbf{v}(0) \cdot \mathbf{a}(0) = 0 \Rightarrow \cos \theta = 0 \Rightarrow \theta = \frac{\pi}{2}$
16. $\mathbf{v} = \frac{\sqrt{2}}{2}\mathbf{i} + \left(\frac{\sqrt{2}}{2} - 32t\right)\mathbf{j}$ and $\mathbf{a} = -32\mathbf{j} \Rightarrow \mathbf{v}(0) = \frac{\sqrt{2}}{2}\mathbf{i} + \frac{\sqrt{2}}{2}\mathbf{j}$ and $\mathbf{a}(0) = -32\mathbf{j} \Rightarrow |\mathbf{v}(0)| = \sqrt{\left(\frac{\sqrt{2}}{2}\right)^2 + \left(\frac{\sqrt{2}}{2}\right)^2}$
 $= 1$ and $|\mathbf{a}(0)| = \sqrt{(-32)^2} = 32$; $\mathbf{v}(0) \cdot \mathbf{a}(0) = \left(\frac{\sqrt{2}}{2}\right)(-32) = -16\sqrt{2} \Rightarrow \cos \theta = \frac{-16\sqrt{2}}{1(32)} = -\frac{\sqrt{2}}{2} \Rightarrow \theta = \frac{3\pi}{4}$
17. $\mathbf{v} = \left(\frac{2t}{t^2+1}\right)\mathbf{i} + \left(\frac{1}{t^2+1}\right)\mathbf{j} + t(t^2+1)^{-1/2}\mathbf{k}$ and $\mathbf{a} = \left[\frac{-2t^2+2}{(t^2+1)^2}\right]\mathbf{i} - \left[\frac{2t}{(t^2+1)^2}\right]\mathbf{j} + \left[\frac{1}{(t^2+1)^{3/2}}\right]\mathbf{k} \Rightarrow \mathbf{v}(0) = \mathbf{j}$ and
 $\mathbf{a}(0) = 2\mathbf{i} + \mathbf{k} \Rightarrow |\mathbf{v}(0)| = 1$ and $|\mathbf{a}(0)| = \sqrt{2^2 + 1^2} = \sqrt{5}$; $\mathbf{v}(0) \cdot \mathbf{a}(0) = 0 \Rightarrow \cos \theta = 0 \Rightarrow \theta = \frac{\pi}{2}$
18. $\mathbf{v} = \frac{2}{3}(1+t)^{1/2}\mathbf{i} - \frac{2}{3}(1-t)^{1/2}\mathbf{j} + \frac{1}{3}\mathbf{k}$ and $\mathbf{a} = \frac{1}{3}(1+t)^{-1/2}\mathbf{i} + \frac{1}{3}(1-t)^{-1/2}\mathbf{j} \Rightarrow \mathbf{v}(0) = \frac{2}{3}\mathbf{i} - \frac{2}{3}\mathbf{j} + \frac{1}{3}\mathbf{k}$ and
 $\mathbf{a}(0) = \frac{1}{3}\mathbf{i} + \frac{1}{3}\mathbf{j} \Rightarrow |\mathbf{v}(0)| = \sqrt{\left(\frac{2}{3}\right)^2 + \left(-\frac{2}{3}\right)^2 + \left(\frac{1}{3}\right)^2} = 1$ and $|\mathbf{a}(0)| = \sqrt{\left(\frac{1}{3}\right)^2 + \left(\frac{1}{3}\right)^2} = \frac{\sqrt{2}}{3}$; $\mathbf{v}(0) \cdot \mathbf{a}(0) = \frac{2}{9} - \frac{2}{9}$
 $= 0 \Rightarrow \cos \theta = 0 \Rightarrow \theta = \frac{\pi}{2}$

19. $\mathbf{v} = (1 - \cos t)\mathbf{i} + (\sin t)\mathbf{j}$ and $\mathbf{a} = (\sin t)\mathbf{i} + (\cos t)\mathbf{j} \Rightarrow \mathbf{v} \cdot \mathbf{a} = (\sin t)(1 - \cos t) + (\sin t)(\cos t) = \sin t$. Thus,
 $\mathbf{v} \cdot \mathbf{a} = 0 \Rightarrow \sin t = 0 \Rightarrow t = 0, \pi, \text{ or } 2\pi$

20. $\mathbf{v} = (\cos t)\mathbf{i} + \mathbf{j} - (\sin t)\mathbf{k}$ and $\mathbf{a} = (-\sin t)\mathbf{i} - (\cos t)\mathbf{k} \Rightarrow \mathbf{v} \cdot \mathbf{a} = -\sin t \cos t + \sin t \cos t = 0$ for all $t \geq 0$

21. $\int_0^1 [t^3\mathbf{i} + 7\mathbf{j} + (t+1)\mathbf{k}] dt = \left[\frac{t^4}{4}\right]_0^1 \mathbf{i} + [7t]_0^1 \mathbf{j} + \left[\frac{t^2}{2} + t\right]_0^1 \mathbf{k} = \frac{1}{4}\mathbf{i} + 7\mathbf{j} + \frac{3}{2}\mathbf{k}$

22. $\int_1^2 [(6-6t)\mathbf{i} + 3\sqrt{t}\mathbf{j} + (\frac{4}{t^2})\mathbf{k}] dt = [6t - 3t^2]_1^2 \mathbf{i} + [2t^{3/2}]_1^2 \mathbf{j} + [-4t^{-1}]_1^2 \mathbf{k} = -3\mathbf{i} + (4\sqrt{2} - 2)\mathbf{j} + 2\mathbf{k}$

23. $\int_{-\pi/4}^{\pi/4} [(\sin t)\mathbf{i} + (1 + \cos t)\mathbf{j} + (\sec^2 t)\mathbf{k}] dt = [-\cos t]_{-\pi/4}^{\pi/4} \mathbf{i} + [t + \sin t]_{-\pi/4}^{\pi/4} \mathbf{j} + [\tan t]_{-\pi/4}^{\pi/4} \mathbf{k}$
 $= \left(\frac{\pi + 2\sqrt{2}}{2}\right)\mathbf{j} + 2\mathbf{k}$

24. $\int_0^{\pi/3} [(\sec t \tan t)\mathbf{i} + (\tan t)\mathbf{j} + (2 \sin t \cos t)\mathbf{k}] dt = \int_0^{\pi/3} [(\sec t \tan t)\mathbf{i} + (\tan t)\mathbf{j} + (\sin 2t)\mathbf{k}] dt$
 $= [\sec t]_0^{\pi/3} \mathbf{i} + [-\ln(\cos t)]_0^{\pi/3} \mathbf{j} + [-\frac{1}{2} \cos 2t]_0^{\pi/3} \mathbf{k} = \mathbf{i} + (\ln 2)\mathbf{j} + \frac{3}{4}\mathbf{k}$

25. $\int_1^4 \left(\frac{1}{t}\mathbf{i} + \frac{1}{5-t}\mathbf{j} + \frac{1}{2t}\mathbf{k}\right) dt = [\ln t]_1^4 \mathbf{i} + [-\ln(5-t)]_1^4 \mathbf{j} + \left[\frac{1}{2} \ln t\right]_1^4 \mathbf{k} = (\ln 4)\mathbf{i} + (\ln 4)\mathbf{j} + (\ln 2)\mathbf{k}$

26. $\int_0^1 \left(\frac{2}{\sqrt{1-t^2}}\mathbf{i} + \frac{\sqrt{3}}{1+t^2}\mathbf{k}\right) dt = [2 \sin^{-1} t]_0^1 \mathbf{i} + \left[\sqrt{3} \tan^{-1} t\right]_0^1 \mathbf{k} = \pi\mathbf{i} + \frac{\pi\sqrt{3}}{4}\mathbf{k}$

27. $\mathbf{r} = \int (-t\mathbf{i} - t\mathbf{j} - t\mathbf{k}) dt = -\frac{t^2}{2}\mathbf{i} - \frac{t^2}{2}\mathbf{j} - \frac{t^2}{2}\mathbf{k} + \mathbf{C}$; $\mathbf{r}(0) = 0\mathbf{i} - 0\mathbf{j} - 0\mathbf{k} + \mathbf{C} = \mathbf{i} + 2\mathbf{j} + 3\mathbf{k} \Rightarrow \mathbf{C} = \mathbf{i} + 2\mathbf{j} + 3\mathbf{k}$
 $\Rightarrow \mathbf{r} = \left(-\frac{t^2}{2} + 1\right)\mathbf{i} + \left(-\frac{t^2}{2} + 2\right)\mathbf{j} + \left(-\frac{t^2}{2} + 3\right)\mathbf{k}$

28. $\mathbf{r} = \int [(180t)\mathbf{i} + (180t - 16t^2)\mathbf{j}] dt = 90t^2\mathbf{i} + (90t^2 - \frac{16}{3}t^3)\mathbf{j} + \mathbf{C}$; $\mathbf{r}(0) = 90(0)^2\mathbf{i} + [90(0)^2 - \frac{16}{3}(0)^3]\mathbf{j} + \mathbf{C}$
 $= 100\mathbf{j} \Rightarrow \mathbf{C} = 100\mathbf{j} \Rightarrow \mathbf{r} = 90t^2\mathbf{i} + (90t^2 - \frac{16}{3}t^3 + 100)\mathbf{j}$

29. $\mathbf{r} = \int \left[\left(\frac{3}{2}(t+1)^{1/2}\right)\mathbf{i} + e^{-t}\mathbf{j} + \left(\frac{1}{t+1}\right)\mathbf{k}\right] dt = (t+1)^{3/2}\mathbf{i} - e^{-t}\mathbf{j} + \ln(t+1)\mathbf{k} + \mathbf{C}$;
 $\mathbf{r}(0) = (0+1)^{3/2}\mathbf{i} - e^{-0}\mathbf{j} + \ln(0+1)\mathbf{k} + \mathbf{C} = \mathbf{k} \Rightarrow \mathbf{C} = -\mathbf{i} + \mathbf{j} + \mathbf{k}$
 $\Rightarrow \mathbf{r} = [(t+1)^{3/2} - 1]\mathbf{i} + (1 - e^{-t})\mathbf{j} + [1 + \ln(t+1)]\mathbf{k}$

30. $\mathbf{r} = \int [(t^3 + 4t)\mathbf{i} + t\mathbf{j} + 2t^2\mathbf{k}] dt = \left(\frac{t^4}{4} + 2t^2\right)\mathbf{i} + \frac{t^2}{2}\mathbf{j} + \frac{2t^3}{3}\mathbf{k} + \mathbf{C}$; $\mathbf{r}(0) = \left[\frac{0^4}{4} + 2(0)^2\right]\mathbf{i} + \frac{0^2}{2}\mathbf{j} + \frac{2(0)^3}{3}\mathbf{k} + \mathbf{C}$
 $= \mathbf{i} + \mathbf{j} \Rightarrow \mathbf{C} = \mathbf{i} + \mathbf{j} \Rightarrow \mathbf{r} = \left(\frac{t^4}{4} + 2t^2 + 1\right)\mathbf{i} + \left(\frac{t^2}{2} + 1\right)\mathbf{j} + \frac{2t^3}{3}\mathbf{k}$

31. $\frac{d\mathbf{r}}{dt} = \int (-32t\mathbf{k}) dt = -32t\mathbf{k} + \mathbf{C}_1$; $\frac{d\mathbf{r}}{dt}(0) = 8\mathbf{i} + 8\mathbf{j} \Rightarrow -32(0)\mathbf{k} + \mathbf{C}_1 = 8\mathbf{i} + 8\mathbf{j} \Rightarrow \mathbf{C}_1 = 8\mathbf{i} + 8\mathbf{j}$
 $\Rightarrow \frac{d\mathbf{r}}{dt} = 8\mathbf{i} + 8\mathbf{j} - 32t\mathbf{k}$; $\mathbf{r} = \int (8\mathbf{i} + 8\mathbf{j} - 32t\mathbf{k}) dt = 8t\mathbf{i} + 8t\mathbf{j} - 16t^2\mathbf{k} + \mathbf{C}_2$; $\mathbf{r}(0) = 100\mathbf{k}$
 $\Rightarrow 8(0)\mathbf{i} + 8(0)\mathbf{j} - 16(0)^2\mathbf{k} + \mathbf{C}_2 = 100\mathbf{k} \Rightarrow \mathbf{C}_2 = 100\mathbf{k} \Rightarrow \mathbf{r} = 8t\mathbf{i} + 8t\mathbf{j} + (100 - 16t^2)\mathbf{k}$

32. $\frac{d\mathbf{r}}{dt} = \int -(\mathbf{i} + \mathbf{j} + \mathbf{k}) dt = -(\mathbf{i} + \mathbf{j} + \mathbf{k}) + \mathbf{C}_1$; $\frac{d\mathbf{r}}{dt}(0) = \mathbf{0} \Rightarrow -(0\mathbf{i} + 0\mathbf{j} + 0\mathbf{k}) + \mathbf{C}_1 = \mathbf{0} \Rightarrow \mathbf{C}_1 = \mathbf{0}$
 $\Rightarrow \frac{d\mathbf{r}}{dt} = -(\mathbf{i} + \mathbf{j} + \mathbf{k})$; $\mathbf{r} = \int -(\mathbf{i} + \mathbf{j} + \mathbf{k}) dt = -\left(\frac{t^2}{2}\mathbf{i} + \frac{t^2}{2}\mathbf{j} + \frac{t^2}{2}\mathbf{k}\right) + \mathbf{C}_2$; $\mathbf{r}(0) = 10\mathbf{i} + 10\mathbf{j} + 10\mathbf{k}$
 $\Rightarrow -\left(\frac{0^2}{2}\mathbf{i} + \frac{0^2}{2}\mathbf{j} + \frac{0^2}{2}\mathbf{k}\right) + \mathbf{C}_2 = 10\mathbf{i} + 10\mathbf{j} + 10\mathbf{k} \Rightarrow \mathbf{C}_2 = 10\mathbf{i} + 10\mathbf{j} + 10\mathbf{k}$

$$\Rightarrow \mathbf{r} = \left(-\frac{t^2}{2} + 10\right)\mathbf{i} + \left(-\frac{t^2}{2} + 10\right)\mathbf{j} + \left(-\frac{t^2}{2} + 10\right)\mathbf{k}$$

33. $\mathbf{r}(t) = (\sin t)\mathbf{i} + (t^2 - \cos t)\mathbf{j} + e^t\mathbf{k} \Rightarrow \mathbf{v}(t) = (\cos t)\mathbf{i} + (2t + \sin t)\mathbf{j} + e^t\mathbf{k}$; $t_0 = 0 \Rightarrow \mathbf{v}(t_0) = \mathbf{i} + \mathbf{k}$ and $\mathbf{r}(t_0) = \mathbf{P}_0 = (0, -1, 1) \Rightarrow x = 0 + t = t$, $y = -1$, and $z = 1 + t$ are parametric equations of the tangent line

34. $\mathbf{r}(t) = (2 \sin t)\mathbf{i} + (2 \cos t)\mathbf{j} + 5t\mathbf{k} \Rightarrow \mathbf{v}(t) = (2 \cos t)\mathbf{i} - (2 \sin t)\mathbf{j} + 5\mathbf{k}$; $t_0 = 4\pi \Rightarrow \mathbf{v}(t_0) = 2\mathbf{i} + 5\mathbf{k}$ and $\mathbf{r}(t_0) = \mathbf{P}_0 = (0, 2, 20\pi) \Rightarrow x = 0 + 2t = 2t$, $y = 2$, and $z = 20\pi + 5t$ are parametric equations of the tangent line

35. $\mathbf{r}(t) = (a \sin t)\mathbf{i} + (a \cos t)\mathbf{j} + bt\mathbf{k} \Rightarrow \mathbf{v}(t) = (a \cos t)\mathbf{i} - (a \sin t)\mathbf{j} + b\mathbf{k}$; $t_0 = 2\pi \Rightarrow \mathbf{v}(t_0) = a\mathbf{i} + b\mathbf{k}$ and $\mathbf{r}(t_0) = \mathbf{P}_0 = (0, a, 2b\pi) \Rightarrow x = 0 + at = at$, $y = a$, and $z = 2\pi b + bt$ are parametric equations of the tangent line

36. $\mathbf{r}(t) = (\cos t)\mathbf{i} + (\sin t)\mathbf{j} + (\sin 2t)\mathbf{k} \Rightarrow \mathbf{v}(t) = (-\sin t)\mathbf{i} + (\cos t)\mathbf{j} + (2 \cos 2t)\mathbf{k}$; $t_0 = \frac{\pi}{2} \Rightarrow \mathbf{v}(t_0) = -\mathbf{i} - 2\mathbf{k}$ and $\mathbf{r}(t_0) = \mathbf{P}_0 = (0, 1, 0) \Rightarrow x = 0 - t = -t$, $y = 1$, and $z = 0 - 2t = -2t$ are parametric equations of the tangent line

37. (a) $\mathbf{v}(t) = -(\sin t)\mathbf{i} + (\cos t)\mathbf{j} \Rightarrow \mathbf{a}(t) = -(\cos t)\mathbf{i} - (\sin t)\mathbf{j}$;

(i) $|\mathbf{v}(t)| = \sqrt{(-\sin t)^2 + (\cos t)^2} = 1 \Rightarrow$ constant speed;

(ii) $\mathbf{v} \cdot \mathbf{a} = (\sin t)(\cos t) - (\cos t)(\sin t) = 0 \Rightarrow$ yes, orthogonal;

(iii) counterclockwise movement;

(iv) yes, $\mathbf{r}(0) = \mathbf{i} + 0\mathbf{j}$

(b) $\mathbf{v}(t) = -(2 \sin 2t)\mathbf{i} + (2 \cos 2t)\mathbf{j} \Rightarrow \mathbf{a}(t) = -(4 \cos 2t)\mathbf{i} - (4 \sin 2t)\mathbf{j}$;

(i) $|\mathbf{v}(t)| = \sqrt{4 \sin^2 2t + 4 \cos^2 2t} = 2 \Rightarrow$ constant speed;

(ii) $\mathbf{v} \cdot \mathbf{a} = 8 \sin 2t \cos 2t - 8 \cos 2t \sin 2t = 0 \Rightarrow$ yes, orthogonal;

(iii) counterclockwise movement;

(iv) yes, $\mathbf{r}(0) = \mathbf{i} + 0\mathbf{j}$

(c) $\mathbf{v}(t) = -\sin\left(t - \frac{\pi}{2}\right)\mathbf{i} + \cos\left(t - \frac{\pi}{2}\right)\mathbf{j} \Rightarrow \mathbf{a}(t) = -\cos\left(t - \frac{\pi}{2}\right)\mathbf{i} - \sin\left(t - \frac{\pi}{2}\right)\mathbf{j}$;

(i) $|\mathbf{v}(t)| = \sqrt{\sin^2\left(t - \frac{\pi}{2}\right) + \cos^2\left(t - \frac{\pi}{2}\right)} = 1 \Rightarrow$ constant speed;

(ii) $\mathbf{v} \cdot \mathbf{a} = \sin\left(t - \frac{\pi}{2}\right)\cos\left(t - \frac{\pi}{2}\right) - \cos\left(t - \frac{\pi}{2}\right)\sin\left(t - \frac{\pi}{2}\right) = 0 \Rightarrow$ yes, orthogonal;

(iii) counterclockwise movement;

(iv) no, $\mathbf{r}(0) = 0\mathbf{i} - \mathbf{j}$ instead of $\mathbf{i} + 0\mathbf{j}$

(d) $\mathbf{v}(t) = -(\sin t)\mathbf{i} - (\cos t)\mathbf{j} \Rightarrow \mathbf{a}(t) = -(\cos t)\mathbf{i} + (\sin t)\mathbf{j}$;

(i) $|\mathbf{v}(t)| = \sqrt{(-\sin t)^2 + (-\cos t)^2} = 1 \Rightarrow$ constant speed;

(ii) $\mathbf{v} \cdot \mathbf{a} = (\sin t)(\cos t) - (\cos t)(\sin t) = 0 \Rightarrow$ yes, orthogonal;

(iii) clockwise movement;

(iv) yes, $\mathbf{r}(0) = \mathbf{i} - 0\mathbf{j}$

(e) $\mathbf{v}(t) = -(2t \sin t)\mathbf{i} + (2t \cos t)\mathbf{j} \Rightarrow \mathbf{a}(t) = -(2 \sin t + 2t \cos t)\mathbf{i} + (2 \cos t - 2t \sin t)\mathbf{j}$;

(i) $|\mathbf{v}(t)| = \sqrt{[-(2t \sin t)]^2 + (2t \cos t)^2} = \sqrt{4t^2(\sin^2 t + \cos^2 t)} = 2|t| = 2t, t \geq 0$
 \Rightarrow variable speed;

(ii) $\mathbf{v} \cdot \mathbf{a} = 4(t \sin^2 t + t^2 \sin t \cos t) + 4(t \cos^2 t - t^2 \cos t \sin t) = 4t \neq 0$ in general
 \Rightarrow not orthogonal in general;

(iii) counterclockwise movement;

(iv) yes, $\mathbf{r}(0) = \mathbf{i} + 0\mathbf{j}$

38. Let $\mathbf{p} = 2\mathbf{i} + 2\mathbf{j} + \mathbf{k}$ denote the position vector of the point $(2, 2, 1)$ and let, $\mathbf{u} = \frac{1}{\sqrt{2}}\mathbf{i} - \frac{1}{\sqrt{2}}\mathbf{j}$ and $\mathbf{v} = \frac{1}{\sqrt{3}}\mathbf{i} + \frac{1}{\sqrt{3}}\mathbf{j} + \frac{1}{\sqrt{3}}\mathbf{k}$.

Then $\mathbf{r}(t) = \mathbf{p} + (\cos t)\mathbf{u} + (\sin t)\mathbf{v}$. Note that $(2, 2, 1)$ is a point on the plane and $\mathbf{n} = \mathbf{i} + \mathbf{j} - 2\mathbf{k}$ is normal to the plane. Moreover, \mathbf{u} and \mathbf{v} are orthogonal unit vectors with $\mathbf{u} \cdot \mathbf{n} = \mathbf{v} \cdot \mathbf{n} = 0 \Rightarrow \mathbf{u}$ and \mathbf{v} are parallel to the plane. Therefore, $\mathbf{r}(t)$ identifies a point that lies in the plane for each t . Also, for each t , $(\cos t)\mathbf{u} + (\sin t)\mathbf{v}$

is a unit vector. Starting at the point $(2 + \frac{1}{\sqrt{2}}, 2 - \frac{1}{\sqrt{2}}, 1)$ the vector $\mathbf{r}(t)$ traces out a circle of radius 1 and center $(2, 2, 1)$ in the plane $x + y - 2z = 2$.

39. $\frac{d\mathbf{v}}{dt} = \mathbf{a} = 3\mathbf{i} - \mathbf{j} + \mathbf{k} \Rightarrow \mathbf{v}(t) = 3t\mathbf{i} - t\mathbf{j} + t\mathbf{k} + \mathbf{C}_1$; the particle travels in the direction of the vector $(4 - 1)\mathbf{i} + (1 - 2)\mathbf{j} + (4 - 3)\mathbf{k} = 3\mathbf{i} - \mathbf{j} + \mathbf{k}$ (since it travels in a straight line), and at time $t = 0$ it has speed 2 $\Rightarrow \mathbf{v}(0) = \frac{2}{\sqrt{9+1+1}}(3\mathbf{i} - \mathbf{j} + \mathbf{k}) = \mathbf{C}_1 \Rightarrow \frac{d\mathbf{r}}{dt} = \mathbf{v}(t) = (3t + \frac{6}{\sqrt{11}})\mathbf{i} - (t + \frac{2}{\sqrt{11}})\mathbf{j} + (t + \frac{2}{\sqrt{11}})\mathbf{k}$
 $\Rightarrow \mathbf{r}(t) = (\frac{3}{2}t^2 + \frac{6}{\sqrt{11}}t)\mathbf{i} - (\frac{1}{2}t^2 + \frac{2}{\sqrt{11}}t)\mathbf{j} + (\frac{1}{2}t^2 + \frac{2}{\sqrt{11}}t)\mathbf{k} + \mathbf{C}_2$; $\mathbf{r}(0) = \mathbf{i} + 2\mathbf{j} + 3\mathbf{k} = \mathbf{C}_2$
 $\Rightarrow \mathbf{r}(t) = (\frac{3}{2}t^2 + \frac{6}{\sqrt{11}}t + 1)\mathbf{i} - (\frac{1}{2}t^2 + \frac{2}{\sqrt{11}}t - 2)\mathbf{j} + (\frac{1}{2}t^2 + \frac{2}{\sqrt{11}}t + 3)\mathbf{k}$
 $= (\frac{1}{2}t^2 + \frac{2}{\sqrt{11}}t)(3\mathbf{i} - \mathbf{j} + \mathbf{k}) + (\mathbf{i} + 2\mathbf{j} + 3\mathbf{k})$
40. $\frac{d\mathbf{v}}{dt} = \mathbf{a} = 2\mathbf{i} + \mathbf{j} + \mathbf{k} \Rightarrow \mathbf{v}(t) = 2t\mathbf{i} + t\mathbf{j} + t\mathbf{k} + \mathbf{C}_1$; the particle travels in the direction of the vector $(3 - 1)\mathbf{i} + (0 - (-1))\mathbf{j} + (3 - 2)\mathbf{k} = 2\mathbf{i} + \mathbf{j} + \mathbf{k}$ (since it travels in a straight line), and at time $t = 0$ it has speed 2
 $\Rightarrow \mathbf{v}(0) = \frac{2}{\sqrt{4+1+1}}(2\mathbf{i} + \mathbf{j} + \mathbf{k}) = \mathbf{C}_1 \Rightarrow \frac{d\mathbf{r}}{dt} = \mathbf{v}(t) = (2t + \frac{4}{\sqrt{6}})\mathbf{i} + (t + \frac{2}{\sqrt{6}})\mathbf{j} + (t + \frac{2}{\sqrt{6}})\mathbf{k}$
 $\Rightarrow \mathbf{r}(t) = (t^2 + \frac{4}{\sqrt{6}}t)\mathbf{i} + (\frac{1}{2}t^2 + \frac{2}{\sqrt{6}}t)\mathbf{j} + (\frac{1}{2}t^2 + \frac{2}{\sqrt{6}}t)\mathbf{k} + \mathbf{C}_2$; $\mathbf{r}(0) = \mathbf{i} - \mathbf{j} + 2\mathbf{k} = \mathbf{C}_2$
 $\Rightarrow \mathbf{r}(t) = (t^2 + \frac{4}{\sqrt{6}}t + 1)\mathbf{i} + (\frac{1}{2}t^2 + \frac{2}{\sqrt{6}}t - 1)\mathbf{j} + (\frac{1}{2}t^2 + \frac{2}{\sqrt{6}}t + 2)\mathbf{k} = (\frac{1}{2}t^2 + \frac{2}{\sqrt{6}}t)(2\mathbf{i} + \mathbf{j} + \mathbf{k}) + (\mathbf{i} - \mathbf{j} + 2\mathbf{k})$
41. The velocity vector is tangent to the graph of $y^2 = 2x$ at the point $(2, 2)$, has length 5, and a positive i component. Now, $y^2 = 2x \Rightarrow 2y \frac{dy}{dx} = 2 \Rightarrow \frac{dy}{dx} \Big|_{(2,2)} = \frac{2}{2 \cdot 2} = \frac{1}{2} \Rightarrow$ the tangent vector lies in the direction of the vector $\mathbf{i} + \frac{1}{2}\mathbf{j} \Rightarrow$ the velocity vector is $\mathbf{v} = \frac{5}{\sqrt{1+\frac{1}{4}}}(\mathbf{i} + \frac{1}{2}\mathbf{j}) = \frac{5}{(\frac{\sqrt{5}}{2})}(\mathbf{i} + \frac{1}{2}\mathbf{j}) = 2\sqrt{5}\mathbf{i} + \sqrt{5}\mathbf{j}$

42. (a)

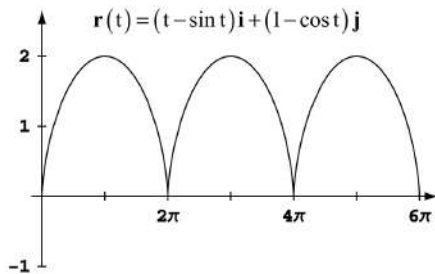

- (b) $\mathbf{v} = (1 - \cos t)\mathbf{i} + (\sin t)\mathbf{j}$ and $\mathbf{a} = (\sin t)\mathbf{i} + (\cos t)\mathbf{j}$; $|\mathbf{v}|^2 = (1 - \cos t)^2 + \sin^2 t = 2 - 2\cos t \Rightarrow |\mathbf{v}|^2$ is at a max when $\cos t = -1 \Rightarrow t = \pi, 3\pi, 5\pi$, etc., and at these values of t , $|\mathbf{v}|^2 = 4 \Rightarrow \max |\mathbf{v}| = \sqrt{4} = 2$; $|\mathbf{v}|^2$ is at a min when $\cos t = 1 \Rightarrow t = 0, 2\pi, 4\pi$, etc., and at these values of t , $|\mathbf{v}|^2 = 0 \Rightarrow \min |\mathbf{v}| = 0$; $|\mathbf{a}|^2 = \sin^2 t + \cos^2 t = 1$ for every $t \Rightarrow \max |\mathbf{a}| = \min |\mathbf{a}| = \sqrt{1} = 1$
43. $\mathbf{v} = (-3 \sin t)\mathbf{j} + (2 \cos t)\mathbf{k}$ and $\mathbf{a} = (-3 \cos t)\mathbf{j} - (2 \sin t)\mathbf{k}$; $|\mathbf{v}|^2 = 9 \sin^2 t + 4 \cos^2 t \Rightarrow \frac{d}{dt}(|\mathbf{v}|^2) = 18 \sin t \cos t - 8 \cos t \sin t = 10 \sin t \cos t$; $\frac{d}{dt}(|\mathbf{v}|^2) = 0 \Rightarrow 10 \sin t \cos t = 0 \Rightarrow \sin t = 0$ or $\cos t = 0$
 $\Rightarrow t = 0, \pi$ or $t = \frac{\pi}{2}, \frac{3\pi}{2}$. When $t = 0, \pi$, $|\mathbf{v}|^2 = 4 \Rightarrow |\mathbf{v}| = \sqrt{4} = 2$; when $t = \frac{\pi}{2}, \frac{3\pi}{2}$, $|\mathbf{v}|^2 = 9 \Rightarrow |\mathbf{v}| = 3$.
Therefore $\max |\mathbf{v}|$ is 3 when $t = \frac{\pi}{2}, \frac{3\pi}{2}$, and $\min |\mathbf{v}| = 2$ when $t = 0, \pi$. Next, $|\mathbf{a}|^2 = 9 \cos^2 t + 4 \sin^2 t$
 $\Rightarrow \frac{d}{dt}(|\mathbf{a}|^2) = -18 \cos t \sin t + 8 \sin t \cos t = -10 \sin t \cos t$; $\frac{d}{dt}(|\mathbf{a}|^2) = 0 \Rightarrow -10 \sin t \cos t = 0 \Rightarrow \sin t = 0$ or $\cos t = 0 \Rightarrow t = 0, \pi$ or $t = \frac{\pi}{2}, \frac{3\pi}{2}$. When $t = 0, \pi$, $|\mathbf{a}|^2 = 9 \Rightarrow |\mathbf{a}| = 3$; when $t = \frac{\pi}{2}, \frac{3\pi}{2}$, $|\mathbf{a}|^2 = 4 \Rightarrow |\mathbf{a}| = 2$.
Therefore, $\max |\mathbf{a}| = 3$ when $t = 0, \pi$, and $\min |\mathbf{a}| = 2$ when $t = \frac{\pi}{2}, \frac{3\pi}{2}$.

44. (a) $\mathbf{r}(t) = (r_0 \cos \theta)\mathbf{i} + (r_0 \sin \theta)\mathbf{j}$, and the distance traveled along the circle in time t is $v t$ (rate times time)
 which equals the circular arc length $r_0 \theta \Rightarrow \theta = \frac{v t}{r_0} \Rightarrow \mathbf{r}(t) = \left(r_0 \cos \frac{v t}{r_0}\right)\mathbf{i} + \left(r_0 \sin \frac{v t}{r_0}\right)\mathbf{j}$
- (b) $\mathbf{v}(t) = \frac{d\mathbf{r}}{dt} = \left(-v \sin \frac{v t}{r_0}\right)\mathbf{i} + \left(v \cos \frac{v t}{r_0}\right)\mathbf{j} \Rightarrow \mathbf{a}(t) = \frac{d\mathbf{v}}{dt} = \left(-\frac{v^2}{r_0} \cos \frac{v t}{r_0}\right)\mathbf{i} + \left(-\frac{v^2}{r_0} \sin \frac{v t}{r_0}\right)\mathbf{j}$
 $= -\frac{v^2}{r_0} \left[\left(r_0 \cos \frac{v t}{r_0}\right)\mathbf{i} + \left(r_0 \sin \frac{v t}{r_0}\right)\mathbf{j}\right] = -\frac{v^2}{r_0} \mathbf{r}(t)$
- (c) $\mathbf{F} = m\mathbf{a} \Rightarrow \left(-\frac{GmM}{r_0^2}\right)\frac{\mathbf{r}}{r_0} = m\left(-\frac{v^2}{r_0}\right)\mathbf{r} \Rightarrow -\frac{GmM}{r_0^3} = -\frac{mv^2}{r_0^3} \Rightarrow v^2 = \frac{GM}{r_0}$
- (d) T is the time for the satellite to complete one full orbit $\Rightarrow vT = \text{circumference of circle} \Rightarrow vT = 2\pi r_0$
- (e) Substitute $v = \frac{2\pi r_0}{T}$ into $v^2 = \frac{GM}{r_0} \Rightarrow \frac{4\pi^2 r_0^2}{T^2} = \frac{GM}{r_0} \Rightarrow T^2 = \frac{4\pi^2 r_0^3}{GM} \Rightarrow T^2$ is proportional to r_0^3 since $\frac{4\pi^2}{GM}$ is a constant

45. $\frac{d}{dt}(\mathbf{v} \cdot \mathbf{v}) = \mathbf{v} \cdot \frac{d\mathbf{v}}{dt} + \frac{d\mathbf{v}}{dt} \cdot \mathbf{v} = 2\mathbf{v} \cdot \frac{d\mathbf{v}}{dt} = 2 \cdot 0 = 0 \Rightarrow \mathbf{v} \cdot \mathbf{v}$ is a constant $\Rightarrow |\mathbf{v}| = \sqrt{\mathbf{v} \cdot \mathbf{v}}$ is constant

46. (a) $\frac{d}{dt}(\mathbf{u} \cdot \mathbf{v} \times \mathbf{w}) = \frac{d\mathbf{u}}{dt} \cdot (\mathbf{v} \times \mathbf{w}) + \mathbf{u} \cdot \frac{d}{dt}(\mathbf{v} \times \mathbf{w}) = \frac{d\mathbf{u}}{dt} \cdot (\mathbf{v} \times \mathbf{w}) + \mathbf{u} \cdot \left(\frac{d\mathbf{v}}{dt} \times \mathbf{w} + \mathbf{v} \times \frac{d\mathbf{w}}{dt}\right)$
 $= \frac{d\mathbf{u}}{dt} \cdot (\mathbf{v} \times \mathbf{w}) + \mathbf{u} \cdot \frac{d\mathbf{v}}{dt} \times \mathbf{w} + \mathbf{u} \cdot \mathbf{v} \times \frac{d\mathbf{w}}{dt}$

- (b) Each of the determinants is equivalent to each expression in Eq. 7 in part (a) because of the formula in Section 12.4 expressing the triple scalar product as a determinant.

47. $\frac{d}{dt} \left[\mathbf{r} \cdot \left(\frac{d\mathbf{r}}{dt} \times \frac{d^2\mathbf{r}}{dt^2} \right) \right] = \frac{d\mathbf{r}}{dt} \cdot \left(\frac{d\mathbf{r}}{dt} \times \frac{d^2\mathbf{r}}{dt^2} \right) + \mathbf{r} \cdot \left(\frac{d^2\mathbf{r}}{dt^2} \times \frac{d^2\mathbf{r}}{dt^2} \right) + \mathbf{r} \cdot \left(\frac{d\mathbf{r}}{dt} \times \frac{d^3\mathbf{r}}{dt^3} \right) = \mathbf{r} \cdot \left(\frac{d\mathbf{r}}{dt} \times \frac{d^3\mathbf{r}}{dt^3} \right)$, since $\mathbf{A} \cdot (\mathbf{A} \times \mathbf{B}) = 0$
 and $\mathbf{A} \cdot (\mathbf{B} \times \mathbf{B}) = 0$ for any vectors \mathbf{A} and \mathbf{B}

48. $\mathbf{u} = \mathbf{C} = a\mathbf{i} + b\mathbf{j} + c\mathbf{k}$ with a, b, c real constants $\Rightarrow \frac{d\mathbf{u}}{dt} = \frac{da}{dt}\mathbf{i} + \frac{db}{dt}\mathbf{j} + \frac{dc}{dt}\mathbf{k} = 0\mathbf{i} + 0\mathbf{j} + 0\mathbf{k} = \mathbf{0}$

49. (a) $\mathbf{u} = f(t)\mathbf{i} + g(t)\mathbf{j} + h(t)\mathbf{k} \Rightarrow c\mathbf{u} = cf(t)\mathbf{i} + cg(t)\mathbf{j} + ch(t)\mathbf{k} \Rightarrow \frac{d}{dt}(c\mathbf{u}) = c \frac{df}{dt}\mathbf{i} + c \frac{dg}{dt}\mathbf{j} + c \frac{dh}{dt}\mathbf{k}$
 $= c \left(\frac{df}{dt}\mathbf{i} + \frac{dg}{dt}\mathbf{j} + \frac{dh}{dt}\mathbf{k} \right) = c \frac{d\mathbf{u}}{dt}$

(b) $f\mathbf{u} = f f(t)\mathbf{i} + f g(t)\mathbf{j} + f h(t)\mathbf{k} \Rightarrow \frac{d}{dt}(f\mathbf{u}) = \left[\frac{df}{dt} f(t) + f \frac{df}{dt} \right] \mathbf{i} + \left[\frac{df}{dt} g(t) + f \frac{dg}{dt} \right] \mathbf{j} + \left[\frac{df}{dt} h(t) + f \frac{dh}{dt} \right] \mathbf{k}$
 $= \frac{df}{dt} [f(t)\mathbf{i} + g(t)\mathbf{j} + h(t)\mathbf{k}] + f \left[\frac{df}{dt}\mathbf{i} + \frac{dg}{dt}\mathbf{j} + \frac{dh}{dt}\mathbf{k} \right] = \frac{df}{dt} \mathbf{u} + f \frac{d\mathbf{u}}{dt}$

50. Let $\mathbf{u} = f_1(t)\mathbf{i} + f_2(t)\mathbf{j} + f_3(t)\mathbf{k}$ and $\mathbf{v} = g_1(t)\mathbf{i} + g_2(t)\mathbf{j} + g_3(t)\mathbf{k}$. Then

$$\begin{aligned} \mathbf{u} + \mathbf{v} &= [f_1(t) + g_1(t)]\mathbf{i} + [f_2(t) + g_2(t)]\mathbf{j} + [f_3(t) + g_3(t)]\mathbf{k} \\ &\Rightarrow \frac{d}{dt}(\mathbf{u} + \mathbf{v}) = [f_1'(t) + g_1'(t)]\mathbf{i} + [f_2'(t) + g_2'(t)]\mathbf{j} + [f_3'(t) + g_3'(t)]\mathbf{k} \\ &= [f_1'(t)\mathbf{i} + f_2'(t)\mathbf{j} + f_3'(t)\mathbf{k}] + [g_1'(t)\mathbf{i} + g_2'(t)\mathbf{j} + g_3'(t)\mathbf{k}] = \frac{d\mathbf{u}}{dt} + \frac{d\mathbf{v}}{dt}; \\ \mathbf{u} - \mathbf{v} &= [f_1(t) - g_1(t)]\mathbf{i} + [f_2(t) - g_2(t)]\mathbf{j} + [f_3(t) - g_3(t)]\mathbf{k} \\ &\Rightarrow \frac{d}{dt}(\mathbf{u} - \mathbf{v}) = [f_1'(t) - g_1'(t)]\mathbf{i} + [f_2'(t) - g_2'(t)]\mathbf{j} + [f_3'(t) - g_3'(t)]\mathbf{k} \\ &= [f_1'(t)\mathbf{i} + f_2'(t)\mathbf{j} + f_3'(t)\mathbf{k}] - [g_1'(t)\mathbf{i} + g_2'(t)\mathbf{j} + g_3'(t)\mathbf{k}] = \frac{d\mathbf{u}}{dt} - \frac{d\mathbf{v}}{dt} \end{aligned}$$

51. Suppose \mathbf{r} is continuous at $t = t_0$. Then $\lim_{t \rightarrow t_0} \mathbf{r}(t) = \mathbf{r}(t_0) \Leftrightarrow \lim_{t \rightarrow t_0} [f(t)\mathbf{i} + g(t)\mathbf{j} + h(t)\mathbf{k}]$
 $= f(t_0)\mathbf{i} + g(t_0)\mathbf{j} + h(t_0)\mathbf{k} \Leftrightarrow \lim_{t \rightarrow t_0} f(t) = f(t_0), \lim_{t \rightarrow t_0} g(t) = g(t_0), \text{ and } \lim_{t \rightarrow t_0} h(t) = h(t_0) \Leftrightarrow f, g, \text{ and } h \text{ are}$
 continuous at $t = t_0$.

52. $\lim_{t \rightarrow t_0} [\mathbf{r}_1(t) \times \mathbf{r}_2(t)] = \lim_{t \rightarrow t_0} \begin{vmatrix} \mathbf{i} & \mathbf{j} & \mathbf{k} \\ f_1(t) & f_2(t) & f_3(t) \\ g_1(t) & g_2(t) & g_3(t) \end{vmatrix} = \begin{vmatrix} \mathbf{i} & \mathbf{j} & \mathbf{k} \\ \lim_{t \rightarrow t_0} f_1(t) & \lim_{t \rightarrow t_0} f_2(t) & \lim_{t \rightarrow t_0} f_3(t) \\ \lim_{t \rightarrow t_0} g_1(t) & \lim_{t \rightarrow t_0} g_2(t) & \lim_{t \rightarrow t_0} g_3(t) \end{vmatrix}$
 $= \lim_{t \rightarrow t_0} \mathbf{r}_1(t) \times \lim_{t \rightarrow t_0} \mathbf{r}_2(t) = \mathbf{A} \times \mathbf{B}$

53. $\mathbf{r}'(t_0)$ exists $\Rightarrow f'(t_0)\mathbf{i} + g'(t_0)\mathbf{j} + h'(t_0)\mathbf{k}$ exists $\Rightarrow f'(t_0), g'(t_0), h'(t_0)$ all exist $\Rightarrow f, g,$ and h are continuous at $t = t_0 \Rightarrow \mathbf{r}(t)$ is continuous at $t = t_0$

$$54. \text{ (a) } \int_a^b \mathbf{k}\mathbf{r}(t) dt = \int_a^b [kf(t)\mathbf{i} + kg(t)\mathbf{j} + kh(t)\mathbf{k}] dt = \int_a^b [kf(t)] dt \mathbf{i} + \int_a^b [kg(t)] dt \mathbf{j} + \int_a^b [kh(t)] dt \mathbf{k} \\ = \mathbf{k} \left(\int_a^b f(t) dt \mathbf{i} + \int_a^b g(t) dt \mathbf{j} + \int_a^b h(t) dt \mathbf{k} \right) = \mathbf{k} \int_a^b \mathbf{r}(t) dt$$

$$\text{(b) } \int_a^b [\mathbf{r}_1(t) \pm \mathbf{r}_2(t)] dt = \int_a^b ([f_1(t)\mathbf{i} + g_1(t)\mathbf{j} + h_1(t)\mathbf{k}] \pm [f_2(t)\mathbf{i} + g_2(t)\mathbf{j} + h_2(t)\mathbf{k}]) dt \\ = \int_a^b ([f_1(t) \pm f_2(t)] \mathbf{i} + [g_1(t) \pm g_2(t)] \mathbf{j} + [h_1(t) \pm h_2(t)] \mathbf{k}) dt \\ = \int_a^b [f_1(t) \pm f_2(t)] dt \mathbf{i} + \int_a^b [g_1(t) \pm g_2(t)] dt \mathbf{j} + \int_a^b [h_1(t) \pm h_2(t)] dt \mathbf{k} \\ = \left[\int_a^b f_1(t) dt \mathbf{i} \pm \int_a^b f_2(t) dt \mathbf{i} \right] + \left[\int_a^b g_1(t) dt \mathbf{j} \pm \int_a^b g_2(t) dt \mathbf{j} \right] + \left[\int_a^b h_1(t) dt \mathbf{k} \pm \int_a^b h_2(t) dt \mathbf{k} \right] \\ = \int_a^b \mathbf{r}_1(t) dt \pm \int_a^b \mathbf{r}_2(t) dt$$

$$\text{(c) Let } \mathbf{C} = c_1\mathbf{i} + c_2\mathbf{j} + c_3\mathbf{k}. \text{ Then } \int_a^b \mathbf{C} \cdot \mathbf{r}(t) dt = \int_a^b [c_1f(t) + c_2g(t) + c_3h(t)] dt \\ = c_1 \int_a^b f(t) dt + c_2 \int_a^b g(t) dt + c_3 \int_a^b h(t) dt = \mathbf{C} \cdot \int_a^b \mathbf{r}(t) dt; \\ \int_a^b \mathbf{C} \times \mathbf{r}(t) dt = \int_a^b [c_2h(t) - c_3g(t)] \mathbf{i} + [c_3f(t) - c_1h(t)] \mathbf{j} + [c_1g(t) - c_2f(t)] \mathbf{k} dt \\ = \left[c_2 \int_a^b h(t) dt - c_3 \int_a^b g(t) dt \right] \mathbf{i} + \left[c_3 \int_a^b f(t) dt - c_1 \int_a^b h(t) dt \right] \mathbf{j} + \left[c_1 \int_a^b g(t) dt - c_2 \int_a^b f(t) dt \right] \mathbf{k} \\ = \mathbf{C} \times \int_a^b \mathbf{r}(t) dt$$

55. (a) Let u and \mathbf{r} be continuous on $[a, b]$. Then $\lim_{t \rightarrow t_0} u(t)\mathbf{r}(t) = \lim_{t \rightarrow t_0} [u(t)f(t)\mathbf{i} + u(t)g(t)\mathbf{j} + u(t)h(t)\mathbf{k}] \\ = u(t_0)f(t_0)\mathbf{i} + u(t_0)g(t_0)\mathbf{j} + u(t_0)h(t_0)\mathbf{k} = u(t_0)\mathbf{r}(t_0) \Rightarrow \mathbf{ur}$ is continuous for every t_0 in $[a, b]$.

$$\text{(b) Let } u \text{ and } \mathbf{r} \text{ be differentiable. Then } \frac{d}{dt} (\mathbf{ur}) = \frac{d}{dt} [u(t)f(t)\mathbf{i} + u(t)g(t)\mathbf{j} + u(t)h(t)\mathbf{k}] \\ = \left(\frac{du}{dt} f(t) + u(t) \frac{df}{dt} \right) \mathbf{i} + \left(\frac{du}{dt} g(t) + u(t) \frac{dg}{dt} \right) \mathbf{j} + \left(\frac{du}{dt} h(t) + u(t) \frac{dh}{dt} \right) \mathbf{k} \\ = [f(t)\mathbf{i} + g(t)\mathbf{j} + h(t)\mathbf{k}] \frac{du}{dt} + u(t) \left(\frac{df}{dt} \mathbf{i} + \frac{dg}{dt} \mathbf{j} + \frac{dh}{dt} \mathbf{k} \right) = \mathbf{r} \frac{du}{dt} + u \frac{d\mathbf{r}}{dt}$$

56. (a) If $\mathbf{R}_1(t)$ and $\mathbf{R}_2(t)$ have identical derivatives on I , then $\frac{d\mathbf{R}_1}{dt} = \frac{df_1}{dt} \mathbf{i} + \frac{dg_1}{dt} \mathbf{j} + \frac{dh_1}{dt} \mathbf{k} = \frac{df_2}{dt} \mathbf{i} + \frac{dg_2}{dt} \mathbf{j} + \frac{dh_2}{dt} \mathbf{k} \\ = \frac{d\mathbf{R}_2}{dt} \Rightarrow \frac{df_1}{dt} = \frac{df_2}{dt}, \frac{dg_1}{dt} = \frac{dg_2}{dt}, \frac{dh_1}{dt} = \frac{dh_2}{dt} \Rightarrow f_1(t) = f_2(t) + c_1, g_1(t) = g_2(t) + c_2, h_1(t) = h_2(t) + c_3 \\ \Rightarrow f_1(t)\mathbf{i} + g_1(t)\mathbf{j} + h_1(t)\mathbf{k} = [f_2(t) + c_1]\mathbf{i} + [g_2(t) + c_2]\mathbf{j} + [h_2(t) + c_3]\mathbf{k} \Rightarrow \mathbf{R}_1(t) = \mathbf{R}_2(t) + \mathbf{C}, \text{ where } \\ \mathbf{C} = c_1\mathbf{i} + c_2\mathbf{j} + c_3\mathbf{k}.$

(b) Let $\mathbf{R}(t)$ be an antiderivative of $\mathbf{r}(t)$ on I . Then $\mathbf{R}'(t) = \mathbf{r}(t)$. If $\mathbf{U}(t)$ is an antiderivative of $\mathbf{r}(t)$ on I , then $\mathbf{U}'(t) = \mathbf{r}(t)$. Thus $\mathbf{U}'(t) = \mathbf{R}'(t)$ on $I \Rightarrow \mathbf{U}(t) = \mathbf{R}(t) + \mathbf{C}$.

$$57. \frac{d}{dt} \int_a^t \mathbf{r}(\tau) d\tau = \frac{d}{dt} \int_a^t [f(\tau)\mathbf{i} + g(\tau)\mathbf{j} + h(\tau)\mathbf{k}] d\tau = \frac{d}{dt} \int_a^t f(\tau) d\tau \mathbf{i} + \frac{d}{dt} \int_a^t g(\tau) d\tau \mathbf{j} + \frac{d}{dt} \int_a^t h(\tau) d\tau \mathbf{k} \\ = f(t)\mathbf{i} + g(t)\mathbf{j} + h(t)\mathbf{k} = \mathbf{r}(t). \text{ Since } \frac{d}{dt} \int_a^t \mathbf{r}(\tau) d\tau = \mathbf{r}(t), \text{ we have that } \int_a^t \mathbf{r}(\tau) d\tau \text{ is an antiderivative of } \\ \mathbf{r}. \text{ If } \mathbf{R} \text{ is any antiderivative of } \mathbf{r}, \text{ then } \mathbf{R}(t) = \int_a^t \mathbf{r}(\tau) d\tau + \mathbf{C} \text{ by Exercise 56(b). Then } \mathbf{R}(a) = \int_a^a \mathbf{r}(\tau) d\tau + \mathbf{C} \\ = \mathbf{0} + \mathbf{C} \Rightarrow \mathbf{C} = \mathbf{R}(a) \Rightarrow \int_a^t \mathbf{r}(\tau) d\tau = \mathbf{R}(t) - \mathbf{C} = \mathbf{R}(t) - \mathbf{R}(a) \Rightarrow \int_a^b \mathbf{r}(\tau) d\tau = \mathbf{R}(b) - \mathbf{R}(a).$$

58-61. Example CAS commands:

Maple:

```
> with(plots);
r := t -> [sin(t)-t*cos(t),cos(t)+t*sin(t),t^2];
```

```

t0 := 3*Pi/2;
lo := 0;
hi := 6*Pi;
P1 := spacecurve( r(t), t=lo..hi, axes=boxed, thickness=3 );
display( P1, title="#58(a) (Section 13.1)" );
Dr := unapply( diff(r(t),t), t );          # (b)
Dr(t0);                                   # (c)
q1 := expand( r(t0) + Dr(t0)*(t-t0) );
T := unapply( q1, t );
P2 := spacecurve( T(t), t=lo..hi, axes=boxed, thickness=3, color=black );
display( [P1,P2], title="#58(d) (Section 13.1)" );

```

62-63. Example CAS commands:

Maple:

```

a := 'a'; b := 'b';
r := (a,b,t) -> [cos(a*t),sin(a*t),b*t];
Dr := unapply( diff(r(a,b,t),t), (a,b,t) );
t0 := 3*Pi/2;
q1 := expand( r(a,b,t0) + Dr(a,b,t0)*(t-t0) );
T := unapply( q1, (a,b,t) );
lo := 0;
hi := 4*Pi;
P := NULL;
for a in [ 1, 2, 4, 6 ] do
  P1 := spacecurve( r(a,1,t), t=lo..hi, thickness=3 );
  P2 := spacecurve( T(a,1,t), t=lo..hi, thickness=3, color=black );
  P := P, display( [P1,P2], axes=boxed, title=sprintf("#62 (Section 13.1)\n a=%a",a) );
end do;
display( [P], insequence=true );

```

58-63. Example CAS commands:

Mathematica: (assigned functions, parameters, and intervals will vary)

The x-y-z components for the curve are entered as a list of functions of t. The unit vectors **i**, **j**, **k** are not inserted.

If a graph is too small, highlight it and drag out a corner or side to make it larger.

Only the components of $r[t]$ and values for t_0 , t_{\min} , and t_{\max} require alteration for each problem.

```

Clear[r, v, t, x, y, z]
r[t_]= { Sin[t] - t Cos[t], Cos[t] + t Sin[t], t2}
t0= 3π / 2; tmin= 0; tmax= 6π;
ParametricPlot3D[Evaluate[r[t]], {t, tmin, tmax}, AxesLabel -> {x, y, z}];
v[t_]= r'[t]
tanline[t_]= v[t0] t + r[t0]
ParametricPlot3D[Evaluate[{r[t], tanline[t]}], {t, tmin, tmax}, AxesLabel -> {x, y, z}];

```

For 62 and 63, the curve can be defined as a function of t, a, and b. Leave a space between a and t and b and t.

```

Clear[r, v, t, x, y, z, a, b]
r[t_,a_,b_]= {Cos[a t], Sin[a t], b t}
t0= 3π / 2; tmin= 0; tmax= 4π;
v[t_,a_,b_]= D[r[t, a, b], t]
tanline[t_,a_,b_]=v[t0, a, b] t + r[t0, a, b]
pa1=ParametricPlot3D[Evaluate[{r[t, 1, 1], tanline[t, 1, 1]}], {t,tmin, tmax}, AxesLabel -> {x, y, z}];

```



```

pa2=ParametricPlot3D[Evaluate[{r[t, 2, 1], tanline[t, 2, 1]}], {t,tmin, tmax}, AxesLabel -> {x, y, z}];
pa4=ParametricPlot3D[Evaluate[{r[t, 4, 1], tanline[t, 4, 1]}], {t,tmin, tmax}, AxesLabel -> {x, y, z}];
pa6=ParametricPlot3D[Evaluate[{r[t, 6, 1], tanline[t, 6, 1]}], {t,tmin, tmax}, AxesLabel -> {x, y, z}];
Show[GraphicsArray[{pa1, pa2, pa4, pa6}]]

```

13.2 MODELING PROJECTILE MOTION

- $x = (v_0 \cos \alpha)t \Rightarrow (21 \text{ km})\left(\frac{1000 \text{ m}}{1 \text{ km}}\right) = (840 \text{ m/s})(\cos 60^\circ)t \Rightarrow t = \frac{21,000 \text{ m}}{(840 \text{ m/s})(\cos 60^\circ)} = 50 \text{ seconds}$
- $R = \frac{v_0^2}{g} \sin 2\alpha$ and maximum R occurs when $\alpha = 45^\circ \Rightarrow 24.5 \text{ km} = \left(\frac{v_0^2}{9.8 \text{ m/s}^2}\right) (\sin 90^\circ)$
 $\Rightarrow v_0 = \sqrt{(9.8)(24,500) \text{ m}^2/\text{s}^2} = 490 \text{ m/s}$
- (a) $t = \frac{2v_0 \sin \alpha}{g} = \frac{2(500 \text{ m/s})(\sin 45^\circ)}{9.8 \text{ m/s}^2} \approx 72.2 \text{ seconds}$; $R = \frac{v_0^2}{g} \sin 2\alpha = \frac{(500 \text{ m/s})^2}{9.8 \text{ m/s}^2} (\sin 90^\circ) \approx 25,510.2 \text{ m}$

(b) $x = (v_0 \cos \alpha)t \Rightarrow 5000 \text{ m} = (500 \text{ m/s})(\cos 45^\circ)t \Rightarrow t = \frac{5000 \text{ m}}{(500 \text{ m/s})(\cos 45^\circ)} \approx 14.14 \text{ s}$; thus,
 $y = (v_0 \sin \alpha)t - \frac{1}{2}gt^2 \Rightarrow y \approx (500 \text{ m/s})(\sin 45^\circ)(14.14 \text{ s}) - \frac{1}{2}(9.8 \text{ m/s}^2)(14.14 \text{ s})^2 \approx 4020 \text{ m}$

(c) $y_{\max} = \frac{(v_0 \sin \alpha)^2}{2g} = \frac{(500 \text{ m/s})(\sin 45^\circ)^2}{2(9.8 \text{ m/s}^2)} \approx 6378 \text{ m}$
- $y = y_0 + (v_0 \sin \alpha)t - \frac{1}{2}gt^2 \Rightarrow y = 32 \text{ ft} + (32 \text{ ft/sec})(\sin 30^\circ)t - \frac{1}{2}(32 \text{ ft/sec}^2)t^2 \Rightarrow y = 32 + 16t - 16t^2$;
the ball hits the ground when $y = 0 \Rightarrow 0 = 32 + 16t - 16t^2 \Rightarrow t = -1$ or $t = 2 \Rightarrow t = 2 \text{ sec}$ since $t > 0$; thus,
 $x = (v_0 \cos \alpha)t \Rightarrow x = (32 \text{ ft/sec})(\cos 30^\circ)t = 32\left(\frac{\sqrt{3}}{2}\right)(2) \approx 55.4 \text{ ft}$
- $x = x_0 + (v_0 \cos \alpha)t = 0 + (44 \cos 45^\circ)t = 22\sqrt{2}t$ and $y = y_0 + (v_0 \sin \alpha)t - \frac{1}{2}gt^2 = 6.5 + (44 \sin 45^\circ)t - 16t^2$
 $= 6.5 + 22\sqrt{2}t - 16t^2$; the shot lands when $y = 0 \Rightarrow t = \frac{22\sqrt{2} \pm \sqrt{968 + 416}}{32} \approx 2.135 \text{ sec}$ since $t > 0$; thus
 $x = 22\sqrt{2}t \approx (22\sqrt{2})(2.135) \approx 66.43 \text{ ft}$
- $x = 0 + (44 \cos 40^\circ)t \approx 33.706t$ and $y = 6.5 + (44 \sin 40^\circ)t - 16t^2 \approx 6.5 + 28.283t - 16t^2$; $y = 0$
 $\Rightarrow t \approx \frac{28.283 + \sqrt{(28.283)^2 + 416}}{32} \approx 1.9735 \text{ sec}$ since $t > 0$; thus $x \approx (33.706)(1.9735) \approx 66.52 \text{ ft} \Rightarrow$ the
difference in distances is about $66.52 - 66.43 = 0.09 \text{ ft}$ or about 1 inch
- (a) $R = \frac{v_0^2}{g} \sin 2\alpha \Rightarrow 10 \text{ m} = \left(\frac{v_0^2}{9.8 \text{ m/s}^2}\right) (\sin 90^\circ) \Rightarrow v_0^2 = 98 \text{ m}^2/\text{s}^2 \Rightarrow v_0 \approx 9.9 \text{ m/s}$;

(b) $6 \text{ m} \approx \frac{(9.9 \text{ m/s})^2}{9.8 \text{ m/s}^2} (\sin 2\alpha) \Rightarrow \sin 2\alpha \approx 0.59999 \Rightarrow 2\alpha \approx 36.87^\circ$ or $143.12^\circ \Rightarrow \alpha \approx 18.4^\circ$ or 71.6°
- $v_0 = 5 \times 10^6 \text{ m/s}$ and $x = 40 \text{ cm} = 0.4 \text{ m}$; thus $x = (v_0 \cos \alpha)t \Rightarrow 0.4 \text{ m} = (5 \times 10^6 \text{ m/s})(\cos 0^\circ)t$
 $\Rightarrow t = 0.08 \times 10^{-6} \text{ s} = 8 \times 10^{-8} \text{ s}$; also, $y = y_0 + (v_0 \sin \alpha)t - \frac{1}{2}gt^2$
 $\Rightarrow y = (5 \times 10^6 \text{ m/s})(\sin 0^\circ)(8 \times 10^{-8} \text{ s}) - \frac{1}{2}(9.8 \text{ m/s}^2)(8 \times 10^{-8} \text{ s})^2 = -3.136 \times 10^{-14} \text{ m}$ or
 $-3.136 \times 10^{-12} \text{ cm}$. Therefore, it drops $3.136 \times 10^{-12} \text{ cm}$.
- $R = \frac{v_0^2}{g} \sin 2\alpha \Rightarrow 3(248.8) \text{ ft} = \left(\frac{v_0^2}{32 \text{ ft/sec}^2}\right) (\sin 18^\circ) \Rightarrow v_0^2 \approx 77,292.84 \text{ ft}^2/\text{sec}^2 \Rightarrow v_0 \approx 278.02 \text{ ft/sec} \approx 190 \text{ mph}$
- $v_0 = \frac{80\sqrt{10}}{3} \text{ ft/sec}$ and $R = 200 \text{ ft} \Rightarrow 200 = \frac{\left(\frac{80\sqrt{10}}{3}\right)^2}{32} (\sin 2\alpha) \Rightarrow \sin 2\alpha = 0.9 \Rightarrow 2\alpha \approx 64.2^\circ \Rightarrow \alpha \approx 32.1^\circ$; or
 $2\alpha \approx 115.8^\circ \Rightarrow \alpha \approx 57.9^\circ$; If $\alpha \approx 32.1^\circ$, $y_{\max} = \frac{\left[\left(\frac{80\sqrt{10}}{3}\right)(\sin 32.1^\circ)\right]^2}{2(32)} \approx 31.4 \text{ ft}$. If $\alpha \approx 57.9^\circ$, $y_{\max} \approx 79.7 \text{ ft} > 75 \text{ ft}$. In
order to reach the cushion, the angle of elevation will need to be about 32.1° . At this angle, the circus performer will go

31.4 ft into the air at maximum height and will not strike the 75 ft high ceiling.

11. $x = (v_0 \cos \alpha)t \Rightarrow 135 \text{ ft} = (90 \text{ ft/sec})(\cos 30^\circ)t \Rightarrow t \approx 1.732 \text{ sec}$; $y = (v_0 \sin \alpha)t - \frac{1}{2}gt^2$
 $\Rightarrow y \approx (90 \text{ ft/sec})(\sin 30^\circ)(1.732 \text{ sec}) - \frac{1}{2}(32 \text{ ft/sec}^2)(1.732 \text{ sec})^2 \Rightarrow y \approx 29.94 \text{ ft} \Rightarrow$ the golf ball will clip the leaves at the top

12. $v_0 = 116 \text{ ft/sec}$, $\alpha = 45^\circ$, and $x = (v_0 \cos \alpha)t$
 $\Rightarrow 369 = (116 \cos 45^\circ)t \Rightarrow t \approx 4.50 \text{ sec}$;
 also $y = (v_0 \sin \alpha)t - \frac{1}{2}gt^2$
 $\Rightarrow y = (116 \sin 45^\circ)(4.50) - \frac{1}{2}(32)(4.50)^2$
 $\approx 45.11 \text{ ft}$. It will take the ball 4.50 sec to travel 369 ft. At that time the ball will be 45.11 ft in the air and will hit the green past the pin.

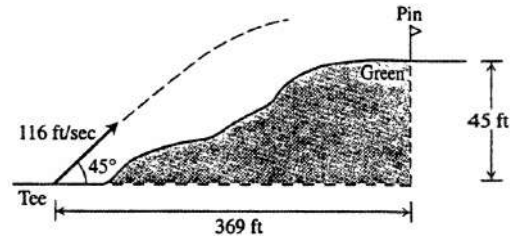

13. We do part b first.

(b) $x = (v_0 \cos \alpha)t \Rightarrow 315 \text{ ft} = (v_0 \cos 20^\circ)t \Rightarrow v_0 = \frac{315}{t \cos 20^\circ}$; also $y = (v_0 \sin \alpha)t - \frac{1}{2}gt^2$
 $\Rightarrow 34 \text{ ft} = \left(\frac{315}{t \cos 20^\circ}\right)(t \sin 20^\circ) - \frac{1}{2}(32)t^2 \Rightarrow 34 = 315 \tan 20^\circ - 16t^2 \Rightarrow t^2 \approx 5.04 \text{ sec}^2 \Rightarrow t \approx 2.25 \text{ sec}$

(a) $v_0 = \frac{315}{(2.25)(\cos 20^\circ)} \approx 149 \text{ ft/sec}$

14. $R = \frac{v_0^2}{g} \sin 2\alpha = \frac{v_0^2}{g} (2 \sin \alpha \cos \alpha) = \frac{v_0^2}{g} [2 \cos(90^\circ - \alpha) \sin(90^\circ - \alpha)] = \frac{v_0^2}{g} [\sin 2(90^\circ - \alpha)]$

15. $R = \frac{v_0^2}{g} \sin 2\alpha \Rightarrow 16,000 \text{ m} = \frac{(400 \text{ m/s})^2}{9.8 \text{ m/s}^2} \sin 2\alpha \Rightarrow \sin 2\alpha = 0.98 \Rightarrow 2\alpha \approx 78.5^\circ$ or $2\alpha \approx 101.5^\circ \Rightarrow \alpha \approx 39.3^\circ$ or 50.7°

16. (a) $R = \frac{(2v_0)^2}{g} \sin 2\alpha = \frac{4v_0^2}{g} \sin 2\alpha = 4 \left(\frac{v_0^2}{g} \sin 2\alpha\right)$ or 4 times the original range.

(b) Now, let the initial range be $R = \frac{v_0^2}{g} \sin 2\alpha$. Then we want the factor p so that pv_0 will double the range
 $\Rightarrow \frac{(pv_0)^2}{g} \sin 2\alpha = 2 \left(\frac{v_0^2}{g} \sin 2\alpha\right) \Rightarrow p^2 = 2 \Rightarrow p = \sqrt{2}$ or about 141%. The same percentage will approximately double the height: $\frac{(pv_0 \sin \alpha)^2}{2g} = \frac{2(v_0 \sin \alpha)^2}{2g} \Rightarrow p^2 = 2 \Rightarrow p = \sqrt{2}$.

17. $x = x_0 + (v_0 \cos \alpha)t = 0 + (v_0 \cos 40^\circ)t \approx 0.766 v_0 t$ and $y = y_0 + (v_0 \sin \alpha)t - \frac{1}{2}gt^2 = 6.5 + (v_0 \sin 40^\circ)t - 16t^2$
 $\approx 6.5 + 0.643 v_0 t - 16t^2$; now the shot went 73.833 ft $\Rightarrow 73.833 = 0.766 v_0 t \Rightarrow t \approx \frac{96.383}{v_0}$ sec; the shot lands when $y = 0 \Rightarrow 0 = 6.5 + (0.643)(96.383) - 16 \left(\frac{96.383}{v_0}\right)^2 \Rightarrow 0 \approx 68.474 - \frac{148,635}{v_0^2} \Rightarrow v_0 \approx \sqrt{\frac{148,635}{68.474}} \approx 46.6 \text{ ft/sec}$, the shot's initial speed

18. $y_{\max} = \frac{(v_0 \sin \alpha)^2}{2g} \Rightarrow \frac{3}{4} y_{\max} = \frac{3(v_0 \sin \alpha)^2}{8g}$ and $y = (v_0 \sin \alpha)t - \frac{1}{2}gt^2 \Rightarrow \frac{3(v_0 \sin \alpha)^2}{8g} = (v_0 \sin \alpha)t - \frac{1}{2}gt^2$
 $\Rightarrow 3(v_0 \sin \alpha)^2 = (8gv_0 \sin \alpha)t - 4g^2t^2 \Rightarrow 4g^2t^2 - (8gv_0 \sin \alpha)t + 3(v_0 \sin \alpha)^2 = 0 \Rightarrow 2gt - 3v_0 \sin \alpha = 0$ or $2gt - v_0 \sin \alpha = 0 \Rightarrow t = \frac{3v_0 \sin \alpha}{2g}$ or $t = \frac{v_0 \sin \alpha}{2g}$. Since the time it takes to reach y_{\max} is $t_{\max} = \frac{v_0 \sin \alpha}{g}$, then the time it takes the projectile to reach $\frac{3}{4}$ of y_{\max} is the shorter time $t = \frac{v_0 \sin \alpha}{2g}$ or half the time it takes to reach the maximum height.

19. $\frac{d\mathbf{r}}{dt} = \int (-g\mathbf{j}) dt = -gt\mathbf{j} + \mathbf{C}_1$ and $\frac{d\mathbf{r}}{dt}(0) = (v_0 \cos \alpha)\mathbf{i} + (v_0 \sin \alpha)\mathbf{j} \Rightarrow -g(0)\mathbf{j} + \mathbf{C}_1 = (v_0 \cos \alpha)\mathbf{i} + (v_0 \sin \alpha)\mathbf{j}$
 $\Rightarrow \mathbf{C}_1 = (v_0 \cos \alpha)\mathbf{i} + (v_0 \sin \alpha)\mathbf{j} \Rightarrow \frac{d\mathbf{r}}{dt} = (v_0 \cos \alpha)\mathbf{i} + (v_0 \sin \alpha - gt)\mathbf{j}$; $\mathbf{r} = \int [(v_0 \cos \alpha)\mathbf{i} + (v_0 \sin \alpha - gt)\mathbf{j}] dt$
 $= (v_0 t \cos \alpha)\mathbf{i} + (v_0 t \sin \alpha - \frac{1}{2}gt^2)\mathbf{j} + \mathbf{C}_2$ and $\mathbf{r}(0) = x_0\mathbf{i} + y_0\mathbf{j} \Rightarrow [v_0(0) \cos \alpha]\mathbf{i} + [v_0(0) \sin \alpha - \frac{1}{2}g(0)^2]\mathbf{j} + \mathbf{C}_2$
 $= x_0\mathbf{i} + y_0\mathbf{j} \Rightarrow \mathbf{C}_2 = x_0\mathbf{i} + y_0\mathbf{j} \Rightarrow \mathbf{r} = (x_0 + v_0 t \cos \alpha)\mathbf{i} + (y_0 + v_0 t \sin \alpha - \frac{1}{2}gt^2)\mathbf{j} \Rightarrow x = x_0 + v_0 t \cos \alpha$ and

$$y = y_0 + v_0 t \sin \alpha - \frac{1}{2} g t^2$$

20. From Example 3(b) in the text, $v_0 \sin \alpha = \sqrt{(68)(64)} \Rightarrow v_0 \sin 56.5^\circ \approx 65.97 \Rightarrow v_0 \approx 79$ ft/sec
21. The horizontal distance from Rebollo to the center of the cauldron is 90 ft \Rightarrow the horizontal distance to the nearest rim is $x = 90 - \frac{1}{2}(12) = 84 \Rightarrow 84 = x_0 + (v_0 \cos \alpha)t \approx 0 + \left(\frac{90g}{v_0 \sin \alpha}\right)t \Rightarrow 84 = \frac{(90)(32)}{\sqrt{(68)(64)}}t$
 $\Rightarrow t = 1.92$ sec. The vertical distance at this time is $y = y_0 + (v_0 \sin \alpha)t - \frac{1}{2} g t^2$
 $\approx 6 + \sqrt{(68)(64)}(1.92) - 16(1.92)^2 \approx 73.7$ ft \Rightarrow the arrow clears the rim by 3.7 ft
22. The projectile rises straight up and then falls straight down, returning to the firing point.
23. Flight time = 1 sec and the measure of the angle of elevation is about 64° (using a protractor) so that
 $t = \frac{2v_0 \sin \alpha}{g} \Rightarrow 1 = \frac{2v_0 \sin 64^\circ}{32} \Rightarrow v_0 \approx 17.80$ ft/sec. Then $y_{\max} = \frac{(17.80 \sin 64^\circ)^2}{2(32)} \approx 4.00$ ft and
 $R = \frac{v_0^2}{g} \sin 2\alpha \Rightarrow R = \frac{(17.80)^2}{32} \sin 128^\circ \approx 7.80$ ft \Rightarrow the engine traveled about 7.80 ft in 1 sec \Rightarrow the engine velocity was about 7.80 ft/sec
24. When marble A is located R units downrange, we have $x = (v_0 \cos \alpha)t \Rightarrow R = (v_0 \cos \alpha)t \Rightarrow t = \frac{R}{v_0 \cos \alpha}$. At that time the height of marble A is $y = y_0 + (v_0 \sin \alpha)t - \frac{1}{2} g t^2 = (v_0 \sin \alpha) \left(\frac{R}{v_0 \cos \alpha}\right) - \frac{1}{2} g \left(\frac{R}{v_0 \cos \alpha}\right)^2$
 $\Rightarrow y = R \tan \alpha - \frac{1}{2} g \left(\frac{R^2}{v_0^2 \cos^2 \alpha}\right)$. The height of marble B at the same time $t = \frac{R}{v_0 \cos \alpha}$ seconds is
 $h = R \tan \alpha - \frac{1}{2} g t^2 = R \tan \alpha - \frac{1}{2} g \left(\frac{R^2}{v_0^2 \cos^2 \alpha}\right)$. Since the heights are the same, the marbles collide regardless of the initial velocity v_0 .

25. (a) At the time t when the projectile hits the line OR we

$$\text{have } \tan \beta = \frac{y}{x}; x = [v_0 \cos(\alpha - \beta)]t \text{ and}$$

$$y = [v_0 \sin(\alpha - \beta)]t - \frac{1}{2} g t^2 < 0 \text{ since } R \text{ is}$$

below level ground. Therefore let

$$|y| = \frac{1}{2} g t^2 - [v_0 \sin(\alpha - \beta)]t > 0$$

$$\text{so that } \tan \beta = \frac{[\frac{1}{2} g t^2 (v_0 \sin(\alpha - \beta))]t}{[v_0 \cos(\alpha - \beta)]t} = \frac{[\frac{1}{2} g t - v_0 \sin(\alpha - \beta)]}{v_0 \cos(\alpha - \beta)}$$

$$\Rightarrow v_0 \cos(\alpha - \beta) \tan \beta = \frac{1}{2} g t - v_0 \sin(\alpha - \beta)$$

$$\Rightarrow t = \frac{2v_0 \sin(\alpha - \beta) + 2v_0 \cos(\alpha - \beta) \tan \beta}{g}, \text{ which is the time}$$

when the projectile hits the downhill slope. Therefore,

$$x = [v_0 \cos(\alpha - \beta)] \left[\frac{2v_0 \sin(\alpha - \beta) + 2v_0 \cos(\alpha - \beta) \tan \beta}{g} \right] = \frac{2v_0^2}{g} [\cos^2(\alpha - \beta) \tan \beta + \sin(\alpha - \beta) \cos(\alpha - \beta)]. \text{ If } x \text{ is}$$

$$\text{maximized, then OR is maximized: } \frac{dx}{d\alpha} = \frac{2v_0^2}{g} [-\sin 2(\alpha - \beta) \tan \beta + \cos 2(\alpha - \beta)] = 0$$

$$\Rightarrow -\sin 2(\alpha - \beta) \tan \beta + \cos 2(\alpha - \beta) = 0 \Rightarrow \tan \beta = \cot 2(\alpha - \beta) \Rightarrow 2(\alpha - \beta) = 90^\circ - \beta$$

$$\Rightarrow \alpha - \beta = \frac{1}{2}(90^\circ - \beta) \Rightarrow \alpha = \frac{1}{2}(90^\circ + \beta) = \frac{1}{2} \text{ of } \angle AOR.$$

- (b) At the time t when the projectile hits OR we have

$$\tan \beta = \frac{y}{x}; x = [v_0 \cos(\alpha + \beta)]t \text{ and}$$

$$y = [v_0 \sin(\alpha + \beta)]t - \frac{1}{2} g t^2$$

$$\Rightarrow \tan \beta = \frac{[v_0 \sin(\alpha + \beta)]t - \frac{1}{2} g t^2}{[v_0 \cos(\alpha + \beta)]t} = \frac{[v_0 \sin(\alpha + \beta) - \frac{1}{2} g t]}{v_0 \cos(\alpha + \beta)}$$

$$\Rightarrow v_0 \cos(\alpha + \beta) \tan \beta = v_0 \sin(\alpha + \beta) - \frac{1}{2} g t$$

$$\Rightarrow t = \frac{2v_0 \sin(\alpha + \beta) - 2v_0 \cos(\alpha + \beta) \tan \beta}{g}, \text{ which is the time}$$

when the projectile hits the uphill slope. Therefore,

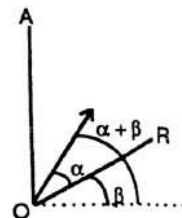
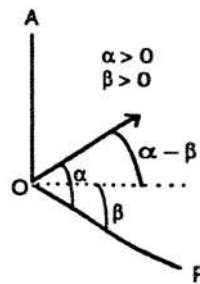

$x = [v_0 \cos(\alpha + \beta)] \left[\frac{2v_0 \sin(\alpha + \beta) - 2v_0 \cos(\alpha + \beta) \tan \beta}{g} \right] = \frac{2v_0^2}{g} [\sin(\alpha + \beta) \cos(\alpha + \beta) - \cos^2(\alpha + \beta) \tan \beta]$. If x is maximized, then OR is maximized: $\frac{dx}{d\alpha} = \frac{2v_0^2}{g} [\cos 2(\alpha + \beta) + \sin 2(\alpha + \beta) \tan \beta] = 0$
 $\Rightarrow \cos 2(\alpha + \beta) + \sin 2(\alpha + \beta) \tan \beta = 0 \Rightarrow \cot 2(\alpha + \beta) + \tan \beta = 0 \Rightarrow \cot 2(\alpha + \beta) = -\tan \beta$
 $= \tan(-\beta) \Rightarrow 2(\alpha + \beta) = 90^\circ - (-\beta) = 90^\circ + \beta \Rightarrow \alpha = \frac{1}{2}(90^\circ - \beta) = \frac{1}{2}$ of $\angle AOR$. Therefore v_0 would bisect $\angle AOR$ for maximum range uphill.

26. (a) $\mathbf{r}(t) = (x(t))\mathbf{i} + (y(t))\mathbf{j}$; where $x(t) = (145 \cos 23^\circ - 14)t$ and $y(t) = 2.5 + (145 \sin 23^\circ)t - 16t^2$.
 (b) $y_{\max} = \frac{(v_0 \sin \alpha)^2}{2g} + 2.5 = \frac{(145 \sin 23^\circ)^2}{64} + 2.5 \approx 52.655$ feet, which is reached at $t = \frac{v_0 \sin \alpha}{g} = \frac{145 \sin 23^\circ}{32} \approx 1.771$ seconds.
 (c) For the time, solve $y = 2.5 + (145 \sin 23^\circ)t - 16t^2 = 0$ for t , using the quadratic formula
 $t = \frac{145 \sin 23^\circ + \sqrt{(145 \sin 23^\circ)^2 + 160}}{32} \approx 3.585$ sec. Then the range at $t \approx 3.585$ is about $x = (145 \cos 23^\circ - 14)(3.585) \approx 428.311$ feet.
 (d) For the time, solve $y = 2.5 + (145 \sin 23^\circ)t - 16t^2 = 20$ for t , using the quadratic formula
 $t = \frac{145 \sin 23^\circ + \sqrt{(145 \sin 23^\circ)^2 - 1120}}{32} \approx 0.342$ and 3.199 seconds. At those times the ball is about $x(0.342) = (145 \cos 23^\circ - 14)(0.342) \approx 40.860$ feet from home plate and $x(3.199) = (145 \cos 23^\circ - 14)(3.199) \approx 382.195$ feet from home plate.
 (e) Yes. According to part (d), the ball is still 20 feet above the ground when it is 382 feet from home plate.
27. (a) (Assuming that "x" is zero at the point of impact):
 $\mathbf{r}(t) = (x(t))\mathbf{i} + (y(t))\mathbf{j}$; where $x(t) = (35 \cos 27^\circ)t$ and $y(t) = 4 + (35 \sin 27^\circ)t - 16t^2$.
 (b) $y_{\max} = \frac{(v_0 \sin \alpha)^2}{2g} + 4 = \frac{(35 \sin 27^\circ)^2}{64} + 4 \approx 7.945$ feet, which is reached at $t = \frac{v_0 \sin \alpha}{g} = \frac{35 \sin 27^\circ}{32} \approx 0.497$ seconds.
 (c) For the time, solve $y = 4 + (35 \sin 27^\circ)t - 16t^2 = 0$ for t , using the quadratic formula
 $t = \frac{35 \sin 27^\circ + \sqrt{(-35 \sin 27^\circ)^2 + 256}}{32} \approx 1.201$ sec. Then the range is about $x(1.201) = (35 \cos 27^\circ)(1.201) \approx 37.453$ feet.
 (d) For the time, solve $y = 4 + (35 \sin 27^\circ)t - 16t^2 = 7$ for t , using the quadratic formula
 $t = \frac{35 \sin 27^\circ + \sqrt{(-35 \sin 27^\circ)^2 - 192}}{32} \approx 0.254$ and 0.740 seconds. At those times the ball is about $x(0.254) = (35 \cos 27^\circ)(0.254) \approx 7.921$ feet and $x(0.740) = (35 \cos 27^\circ)(0.740) \approx 23.077$ feet the impact point, or about $37.453 - 7.921 \approx 29.532$ feet and $37.453 - 23.077 \approx 14.376$ feet from the landing spot.
 (e) Yes. It changes things because the ball won't clear the net ($y_{\max} \approx 7.945$).

28. The maximum height is $y = \frac{(v_0 \sin \alpha)^2}{2g}$ and this occurs for $x = \frac{v_0^2}{2g} \sin 2\alpha = \frac{v_0^2 \sin \alpha \cos \alpha}{g}$. These equations describe parametrically the points on a curve in the xy -plane associated with the maximum heights on the parabolic trajectories in terms of the parameter (launch angle) α . Eliminating the parameter α , we have $x^2 = \frac{v_0^4 \sin^2 \alpha \cos^2 \alpha}{g^2} = \frac{(v_0^4 \sin^2 \alpha)(1 - \sin^2 \alpha)}{g^2}$
 $= \frac{v_0^4 \sin^2 \alpha}{g^2} - \frac{v_0^4 \sin^4 \alpha}{g^2} = \frac{v_0^2}{g} (2y) - (2y)^2 \Rightarrow x^2 + 4y^2 - \left(\frac{2v_0^2}{g}\right)y = 0 \Rightarrow x^2 + 4\left[y^2 - \left(\frac{v_0^2}{2g}\right)y + \frac{v_0^4}{16g^2}\right] = \frac{v_0^4}{4g^2}$
 $\Rightarrow x^2 + 4\left(y - \frac{v_0^2}{4g}\right)^2 = \frac{v_0^4}{4g^2}$, where $x \geq 0$.

29. $\frac{d^2\mathbf{r}}{dt^2} + k\frac{d\mathbf{r}}{dt} = -g\mathbf{j} \Rightarrow \mathbf{P}(t) = k$ and $\mathbf{Q}(t) = -g\mathbf{j} \Rightarrow \int \mathbf{P}(t) dt = kt \Rightarrow \mathbf{v}(t) = e^{\int \mathbf{P}(t) dt} = e^{kt} \Rightarrow \frac{d\mathbf{r}}{dt} = \frac{1}{v(t)} \int v(t) \mathbf{Q}(t) dt$
 $= -ge^{-kt} \int e^{kt} \mathbf{j} dt = -ge^{-kt} \left[\frac{e^{kt}}{k} \mathbf{j} + \mathbf{C}_1 \right] = -\frac{g}{k} \mathbf{j} + \mathbf{C}e^{-kt}$, where $\mathbf{C} = -g\mathbf{C}_1$; apply the initial condition:
 $\left. \frac{d\mathbf{r}}{dt} \right|_{t=0} = (v_0 \cos \alpha)\mathbf{i} + (v_0 \sin \alpha)\mathbf{j} = -\frac{g}{k} \mathbf{j} + \mathbf{C} \Rightarrow \mathbf{C} = (v_0 \cos \alpha)\mathbf{i} + \left(\frac{g}{k} + v_0 \sin \alpha\right)\mathbf{j}$
 $\Rightarrow \frac{d\mathbf{r}}{dt} = (v_0 e^{-kt} \cos \alpha)\mathbf{i} + \left(-\frac{g}{k} + e^{-kt} \left(\frac{g}{k} + v_0 \sin \alpha\right)\right)\mathbf{j}$, $\mathbf{r} = \int \left[(v_0 e^{-kt} \cos \alpha)\mathbf{i} + \left(-\frac{g}{k} + e^{-kt} \left(\frac{g}{k} + v_0 \sin \alpha\right)\right)\mathbf{j} \right] dt$
 $= \left(-\frac{v_0}{k} e^{-kt} \cos \alpha\right)\mathbf{i} + \left(-\frac{gt}{k} - \frac{e^{-kt}}{k} \left(\frac{g}{k} + v_0 \sin \alpha\right)\right)\mathbf{j} + \mathbf{C}_2$; apply the initial condition:

$$\mathbf{r}(0) = \mathbf{0} = \left(-\frac{v_0}{k} \cos \alpha\right)\mathbf{i} + \left(-\frac{g}{k^2} - \frac{v_0 \sin \alpha}{k}\right)\mathbf{j} + \mathbf{C}_2 \Rightarrow \mathbf{C}_2 = \left(\frac{v_0}{k} \cos \alpha\right)\mathbf{i} + \left(\frac{g}{k^2} + \frac{v_0 \sin \alpha}{k}\right)\mathbf{j}$$

$$\Rightarrow \mathbf{r}(t) = \left(\frac{v_0}{k}(1 - e^{-kt}) \cos \alpha\right)\mathbf{i} + \left(\frac{v_0}{k}(1 - e^{-kt}) \sin \alpha + \frac{g}{k^2}(1 - kt - e^{-kt})\right)\mathbf{j}$$

30. (a) $\mathbf{r}(t) = (x(t))\mathbf{i} + (y(t))\mathbf{j}$; where $x(t) = \left(\frac{152}{0.12}\right)(1 - e^{-0.12t})(\cos 20^\circ)$ and $y(t) = 3 + \left(\frac{152}{0.12}\right)(1 - e^{-0.12t})(\sin 20^\circ) + \left(\frac{32}{0.12^2}\right)(1 - 0.12t - e^{-0.12t})$
- (b) Solve graphically using a calculator or CAS: At $t \approx 1.484$ seconds the ball reaches a maximum height of about 40.435 feet.
- (c) Use a graphing calculator or CAS to find that $y = 0$ when the ball has traveled for ≈ 3.126 seconds. The range is about $x(3.126) = \left(\frac{152}{0.12}\right)(1 - e^{-0.12(3.126)})(\cos 20^\circ) \approx 372.311$ feet.
- (d) Use a graphing calculator or CAS to find that $y = 30$ for $t \approx 0.689$ and 2.305 seconds, at which times the ball is about $x(0.689) \approx 94.454$ feet and $x(2.305) \approx 287.621$ feet from home plate.
- (e) Yes, the batter has hit a home run since a graph of the trajectory shows that the ball is more than 14 feet above the ground when it passes over the fence.
31. (a) $\mathbf{r}(t) = (x(t))\mathbf{i} + (y(t))\mathbf{j}$; where $x(t) = \left(\frac{1}{0.08}\right)(1 - e^{-0.08t})(152 \cos 20^\circ - 17.6)$ and $y(t) = 3 + \left(\frac{152}{0.08}\right)(1 - e^{-0.08t})(\sin 20^\circ) + \left(\frac{32}{0.08^2}\right)(1 - 0.08t - e^{-0.08t})$
- (b) Solve graphically using a calculator or CAS: At $t \approx 1.527$ seconds the ball reaches a maximum height of about 41.893 feet.
- (c) Use a graphing calculator or CAS to find that $y = 0$ when the ball has traveled for ≈ 3.181 seconds. The range is about $x(3.181) = \left(\frac{1}{0.08}\right)(1 - e^{-0.08(3.181)})(152 \cos 20^\circ - 17.6) \approx 351.734$ feet.
- (d) Use a graphing calculator or CAS to find that $y = 35$ for $t \approx 0.877$ and 2.190 seconds, at which times the ball is about $x(0.877) \approx 106.028$ feet and $x(2.190) \approx 251.530$ feet from home plate.
- (e) No; the range is less than 380 feet. To find the wind needed for a home run, first use the method of part (d) to find that $y = 20$ at $t \approx 0.376$ and 2.716 seconds. Then define $x(w) = \left(\frac{1}{0.08}\right)(1 - e^{-0.08(2.716)})(152 \cos 20^\circ + w)$, and solve $x(w) = 380$ to find $w \approx 12.846$ ft/sec.

13.3 ARC LENGTH AND THE UNIT TANGENT VECTOR **T**

1. $\mathbf{r} = (2 \cos t)\mathbf{i} + (2 \sin t)\mathbf{j} + \sqrt{5}t\mathbf{k} \Rightarrow \mathbf{v} = (-2 \sin t)\mathbf{i} + (2 \cos t)\mathbf{j} + \sqrt{5}\mathbf{k}$
 $\Rightarrow |\mathbf{v}| = \sqrt{(-2 \sin t)^2 + (2 \cos t)^2 + (\sqrt{5})^2} = \sqrt{4 \sin^2 t + 4 \cos^2 t + 5} = 3$; $\mathbf{T} = \frac{\mathbf{v}}{|\mathbf{v}|}$
 $= \left(-\frac{2}{3} \sin t\right)\mathbf{i} + \left(\frac{2}{3} \cos t\right)\mathbf{j} + \frac{\sqrt{5}}{3}\mathbf{k}$ and Length $= \int_0^\pi |\mathbf{v}| dt = \int_0^\pi 3 dt = [3t]_0^\pi = 3\pi$
2. $\mathbf{r} = (6 \sin 2t)\mathbf{i} + (6 \cos 2t)\mathbf{j} + 5t\mathbf{k} \Rightarrow \mathbf{v} = (12 \cos 2t)\mathbf{i} + (-12 \sin 2t)\mathbf{j} + 5\mathbf{k}$
 $\Rightarrow |\mathbf{v}| = \sqrt{(12 \cos 2t)^2 + (-12 \sin 2t)^2 + 5^2} = \sqrt{144 \cos^2 2t + 144 \sin^2 2t + 25} = 13$; $\mathbf{T} = \frac{\mathbf{v}}{|\mathbf{v}|}$
 $= \left(\frac{12}{13} \cos 2t\right)\mathbf{i} - \left(\frac{12}{13} \sin 2t\right)\mathbf{j} + \frac{5}{13}\mathbf{k}$ and Length $= \int_0^\pi |\mathbf{v}| dt = \int_0^\pi 13 dt = [13t]_0^\pi = 13\pi$
3. $\mathbf{r} = t\mathbf{i} + \frac{2}{3}t^{3/2}\mathbf{k} \Rightarrow \mathbf{v} = \mathbf{i} + t^{1/2}\mathbf{k} \Rightarrow |\mathbf{v}| = \sqrt{1^2 + (t^{1/2})^2} = \sqrt{1+t}$; $\mathbf{T} = \frac{\mathbf{v}}{|\mathbf{v}|} = \frac{1}{\sqrt{1+t}}\mathbf{i} + \frac{\sqrt{t}}{\sqrt{1+t}}\mathbf{k}$
and Length $= \int_0^8 \sqrt{1+t} dt = \left[\frac{2}{3}(1+t)^{3/2}\right]_0^8 = \frac{52}{3}$
4. $\mathbf{r} = (2+t)\mathbf{i} - (t+1)\mathbf{j} + t\mathbf{k} \Rightarrow \mathbf{v} = \mathbf{i} - \mathbf{j} + \mathbf{k} \Rightarrow |\mathbf{v}| = \sqrt{1^2 + (-1)^2 + 1^2} = \sqrt{3}$; $\mathbf{T} = \frac{\mathbf{v}}{|\mathbf{v}|} = \frac{1}{\sqrt{3}}\mathbf{i} - \frac{1}{\sqrt{3}}\mathbf{j} + \frac{1}{\sqrt{3}}\mathbf{k}$
and Length $= \int_0^3 \sqrt{3} dt = \left[\sqrt{3}t\right]_0^3 = 3\sqrt{3}$

5. $\mathbf{r} = (\cos^3 t)\mathbf{j} + (\sin^3 t)\mathbf{k} \Rightarrow \mathbf{v} = (-3 \cos^2 t \sin t)\mathbf{j} + (3 \sin^2 t \cos t)\mathbf{k} \Rightarrow |\mathbf{v}|$
 $= \sqrt{(-3 \cos^2 t \sin t)^2 + (3 \sin^2 t \cos t)^2} = \sqrt{(9 \cos^2 t \sin^2 t)(\cos^2 t + \sin^2 t)} = 3 |\cos t \sin t|;$
 $\mathbf{T} = \frac{\mathbf{v}}{|\mathbf{v}|} = \frac{-3 \cos^2 t \sin t}{3 |\cos t \sin t|} \mathbf{j} + \frac{3 \sin^2 t \cos t}{3 |\cos t \sin t|} \mathbf{k} = (-\cos t)\mathbf{j} + (\sin t)\mathbf{k}, \text{ if } 0 \leq t \leq \frac{\pi}{2}, \text{ and}$
 $\text{Length} = \int_0^{\pi/2} 3 |\cos t \sin t| dt = \int_0^{\pi/2} 3 \cos t \sin t dt = \int_0^{\pi/2} \frac{3}{2} \sin 2t dt = \left[-\frac{3}{4} \cos 2t\right]_0^{\pi/2} = \frac{3}{2}$
6. $\mathbf{r} = 6t^3\mathbf{i} - 2t^3\mathbf{j} - 3t^3\mathbf{k} \Rightarrow \mathbf{v} = 18t^2\mathbf{i} - 6t^2\mathbf{j} - 9t^2\mathbf{k} \Rightarrow |\mathbf{v}| = \sqrt{(18t^2)^2 + (-6t^2)^2 + (-9t^2)^2} = \sqrt{441t^4} = 21t^2;$
 $\mathbf{T} = \frac{\mathbf{v}}{|\mathbf{v}|} = \frac{18t^2}{21t^2} \mathbf{i} - \frac{6t^2}{21t^2} \mathbf{j} - \frac{9t^2}{21t^2} \mathbf{k} = \frac{6}{7} \mathbf{i} - \frac{2}{7} \mathbf{j} - \frac{3}{7} \mathbf{k} \text{ and } \text{Length} = \int_1^2 21t^2 dt = [7t^3]_1^2 = 49$
7. $\mathbf{r} = (t \cos t)\mathbf{i} + (t \sin t)\mathbf{j} + \frac{2\sqrt{2}}{3} t^{3/2}\mathbf{k} \Rightarrow \mathbf{v} = (\cos t - t \sin t)\mathbf{i} + (\sin t + t \cos t)\mathbf{j} + \left(\sqrt{2} t^{1/2}\right)\mathbf{k}$
 $\Rightarrow |\mathbf{v}| = \sqrt{(\cos t - t \sin t)^2 + (\sin t + t \cos t)^2 + \left(\sqrt{2} t\right)^2} = \sqrt{1 + t^2 + 2t} = \sqrt{(t+1)^2} = |t+1| = t+1, \text{ if } t \geq 0;$
 $\mathbf{T} = \frac{\mathbf{v}}{|\mathbf{v}|} = \left(\frac{\cos t - t \sin t}{t+1}\right)\mathbf{i} + \left(\frac{\sin t + t \cos t}{t+1}\right)\mathbf{j} + \left(\frac{\sqrt{2} t^{1/2}}{t+1}\right)\mathbf{k} \text{ and } \text{Length} = \int_0^{\pi} (t+1) dt = \left[\frac{t^2}{2} + t\right]_0^{\pi} = \frac{\pi^2}{2} + \pi$
8. $\mathbf{r} = (t \sin t + \cos t)\mathbf{i} + (t \cos t - \sin t)\mathbf{j} \Rightarrow \mathbf{v} = (\sin t + t \cos t - \sin t)\mathbf{i} + (\cos t - t \sin t - \cos t)\mathbf{j}$
 $= (t \cos t)\mathbf{i} - (t \sin t)\mathbf{j} \Rightarrow |\mathbf{v}| = \sqrt{(t \cos t)^2 + (-t \sin t)^2} = \sqrt{t^2} = |t| = t \text{ if } \sqrt{2} \leq t \leq 2; \mathbf{T} = \frac{\mathbf{v}}{|\mathbf{v}|}$
 $= \left(\frac{t \cos t}{t}\right)\mathbf{i} - \left(\frac{t \sin t}{t}\right)\mathbf{j} = (\cos t)\mathbf{i} - (\sin t)\mathbf{j} \text{ and } \text{Length} = \int_{\sqrt{2}}^2 t dt = \left[\frac{t^2}{2}\right]_{\sqrt{2}}^2 = 1$
9. Let $P(t_0)$ denote the point. Then $\mathbf{v} = (5 \cos t)\mathbf{i} - (5 \sin t)\mathbf{j} + 12\mathbf{k}$ and $26\pi = \int_0^{t_0} \sqrt{25 \cos^2 t + 25 \sin^2 t + 144} dt$
 $= \int_0^{t_0} 13 dt = 13t_0 \Rightarrow t_0 = 2\pi, \text{ and the point is } P(2\pi) = (5 \sin 2\pi, 5 \cos 2\pi, 24\pi) = (0, 5, 24\pi)$
10. Let $P(t_0)$ denote the point. Then $\mathbf{v} = (12 \cos t)\mathbf{i} + (12 \sin t)\mathbf{j} + 5\mathbf{k}$ and
 $-13\pi = \int_0^{t_0} \sqrt{144 \cos^2 t + 144 \sin^2 t + 25} dt = \int_0^{t_0} 13 dt = 13t_0 \Rightarrow t_0 = -\pi, \text{ and the point is}$
 $P(-\pi) = (12 \sin(-\pi), -12 \cos(-\pi), -5\pi) = (0, 12, -5\pi)$
11. $\mathbf{r} = (4 \cos t)\mathbf{i} + (4 \sin t)\mathbf{j} + 3t\mathbf{k} \Rightarrow \mathbf{v} = (-4 \sin t)\mathbf{i} + (4 \cos t)\mathbf{j} + 3\mathbf{k} \Rightarrow |\mathbf{v}| = \sqrt{(-4 \sin t)^2 + (4 \cos t)^2 + 3^2}$
 $= \sqrt{25} = 5 \Rightarrow s(t) = \int_0^t 5 d\tau = 5t \Rightarrow \text{Length} = s\left(\frac{\pi}{2}\right) = \frac{5\pi}{2}$
12. $\mathbf{r} = (\cos t + t \sin t)\mathbf{i} + (\sin t - t \cos t)\mathbf{j} \Rightarrow \mathbf{v} = (-\sin t + \sin t + t \cos t)\mathbf{i} + (\cos t - \cos t + t \sin t)\mathbf{j}$
 $= (t \cos t)\mathbf{i} + (t \sin t)\mathbf{j} \Rightarrow |\mathbf{v}| = \sqrt{(t \cos t)^2 + (t \sin t)^2} = \sqrt{t^2} = t, \text{ since } \frac{\pi}{2} \leq t \leq \pi \Rightarrow s(t) = \int_0^t \tau d\tau = \frac{t^2}{2}$
 $\Rightarrow \text{Length} = s(\pi) - s\left(\frac{\pi}{2}\right) = \frac{\pi^2}{2} - \frac{\left(\frac{\pi}{2}\right)^2}{2} = \frac{3\pi^2}{8}$
13. $\mathbf{r} = (e^t \cos t)\mathbf{i} + (e^t \sin t)\mathbf{j} + e^t\mathbf{k} \Rightarrow \mathbf{v} = (e^t \cos t - e^t \sin t)\mathbf{i} + (e^t \sin t + e^t \cos t)\mathbf{j} + e^t\mathbf{k}$
 $\Rightarrow |\mathbf{v}| = \sqrt{(e^t \cos t - e^t \sin t)^2 + (e^t \sin t + e^t \cos t)^2 + (e^t)^2} = \sqrt{3e^{2t}} = \sqrt{3} e^t \Rightarrow s(t) = \int_0^t \sqrt{3} e^{\tau} d\tau$
 $= \sqrt{3} e^t - \sqrt{3} \Rightarrow \text{Length} = s(0) - s(-\ln 4) = 0 - \left(\sqrt{3} e^{-\ln 4} - \sqrt{3}\right) = \frac{3\sqrt{3}}{4}$
14. $\mathbf{r} = (1 + 2t)\mathbf{i} + (1 + 3t)\mathbf{j} + (6 - 6t)\mathbf{k} \Rightarrow \mathbf{v} = 2\mathbf{i} + 3\mathbf{j} - 6\mathbf{k} \Rightarrow |\mathbf{v}| = \sqrt{2^2 + 3^2 + (-6)^2} = 7 \Rightarrow s(t) = \int_0^t 7 d\tau = 7t$
 $\Rightarrow \text{Length} = s(0) - s(-1) = 0 - (-7) = 7$

$$15. \mathbf{r} = (\sqrt{2}t)\mathbf{i} + (\sqrt{2}t)\mathbf{j} + (1-t^2)\mathbf{k} \Rightarrow \mathbf{v} = \sqrt{2}\mathbf{i} + \sqrt{2}\mathbf{j} - 2t\mathbf{k} \Rightarrow |\mathbf{v}| = \sqrt{(\sqrt{2})^2 + (\sqrt{2})^2 + (-2t)^2} = \sqrt{4+4t^2}$$

$$= 2\sqrt{1+t^2} \Rightarrow \text{Length} = \int_0^1 2\sqrt{1+t^2} dt = \left[2\left(\frac{1}{2}\sqrt{1+t^2} + \frac{1}{2}\ln(t + \sqrt{1+t^2})\right) \right]_0^1 = \sqrt{2} + \ln(1 + \sqrt{2})$$

16. Let the helix make one complete turn from $t = 0$ to $t = 2\pi$.
 Note that the radius of the cylinder is 1 \Rightarrow the circumference of the base is 2π . When $t = 2\pi$, the point P is $(\cos 2\pi, \sin 2\pi, 2\pi) = (1, 0, 2\pi) \Rightarrow$ the cylinder is 2π units high. Cut the cylinder along PQ and flatten. The resulting rectangle has a width equal to the circumference of the cylinder $= 2\pi$ and a height equal to 2π , the height of the cylinder. Therefore, the rectangle is a square and the portion of the helix from $t = 0$ to $t = 2\pi$ is its diagonal.

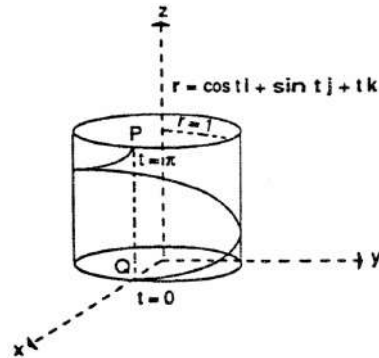

17. (a) $\mathbf{r} = (\cos t)\mathbf{i} + (\sin t)\mathbf{j} + (1 - \cos t)\mathbf{k}$, $0 \leq t \leq 2\pi \Rightarrow x = \cos t$, $y = \sin t$, $z = 1 - \cos t \Rightarrow x^2 + y^2 = \cos^2 t + \sin^2 t = 1$, a right circular cylinder with the z-axis as the axis and radius = 1. Therefore $P(\cos t, \sin t, 1 - \cos t)$ lies on the cylinder $x^2 + y^2 = 1$; $t = 0 \Rightarrow P(1, 0, 0)$ is on the curve; $t = \frac{\pi}{2} \Rightarrow Q(0, 1, 1)$ is on the curve; $t = \pi \Rightarrow R(-1, 0, 2)$ is on the curve. Then $\vec{PQ} = -\mathbf{i} + \mathbf{j} + \mathbf{k}$ and $\vec{PR} = -2\mathbf{i} + 2\mathbf{k}$

$$\Rightarrow \vec{PQ} \times \vec{PR} = \begin{vmatrix} \mathbf{i} & \mathbf{j} & \mathbf{k} \\ -1 & 1 & 1 \\ -2 & 0 & 2 \end{vmatrix} = 2\mathbf{i} + 2\mathbf{k}$$

is a vector normal to the plane of P, Q, and R. Then the

plane containing P, Q, and R has an equation $2x + 2z = 2(1) + 2(0)$ or $x + z = 1$. Any point on the curve will satisfy this equation since $x + z = \cos t + (1 - \cos t) = 1$. Therefore, any point on the curve lies on the intersection of the cylinder $x^2 + y^2 = 1$ and the plane $x + z = 1 \Rightarrow$ the curve is an ellipse.

(b) $\mathbf{v} = (-\sin t)\mathbf{i} + (\cos t)\mathbf{j} + (\sin t)\mathbf{k} \Rightarrow |\mathbf{v}| = \sqrt{\sin^2 t + \cos^2 t + \sin^2 t} = \sqrt{1 + \sin^2 t} \Rightarrow \mathbf{T} = \frac{\mathbf{v}}{|\mathbf{v}|}$
 $= \frac{(-\sin t)\mathbf{i} + (\cos t)\mathbf{j} + (\sin t)\mathbf{k}}{\sqrt{1 + \sin^2 t}} \Rightarrow \mathbf{T}(0) = \mathbf{j}$, $\mathbf{T}(\frac{\pi}{2}) = \frac{-\mathbf{i} + \mathbf{k}}{\sqrt{2}}$, $\mathbf{T}(\pi) = -\mathbf{j}$, $\mathbf{T}(\frac{3\pi}{2}) = \frac{\mathbf{i} - \mathbf{k}}{\sqrt{2}}$

- (c) $\mathbf{a} = (-\cos t)\mathbf{i} - (\sin t)\mathbf{j} + (\cos t)\mathbf{k}$; $\mathbf{n} = \mathbf{i} + \mathbf{k}$ is normal to the plane $x + z = 1 \Rightarrow \mathbf{n} \cdot \mathbf{a} = -\cos t + \cos t = 0 \Rightarrow \mathbf{a}$ is orthogonal to $\mathbf{n} \Rightarrow \mathbf{a}$ is parallel to the plane; $\mathbf{a}(0) = -\mathbf{i} + \mathbf{k}$, $\mathbf{a}(\frac{\pi}{2}) = -\mathbf{j}$, $\mathbf{a}(\pi) = \mathbf{i} - \mathbf{k}$, $\mathbf{a}(\frac{3\pi}{2}) = \mathbf{j}$

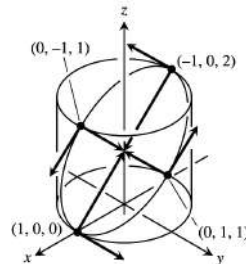

(d) $|\mathbf{v}| = \sqrt{1 + \sin^2 t}$ (See part (b)) $\Rightarrow L = \int_0^{2\pi} \sqrt{1 + \sin^2 t} dt$

(e) $L \approx 7.64$ (by *Mathematica*)

18. (a) $\mathbf{r} = (\cos 4t)\mathbf{i} + (\sin 4t)\mathbf{j} + 4t\mathbf{k} \Rightarrow \mathbf{v} = (-4 \sin 4t)\mathbf{i} + (4 \cos 4t)\mathbf{j} + 4\mathbf{k} \Rightarrow |\mathbf{v}| = \sqrt{(-4 \sin 4t)^2 + (4 \cos 4t)^2 + 4^2}$
 $= \sqrt{32} = 4\sqrt{2} \Rightarrow \text{Length} = \int_0^{\pi/2} 4\sqrt{2} dt = [4\sqrt{2}t]_0^{\pi/2} = 2\pi\sqrt{2}$

(b) $\mathbf{r} = (\cos \frac{1}{2}t)\mathbf{i} + (\sin \frac{1}{2}t)\mathbf{j} + \frac{1}{2}t\mathbf{k} \Rightarrow \mathbf{v} = (-\frac{1}{2}\sin \frac{1}{2}t)\mathbf{i} + (\frac{1}{2}\cos \frac{1}{2}t)\mathbf{j} + \frac{1}{2}\mathbf{k}$
 $\Rightarrow |\mathbf{v}| = \sqrt{(-\frac{1}{2}\sin \frac{1}{2}t)^2 + (\frac{1}{2}\cos \frac{1}{2}t)^2 + (\frac{1}{2})^2} = \sqrt{\frac{1}{4} + \frac{1}{4}} = \frac{\sqrt{2}}{2} \Rightarrow \text{Length} = \int_0^{4\pi} \frac{\sqrt{2}}{2} dt = \left[\frac{\sqrt{2}}{2}t \right]_0^{4\pi} = 2\pi\sqrt{2}$

(c) $\mathbf{r} = (\cos t)\mathbf{i} - (\sin t)\mathbf{j} - t\mathbf{k} \Rightarrow \mathbf{v} = (-\sin t)\mathbf{i} - (\cos t)\mathbf{j} - \mathbf{k} \Rightarrow |\mathbf{v}| = \sqrt{(-\sin t)^2 + (-\cos t)^2 + (-1)^2} = \sqrt{1+1}$
 $= \sqrt{2} \Rightarrow \text{Length} = \int_{-2\pi}^0 \sqrt{2} dt = \left[\sqrt{2}t \right]_{-2\pi}^0 = 2\pi\sqrt{2}$

19. $\angle PQB = \angle QOB = t$ and $PQ = \text{arc}(AQ) = t$ since
 $PQ = \text{length of the unwound string} = \text{length of arc}(AQ)$;
 thus $x = OB + BC = OB + DP = \cos t + t \sin t$, and
 $y = PC = QB - QD = \sin t - t \cos t$

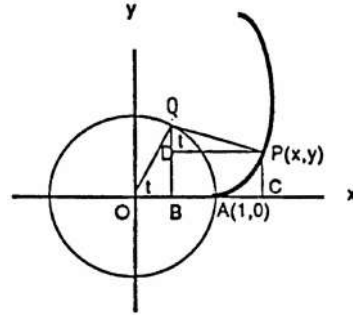

20. $\mathbf{r} = (\cos t + t \sin t)\mathbf{i} + (\sin t + t \cos t)\mathbf{j} \Rightarrow \mathbf{v} = (-\sin t + t \cos t + \sin t)\mathbf{i} + (\cos t - (t(-\sin t) + \cos t))\mathbf{j}$
 $= (t \cos t)\mathbf{i} + (t \sin t)\mathbf{j} \Rightarrow |\mathbf{v}| = \sqrt{(t \cos t)^2 + (t \sin t)^2} = \sqrt{t^2} = |t| = t, t \geq 0 \Rightarrow \mathbf{T} = \frac{\mathbf{v}}{|\mathbf{v}|} = \frac{t \cos t}{t}\mathbf{i} + \frac{t \sin t}{t}\mathbf{j}$
 $= \cos t \mathbf{i} + \sin t \mathbf{j}$

13.4 CURVATURE AND THE UNIT NORMAL VECTOR N

1. $\mathbf{r} = t\mathbf{i} + \ln(\cos t)\mathbf{j} \Rightarrow \mathbf{v} = \mathbf{i} + \left(\frac{-\sin t}{\cos t}\right)\mathbf{j} = \mathbf{i} - (\tan t)\mathbf{j} \Rightarrow |\mathbf{v}| = \sqrt{1^2 + (-\tan t)^2} = \sqrt{\sec^2 t} = |\sec t| = \sec t$, since
 $-\frac{\pi}{2} < t < \frac{\pi}{2} \Rightarrow \mathbf{T} = \frac{\mathbf{v}}{|\mathbf{v}|} = \left(\frac{1}{\sec t}\right)\mathbf{i} - \left(\frac{\tan t}{\sec t}\right)\mathbf{j} = (\cos t)\mathbf{i} - (\sin t)\mathbf{j}; \frac{d\mathbf{T}}{dt} = (-\sin t)\mathbf{i} - (\cos t)\mathbf{j}$
 $\Rightarrow \left|\frac{d\mathbf{T}}{dt}\right| = \sqrt{(-\sin t)^2 + (-\cos t)^2} = 1 \Rightarrow \mathbf{N} = \frac{\left(\frac{d\mathbf{T}}{dt}\right)}{\left|\frac{d\mathbf{T}}{dt}\right|} = (-\sin t)\mathbf{i} - (\cos t)\mathbf{j};$
 $\kappa = \frac{1}{|\mathbf{v}|} \cdot \left|\frac{d\mathbf{T}}{dt}\right| = \frac{1}{\sec t} \cdot 1 = \cos t.$
2. $\mathbf{r} = \ln(\sec t)\mathbf{i} + t\mathbf{j} \Rightarrow \mathbf{v} = \left(\frac{\sec t \tan t}{\sec t}\right)\mathbf{i} + \mathbf{j} = (\tan t)\mathbf{i} + \mathbf{j} \Rightarrow |\mathbf{v}| = \sqrt{(\tan t)^2 + 1^2} = \sqrt{\sec^2 t} = |\sec t| = \sec t$,
 since $-\frac{\pi}{2} < t < \frac{\pi}{2} \Rightarrow \mathbf{T} = \frac{\mathbf{v}}{|\mathbf{v}|} = \left(\frac{\tan t}{\sec t}\right)\mathbf{i} + \left(\frac{1}{\sec t}\right)\mathbf{j} = (\sin t)\mathbf{i} + (\cos t)\mathbf{j}; \frac{d\mathbf{T}}{dt} = (\cos t)\mathbf{i} - (\sin t)\mathbf{j}$
 $\Rightarrow \left|\frac{d\mathbf{T}}{dt}\right| = \sqrt{(\cos t)^2 + (-\sin t)^2} = 1 \Rightarrow \mathbf{N} = \frac{\left(\frac{d\mathbf{T}}{dt}\right)}{\left|\frac{d\mathbf{T}}{dt}\right|} = (\cos t)\mathbf{i} - (\sin t)\mathbf{j};$
 $\kappa = \frac{1}{|\mathbf{v}|} \cdot \left|\frac{d\mathbf{T}}{dt}\right| = \frac{1}{\sec t} \cdot 1 = \cos t.$
3. $\mathbf{r} = (2t + 3)\mathbf{i} + (5 - t^2)\mathbf{j} \Rightarrow \mathbf{v} = 2\mathbf{i} - 2t\mathbf{j} \Rightarrow |\mathbf{v}| = \sqrt{2^2 + (-2t)^2} = 2\sqrt{1 + t^2} \Rightarrow \mathbf{T} = \frac{\mathbf{v}}{|\mathbf{v}|} = \frac{2}{2\sqrt{1+t^2}}\mathbf{i} + \frac{-2t}{2\sqrt{1+t^2}}\mathbf{j}$
 $= \frac{1}{\sqrt{1+t^2}}\mathbf{i} - \frac{t}{\sqrt{1+t^2}}\mathbf{j}; \frac{d\mathbf{T}}{dt} = \frac{-t}{(\sqrt{1+t^2})^3}\mathbf{i} - \frac{1}{(\sqrt{1+t^2})^3}\mathbf{j} \Rightarrow \left|\frac{d\mathbf{T}}{dt}\right| = \sqrt{\left(\frac{-t}{(\sqrt{1+t^2})^3}\right)^2 + \left(-\frac{1}{(\sqrt{1+t^2})^3}\right)^2}$
 $= \sqrt{\frac{1}{(1+t^2)^3}} = \frac{1}{1+t^2} \Rightarrow \mathbf{N} = \frac{\left(\frac{d\mathbf{T}}{dt}\right)}{\left|\frac{d\mathbf{T}}{dt}\right|} = \frac{-t}{\sqrt{1+t^2}}\mathbf{i} - \frac{1}{\sqrt{1+t^2}}\mathbf{j};$
 $\kappa = \frac{1}{|\mathbf{v}|} \cdot \left|\frac{d\mathbf{T}}{dt}\right| = \frac{1}{2\sqrt{1+t^2}} \cdot \frac{1}{1+t^2} = \frac{1}{2(1+t^2)^{3/2}}$
4. $\mathbf{r} = (\cos t + t \sin t)\mathbf{i} + (\sin t - t \cos t)\mathbf{j} \Rightarrow \mathbf{v} = (t \cos t)\mathbf{i} + (t \sin t)\mathbf{j} \Rightarrow |\mathbf{v}| = \sqrt{(t \cos t)^2 + (t \sin t)^2} = \sqrt{t^2} = |t|$
 $= t$, since $t > 0 \Rightarrow \mathbf{T} = \frac{\mathbf{v}}{|\mathbf{v}|} = \frac{(t \cos t)\mathbf{i} + (t \sin t)\mathbf{j}}{t} = (\cos t)\mathbf{i} + (\sin t)\mathbf{j}; \frac{d\mathbf{T}}{dt} = (-\sin t)\mathbf{i} + (\cos t)\mathbf{j}$
 $\Rightarrow \left|\frac{d\mathbf{T}}{dt}\right| = \sqrt{(-\sin t)^2 + (\cos t)^2} = 1 \Rightarrow \mathbf{N} = \frac{\left(\frac{d\mathbf{T}}{dt}\right)}{\left|\frac{d\mathbf{T}}{dt}\right|} = (-\sin t)\mathbf{i} + (\cos t)\mathbf{j}; \kappa = \frac{1}{|\mathbf{v}|} \cdot \left|\frac{d\mathbf{T}}{dt}\right| = \frac{1}{t} \cdot 1 = \frac{1}{t}$

5. (a) $\kappa(x) = \frac{1}{|\mathbf{v}(x)|} \cdot \left|\frac{d\mathbf{T}(x)}{dx}\right|$. Now, $\mathbf{v} = \mathbf{i} + f'(x)\mathbf{j} \Rightarrow |\mathbf{v}(x)| = \sqrt{1 + [f'(x)]^2} \Rightarrow \mathbf{T} = \frac{\mathbf{v}}{|\mathbf{v}|}$
 $= \left(1 + [f'(x)]^2\right)^{-1/2} \mathbf{i} + f'(x) \left(1 + [f'(x)]^2\right)^{-1/2} \mathbf{j}$. Thus $\frac{d\mathbf{T}}{dx}(x) = \frac{-f'(x)f''(x)}{(1 + [f'(x)]^2)^{3/2}}\mathbf{i} + \frac{f''(x)}{(1 + [f'(x)]^2)^{3/2}}\mathbf{j}$
 $\Rightarrow \left|\frac{d\mathbf{T}(x)}{dx}\right| = \sqrt{\left[\frac{-f'(x)f''(x)}{(1 + [f'(x)]^2)^{3/2}}\right]^2 + \left[\frac{f''(x)}{(1 + [f'(x)]^2)^{3/2}}\right]^2} = \sqrt{\frac{[f''(x)]^2(1 + [f'(x)]^2)}{(1 + [f'(x)]^2)^3}} = \frac{|f''(x)|}{1 + [f'(x)]^2}$

$$\text{Thus } \kappa(x) = \frac{1}{(1+[f'(x)]^2)^{3/2}} \cdot \frac{|f''(x)|}{|1+[f'(x)]^2|} = \frac{|f''(x)|}{(1+[f'(x)]^2)^{3/2}}$$

$$\begin{aligned} \text{(b) } y = \ln(\cos x) &\Rightarrow \frac{dy}{dx} = \left(\frac{1}{\cos x}\right)(-\sin x) = -\tan x \Rightarrow \frac{d^2y}{dx^2} = -\sec^2 x \Rightarrow \kappa = \frac{|-\sec^2 x|}{[1+(-\tan x)^2]^{3/2}} = \frac{\sec^2 x}{|\sec^3 x|} \\ &= \frac{1}{\sec x} = \cos x, \text{ since } -\frac{\pi}{2} < x < \frac{\pi}{2} \end{aligned}$$

(c) Note that $f''(x) = 0$ at an inflection point.

$$\begin{aligned} \text{6. (a) } \mathbf{r} = f(t)\mathbf{i} + g(t)\mathbf{j} = x\mathbf{i} + y\mathbf{j} &\Rightarrow \mathbf{v} = \dot{x}\mathbf{i} + \dot{y}\mathbf{j} \Rightarrow |\mathbf{v}| = \sqrt{\dot{x}^2 + \dot{y}^2} \Rightarrow \mathbf{T} = \frac{\mathbf{v}}{|\mathbf{v}|} = \frac{\dot{x}}{\sqrt{\dot{x}^2 + \dot{y}^2}}\mathbf{i} + \frac{\dot{y}}{\sqrt{\dot{x}^2 + \dot{y}^2}}\mathbf{j} \\ \frac{d\mathbf{T}}{dt} &= \frac{\dot{y}(\dot{y}\dot{x} - \dot{x}\dot{y})}{(\dot{x}^2 + \dot{y}^2)^{3/2}}\mathbf{i} + \frac{\dot{x}(\dot{x}\dot{y} - \dot{y}\dot{x})}{(\dot{x}^2 + \dot{y}^2)^{3/2}}\mathbf{j} \Rightarrow \left|\frac{d\mathbf{T}}{dt}\right| = \sqrt{\left[\frac{\dot{y}(\dot{y}\dot{x} - \dot{x}\dot{y})}{(\dot{x}^2 + \dot{y}^2)^{3/2}}\right]^2 + \left[\frac{\dot{x}(\dot{x}\dot{y} - \dot{y}\dot{x})}{(\dot{x}^2 + \dot{y}^2)^{3/2}}\right]^2} = \sqrt{\frac{(\dot{y}^2 + \dot{x}^2)(\dot{y}\dot{x} - \dot{x}\dot{y})^2}{(\dot{x}^2 + \dot{y}^2)^3}} \\ &= \frac{|\dot{y}\dot{x} - \dot{x}\dot{y}|}{|\dot{x}^2 + \dot{y}^2|}; \kappa = \frac{1}{|\mathbf{v}|} \cdot \left|\frac{d\mathbf{T}}{dt}\right| = \frac{1}{\sqrt{\dot{x}^2 + \dot{y}^2}} \cdot \frac{|\dot{y}\dot{x} - \dot{x}\dot{y}|}{|\dot{x}^2 + \dot{y}^2|} = \frac{|\dot{y}\dot{x} - \dot{x}\dot{y}|}{(\dot{x}^2 + \dot{y}^2)^{3/2}}. \end{aligned}$$

$$\begin{aligned} \text{(b) } \mathbf{r}(t) = t\mathbf{i} + \ln(\sin t)\mathbf{j}, 0 < t < \pi &\Rightarrow x = t \text{ and } y = \ln(\sin t) \Rightarrow \dot{x} = 1, \dot{y} = 0; \dot{y} = \frac{\cos t}{\sin t} = \cot t, \ddot{y} = -\csc^2 t \\ &\Rightarrow \kappa = \frac{|-\csc^2 t - 0|}{(1 + \cot^2 t)^{3/2}} = \frac{\csc^2 t}{\csc^3 t} = \sin t \end{aligned}$$

$$\begin{aligned} \text{(c) } \mathbf{r}(t) = \tan^{-1}(\sinh t)\mathbf{i} + \ln(\cosh t)\mathbf{j} &\Rightarrow x = \tan^{-1}(\sinh t) \text{ and } y = \ln(\cosh t) \Rightarrow \dot{x} = \frac{\cosh t}{1 + \sinh^2 t} = \frac{1}{\cosh t} \\ &= \operatorname{sech} t, \ddot{x} = -\operatorname{sech} t \tanh t; \dot{y} = \frac{\sinh t}{\cosh t} = \tanh t, \ddot{y} = \operatorname{sech}^2 t \Rightarrow \kappa = \frac{|\operatorname{sech}^3 t + \operatorname{sech} t \tanh^2 t|}{(\operatorname{sech}^2 t + \tanh^2 t)^{3/2}} = |\operatorname{sech} t| \\ &= \operatorname{sech} t \end{aligned}$$

7. (a) $\mathbf{r}(t) = f(t)\mathbf{i} + g(t)\mathbf{j} \Rightarrow \mathbf{v} = f'(t)\mathbf{i} + g'(t)\mathbf{j}$ is tangent to the curve at the point $(f(t), g(t))$;
 $\mathbf{n} \cdot \mathbf{v} = [-g'(t)\mathbf{i} + f'(t)\mathbf{j}] \cdot [f'(t)\mathbf{i} + g'(t)\mathbf{j}] = -g'(t)f'(t) + f'(t)g'(t) = 0$; $-\mathbf{n} \cdot \mathbf{v} = -(\mathbf{n} \cdot \mathbf{v}) = 0$; thus,
 \mathbf{n} and $-\mathbf{n}$ are both normal to the curve at the point

$$\begin{aligned} \text{(b) } \mathbf{r}(t) = t\mathbf{i} + e^{2t}\mathbf{j} &\Rightarrow \mathbf{v} = \mathbf{i} + 2e^{2t}\mathbf{j} \Rightarrow \mathbf{n} = -2e^{2t}\mathbf{i} + \mathbf{j} \text{ points toward the concave side of the curve; } \mathbf{N} = \frac{\mathbf{n}}{|\mathbf{n}|} \text{ and} \\ |\mathbf{n}| = \sqrt{4e^{4t} + 1} &\Rightarrow \mathbf{N} = \frac{-2e^{2t}}{\sqrt{1 + 4e^{4t}}}\mathbf{i} + \frac{1}{\sqrt{1 + 4e^{4t}}}\mathbf{j} \end{aligned}$$

$$\begin{aligned} \text{(c) } \mathbf{r}(t) = \sqrt{4 - t^2}\mathbf{i} + t\mathbf{j} &\Rightarrow \mathbf{v} = \frac{-t}{\sqrt{4 - t^2}}\mathbf{i} + \mathbf{j} \Rightarrow \mathbf{n} = -\mathbf{i} - \frac{t}{\sqrt{4 - t^2}}\mathbf{j} \text{ points toward the concave side of the curve;} \\ \mathbf{N} = \frac{\mathbf{n}}{|\mathbf{n}|} \text{ and } |\mathbf{n}| = \sqrt{1 + \frac{t^2}{4 - t^2}} = \frac{2}{\sqrt{4 - t^2}} &\Rightarrow \mathbf{N} = -\frac{1}{2}(\sqrt{4 - t^2}\mathbf{i} + t\mathbf{j}) \end{aligned}$$

8. (a) $\mathbf{r}(t) = t\mathbf{i} + \frac{1}{3}t^3\mathbf{j} \Rightarrow \mathbf{v} = \mathbf{i} + t^2\mathbf{j} \Rightarrow \mathbf{n} = t^2\mathbf{i} - \mathbf{j}$ points toward the concave side of the curve when $t < 0$ and
 $-\mathbf{n} = -t^2\mathbf{i} + \mathbf{j}$ points toward the concave side when $t > 0 \Rightarrow \mathbf{N} = \frac{1}{\sqrt{1 + t^4}}(t^2\mathbf{i} - \mathbf{j})$ for $t < 0$ and
 $\mathbf{N} = \frac{1}{\sqrt{1 + t^4}}(-t^2\mathbf{i} + \mathbf{j})$ for $t > 0$

$$\begin{aligned} \text{(b) From part (a), } |\mathbf{v}| = \sqrt{1 + t^4} &\Rightarrow \mathbf{T} = \frac{1}{\sqrt{1 + t^4}}\mathbf{i} + \frac{t^2}{\sqrt{1 + t^4}}\mathbf{j} \Rightarrow \frac{d\mathbf{T}}{dt} = \frac{-2t^3}{(1 + t^4)^{3/2}}\mathbf{i} + \frac{2t}{(1 + t^4)^{3/2}}\mathbf{j} \Rightarrow \left|\frac{d\mathbf{T}}{dt}\right| = \sqrt{\frac{4t^6 + 4t^2}{(1 + t^4)^3}} \\ &= \frac{2|t|}{1 + t^4}; \mathbf{N} = \frac{(\frac{d\mathbf{T}}{dt})}{|\frac{d\mathbf{T}}{dt}|} = \frac{1 + t^4}{2|t|} \left(\frac{-2t^3}{(1 + t^4)^{3/2}}\mathbf{i} + \frac{2t}{(1 + t^4)^{3/2}}\mathbf{j} \right) = \frac{-t^3}{|t|\sqrt{1 + t^4}}\mathbf{i} + \frac{t}{|t|\sqrt{1 + t^4}}\mathbf{j}; t \neq 0 \end{aligned}$$

\mathbf{N} does not exist at $t = 0$, where the curve has a point of inflection; $\frac{d\mathbf{T}}{dt} \Big|_{t=0} = 0$ so the curvature $\kappa = \left|\frac{d\mathbf{T}}{ds}\right|$
 $= \left|\frac{d\mathbf{T}}{dt} \cdot \frac{dt}{ds}\right| = 0$ at $t = 0 \Rightarrow \mathbf{N} = \frac{1}{\kappa} \frac{d\mathbf{T}}{ds}$ is undefined. Since $x = t$ and $y = \frac{1}{3}t^3 \Rightarrow y = \frac{1}{3}x^3$, the curve is the
 cubic power curve which is concave down for $x = t < 0$ and concave up for $x = t > 0$.

$$\begin{aligned} \text{9. } \mathbf{r} = (3 \sin t)\mathbf{i} + (3 \cos t)\mathbf{j} + 4t\mathbf{k} &\Rightarrow \mathbf{v} = (3 \cos t)\mathbf{i} + (-3 \sin t)\mathbf{j} + 4\mathbf{k} \Rightarrow |\mathbf{v}| = \sqrt{(3 \cos t)^2 + (-3 \sin t)^2 + 4^2} \\ &= \sqrt{25} = 5 \Rightarrow \mathbf{T} = \frac{\mathbf{v}}{|\mathbf{v}|} = \left(\frac{3}{5} \cos t\right)\mathbf{i} - \left(\frac{3}{5} \sin t\right)\mathbf{j} + \frac{4}{5}\mathbf{k} \Rightarrow \frac{d\mathbf{T}}{dt} = \left(-\frac{3}{5} \sin t\right)\mathbf{i} - \left(\frac{3}{5} \cos t\right)\mathbf{j} \\ &\Rightarrow \left|\frac{d\mathbf{T}}{dt}\right| = \sqrt{\left(-\frac{3}{5} \sin t\right)^2 + \left(-\frac{3}{5} \cos t\right)^2} = \frac{3}{5} \Rightarrow \mathbf{N} = \frac{(\frac{d\mathbf{T}}{dt})}{|\frac{d\mathbf{T}}{dt}|} = (-\sin t)\mathbf{i} - (\cos t)\mathbf{j}; \kappa = \frac{1}{5} \cdot \frac{3}{5} = \frac{3}{25} \end{aligned}$$

$$\begin{aligned} \text{10. } \mathbf{r} = (\cos t + t \sin t)\mathbf{i} + (\sin t - t \cos t)\mathbf{j} + 3t\mathbf{k} &\Rightarrow \mathbf{v} = (t \cos t)\mathbf{i} + (t \sin t)\mathbf{j} \Rightarrow |\mathbf{v}| = \sqrt{(t \cos t)^2 + (t \sin t)^2} = \sqrt{t^2} \\ &= |t| = t, \text{ if } t > 0 \Rightarrow \mathbf{T} = \frac{\mathbf{v}}{|\mathbf{v}|} = (\cos t)\mathbf{i} - (\sin t)\mathbf{j}, t > 0 \Rightarrow \frac{d\mathbf{T}}{dt} = (-\sin t)\mathbf{i} + (\cos t)\mathbf{j} \\ &\Rightarrow \left|\frac{d\mathbf{T}}{dt}\right| = \sqrt{(-\sin t)^2 + (\cos t)^2} = 1 \Rightarrow \mathbf{N} = \frac{(\frac{d\mathbf{T}}{dt})}{|\frac{d\mathbf{T}}{dt}|} = (-\sin t)\mathbf{i} + (\cos t)\mathbf{j}; \kappa = \frac{1}{t} \cdot 1 = \frac{1}{t} \end{aligned}$$

$$11. \mathbf{r} = (e^t \cos t)\mathbf{i} + (e^t \sin t)\mathbf{j} + 2\mathbf{k} \Rightarrow \mathbf{v} = (e^t \cos t - e^t \sin t)\mathbf{i} + (e^t \sin t + e^t \cos t)\mathbf{j} \Rightarrow$$

$$|\mathbf{v}| = \sqrt{(e^t \cos t - e^t \sin t)^2 + (e^t \sin t + e^t \cos t)^2} = \sqrt{2e^{2t}} = e^t \sqrt{2};$$

$$\mathbf{T} = \frac{\mathbf{v}}{|\mathbf{v}|} = \left(\frac{\cos t - \sin t}{\sqrt{2}} \right)\mathbf{i} + \left(\frac{\sin t + \cos t}{\sqrt{2}} \right)\mathbf{j} \Rightarrow \frac{d\mathbf{T}}{dt} = \left(\frac{-\sin t - \cos t}{\sqrt{2}} \right)\mathbf{i} + \left(\frac{\cos t - \sin t}{\sqrt{2}} \right)\mathbf{j}$$

$$\Rightarrow \left| \frac{d\mathbf{T}}{dt} \right| = \sqrt{\left(\frac{-\sin t - \cos t}{\sqrt{2}} \right)^2 + \left(\frac{\cos t - \sin t}{\sqrt{2}} \right)^2} = 1 \Rightarrow \mathbf{N} = \frac{\left(\frac{d\mathbf{T}}{dt} \right)}{\left| \frac{d\mathbf{T}}{dt} \right|} = \left(\frac{-\cos t - \sin t}{\sqrt{2}} \right)\mathbf{i} + \left(\frac{-\sin t + \cos t}{\sqrt{2}} \right)\mathbf{j};$$

$$\kappa = \frac{1}{|\mathbf{v}|} \cdot \left| \frac{d\mathbf{T}}{dt} \right| = \frac{1}{e^t \sqrt{2}} \cdot 1 = \frac{1}{e^t \sqrt{2}}$$

$$12. \mathbf{r} = (6 \sin 2t)\mathbf{i} + (6 \cos 2t)\mathbf{j} + 5t\mathbf{k} \Rightarrow \mathbf{v} = (12 \cos 2t)\mathbf{i} - (12 \sin 2t)\mathbf{j} + 5\mathbf{k}$$

$$\Rightarrow |\mathbf{v}| = \sqrt{(12 \cos 2t)^2 + (-12 \sin 2t)^2 + 5^2} = \sqrt{169} = 13 \Rightarrow \mathbf{T} = \frac{\mathbf{v}}{|\mathbf{v}|}$$

$$= \left(\frac{12}{13} \cos 2t \right)\mathbf{i} - \left(\frac{12}{13} \sin 2t \right)\mathbf{j} + \frac{5}{13}\mathbf{k} \Rightarrow \frac{d\mathbf{T}}{dt} = \left(-\frac{24}{13} \sin 2t \right)\mathbf{i} - \left(\frac{24}{13} \cos 2t \right)\mathbf{j}$$

$$\Rightarrow \left| \frac{d\mathbf{T}}{dt} \right| = \sqrt{\left(-\frac{24}{13} \sin 2t \right)^2 + \left(-\frac{24}{13} \cos 2t \right)^2} = \frac{24}{13} \Rightarrow \mathbf{N} = \frac{\left(\frac{d\mathbf{T}}{dt} \right)}{\left| \frac{d\mathbf{T}}{dt} \right|} = (-\sin 2t)\mathbf{i} - (\cos 2t)\mathbf{j};$$

$$\kappa = \frac{1}{|\mathbf{v}|} \cdot \left| \frac{d\mathbf{T}}{dt} \right| = \frac{1}{13} \cdot \frac{24}{13} = \frac{24}{169}$$

$$13. \mathbf{r} = \left(\frac{t^3}{3} \right)\mathbf{i} + \left(\frac{t^2}{2} \right)\mathbf{j}, t > 0 \Rightarrow \mathbf{v} = t^2\mathbf{i} + t\mathbf{j} \Rightarrow |\mathbf{v}| = \sqrt{t^4 + t^2} = t\sqrt{t^2 + 1}, \text{ since } t > 0 \Rightarrow \mathbf{T} = \frac{\mathbf{v}}{|\mathbf{v}|}$$

$$= \frac{t}{\sqrt{t^2+1}}\mathbf{i} + \frac{1}{\sqrt{t^2+1}}\mathbf{j} \Rightarrow \frac{d\mathbf{T}}{dt} = \frac{1}{(t^2+1)^{3/2}}\mathbf{i} - \frac{t}{(t^2+1)^{3/2}}\mathbf{j} \Rightarrow \left| \frac{d\mathbf{T}}{dt} \right| = \sqrt{\left(\frac{1}{(t^2+1)^{3/2}} \right)^2 + \left(\frac{-t}{(t^2+1)^{3/2}} \right)^2}$$

$$= \sqrt{\frac{1+t^2}{(t^2+1)^3}} = \frac{1}{t^2+1} \Rightarrow \mathbf{N} = \frac{\left(\frac{d\mathbf{T}}{dt} \right)}{\left| \frac{d\mathbf{T}}{dt} \right|} = \frac{1}{\sqrt{t^2+1}}\mathbf{i} - \frac{t}{\sqrt{t^2+1}}\mathbf{j}; \kappa = \frac{1}{|\mathbf{v}|} \cdot \left| \frac{d\mathbf{T}}{dt} \right| = \frac{1}{t\sqrt{t^2+1}} \cdot \frac{1}{t^2+1} = \frac{1}{t(t^2+1)^{3/2}}$$

$$14. \mathbf{r} = (\cos^3 t)\mathbf{i} + (\sin^3 t)\mathbf{j}, 0 < t < \frac{\pi}{2} \Rightarrow \mathbf{v} = (-3 \cos^2 t \sin t)\mathbf{i} + (3 \sin^2 t \cos t)\mathbf{j}$$

$$\Rightarrow |\mathbf{v}| = \sqrt{(-3 \cos^2 t \sin t)^2 + (3 \sin^2 t \cos t)^2} = \sqrt{9 \cos^4 t \sin^2 t + 9 \sin^4 t \cos^2 t} = 3 \cos t \sin t, \text{ since } 0 < t < \frac{\pi}{2}$$

$$\Rightarrow \mathbf{T} = \frac{\mathbf{v}}{|\mathbf{v}|} = (-\cos t)\mathbf{i} + (\sin t)\mathbf{j} \Rightarrow \frac{d\mathbf{T}}{dt} = (\sin t)\mathbf{i} + (\cos t)\mathbf{j} \Rightarrow \left| \frac{d\mathbf{T}}{dt} \right| = \sqrt{\sin^2 t + \cos^2 t} = 1 \Rightarrow \mathbf{N} = \frac{\left(\frac{d\mathbf{T}}{dt} \right)}{\left| \frac{d\mathbf{T}}{dt} \right|}$$

$$= (\sin t)\mathbf{i} + (\cos t)\mathbf{j}; \kappa = \frac{1}{|\mathbf{v}|} \cdot \left| \frac{d\mathbf{T}}{dt} \right| = \frac{1}{3 \cos t \sin t} \cdot 1 = \frac{1}{3 \cos t \sin t}$$

$$15. \mathbf{r} = t\mathbf{i} + (a \cosh \frac{t}{a})\mathbf{j}, a > 0 \Rightarrow \mathbf{v} = \mathbf{i} + (\sinh \frac{t}{a})\mathbf{j} \Rightarrow |\mathbf{v}| = \sqrt{1 + \sinh^2 \left(\frac{t}{a} \right)} = \sqrt{\cosh^2 \left(\frac{t}{a} \right)} = \cosh \frac{t}{a}$$

$$\Rightarrow \mathbf{T} = \frac{\mathbf{v}}{|\mathbf{v}|} = \left(\operatorname{sech} \frac{t}{a} \right)\mathbf{i} + \left(\tanh \frac{t}{a} \right)\mathbf{j} \Rightarrow \frac{d\mathbf{T}}{dt} = \left(-\frac{1}{a} \operatorname{sech} \frac{t}{a} \tanh \frac{t}{a} \right)\mathbf{i} + \left(\frac{1}{a} \operatorname{sech}^2 \frac{t}{a} \right)\mathbf{j}$$

$$\Rightarrow \left| \frac{d\mathbf{T}}{dt} \right| = \sqrt{\frac{1}{a^2} \operatorname{sech}^2 \left(\frac{t}{a} \right) \tanh^2 \left(\frac{t}{a} \right) + \frac{1}{a^2} \operatorname{sech}^4 \left(\frac{t}{a} \right)} = \frac{1}{a} \operatorname{sech} \left(\frac{t}{a} \right) \Rightarrow \mathbf{N} = \frac{\left(\frac{d\mathbf{T}}{dt} \right)}{\left| \frac{d\mathbf{T}}{dt} \right|} = \left(-\tanh \frac{t}{a} \right)\mathbf{i} + \left(\operatorname{sech} \frac{t}{a} \right)\mathbf{j};$$

$$\kappa = \frac{1}{|\mathbf{v}|} \cdot \left| \frac{d\mathbf{T}}{dt} \right| = \frac{1}{\cosh \frac{t}{a}} \cdot \frac{1}{a} \operatorname{sech} \left(\frac{t}{a} \right) = \frac{1}{a} \operatorname{sech}^2 \left(\frac{t}{a} \right)$$

$$16. \mathbf{r} = (\cosh t)\mathbf{i} - (\sinh t)\mathbf{j} + t\mathbf{k} \Rightarrow \mathbf{v} = (\sinh t)\mathbf{i} - (\cosh t)\mathbf{j} + \mathbf{k} \Rightarrow |\mathbf{v}| = \sqrt{\sinh^2 t + (-\cosh t)^2 + 1} = \sqrt{2} \cosh t$$

$$\Rightarrow \mathbf{T} = \frac{\mathbf{v}}{|\mathbf{v}|} = \left(\frac{1}{\sqrt{2}} \tanh t \right)\mathbf{i} - \frac{1}{\sqrt{2}}\mathbf{j} + \left(\frac{1}{\sqrt{2}} \operatorname{sech} t \right)\mathbf{k} \Rightarrow \frac{d\mathbf{T}}{dt} = \left(\frac{1}{\sqrt{2}} \operatorname{sech}^2 t \right)\mathbf{i} - \left(\frac{1}{\sqrt{2}} \operatorname{sech} t \tanh t \right)\mathbf{k}$$

$$\Rightarrow \left| \frac{d\mathbf{T}}{dt} \right| = \sqrt{\frac{1}{2} \operatorname{sech}^4 t + \frac{1}{2} \operatorname{sech}^2 t \tanh^2 t} = \frac{1}{\sqrt{2}} \operatorname{sech} t \Rightarrow \mathbf{N} = \frac{\left(\frac{d\mathbf{T}}{dt} \right)}{\left| \frac{d\mathbf{T}}{dt} \right|} = (\operatorname{sech} t)\mathbf{i} - (\tanh t)\mathbf{k};$$

$$\kappa = \frac{1}{|\mathbf{v}|} \cdot \left| \frac{d\mathbf{T}}{dt} \right| = \frac{1}{\sqrt{2} \cosh t} \cdot \frac{1}{\sqrt{2}} \operatorname{sech} t = \frac{1}{2} \operatorname{sech}^2 t$$

$$17. y = ax^2 \Rightarrow y' = 2ax \Rightarrow y'' = 2a; \text{ from Exercise 5(a), } \kappa(x) = \frac{|2a|}{(1+4a^2x^2)^{3/2}} = |2a| (1+4a^2x^2)^{-3/2}$$

$\Rightarrow \kappa'(x) = -\frac{3}{2} |2a| (1+4a^2x^2)^{-5/2} (8a^2x)$; thus, $\kappa'(x) = 0 \Rightarrow x = 0$. Now, $\kappa'(x) > 0$ for $x < 0$ and $\kappa'(x) < 0$ for $x > 0$ so that $\kappa(x)$ has an absolute maximum at $x = 0$ which is the vertex of the parabola. Since $x = 0$ is the only critical point for $\kappa(x)$, the curvature has no minimum value.

$$18. \mathbf{r} = (a \cos t)\mathbf{i} + (b \sin t)\mathbf{j} \Rightarrow \mathbf{v} = (-a \sin t)\mathbf{i} + (b \cos t)\mathbf{j} \Rightarrow \mathbf{a} = (-a \cos t)\mathbf{i} - (b \sin t)\mathbf{j} \Rightarrow \mathbf{v} \times \mathbf{a}$$

$$= \begin{vmatrix} \mathbf{i} & \mathbf{j} & \mathbf{k} \\ -a \sin t & b \cos t & 0 \\ -a \cos t & -b \sin t & 0 \end{vmatrix} = ab\mathbf{k} \Rightarrow |\mathbf{v} \times \mathbf{a}| = |ab| = ab, \text{ since } a > b > 0; \kappa(t) = \frac{|\mathbf{v} \times \mathbf{a}|}{|\mathbf{v}|^3}$$

$$= ab(a^2 \sin^2 t + b^2 \cos^2 t)^{-3/2}; \kappa'(t) = -\frac{3}{2}(ab)(a^2 \sin^2 t + b^2 \cos^2 t)^{-5/2}(2a^2 \sin t \cos t - 2b^2 \sin t \cos t)$$

$$= -\frac{3}{2}(ab)(a^2 - b^2)(\sin 2t)(a^2 \sin^2 t + b^2 \cos^2 t)^{-5/2}; \text{ thus, } \kappa'(t) = 0 \Rightarrow \sin 2t = 0 \Rightarrow t = 0, \pi \text{ identifying}$$

points on the major axis, or $t = \frac{\pi}{2}, \frac{3\pi}{2}$ identifying points on the minor axis. Furthermore, $\kappa'(t) < 0$ for

$0 < t < \frac{\pi}{2}$ and for $\pi < t < \frac{3\pi}{2}$; $\kappa'(t) > 0$ for $\frac{\pi}{2} < t < \pi$ and $\frac{3\pi}{2} < t < 2\pi$. Therefore, the points associated

with $t = 0$ and $t = \pi$ on the major axis give absolute maximum curvature and the points associated with $t = \frac{\pi}{2}$

and $t = \frac{3\pi}{2}$ on the minor axis give absolute minimum curvature.

$$19. \kappa = \frac{a}{a^2 + b^2} \Rightarrow \frac{d\kappa}{da} = \frac{-a^2 + b^2}{(a^2 + b^2)^2}; \frac{d\kappa}{da} = 0 \Rightarrow -a^2 + b^2 = 0 \Rightarrow a = \pm b \Rightarrow a = b \text{ since } a, b \geq 0. \text{ Now, } \frac{d\kappa}{da} > 0 \text{ if } a < b \text{ and } \frac{d\kappa}{da} < 0 \text{ if } a > b \Rightarrow \kappa \text{ is at a maximum for } a = b \text{ and } \kappa(b) = \frac{b}{b^2 + b^2} = \frac{1}{2b} \text{ is the maximum value of } \kappa.$$

$$20. (a) \text{ From Example 5, the curvature of the helix } \mathbf{r}(t) = (a \cos t)\mathbf{i} + (a \sin t)\mathbf{j} + b\mathbf{k}, a, b \geq 0 \text{ is } \kappa = \frac{a}{a^2 + b^2}; \text{ also}$$

$$|\mathbf{v}| = \sqrt{a^2 + b^2}. \text{ For the helix } \mathbf{r}(t) = (3 \cos t)\mathbf{i} + (3 \sin t)\mathbf{j} + t\mathbf{k}, 0 \leq t \leq 4\pi, a = 3 \text{ and } b = 1 \Rightarrow \kappa = \frac{3}{3^2 + 1^2} = \frac{3}{10}$$

$$\text{and } |\mathbf{v}| = \sqrt{10} \Rightarrow K = \int_0^{4\pi} \frac{3}{10} \sqrt{10} dt = \left[\frac{3}{\sqrt{10}} t \right]_0^{4\pi} = \frac{12\pi}{\sqrt{10}}$$

$$(b) y = x^2 \Rightarrow x = t \text{ and } y = t^2, -\infty < t < \infty \Rightarrow \mathbf{r}(t) = t\mathbf{i} + t^2\mathbf{j} \Rightarrow \mathbf{v} = \mathbf{i} + 2t\mathbf{j} \Rightarrow |\mathbf{v}| = \sqrt{1 + 4t^2};$$

$$\mathbf{T} = \frac{1}{\sqrt{1 + 4t^2}}\mathbf{i} + \frac{2t}{\sqrt{1 + 4t^2}}\mathbf{j}; \frac{d\mathbf{T}}{dt} = \frac{-4t}{(1 + 4t^2)^{3/2}}\mathbf{i} + \frac{2}{(1 + 4t^2)^{3/2}}\mathbf{j}; \left| \frac{d\mathbf{T}}{dt} \right| = \sqrt{\frac{16t^2 + 4}{(1 + 4t^2)^3}} = \frac{2}{1 + 4t^2}. \text{ Thus}$$

$$\kappa = \frac{1}{\sqrt{1 + 4t^2}} \cdot \frac{2}{1 + 4t^2} = \frac{2}{(\sqrt{1 + 4t^2})^3}. \text{ Then } K = \int_{-\infty}^{\infty} \frac{2}{(\sqrt{1 + 4t^2})^3} (\sqrt{1 + 4t^2}) dt = \int_{-\infty}^{\infty} \frac{2}{1 + 4t^2} dt$$

$$= a \lim_{a \rightarrow -\infty} \int_a^0 \frac{2}{1 + 4t^2} dt + b \lim_{b \rightarrow \infty} \int_0^b \frac{2}{1 + 4t^2} dt = a \lim_{a \rightarrow -\infty} [\tan^{-1} 2t]_a^0 + b \lim_{b \rightarrow \infty} [\tan^{-1} 2t]_0^b$$

$$= a \lim_{a \rightarrow -\infty} (-\tan^{-1} 2a) + b \lim_{b \rightarrow \infty} (\tan^{-1} 2b) = \frac{\pi}{2} + \frac{\pi}{2} = \pi$$

$$21. \mathbf{r} = t\mathbf{i} + (\sin t)\mathbf{j} \Rightarrow \mathbf{v} = \mathbf{i} + (\cos t)\mathbf{j} \Rightarrow |\mathbf{v}| = \sqrt{1^2 + (\cos t)^2} = \sqrt{1 + \cos^2 t} \Rightarrow |\mathbf{v}(\frac{\pi}{2})| = \sqrt{1 + \cos^2(\frac{\pi}{2})} = 1; \mathbf{T} = \frac{\mathbf{v}}{|\mathbf{v}|}$$

$$= \frac{\mathbf{i} + \cos t \mathbf{j}}{\sqrt{1 + \cos^2 t}} \Rightarrow \frac{d\mathbf{T}}{dt} = \frac{\sin t \cos t}{(1 + \cos^2 t)^{3/2}}\mathbf{i} + \frac{-\sin t}{(1 + \cos^2 t)^{3/2}}\mathbf{j} \Rightarrow \left| \frac{d\mathbf{T}}{dt} \right| = \frac{|\sin t|}{1 + \cos^2 t}; \left| \frac{d\mathbf{T}}{dt} \right|_{t=\frac{\pi}{2}} = \frac{|\sin \frac{\pi}{2}|}{1 + \cos^2(\frac{\pi}{2})} = \frac{1}{1} = 1. \text{ Thus } \kappa(\frac{\pi}{2}) = \frac{1}{1} \cdot 1 = 1$$

$$\Rightarrow \rho = \frac{1}{1} = 1 \text{ and the center is } (\frac{\pi}{2}, 0) \Rightarrow (x - \frac{\pi}{2})^2 + y^2 = 1$$

$$22. \mathbf{r} = (2 \ln t)\mathbf{i} - (t + \frac{1}{t})\mathbf{j} \Rightarrow \mathbf{v} = (\frac{2}{t})\mathbf{i} - (1 - \frac{1}{t^2})\mathbf{j} \Rightarrow |\mathbf{v}| = \sqrt{\frac{4}{t^2} + (1 - \frac{1}{t^2})^2} = \frac{t^2 + 1}{t^2} \Rightarrow \mathbf{T} = \frac{\mathbf{v}}{|\mathbf{v}|} = \frac{2t}{t^2 + 1}\mathbf{i} - \frac{t^2 - 1}{t^2 + 1}\mathbf{j};$$

$$\frac{d\mathbf{T}}{dt} = \frac{-2(t^2 - 1)}{(t^2 + 1)^2}\mathbf{i} - \frac{4t}{(t^2 + 1)^2}\mathbf{j} \Rightarrow \left| \frac{d\mathbf{T}}{dt} \right| = \sqrt{\frac{4(t^2 - 1)^2 + 16t^2}{(t^2 + 1)^4}} = \frac{2}{t^2 + 1}. \text{ Thus } \kappa = \frac{1}{|\mathbf{v}|} \cdot \left| \frac{d\mathbf{T}}{dt} \right| = \frac{t^2}{t^2 + 1} \cdot \frac{2}{t^2 + 1} = \frac{2t^2}{(t^2 + 1)^2} \Rightarrow \kappa(1) = \frac{2}{2^2}$$

$$= \frac{1}{2} \Rightarrow \rho = \frac{1}{\kappa} = 2. \text{ The circle of curvature is tangent to the curve at } P(0, -2) \Rightarrow \text{circle has same tangent as the curve}$$

$\Rightarrow \mathbf{v}(1) = 2\mathbf{i}$ is tangent to the circle \Rightarrow the center lies on the y-axis. If $t \neq 1$ ($t > 0$), then $(t - 1)^2 > 0$

$$\Rightarrow t^2 - 2t + 1 > 0 \Rightarrow t^2 + 1 > 2t \Rightarrow \frac{t^2 + 1}{t} > 2 \text{ since } t > 0 \Rightarrow t + \frac{1}{t} > 2 \Rightarrow -(t + \frac{1}{t}) < -2 \Rightarrow y < -2 \text{ on both}$$

sides of $(0, -2) \Rightarrow$ the curve is concave down \Rightarrow center of circle of curvature is $(0, -4) \Rightarrow x^2 + (y + 4)^2 = 4$

is an equation of the circle of curvature

23. $y = x^2 \Rightarrow f'(x) = 2x$ and $f''(x) = 2$

$$\Rightarrow \kappa = \frac{|2|}{(1+(2x)^2)^{3/2}} = \frac{2}{(1+4x^2)^{3/2}}$$

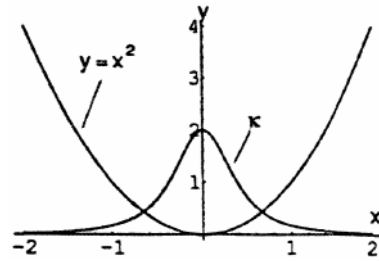

24. $y = \frac{x^4}{4} \Rightarrow f'(x) = x^3$ and $f''(x) = 3x^2$

$$\Rightarrow \kappa = \frac{|3x^2|}{(1+(x^3)^2)^{3/2}} = \frac{3x^2}{(1+x^6)^{3/2}}$$

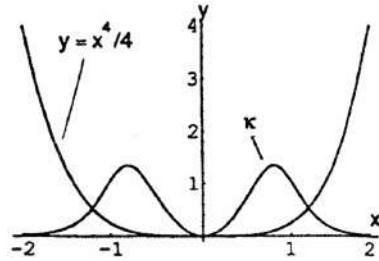

25. $y = \sin x \Rightarrow f'(x) = \cos x$ and $f''(x) = -\sin x$

$$\Rightarrow \kappa = \frac{|-\sin x|}{(1+\cos^2 x)^{3/2}} = \frac{|\sin x|}{(1+\cos^2 x)^{3/2}}$$

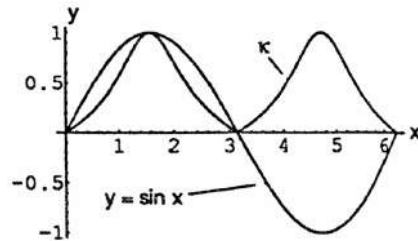

26. $y = e^x \Rightarrow f'(x) = e^x$ and $f''(x) = e^x$

$$\Rightarrow \kappa = \frac{|e^x|}{(1+(e^x)^2)^{3/2}} = \frac{e^x}{(1+e^{2x})^{3/2}}$$

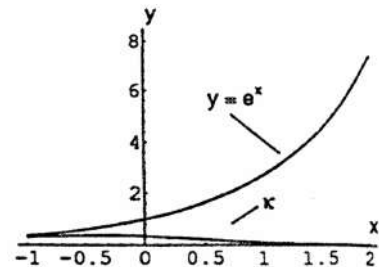

27-34. Example CAS commands:

Maple:

```
with( plots );
r := t -> [3*cos(t),5*sin(t)];
lo := 0;
hi := 2*Pi;
t0 := Pi/4;
P1 := plot( [r(t)[], t=lo..hi] );
display( P1, scaling=constrained, title="#27(a) (Section 13.4)" );
CURVATURE := (x,y,t) -> simplify(abs(diff(x,t)*diff(y,t)-diff(y,t)*diff(x,t))/(diff(x,t)^2+diff(y,t)^2)^(3/2));
kappa := eval(CURVATURE(r(t)[],t),t=t0);
UnitNormal := (x,y,t) -> expand( [-diff(y,t),diff(x,t)]/sqrt(diff(x,t)^2+diff(y,t)^2) );
N := eval( UnitNormal(r(t)[],t), t=t0 );
C := expand( r(t0) + N/kappa );
OscCircle := (x-C[1])^2+(y-C[2])^2 = 1/kappa^2;
evalf( OscCircle );
P2 := implicitplot( (x-C[1])^2+(y-C[2])^2 = 1/kappa^2, x=-7..4, y=-4..6, color=blue );
```

display([P1,P2], scaling=constrained, title="#27(e) (Section 13.4)");

Mathematica: (assigned functions and parameters may vary)

In Mathematica, the dot product can be applied either with a period "." or with the word, "Dot".

Similarly, the cross product can be applied either with a very small "x" (in the palette next to the arrow) or with the word, "Cross". However, the Cross command assumes the vectors are in three dimensions

For the purposes of applying the cross product command, we will define the position vector \mathbf{r} as a three dimensional vector with zero for its z-component. For graphing, we will use only the first two components.

```
Clear[r, t, x, y]
r[t_]= {3 Cos[t], 5 Sin[t] }
t0= π /4; tmin= 0; tmax= 2π;
r2[t_]= {r[t][[1]], r[t][[2]]}
pp=ParametricPlot[r2[t], {t, tmin, tmax}];
mag[v_]=Sqrt[v.v]
vel[t_]= r'[t]
speed[t_]=mag[vel[t]]
acc[t_]= vel'[t]
curv[t_]= mag[Cross[vel[t],acc[t]]]/speed[t]^3//Simplify
unittan[t_]= vel[t]/speed[t]//Simplify
unitnorm[t_]= unittan'[t] / mag[unittan'[t]]
ctr= r[t0] + (1 / curv[t0]) unitnorm[t0] //Simplify
{a,b}= {ctr[[1]], ctr[[2]]}
```

To plot the osculating circle, load a graphics package and then plot it, and show it together with the original curve.

```
<<Graphics`ImplicitPlot`
pc=ImplicitPlot[(x - a)^2 + (y - b)^2 == 1/curv[t0]^2, {x, -8, 8},{y, -8, 8}]
radius=Graphics[Line[{a, b}, r2[t0]}]
Show[pp, pc, radius, AspectRatio -> 1]
```

13.5 TORSION AND THE UNIT BINORMAL VECTOR **B**

1. By Exercise 9 in Section 13.4, $\mathbf{T} = \left(\frac{3}{5} \cos t\right) \mathbf{i} + \left(-\frac{3}{5} \sin t\right) \mathbf{j} + \frac{4}{5} \mathbf{k}$ and $\mathbf{N} = (-\sin t) \mathbf{i} - (\cos t) \mathbf{j}$ so that $\mathbf{B} = \mathbf{T} \times \mathbf{N}$

$$= \begin{vmatrix} \mathbf{i} & \mathbf{j} & \mathbf{k} \\ \frac{3}{5} \cos t & -\frac{3}{5} \sin t & \frac{4}{5} \\ -\sin t & -\cos t & 0 \end{vmatrix} = \left(\frac{4}{5} \cos t\right) \mathbf{i} - \left(\frac{4}{5} \sin t\right) \mathbf{j} - \frac{3}{5} \mathbf{k}. \text{ Also } \mathbf{v} = (3 \cos t) \mathbf{i} + (-3 \sin t) \mathbf{j} + 4 \mathbf{k}$$

$$\Rightarrow \mathbf{a} = (-3 \sin t) \mathbf{i} + (-3 \cos t) \mathbf{j} \Rightarrow \frac{d\mathbf{a}}{dt} = (-3 \cos t) \mathbf{i} + (3 \sin t) \mathbf{j} \text{ and } \mathbf{v} \times \mathbf{a} = \begin{vmatrix} \mathbf{i} & \mathbf{j} & \mathbf{k} \\ 3 \cos t & -3 \sin t & 4 \\ -3 \sin t & -3 \cos t & 0 \end{vmatrix}$$

$$= (12 \cos t) \mathbf{i} - (12 \sin t) \mathbf{j} - 9 \mathbf{k} \Rightarrow |\mathbf{v} \times \mathbf{a}|^2 = (12 \cos t)^2 + (-12 \sin t)^2 + (-9)^2 = 225. \text{ Thus}$$

$$\tau = \frac{\begin{vmatrix} 3 \cos t & -3 \sin t & 4 \\ -3 \sin t & -3 \cos t & 0 \\ -3 \cos t & 3 \sin t & 0 \end{vmatrix}}{225} = \frac{4(-9 \sin^2 t - 9 \cos^2 t)}{225} = \frac{-36}{225} = -\frac{4}{25}$$

2. By Exercise 10 in Section 13.4, $\mathbf{T} = (\cos t) \mathbf{i} + (\sin t) \mathbf{j}$ and $\mathbf{N} = (-\sin t) \mathbf{i} + (\cos t) \mathbf{j}$; thus $\mathbf{B} = \mathbf{T} \times \mathbf{N}$

$$= \begin{vmatrix} \mathbf{i} & \mathbf{j} & \mathbf{k} \\ \cos t & \sin t & 0 \\ -\sin t & \cos t & 0 \end{vmatrix} = (\cos^2 t + \sin^2 t) \mathbf{k} = \mathbf{k}. \text{ Also } \mathbf{v} = (t \cos t) \mathbf{i} + (t \sin t) \mathbf{j}$$

$$\Rightarrow \mathbf{a} = (t(-\sin t) + \cos t) \mathbf{i} + (t \cos t + \sin t) \mathbf{j} \Rightarrow \frac{d\mathbf{a}}{dt} = (-t \cos t - \sin t - \sin t) \mathbf{i} + (-t \sin t + \cos t + \cos t) \mathbf{j}$$

$$= (-t \cos t - 2 \sin t) \mathbf{i} + (2 \cos t - t \sin t) \mathbf{j}. \text{ Thus } \mathbf{v} \times \mathbf{a} = \begin{vmatrix} \mathbf{i} & \mathbf{j} & \mathbf{k} \\ t \cos t & t \sin t & 0 \\ (-t \sin t + \cos t) & (t \cos t + \sin t) & 0 \end{vmatrix}$$

$$= [(t \cos t)(t \cos t + \sin t) - (t \sin t)(-t \sin t + \cos t)] \mathbf{k} = t^2 \mathbf{k} \Rightarrow |\mathbf{v} \times \mathbf{a}|^2 = (t^2)^2 = t^4. \text{ Thus}$$

$$\tau = \frac{\begin{vmatrix} t \cos t & t \sin t & 0 \\ \cos t - t \sin t & \sin t + t \cos t & 0 \\ -2 \sin t - t \cos t & 2 \cos t - t \sin t & 0 \end{vmatrix}}{t^4} = \frac{0}{t^4} = 0$$

3. By Exercise 11 in Section 13.4, $\mathbf{T} = \left(\frac{\cos t - \sin t}{\sqrt{2}}\right) \mathbf{i} + \left(\frac{\sin t + \cos t}{\sqrt{2}}\right) \mathbf{j}$ and $\mathbf{N} = \left(\frac{-\cos t - \sin t}{\sqrt{2}}\right) \mathbf{i} + \left(\frac{-\sin t + \cos t}{\sqrt{2}}\right) \mathbf{j}$; Thus

$$\begin{aligned} \mathbf{B} = \mathbf{T} \times \mathbf{N} &= \begin{vmatrix} \mathbf{i} & \mathbf{j} & \mathbf{k} \\ \frac{\cos t - \sin t}{\sqrt{2}} & \frac{\sin t + \cos t}{\sqrt{2}} & 0 \\ \frac{-\cos t - \sin t}{\sqrt{2}} & \frac{-\sin t + \cos t}{\sqrt{2}} & 0 \end{vmatrix} = \left[\left(\frac{\cos^2 t - 2 \cos t \sin t + \sin^2 t}{2} \right) + \left(\frac{\sin^2 t + 2 \sin t \cos t + \cos^2 t}{2} \right) \right] \mathbf{k} \\ &= \left[\left(\frac{1 - \sin(2t)}{2} \right) + \left(\frac{1 + \sin(2t)}{2} \right) \right] \mathbf{k} = \mathbf{k}. \text{ Also, } \mathbf{v} = (e^t \cos t - e^t \sin t) \mathbf{i} + (e^t \sin t + e^t \cos t) \mathbf{j} \\ \Rightarrow \mathbf{a} &= [e^t(-\sin t - \cos t) + e^t(\cos t - \sin t)] \mathbf{i} + [e^t(\cos t - \sin t) + e^t(\sin t + \cos t)] \mathbf{j} = (-2e^t \sin t) \mathbf{i} + (2e^t \cos t) \mathbf{j} \\ \Rightarrow \frac{d\mathbf{a}}{dt} &= -2e^t(\cos t + \sin t) \mathbf{i} + 2e^t(-\sin t + \cos t) \mathbf{j}. \text{ Thus } \mathbf{v} \times \mathbf{a} = \begin{vmatrix} \mathbf{i} & \mathbf{j} & \mathbf{k} \\ e^t(\cos t - \sin t) & e^t(\sin t + \cos t) & 0 \\ -2e^t \sin t & 2e^t \cos t & 0 \end{vmatrix} = 2e^{2t} \mathbf{k} \\ \Rightarrow |\mathbf{v} \times \mathbf{a}|^2 &= (2e^{2t})^2 = 4e^{4t}. \text{ Thus } \tau = \frac{\begin{vmatrix} e^t(\cos t - \sin t) & e^t(\sin t + \cos t) & 0 \\ -2e^t \sin t & 2e^t \cos t & 0 \\ -2e^t(\cos t + \sin t) & 2e^t(-\sin t + \cos t) & 0 \end{vmatrix}}{4e^{4t}} = 0 \end{aligned}$$

4. By Exercise 12 in Section 13.4, $\mathbf{T} = \left(\frac{12}{13} \cos 2t\right) \mathbf{i} - \left(\frac{12}{13} \sin 2t\right) \mathbf{j} + \frac{5}{13} \mathbf{k}$ and $\mathbf{N} = (-\sin 2t) \mathbf{i} - (\cos 2t) \mathbf{j}$ so

$$\begin{aligned} \mathbf{B} = \mathbf{T} \times \mathbf{N} &= \begin{vmatrix} \mathbf{i} & \mathbf{j} & \mathbf{k} \\ \frac{12}{13} \cos 2t & -\frac{12}{13} \sin 2t & \frac{5}{13} \\ -\sin 2t & -\cos 2t & 0 \end{vmatrix} = \left(\frac{5}{13} \cos 2t\right) \mathbf{i} - \left(\frac{5}{13} \sin 2t\right) \mathbf{j} - \frac{12}{13} \mathbf{k}. \text{ Also,} \\ \mathbf{v} &= (12 \cos 2t) \mathbf{i} - (12 \sin 2t) \mathbf{j} + 5 \mathbf{k} \Rightarrow \mathbf{a} = (-24 \sin 2t) \mathbf{i} - (24 \cos 2t) \mathbf{j} \text{ and } \frac{d\mathbf{a}}{dt} = (-48 \cos 2t) \mathbf{i} + (48 \sin 2t) \mathbf{j} \\ \mathbf{v} \times \mathbf{a} &= \begin{vmatrix} \mathbf{i} & \mathbf{j} & \mathbf{k} \\ 12 \cos 2t & -12 \sin 2t & 5 \\ -24 \sin 2t & -24 \cos 2t & 0 \end{vmatrix} = (120 \cos 2t) \mathbf{i} - (120 \sin 2t) \mathbf{j} - 288 \mathbf{k} \Rightarrow |\mathbf{v} \times \mathbf{a}|^2 \\ &= (120 \cos 2t)^2 + (-120 \sin 2t)^2 + (-288)^2 = 120^2(\cos^2 2t + \sin^2 2t) + 288^2 = 97344. \text{ Thus} \\ \tau &= \frac{\begin{vmatrix} 12 \cos 2t & -12 \sin 2t & 5 \\ -24 \sin 2t & -24 \cos 2t & 0 \\ -48 \cos 2t & 48 \sin 2t & 0 \end{vmatrix}}{97344} = \frac{5(-24 \cdot 48)}{97344} = -\frac{10}{169} \end{aligned}$$

5. By Exercise 13 in Section 13.4, $\mathbf{T} = \frac{t}{(t^2+1)^{3/2}} \mathbf{i} + \frac{1}{(t^2+1)^{3/2}} \mathbf{j}$ and $\mathbf{N} = \frac{1}{\sqrt{t^2+1}} \mathbf{i} - \frac{t}{\sqrt{t^2+1}} \mathbf{j}$ so that $\mathbf{B} = \mathbf{T} \times \mathbf{N}$

$$= \begin{vmatrix} \mathbf{i} & \mathbf{j} & \mathbf{k} \\ \frac{t}{\sqrt{t^2+1}} & \frac{1}{\sqrt{t^2+1}} & 0 \\ \frac{1}{\sqrt{t^2+1}} & -\frac{t}{\sqrt{t^2+1}} & 0 \end{vmatrix} = -\mathbf{k}. \text{ Also, } \mathbf{v} = t^2 \mathbf{i} + t \mathbf{j} \Rightarrow \mathbf{a} = 2t \mathbf{i} + \mathbf{j} \Rightarrow \frac{d\mathbf{a}}{dt} = 2 \mathbf{i} \text{ so that } \begin{vmatrix} t^2 & t & 0 \\ 2t & 1 & 0 \\ 2 & 0 & 0 \end{vmatrix} = 0 \Rightarrow \tau = 0$$

6. By Exercise 14 in Section 13.4, $\mathbf{T} = (-\cos t) \mathbf{i} + (\sin t) \mathbf{j}$ and $\mathbf{N} = (\sin t) \mathbf{i} + (\cos t) \mathbf{j}$ so that $\mathbf{B} = \mathbf{T} \times \mathbf{N}$

$$\begin{aligned} &= \begin{vmatrix} \mathbf{i} & \mathbf{j} & \mathbf{k} \\ -\cos t & \sin t & 0 \\ \sin t & \cos t & 0 \end{vmatrix} = -\mathbf{k}. \text{ Also, } \mathbf{v} = (-3 \cos^2 t \sin t) \mathbf{i} + (3 \sin^2 t \cos t) \mathbf{j} \\ \Rightarrow \mathbf{a} &= \frac{d}{dt}(-3 \cos^2 t \sin t) \mathbf{i} + \frac{d}{dt}(3 \sin^2 t \cos t) \mathbf{j} \Rightarrow \frac{d\mathbf{a}}{dt} = \frac{d}{dt} \left(\frac{d}{dt}(-3 \cos^2 t \sin t) \right) \mathbf{i} + \frac{d}{dt} \left(\frac{d}{dt}(3 \sin^2 t \cos t) \right) \mathbf{j} \\ \Rightarrow &\begin{vmatrix} -3 \cos^2 t \sin t & 3 \sin^2 t \cos t & 0 \\ \frac{d}{dt}(-3 \cos^2 t \sin t) & \frac{d}{dt}(3 \sin^2 t \cos t) & 0 \\ \frac{d}{dt} \left(\frac{d}{dt}(-3 \cos^2 t \sin t) \right) & \frac{d}{dt} \left(\frac{d}{dt}(3 \sin^2 t \cos t) \right) & 0 \end{vmatrix} = 0 \Rightarrow \tau = 0 \end{aligned}$$

7. By Exercise 15 in Section 13.4, $\mathbf{T} = \frac{v}{|v|} = \left(\operatorname{sech} \frac{t}{a}\right) \mathbf{i} + \left(\tanh \frac{t}{a}\right) \mathbf{j}$ and $\mathbf{N} = \left(-\tanh \frac{t}{a}\right) \mathbf{i} + \left(\operatorname{sech} \frac{t}{a}\right) \mathbf{j}$ so that $\mathbf{B} = \mathbf{T} \times \mathbf{N}$

$$= \begin{vmatrix} \mathbf{i} & \mathbf{j} & \mathbf{k} \\ \operatorname{sech} \left(\frac{t}{a}\right) & \tanh \left(\frac{t}{a}\right) & 0 \\ -\tanh \left(\frac{t}{a}\right) & \operatorname{sech} \left(\frac{t}{a}\right) & 0 \end{vmatrix} = \mathbf{k}. \text{ Also, } \mathbf{v} = \mathbf{i} + \left(\sinh \frac{t}{a}\right) \mathbf{j} \Rightarrow \mathbf{a} = \left(\frac{1}{a} \cosh \frac{t}{a}\right) \mathbf{j} \Rightarrow \frac{d\mathbf{a}}{dt} = \frac{1}{a^2} \sinh \left(\frac{t}{a}\right) \mathbf{j} \text{ so that}$$

$$\begin{vmatrix} 1 & \sinh\left(\frac{1}{a}\right) & 0 \\ 0 & \frac{1}{a} \cosh\left(\frac{1}{a}\right) & 0 \\ 0 & \frac{1}{a^2} \sinh\left(\frac{1}{a}\right) & 0 \end{vmatrix} = 0 \Rightarrow \tau = 0$$

8. By Exercise 16 in Section 13.4, $\mathbf{T} = \left(\frac{1}{\sqrt{2}} \tanh t\right) \mathbf{i} - \frac{1}{\sqrt{2}} \mathbf{j} + \left(\frac{1}{\sqrt{2}} \operatorname{sech} t\right) \mathbf{k}$ and $\mathbf{N} = (\operatorname{sech} t) \mathbf{i} - (\tanh t) \mathbf{k}$ so that

$$\mathbf{B} = \mathbf{T} \times \mathbf{N} = \begin{vmatrix} \mathbf{i} & \mathbf{j} & \mathbf{k} \\ \frac{1}{\sqrt{2}} \tanh t & -\frac{1}{\sqrt{2}} & \frac{1}{\sqrt{2}} \operatorname{sech} t \\ \operatorname{sech} t & 0 & -\tanh t \end{vmatrix} = \left(\frac{1}{\sqrt{2}} \tanh t\right) \mathbf{i} + \frac{1}{\sqrt{2}} \mathbf{j} + \left(\frac{1}{\sqrt{2}} \operatorname{sech} t\right) \mathbf{k}. \text{ Also, } \mathbf{v} = (\sinh t) \mathbf{i} - (\cosh t) \mathbf{j} + \mathbf{k}$$

$$\mathbf{a} = (\cosh t) \mathbf{i} - (\sinh t) \mathbf{j} \Rightarrow \frac{d\mathbf{a}}{dt} = (\sinh t) \mathbf{i} - (\cosh t) \mathbf{j} \text{ and } \mathbf{v} \times \mathbf{a} = \begin{vmatrix} \mathbf{i} & \mathbf{j} & \mathbf{k} \\ \sinh t & -\cosh t & 1 \\ \cosh t & -\sinh t & 0 \end{vmatrix}$$

$$= (\sinh t) \mathbf{i} + (\cosh t) \mathbf{j} + (\cosh^2 t - \sinh^2 t) \mathbf{k} = (\sinh t) \mathbf{i} + (\cosh t) \mathbf{j} + \mathbf{k} \Rightarrow |\mathbf{v} \times \mathbf{a}|^2 = \sinh^2 t + \cosh^2 t + 1. \text{ Thus}$$

$$\tau = \frac{\begin{vmatrix} \sinh t & -\cosh t & 1 \\ \cosh t & -\sinh t & 0 \\ \sinh t & -\cosh t & 0 \end{vmatrix}}{\sinh^2 t + \cosh^2 t + 1} = \frac{-1}{\sinh^2 t + \cosh^2 t + 1} = \frac{-1}{2 \cosh^2 t}.$$

9. $\mathbf{r} = (a \cos t) \mathbf{i} + (a \sin t) \mathbf{j} + b \mathbf{k} \Rightarrow \mathbf{v} = (-a \sin t) \mathbf{i} + (a \cos t) \mathbf{j} + b \mathbf{k} \Rightarrow |\mathbf{v}| = \sqrt{(-a \sin t)^2 + (a \cos t)^2 + b^2}$
 $= \sqrt{a^2 + b^2} \Rightarrow a_T = \frac{d}{dt} |\mathbf{v}| = 0; \mathbf{a} = (-a \cos t) \mathbf{i} + (-a \sin t) \mathbf{j} \Rightarrow |\mathbf{a}| = \sqrt{(-a \cos t)^2 + (-a \sin t)^2} = \sqrt{a^2} = |a|$
 $\Rightarrow a_N = \sqrt{|\mathbf{a}|^2 - a_T^2} = \sqrt{|\mathbf{a}|^2 - 0^2} = |\mathbf{a}| = |a| \Rightarrow \mathbf{a} = (0) \mathbf{T} + |a| \mathbf{N} = |a| \mathbf{N}$

10. $\mathbf{r} = (1 + 3t) \mathbf{i} + (t - 2) \mathbf{j} - 3t \mathbf{k} \Rightarrow \mathbf{v} = 3 \mathbf{i} + \mathbf{j} - 3 \mathbf{k} \Rightarrow |\mathbf{v}| = \sqrt{3^2 + 1^2 + (-3)^2} = \sqrt{19} \Rightarrow a_T = \frac{d}{dt} |\mathbf{v}| = 0; \mathbf{a} = \mathbf{0}$
 $\Rightarrow a_N = \sqrt{|\mathbf{a}|^2 - a_T^2} = 0 \Rightarrow \mathbf{a} = (0) \mathbf{T} + (0) \mathbf{N} = \mathbf{0}$

11. $\mathbf{r} = (t + 1) \mathbf{i} + 2t \mathbf{j} + t^2 \mathbf{k} \Rightarrow \mathbf{v} = \mathbf{i} + 2 \mathbf{j} + 2t \mathbf{k} \Rightarrow |\mathbf{v}| = \sqrt{1^2 + 2^2 + (2t)^2} = \sqrt{5 + 4t^2} \Rightarrow a_T = \frac{1}{2} (5 + 4t^2)^{-1/2} (8t)$
 $= 4t (5 + 4t^2)^{-1/2} \Rightarrow a_T(1) = \frac{4}{\sqrt{9}} = \frac{4}{3}; \mathbf{a} = 2 \mathbf{k} \Rightarrow \mathbf{a}(1) = 2 \mathbf{k} \Rightarrow |\mathbf{a}(1)| = 2 \Rightarrow a_N = \sqrt{|\mathbf{a}|^2 - a_T^2} = \sqrt{2^2 - \left(\frac{4}{3}\right)^2}$
 $= \sqrt{\frac{20}{9}} = \frac{2\sqrt{5}}{3} \Rightarrow \mathbf{a}(1) = \frac{4}{3} \mathbf{T} + \frac{2\sqrt{5}}{3} \mathbf{N}$

12. $\mathbf{r} = (t \cos t) \mathbf{i} + (t \sin t) \mathbf{j} + t^2 \mathbf{k} \Rightarrow \mathbf{v} = (\cos t - t \sin t) \mathbf{i} + (\sin t + t \cos t) \mathbf{j} + 2t \mathbf{k}$
 $\Rightarrow |\mathbf{v}| = \sqrt{(\cos t - t \sin t)^2 + (\sin t + t \cos t)^2 + (2t)^2} = \sqrt{5t^2 + 1} \Rightarrow a_T = \frac{1}{2} (5t^2 + 1)^{-1/2} (10t)$
 $= \frac{5t}{\sqrt{5t^2 + 1}} \Rightarrow a_T(0) = 0; \mathbf{a} = (-2 \sin t - t \cos t) \mathbf{i} + (2 \cos t - t \sin t) \mathbf{j} + 2 \mathbf{k} \Rightarrow \mathbf{a}(0) = 2 \mathbf{j} + 2 \mathbf{k} \Rightarrow |\mathbf{a}(0)|$
 $= \sqrt{2^2 + 2^2} = 2\sqrt{2} \Rightarrow a_N = \sqrt{|\mathbf{a}|^2 - a_T^2} = \sqrt{(2\sqrt{2})^2 - 0^2} = 2\sqrt{2} \Rightarrow \mathbf{a}(0) = (0) \mathbf{T} + 2\sqrt{2} \mathbf{N} = 2\sqrt{2} \mathbf{N}$

13. $\mathbf{r} = t^2 \mathbf{i} + (t + \frac{1}{3} t^3) \mathbf{j} + (t - \frac{1}{3} t^3) \mathbf{k} \Rightarrow \mathbf{v} = 2t \mathbf{i} + (1 + t^2) \mathbf{j} + (1 - t^2) \mathbf{k} \Rightarrow |\mathbf{v}| = \sqrt{(2t)^2 + (1 + t^2)^2 + (1 - t^2)^2}$
 $= \sqrt{2(t^4 + 2t^2 + 1)} = \sqrt{2} (1 + t^2) \Rightarrow a_T = 2t\sqrt{2} \Rightarrow a_T(0) = 0; \mathbf{a} = 2 \mathbf{i} + 2t \mathbf{j} - 2t \mathbf{k} \Rightarrow \mathbf{a}(0) = 2 \mathbf{i} \Rightarrow |\mathbf{a}(0)| = 2$
 $\Rightarrow a_N = \sqrt{|\mathbf{a}|^2 - a_T^2} = \sqrt{2^2 - 0^2} = 2 \Rightarrow \mathbf{a}(0) = (0) \mathbf{T} + 2 \mathbf{N} = 2 \mathbf{N}$

14. $\mathbf{r} = (e^t \cos t) \mathbf{i} + (e^t \sin t) \mathbf{j} + \sqrt{2} e^t \mathbf{k} \Rightarrow \mathbf{v} = (e^t \cos t - e^t \sin t) \mathbf{i} + (e^t \sin t + e^t \cos t) \mathbf{j} + \sqrt{2} e^t \mathbf{k}$
 $\Rightarrow |\mathbf{v}| = \sqrt{(e^t \cos t - e^t \sin t)^2 + (e^t \sin t + e^t \cos t)^2 + (\sqrt{2} e^t)^2} = \sqrt{4e^{2t}} = 2e^t \Rightarrow a_T = 2e^t \Rightarrow a_T(0) = 2;$
 $\mathbf{a} = (e^t \cos t - e^t \sin t - e^t \sin t - e^t \cos t) \mathbf{i} + (e^t \sin t + e^t \cos t + e^t \cos t - e^t \sin t) \mathbf{j} + \sqrt{2} e^t \mathbf{k}$
 $= (-2e^t \sin t) \mathbf{i} + (2e^t \cos t) \mathbf{j} + \sqrt{2} e^t \mathbf{k} \Rightarrow \mathbf{a}(0) = 2 \mathbf{j} + \sqrt{2} \mathbf{k} \Rightarrow |\mathbf{a}(0)| = \sqrt{2^2 + (\sqrt{2})^2} = \sqrt{6}$

$$\Rightarrow a_N = \sqrt{|\mathbf{a}|^2 - a_T^2} = \sqrt{(\sqrt{6})^2 - 2^2} = \sqrt{2} \Rightarrow \mathbf{a}(0) = 2\mathbf{T} + \sqrt{2}\mathbf{N}$$

15. $\mathbf{r} = (\cos t)\mathbf{i} + (\sin t)\mathbf{j} - \mathbf{k} \Rightarrow \mathbf{v} = (-\sin t)\mathbf{i} + (\cos t)\mathbf{j} \Rightarrow |\mathbf{v}| = \sqrt{(-\sin t)^2 + (\cos t)^2} = 1 \Rightarrow \mathbf{T} = \frac{\mathbf{v}}{|\mathbf{v}|}$
 $= (-\sin t)\mathbf{i} + (\cos t)\mathbf{j} \Rightarrow \mathbf{T}\left(\frac{\pi}{4}\right) = -\frac{\sqrt{2}}{2}\mathbf{i} + \frac{\sqrt{2}}{2}\mathbf{j}; \frac{d\mathbf{T}}{dt} = (-\cos t)\mathbf{i} - (\sin t)\mathbf{j} \Rightarrow \left|\frac{d\mathbf{T}}{dt}\right| = \sqrt{(-\cos t)^2 + (-\sin t)^2}$
 $= 1 \Rightarrow \mathbf{N} = \frac{\left(\frac{d\mathbf{T}}{dt}\right)}{\left|\frac{d\mathbf{T}}{dt}\right|} = (-\cos t)\mathbf{i} - (\sin t)\mathbf{j} \Rightarrow \mathbf{N}\left(\frac{\pi}{4}\right) = -\frac{\sqrt{2}}{2}\mathbf{i} - \frac{\sqrt{2}}{2}\mathbf{j}; \mathbf{B} = \mathbf{T} \times \mathbf{N} = \begin{vmatrix} \mathbf{i} & \mathbf{j} & \mathbf{k} \\ -\sin t & \cos t & 0 \\ -\cos t & -\sin t & 0 \end{vmatrix} = \mathbf{k}$
 $\Rightarrow \mathbf{B}\left(\frac{\pi}{4}\right) = \mathbf{k}$, the normal to the osculating plane; $\mathbf{r}\left(\frac{\pi}{4}\right) = \frac{\sqrt{2}}{2}\mathbf{i} + \frac{\sqrt{2}}{2}\mathbf{j} - \mathbf{k} \Rightarrow \mathbf{P} = \left(\frac{\sqrt{2}}{2}, \frac{\sqrt{2}}{2}, -1\right)$ lies on the
 osculating plane $\Rightarrow 0\left(x - \frac{\sqrt{2}}{2}\right) + 0\left(y - \frac{\sqrt{2}}{2}\right) + (z - (-1)) = 0 \Rightarrow z = -1$ is the osculating plane; \mathbf{T} is normal
 to the normal plane $\Rightarrow \left(-\frac{\sqrt{2}}{2}\right)\left(x - \frac{\sqrt{2}}{2}\right) + \left(\frac{\sqrt{2}}{2}\right)\left(y - \frac{\sqrt{2}}{2}\right) + 0(z - (-1)) = 0 \Rightarrow -\frac{\sqrt{2}}{2}x + \frac{\sqrt{2}}{2}y = 0$
 $\Rightarrow -x + y = 0$ is the normal plane; \mathbf{N} is normal to the rectifying plane
 $\Rightarrow \left(-\frac{\sqrt{2}}{2}\right)\left(x - \frac{\sqrt{2}}{2}\right) + \left(-\frac{\sqrt{2}}{2}\right)\left(y - \frac{\sqrt{2}}{2}\right) + 0(z - (-1)) = 0 \Rightarrow -\frac{\sqrt{2}}{2}x - \frac{\sqrt{2}}{2}y = -1 \Rightarrow x + y = \sqrt{2}$ is the
 rectifying plane

16. $\mathbf{r} = (\cos t)\mathbf{i} + (\sin t)\mathbf{j} + t\mathbf{k} \Rightarrow \mathbf{v} = (-\sin t)\mathbf{i} + (\cos t)\mathbf{j} + \mathbf{k} \Rightarrow |\mathbf{v}| = \sqrt{\sin^2 t + \cos^2 t + 1} = \sqrt{2} \Rightarrow \mathbf{T} = \frac{\mathbf{v}}{|\mathbf{v}|}$
 $= \left(-\frac{1}{\sqrt{2}}\sin t\right)\mathbf{i} + \left(\frac{1}{\sqrt{2}}\cos t\right)\mathbf{j} + \frac{1}{\sqrt{2}}\mathbf{k} \Rightarrow \frac{d\mathbf{T}}{dt} = \left(-\frac{1}{\sqrt{2}}\cos t\right)\mathbf{i} + \left(-\frac{1}{\sqrt{2}}\sin t\right)\mathbf{j} \Rightarrow \left|\frac{d\mathbf{T}}{dt}\right|$
 $= \sqrt{\frac{1}{2}\cos^2 t + \frac{1}{2}\sin^2 t} = \frac{1}{\sqrt{2}} \Rightarrow \mathbf{N} = \frac{\left(\frac{d\mathbf{T}}{dt}\right)}{\left|\frac{d\mathbf{T}}{dt}\right|} = (-\cos t)\mathbf{i} - (\sin t)\mathbf{j}$; thus $\mathbf{T}(0) = \frac{1}{\sqrt{2}}\mathbf{j} + \frac{1}{\sqrt{2}}\mathbf{k}$ and $\mathbf{N}(0) = -\mathbf{i}$
 $\Rightarrow \mathbf{B}(0) = \begin{vmatrix} \mathbf{i} & \mathbf{j} & \mathbf{k} \\ 0 & \frac{1}{\sqrt{2}} & \frac{1}{\sqrt{2}} \\ -1 & 0 & 0 \end{vmatrix} = -\frac{1}{\sqrt{2}}\mathbf{j} + \frac{1}{\sqrt{2}}\mathbf{k}$, the normal to the osculating plane; $\mathbf{r}(0) = \mathbf{i} \Rightarrow \mathbf{P}(1, 0, 0)$ lies on
 the osculating plane $\Rightarrow 0(x - 1) - \frac{1}{\sqrt{2}}(y - 0) + \frac{1}{\sqrt{2}}(z - 0) = 0 \Rightarrow y - z = 0$ is the osculating plane; \mathbf{T} is normal
 to the normal plane $\Rightarrow 0(x - 1) + \frac{1}{\sqrt{2}}(y - 0) + \frac{1}{\sqrt{2}}(z - 0) = 0 \Rightarrow y + z = 0$ is the normal plane; \mathbf{N} is normal to
 the rectifying plane $\Rightarrow -1(x - 1) + 0(y - 0) + 0(z - 0) = 0 \Rightarrow x = 1$ is the rectifying plane

17. Yes. If the car is moving along a curved path, then $\kappa \neq 0$ and $a_N = \kappa |\mathbf{v}|^2 \neq 0 \Rightarrow \mathbf{a} = a_T\mathbf{T} + a_N\mathbf{N} \neq \mathbf{0}$.

18. $|\mathbf{v}|$ constant $\Rightarrow a_T = \frac{d}{dt}|\mathbf{v}| = 0 \Rightarrow \mathbf{a} = a_N\mathbf{N}$ is orthogonal to $\mathbf{T} \Rightarrow$ the acceleration is normal to the path

19. $\mathbf{a} \perp \mathbf{v} \Rightarrow \mathbf{a} \perp \mathbf{T} \Rightarrow a_T = 0 \Rightarrow \frac{d}{dt}|\mathbf{v}| = 0 \Rightarrow |\mathbf{v}|$ is constant

20. $\mathbf{a}(t) = a_T\mathbf{T} + a_N\mathbf{N}$, where $a_T = \frac{d}{dt}|\mathbf{v}| = \frac{d}{dt}(10) = 0$ and $a_N = \kappa |\mathbf{v}|^2 = 100\kappa \Rightarrow \mathbf{a} = 0\mathbf{T} + 100\kappa\mathbf{N}$. Now, from
 Exercise 5(a) Section 13.4, we find for $y = f(x) = x^2$ that $\kappa = \frac{|f''(x)|}{[1 + (f'(x))^2]^{3/2}} = \frac{2}{[1 + (2x)^2]^{3/2}} = \frac{2}{(1 + 4x^2)^{3/2}}$; also,

$\mathbf{r}(t) = t\mathbf{i} + t^2\mathbf{j}$ is the position vector of the moving mass $\Rightarrow \mathbf{v} = \mathbf{i} + 2t\mathbf{j} \Rightarrow |\mathbf{v}| = \sqrt{1 + 4t^2}$
 $\Rightarrow \mathbf{T} = \frac{1}{\sqrt{1 + 4t^2}}(\mathbf{i} + 2t\mathbf{j})$. At $(0, 0)$: $\mathbf{T}(0) = \mathbf{i}$, $\mathbf{N}(0) = \mathbf{j}$ and $\kappa(0) = 2 \Rightarrow \mathbf{F} = \mathbf{ma} = m(100\kappa)\mathbf{N} = 200m\mathbf{j}$;
 At $(\sqrt{2}, 2)$: $\mathbf{T}(\sqrt{2}) = \frac{1}{3}(\mathbf{i} + 2\sqrt{2}\mathbf{j}) = \frac{1}{3}\mathbf{i} + \frac{2\sqrt{2}}{3}\mathbf{j}$, $\mathbf{N}(\sqrt{2}) = -\frac{2\sqrt{2}}{3}\mathbf{i} + \frac{1}{3}\mathbf{j}$, and $\kappa(\sqrt{2}) = \frac{2}{27} \Rightarrow \mathbf{F} = \mathbf{ma}$
 $= m(100\kappa)\mathbf{N} = \left(\frac{200}{27}m\right)\left(-\frac{2\sqrt{2}}{3}\mathbf{i} + \frac{1}{3}\mathbf{j}\right) = -\frac{400\sqrt{2}}{81}m\mathbf{i} + \frac{200}{81}m\mathbf{j}$

21. $\mathbf{a} = a_T\mathbf{T} + a_N\mathbf{N}$, where $a_T = \frac{d}{dt}|\mathbf{v}| = \frac{d}{dt}(\text{constant}) = 0$ and $a_N = \kappa |\mathbf{v}|^2 \Rightarrow \mathbf{F} = \mathbf{ma} = m\kappa |\mathbf{v}|^2\mathbf{N} \Rightarrow |\mathbf{F}| = m\kappa |\mathbf{v}|^2$
 $= (m |\mathbf{v}|^2) \kappa$, a constant multiple of the curvature κ of the trajectory

22. $a_N = 0 \Rightarrow \kappa |\mathbf{v}|^2 = 0 \Rightarrow \kappa = 0$ (since the particle is moving, we cannot have zero speed) \Rightarrow the curvature is zero so the particle is moving along a straight line

23. From Example 1, $|\mathbf{v}| = t$ and $a_N = t$ so that $a_N = \kappa |\mathbf{v}|^2 \Rightarrow \kappa = \frac{a_N}{|\mathbf{v}|^2} = \frac{t}{t^2} = \frac{1}{t}$, $t \neq 0 \Rightarrow \rho = \frac{1}{\kappa} = t$

24. $\mathbf{r} = (x_0 + At)\mathbf{i} + (y_0 + Bt)\mathbf{j} + (z_0 + Ct)\mathbf{k} \Rightarrow \mathbf{v} = A\mathbf{i} + B\mathbf{j} + C\mathbf{k} \Rightarrow \mathbf{a} = \mathbf{0} \Rightarrow \mathbf{v} \times \mathbf{a} = \mathbf{0} \Rightarrow \kappa = 0$. Since the curve is a plane curve, $\tau = 0$.

25. If a plane curve is sufficiently differentiable the torsion is zero as the following argument shows:

$$\mathbf{r} = f(t)\mathbf{i} + g(t)\mathbf{j} \Rightarrow \mathbf{v} = f'(t)\mathbf{i} + g'(t)\mathbf{j} \Rightarrow \mathbf{a} = f''(t)\mathbf{i} + g''(t)\mathbf{j} \Rightarrow \frac{d\mathbf{a}}{dt} = f'''(t)\mathbf{i} + g'''(t)\mathbf{j}$$

$$\Rightarrow \tau = \frac{\begin{vmatrix} f'(t) & g'(t) & 0 \\ f''(t) & g''(t) & 0 \\ f'''(t) & g'''(t) & 0 \end{vmatrix}}{|\mathbf{v} \times \mathbf{a}|^2} = 0$$

26. From Example 2, $\tau = \frac{b}{a^2 + b^2} \Rightarrow \tau'(b) = \frac{a^2 - b^2}{(a^2 + b^2)^2}$; $\tau'(b) = 0 \Rightarrow \frac{a^2 - b^2}{(a^2 + b^2)^2} = 0 \Rightarrow a^2 - b^2 = 0 \Rightarrow b = \pm a$
 $\Rightarrow b = a$ since $a, b > 0$. Also $b < a \Rightarrow \tau' > 0$ and $b > a \Rightarrow \tau' < 0$ so τ_{\max} occurs when $b = a \Rightarrow \tau_{\max} = \frac{a}{a^2 + a^2} = \frac{1}{2a}$

27. $\mathbf{r}(t) = f(t)\mathbf{i} + g(t)\mathbf{j} + h(t)\mathbf{k} \Rightarrow \mathbf{v} = f'(t)\mathbf{i} + g'(t)\mathbf{j} + h'(t)\mathbf{k}$; $\mathbf{v} \cdot \mathbf{k} = 0 \Rightarrow h'(t) = 0 \Rightarrow h(t) = C$
 $\Rightarrow \mathbf{r}(t) = f(t)\mathbf{i} + g(t)\mathbf{j} + C\mathbf{k}$ and $\mathbf{r}(a) = f(a)\mathbf{i} + g(a)\mathbf{j} + C\mathbf{k} = \mathbf{0} \Rightarrow f(a) = 0, g(a) = 0$ and $C = 0 \Rightarrow h(t) = 0$.

28. From Example 2, $\mathbf{v} = -(a \sin t)\mathbf{i} + (a \cos t)\mathbf{j} + b\mathbf{k} \Rightarrow |\mathbf{v}| = \sqrt{a^2 + b^2} \Rightarrow \mathbf{T} = \frac{\mathbf{v}}{|\mathbf{v}|}$
 $= \frac{1}{\sqrt{a^2 + b^2}} [-(a \sin t)\mathbf{i} + (a \cos t)\mathbf{j} + b\mathbf{k}]$; $\frac{d\mathbf{T}}{dt} = \frac{1}{\sqrt{a^2 + b^2}} [-(a \cos t)\mathbf{i} - (a \sin t)\mathbf{j}] \Rightarrow \mathbf{N} = \frac{(\frac{d\mathbf{T}}{dt})}{|\frac{d\mathbf{T}}{dt}|}$
 $= -(\cos t)\mathbf{i} - (\sin t)\mathbf{j}$; $\mathbf{B} = \mathbf{T} \times \mathbf{N} = \begin{vmatrix} \mathbf{i} & \mathbf{j} & \mathbf{k} \\ -\frac{a \sin t}{\sqrt{a^2 + b^2}} & \frac{a \cos t}{\sqrt{a^2 + b^2}} & \frac{b}{\sqrt{a^2 + b^2}} \\ -\cos t & -\sin t & 0 \end{vmatrix}$
 $= \frac{b \sin t}{\sqrt{a^2 + b^2}} \mathbf{i} - \frac{b \cos t}{\sqrt{a^2 + b^2}} \mathbf{j} + \frac{a}{\sqrt{a^2 + b^2}} \mathbf{k} \Rightarrow \frac{d\mathbf{B}}{dt} = \frac{1}{\sqrt{a^2 + b^2}} [(b \cos t)\mathbf{i} + (b \sin t)\mathbf{j}] \Rightarrow \frac{d\mathbf{B}}{dt} \cdot \mathbf{N} = -\frac{b}{\sqrt{a^2 + b^2}}$
 $\Rightarrow \tau = -\frac{1}{|\mathbf{v}|} \left(\frac{d\mathbf{B}}{dt} \cdot \mathbf{N} \right) = \left(-\frac{1}{\sqrt{a^2 + b^2}} \right) \left(-\frac{b}{\sqrt{a^2 + b^2}} \right) = \frac{b}{a^2 + b^2}$, which is consistent with the result in Example 2.

29-32. Example CAS commands:

Maple:

```
with( LinearAlgebra );
r := < t*cos(t) | t*sin(t) | t >;
t0 := sqrt(3);
rr := eval( r, t=t0 );
v := map( diff, r, t );
vv := eval( v, t=t0 );
a := map( diff, v, t );
aa := eval( a, t=t0 );
s := simplify( Norm( v, 2 ) ) assuming t::real;
ss := eval( s, t=t0 );
T := v/s;
TT := vv/ss ;
q1 := map( diff, simplify(T), t );
NN := simplify( eval( q1/Norm(q1,2), t=t0 ) );
```

```

BB := CrossProduct( TT, NN );
kappa := Norm(CrossProduct(vv,aa),2)/ss^3;
tau := simplify( Determinant(< vv, aa, eval(map(diff,a,t),t=t0) >)/Norm(CrossProduct(vv,aa),2)^3 );
a_t := eval( diff( s, t ), t=t0 );
a_n := evalf[4]( kappa*ss^2 );

```

Mathematica: (assigned functions and value for t0 will vary)

```

Clear[t, v, a, t]
mag[vector_]:=Sqrt[vector.vector]
Print["The position vector is ", r[t_]={t Cos[t], t Sin[t], t}]
Print["The velocity vector is ", v[t_]=r'[t]]
Print["The acceleration vector is ", a[t_]=v'[t]]
Print["The speed is ", speed[t_]=mag[v[t]]//Simplify]
Print["The unit tangent vector is ", utan[t_]=v[t]/speed[t] //Simplify]
Print["The curvature is ", curv[t_]=mag[Cross[v[t],a[t]]] / speed[t]^3 //Simplify]
Print["The torsion is ", torsion[t_]=Det[{v[t], a[t], a'[t]}] / mag[Cross[v[t],a[t]]]^2 //Simplify]
Print["The unit normal vector is ", unorm[t_]=utan'[t] / mag[utan'[t]] //Simplify]
Print["The unit binormal vector is ", ubinorm[t_]=Cross[utan[t],unorm[t]] //Simplify]
Print["The tangential component of the acceleration is ", at[t_]=a[t].utan[t] //Simplify]
Print["The normal component of the acceleration is ", an[t_]=a[t].unorm[t] //Simplify]

```

You can evaluate any of these functions at a specified value of t.

```

t0= Sqrt[3]
{utan[t0], unorm[t0], ubinorm[t0]}
N[{utan[t0], unorm[t0], ubinorm[t0]}]
{curv[t0], torsion[t0]}
N[{curv[t0], torsion[t0]}]
{at[t0], an[t0]}
N[{at[t0], an[t0]}]

```

To verify that the tangential and normal components of the acceleration agree with the formulas in the book:

```

at[t]== speed'[t] //Simplify
an[t]==curv [t] speed[t]^2 //Simplify

```

13.6 PLANETARY MOTION AND SATELLITES

- $$\frac{T^2}{a^3} = \frac{4\pi^2}{GM} \Rightarrow T^2 = \frac{4\pi^2}{GM} a^3 \Rightarrow T^2 = \frac{4\pi^2}{(6.6726 \times 10^{-11} \text{ Nm}^2\text{kg}^{-2})(5.975 \times 10^{24} \text{ kg})} (6,808,000 \text{ m})^3$$

$$\approx 3.125 \times 10^7 \text{ sec}^2 \Rightarrow T \approx \sqrt{3125 \times 10^4 \text{ sec}^2} \approx 55.90 \times 10^2 \text{ sec} \approx 93.2 \text{ min}$$
- $$e = 0.0167 \text{ and perihelion distance} = 149,577,000 \text{ km and } e = \frac{r_0 v_0^2}{GM} - 1$$

$$\Rightarrow 0.0167 = \frac{(149,577,000 \text{ m})v_0^2}{(6.6726 \times 10^{-11} \text{ Nm}^2\text{kg}^{-2})(1.99 \times 10^{30} \text{ kg})} - 1 \Rightarrow v_0^2 \approx 9.03 \times 10^8 \text{ m}^2/\text{sec}^2$$

$$\Rightarrow v_0 \approx \sqrt{9.03 \times 10^8 \text{ m}^2/\text{sec}^2} \approx 3.00 \times 10^4 \text{ m/sec}$$
- $$92.25 \text{ min} = 5535 \text{ sec and } \frac{T^2}{a^3} = \frac{4\pi^2}{GM} \Rightarrow a^3 = \frac{GM}{4\pi^2} T^2$$

$$\Rightarrow a^3 = \frac{(6.6726 \times 10^{-11} \text{ Nm}^2\text{kg}^{-2})(5.975 \times 10^{24} \text{ kg})}{4\pi^2} (5535 \text{ sec})^2 = 3.094 \times 10^{20} \text{ m}^3 \Rightarrow a \approx \sqrt[3]{3.094 \times 10^{20} \text{ m}^3}$$

$$= 6.764 \times 10^6 \text{ m} \approx 6764 \text{ km. Note that } 6764 \text{ km} \approx \frac{1}{2}(12,757 \text{ km} + 183 \text{ km} + 589 \text{ km}).$$
- $$T = 1639 \text{ min} = 98,340 \text{ sec and mass of Mars} = 6.418 \times 10^{23} \text{ kg} \Rightarrow a^3 = \frac{GM}{4\pi^2} T^2$$

$$= \frac{(6.6726 \times 10^{-11} \text{ Nm}^2\text{kg}^{-2})(6.418 \times 10^{23} \text{ kg})(98,340 \text{ sec})^2}{4\pi^2} \approx 1.049 \times 10^{22} \text{ m}^3 \Rightarrow a \approx \sqrt[3]{1.049 \times 10^{22} \text{ m}^3}$$

$$= 2.19 \times 10^7 \text{ m} = 21,900 \text{ km}$$

5. $2a = \text{diameter of Mars} + \text{perigee height} + \text{apogee height} = D + 1499 \text{ km} + 35,800 \text{ km}$
 $\Rightarrow 2(21,900) \text{ km} = D + 37,299 \text{ km} \Rightarrow D = 6501 \text{ km}$
6. $a = 22,030 \text{ km} = 2.203 \times 10^7 \text{ m}$ and $T^2 = \frac{4\pi^2}{GM} a^3$
 $\Rightarrow T^2 = \frac{4\pi^2}{(6.6720 \times 10^{-11} \text{ Nm}^2\text{kg}^{-2})(6.418 \times 10^{23} \text{ kg})} (2.203 \times 10^7 \text{ m})^3 \approx 9.856 \times 10^9 \text{ sec}^2$
 $\Rightarrow T \approx \sqrt{9.856 \times 10^9 \text{ sec}^2} \approx 9.928 \times 10^4 \text{ sec} \approx 1655 \text{ min}$
7. (a) Period of the satellite = rotational period of the Earth \Rightarrow period of the satellite = 1436.1 min
 $= 86,166 \text{ sec}$; $a^3 = \frac{GMT^2}{4\pi^2} \Rightarrow a^3 = \frac{(6.6726 \times 10^{-11} \text{ Nm}^2\text{kg}^{-2})(5.975 \times 10^{24} \text{ kg})(86,166 \text{ sec})^2}{4\pi^2}$
 $\approx 7.4980 \times 10^{22} \text{ m}^3 \Rightarrow a \approx \sqrt[3]{7.4980 \times 10^{21} \text{ m}^3} \approx 4.2168 \times 10^7 \text{ m} = 42,168 \text{ km}$
 (b) The radius of the Earth is approximately 6379 km \Rightarrow the height of the orbit is $42,168 - 6379 = 35,789 \text{ km}$
 (c) Symcom 3, GOES 4, and Intelsat 5
8. $T = 1477.4 \text{ min} = 88,644 \text{ sec} \Rightarrow a^3 = \frac{GMT^2}{4\pi^2}$
 $= \frac{(6.6726 \times 10^{-11} \text{ Nm}^2\text{kg}^{-2})(6.418 \times 10^{23} \text{ kg})(88,644 \text{ sec})^2}{4\pi^2} = 8.524 \times 10^{21} \text{ m}^3 \Rightarrow a \approx \sqrt[3]{8.524 \times 10^{21} \text{ m}^3}$
 $\approx 2.043 \times 10^7 \text{ m} = 20,430 \text{ km}$
9. Period of the Moon = $2.36055 \times 10^6 \text{ sec} \Rightarrow a^3 = \frac{GMT^2}{4\pi^2}$
 $= \frac{(6.6726 \times 10^{-11} \text{ Nm}^2\text{kg}^{-2})(5.975 \times 10^{24} \text{ kg})(2.36055 \times 10^6 \text{ sec})^2}{4\pi^2} \approx 5.627 \times 10^{25} \text{ m}^3 \Rightarrow a \approx \sqrt[3]{5.627 \times 10^{25} \text{ m}^3}$
 $\approx 3.832 \times 10^8 \text{ m} = 383,200 \text{ km}$ from the center of the Earth.
10. $r = \frac{GM}{v^2} \Rightarrow v^2 = \frac{GM}{r} \Rightarrow |v| = \sqrt{\frac{GM}{r}} = \sqrt{\frac{(6.6726 \times 10^{-11} \text{ Nm}^2\text{kg}^{-2})(5.975 \times 10^{24} \text{ kg})}{r}} \approx 1.9967 \times 10^7 r^{-1/2} \text{ m/sec}$
11. Solar System: $\frac{T^2}{a^3} = \frac{4\pi^2}{(6.6726 \times 10^{-11} \text{ Nm}^2\text{kg}^{-2})(1.99 \times 10^{30} \text{ kg})} \approx 2.97 \times 10^{-19} \text{ sec}^2/\text{m}^3$;
 Earth: $\frac{T^2}{a^3} = \frac{4\pi^2}{(6.6726 \times 10^{-11} \text{ Nm}^2\text{kg}^{-2})(5.975 \times 10^{24} \text{ kg})} \approx 9.902 \times 10^{-14} \text{ sec}^2/\text{m}^3$;
 Moon: $\frac{T^2}{a^3} = \frac{4\pi^2}{(6.6726 \times 10^{-11} \text{ Nm}^2\text{kg}^{-2})(7.354 \times 10^{22} \text{ kg})} \approx 8.045 \times 10^{-12} \text{ sec}^2/\text{m}^3$;
12. $e = \frac{r_0 v_0^2}{GM} - 1 \Rightarrow v_0^2 = \frac{GM(e+1)}{r_0} \Rightarrow v_0 = \sqrt{\frac{GM(e+1)}{r_0}}$;
 Circle: $e = 0 \Rightarrow v_0 = \sqrt{\frac{GM}{r_0}}$
 Ellipse: $0 < e < 1 \Rightarrow \sqrt{\frac{GM}{r_0}} < v_0 < \sqrt{\frac{2GM}{r_0}}$
 Parabola: $e = 1 \Rightarrow v_0 = \sqrt{\frac{2GM}{r_0}}$
 Hyperbola: $e > 1 \Rightarrow v_0 > \sqrt{\frac{2GM}{r_0}}$
13. $r = \frac{GM}{v^2} \Rightarrow v^2 = \frac{GM}{r} \Rightarrow v = \sqrt{\frac{GM}{r}}$ which is constant since G , M , and r (the radius of orbit) are constant
14. $\Delta A = \frac{1}{2} |\mathbf{r}(t + \Delta t) \times \mathbf{r}(t)| \Rightarrow \frac{\Delta A}{\Delta t} = \frac{1}{2} \left| \frac{\mathbf{r}(t + \Delta t)}{\Delta t} \times \mathbf{r}(t) \right| = \frac{1}{2} \left| \frac{\mathbf{r}(t + \Delta t) - \mathbf{r}(t) + \mathbf{r}(t)}{\Delta t} \times \mathbf{r}(t) \right|$
 $= \frac{1}{2} \left| \frac{\mathbf{r}(t + \Delta t) - \mathbf{r}(t)}{\Delta t} \times \mathbf{r}(t) + \frac{1}{\Delta t} \mathbf{r}(t) \times \mathbf{r}(t) \right| = \frac{1}{2} \left| \frac{\mathbf{r}(t + \Delta t) - \mathbf{r}(t)}{\Delta t} \times \mathbf{r}(t) \right| \Rightarrow \frac{dA}{dt} = \lim_{\Delta t \rightarrow 0} \frac{1}{2} \left| \frac{\mathbf{r}(t + \Delta t) - \mathbf{r}(t)}{\Delta t} \times \mathbf{r}(t) \right|$
 $= \frac{1}{2} \left| \frac{d\mathbf{r}}{dt} \times \mathbf{r}(t) \right| = \frac{1}{2} |\mathbf{r}(t) \times \frac{d\mathbf{r}}{dt}| = \frac{1}{2} |\mathbf{r} \times \dot{\mathbf{r}}|$

$$\begin{aligned}
 15. \quad T &= \left(\frac{2\pi a^3}{r_0 v_0} \right) \sqrt{1 - e^2} \Rightarrow T^2 = \left(\frac{4\pi^2 a^4}{r_0^2 v_0^2} \right) (1 - e^2) = \left(\frac{4\pi^2 a^4}{r_0^2 v_0^2} \right) \left[1 - \left(\frac{r_0 v_0^2}{GM} - 1 \right)^2 \right] \text{ (from Equation 32)} \\
 &= \left(\frac{4\pi^2 a^4}{r_0^2 v_0^2} \right) \left[-\frac{r_0^2 v_0^4}{G^2 M^2} + 2 \left(\frac{r_0 v_0^2}{GM} \right) \right] = \left(\frac{4\pi^2 a^4}{r_0^2 v_0^2} \right) \left[\frac{2GM r_0 v_0^2 - r_0^2 v_0^4}{G^2 M^2} \right] = \frac{(4\pi^2 a^4) (2GM - r_0 v_0^2)}{r_0 G^2 M^2} \\
 &= (4\pi^2 a^4) \left(\frac{2GM - r_0 v_0^2}{2r_0 GM} \right) \left(\frac{2}{GM} \right) = (4\pi^2 a^4) \left(\frac{1}{2a} \right) \left(\frac{2}{GM} \right) \text{ (from Equation 35)} \Rightarrow T^2 = \frac{4\pi^2 a^3}{GM} \Rightarrow \frac{T^2}{a^3} = \frac{4\pi^2}{GM}
 \end{aligned}$$

$$\begin{aligned}
 16. \quad \text{Let } \mathbf{r}_{AB}(t) \text{ denote the vector from planet A to planet B at time } t. \text{ Then } \mathbf{r}_{AB}(t) &= \mathbf{r}_B(t) - \mathbf{r}_A(t) \\
 &= [3 \cos(\pi t) - 2 \cos(2\pi t)]\mathbf{i} + [3 \sin(\pi t) - 2 \sin(2\pi t)]\mathbf{j} \\
 &= [3 \cos(\pi t) - 2(\cos^2(\pi t) - \sin^2(\pi t))]\mathbf{i} + [3 \sin(\pi t) - 4 \sin(\pi t) \cos(\pi t)]\mathbf{j} \\
 &= [3 \cos(\pi t) - 4 \cos^2(\pi t) + 2]\mathbf{i} + [(3 - 4 \cos(\pi t)) \sin(\pi t)]\mathbf{j} \Rightarrow \text{parametric equations for the path are} \\
 x(t) &= 2 + [3 - 4 \cos(\pi t)] \cos(\pi t) \text{ and } y(t) = [3 - 4 \cos(\pi t)] \sin(\pi t)
 \end{aligned}$$

17. The graph of the path of planet B is the limaçon at the right.

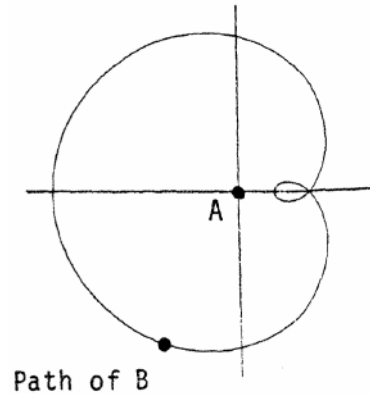

18. (i) Perihelion is the time t such that $|\mathbf{r}(t)|$ is a minimum.
 (ii) Aphelion is the time t such that $|\mathbf{r}(t)|$ is a maximum.
 (iii) Equinox is the time t such that $\mathbf{r}(t) \cdot \mathbf{w} = 0$.
 (iv) Summer solstice is the time t such that the angle between $\mathbf{r}(t)$ and \mathbf{w} is a maximum.
 (v) Winter solstice is the time t such that the angle between $\mathbf{r}(t)$ and \mathbf{w} is a minimum.

CHAPTER 13 PRACTICE EXERCISES

1. $\mathbf{r}(t) = (4 \cos t)\mathbf{i} + (\sqrt{2} \sin t)\mathbf{j} \Rightarrow x = 4 \cos t$

and $y = \sqrt{2} \sin t \Rightarrow \frac{x^2}{16} + \frac{y^2}{2} = 1;$

$\mathbf{v} = (-4 \sin t)\mathbf{i} + (\sqrt{2} \cos t)\mathbf{j}$ and

$\mathbf{a} = (-4 \cos t)\mathbf{i} - (\sqrt{2} \sin t)\mathbf{j}; \mathbf{r}(0) = 4\mathbf{i}, \mathbf{v}(0) = \sqrt{2}\mathbf{j},$

$\mathbf{a}(0) = -4\mathbf{i}; \mathbf{r}(\frac{\pi}{4}) = 2\sqrt{2}\mathbf{i} + \mathbf{j}, \mathbf{v}(\frac{\pi}{4}) = -2\sqrt{2}\mathbf{i} + \mathbf{j},$

$\mathbf{a}(\frac{\pi}{4}) = -2\sqrt{2}\mathbf{i} - \mathbf{j}; |\mathbf{v}| = \sqrt{16 \sin^2 t + 2 \cos^2 t}$

$\Rightarrow a_T = \frac{d}{dt} |\mathbf{v}| = \frac{14 \sin t \cos t}{\sqrt{16 \sin^2 t + 2 \cos^2 t}}; \text{ at } t = 0: a_T = 0, a_N = \sqrt{|\mathbf{a}|^2 - 0} = 4, \kappa = \frac{a_N}{|\mathbf{v}|^2} = \frac{4}{2} = 2;$

at $t = \frac{\pi}{4}: a_T = \frac{7}{\sqrt{8+1}} = \frac{7}{3}, a_N = \sqrt{9 - \frac{49}{9}} = \frac{4\sqrt{2}}{3}, \kappa = \frac{a_N}{|\mathbf{v}|^2} = \frac{4\sqrt{2}}{27}$

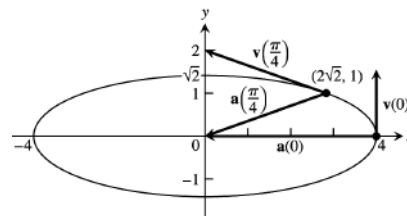

$$2. \mathbf{r}(t) = (\sqrt{3} \sec t) \mathbf{i} + (\sqrt{3} \tan t) \mathbf{j} \Rightarrow x = \sqrt{3} \sec t \text{ and } y = \sqrt{3} \tan t \Rightarrow \frac{x^2}{3} - \frac{y^2}{3} = \sec^2 t - \tan^2 t = 1;$$

$$\Rightarrow x^2 - y^2 = 3; \mathbf{v} = (\sqrt{3} \sec t \tan t) \mathbf{i} + (\sqrt{3} \sec^2 t) \mathbf{j}$$

and

$$\mathbf{a} = (\sqrt{3} \sec t \tan^2 t + \sqrt{3} \sec^3 t) \mathbf{i} - (2\sqrt{3} \sec^2 t \tan t) \mathbf{j};$$

$$\mathbf{r}(0) = \sqrt{3}\mathbf{i}, \mathbf{v}(0) = \sqrt{3}\mathbf{j}, \mathbf{a}(0) = \sqrt{3}\mathbf{i};$$

$$|\mathbf{v}| = \sqrt{3 \sec^2 t \tan^2 t + 3 \sec^4 t}$$

$$\Rightarrow \mathbf{a}_T = \frac{d}{dt} |\mathbf{v}| = \frac{6 \sec^2 t \tan^3 t + 18 \sec^4 t \tan t}{2\sqrt{3 \sec^2 t \tan^2 t + 3 \sec^4 t}};$$

$$\text{at } t = 0: \mathbf{a}_T = 0, \mathbf{a}_N = \sqrt{|\mathbf{a}|^2 - 0} = \sqrt{3},$$

$$\kappa = \frac{\mathbf{a}_N}{|\mathbf{v}|^2} = \frac{\sqrt{3}}{3} = \frac{1}{\sqrt{3}}$$

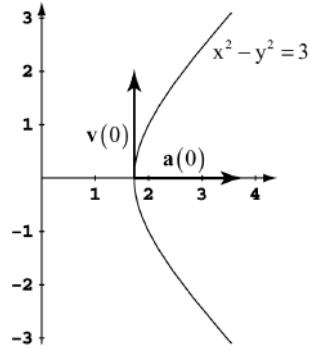

$$3. \mathbf{r} = \frac{1}{\sqrt{1+t^2}} \mathbf{i} + \frac{t}{\sqrt{1+t^2}} \mathbf{j} \Rightarrow \mathbf{v} = -t(1+t^2)^{-3/2} \mathbf{i} + (1+t^2)^{-3/2} \mathbf{j}$$

$$\Rightarrow |\mathbf{v}| = \sqrt{[-t(1+t^2)^{-3/2}]^2 + [(1+t^2)^{-3/2}]^2} = \frac{1}{1+t^2}. \text{ We want to maximize } |\mathbf{v}|: \frac{d|\mathbf{v}|}{dt} = \frac{-2t}{(1+t^2)^2} \text{ and}$$

$$\frac{d|\mathbf{v}|}{dt} = 0 \Rightarrow \frac{-2t}{(1+t^2)^2} = 0 \Rightarrow t = 0. \text{ For } t < 0, \frac{-2t}{(1+t^2)^2} > 0; \text{ for } t > 0, \frac{-2t}{(1+t^2)^2} < 0 \Rightarrow |\mathbf{v}|_{\max} \text{ occurs when}$$

$$t = 0 \Rightarrow |\mathbf{v}|_{\max} = 1$$

$$4. \mathbf{r} = (e^t \cos t) \mathbf{i} + (e^t \sin t) \mathbf{j} \Rightarrow \mathbf{v} = (e^t \cos t - e^t \sin t) \mathbf{i} + (e^t \sin t + e^t \cos t) \mathbf{j}$$

$$\Rightarrow \mathbf{a} = (e^t \cos t - e^t \sin t - e^t \sin t - e^t \cos t) \mathbf{i} + (e^t \sin t + e^t \cos t + e^t \cos t - e^t \sin t) \mathbf{j}$$

$$= (-2e^t \sin t) \mathbf{i} + (2e^t \cos t) \mathbf{j}. \text{ Let } \theta \text{ be the angle between } \mathbf{r} \text{ and } \mathbf{a}. \text{ Then } \theta = \cos^{-1} \left(\frac{\mathbf{r} \cdot \mathbf{a}}{|\mathbf{r}| |\mathbf{a}|} \right)$$

$$= \cos^{-1} \left(\frac{-2e^{2t} \sin t \cos t + 2e^{2t} \sin t \cos t}{\sqrt{(e^t \cos t)^2 + (e^t \sin t)^2} \sqrt{(-2e^t \sin t)^2 + (2e^t \cos t)^2}} \right) = \cos^{-1} \left(\frac{0}{2e^{2t}} \right) = \cos^{-1} 0 = \frac{\pi}{2} \text{ for all } t$$

$$5. \mathbf{v} = 3\mathbf{i} + 4\mathbf{j} \text{ and } \mathbf{a} = 5\mathbf{i} + 15\mathbf{j} \Rightarrow \mathbf{v} \times \mathbf{a} = \begin{vmatrix} \mathbf{i} & \mathbf{j} & \mathbf{k} \\ 3 & 4 & 0 \\ 5 & 15 & 0 \end{vmatrix} = 25\mathbf{k} \Rightarrow |\mathbf{v} \times \mathbf{a}| = 25; |\mathbf{v}| = \sqrt{3^2 + 4^2} = 5$$

$$\Rightarrow \kappa = \frac{|\mathbf{v} \times \mathbf{a}|}{|\mathbf{v}|^3} = \frac{25}{5^3} = \frac{1}{5}$$

$$6. \kappa = \frac{|y''|}{[1+(y')^2]^{3/2}} = e^x (1+e^{2x})^{-3/2} \Rightarrow \frac{d\kappa}{dx} = e^x (1+e^{2x})^{-3/2} + e^x \left[-\frac{3}{2} (1+e^{2x})^{-5/2} (2e^{2x}) \right]$$

$$= e^x (1+e^{2x})^{-3/2} - 3e^{3x} (1+e^{2x})^{-5/2} = e^x (1+e^{2x})^{-5/2} [(1+e^{2x}) - 3e^{2x}] = e^x (1+e^{2x})^{-5/2} (1-2e^{2x});$$

$$\frac{d\kappa}{dx} = 0 \Rightarrow (1-2e^{2x}) = 0 \Rightarrow e^{2x} = \frac{1}{2} \Rightarrow 2x = -\ln 2 \Rightarrow x = -\frac{1}{2} \ln 2 = -\ln \sqrt{2} \Rightarrow y = \frac{1}{\sqrt{2}}; \text{ therefore } \kappa \text{ is at a}$$

$$\text{maximum at the point } \left(-\ln \sqrt{2}, \frac{1}{\sqrt{2}} \right)$$

$$7. \mathbf{r} = x\mathbf{i} + y\mathbf{j} \Rightarrow \mathbf{v} = \frac{dx}{dt} \mathbf{i} + \frac{dy}{dt} \mathbf{j} \text{ and } \mathbf{v} \cdot \mathbf{i} = y \Rightarrow \frac{dx}{dt} = y. \text{ Since the particle moves around the unit circle}$$

$$x^2 + y^2 = 1, 2x \frac{dx}{dt} + 2y \frac{dy}{dt} = 0 \Rightarrow \frac{dy}{dt} = -\frac{x}{y} \frac{dx}{dt} \Rightarrow \frac{dy}{dt} = -\frac{x}{y} (y) = -x. \text{ Since } \frac{dx}{dt} = y \text{ and } \frac{dy}{dt} = -x, \text{ we have}$$

$$\mathbf{v} = y\mathbf{i} - x\mathbf{j} \Rightarrow \text{at } (1, 0), \mathbf{v} = -\mathbf{j} \text{ and the motion is clockwise.}$$

$$8. 9y = x^3 \Rightarrow 9 \frac{dy}{dt} = 3x^2 \frac{dx}{dt} \Rightarrow \frac{dy}{dt} = \frac{1}{3} x^2 \frac{dx}{dt}. \text{ If } \mathbf{r} = x\mathbf{i} + y\mathbf{j}, \text{ where } x \text{ and } y \text{ are differentiable functions of } t,$$

$$\text{then } \mathbf{v} = \frac{dx}{dt} \mathbf{i} + \frac{dy}{dt} \mathbf{j}. \text{ Hence } \mathbf{v} \cdot \mathbf{i} = 4 \Rightarrow \frac{dx}{dt} = 4 \text{ and } \mathbf{v} \cdot \mathbf{j} = \frac{dy}{dt} = \frac{1}{3} x^2 \frac{dx}{dt} = \frac{1}{3} (3)^2 (4) = 12 \text{ at } (3, 3). \text{ Also,}$$

$$\mathbf{a} = \frac{d^2x}{dt^2} \mathbf{i} + \frac{d^2y}{dt^2} \mathbf{j} \text{ and } \frac{d^2y}{dt^2} = \left(\frac{2}{3} x \right) \left(\frac{dx}{dt} \right)^2 + \left(\frac{1}{3} x^2 \right) \frac{d^2x}{dt^2}. \text{ Hence } \mathbf{a} \cdot \mathbf{i} = -2 \Rightarrow \frac{d^2x}{dt^2} = -2 \text{ and}$$

$$\mathbf{a} \cdot \mathbf{j} = \frac{d^2y}{dt^2} = \frac{2}{3} (3)(4)^2 + \frac{1}{3} (3)^2 (-2) = 26 \text{ at the point } (x, y) = (3, 3).$$

9. $\frac{dr}{dt}$ orthogonal to $\mathbf{r} \Rightarrow 0 = \frac{dr}{dt} \cdot \mathbf{r} = \frac{1}{2} \frac{dr}{dt} \cdot \mathbf{r} + \frac{1}{2} \mathbf{r} \cdot \frac{dr}{dt} = \frac{1}{2} \frac{d}{dt} (\mathbf{r} \cdot \mathbf{r}) \Rightarrow \mathbf{r} \cdot \mathbf{r} = K$, a constant. If $\mathbf{r} = x\mathbf{i} + y\mathbf{j}$, where x and y are differentiable functions of t , then $\mathbf{r} \cdot \mathbf{r} = x^2 + y^2 \Rightarrow x^2 + y^2 = K$, which is the equation of a circle centered at the origin.

10. (b) $\mathbf{v} = (\pi - \pi \cos \pi t)\mathbf{i} + (\pi \sin \pi t)\mathbf{j}$
 $\Rightarrow \mathbf{a} = (\pi^2 \sin \pi t)\mathbf{i} + (\pi^2 \cos \pi t)\mathbf{j}$;
 $\mathbf{v}(0) = \mathbf{0}$ and $\mathbf{a}(0) = \pi^2\mathbf{j}$;
 $\mathbf{v}(1) = 2\pi\mathbf{i}$ and $\mathbf{a}(1) = -\pi^2\mathbf{j}$;
 $\mathbf{v}(2) = \mathbf{0}$ and $\mathbf{a}(2) = \pi^2\mathbf{j}$;
 $\mathbf{v}(3) = 2\pi\mathbf{i}$ and $\mathbf{a}(3) = -\pi^2\mathbf{j}$

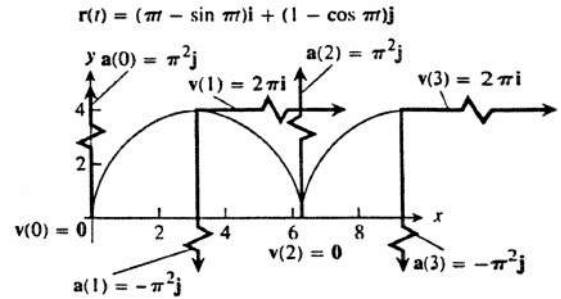

(c) Forward speed at the topmost point is $|\mathbf{v}(1)| = |\mathbf{v}(3)| = 2\pi$ ft/sec; since the circle makes $\frac{1}{2}$ revolution per second, the center moves π ft parallel to the x -axis each second \Rightarrow the forward speed of C is π ft/sec.

11. $y = y_0 + (v_0 \sin \alpha)t - \frac{1}{2}gt^2 \Rightarrow y = 6.5 + (44 \text{ ft/sec})(\sin 45^\circ)(3 \text{ sec}) - \frac{1}{2}(32 \text{ ft/sec}^2)(3 \text{ sec})^2 = 6.5 + 66\sqrt{2} - 144 \approx -44.16 \text{ ft} \Rightarrow$ the shot put is on the ground. Now, $y = 0 \Rightarrow 6.5 + 22\sqrt{2}t - 16t^2 = 0 \Rightarrow t \approx 2.13 \text{ sec}$ (the positive root) $\Rightarrow x \approx (44 \text{ ft/sec})(\cos 45^\circ)(2.13 \text{ sec}) \approx 66.27 \text{ ft}$ or about 66 ft, 3 in. from the stopboard

12. $y_{\max} = y_0 + \frac{(v_0 \sin \alpha)^2}{2g} = 7 \text{ ft} + \frac{[(80 \text{ ft/sec})(\sin 45^\circ)]^2}{(2)(32 \text{ ft/sec}^2)} \approx 57 \text{ ft}$

13. $x = (v_0 \cos \alpha)t$ and $y = (v_0 \sin \alpha)t - \frac{1}{2}gt^2 \Rightarrow \tan \phi = \frac{y}{x} = \frac{(v_0 \sin \alpha)t - \frac{1}{2}gt^2}{(v_0 \cos \alpha)t} = \frac{(v_0 \sin \alpha) - \frac{1}{2}gt}{v_0 \cos \alpha}$
 $\Rightarrow v_0 \cos \alpha \tan \phi = v_0 \sin \alpha - \frac{1}{2}gt \Rightarrow t = \frac{2v_0 \sin \alpha - 2v_0 \cos \alpha \tan \phi}{g}$, which is the time when the golf ball hits the upward slope. At this time

$$x = (v_0 \cos \alpha) \left(\frac{2v_0 \sin \alpha - 2v_0 \cos \alpha \tan \phi}{g} \right)$$

$$= \left(\frac{2}{g} \right) (v_0^2 \sin \alpha \cos \alpha - v_0^2 \cos^2 \alpha \tan \phi). \text{ Now}$$

$$\text{OR} = \frac{x}{\cos \phi} \Rightarrow \text{OR} = \left(\frac{2}{g} \right) \left(\frac{v_0^2 \sin \alpha \cos \alpha - v_0^2 \cos^2 \alpha \tan \phi}{\cos \phi} \right)$$

$$= \left(\frac{2v_0^2 \cos \alpha}{g} \right) \left(\frac{\sin \alpha}{\cos \phi} - \frac{\cos \alpha \tan \phi}{\cos \phi} \right)$$

$$= \left(\frac{2v_0^2 \cos \alpha}{g} \right) \left(\frac{\sin \alpha \cos \phi - \cos \alpha \sin \phi}{\cos^2 \phi} \right)$$

$$= \left(\frac{2v_0^2 \cos \alpha}{g \cos^2 \phi} \right) [\sin(\alpha - \phi)]. \text{ The distance OR is maximized}$$

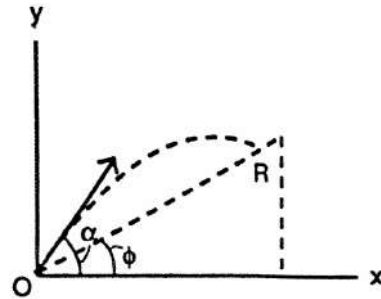

when x is maximized: $\frac{dx}{d\alpha} = \left(\frac{2v_0^2}{g} \right) (\cos 2\alpha + \sin 2\alpha \tan \phi) = 0 \Rightarrow (\cos 2\alpha + \sin 2\alpha \tan \phi) = 0 \Rightarrow \cot 2\alpha + \tan \phi = 0$
 $\Rightarrow \cot 2\alpha = \tan(-\phi) \Rightarrow 2\alpha = \frac{\pi}{2} + \phi \Rightarrow \alpha = \frac{\phi}{2} + \frac{\pi}{4}$

14. $R = \frac{v_0^2}{g} \sin 2\alpha \Rightarrow v_0 = \sqrt{\frac{Rg}{\sin 2\alpha}}$; for 4325 yards: 4325 yards = 12,975 ft $\Rightarrow v_0 = \sqrt{\frac{(12,975 \text{ ft})(32 \text{ ft/sec}^2)}{(\sin 90^\circ)}}$
 $\approx 644 \text{ ft/sec}$; for 4752 yards: 4752 yards = 14,256 ft $\Rightarrow v_0 = \sqrt{\frac{(14,256 \text{ ft})(32 \text{ ft/sec}^2)}{(\sin 90^\circ)}} \approx 675 \text{ ft/sec}$

15. (a) $R = \frac{v_0^2}{g} \sin 2\alpha \Rightarrow 109.5 \text{ ft} = \left(\frac{v_0^2}{32 \text{ ft/sec}^2} \right) (\sin 90^\circ) \Rightarrow v_0^2 = 3504 \text{ ft}^2/\text{sec}^2 \Rightarrow v_0 = \sqrt{3504 \text{ ft}^2/\text{sec}^2} \approx 59.19 \text{ ft/sec}$

(b) $x = (v_0 \cos \alpha)t$ and $y = 4 + (v_0 \sin \alpha)t - \frac{1}{2}gt^2$; when the cork hits the ground, $x = 177.75 \text{ ft}$ and $y = 0$
 $\Rightarrow 177.75 = \left(v_0 \frac{1}{\sqrt{2}} \right) t$ and $0 = 4 + \left(v_0 \frac{1}{\sqrt{2}} \right) t - 16t^2 \Rightarrow 16t^2 = 4 + 177.75 \Rightarrow t = \frac{\sqrt{181.75}}{4}$
 $\Rightarrow v_0 = \frac{(177.75)\sqrt{2}}{t} = \frac{4(177.75)\sqrt{2}}{\sqrt{181.75}} \approx 74.58 \text{ ft/sec}$

$$16. (a) \quad x = v_0(\cos 40^\circ)t \text{ and } y = 6.5 + v_0(\sin 40^\circ)t - \frac{1}{2}gt^2 = 6.5 + v_0(\sin 40^\circ)t - 16t^2; \quad x = 262 \frac{5}{12} \text{ ft and } y = 0 \text{ ft}$$

$$\Rightarrow 262 \frac{5}{12} = v_0(\cos 40^\circ)t \text{ or } v_0 = \frac{262.4167}{(\cos 40^\circ)t} \text{ and } 0 = 6.5 + \left[\frac{262.4167}{(\cos 40^\circ)t} \right] (\sin 40^\circ)t - 16t^2 \Rightarrow t^2 = 14.1684$$

$$\Rightarrow t \approx 3.764 \text{ sec. Therefore, } 262.4167 \approx v_0(\cos 40^\circ)(3.764 \text{ sec}) \Rightarrow v_0 \approx \frac{262.4167}{(\cos 40^\circ)(3.764 \text{ sec})} \Rightarrow v_0 \approx 91 \text{ ft/sec}$$

$$(b) \quad y_{\max} = y_0 + \frac{(v_0 \sin \alpha)^2}{2g} \approx 6.5 + \frac{(91)(\sin 40^\circ)^2}{(2)(32)} \approx 60 \text{ ft}$$

$$17. \quad x^2 = (v_0^2 \cos^2 \alpha) t^2 \text{ and } (y + \frac{1}{2}gt^2)^2 = (v_0^2 \sin^2 \alpha) t^2 \Rightarrow x^2 + (y + \frac{1}{2}gt^2)^2 = v_0^2 t^2$$

$$18. \quad \ddot{s} = \frac{d}{dt} \sqrt{\dot{x}^2 + \dot{y}^2} = \frac{\dot{x}\ddot{x} + \dot{y}\ddot{y}}{\sqrt{\dot{x}^2 + \dot{y}^2}} \Rightarrow \ddot{x}^2 + \ddot{y}^2 - \ddot{s}^2 = \ddot{x}^2 + \ddot{y}^2 - \frac{(\dot{x}\ddot{x} + \dot{y}\ddot{y})^2}{\dot{x}^2 + \dot{y}^2}$$

$$= \frac{(\dot{x}^2 + \dot{y}^2)(\ddot{x}^2 + \ddot{y}^2) - (\dot{x}\ddot{x} + \dot{y}\ddot{y})^2}{\dot{x}^2 + \dot{y}^2} = \frac{\dot{x}^2 \ddot{y}^2 + \dot{y}^2 \ddot{x}^2 - 2\dot{x}\dot{y}\ddot{x}\ddot{y}}{\dot{x}^2 + \dot{y}^2} = \frac{(\dot{x}\ddot{y} - \dot{y}\ddot{x})^2}{\dot{x}^2 + \dot{y}^2}$$

$$\Rightarrow \sqrt{\ddot{x}^2 + \ddot{y}^2 - \ddot{s}^2} = \frac{|\dot{x}\ddot{y} - \dot{y}\ddot{x}|}{\sqrt{\dot{x}^2 + \dot{y}^2}} \Rightarrow \frac{\dot{x}^2 + \dot{y}^2}{\sqrt{\dot{x}^2 + \dot{y}^2 - \ddot{s}^2}} = \frac{(\dot{x}^2 + \dot{y}^2)^{3/2}}{|\dot{x}\ddot{y} - \dot{y}\ddot{x}|} = \frac{1}{\kappa} = \rho$$

$$19. \quad \mathbf{r}(t) = \left[\int_0^t \cos\left(\frac{1}{2}\pi\theta^2\right) d\theta \right] \mathbf{i} + \left[\int_0^t \sin\left(\frac{1}{2}\pi\theta^2\right) d\theta \right] \mathbf{j} \Rightarrow \mathbf{v}(t) = \cos\left(\frac{\pi t^2}{2}\right) \mathbf{i} + \sin\left(\frac{\pi t^2}{2}\right) \mathbf{j} \Rightarrow |\mathbf{v}| = 1;$$

$$\mathbf{a}(t) = -\pi t \sin\left(\frac{\pi t^2}{2}\right) \mathbf{i} + \pi t \cos\left(\frac{\pi t^2}{2}\right) \mathbf{j} \Rightarrow \mathbf{v} \times \mathbf{a} = \begin{vmatrix} \mathbf{i} & \mathbf{j} & \mathbf{k} \\ \cos\left(\frac{\pi t^2}{2}\right) & \sin\left(\frac{\pi t^2}{2}\right) & 0 \\ -\pi t \sin\left(\frac{\pi t^2}{2}\right) & \pi t \cos\left(\frac{\pi t^2}{2}\right) & 0 \end{vmatrix}$$

$$= \pi t \mathbf{k} \Rightarrow \kappa = \frac{|\mathbf{v} \times \mathbf{a}|}{|\mathbf{v}|^3} = \pi t; \quad |\mathbf{v}(t)| = \frac{ds}{dt} = 1 \Rightarrow s = t + C; \quad \mathbf{r}(0) = \mathbf{0} \Rightarrow s(0) = 0 \Rightarrow C = 0 \Rightarrow \kappa = \pi s$$

$$20. \quad s = a\theta \Rightarrow \theta = \frac{s}{a} \Rightarrow \phi = \frac{s}{a} + \frac{\pi}{2} \Rightarrow \frac{d\phi}{ds} = \frac{1}{a} \Rightarrow \kappa = \left| \frac{1}{a} \right| = \frac{1}{a} \text{ since } a > 0$$

$$21. \quad \mathbf{r} = (2 \cos t)\mathbf{i} + (2 \sin t)\mathbf{j} + t^2\mathbf{k} \Rightarrow \mathbf{v} = (-2 \sin t)\mathbf{i} + (2 \cos t)\mathbf{j} + 2t\mathbf{k} \Rightarrow |\mathbf{v}| = \sqrt{(-2 \sin t)^2 + (2 \cos t)^2 + (2t)^2}$$

$$= 2\sqrt{1+t^2} \Rightarrow \text{Length} = \int_0^{\pi/4} 2\sqrt{1+t^2} dt = \left[t\sqrt{1+t^2} + \ln \left| t + \sqrt{1+t^2} \right| \right]_0^{\pi/4} = \frac{\pi}{4} \sqrt{1 + \frac{\pi^2}{16}} + \ln \left(\frac{\pi}{4} + \sqrt{1 + \frac{\pi^2}{16}} \right)$$

$$22. \quad \mathbf{r} = (3 \cos t)\mathbf{i} + (3 \sin t)\mathbf{j} + 2t^{3/2}\mathbf{k} \Rightarrow \mathbf{v} = (-3 \sin t)\mathbf{i} + (3 \cos t)\mathbf{j} + 3t^{1/2}\mathbf{k}$$

$$\Rightarrow |\mathbf{v}| = \sqrt{(-3 \sin t)^2 + (3 \cos t)^2 + (3t^{1/2})^2} = \sqrt{9 + 9t} = 3\sqrt{1+t} \Rightarrow \text{Length} = \int_0^3 3\sqrt{1+t} dt = [2(1+t)^{3/2}]_0^3$$

$$= 14$$

$$23. \quad \mathbf{r} = \frac{4}{9}(1+t)^{3/2}\mathbf{i} + \frac{4}{9}(1-t)^{3/2}\mathbf{j} + \frac{1}{3}t\mathbf{k} \Rightarrow \mathbf{v} = \frac{2}{3}(1+t)^{1/2}\mathbf{i} - \frac{2}{3}(1-t)^{1/2}\mathbf{j} + \frac{1}{3}\mathbf{k}$$

$$\Rightarrow |\mathbf{v}| = \sqrt{\left[\frac{2}{3}(1+t)^{1/2} \right]^2 + \left[-\frac{2}{3}(1-t)^{1/2} \right]^2 + \left(\frac{1}{3} \right)^2} = 1 \Rightarrow \mathbf{T} = \frac{2}{3}(1+t)^{1/2}\mathbf{i} - \frac{2}{3}(1-t)^{1/2}\mathbf{j} + \frac{1}{3}\mathbf{k}$$

$$\Rightarrow \mathbf{T}(0) = \frac{2}{3}\mathbf{i} - \frac{2}{3}\mathbf{j} + \frac{1}{3}\mathbf{k}; \quad \frac{d\mathbf{T}}{dt} = \frac{1}{3}(1+t)^{-1/2}\mathbf{i} + \frac{1}{3}(1-t)^{-1/2}\mathbf{j} \Rightarrow \frac{d\mathbf{T}}{dt}(0) = \frac{1}{3}\mathbf{i} + \frac{1}{3}\mathbf{j} \Rightarrow \left| \frac{d\mathbf{T}}{dt}(0) \right| = \frac{\sqrt{2}}{3}$$

$$\Rightarrow \mathbf{N}(0) = \frac{1}{\sqrt{2}}\mathbf{i} + \frac{1}{\sqrt{2}}\mathbf{j}; \quad \mathbf{B}(0) = \mathbf{T}(0) \times \mathbf{N}(0) = \begin{vmatrix} \mathbf{i} & \mathbf{j} & \mathbf{k} \\ \frac{2}{3} & -\frac{2}{3} & \frac{1}{3} \\ \frac{1}{\sqrt{2}} & \frac{1}{\sqrt{2}} & 0 \end{vmatrix} = -\frac{1}{3\sqrt{2}}\mathbf{i} + \frac{1}{3\sqrt{2}}\mathbf{j} + \frac{4}{3\sqrt{2}}\mathbf{k};$$

$$\mathbf{a} = \frac{1}{3}(1+t)^{-1/2}\mathbf{i} + \frac{1}{3}(1-t)^{-1/2}\mathbf{j} \Rightarrow \mathbf{a}(0) = \frac{1}{3}\mathbf{i} + \frac{1}{3}\mathbf{j} \text{ and } \mathbf{v}(0) = \frac{2}{3}\mathbf{i} - \frac{2}{3}\mathbf{j} + \frac{1}{3}\mathbf{k} \Rightarrow \mathbf{v}(0) \times \mathbf{a}(0)$$

$$= \begin{vmatrix} \mathbf{i} & \mathbf{j} & \mathbf{k} \\ \frac{2}{3} & -\frac{2}{3} & \frac{1}{3} \\ \frac{1}{3} & \frac{1}{3} & 0 \end{vmatrix} = -\frac{1}{9}\mathbf{i} + \frac{1}{9}\mathbf{j} + \frac{4}{9}\mathbf{k} \Rightarrow |\mathbf{v} \times \mathbf{a}| = \frac{\sqrt{2}}{3} \Rightarrow \kappa(0) = \frac{|\mathbf{v} \times \mathbf{a}|}{|\mathbf{v}|^3} = \frac{(\frac{\sqrt{2}}{3})}{1^3} = \frac{\sqrt{2}}{3};$$

$$\dot{\mathbf{a}} = -\frac{1}{6}(1+t)^{-3/2}\mathbf{i} + \frac{1}{6}(1-t)^{-3/2}\mathbf{j} \Rightarrow \dot{\mathbf{a}}(0) = -\frac{1}{6}\mathbf{i} + \frac{1}{6}\mathbf{j} \Rightarrow \tau(0) = \frac{\begin{vmatrix} \frac{2}{3} & -\frac{2}{3} & \frac{1}{3} \\ \frac{1}{3} & \frac{1}{3} & 0 \\ -\frac{1}{6} & \frac{1}{6} & 0 \end{vmatrix}}{|\mathbf{v} \times \mathbf{a}|^2} = \frac{(\frac{1}{3})(\frac{2}{18})}{(\frac{\sqrt{2}}{3})^2} = \frac{1}{6};$$

$$t = 0 \Rightarrow \left(\frac{4}{9}, \frac{4}{9}, 0 \right) \text{ is the point on the curve}$$

24. $\mathbf{r} = (e^t \sin 2t)\mathbf{i} + (e^t \cos 2t)\mathbf{j} + 2e^t\mathbf{k} \Rightarrow \mathbf{v} = (e^t \sin 2t + 2e^t \cos 2t)\mathbf{i} + (e^t \cos 2t - 2e^t \sin 2t)\mathbf{j} + 2e^t\mathbf{k}$
 $\Rightarrow |\mathbf{v}| = \sqrt{(e^t \sin 2t + 2e^t \cos 2t)^2 + (e^t \cos 2t - 2e^t \sin 2t)^2 + (2e^t)^2} = 3e^t \Rightarrow \mathbf{T} = \frac{\mathbf{v}}{|\mathbf{v}|}$
 $= \left(\frac{1}{3} \sin 2t + \frac{2}{3} \cos 2t\right)\mathbf{i} + \left(\frac{1}{3} \cos 2t - \frac{2}{3} \sin 2t\right)\mathbf{j} + \frac{2}{3}\mathbf{k} \Rightarrow \mathbf{T}(0) = \frac{2}{3}\mathbf{i} + \frac{1}{3}\mathbf{j} + \frac{2}{3}\mathbf{k}$;
 $\frac{d\mathbf{T}}{dt} = \left(\frac{2}{3} \cos 2t - \frac{4}{3} \sin 2t\right)\mathbf{i} + \left(-\frac{2}{3} \sin 2t - \frac{4}{3} \cos 2t\right)\mathbf{j} \Rightarrow \frac{d\mathbf{T}}{dt}(0) = \frac{2}{3}\mathbf{i} - \frac{4}{3}\mathbf{j} \Rightarrow \left|\frac{d\mathbf{T}}{dt}(0)\right| = \frac{2}{3}\sqrt{5}$
 $\Rightarrow \mathbf{N}(0) = \frac{\left(\frac{2}{3}\mathbf{i} - \frac{4}{3}\mathbf{j}\right)}{\left(\frac{2\sqrt{5}}{3}\right)} = \frac{1}{\sqrt{5}}\mathbf{i} - \frac{2}{\sqrt{5}}\mathbf{j}$; $\mathbf{B}(0) = \mathbf{T}(0) \times \mathbf{N}(0) = \begin{vmatrix} \mathbf{i} & \mathbf{j} & \mathbf{k} \\ \frac{2}{3} & \frac{1}{3} & \frac{2}{3} \\ \frac{1}{\sqrt{5}} & -\frac{2}{\sqrt{5}} & 0 \end{vmatrix} = \frac{4}{3\sqrt{5}}\mathbf{i} + \frac{2}{3\sqrt{5}}\mathbf{j} - \frac{5}{3\sqrt{5}}\mathbf{k}$;
 $\mathbf{a} = (4e^t \cos 2t - 3e^t \sin 2t)\mathbf{i} + (-3e^t \cos 2t - 4e^t \sin 2t)\mathbf{j} + 2e^t\mathbf{k} \Rightarrow \mathbf{a}(0) = 4\mathbf{i} - 3\mathbf{j} + 2\mathbf{k}$ and $\mathbf{v}(0) = 2\mathbf{i} + \mathbf{j} + 2\mathbf{k}$
 $\Rightarrow \mathbf{v}(0) \times \mathbf{a}(0) = \begin{vmatrix} \mathbf{i} & \mathbf{j} & \mathbf{k} \\ 2 & 1 & 2 \\ 4 & -3 & 2 \end{vmatrix} = 8\mathbf{i} + 4\mathbf{j} - 10\mathbf{k} \Rightarrow |\mathbf{v} \times \mathbf{a}| = \sqrt{64 + 16 + 100} = 6\sqrt{5}$ and $|\mathbf{v}(0)| = 3$
 $\Rightarrow \kappa(0) = \frac{6\sqrt{5}}{3^3} = \frac{2\sqrt{5}}{9}$;
 $\dot{\mathbf{a}} = (4e^t \cos 2t - 8e^t \sin 2t - 3e^t \sin 2t - 6e^t \cos 2t)\mathbf{i} + (-3e^t \cos 2t + 6e^t \sin 2t - 4e^t \sin 2t - 8e^t \cos 2t)\mathbf{j} + 2e^t\mathbf{k}$
 $= (-2e^t \cos 2t - 11e^t \sin 2t)\mathbf{i} + (-11e^t \cos 2t + 2e^t \sin 2t)\mathbf{j} + 2e^t\mathbf{k} \Rightarrow \dot{\mathbf{a}}(0) = -2\mathbf{i} - 11\mathbf{j} + 2\mathbf{k}$
 $\Rightarrow \tau(0) = \frac{\begin{vmatrix} 2 & 1 & 2 \\ 4 & -3 & 2 \\ -2 & -11 & 2 \end{vmatrix}}{|\mathbf{v} \times \mathbf{a}|^2} = \frac{-80}{180} = -\frac{4}{9}$; $t = 0 \Rightarrow (0, 1, 2)$ is on the curve
25. $\mathbf{r} = t\mathbf{i} + \frac{1}{2}e^{2t}\mathbf{j} \Rightarrow \mathbf{v} = \mathbf{i} + e^{2t}\mathbf{j} \Rightarrow |\mathbf{v}| = \sqrt{1 + e^{4t}} \Rightarrow \mathbf{T} = \frac{1}{\sqrt{1 + e^{4t}}}\mathbf{i} + \frac{e^{2t}}{\sqrt{1 + e^{4t}}}\mathbf{j} \Rightarrow \mathbf{T}(\ln 2) = \frac{1}{\sqrt{17}}\mathbf{i} + \frac{4}{\sqrt{17}}\mathbf{j}$;
 $\frac{d\mathbf{T}}{dt} = \frac{-2e^{4t}}{(1 + e^{4t})^{3/2}}\mathbf{i} + \frac{2e^{2t}}{(1 + e^{4t})^{3/2}}\mathbf{j} \Rightarrow \frac{d\mathbf{T}}{dt}(\ln 2) = \frac{-32}{17\sqrt{17}}\mathbf{i} + \frac{8}{17\sqrt{17}}\mathbf{j} \Rightarrow \mathbf{N}(\ln 2) = -\frac{4}{\sqrt{17}}\mathbf{i} + \frac{1}{\sqrt{17}}\mathbf{j}$;
 $\mathbf{B}(\ln 2) = \mathbf{T}(\ln 2) \times \mathbf{N}(\ln 2) = \begin{vmatrix} \mathbf{i} & \mathbf{j} & \mathbf{k} \\ \frac{1}{\sqrt{17}} & \frac{4}{\sqrt{17}} & 0 \\ -\frac{4}{\sqrt{17}} & \frac{1}{\sqrt{17}} & 0 \end{vmatrix} = \mathbf{k}$; $\mathbf{a} = 2e^{2t}\mathbf{j} \Rightarrow \mathbf{a}(\ln 2) = 8\mathbf{j}$ and $\mathbf{v}(\ln 2) = \mathbf{i} + 4\mathbf{j}$
 $\Rightarrow \mathbf{v}(\ln 2) \times \mathbf{a}(\ln 2) = \begin{vmatrix} \mathbf{i} & \mathbf{j} & \mathbf{k} \\ 1 & 4 & 0 \\ 0 & 8 & 0 \end{vmatrix} = 8\mathbf{k} \Rightarrow |\mathbf{v} \times \mathbf{a}| = 8$ and $|\mathbf{v}(\ln 2)| = \sqrt{17} \Rightarrow \kappa(\ln 2) = \frac{8}{17\sqrt{17}}$; $\dot{\mathbf{a}} = 4e^{2t}\mathbf{j}$
 $\Rightarrow \dot{\mathbf{a}}(\ln 2) = 16\mathbf{j} \Rightarrow \tau(\ln 2) = \frac{\begin{vmatrix} 1 & 4 & 0 \\ 0 & 8 & 0 \\ 0 & 16 & 0 \end{vmatrix}}{|\mathbf{v} \times \mathbf{a}|^2} = 0$; $t = \ln 2 \Rightarrow (\ln 2, 2, 0)$ is on the curve
26. $\mathbf{r} = (3 \cosh 2t)\mathbf{i} + (3 \sinh 2t)\mathbf{j} + 6t\mathbf{k} \Rightarrow \mathbf{v} = (6 \sinh 2t)\mathbf{i} + (6 \cosh 2t)\mathbf{j} + 6\mathbf{k}$
 $\Rightarrow |\mathbf{v}| = \sqrt{36 \sinh^2 2t + 36 \cosh^2 2t + 36} = 6\sqrt{2} \cosh 2t \Rightarrow \mathbf{T} = \frac{\mathbf{v}}{|\mathbf{v}|} = \left(\frac{1}{\sqrt{2}} \tanh 2t\right)\mathbf{i} + \frac{1}{\sqrt{2}}\mathbf{j} + \left(\frac{1}{\sqrt{2}} \operatorname{sech} 2t\right)\mathbf{k}$
 $\Rightarrow \mathbf{T}(\ln 2) = \frac{15}{17\sqrt{2}}\mathbf{i} + \frac{1}{\sqrt{2}}\mathbf{j} + \frac{8}{17\sqrt{2}}\mathbf{k}$; $\frac{d\mathbf{T}}{dt} = \left(\frac{2}{\sqrt{2}} \operatorname{sech}^2 2t\right)\mathbf{i} - \left(\frac{2}{\sqrt{2}} \operatorname{sech} 2t \tanh 2t\right)\mathbf{k} \Rightarrow \frac{d\mathbf{T}}{dt}(\ln 2)$
 $= \left(\frac{2}{\sqrt{2}}\right)\left(\frac{8}{17}\right)^2\mathbf{i} - \left(\frac{2}{\sqrt{2}}\right)\left(\frac{8}{17}\right)\left(\frac{15}{17}\right)\mathbf{k} = \frac{128}{289\sqrt{2}}\mathbf{i} - \frac{240}{289\sqrt{2}}\mathbf{k} \Rightarrow \left|\frac{d\mathbf{T}}{dt}(\ln 2)\right| = \sqrt{\left(\frac{128}{289\sqrt{2}}\right)^2 + \left(-\frac{240}{289\sqrt{2}}\right)^2} = \frac{8\sqrt{2}}{17}$
 $\Rightarrow \mathbf{N}(\ln 2) = \frac{8}{17}\mathbf{i} - \frac{15}{17}\mathbf{k}$; $\mathbf{B}(\ln 2) = \mathbf{T}(\ln 2) \times \mathbf{N}(\ln 2) = \begin{vmatrix} \mathbf{i} & \mathbf{j} & \mathbf{k} \\ \frac{15}{17\sqrt{2}} & \frac{1}{\sqrt{2}} & \frac{8}{17\sqrt{2}} \\ \frac{8}{17} & 0 & -\frac{15}{17} \end{vmatrix} = -\frac{15}{17\sqrt{2}}\mathbf{i} + \frac{1}{\sqrt{2}}\mathbf{j} - \frac{8}{17\sqrt{2}}\mathbf{k}$;
 $\mathbf{a} = (12 \cosh 2t)\mathbf{i} + (12 \sinh 2t)\mathbf{j} \Rightarrow \mathbf{a}(\ln 2) = 12\left(\frac{17}{8}\right)\mathbf{i} + 12\left(\frac{15}{8}\right)\mathbf{j} = \frac{51}{2}\mathbf{i} + \frac{45}{2}\mathbf{j}$ and
 $\mathbf{v}(\ln 2) = 6\left(\frac{15}{8}\right)\mathbf{i} + 6\left(\frac{17}{8}\right)\mathbf{j} + 6\mathbf{k} = \frac{45}{4}\mathbf{i} + \frac{51}{4}\mathbf{j} + 6\mathbf{k} \Rightarrow \mathbf{v}(\ln 2) \times \mathbf{a}(\ln 2) = \begin{vmatrix} \mathbf{i} & \mathbf{j} & \mathbf{k} \\ \frac{45}{4} & \frac{51}{4} & 6 \\ \frac{51}{2} & \frac{45}{2} & 0 \end{vmatrix}$
 $= -135\mathbf{i} + 153\mathbf{j} - 72\mathbf{k} \Rightarrow |\mathbf{v} \times \mathbf{a}| = 153\sqrt{2}$ and $|\mathbf{v}(\ln 2)| = \frac{51}{4}\sqrt{2} \Rightarrow \kappa(\ln 2) = \frac{153\sqrt{2}}{\left(\frac{51}{4}\sqrt{2}\right)^3} = \frac{32}{867}$;

$$\mathbf{a} = (24 \sinh 2t)\mathbf{i} + (24 \cosh 2t)\mathbf{j} \Rightarrow \mathbf{a}(\ln 2) = 45\mathbf{i} + 51\mathbf{j} \Rightarrow \tau(\ln 2) = \frac{\begin{vmatrix} \frac{45}{4} & \frac{51}{4} & 6 \\ \frac{51}{2} & \frac{45}{2} & 0 \\ 45 & 51 & 0 \end{vmatrix}}{|\mathbf{v} \times \mathbf{a}|^2} = \frac{32}{867};$$

$$t = \ln 2 \Rightarrow \left(\frac{51}{8}, \frac{45}{8}, 6 \ln 2\right) \text{ is on the curve}$$

27. $\mathbf{r} = (2 + 3t + 3t^2)\mathbf{i} + (4t + 4t^2)\mathbf{j} - (6 \cos t)\mathbf{k} \Rightarrow \mathbf{v} = (3 + 6t)\mathbf{i} + (4 + 8t)\mathbf{j} + (6 \sin t)\mathbf{k}$
 $\Rightarrow |\mathbf{v}| = \sqrt{(3 + 6t)^2 + (4 + 8t)^2 + (6 \sin t)^2} = \sqrt{25 + 100t + 100t^2 + 36 \sin^2 t}$
 $\Rightarrow \frac{d|\mathbf{v}|}{dt} = \frac{1}{2}(25 + 100t + 100t^2 + 36 \sin^2 t)^{-1/2}(100 + 200t + 72 \sin t \cos t) \Rightarrow a_T(0) = \frac{d|\mathbf{v}|}{dt}(0) = 10;$
 $\mathbf{a} = 6\mathbf{i} + 8\mathbf{j} + (6 \cos t)\mathbf{k} \Rightarrow |\mathbf{a}| = \sqrt{6^2 + 8^2 + (6 \cos t)^2} = \sqrt{100 + 36 \cos^2 t} \Rightarrow |\mathbf{a}(0)| = \sqrt{136}$
 $\Rightarrow a_N = \sqrt{|\mathbf{a}|^2 - a_T^2} = \sqrt{136 - 10^2} = \sqrt{36} = 6 \Rightarrow \mathbf{a}(0) = 10\mathbf{T} + 6\mathbf{N}$
28. $\mathbf{r} = (2 + t)\mathbf{i} + (t + 2t^2)\mathbf{j} + (1 + t^2)\mathbf{k} \Rightarrow \mathbf{v} = \mathbf{i} + (1 + 4t)\mathbf{j} + 2t\mathbf{k} \Rightarrow |\mathbf{v}| = \sqrt{1^2 + (1 + 4t)^2 + (2t)^2}$
 $= \sqrt{2 + 8t + 20t^2} \Rightarrow \frac{d|\mathbf{v}|}{dt} = \frac{1}{2}(2 + 8t + 20t^2)^{-1/2}(8 + 40t) \Rightarrow a_T = \frac{d|\mathbf{v}|}{dt}(0) = 2\sqrt{2}; \mathbf{a} = 4\mathbf{j} + 2\mathbf{k}$
 $\Rightarrow |\mathbf{a}| = \sqrt{4^2 + 2^2} = \sqrt{20} \Rightarrow a_N = \sqrt{|\mathbf{a}|^2 - a_T^2} = \sqrt{20 - (2\sqrt{2})^2} = \sqrt{12} = 2\sqrt{3} \Rightarrow \mathbf{a}(0) = 2\sqrt{2}\mathbf{T} + 2\sqrt{3}\mathbf{N}$
29. $\mathbf{r} = (\sin t)\mathbf{i} + (\sqrt{2} \cos t)\mathbf{j} + (\sin t)\mathbf{k} \Rightarrow \mathbf{v} = (\cos t)\mathbf{i} - (\sqrt{2} \sin t)\mathbf{j} + (\cos t)\mathbf{k}$
 $\Rightarrow |\mathbf{v}| = \sqrt{(\cos t)^2 + (-\sqrt{2} \sin t)^2 + (\cos t)^2} = \sqrt{2} \Rightarrow \mathbf{T} = \frac{\mathbf{v}}{|\mathbf{v}|} = \left(\frac{1}{\sqrt{2}} \cos t\right)\mathbf{i} - (\sin t)\mathbf{j} + \left(\frac{1}{\sqrt{2}} \cos t\right)\mathbf{k};$
 $\frac{d\mathbf{T}}{dt} = \left(-\frac{1}{\sqrt{2}} \sin t\right)\mathbf{i} - (\cos t)\mathbf{j} - \left(\frac{1}{\sqrt{2}} \sin t\right)\mathbf{k} \Rightarrow \left|\frac{d\mathbf{T}}{dt}\right| = \sqrt{\left(-\frac{1}{\sqrt{2}} \sin t\right)^2 + (-\cos t)^2 + \left(-\frac{1}{\sqrt{2}} \sin t\right)^2} = 1$
 $\Rightarrow \mathbf{N} = \frac{d\mathbf{T}}{|\frac{d\mathbf{T}}{dt}|} = \left(-\frac{1}{\sqrt{2}} \sin t\right)\mathbf{i} - (\cos t)\mathbf{j} - \left(\frac{1}{\sqrt{2}} \sin t\right)\mathbf{k}; \mathbf{B} = \mathbf{T} \times \mathbf{N} = \begin{vmatrix} \mathbf{i} & \mathbf{j} & \mathbf{k} \\ \frac{1}{\sqrt{2}} \cos t & -\sin t & \frac{1}{\sqrt{2}} \cos t \\ -\frac{1}{\sqrt{2}} \sin t & -\cos t & -\frac{1}{\sqrt{2}} \sin t \end{vmatrix}$
 $= \frac{1}{\sqrt{2}}\mathbf{i} - \frac{1}{\sqrt{2}}\mathbf{k}; \mathbf{a} = (-\sin t)\mathbf{i} - (\sqrt{2} \cos t)\mathbf{j} - (\sin t)\mathbf{k} \Rightarrow \mathbf{v} \times \mathbf{a} = \begin{vmatrix} \mathbf{i} & \mathbf{j} & \mathbf{k} \\ \cos t & -\sqrt{2} \sin t & \cos t \\ -\sin t & -\sqrt{2} \cos t & -\sin t \end{vmatrix}$
 $= \sqrt{2}\mathbf{i} - \sqrt{2}\mathbf{k} \Rightarrow |\mathbf{v} \times \mathbf{a}| = \sqrt{4} = 2 \Rightarrow \kappa = \frac{|\mathbf{v} \times \mathbf{a}|}{|\mathbf{v}|^3} = \frac{2}{(\sqrt{2})^3} = \frac{1}{\sqrt{2}}; \mathbf{a} = (-\cos t)\mathbf{i} + (\sqrt{2} \sin t)\mathbf{j} - (\cos t)\mathbf{k}$
 $\Rightarrow \tau = \frac{\begin{vmatrix} \cos t & -\sqrt{2} \sin t & \cos t \\ -\sin t & -\sqrt{2} \cos t & -\sin t \\ -\cos t & \sqrt{2} \sin t & -\cos t \end{vmatrix}}{|\mathbf{v} \times \mathbf{a}|^2} = \frac{(\cos t)(\sqrt{2}) - (\sqrt{2} \sin t)(0) + (\cos t)(-\sqrt{2})}{4} = 0$
30. $\mathbf{r} = \mathbf{i} + (5 \cos t)\mathbf{j} + (3 \sin t)\mathbf{k} \Rightarrow \mathbf{v} = (-5 \sin t)\mathbf{j} + (3 \cos t)\mathbf{k} \Rightarrow \mathbf{a} = (-5 \cos t)\mathbf{j} - (3 \sin t)\mathbf{k}$
 $\Rightarrow \mathbf{v} \cdot \mathbf{a} = 25 \sin t \cos t - 9 \sin t \cos t = 16 \sin t \cos t; \mathbf{v} \cdot \mathbf{a} = 0 \Rightarrow 16 \sin t \cos t = 0 \Rightarrow \sin t = 0 \text{ or } \cos t = 0$
 $\Rightarrow t = 0, \frac{\pi}{2} \text{ or } \pi$
31. $\mathbf{r} = 2\mathbf{i} + (4 \sin \frac{1}{2}t)\mathbf{j} + (3 - \frac{1}{\pi}t)\mathbf{k} \Rightarrow 0 = \mathbf{r} \cdot (\mathbf{i} - \mathbf{j}) = 2(1) + (4 \sin \frac{1}{2}t)(-1) \Rightarrow 0 = 2 - 4 \sin \frac{1}{2}t \Rightarrow \sin \frac{1}{2}t = \frac{1}{2} \Rightarrow \frac{1}{2}t = \frac{\pi}{6}$
 $\Rightarrow t = \frac{\pi}{3} \text{ (for the first time)}$
32. $\mathbf{r}(t) = t\mathbf{i} + t^2\mathbf{j} + t^3\mathbf{k} \Rightarrow \mathbf{v} = \mathbf{i} + 2t\mathbf{j} + 3t^2\mathbf{k} \Rightarrow |\mathbf{v}| = \sqrt{1 + 4t^2 + 9t^4} \Rightarrow |\mathbf{v}(1)| = \sqrt{14}$
 $\Rightarrow \mathbf{T}(1) = \frac{1}{\sqrt{14}}\mathbf{i} + \frac{2}{\sqrt{14}}\mathbf{j} + \frac{3}{\sqrt{14}}\mathbf{k}$, which is normal to the normal plane
 $\Rightarrow \frac{1}{\sqrt{14}}(x - 1) + \frac{2}{\sqrt{14}}(y - 1) + \frac{3}{\sqrt{14}}(z - 1) = 0$ or $x + 2y + 3z = 6$ is an equation of the normal plane. Next we calculate $\mathbf{N}(1)$ which is normal to the rectifying plane. Now, $\mathbf{a} = 2\mathbf{j} + 6t\mathbf{k} \Rightarrow \mathbf{a}(1) = 2\mathbf{j} + 6\mathbf{k} \Rightarrow \mathbf{v}(1) \times \mathbf{a}(1)$

$$\begin{aligned}
&= \begin{vmatrix} \mathbf{i} & \mathbf{j} & \mathbf{k} \\ 1 & 2 & 3 \\ 0 & 2 & 6 \end{vmatrix} = 6\mathbf{i} - 6\mathbf{j} + 2\mathbf{k} \Rightarrow |\mathbf{v}(1) \times \mathbf{a}(1)| = \sqrt{76} \Rightarrow \kappa(1) = \frac{\sqrt{76}}{(\sqrt{14})^3} = \frac{\sqrt{19}}{7\sqrt{14}}; \frac{ds}{dt} = |\mathbf{v}(t)| \Rightarrow \left. \frac{d^2s}{dt^2} \right|_{t=1} \\
&= \frac{1}{2} (1 + 4t^2 + 9t^4)^{-1/2} (8t + 36t^3) \Big|_{t=1} = \frac{22}{\sqrt{14}}, \text{ so } \mathbf{a} = \frac{d^2s}{dt^2} \mathbf{T} + \kappa \left(\frac{ds}{dt} \right)^2 \mathbf{N} \Rightarrow 2\mathbf{j} + 6\mathbf{k} \\
&= \frac{22}{\sqrt{14}} \left(\frac{\mathbf{i} + 2\mathbf{j} + 3\mathbf{k}}{\sqrt{14}} \right) + \frac{\sqrt{19}}{7\sqrt{14}} (\sqrt{14})^2 \mathbf{N} \Rightarrow \mathbf{N} = \frac{\sqrt{14}}{2\sqrt{19}} \left(-\frac{11}{7}\mathbf{i} - \frac{8}{7}\mathbf{j} + \frac{9}{7}\mathbf{k} \right) \Rightarrow -\frac{11}{7}(x-1) - \frac{8}{7}(y-1) + \frac{9}{7}(z-1) \\
&= 0 \text{ or } 11x + 8y - 9z = 10 \text{ is an equation of the rectifying plane. Finally, } \mathbf{B}(1) = \mathbf{T}(1) \times \mathbf{N}(1) \\
&= \left(\frac{\sqrt{14}}{2\sqrt{19}} \right) \left(\frac{1}{\sqrt{14}} \right) \left(\frac{1}{7} \right) \begin{vmatrix} \mathbf{i} & \mathbf{j} & \mathbf{k} \\ 1 & 2 & 3 \\ -11 & -8 & 9 \end{vmatrix} = \frac{1}{\sqrt{19}} (3\mathbf{i} - 3\mathbf{j} + \mathbf{k}) \Rightarrow 3(x-1) - 3(y-1) + (z-1) = 0 \text{ or } 3x - 3y + z \\
&= 1 \text{ is an equation of the osculating plane.}
\end{aligned}$$

33. $\mathbf{r} = e^t \mathbf{i} + (\sin t) \mathbf{j} + \ln(1-t) \mathbf{k} \Rightarrow \mathbf{v} = e^t \mathbf{i} + (\cos t) \mathbf{j} - \left(\frac{1}{1-t} \right) \mathbf{k} \Rightarrow \mathbf{v}(0) = \mathbf{i} + \mathbf{j} - \mathbf{k}; \mathbf{r}(0) = \mathbf{i} \Rightarrow (1, 0, 0)$ is on the line
 $\Rightarrow x = 1 + t, y = t, \text{ and } z = -t$ are parametric equations of the line

34. $\mathbf{r} = (\sqrt{2} \cos t) \mathbf{i} + (\sqrt{2} \sin t) \mathbf{j} + t \mathbf{k} \Rightarrow \mathbf{v} = (-\sqrt{2} \sin t) \mathbf{i} + (\sqrt{2} \cos t) \mathbf{j} + \mathbf{k} \Rightarrow \mathbf{v} \left(\frac{\pi}{4} \right)$
 $= (-\sqrt{2} \sin \frac{\pi}{4}) \mathbf{i} + (\sqrt{2} \cos \frac{\pi}{4}) \mathbf{j} + \mathbf{k} = -\mathbf{i} + \mathbf{j} + \mathbf{k}$ is a vector tangent to the helix when $t = \frac{\pi}{4} \Rightarrow$ the tangent line
is parallel to $\mathbf{v} \left(\frac{\pi}{4} \right)$; also $\mathbf{r} \left(\frac{\pi}{4} \right) = (\sqrt{2} \cos \frac{\pi}{4}) \mathbf{i} + (\sqrt{2} \sin \frac{\pi}{4}) \mathbf{j} + \frac{\pi}{4} \mathbf{k} \Rightarrow$ the point $(1, 1, \frac{\pi}{4})$ is on the line
 $\Rightarrow x = 1 - t, y = 1 + t, \text{ and } z = \frac{\pi}{4} + t$ are parametric equations of the line

35. (a) $\Delta SOT \approx \Delta TOD \Rightarrow \frac{DO}{OT} = \frac{OT}{SO} \Rightarrow \frac{y_0}{6380} = \frac{6380}{6380+437}$

$$\Rightarrow y_0 = \frac{6380^2}{6817} \Rightarrow y_0 \approx 5971 \text{ km};$$

(b) $VA = \int_{5971}^{6380} 2\pi x \sqrt{1 + \left(\frac{dx}{dy} \right)^2} dy$

$$= 2\pi \int_{5971}^{6380} \sqrt{6380^2 - y^2} \left(\frac{6380}{\sqrt{6380^2 - y^2}} \right) dy$$

$$= 2\pi \int_{5971}^{6380} 6380 dy = 2\pi [6380y]_{5971}^{6380}$$

$$= 16,395,469 \text{ km}^2 \approx 1.639 \times 10^7 \text{ km}^2;$$

(c) percentage visible $\approx \frac{16,395,469 \text{ km}^2}{4\pi(6380 \text{ km})^2} \approx 3.21\%$

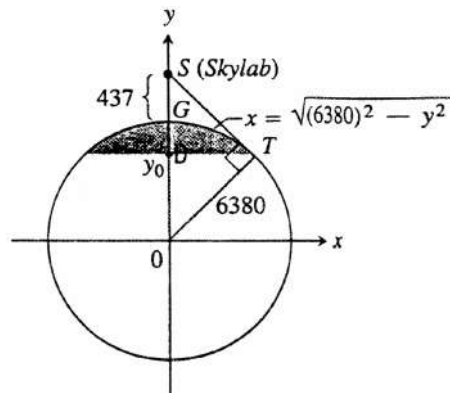

CHAPTER 13 ADDITIONAL AND ADVANCED EXERCISES

- (a) The velocity of the boat at (x, y) relative to land is the sum of the velocity due to the rower and the velocity of the river, or $\mathbf{v} = \left[-\frac{1}{250} (y-50)^2 + 10 \right] \mathbf{i} - 20\mathbf{j}$. Now, $\frac{dy}{dt} = -20 \Rightarrow y = -20t + c; y(0) = 100$
 $\Rightarrow c = 100 \Rightarrow y = -20t + 100 \Rightarrow \mathbf{v} = \left[-\frac{1}{250} (-20t + 50)^2 + 10 \right] \mathbf{i} - 20\mathbf{j} = \left(-\frac{8}{5} t^2 + 8t \right) \mathbf{i} - 20\mathbf{j}$
 $\Rightarrow \mathbf{r}(t) = \left(-\frac{8}{15} t^3 + 4t^2 \right) \mathbf{i} - 20t\mathbf{j} + \mathbf{C}_1; \mathbf{r}(0) = 0\mathbf{i} + 100\mathbf{j} \Rightarrow 100\mathbf{j} = \mathbf{C}_1 \Rightarrow \mathbf{r}(t)$
 $= \left(-\frac{8}{15} t^3 + 4t^2 \right) \mathbf{i} + (100 - 20t)\mathbf{j}$

(b) The boat reaches the shore when $y = 0 \Rightarrow 0 = -20t + 100$ from part (a) $\Rightarrow t = 5$
 $\Rightarrow \mathbf{r}(5) = \left(-\frac{8}{15} \cdot 125 + 4 \cdot 25 \right) \mathbf{i} + (100 - 20 \cdot 5)\mathbf{j} = \left(-\frac{200}{3} + 100 \right) \mathbf{i} = \frac{100}{3} \mathbf{i}$; the distance downstream is therefore $\frac{100}{3}$ m
- (a) Let $a\mathbf{i} + b\mathbf{j}$ be the velocity of the boat. The velocity of the boat relative to an observer on the bank of the river is $\mathbf{v} = a\mathbf{i} + \left[b - \frac{3x(20-x)}{100} \right] \mathbf{j}$. The distance x of the boat as it crosses the river is related to time by
 $x = at \Rightarrow \mathbf{v} = a\mathbf{i} + \left[b - \frac{3at(20-at)}{100} \right] \mathbf{j} = a\mathbf{i} + \left(b + \frac{3a^2t^2 - 60at}{100} \right) \mathbf{j} \Rightarrow \mathbf{r}(t) = at\mathbf{i} + \left(bt + \frac{a^2t^3}{100} - \frac{30at^2}{100} \right) \mathbf{j} + \mathbf{C}$;

$\mathbf{r}(0) = 0\mathbf{i} + 0\mathbf{j} \Rightarrow \mathbf{C} = 0 \Rightarrow \mathbf{r}(t) = at\mathbf{i} + \left(bt + \frac{a^2t^3 - 30at^2}{100}\right)\mathbf{j}$. The boat reaches the shore when $x = 20$
 $\Rightarrow 20 = at \Rightarrow t = \frac{20}{a}$ and $y = 0 \Rightarrow 0 = b\left(\frac{20}{a}\right) + \frac{a^2\left(\frac{20}{a}\right)^3 - 30a\left(\frac{20}{a}\right)^2}{100} = \frac{20b}{a} + \frac{(20)^3 - 30(20)^2}{100a}$
 $= \frac{2000b + 8000 - 12,000}{100a} \Rightarrow b = 2$; the speed of the boat is $\sqrt{20} = |\mathbf{v}| = \sqrt{a^2 + b^2} = \sqrt{a^2 + 4} \Rightarrow a^2 = 16$
 $\Rightarrow a = 4$; thus, $\mathbf{v} = 4\mathbf{i} + 2\mathbf{j}$ is the velocity of the boat

(b) $\mathbf{r}(t) = at\mathbf{i} + \left(bt + \frac{a^2t^3 - 30at^2}{100}\right)\mathbf{j} = 4t\mathbf{i} + \left(2t + \frac{16t^3}{100} - \frac{120t^2}{100}\right)\mathbf{j}$ by part (a), where $0 \leq t \leq 5$

(c) $x = 4t$ and $y = 2t + \frac{16t^3}{100} - \frac{120t^2}{100}$
 $= \frac{4}{25}t^3 - \frac{6}{5}t^2 + 2t = \frac{2}{25}t(2t^2 - 15t + 25)$
 $= \frac{2}{25}t(2t - 5)(t - 5)$, which is the graph of the cubic displayed here

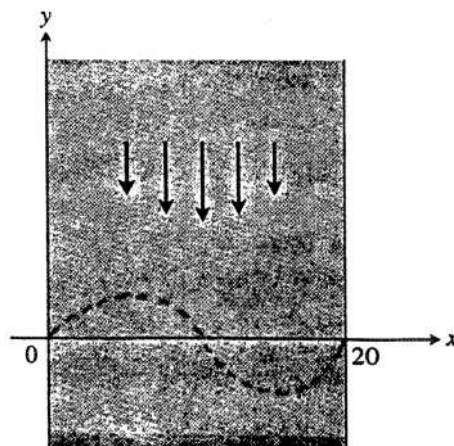

3. (a) $\mathbf{r}(\theta) = (a \cos \theta)\mathbf{i} + (a \sin \theta)\mathbf{j} + b\theta\mathbf{k} \Rightarrow \frac{d\mathbf{r}}{dt} = [(-a \sin \theta)\mathbf{i} + (a \cos \theta)\mathbf{j} + b\mathbf{k}] \frac{d\theta}{dt}$; $|\mathbf{v}| = \sqrt{2gz} = \left|\frac{d\mathbf{r}}{dt}\right|$
 $= \sqrt{a^2 + b^2} \frac{d\theta}{dt} \Rightarrow \frac{d\theta}{dt} = \sqrt{\frac{2gz}{a^2 + b^2}} = \sqrt{\frac{2gb\theta}{a^2 + b^2}} \Rightarrow \frac{d\theta}{dt} \Big|_{\theta=2\pi} = \sqrt{\frac{4\pi gb}{a^2 + b^2}} = 2\sqrt{\frac{\pi gb}{a^2 + b^2}}$

(b) $\frac{d\theta}{dt} = \sqrt{\frac{2gb\theta}{a^2 + b^2}} \Rightarrow \frac{d\theta}{\sqrt{\theta}} = \sqrt{\frac{2gb}{a^2 + b^2}} dt \Rightarrow 2\theta^{1/2} = \sqrt{\frac{2gb}{a^2 + b^2}} t + C$; $t = 0 \Rightarrow \theta = 0 \Rightarrow C = 0$
 $\Rightarrow 2\theta^{1/2} = \sqrt{\frac{2gb}{a^2 + b^2}} t \Rightarrow \theta = \frac{gbt^2}{2(a^2 + b^2)}$; $z = b\theta \Rightarrow z = \frac{gb^2t^2}{2(a^2 + b^2)}$

(c) $\mathbf{v}(t) = \frac{d\mathbf{r}}{dt} = [(-a \sin \theta)\mathbf{i} + (a \cos \theta)\mathbf{j} + b\mathbf{k}] \frac{d\theta}{dt} = [(-a \sin \theta)\mathbf{i} + (a \cos \theta)\mathbf{j} + b\mathbf{k}] \left(\frac{gbt}{a^2 + b^2}\right)$, from part (b)
 $\Rightarrow \mathbf{v}(t) = \left[\frac{(-a \sin \theta)\mathbf{i} + (a \cos \theta)\mathbf{j} + b\mathbf{k}}{\sqrt{a^2 + b^2}}\right] \left(\frac{gbt}{\sqrt{a^2 + b^2}}\right) = \frac{gbt}{\sqrt{a^2 + b^2}} \mathbf{T}$;
 $\frac{d^2\mathbf{r}}{dt^2} = [(-a \cos \theta)\mathbf{i} - (a \sin \theta)\mathbf{j}] \left(\frac{d\theta}{dt}\right)^2 + [(-a \sin \theta)\mathbf{i} + (a \cos \theta)\mathbf{j} + b\mathbf{k}] \frac{d^2\theta}{dt^2}$
 $= \left(\frac{gbt}{a^2 + b^2}\right)^2 [(-a \cos \theta)\mathbf{i} - (a \sin \theta)\mathbf{j}] + [(-a \sin \theta)\mathbf{i} + (a \cos \theta)\mathbf{j} + b\mathbf{k}] \left(\frac{gb}{a^2 + b^2}\right)$
 $= \left[\frac{(-a \sin \theta)\mathbf{i} + (a \cos \theta)\mathbf{j} + b\mathbf{k}}{\sqrt{a^2 + b^2}}\right] \left(\frac{gb}{\sqrt{a^2 + b^2}}\right) + a \left(\frac{gbt}{a^2 + b^2}\right)^2 [(-\cos \theta)\mathbf{i} - (\sin \theta)\mathbf{j}]$
 $= \frac{gb}{\sqrt{a^2 + b^2}} \mathbf{T} + a \left(\frac{gbt}{a^2 + b^2}\right)^2 \mathbf{N}$ (there is no component in the direction of \mathbf{B}).

4. (a) $\mathbf{r}(\theta) = (a\theta \cos \theta)\mathbf{i} + (a\theta \sin \theta)\mathbf{j} + b\theta\mathbf{k} \Rightarrow \frac{d\mathbf{r}}{dt} = [(a \cos \theta - a\theta \sin \theta)\mathbf{i} + (a \sin \theta + a\theta \cos \theta)\mathbf{j} + b\mathbf{k}] \frac{d\theta}{dt}$;
 $|\mathbf{v}| = \sqrt{2gz} = \left|\frac{d\mathbf{r}}{dt}\right| = (a^2 + a^2\theta^2 + b^2)^{1/2} \left(\frac{d\theta}{dt}\right) \Rightarrow \frac{d\theta}{dt} = \frac{\sqrt{2gb\theta}}{\sqrt{a^2 + a^2\theta^2 + b^2}}$

(b) $s = \int_0^t |\mathbf{v}| dt = \int_0^t (a^2 + a^2\theta^2 + b^2)^{1/2} \frac{d\theta}{dt} dt = \int_0^\theta (a^2 + a^2\theta^2 + b^2)^{1/2} d\theta = \int_0^\theta (a^2 + a^2u^2 + b^2)^{1/2} du$
 $= \int_0^\theta a \sqrt{\frac{a^2 + b^2}{a^2} + u^2} du = a \int_0^\theta \sqrt{c^2 + u^2} du$, where $c = \frac{\sqrt{a^2 + b^2}}{|a|}$
 $\Rightarrow s = a \left[\frac{u}{2} \sqrt{c^2 + u^2} + \frac{c^2}{2} \ln \left| u + \sqrt{c^2 + u^2} \right| \right]_0^\theta = \frac{a}{2} \left(\theta \sqrt{c^2 + \theta^2} + c^2 \ln \left| \theta + \sqrt{c^2 + \theta^2} \right| - c^2 \ln c \right)$

5. $\mathbf{r} = \frac{(1+e)r_0}{1+e \cos \theta} \Rightarrow \frac{d\mathbf{r}}{d\theta} = \frac{(1+e)r_0(e \sin \theta)}{(1+e \cos \theta)^2}$; $\frac{d\mathbf{r}}{dt} = 0 \Rightarrow \frac{(1+e)r_0(e \sin \theta)}{(1+e \cos \theta)^2} = 0 \Rightarrow (1+e)r_0(e \sin \theta) = 0$
 $\Rightarrow \sin \theta = 0 \Rightarrow \theta = 0$ or π . Note that $\frac{d\mathbf{r}}{d\theta} > 0$ when $\sin \theta > 0$ and $\frac{d\mathbf{r}}{d\theta} < 0$ when $\sin \theta < 0$. Since $\sin \theta < 0$ on $-\pi < \theta < 0$ and $\sin \theta > 0$ on $0 < \theta < \pi$, \mathbf{r} is a minimum when $\theta = 0$ and $\mathbf{r}(0) = \frac{(1+e)r_0}{1+e \cos 0} = r_0$

6. (a) $f(x) = x - 1 - \frac{1}{2} \sin x = 0 \Rightarrow f(0) = -1$ and $f(2) = 2 - 1 - \frac{1}{2} \sin 2 \geq \frac{1}{2}$ since $|\sin 2| \leq 1$; since f is continuous on $[0, 2]$, the Intermediate Value Theorem implies there is a root between 0 and 2
 (b) Root ≈ 1.4987011335179

7. (a) $\mathbf{v} = \frac{dx}{dt} \mathbf{i} + \frac{dy}{dt} \mathbf{j}$ and $\mathbf{v} = \frac{dr}{dt} \mathbf{u}_r + r \frac{d\theta}{dt} \mathbf{u}_\theta = \left(\frac{dr}{dt}\right) [(\cos \theta)\mathbf{i} + (\sin \theta)\mathbf{j}] + \left(r \frac{d\theta}{dt}\right) [(-\sin \theta)\mathbf{i} + (\cos \theta)\mathbf{j}] \Rightarrow \mathbf{v} \cdot \mathbf{i} = \frac{dx}{dt}$ and $\mathbf{v} \cdot \mathbf{j} = \frac{dy}{dt}$
 $\mathbf{v} \cdot \mathbf{i} = \frac{dr}{dt} \cos \theta - r \frac{d\theta}{dt} \sin \theta \Rightarrow \frac{dx}{dt} = \frac{dr}{dt} \cos \theta - r \frac{d\theta}{dt} \sin \theta$; $\mathbf{v} \cdot \mathbf{j} = \frac{dy}{dt}$ and $\mathbf{v} \cdot \mathbf{j} = \frac{dr}{dt} \sin \theta + r \frac{d\theta}{dt} \cos \theta$
 $\Rightarrow \frac{dy}{dt} = \frac{dr}{dt} \sin \theta + r \frac{d\theta}{dt} \cos \theta$
 (b) $\mathbf{u}_r = (\cos \theta)\mathbf{i} + (\sin \theta)\mathbf{j} \Rightarrow \mathbf{v} \cdot \mathbf{u}_r = \frac{dx}{dt} \cos \theta + \frac{dy}{dt} \sin \theta$
 $= \left(\frac{dr}{dt} \cos \theta - r \frac{d\theta}{dt} \sin \theta\right) (\cos \theta) + \left(\frac{dr}{dt} \sin \theta + r \frac{d\theta}{dt} \cos \theta\right) (\sin \theta)$ by part (a),
 $\Rightarrow \mathbf{v} \cdot \mathbf{u}_r = \frac{dr}{dt}$; therefore, $\frac{dr}{dt} = \frac{dx}{dt} \cos \theta + \frac{dy}{dt} \sin \theta$;
 $\mathbf{u}_\theta = -(\sin \theta)\mathbf{i} + (\cos \theta)\mathbf{j} \Rightarrow \mathbf{v} \cdot \mathbf{u}_\theta = -\frac{dx}{dt} \sin \theta + \frac{dy}{dt} \cos \theta$
 $= \left(\frac{dr}{dt} \cos \theta - r \frac{d\theta}{dt} \sin \theta\right) (-\sin \theta) + \left(\frac{dr}{dt} \sin \theta + r \frac{d\theta}{dt} \cos \theta\right) (\cos \theta)$ by part (a) $\Rightarrow \mathbf{v} \cdot \mathbf{u}_\theta = r \frac{d\theta}{dt}$;
 therefore, $r \frac{d\theta}{dt} = -\frac{dx}{dt} \sin \theta + \frac{dy}{dt} \cos \theta$

8. $\mathbf{r} = f(\theta) \Rightarrow \frac{dr}{dt} = f'(\theta) \frac{d\theta}{dt} \Rightarrow \frac{d^2r}{dt^2} = f''(\theta) \left(\frac{d\theta}{dt}\right)^2 + f'(\theta) \frac{d^2\theta}{dt^2}$; $\mathbf{v} = \frac{dr}{dt} \mathbf{u}_r + r \frac{d\theta}{dt} \mathbf{u}_\theta$
 $= \left(\cos \theta \frac{dr}{dt} - r \sin \theta \frac{d\theta}{dt}\right) \mathbf{i} + \left(\sin \theta \frac{dr}{dt} + r \cos \theta \frac{d\theta}{dt}\right) \mathbf{j} \Rightarrow |\mathbf{v}| = \left[\left(\frac{dr}{dt}\right)^2 + r^2 \left(\frac{d\theta}{dt}\right)^2\right]^{1/2} = \left[(f')^2 + f^2\right]^{1/2} \left(\frac{d\theta}{dt}\right)$;
 $|\mathbf{v} \times \mathbf{a}| = |\dot{x}\dot{y} - \dot{y}\dot{x}|$, where $x = r \cos \theta$ and $y = r \sin \theta$. Then $\frac{dx}{dt} = (-r \sin \theta) \frac{d\theta}{dt} + (\cos \theta) \frac{dr}{dt}$
 $\Rightarrow \frac{d^2x}{dt^2} = (-2 \sin \theta) \frac{d\theta}{dt} \frac{dr}{dt} - (r \cos \theta) \left(\frac{d\theta}{dt}\right)^2 - (r \sin \theta) \frac{d^2\theta}{dt^2} + (\cos \theta) \frac{d^2r}{dt^2}$; $\frac{dy}{dt} = (r \cos \theta) \frac{d\theta}{dt} + (\sin \theta) \frac{dr}{dt}$
 $\Rightarrow \frac{d^2y}{dt^2} = (2 \cos \theta) \frac{d\theta}{dt} \frac{dr}{dt} - (r \sin \theta) \left(\frac{d\theta}{dt}\right)^2 + (r \cos \theta) \frac{d^2\theta}{dt^2} + (\sin \theta) \frac{d^2r}{dt^2}$. Then $|\mathbf{v} \times \mathbf{a}|$
 $=$ (after much algebra) $r^2 \left(\frac{d\theta}{dt}\right)^3 + r \frac{d^2\theta}{dt^2} \frac{dr}{dt} - r \frac{d\theta}{dt} \frac{d^2r}{dt^2} + 2 \frac{d\theta}{dt} \left(\frac{dr}{dt}\right)^2 = \left(\frac{d\theta}{dt}\right)^3 \left(f^2 - f \cdot f'' + 2(f')^2\right)$
 $\Rightarrow \kappa = \frac{|\mathbf{v} \times \mathbf{a}|}{|\mathbf{v}|^3} = \frac{f^2 - f \cdot f'' + 2(f')^2}{[(f')^2 + f^2]^{3/2}}$

9. (a) Let $r = 2 - t$ and $\theta = 3t \Rightarrow \frac{dr}{dt} = -1$ and $\frac{d\theta}{dt} = 3 \Rightarrow \frac{d^2r}{dt^2} = \frac{d^2\theta}{dt^2} = 0$. The halfway point is $(1, 3) \Rightarrow t = 1$;
 $\mathbf{v} = \frac{dr}{dt} \mathbf{u}_r + r \frac{d\theta}{dt} \mathbf{u}_\theta \Rightarrow \mathbf{v}(1) = -\mathbf{u}_r + 3\mathbf{u}_\theta$; $\mathbf{a} = \left[\frac{d^2r}{dt^2} - r \left(\frac{d\theta}{dt}\right)^2\right] \mathbf{u}_r + \left[r \frac{d^2\theta}{dt^2} + 2 \frac{dr}{dt} \frac{d\theta}{dt}\right] \mathbf{u}_\theta \Rightarrow \mathbf{a}(1) = -9\mathbf{u}_r - 6\mathbf{u}_\theta$
 (b) It takes the beetle 2 min to crawl to the origin \Rightarrow the rod has revolved 6 radians
 $\Rightarrow L = \int_0^6 \sqrt{[f(\theta)]^2 + [f'(\theta)]^2} d\theta = \int_0^6 \sqrt{\left(2 - \frac{\theta}{3}\right)^2 + \left(-\frac{1}{3}\right)^2} d\theta = \int_0^6 \sqrt{4 - \frac{4\theta}{3} + \frac{\theta^2}{9} + \frac{1}{9}} d\theta$
 $= \int_0^6 \sqrt{\frac{37 - 12\theta + \theta^2}{9}} d\theta = \frac{1}{3} \int_0^6 \sqrt{(\theta - 6)^2 + 1} d\theta = \frac{1}{3} \left[\frac{(\theta - 6)}{2} \sqrt{(\theta - 6)^2 + 1} + \frac{1}{2} \ln |\theta - 6 + \sqrt{(\theta - 6)^2 + 1}|\right]_0^6$
 $= \sqrt{37} - \frac{1}{6} \ln(\sqrt{37} - 6) \approx 6.5$ in.

10. $\mathbf{L}(t) = \mathbf{r}(t) \times m\mathbf{v}(t) \Rightarrow \frac{d\mathbf{L}}{dt} = \left(\frac{d\mathbf{r}}{dt} \times m\mathbf{v}\right) + \left(\mathbf{r} \times m \frac{d^2\mathbf{r}}{dt^2}\right) \Rightarrow \frac{d\mathbf{L}}{dt} = (\mathbf{v} \times m\mathbf{v}) + (\mathbf{r} \times m\mathbf{a}) = \mathbf{r} \times m\mathbf{a}$; $\mathbf{F} = m\mathbf{a} \Rightarrow -\frac{c}{|\mathbf{r}|^3} \mathbf{r}$
 $= m\mathbf{a} \Rightarrow \frac{d\mathbf{L}}{dt} = \mathbf{r} \times m\mathbf{a} = \mathbf{r} \times \left(-\frac{c}{|\mathbf{r}|^3} \mathbf{r}\right) = -\frac{c}{|\mathbf{r}|^3} (\mathbf{r} \times \mathbf{r}) = \mathbf{0} \Rightarrow \mathbf{L} = \text{constant vector}$

11. (a) $\mathbf{u}_r \times \mathbf{u}_\theta = \begin{vmatrix} \mathbf{i} & \mathbf{j} & \mathbf{k} \\ \cos \theta & \sin \theta & 0 \\ -\sin \theta & \cos \theta & 0 \end{vmatrix} = \mathbf{k} \Rightarrow$ a right-handed frame of unit vectors

(b) $\frac{d\mathbf{u}_r}{d\theta} = (-\sin \theta)\mathbf{i} + (\cos \theta)\mathbf{j} = \mathbf{u}_\theta$ and $\frac{d\mathbf{u}_\theta}{d\theta} = (-\cos \theta)\mathbf{i} - (\sin \theta)\mathbf{j} = -\mathbf{u}_r$.

(c) From Eq. (7), $\mathbf{v} = \dot{r}\mathbf{u}_r + r\dot{\theta}\mathbf{u}_\theta + \dot{\mathbf{z}}\mathbf{k} \Rightarrow \mathbf{a} = \dot{\mathbf{v}} = (\ddot{r}\mathbf{u}_r + \dot{r}\dot{\mathbf{u}}_r) + (\dot{r}\dot{\theta}\mathbf{u}_\theta + r\ddot{\theta}\mathbf{u}_\theta + r\dot{\theta}\dot{\mathbf{u}}_\theta) + \ddot{\mathbf{z}}\mathbf{k}$
 $= (\ddot{r} - r\dot{\theta}^2)\mathbf{u}_r + (r\ddot{\theta} + 2\dot{r}\dot{\theta})\mathbf{u}_\theta + \ddot{\mathbf{z}}\mathbf{k}$

12. (a) $x = r \cos \theta \Rightarrow dx = \cos \theta dr - r \sin \theta d\theta$; $y = r \sin \theta \Rightarrow dy = \sin \theta dr + r \cos \theta d\theta$; thus $dx^2 = \cos^2 \theta dr^2 - 2r \sin \theta \cos \theta dr d\theta + r^2 \sin^2 \theta d\theta^2$ and

$$dy^2 = \sin^2 \theta dr^2 + 2r \sin \theta \cos \theta dr d\theta + r^2 \cos^2 \theta d\theta^2 \Rightarrow dx^2 + dy^2 + dz^2 = dr^2 + r^2 d\theta^2 + dz^2$$

(c) $r = e^\theta \Rightarrow dr = e^\theta d\theta$

(b)

$$\Rightarrow L = \int_0^{\ln 8} \sqrt{dr^2 + r^2 d\theta^2 + dz^2}$$

$$= \int_0^{\ln 8} \sqrt{e^{2\theta} + e^{2\theta} + e^{2\theta}} d\theta$$

$$= \int_0^{\ln 8} \sqrt{3} e^\theta d\theta = \left[\sqrt{3} e^\theta \right]_0^{\ln 8}$$

$$= 8\sqrt{3} - \sqrt{3} = 7\sqrt{3}$$

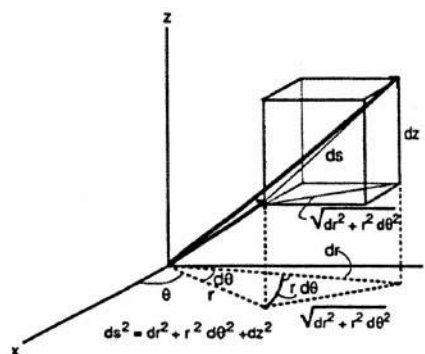

NOTES:

CHAPTER 14 PARTIAL DERIVATIVES

14.1 FUNCTIONS OF SEVERAL VARIABLES

- Domain: all points in the xy -plane
 - Range: all real numbers
 - level curves are straight lines $y - x = c$ parallel to the line $y = x$
 - no boundary points
 - both open and closed
 - unbounded
- Domain: set of all (x, y) so that $y - x \geq 0 \Rightarrow y \geq x$
 - Range: $z \geq 0$
 - level curves are straight lines of the form $y - x = c$ where $c \geq 0$
 - boundary is $\sqrt{y - x} = 0 \Rightarrow y = x$, a straight line
 - closed
 - unbounded
- Domain: all points in the xy -plane
 - Range: $z \geq 0$
 - level curves: for $f(x, y) = 0$, the origin; for $f(x, y) = c > 0$, ellipses with center $(0, 0)$ and major and minor axes along the x - and y -axes, respectively
 - no boundary points
 - both open and closed
 - unbounded
- Domain: all points in the xy -plane
 - Range: all real numbers
 - level curves: for $f(x, y) = 0$, the union of the lines $y = \pm x$; for $f(x, y) = c \neq 0$, hyperbolas centered at $(0, 0)$ with foci on the x -axis if $c > 0$ and on the y -axis if $c < 0$
 - no boundary points
 - both open and closed
 - unbounded
- Domain: all points in the xy -plane
 - Range: all real numbers
 - level curves are hyperbolas with the x - and y -axes as asymptotes when $f(x, y) \neq 0$, and the x - and y -axes when $f(x, y) = 0$
 - no boundary points
 - both open and closed
 - unbounded
- Domain: all $(x, y) \neq (0, y)$
 - Range: all real numbers
 - level curves: for $f(x, y) = 0$, the x -axis minus the origin; for $f(x, y) = c \neq 0$, the parabolas $y = cx^2$ minus the origin
 - boundary is the line $x = 0$

- (e) open
(f) unbounded
7. (a) Domain: all (x, y) satisfying $x^2 + y^2 < 16$
(b) Range: $z \geq \frac{1}{4}$
(c) level curves are circles centered at the origin with radii $r < 4$
(d) boundary is the circle $x^2 + y^2 = 16$
(e) open
(f) bounded
8. (a) Domain: all (x, y) satisfying $x^2 + y^2 \leq 9$
(b) Range: $0 \leq z \leq 3$
(c) level curves are circles centered at the origin with radii $r \leq 3$
(d) boundary is the circle $x^2 + y^2 = 9$
(e) closed
(f) bounded
9. (a) Domain: $(x, y) \neq (0, 0)$
(b) Range: all real numbers
(c) level curves are circles with center $(0, 0)$ and radii $r > 0$
(d) boundary is the single point $(0, 0)$
(e) open
(f) unbounded
10. (a) Domain: all points in the xy -plane
(b) Range: $0 < z \leq 1$
(c) level curves are the origin itself and the circles with center $(0, 0)$ and radii $r > 0$
(d) no boundary points
(e) both open and closed
(f) unbounded
11. (a) Domain: all (x, y) satisfying $-1 \leq y - x \leq 1$
(b) Range: $-\frac{\pi}{2} \leq z \leq \frac{\pi}{2}$
(c) level curves are straight lines of the form $y - x = c$ where $-1 \leq c \leq 1$
(d) boundary is the two straight lines $y = 1 + x$ and $y = -1 + x$
(e) closed
(f) unbounded
12. (a) Domain: all (x, y) , $x \neq 0$
(b) Range: $-\frac{\pi}{2} < z < \frac{\pi}{2}$
(c) level curves are the straight lines of the form $y = cx$, c any real number and $x \neq 0$
(d) boundary is the line $x = 0$
(e) open
(f) unbounded
13. f
14. e
15. a
16. c
17. d
18. b

19. (a)

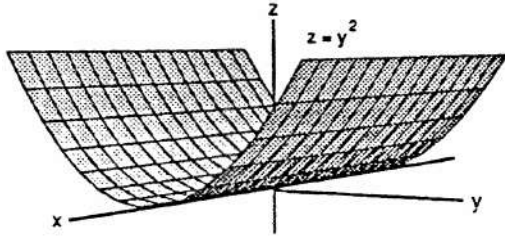

(b)

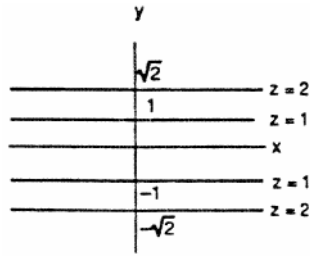

20. (a)

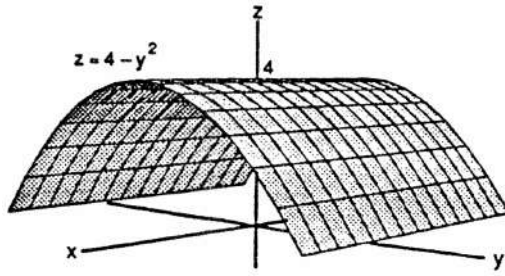

(b)

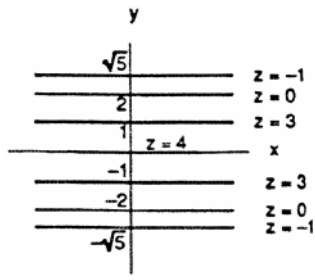

21. (a)



(b)

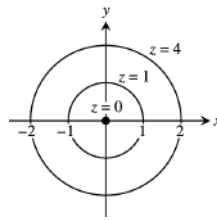

22. (a)

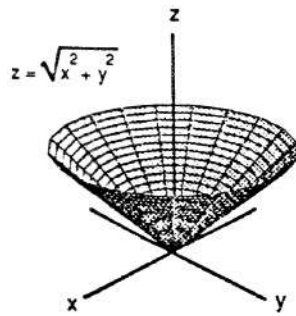

(b)

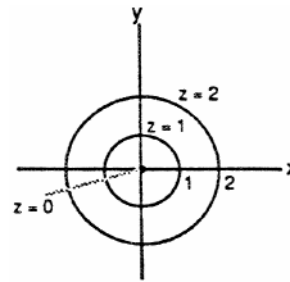

23. (a)

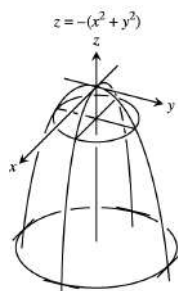

(b)

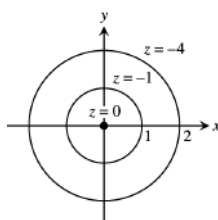

24. (a)

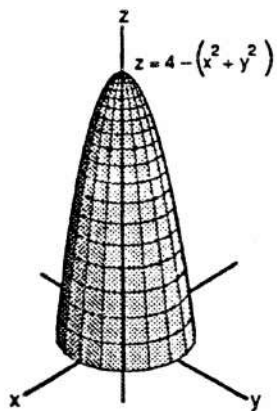

(b)

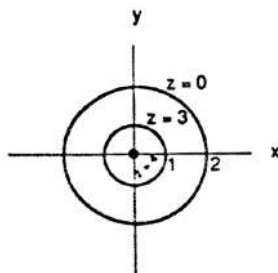

25. (a)

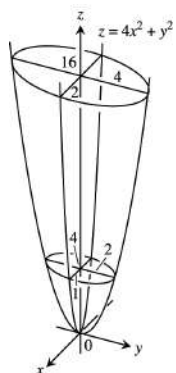

(b)

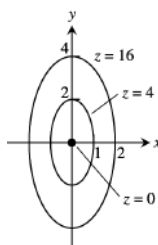

26. (a)

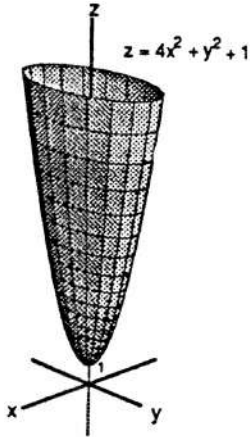

(b)

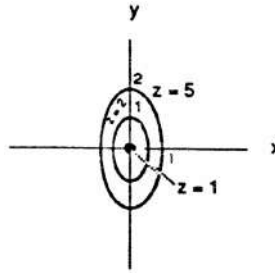

27. (a)

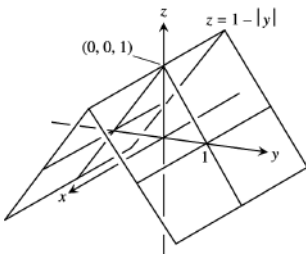

(b)

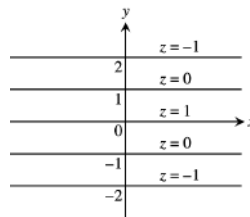

28. (a)

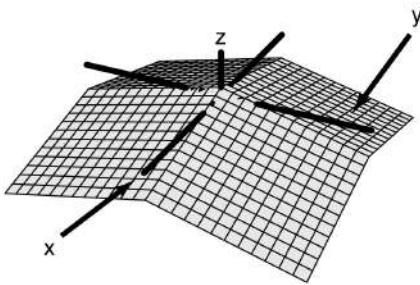

(b)

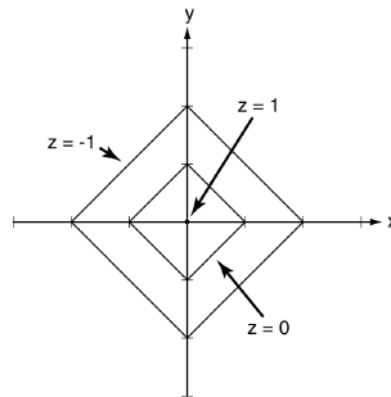

29. $f(x, y) = 16 - x^2 - y^2$ and $(2\sqrt{2}, \sqrt{2}) \Rightarrow z = 16 - (2\sqrt{2})^2 - (\sqrt{2})^2 = 6 \Rightarrow 6 = 16 - x^2 - y^2 \Rightarrow x^2 + y^2 = 10$

30. $f(x, y) = \sqrt{x^2 - 1}$ and $(1, 0) \Rightarrow z = \sqrt{1^2 - 1} = 0 \Rightarrow x^2 - 1 = 0 \Rightarrow x = 1$ or $x = -1$

31. $f(x, y) = \int_x^y \frac{1}{1+t^2} dt$ at $(-\sqrt{2}, \sqrt{2}) \Rightarrow z = \tan^{-1} y - \tan^{-1} x$; at $(-\sqrt{2}, \sqrt{2}) \Rightarrow z = \tan^{-1} \sqrt{2} - \tan^{-1} (-\sqrt{2})$
 $= 2 \tan^{-1} \sqrt{2} \Rightarrow \tan^{-1} y - \tan^{-1} x = 2 \tan^{-1} \sqrt{2}$

32. $f(x, y) = \sum_{n=0}^{\infty} \left(\frac{x}{y}\right)^n$ at $(1, 2) \Rightarrow z = \frac{1}{1 - (\frac{x}{y})} = \frac{y}{y-x}$; at $(1, 2) \Rightarrow z = \frac{2}{2-1} = 2 \Rightarrow 2 = \frac{y}{y-x} \Rightarrow 2y - 2x = y$
 $\Rightarrow y = 2x$

33.

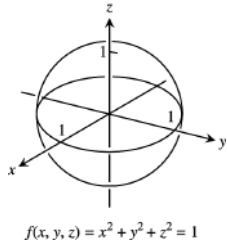

34.

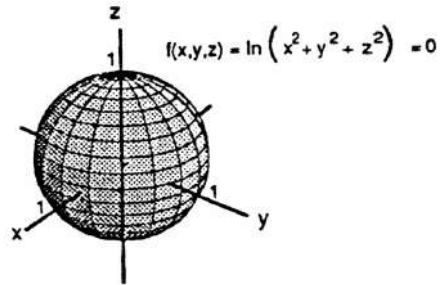

35.

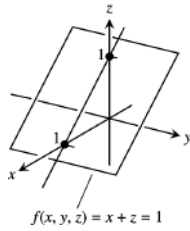

36.

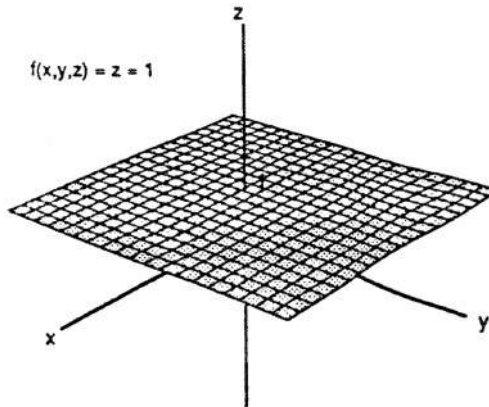

37.

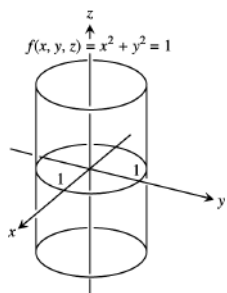

38.

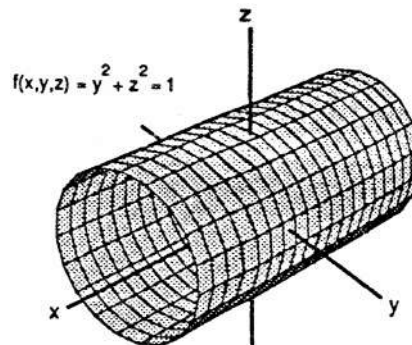

39.

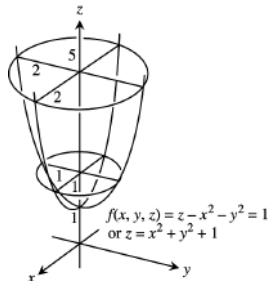

40.

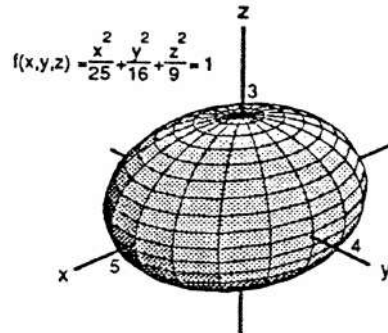

41. $f(x, y, z) = \sqrt{x-y} - \ln z$ at $(3, -1, 1) \Rightarrow w = \sqrt{x-y} - \ln z$; at $(3, -1, 1) \Rightarrow w = \sqrt{3-(-1)} - \ln 1 = 2$
 $\Rightarrow \sqrt{x-y} - \ln z = 2$

42. $f(x, y, z) = \ln(x^2 + y + z^2)$ at $(-1, 2, 1) \Rightarrow w = \ln(x^2 + y + z^2)$; at $(-1, 2, 1) \Rightarrow w = \ln(1 + 2 + 1) = \ln 4$
 $\Rightarrow \ln 4 = \ln(x^2 + y + z^2) \Rightarrow x^2 + y + z^2 = 4$

43. $g(x, y, z) = \sum_{n=0}^{\infty} \frac{(x+y)^n}{n!z^n}$ at $(\ln 2, \ln 4, 3) \Rightarrow w = \sum_{n=0}^{\infty} \frac{(x+y)^n}{n!z^n} = e^{(x+y)/z}$; at $(\ln 2, \ln 4, 3) \Rightarrow w = e^{(\ln 2 + \ln 4)/3}$
 $= e^{(\ln 8)/3} = e^{\ln 2} = 2 \Rightarrow 2 = e^{(x+y)/z} \Rightarrow \frac{x+y}{z} = \ln 2$

44. $g(x, y, z) = \int_x^y \frac{d\theta}{\sqrt{1-\theta^2}} + \int_{\sqrt{2}t}^z \frac{dt}{t\sqrt{t^2-1}}$ at $(0, \frac{1}{2}, 2) \Rightarrow w = [\sin^{-1} \theta]_x^y + [\sec^{-1} t]_{\sqrt{2}}^z$
 $= \sin^{-1} y - \sin^{-1} x + \sec^{-1} z - \sec^{-1}(\sqrt{2}) \Rightarrow w = \sin^{-1} y - \sin^{-1} x + \sec^{-1} z - \frac{\pi}{4}$; at $(0, \frac{1}{2}, 2)$
 $\Rightarrow w = \sin^{-1} \frac{1}{2} - \sin^{-1} 0 + \sec^{-1} 2 - \frac{\pi}{4} = \frac{\pi}{4} \Rightarrow \frac{\pi}{2} = \sin^{-1} y - \sin^{-1} x + \sec^{-1} z$

45. $f(x, y, z) = xyz$ and $x = 20 - t, y = t, z = 20 \Rightarrow w = (20 - t)(t)(20)$ along the line $\Rightarrow w = 400t - 20t^2$
 $\Rightarrow \frac{dw}{dt} = 400 - 40t; \frac{d^2w}{dt^2} = 0 \Rightarrow 400 - 40t = 0 \Rightarrow t = 10$ and $\frac{d^2w}{dt^2} = -40$ for all $t \Rightarrow$ yes, maximum at $t = 10$
 $\Rightarrow x = 20 - 10 = 10, y = 10, z = 20 \Rightarrow$ maximum of f along the line is $f(10, 10, 20) = (10)(10)(20) = 2000$

46. $f(x, y, z) = xy - z$ and $x = t - 1, y = t - 2, z = t + 7 \Rightarrow w = (t - 1)(t - 2) - (t + 7) = t^2 - 4t - 5$ along the line
 $\Rightarrow \frac{dw}{dt} = 2t - 4; \frac{d^2w}{dt^2} = 0 \Rightarrow 2t - 4 = 0 \Rightarrow t = 2$ and $\frac{d^2w}{dt^2} = 2$ for all $t \Rightarrow$ yes, minimum at $t = 2 \Rightarrow x = 2 - 1 = 1,$
 $y = 2 - 2 = 0,$ and $z = 2 + 7 = 9 \Rightarrow$ minimum of f along the line is $f(1, 0, 9) = (1)(0) - 9 = -9$

47. $w = 4 \left(\frac{\text{Th}}{d}\right)^{1/2} = 4 \left[\frac{(290 \text{ K})(16.8 \text{ km})}{5 \text{ K/km}}\right]^{1/2} \approx 124.86 \text{ km} \Rightarrow$ must be $\frac{1}{2}(124.86) \approx 63 \text{ km}$ south of Nantucket

48. The graph of $f(x_1, x_2, x_3, x_4)$ is a set in a five-dimensional space. It is the set of points $(x_1, x_2, x_3, x_4, f(x_1, x_2, x_3, x_4))$ for (x_1, x_2, x_3, x_4) in the domain of f . The graph of $f(x_1, x_2, x_3, \dots, x_n)$ is a set in an $(n + 1)$ -dimensional space. It is the set of points $(x_1, x_2, x_3, \dots, x_n, f(x_1, x_2, x_3, \dots, x_n))$ for $(x_1, x_2, x_3, \dots, x_n)$ in the domain of f .

49-52. Example CAS commands:

Maple:

```
with( plots );
f := (x,y) -> x*sin(y/2) + y*sin(2*x);
xdomain := x=0..5*Pi;
ydomain := y=0..5*Pi;
x0,y0 := 3*Pi,3*Pi;
plot3d( f(x,y), xdomain, ydomain, axes=boxed, style=patch, shading=zhue, title="#49(a) (Section 14.1)" );
plot3d( f(x,y), xdomain, ydomain, grid=[50,50], axes=boxed, shading=zhue, style=patchcontour, orientation=[-90,0],
title="#49(b) (Section 14.1)" ); # (b)
L := evalf( f(x0,y0) ); # (c)
plot3d( f(x,y), xdomain, ydomain, grid=[50,50], axes=boxed, shading=zhue, style=patchcontour, contours=[L],
orientation=[-90,0], title="#49(c) (Section 14.1)" );
```

53-56. Example CAS commands:

Maple:

```
eq := 4*ln(x^2+y^2+z^2)=1;
implicitplot3d( eq, x=-2..2, y=-2..2, z=-2..2, grid=[30,30,30], axes=boxed, title="#53 (Section 14.1)" );
```

57-60. Example CAS commands:

Maple:

```
x := (u,v) -> u*cos(v);
y := (u,v) -> u*sin(v);
z := (u,v) -> u;
plot3d( [x(u,v),y(u,v),z(u,v)], u=0..2, v=0..2*Pi, axes=boxed, style=patchcontour, contours=[(0.4)/2], shading=zhue,
        title="#57 (Section 14.1)" );
```

49-60. Example CAS commands:

Mathematica: (assigned functions and bounds will vary)

For 49 - 52, the command **ContourPlot** draws 2-dimensional contours that are z-level curves of surfaces $z = f(x,y)$.

```
Clear[x, y, f]
f[x_, y_]:= x Sin[y/2] + y Sin[2x]
xmin= 0; xmax= 5π; ymin= 0; ymax= 5π; {x0, y0}={3π, 3π};
cp= ContourPlot[f[x,y], {x, xmin, xmax}, {y, ymin, ymax}, ContourShading -> False];
cp0= ContourPlot[[f[x,y], {x, xmin, xmax}, {y, ymin, ymax}, Contours -> {f[x0,y0]}, ContourShading -> False,
                PlotStyle -> {RGBColor[1,0,0]}];
Show[cp, cp0]
```

For 53 - 56, the command **ContourPlot3D** will be used and requires loading a package. Write the function $f[x, y, z]$ so that when it is equated to zero, it represents the level surface given.

For 53, the problem associated with $\text{Log}[0]$ can be avoided by rewriting the function as $x^2 + y^2 + z^2 - e^{1/4}$

```
<<Graphics`ContourPlot3D`
Clear[x, y, z, f]
f[x_, y_, z_]:= x^2 + y^2 + z^2 - Exp[1/4]
ContourPlot3D[f[x, y, z], {x, -5, 5}, {y, -5, 5}, {z, -5, 5}, PlotPoints -> {7, 7}];
```

For 57 - 60, the command **ParametricPlot3D** will be used and requires loading a package. To get the z-level curves here, we solve x and y in terms of z and either u or v (v here), create a table of level curves, then plot that table.

```
<<Graphics`ParametricPlot3D`
Clear[x, y, z, u, v]
ParametricPlot3D[{u Cos[v], u Sin[v], u}, {u, 0, 2}, {v, 0, 2π}];
zlevel= Table[{z Cos[v], z Sin[v]}, {z, 0, 2, .1}];
ParametricPlot[Evaluate[zlevel], {v, 0, 2π}];
```

14.2 LIMITS AND CONTINUITY

- $$\lim_{(x,y) \rightarrow (0,0)} \frac{3x^2 - y^2 + 5}{x^2 + y^2 + 2} = \frac{3(0)^2 - 0^2 + 5}{0^2 + 0^2 + 2} = \frac{5}{2}$$
- $$\lim_{(x,y) \rightarrow (0,4)} \frac{x}{\sqrt{y}} = \frac{0}{\sqrt{4}} = 0$$
- $$\lim_{(x,y) \rightarrow (3,4)} \sqrt{x^2 + y^2 - 1} = \sqrt{3^2 + 4^2 - 1} = \sqrt{24} = 2\sqrt{6}$$
- $$\lim_{(x,y) \rightarrow (2,-3)} \left(\frac{1}{x} + \frac{1}{y}\right)^2 = \left[\frac{1}{2} + \left(\frac{1}{-3}\right)\right]^2 = \left(\frac{1}{6}\right)^2 = \frac{1}{36}$$
- $$\lim_{(x,y) \rightarrow (0, \frac{\pi}{4})} \sec x \tan y = (\sec 0) \left(\tan \frac{\pi}{4}\right) = (1)(1) = 1$$

$$6. \lim_{(x,y) \rightarrow (0,0)} \cos\left(\frac{x^2+y^3}{x+y+1}\right) = \cos\left(\frac{0^2+0^3}{0+0+1}\right) = \cos 0 = 1$$

$$7. \lim_{(x,y) \rightarrow (0, \ln 2)} e^{x-y} = e^{0-\ln 2} = e^{\ln(\frac{1}{2})} = \frac{1}{2}$$

$$8. \lim_{(x,y) \rightarrow (1,1)} \ln|1+x^2y^2| = \ln|1+(1)^2(1)^2| = \ln 2$$

$$9. \lim_{(x,y) \rightarrow (0,0)} \frac{e^y \sin x}{x} = \lim_{(x,y) \rightarrow (0,0)} (e^y) \left(\frac{\sin x}{x}\right) = e^0 \cdot \lim_{x \rightarrow 0} \left(\frac{\sin x}{x}\right) = 1 \cdot 1 = 1$$

$$10. \lim_{(x,y) \rightarrow (1,1)} \cos\left(\sqrt[3]{|xy|-1}\right) = \cos\left(\sqrt[3]{(1)(1)-1}\right) = \cos 0 = 1$$

$$11. \lim_{(x,y) \rightarrow (1,0)} \frac{x \sin y}{x^2+1} = \frac{1 \cdot \sin 0}{1^2+1} = \frac{0}{2} = 0$$

$$12. \lim_{(x,y) \rightarrow (\frac{\pi}{2}, 0)} \frac{\cos y + 1}{y - \sin x} = \frac{\cos 0 + 1}{0 - \sin(\frac{\pi}{2})} = \frac{1+1}{-1} = -2$$

$$13. \lim_{\substack{(x,y) \rightarrow (1,1) \\ x \neq y}} \frac{x^2 - 2xy + y^2}{x-y} = \lim_{(x,y) \rightarrow (1,1)} \frac{(x-y)^2}{x-y} = \lim_{(x,y) \rightarrow (1,1)} (x-y) = (1-1) = 0$$

$$14. \lim_{\substack{(x,y) \rightarrow (1,1) \\ x \neq y}} \frac{x^2 - y^2}{x-y} = \lim_{(x,y) \rightarrow (1,1)} \frac{(x+y)(x-y)}{x-y} = \lim_{(x,y) \rightarrow (1,1)} (x+y) = (1+1) = 2$$

$$15. \lim_{\substack{(x,y) \rightarrow (1,1) \\ x \neq 1}} \frac{xy - y - 2x + 2}{x-1} = \lim_{\substack{(x,y) \rightarrow (1,1) \\ x \neq 1}} \frac{(x-1)(y-2)}{x-1} = \lim_{(x,y) \rightarrow (1,1)} (y-2) = (1-2) = -1$$

$$16. \lim_{\substack{(x,y) \rightarrow (2,-4) \\ y \neq -4, x \neq x^2}} \frac{y+4}{x^2y - xy + 4x^2 - 4x} = \lim_{\substack{(x,y) \rightarrow (2,-4) \\ y \neq -4, x \neq x^2}} \frac{y+4}{x(x-1)(y+4)} = \lim_{\substack{(x,y) \rightarrow (2,-4) \\ x \neq x^2}} \frac{1}{x(x-1)} = \frac{1}{2(2-1)} = \frac{1}{2}$$

$$17. \lim_{\substack{(x,y) \rightarrow (0,0) \\ x \neq y}} \frac{x-y+2\sqrt{x}-2\sqrt{y}}{\sqrt{x}-\sqrt{y}} = \lim_{\substack{(x,y) \rightarrow (0,0) \\ x \neq y}} \frac{(\sqrt{x}-\sqrt{y})(\sqrt{x}+\sqrt{y}+2)}{\sqrt{x}-\sqrt{y}} = \lim_{(x,y) \rightarrow (0,0)} (\sqrt{x} + \sqrt{y} + 2) \\ = (\sqrt{0} + \sqrt{0} + 2) = 2$$

Note: (x, y) must approach $(0, 0)$ through the first quadrant only with $x \neq y$.

$$18. \lim_{\substack{(x,y) \rightarrow (2,2) \\ x+y \neq 4}} \frac{x+y-4}{\sqrt{x+y}-2} = \lim_{\substack{(x,y) \rightarrow (2,2) \\ x+y \neq 4}} \frac{(\sqrt{x+y}+2)(\sqrt{x+y}-2)}{\sqrt{x+y}-2} = \lim_{\substack{(x,y) \rightarrow (2,2) \\ x+y \neq 4}} (\sqrt{x+y} + 2) \\ = (\sqrt{2+2} + 2) = 2 + 2 = 4$$

$$19. \lim_{\substack{(x,y) \rightarrow (2,0) \\ 2x-y \neq 4}} \frac{\sqrt{2x-y}-2}{2x-y-4} = \lim_{\substack{(x,y) \rightarrow (2,0) \\ 2x-y \neq 4}} \frac{\sqrt{2x-y}-2}{(\sqrt{2x-y}+2)(\sqrt{2x-y}-2)} = \lim_{(x,y) \rightarrow (2,0)} \frac{1}{\sqrt{2x-y}+2} \\ = \frac{1}{\sqrt{(2)(2)-0}+2} = \frac{1}{2+2} = \frac{1}{4}$$

$$20. \lim_{\substack{(x,y) \rightarrow (4,3) \\ x-y \neq 1}} \frac{\sqrt{x}-\sqrt{y+1}}{x-y-1} = \lim_{\substack{(x,y) \rightarrow (4,3) \\ x-y \neq 1}} \frac{\sqrt{x}-\sqrt{y+1}}{(\sqrt{x}+\sqrt{y+1})(\sqrt{x}-\sqrt{y+1})} = \lim_{(x,y) \rightarrow (4,3)} \frac{1}{\sqrt{x}+\sqrt{y+1}}$$

872 Chapter 14 Partial Derivatives

$$= \frac{1}{\sqrt{4+\sqrt{3+1}}} = \frac{1}{2+2} = \frac{1}{4}$$

21. $\lim_{P \rightarrow (1,3,4)} \left(\frac{1}{x} + \frac{1}{y} + \frac{1}{z} \right) = \frac{1}{1} + \frac{1}{3} + \frac{1}{4} = \frac{12+4+3}{12} = \frac{19}{12}$

22. $\lim_{P \rightarrow (1,-1,-1)} \frac{2xy+yz}{x^2+z^2} = \frac{2(1)(-1)+(-1)(-1)}{1^2+(-1)^2} = \frac{-2+1}{1+1} = -\frac{1}{2}$

23. $\lim_{P \rightarrow (3,3,0)} (\sin^2 x + \cos^2 y + \sec^2 z) = (\sin^2 3 + \cos^2 3) + \sec^2 0 = 1 + 1^2 = 2$

24. $\lim_{P \rightarrow \left(-\frac{1}{4}, \frac{\pi}{2}, 2\right)} \tan^{-1}(xyz) = \tan^{-1}\left(-\frac{1}{4} \cdot \frac{\pi}{2} \cdot 2\right) = \tan^{-1}\left(-\frac{\pi}{4}\right)$

25. $\lim_{P \rightarrow (\pi, 0, 3)} ze^{-2y} \cos 2x = 3e^{-2(0)} \cos 2\pi = (3)(1)(1) = 3$

26. $\lim_{P \rightarrow (0, -2, 0)} \ln \sqrt{x^2 + y^2 + z^2} = \ln \sqrt{0^2 + (-2)^2 + 0^2} = \ln \sqrt{4} = \ln 2$

27. (a) All (x, y)
 (b) All (x, y) except $(0, 0)$

28. (a) All (x, y) so that $x \neq y$
 (b) All (x, y)

29. (a) All (x, y) except where $x = 0$ or $y = 0$
 (b) All (x, y)

30. (a) All (x, y) so that $x^2 - 3x + 2 \neq 0 \Rightarrow (x-2)(x-1) \neq 0 \Rightarrow x \neq 2$ and $x \neq 1$
 (b) All (x, y) so that $y \neq x^2$

31. (a) All (x, y, z)
 (b) All (x, y, z) except the interior of the cylinder $x^2 + y^2 = 1$

32. (a) All (x, y, z) so that $xyz > 0$
 (b) All (x, y, z)

33. (a) All (x, y, z) with $z \neq 0$
 (b) All (x, y, z) with $x^2 + z^2 \neq 1$

34. (a) All (x, y, z) except $(x, 0, 0)$
 (b) All (x, y, z) except $(0, y, 0)$ or $(x, 0, 0)$

35. $\lim_{\substack{(x,y) \rightarrow (0,0) \\ \text{along } y=x \\ x > 0}} \frac{x}{\sqrt{x^2+y^2}} = \lim_{x \rightarrow 0^+} \frac{x}{\sqrt{x^2+x^2}} = \lim_{x \rightarrow 0^+} \frac{x}{\sqrt{2}|x|} = \lim_{x \rightarrow 0^+} \frac{x}{\sqrt{2}x} = \lim_{x \rightarrow 0^+} \frac{1}{\sqrt{2}} = \frac{1}{\sqrt{2}};$

$\lim_{\substack{(x,y) \rightarrow (0,0) \\ \text{along } y=x \\ x < 0}} \frac{x}{\sqrt{x^2+y^2}} = \lim_{x \rightarrow 0^-} \frac{x}{\sqrt{2}|x|} = \lim_{x \rightarrow 0^-} \frac{x}{\sqrt{2}(-x)} = \lim_{x \rightarrow 0^-} \frac{1}{\sqrt{2}} = \frac{1}{\sqrt{2}}$

$$36. \lim_{\substack{(x,y) \rightarrow (0,0) \\ \text{along } y=0}} \frac{x^4}{x^4+y^2} = \lim_{x \rightarrow 0} \frac{x^4}{x^4+0^2} = 1; \lim_{\substack{(x,y) \rightarrow (0,0) \\ \text{along } y=x^2}} \frac{x^4}{x^4+y^2} = \lim_{x \rightarrow 0} \frac{x^4}{x^4+(x^2)^2} = \lim_{x \rightarrow 0} \frac{x^4}{2x^4} = \frac{1}{2}$$

$$37. \lim_{\substack{(x,y) \rightarrow (0,0) \\ \text{along } y=kx^2}} \frac{x^4-y^2}{x^4+y^2} = \lim_{x \rightarrow 0} \frac{x^4-(kx^2)^2}{x^4+(kx^2)^2} = \lim_{x \rightarrow 0} \frac{x^4-k^2x^4}{x^4+k^2x^4} = \frac{1-k^2}{1+k^2} \Rightarrow \text{different limits for different values of } k$$

$$38. \lim_{\substack{(x,y) \rightarrow (0,0) \\ \text{along } y=kx \\ k \neq 0}} \frac{xy}{|xy|} = \lim_{x \rightarrow 0} \frac{x(kx)}{|x(kx)|} = \lim_{x \rightarrow 0} \frac{kx^2}{|kx^2|} = \lim_{x \rightarrow 0} \frac{k}{|k|}; \text{ if } k > 0, \text{ the limit is } 1; \text{ but if } k < 0, \text{ the limit is } -1$$

$$39. \lim_{\substack{(x,y) \rightarrow (0,0) \\ \text{along } y=kx \\ k \neq -1}} \frac{x-y}{x+y} = \lim_{x \rightarrow 0} \frac{x-kx}{x+kx} = \frac{1-k}{1+k} \Rightarrow \text{different limits for different values of } k, k \neq -1$$

$$40. \lim_{\substack{(x,y) \rightarrow (0,0) \\ \text{along } y=kx \\ k \neq 1}} \frac{x+y}{x-y} = \lim_{x \rightarrow 0} \frac{x+kx}{x-kx} = \frac{1+k}{1-k} \Rightarrow \text{different limits for different values of } k, k \neq 1$$

$$41. \lim_{\substack{(x,y) \rightarrow (0,0) \\ \text{along } y=kx^2 \\ k \neq 0}} \frac{x^2+y}{y} = \lim_{x \rightarrow 0} \frac{x^2+kx^2}{kx^2} = \frac{1+k}{k} \Rightarrow \text{different limits for different values of } k, k \neq 0$$

$$42. \lim_{\substack{(x,y) \rightarrow (0,0) \\ \text{along } y=kx^2 \\ k \neq 1}} \frac{x^2}{x^2-y} = \lim_{x \rightarrow 0} \frac{x^2}{x^2-kx^2} = \frac{1}{1-k} \Rightarrow \text{different limits for different values of } k, k \neq 1$$

43. No, the limit depends only on the values $f(x, y)$ has when $(x, y) \neq (x_0, y_0)$

44. If f is continuous at (x_0, y_0) , then $\lim_{(x,y) \rightarrow (x_0,y_0)} f(x, y)$ must equal $f(x_0, y_0) = 3$. If f is not continuous at (x_0, y_0) , the limit could have any value different from 3, and need not even exist.

$$45. \lim_{(x,y) \rightarrow (0,0)} \left(1 - \frac{x^2y^2}{3}\right) = 1 \text{ and } \lim_{(x,y) \rightarrow (0,0)} 1 = 1 \Rightarrow \lim_{(x,y) \rightarrow (0,0)} \frac{\tan^{-1}xy}{xy} = 1, \text{ by the Sandwich Theorem}$$

$$46. \text{ If } xy > 0, \lim_{(x,y) \rightarrow (0,0)} \frac{2|xy| - \left(\frac{x^2y^2}{6}\right)}{|xy|} = \lim_{(x,y) \rightarrow (0,0)} \frac{2xy - \left(\frac{x^2y^2}{6}\right)}{xy} = \lim_{(x,y) \rightarrow (0,0)} \left(2 - \frac{xy}{6}\right) = 2 \text{ and}$$

$$\lim_{(x,y) \rightarrow (0,0)} \frac{2|xy|}{|xy|} = \lim_{(x,y) \rightarrow (0,0)} 2 = 2; \text{ if } xy < 0, \lim_{(x,y) \rightarrow (0,0)} \frac{2|xy| - \left(\frac{x^2y^2}{6}\right)}{|xy|} = \lim_{(x,y) \rightarrow (0,0)} \frac{-2xy - \left(\frac{x^2y^2}{6}\right)}{-xy}$$

$$= \lim_{(x,y) \rightarrow (0,0)} \left(2 + \frac{xy}{6}\right) = 2 \text{ and } \lim_{(x,y) \rightarrow (0,0)} \frac{2|xy|}{|xy|} = 2 \Rightarrow \lim_{(x,y) \rightarrow (0,0)} \frac{4 - 4 \cos \sqrt{|xy|}}{|xy|} = 2, \text{ by the Sandwich Theorem}$$

47. The limit is 0 since $|\sin(\frac{1}{x})| \leq 1 \Rightarrow -1 \leq \sin(\frac{1}{x}) \leq 1 \Rightarrow -y \leq y \sin(\frac{1}{x}) \leq y$ for $y \geq 0$, and $-y \geq y \sin(\frac{1}{x}) \geq y$ for $y \leq 0$. Thus as $(x, y) \rightarrow (0, 0)$, both $-y$ and y approach 0 $\Rightarrow y \sin(\frac{1}{x}) \rightarrow 0$, by the Sandwich Theorem.

48. The limit is 0 since $|\cos(\frac{1}{y})| \leq 1 \Rightarrow -1 \leq \cos(\frac{1}{y}) \leq 1 \Rightarrow -x \leq x \cos(\frac{1}{y}) \leq x$ for $x \geq 0$, and $-x \geq x \cos(\frac{1}{y}) \geq x$ for $x \leq 0$. Thus as $(x, y) \rightarrow (0, 0)$, both $-x$ and x approach 0 $\Rightarrow x \cos(\frac{1}{y}) \rightarrow 0$, by the Sandwich Theorem.

49. (a) $f(x, y)|_{y=mx} = \frac{2m}{1+m^2} = \frac{2 \tan \theta}{1 + \tan^2 \theta} = \sin 2\theta$. The value of $f(x, y) = \sin 2\theta$ varies with θ , which is the line's angle of inclination.
- (b) Since $f(x, y)|_{y=mx} = \sin 2\theta$ and since $-1 \leq \sin 2\theta \leq 1$ for every θ , $\lim_{(x, y) \rightarrow (0, 0)} f(x, y)$ varies from -1 to 1 along $y = mx$.
50. $|xy(x^2 - y^2)| = |xy| |x^2 - y^2| \leq |x| |y| |x^2 + y^2| = \sqrt{x^2} \sqrt{y^2} |x^2 + y^2| \leq \sqrt{x^2 + y^2} \sqrt{x^2 + y^2} |x^2 + y^2|$
 $= (x^2 + y^2)^2 \Rightarrow \left| \frac{xy(x^2 - y^2)}{x^2 + y^2} \right| \leq \frac{(x^2 + y^2)^2}{x^2 + y^2} = x^2 + y^2 \Rightarrow -(x^2 + y^2) \leq \frac{xy(x^2 - y^2)}{x^2 + y^2} \leq (x^2 + y^2)$
 $\Rightarrow \lim_{(x, y) \rightarrow (0, 0)} xy \frac{x^2 - y^2}{x^2 + y^2} = 0$ by the Sandwich Theorem, since $\lim_{(x, y) \rightarrow (0, 0)} \pm (x^2 + y^2) = 0$; thus, define $f(0, 0) = 0$
51. $\lim_{(x, y) \rightarrow (0, 0)} \frac{x^3 - xy^2}{x^2 + y^2} = \lim_{r \rightarrow 0} \frac{r^3 \cos^3 \theta - (r \cos \theta)(r^2 \sin^2 \theta)}{r^2 \cos^2 \theta + r^2 \sin^2 \theta} = \lim_{r \rightarrow 0} \frac{r(\cos^3 \theta - \cos \theta \sin^2 \theta)}{1} = 0$
52. $\lim_{(x, y) \rightarrow (0, 0)} \cos \left(\frac{x^3 - y^3}{x^2 + y^2} \right) = \lim_{r \rightarrow 0} \cos \left(\frac{r^3 \cos^3 \theta - r^3 \sin^3 \theta}{r^2 \cos^2 \theta + r^2 \sin^2 \theta} \right) = \lim_{r \rightarrow 0} \cos \left[\frac{r(\cos^3 \theta - \sin^3 \theta)}{1} \right] = \cos 0 = 1$
53. $\lim_{(x, y) \rightarrow (0, 0)} \frac{y^2}{x^2 + y^2} = \lim_{r \rightarrow 0} \frac{r^2 \sin^2 \theta}{r^2} = \lim_{r \rightarrow 0} (\sin^2 \theta) = \sin^2 \theta$; the limit does not exist since $\sin^2 \theta$ is between 0 and 1 depending on θ
54. $\lim_{(x, y) \rightarrow (0, 0)} \frac{2x}{x^2 + x + y^2} = \lim_{r \rightarrow 0} \frac{2r \cos \theta}{r^2 + r \cos \theta} = \lim_{r \rightarrow 0} \frac{2 \cos \theta}{r + \cos \theta} = \frac{2 \cos \theta}{\cos \theta}$; the limit does not exist for $\cos \theta = 0$
55. $\lim_{(x, y) \rightarrow (0, 0)} \tan^{-1} \left[\frac{|x| + |y|}{x^2 + y^2} \right] = \lim_{r \rightarrow 0} \tan^{-1} \left[\frac{|r \cos \theta| + |r \sin \theta|}{r^2} \right] = \lim_{r \rightarrow 0} \tan^{-1} \left[\frac{|r|(|\cos \theta| + |\sin \theta|)}{r^2} \right]$;
 if $r \rightarrow 0^+$, then $\lim_{r \rightarrow 0^+} \tan^{-1} \left[\frac{|r|(|\cos \theta| + |\sin \theta|)}{r^2} \right] = \lim_{r \rightarrow 0^+} \tan^{-1} \left[\frac{|\cos \theta| + |\sin \theta|}{r} \right] = \frac{\pi}{2}$; if $r \rightarrow 0^-$, then
 $\lim_{r \rightarrow 0^-} \tan^{-1} \left[\frac{|r|(|\cos \theta| + |\sin \theta|)}{r^2} \right] = \lim_{r \rightarrow 0^-} \tan^{-1} \left(\frac{|\cos \theta| + |\sin \theta|}{-r} \right) = \frac{\pi}{2} \Rightarrow$ the limit is $\frac{\pi}{2}$
56. $\lim_{(x, y) \rightarrow (0, 0)} \frac{x^2 - y^2}{x^2 + y^2} = \lim_{r \rightarrow 0} \frac{r^2 \cos^2 \theta - r^2 \sin^2 \theta}{r^2} = \lim_{r \rightarrow 0} (\cos^2 \theta - \sin^2 \theta) = \lim_{r \rightarrow 0} (\cos 2\theta)$ which ranges between -1 and 1 depending on $\theta \Rightarrow$ the limit does not exist
57. $\lim_{(x, y) \rightarrow (0, 0)} \ln \left(\frac{3x^2 - x^2 y^2 + 3y^2}{x^2 + y^2} \right) = \lim_{r \rightarrow 0} \ln \left(\frac{3r^2 \cos^2 \theta - r^4 \cos^2 \theta \sin^2 \theta + 3r^2 \sin^2 \theta}{r^2} \right)$
 $= \lim_{r \rightarrow 0} \ln (3 - r^2 \cos^2 \theta \sin^2 \theta) = \ln 3 \Rightarrow$ define $f(0, 0) = \ln 3$
58. $\lim_{(x, y) \rightarrow (0, 0)} \frac{2xy^2}{x^2 + y^2} = \lim_{r \rightarrow 0} \frac{(2r \cos \theta)(r^2 \sin^2 \theta)}{r^2} = \lim_{r \rightarrow 0} 2r \cos \theta \sin^2 \theta = 0 \Rightarrow$ define $f(0, 0) = 0$
59. Let $\delta = 0.1$. Then $\sqrt{x^2 + y^2} < \delta \Rightarrow \sqrt{x^2 + y^2} < 0.1 \Rightarrow x^2 + y^2 < 0.01 \Rightarrow |x^2 + y^2 - 0| < 0.01 \Rightarrow |f(x, y) - f(0, 0)| < 0.01 = \epsilon$.
60. Let $\delta = 0.05$. Then $|x| < \delta$ and $|y| < \delta \Rightarrow |f(x, y) - f(0, 0)| = \left| \frac{y}{x^2 + 1} - 0 \right| = \left| \frac{y}{x^2 + 1} \right| \leq |y| < 0.05 = \epsilon$.
61. Let $\delta = 0.005$. Then $|x| < \delta$ and $|y| < \delta \Rightarrow |f(x, y) - f(0, 0)| = \left| \frac{x+y}{x^2+1} - 0 \right| = \left| \frac{x+y}{x^2+1} \right| \leq |x+y| < |x| + |y| < 0.005 + 0.005 = 0.01 = \epsilon$.

62. Let $\delta = 0.01$. Since $-1 \leq \cos x \leq 1 \Rightarrow 1 \leq 2 + \cos x \leq 3 \Rightarrow \frac{1}{3} \leq \frac{1}{2 + \cos x} \leq 1 \Rightarrow \frac{|x+y|}{3} \leq \left| \frac{x+y}{2 + \cos x} \right| \leq |x+y| \leq |x| + |y|$. Then $|x| < \delta$ and $|y| < \delta \Rightarrow |f(x, y) - f(0, 0)| = \left| \frac{x+y}{2 + \cos x} - 0 \right| = \left| \frac{x+y}{2 + \cos x} \right| \leq |x| + |y| < 0.01 + 0.01 = 0.02 = \epsilon$.

63. Let $\delta = \sqrt{0.015}$. Then $\sqrt{x^2 + y^2 + z^2} < \delta \Rightarrow |f(x, y, z) - f(0, 0, 0)| = |x^2 + y^2 + z^2 - 0| = |x^2 + y^2 + z^2| = \left(\sqrt{x^2 + y^2 + z^2} \right)^2 < \left(\sqrt{0.015} \right)^2 = 0.015 = \epsilon$.

64. Let $\delta = 0.2$. Then $|x| < \delta$, $|y| < \delta$, and $|z| < \delta \Rightarrow |f(x, y, z) - f(0, 0, 0)| = |xyz - 0| = |xyz| = |x| |y| |z| < (0.2)^3 = 0.008 = \epsilon$.

65. Let $\delta = 0.005$. Then $|x| < \delta$, $|y| < \delta$, and $|z| < \delta \Rightarrow |f(x, y, z) - f(0, 0, 0)| = \left| \frac{x+y+z}{x^2+y^2+z^2+1} - 0 \right| = \left| \frac{x+y+z}{x^2+y^2+z^2+1} \right| \leq |x+y+z| \leq |x| + |y| + |z| < 0.005 + 0.005 + 0.005 = 0.015 = \epsilon$.

66. Let $\delta = \tan^{-1}(0.1)$. Then $|x| < \delta$, $|y| < \delta$, and $|z| < \delta \Rightarrow |f(x, y, z) - f(0, 0, 0)| = |\tan^2 x + \tan^2 y + \tan^2 z| \leq |\tan^2 x| + |\tan^2 y| + |\tan^2 z| = \tan^2 x + \tan^2 y + \tan^2 z < \tan^2 \delta + \tan^2 \delta + \tan^2 \delta = 0.01 + 0.01 + 0.01 = 0.03 = \epsilon$.

67. $\lim_{(x, y, z) \rightarrow (x_0, y_0, z_0)} f(x, y, z) = \lim_{(x, y, z) \rightarrow (x_0, y_0, z_0)} (x + y + z) = x_0 + y_0 + z_0 = f(x_0, y_0, z_0) \Rightarrow f$ is continuous at every (x_0, y_0, z_0)

68. $\lim_{(x, y, z) \rightarrow (x_0, y_0, z_0)} f(x, y, z) = \lim_{(x, y, z) \rightarrow (x_0, y_0, z_0)} (x^2 + y^2 + z^2) = x_0^2 + y_0^2 + z_0^2 = f(x_0, y_0, z_0) \Rightarrow f$ is continuous at every point (x_0, y_0, z_0)

14.3 PARTIAL DERIVATIVES

- $\frac{\partial f}{\partial x} = 4x, \frac{\partial f}{\partial y} = -3$
- $\frac{\partial f}{\partial x} = 2x - y, \frac{\partial f}{\partial y} = -x + 2y$
- $\frac{\partial f}{\partial x} = 2x(y + 2), \frac{\partial f}{\partial y} = x^2 - 1$
- $\frac{\partial f}{\partial x} = 5y - 14x + 3, \frac{\partial f}{\partial y} = 5x - 2y - 6$
- $\frac{\partial f}{\partial x} = 2y(xy - 1), \frac{\partial f}{\partial y} = 2x(xy - 1)$
- $\frac{\partial f}{\partial x} = 6(2x - 3y)^2, \frac{\partial f}{\partial y} = -9(2x - 3y)^2$
- $\frac{\partial f}{\partial x} = \frac{x}{\sqrt{x^2 + y^2}}, \frac{\partial f}{\partial y} = \frac{y}{\sqrt{x^2 + y^2}}$
- $\frac{\partial f}{\partial x} = \frac{2x^2}{\sqrt[3]{x^3 + (\frac{y}{2})}}, \frac{\partial f}{\partial y} = \frac{1}{3\sqrt[3]{x^3 + (\frac{y}{2})}}$
- $\frac{\partial f}{\partial x} = -\frac{1}{(x+y)^2} \cdot \frac{\partial}{\partial x}(x+y) = -\frac{1}{(x+y)^2}, \frac{\partial f}{\partial y} = -\frac{1}{(x+y)^2} \cdot \frac{\partial}{\partial y}(x+y) = -\frac{1}{(x+y)^2}$
- $\frac{\partial f}{\partial x} = \frac{(x^2 + y^2)(1) - x(2x)}{(x^2 + y^2)^2} = \frac{y^2 - x^2}{(x^2 + y^2)^2}, \frac{\partial f}{\partial y} = \frac{(x^2 + y^2)(0) - x(2y)}{(x^2 + y^2)^2} = -\frac{2xy}{(x^2 + y^2)^2}$
- $\frac{\partial f}{\partial x} = \frac{(xy - 1)(1) - (x+y)(y)}{(xy - 1)^2} = \frac{-y^2 - 1}{(xy - 1)^2}, \frac{\partial f}{\partial y} = \frac{(xy - 1)(1) - (x+y)(x)}{(xy - 1)^2} = \frac{-x^2 - 1}{(xy - 1)^2}$
- $\frac{\partial f}{\partial x} = \frac{1}{1 + (\frac{y}{x})^2} \cdot \frac{\partial}{\partial x} \left(\frac{y}{x} \right) = -\frac{y}{x^2 \left[1 + (\frac{y}{x})^2 \right]}, \frac{\partial f}{\partial y} = \frac{1}{1 + (\frac{y}{x})^2} \cdot \frac{\partial}{\partial y} \left(\frac{y}{x} \right) = \frac{1}{x \left[1 + (\frac{y}{x})^2 \right]} = \frac{x}{x^2 + y^2}$
- $\frac{\partial f}{\partial x} = e^{(x+y+1)} \cdot \frac{\partial}{\partial x}(x+y+1) = e^{(x+y+1)}, \frac{\partial f}{\partial y} = e^{(x+y+1)} \cdot \frac{\partial}{\partial y}(x+y+1) = e^{(x+y+1)}$

876 Chapter 14 Partial Derivatives

14. $\frac{\partial f}{\partial x} = -e^{-x} \sin(x+y) + e^{-x} \cos(x+y)$, $\frac{\partial f}{\partial y} = e^{-x} \cos(x+y)$

15. $\frac{\partial f}{\partial x} = \frac{1}{x+y} \cdot \frac{\partial}{\partial x}(x+y) = \frac{1}{x+y}$, $\frac{\partial f}{\partial y} = \frac{1}{x+y} \cdot \frac{\partial}{\partial y}(x+y) = \frac{1}{x+y}$

16. $\frac{\partial f}{\partial x} = e^{xy} \cdot \frac{\partial}{\partial x}(xy) \cdot \ln y = ye^{xy} \ln y$, $\frac{\partial f}{\partial y} = e^{xy} \cdot \frac{\partial}{\partial y}(xy) \cdot \ln y + e^{xy} \cdot \frac{1}{y} = xe^{xy} \ln y + \frac{e^{xy}}{y}$

17. $\frac{\partial f}{\partial x} = 2 \sin(x-3y) \cdot \frac{\partial}{\partial x} \sin(x-3y) = 2 \sin(x-3y) \cos(x-3y) \cdot \frac{\partial}{\partial x}(x-3y) = 2 \sin(x-3y) \cos(x-3y)$,
 $\frac{\partial f}{\partial y} = 2 \sin(x-3y) \cdot \frac{\partial}{\partial y} \sin(x-3y) = 2 \sin(x-3y) \cos(x-3y) \cdot \frac{\partial}{\partial y}(x-3y) = -6 \sin(x-3y) \cos(x-3y)$

18. $\frac{\partial f}{\partial x} = 2 \cos(3x-y^2) \cdot \frac{\partial}{\partial x} \cos(3x-y^2) = -2 \cos(3x-y^2) \sin(3x-y^2) \cdot \frac{\partial}{\partial x}(3x-y^2)$
 $= -6 \cos(3x-y^2) \sin(3x-y^2)$,
 $\frac{\partial f}{\partial y} = 2 \cos(3x-y^2) \cdot \frac{\partial}{\partial y} \cos(3x-y^2) = -2 \cos(3x-y^2) \sin(3x-y^2) \cdot \frac{\partial}{\partial y}(3x-y^2)$
 $= 4y \cos(3x-y^2) \sin(3x-y^2)$

19. $\frac{\partial f}{\partial x} = yx^{y-1}$, $\frac{\partial f}{\partial y} = x^y \ln x$

20. $f(x, y) = \frac{\ln x}{\ln y} \Rightarrow \frac{\partial f}{\partial x} = \frac{1}{x \ln y}$ and $\frac{\partial f}{\partial y} = \frac{-\ln x}{y(\ln y)^2}$

21. $\frac{\partial f}{\partial x} = -g(x)$, $\frac{\partial f}{\partial y} = g(y)$

22. $f(x, y) = \sum_{n=0}^{\infty} (xy)^n$, $|xy| < 1 \Rightarrow f(x, y) = \frac{1}{1-xy} \Rightarrow \frac{\partial f}{\partial x} = -\frac{1}{(1-xy)^2} \cdot \frac{\partial}{\partial x}(1-xy) = \frac{y}{(1-xy)^2}$ and
 $\frac{\partial f}{\partial y} = -\frac{1}{(1-xy)^2} \cdot \frac{\partial}{\partial y}(1-xy) = \frac{x}{(1-xy)^2}$

23. $f_x = 1 + y^2$, $f_y = 2xy$, $f_z = -4z$

24. $f_x = y + z$, $f_y = x + z$, $f_z = y + x$

25. $f_x = 1$, $f_y = -\frac{y}{\sqrt{y^2+z^2}}$, $f_z = -\frac{z}{\sqrt{y^2+z^2}}$

26. $f_x = -x(x^2+y^2+z^2)^{-3/2}$, $f_y = -y(x^2+y^2+z^2)^{-3/2}$, $f_z = -z(x^2+y^2+z^2)^{-3/2}$

27. $f_x = \frac{yz}{\sqrt{1-x^2y^2z^2}}$, $f_y = \frac{xz}{\sqrt{1-x^2y^2z^2}}$, $f_z = \frac{xy}{\sqrt{1-x^2y^2z^2}}$

28. $f_x = \frac{1}{|x+yz|\sqrt{(x+yz)^2-1}}$, $f_y = \frac{z}{|x+yz|\sqrt{(x+yz)^2-1}}$, $f_z = \frac{y}{|x+yz|\sqrt{(x+yz)^2-1}}$

29. $f_x = \frac{1}{x+2y+3z}$, $f_y = \frac{2}{x+2y+3z}$, $f_z = \frac{3}{x+2y+3z}$

30. $f_x = yz \cdot \frac{1}{xy} \cdot \frac{\partial}{\partial x}(xy) = \frac{(yz)(y)}{xy} = \frac{yz}{x}$, $f_y = z \ln(xy) + yz \cdot \frac{\partial}{\partial y} \ln(xy) = z \ln(xy) + \frac{yz}{xy} \cdot \frac{\partial}{\partial y}(xy) = z \ln(xy) + z$,
 $f_z = y \ln(xy) + yz \cdot \frac{\partial}{\partial z} \ln(xy) = y \ln(xy)$

31. $f_x = -2xe^{-(x^2+y^2+z^2)}$, $f_y = -2ye^{-(x^2+y^2+z^2)}$, $f_z = -2ze^{-(x^2+y^2+z^2)}$

32. $f_x = -yze^{-xyz}$, $f_y = -xze^{-xyz}$, $f_z = -xye^{-xyz}$

33. $f_x = \operatorname{sech}^2(x+2y+3z)$, $f_y = 2 \operatorname{sech}^2(x+2y+3z)$, $f_z = 3 \operatorname{sech}^2(x+2y+3z)$

34. $f_x = y \cosh(xy-z^2)$, $f_y = x \cosh(xy-z^2)$, $f_z = -2z \cosh(xy-z^2)$

35. $\frac{\partial f}{\partial t} = -2\pi \sin(2\pi t - \alpha)$, $\frac{\partial f}{\partial \alpha} = \sin(2\pi t - \alpha)$
36. $\frac{\partial g}{\partial u} = v^2 e^{(2u/v)} \cdot \frac{\partial}{\partial u} \left(\frac{2u}{v} \right) = 2ve^{(2u/v)}$, $\frac{\partial g}{\partial v} = 2ve^{(2u/v)} + v^2 e^{(2u/v)} \cdot \frac{\partial}{\partial v} \left(\frac{2u}{v} \right) = 2ve^{(2u/v)} - 2ue^{(2u/v)}$
37. $\frac{\partial h}{\partial \rho} = \sin \phi \cos \theta$, $\frac{\partial h}{\partial \phi} = \rho \cos \phi \cos \theta$, $\frac{\partial h}{\partial \theta} = -\rho \sin \phi \sin \theta$
38. $\frac{\partial g}{\partial r} = 1 - \cos \theta$, $\frac{\partial g}{\partial \theta} = r \sin \theta$, $\frac{\partial g}{\partial z} = -1$
39. $\mathbf{W}_p = \mathbf{V}$, $\mathbf{W}_v = \mathbf{P} + \frac{\delta v^2}{2g}$, $\mathbf{W}_\delta = \frac{Vv^2}{2g}$, $\mathbf{W}_v = \frac{2V\delta v}{2g} = \frac{V\delta v}{g}$, $\mathbf{W}_g = -\frac{V\delta v^2}{2g^2}$
40. $\frac{\partial \Lambda}{\partial c} = m$, $\frac{\partial \Lambda}{\partial h} = \frac{q}{2}$, $\frac{\partial \Lambda}{\partial k} = \frac{m}{q}$, $\frac{\partial \Lambda}{\partial m} = \frac{k}{q} + c$, $\frac{\partial \Lambda}{\partial q} = -\frac{km}{q^2} + \frac{h}{2}$
41. $\frac{\partial f}{\partial x} = 1 + y$, $\frac{\partial f}{\partial y} = 1 + x$, $\frac{\partial^2 f}{\partial x^2} = 0$, $\frac{\partial^2 f}{\partial y^2} = 0$, $\frac{\partial^2 f}{\partial y \partial x} = \frac{\partial^2 f}{\partial x \partial y} = 1$
42. $\frac{\partial f}{\partial x} = y \cos xy$, $\frac{\partial f}{\partial y} = x \cos xy$, $\frac{\partial^2 f}{\partial x^2} = -y^2 \sin xy$, $\frac{\partial^2 f}{\partial y^2} = -x^2 \sin xy$, $\frac{\partial^2 f}{\partial y \partial x} = \frac{\partial^2 f}{\partial x \partial y} = \cos xy - xy \sin xy$
43. $\frac{\partial g}{\partial x} = 2xy + y \cos x$, $\frac{\partial g}{\partial y} = x^2 - \sin y + \sin x$, $\frac{\partial^2 g}{\partial x^2} = 2y - y \sin x$, $\frac{\partial^2 g}{\partial y^2} = -\cos y$, $\frac{\partial^2 g}{\partial y \partial x} = \frac{\partial^2 g}{\partial x \partial y} = 2x + \cos x$
44. $\frac{\partial h}{\partial x} = e^y$, $\frac{\partial h}{\partial y} = xe^y + 1$, $\frac{\partial^2 h}{\partial x^2} = 0$, $\frac{\partial^2 h}{\partial y^2} = xe^y$, $\frac{\partial^2 h}{\partial y \partial x} = \frac{\partial^2 h}{\partial x \partial y} = e^y$
45. $\frac{\partial r}{\partial x} = \frac{1}{x+y}$, $\frac{\partial r}{\partial y} = \frac{1}{x+y}$, $\frac{\partial^2 r}{\partial x^2} = \frac{-1}{(x+y)^2}$, $\frac{\partial^2 r}{\partial y^2} = \frac{-1}{(x+y)^2}$, $\frac{\partial^2 r}{\partial y \partial x} = \frac{\partial^2 r}{\partial x \partial y} = \frac{-1}{(x+y)^2}$
46. $\frac{\partial s}{\partial x} = \left[\frac{1}{1 + \left(\frac{y}{x}\right)^2} \right] \cdot \frac{\partial}{\partial x} \left(\frac{y}{x} \right) = \left(-\frac{y}{x^2} \right) \left[\frac{1}{1 + \left(\frac{y}{x}\right)^2} \right] = \frac{-y}{x^2 + y^2}$, $\frac{\partial s}{\partial y} = \left[\frac{1}{1 + \left(\frac{y}{x}\right)^2} \right] \cdot \frac{\partial}{\partial y} \left(\frac{y}{x} \right) = \left(\frac{1}{x} \right) \left[\frac{1}{1 + \left(\frac{y}{x}\right)^2} \right] = \frac{x}{x^2 + y^2}$,
 $\frac{\partial^2 s}{\partial x^2} = \frac{y(2x)}{(x^2 + y^2)^2} = \frac{2xy}{(x^2 + y^2)^2}$, $\frac{\partial^2 s}{\partial y^2} = \frac{-x(2y)}{(x^2 + y^2)^2} = -\frac{2xy}{(x^2 + y^2)^2}$,
 $\frac{\partial^2 s}{\partial y \partial x} = \frac{\partial^2 s}{\partial x \partial y} = \frac{(x^2 + y^2)(-1) + y(2y)}{(x^2 + y^2)^2} = \frac{y^2 - x^2}{(x^2 + y^2)^2}$
47. $\frac{\partial w}{\partial x} = \frac{2}{2x+3y}$, $\frac{\partial w}{\partial y} = \frac{3}{2x+3y}$, $\frac{\partial^2 w}{\partial y \partial x} = \frac{-6}{(2x+3y)^2}$, and $\frac{\partial^2 w}{\partial x \partial y} = \frac{-6}{(2x+3y)^2}$
48. $\frac{\partial w}{\partial x} = e^x + \ln y + \frac{y}{x}$, $\frac{\partial w}{\partial y} = \frac{x}{y} + \ln x$, $\frac{\partial^2 w}{\partial y \partial x} = \frac{1}{y} + \frac{1}{x}$, and $\frac{\partial^2 w}{\partial x \partial y} = \frac{1}{y} + \frac{1}{x}$
49. $\frac{\partial w}{\partial x} = y^2 + 2xy^3 + 3x^2y^4$, $\frac{\partial w}{\partial y} = 2xy + 3x^2y^2 + 4x^3y^3$, $\frac{\partial^2 w}{\partial y \partial x} = 2y + 6xy^2 + 12x^2y^3$, and
 $\frac{\partial^2 w}{\partial x \partial y} = 2y + 6xy^2 + 12x^2y^3$
50. $\frac{\partial w}{\partial x} = \sin y + y \cos x + y$, $\frac{\partial w}{\partial y} = x \cos y + \sin x + x$, $\frac{\partial^2 w}{\partial y \partial x} = \cos y + \cos x + 1$, and
 $\frac{\partial^2 w}{\partial x \partial y} = \cos y + \cos x + 1$
51. (a) x first (b) y first (c) x first (d) x first (e) y first (f) y first
52. (a) y first three times (b) y first three times (c) y first twice (d) x first twice

$$53. f_x(1, 2) = \lim_{h \rightarrow 0} \frac{f(1+h, 2) - f(1, 2)}{h} = \lim_{h \rightarrow 0} \frac{[1 - (1+h) + 2 - 6(1+h)^2] - (2-6)}{h} = \lim_{h \rightarrow 0} \frac{-h - 6(1+2h+h^2) + 6}{h}$$

$$= \lim_{h \rightarrow 0} \frac{-13h - 6h^2}{h} = \lim_{h \rightarrow 0} (-13 - 6h) = -13,$$

$$f_y(1, 2) = \lim_{h \rightarrow 0} \frac{f(1, 2+h) - f(1, 2)}{h} = \lim_{h \rightarrow 0} \frac{[1 - 1 + (2+h) - 3(2+h)] - (2-6)}{h} = \lim_{h \rightarrow 0} \frac{(2-6-2h) - (2-6)}{h}$$

$$= \lim_{h \rightarrow 0} (-2) = -2$$

$$54. f_x(-2, 1) = \lim_{h \rightarrow 0} \frac{f(-2+h, 1) - f(-2, 1)}{h} = \lim_{h \rightarrow 0} \frac{[4 + 2(-2+h) - 3 - (-2+h)] - (-3+2)}{h}$$

$$= \lim_{h \rightarrow 0} \frac{(2h-1-h)+1}{h} = \lim_{h \rightarrow 0} 1 = 1,$$

$$f_y(-2, 1) = \lim_{h \rightarrow 0} \frac{f(-2, 1+h) - f(-2, 1)}{h} = \lim_{h \rightarrow 0} \frac{[4 - 4 - 3(1+h) + 2(1+h^2)] - (-3+2)}{h}$$

$$= \lim_{h \rightarrow 0} \frac{(-3-3h+2+4h+2h^2)+1}{h} = \lim_{h \rightarrow 0} \frac{h+2h^2}{h} = \lim_{h \rightarrow 0} (1+2h) = 1$$

$$55. f_z(x_0, y_0, z_0) = \lim_{h \rightarrow 0} \frac{f(x_0, y_0, z_0+h) - f(x_0, y_0, z_0)}{h};$$

$$f_z(1, 2, 3) = \lim_{h \rightarrow 0} \frac{f(1, 2, 3+h) - f(1, 2, 3)}{h} = \lim_{h \rightarrow 0} \frac{2(3+h)^2 - 2(9)}{h} = \lim_{h \rightarrow 0} \frac{12h+2h^2}{h} = \lim_{h \rightarrow 0} (12+2h) = 12$$

$$56. f_y(x_0, y_0, z_0) = \lim_{h \rightarrow 0} \frac{f(x_0, y_0+h, z_0) - f(x_0, y_0, z_0)}{h};$$

$$f_y(-1, 0, 3) = \lim_{h \rightarrow 0} \frac{f(-1, h, 3) - f(-1, 0, 3)}{h} = \lim_{h \rightarrow 0} \frac{(2h^2+9h)-0}{h} = \lim_{h \rightarrow 0} (2h+9) = 9$$

$$57. y + (3z^2 \frac{\partial z}{\partial x})x + z^3 - 2y \frac{\partial z}{\partial x} = 0 \Rightarrow (3xz^2 - 2y) \frac{\partial z}{\partial x} = -y - z^3 \Rightarrow \text{at } (1, 1, 1) \text{ we have } (3-2) \frac{\partial z}{\partial x} = -1-1 \text{ or}$$

$$\frac{\partial z}{\partial x} = -2$$

$$58. \left(\frac{\partial x}{\partial z}\right)z + x + \left(\frac{y}{x}\right)\frac{\partial x}{\partial z} - 2x \frac{\partial x}{\partial z} = 0 \Rightarrow \left(z + \frac{y}{x} - 2x\right) \frac{\partial x}{\partial z} = -x \Rightarrow \text{at } (1, -1, -3) \text{ we have } (-3-1-2) \frac{\partial x}{\partial z} = -1 \text{ or}$$

$$\frac{\partial x}{\partial z} = \frac{1}{6}$$

$$59. a^2 = b^2 + c^2 - 2bc \cos A \Rightarrow 2a = (2bc \sin A) \frac{\partial A}{\partial a} \Rightarrow \frac{\partial A}{\partial a} = \frac{a}{bc \sin A}; \text{ also } 0 = 2b - 2c \cos A + (2bc \sin A) \frac{\partial A}{\partial b}$$

$$\Rightarrow 2c \cos A - 2b = (2bc \sin A) \frac{\partial A}{\partial b} \Rightarrow \frac{\partial A}{\partial b} = \frac{c \cos A - b}{bc \sin A}$$

$$60. \frac{a}{\sin A} = \frac{b}{\sin B} \Rightarrow \frac{(\sin A) \frac{\partial a}{\partial A} - a \cos A}{\sin^2 A} = 0 \Rightarrow (\sin A) \frac{\partial a}{\partial A} - a \cos A = 0 \Rightarrow \frac{\partial a}{\partial A} = \frac{a \cos A}{\sin A}; \text{ also}$$

$$\left(\frac{1}{\sin A}\right) \frac{\partial a}{\partial B} = b(-\csc B \cot B) \Rightarrow \frac{\partial a}{\partial B} = -b \csc B \cot B \sin A$$

$$61. \text{Differentiating each equation implicitly gives } 1 = v_x \ln u + \left(\frac{v}{u}\right) u_x \text{ and } 0 = u_x \ln v + \left(\frac{u}{v}\right) v_x \text{ or}$$

$$\left. \begin{aligned} (\ln u) v_x + \left(\frac{v}{u}\right) u_x &= 1 \\ \left(\frac{u}{v}\right) v_x + (\ln v) u_x &= 0 \end{aligned} \right\} \Rightarrow v_x = \frac{\begin{vmatrix} 1 & \frac{v}{u} \\ 0 & \ln v \end{vmatrix}}{\begin{vmatrix} \ln u & \frac{v}{u} \\ \frac{u}{v} & \ln v \end{vmatrix}} = \frac{\ln v}{(\ln u)(\ln v) - 1}$$

$$62. \text{Differentiating each equation implicitly gives } 1 = (2x)x_u - (2y)y_u \text{ and } 0 = (2x)x_u - y_u \text{ or}$$

$$\left. \begin{aligned} (2x)x_u - (2y)y_u &= 1 \\ (2x)x_u - y_u &= 0 \end{aligned} \right\} \Rightarrow x_u = \frac{\begin{vmatrix} 1 & -2y \\ 0 & -1 \end{vmatrix}}{\begin{vmatrix} 2x & -2y \\ 2x & -1 \end{vmatrix}} = \frac{-1}{-2x+4xy} = \frac{1}{2x-4xy} \text{ and}$$

$$y_u = \frac{\begin{vmatrix} 2x & 1 \\ 2x & 0 \end{vmatrix}}{-2x+4xy} = \frac{-2x}{-2x+4xy} = \frac{2x}{2x-4xy} = \frac{1}{1-2y}; \text{ next } s = x^2 + y^2 \Rightarrow \frac{\partial s}{\partial u} = 2x \frac{\partial x}{\partial u} + 2y \frac{\partial y}{\partial u}$$

$$= 2x \left(\frac{1}{2x-4xy}\right) + 2y \left(\frac{1}{1-2y}\right) = \frac{1}{1-2y} + \frac{2y}{1-2y} = \frac{1+2y}{1-2y}$$

$$63. \frac{\partial f}{\partial x} = 2x, \frac{\partial f}{\partial y} = 2y, \frac{\partial f}{\partial z} = -4z \Rightarrow \frac{\partial^2 f}{\partial x^2} = 2, \frac{\partial^2 f}{\partial y^2} = 2, \frac{\partial^2 f}{\partial z^2} = -4 \Rightarrow \frac{\partial^2 f}{\partial x^2} + \frac{\partial^2 f}{\partial y^2} + \frac{\partial^2 f}{\partial z^2} = 2 + 2 + (-4) = 0$$

64. $\frac{\partial f}{\partial x} = -6xz$, $\frac{\partial f}{\partial y} = -6yz$, $\frac{\partial f}{\partial z} = 6z^2 - 3(x^2 + y^2)$, $\frac{\partial^2 f}{\partial x^2} = -6z$, $\frac{\partial^2 f}{\partial y^2} = -6z$, $\frac{\partial^2 f}{\partial z^2} = 12z \Rightarrow \frac{\partial^2 f}{\partial x^2} + \frac{\partial^2 f}{\partial y^2} + \frac{\partial^2 f}{\partial z^2} = -6z - 6z + 12z = 0$
65. $\frac{\partial f}{\partial x} = -2e^{-2y} \sin 2x$, $\frac{\partial f}{\partial y} = -2e^{-2y} \cos 2x$, $\frac{\partial^2 f}{\partial x^2} = -4e^{-2y} \cos 2x$, $\frac{\partial^2 f}{\partial y^2} = 4e^{-2y} \cos 2x \Rightarrow \frac{\partial^2 f}{\partial x^2} + \frac{\partial^2 f}{\partial y^2} = -4e^{-2y} \cos 2x + 4e^{-2y} \cos 2x = 0$
66. $\frac{\partial f}{\partial x} = \frac{x}{x^2 + y^2}$, $\frac{\partial f}{\partial y} = \frac{y}{x^2 + y^2}$, $\frac{\partial^2 f}{\partial x^2} = \frac{y^2 - x^2}{(x^2 + y^2)^2}$, $\frac{\partial^2 f}{\partial y^2} = \frac{x^2 - y^2}{(x^2 + y^2)^2} \Rightarrow \frac{\partial^2 f}{\partial x^2} + \frac{\partial^2 f}{\partial y^2} = \frac{y^2 - x^2}{(x^2 + y^2)^2} + \frac{x^2 - y^2}{(x^2 + y^2)^2} = 0$
67. $\frac{\partial f}{\partial x} = -\frac{1}{2}(x^2 + y^2 + z^2)^{-3/2}(2x) = -x(x^2 + y^2 + z^2)^{-3/2}$, $\frac{\partial f}{\partial y} = -\frac{1}{2}(x^2 + y^2 + z^2)^{-3/2}(2y) = -y(x^2 + y^2 + z^2)^{-3/2}$, $\frac{\partial f}{\partial z} = -\frac{1}{2}(x^2 + y^2 + z^2)^{-3/2}(2z) = -z(x^2 + y^2 + z^2)^{-3/2}$;
 $\frac{\partial^2 f}{\partial x^2} = -(x^2 + y^2 + z^2)^{-3/2} + 3x^2(x^2 + y^2 + z^2)^{-5/2}$, $\frac{\partial^2 f}{\partial y^2} = -(x^2 + y^2 + z^2)^{-3/2} + 3y^2(x^2 + y^2 + z^2)^{-5/2}$,
 $\frac{\partial^2 f}{\partial z^2} = -(x^2 + y^2 + z^2)^{-3/2} + 3z^2(x^2 + y^2 + z^2)^{-5/2} \Rightarrow \frac{\partial^2 f}{\partial x^2} + \frac{\partial^2 f}{\partial y^2} + \frac{\partial^2 f}{\partial z^2} = \left[-(x^2 + y^2 + z^2)^{-3/2} + 3x^2(x^2 + y^2 + z^2)^{-5/2} \right] + \left[-(x^2 + y^2 + z^2)^{-3/2} + 3y^2(x^2 + y^2 + z^2)^{-5/2} \right] + \left[-(x^2 + y^2 + z^2)^{-3/2} + 3z^2(x^2 + y^2 + z^2)^{-5/2} \right] = -3(x^2 + y^2 + z^2)^{-3/2} + (3x^2 + 3y^2 + 3z^2)(x^2 + y^2 + z^2)^{-5/2} = 0$
68. $\frac{\partial f}{\partial x} = 3e^{3x+4y} \cos 5z$, $\frac{\partial f}{\partial y} = 4e^{3x+4y} \cos 5z$, $\frac{\partial f}{\partial z} = -5e^{3x+4y} \sin 5z$; $\frac{\partial^2 f}{\partial x^2} = 9e^{3x+4y} \cos 5z$, $\frac{\partial^2 f}{\partial y^2} = 16e^{3x+4y} \cos 5z$, $\frac{\partial^2 f}{\partial z^2} = -25e^{3x+4y} \cos 5z \Rightarrow \frac{\partial^2 f}{\partial x^2} + \frac{\partial^2 f}{\partial y^2} + \frac{\partial^2 f}{\partial z^2} = 9e^{3x+4y} \cos 5z + 16e^{3x+4y} \cos 5z - 25e^{3x+4y} \cos 5z = 0$
69. $\frac{\partial w}{\partial x} = \cos(x + ct)$, $\frac{\partial w}{\partial t} = c \cos(x + ct)$; $\frac{\partial^2 w}{\partial x^2} = -\sin(x + ct)$, $\frac{\partial^2 w}{\partial t^2} = -c^2 \sin(x + ct) \Rightarrow \frac{\partial^2 w}{\partial t^2} = c^2 [-\sin(x + ct)] = c^2 \frac{\partial^2 w}{\partial x^2}$
70. $\frac{\partial w}{\partial x} = -2 \sin(2x + 2ct)$, $\frac{\partial w}{\partial t} = -2c \sin(2x + 2ct)$; $\frac{\partial^2 w}{\partial x^2} = -4 \cos(2x + 2ct)$, $\frac{\partial^2 w}{\partial t^2} = -4c^2 \cos(2x + 2ct) \Rightarrow \frac{\partial^2 w}{\partial t^2} = c^2 [-4 \cos(2x + 2ct)] = c^2 \frac{\partial^2 w}{\partial x^2}$
71. $\frac{\partial w}{\partial x} = \cos(x + ct) - 2 \sin(2x + 2ct)$, $\frac{\partial w}{\partial t} = c \cos(x + ct) - 2c \sin(2x + 2ct)$;
 $\frac{\partial^2 w}{\partial x^2} = -\sin(x + ct) - 4 \cos(2x + 2ct)$, $\frac{\partial^2 w}{\partial t^2} = -c^2 \sin(x + ct) - 4c^2 \cos(2x + 2ct) \Rightarrow \frac{\partial^2 w}{\partial t^2} = c^2 [-\sin(x + ct) - 4 \cos(2x + 2ct)] = c^2 \frac{\partial^2 w}{\partial x^2}$
72. $\frac{\partial w}{\partial x} = \frac{1}{x+ct}$, $\frac{\partial w}{\partial t} = \frac{c}{x+ct}$; $\frac{\partial^2 w}{\partial x^2} = \frac{-1}{(x+ct)^2}$, $\frac{\partial^2 w}{\partial t^2} = \frac{-c^2}{(x+ct)^2} \Rightarrow \frac{\partial^2 w}{\partial t^2} = c^2 \left[\frac{-1}{(x+ct)^2} \right] = c^2 \frac{\partial^2 w}{\partial x^2}$
73. $\frac{\partial w}{\partial x} = 2 \sec^2(2x - 2ct)$, $\frac{\partial w}{\partial t} = -2c \sec^2(2x - 2ct)$; $\frac{\partial^2 w}{\partial x^2} = 8 \sec^2(2x - 2ct) \tan(2x - 2ct)$,
 $\frac{\partial^2 w}{\partial t^2} = 8c^2 \sec^2(2x - 2ct) \tan(2x - 2ct) \Rightarrow \frac{\partial^2 w}{\partial t^2} = c^2 [8 \sec^2(2x - 2ct) \tan(2x - 2ct)] = c^2 \frac{\partial^2 w}{\partial x^2}$
74. $\frac{\partial w}{\partial x} = -15 \sin(3x + 3ct) + e^{x+ct}$, $\frac{\partial w}{\partial t} = -15c \sin(3x + 3ct) + ce^{x+ct}$; $\frac{\partial^2 w}{\partial x^2} = -45 \cos(3x + 3ct) + e^{x+ct}$,
 $\frac{\partial^2 w}{\partial t^2} = -45c^2 \cos(3x + 3ct) + c^2 e^{x+ct} \Rightarrow \frac{\partial^2 w}{\partial t^2} = c^2 [-45 \cos(3x + 3ct) + e^{x+ct}] = c^2 \frac{\partial^2 w}{\partial x^2}$
75. $\frac{\partial w}{\partial t} = \frac{\partial f}{\partial u} \frac{\partial u}{\partial t} = \frac{\partial f}{\partial u} (ac) \Rightarrow \frac{\partial^2 w}{\partial t^2} = (ac) \left(\frac{\partial^2 f}{\partial u^2} \right) (ac) = a^2 c^2 \frac{\partial^2 f}{\partial u^2}$; $\frac{\partial w}{\partial x} = \frac{\partial f}{\partial u} \frac{\partial u}{\partial x} = \frac{\partial f}{\partial u} \cdot a \Rightarrow \frac{\partial^2 w}{\partial x^2} = \left(a \frac{\partial^2 f}{\partial u^2} \right) \cdot a = a^2 \frac{\partial^2 f}{\partial u^2} \Rightarrow \frac{\partial^2 w}{\partial t^2} = a^2 c^2 \frac{\partial^2 f}{\partial u^2} = c^2 \left(a^2 \frac{\partial^2 f}{\partial u^2} \right) = c^2 \frac{\partial^2 w}{\partial x^2}$

76. If the first partial derivatives are continuous throughout an open region R , then by Theorem 3 in this section of the text, $f(x, y) = f(x_0, y_0) + f_x(x_0, y_0) \Delta x + f_y(x_0, y_0) \Delta y + \epsilon_1 \Delta x + \epsilon_2 \Delta y$, where $\epsilon_1, \epsilon_2 \rightarrow 0$ as $\Delta x, \Delta y \rightarrow 0$. Then as $(x, y) \rightarrow (x_0, y_0)$, $\Delta x \rightarrow 0$ and $\Delta y \rightarrow 0 \Rightarrow \lim_{(x, y) \rightarrow (x_0, y_0)} f(x, y) = f(x_0, y_0) \Rightarrow f$ is continuous at every point (x_0, y_0) in R .

77. Yes, since f_{xx}, f_{yy}, f_{xy} , and f_{yx} are all continuous on R , use the same reasoning as in Exercise 76 with $f_x(x, y) = f_x(x_0, y_0) + f_{xx}(x_0, y_0) \Delta x + f_{xy}(x_0, y_0) \Delta y + \epsilon_1 \Delta x + \epsilon_2 \Delta y$ and $f_y(x, y) = f_y(x_0, y_0) + f_{yx}(x_0, y_0) \Delta x + f_{yy}(x_0, y_0) \Delta y + \hat{\epsilon}_1 \Delta x + \hat{\epsilon}_2 \Delta y$. Then $\lim_{(x, y) \rightarrow (x_0, y_0)} f_x(x, y) = f_x(x_0, y_0)$ and $\lim_{(x, y) \rightarrow (x_0, y_0)} f_y(x, y) = f_y(x_0, y_0)$.

14.4 THE CHAIN RULE

- (a) $\frac{\partial w}{\partial x} = 2x, \frac{\partial w}{\partial y} = 2y, \frac{dx}{dt} = -\sin t, \frac{dy}{dt} = \cos t \Rightarrow \frac{dw}{dt} = -2x \sin t + 2y \cos t = -2 \cos t \sin t + 2 \sin t \cos t = 0$; $w = x^2 + y^2 = \cos^2 t + \sin^2 t = 1 \Rightarrow \frac{dw}{dt} = 0$

(b) $\frac{dw}{dt}(\pi) = 0$
- (a) $\frac{\partial w}{\partial x} = 2x, \frac{\partial w}{\partial y} = 2y, \frac{dx}{dt} = -\sin t + \cos t, \frac{dy}{dt} = -\sin t - \cos t \Rightarrow \frac{dw}{dt} = (2x)(-\sin t + \cos t) + (2y)(-\sin t - \cos t) = 2(\cos t + \sin t)(\cos t - \sin t) - 2(\cos t - \sin t)(\sin t + \cos t) = (2 \cos^2 t - 2 \sin^2 t) - (2 \cos^2 t - 2 \sin^2 t) = 0$; $w = x^2 + y^2 = (\cos t + \sin t)^2 + (\cos t - \sin t)^2 = 2 \cos^2 t + 2 \sin^2 t = 2 \Rightarrow \frac{dw}{dt} = 0$

(b) $\frac{dw}{dt}(0) = 0$
- (a) $\frac{\partial w}{\partial x} = \frac{1}{z}, \frac{\partial w}{\partial y} = \frac{1}{z}, \frac{\partial w}{\partial z} = \frac{-(x+y)}{z^2}, \frac{dx}{dt} = -2 \cos t \sin t, \frac{dy}{dt} = 2 \sin t \cos t, \frac{dz}{dt} = -\frac{1}{t^2} \Rightarrow \frac{dw}{dt} = -\frac{2}{z} \cos t \sin t + \frac{2}{z} \sin t \cos t + \frac{x+y}{z^2 t^2} = \frac{\cos^2 t + \sin^2 t}{(\frac{1}{t^2})(t^2)} = 1$; $w = \frac{x}{z} + \frac{y}{z} = \frac{\cos^2 t}{(\frac{1}{t})} + \frac{\sin^2 t}{(\frac{1}{t})} = t \Rightarrow \frac{dw}{dt} = 1$

(b) $\frac{dw}{dt}(3) = 1$
- (a) $\frac{\partial w}{\partial x} = \frac{2x}{x^2 + y^2 + z^2}, \frac{\partial w}{\partial y} = \frac{2y}{x^2 + y^2 + z^2}, \frac{\partial w}{\partial z} = \frac{2z}{x^2 + y^2 + z^2}, \frac{dx}{dt} = -\sin t, \frac{dy}{dt} = \cos t, \frac{dz}{dt} = 2t^{-1/2} \Rightarrow \frac{dw}{dt} = \frac{-2x \sin t}{x^2 + y^2 + z^2} + \frac{2y \cos t}{x^2 + y^2 + z^2} + \frac{4zt^{-1/2}}{x^2 + y^2 + z^2} = \frac{-2 \cos t \sin t + 2 \sin t \cos t + 4(4t^{1/2})t^{-1/2}}{\cos^2 t + \sin^2 t + 16t} = \frac{16}{1+16t}$; $w = \ln(x^2 + y^2 + z^2) = \ln(\cos^2 t + \sin^2 t + 16t) = \ln(1 + 16t) \Rightarrow \frac{dw}{dt} = \frac{16}{1+16t}$

(b) $\frac{dw}{dt}(3) = \frac{16}{49}$
- (a) $\frac{\partial w}{\partial x} = 2ye^x, \frac{\partial w}{\partial y} = 2e^x, \frac{\partial w}{\partial z} = -\frac{1}{z}, \frac{dx}{dt} = \frac{2t}{t^2+1}, \frac{dy}{dt} = \frac{1}{t^2+1}, \frac{dz}{dt} = e^t \Rightarrow \frac{dw}{dt} = \frac{4yte^x}{t^2+1} + \frac{2e^x}{t^2+1} - \frac{e^t}{t} = \frac{(4t)(\tan^{-1} t)(t^2+1)}{t^2+1} + \frac{2(t^2+1)}{t^2+1} - \frac{e^t}{e^t} = 4t \tan^{-1} t + 1$; $w = 2ye^x - \ln z = (2 \tan^{-1} t)(t^2+1) - t \Rightarrow \frac{dw}{dt} = \left(\frac{2}{t^2+1}\right)(t^2+1) + (2 \tan^{-1} t)(2t) - 1 = 4t \tan^{-1} t + 1$

(b) $\frac{dw}{dt}(1) = (4)(1)\left(\frac{\pi}{4}\right) + 1 = \pi + 1$
- (a) $\frac{\partial w}{\partial x} = -y \cos xy, \frac{\partial w}{\partial y} = -x \cos xy, \frac{\partial w}{\partial z} = 1, \frac{dx}{dt} = 1, \frac{dy}{dt} = \frac{1}{t}, \frac{dz}{dt} = e^{t-1} \Rightarrow \frac{dw}{dt} = -y \cos xy - \frac{x \cos xy}{t} + e^{t-1} = -(\ln t)[\cos(t \ln t)] - \frac{t \cos(t \ln t)}{t} + e^{t-1} = -(\ln t)[\cos(t \ln t)] - \cos(t \ln t) + e^{t-1}$; $w = z - \sin xy = e^{t-1} - \sin(t \ln t) \Rightarrow \frac{dw}{dt} = e^{t-1} - [\cos(t \ln t)] \left[\ln t + t \left(\frac{1}{t}\right)\right] = e^{t-1} - (1 + \ln t) \cos(t \ln t)$

(b) $\frac{dw}{dt}(1) = 1 - (1 + 0)(1) = 0$

7. (a) $\frac{\partial z}{\partial u} = \frac{\partial z}{\partial x} \frac{\partial x}{\partial u} + \frac{\partial z}{\partial y} \frac{\partial y}{\partial u} = (4e^x \ln y) \left(\frac{\cos v}{u \cos v} \right) + \left(\frac{4e^x}{y} \right) (\sin v) = \frac{4e^x \ln y}{u} + \frac{4e^x \sin v}{y}$
 $= \frac{4(u \cos v) \ln(u \sin v)}{u} + \frac{4(u \cos v)(\sin v)}{u \sin v} = (4 \cos v) \ln(u \sin v) + 4 \cos v$;
 $\frac{\partial z}{\partial v} = \frac{\partial z}{\partial x} \frac{\partial x}{\partial v} + \frac{\partial z}{\partial y} \frac{\partial y}{\partial v} = (4e^x \ln y) \left(\frac{-u \sin v}{u \cos v} \right) + \left(\frac{4e^x}{y} \right) (u \cos v) = -(4e^x \ln y) (\tan v) + \frac{4e^x u \cos v}{y}$
 $= [-4(u \cos v) \ln(u \sin v)](\tan v) + \frac{4(u \cos v)(u \cos v)}{u \sin v} = (-4u \sin v) \ln(u \sin v) + \frac{4u \cos^2 v}{\sin v}$;
 $z = 4e^x \ln y = 4(u \cos v) \ln(u \sin v) \Rightarrow \frac{\partial z}{\partial u} = (4 \cos v) \ln(u \sin v) + 4(u \cos v) \left(\frac{\sin v}{u \sin v} \right)$
 $= (4 \cos v) \ln(u \sin v) + 4 \cos v$; also $\frac{\partial z}{\partial v} = (-4u \sin v) \ln(u \sin v) + 4(u \cos v) \left(\frac{u \cos v}{u \sin v} \right)$
 $= (-4u \sin v) \ln(u \sin v) + \frac{4u \cos^2 v}{\sin v}$
- (b) At $(2, \frac{\pi}{4})$: $\frac{\partial z}{\partial u} = 4 \cos \frac{\pi}{4} \ln(2 \sin \frac{\pi}{4}) + 4 \cos \frac{\pi}{4} = 2\sqrt{2} \ln \sqrt{2} + 2\sqrt{2} = \sqrt{2}(\ln 2 + 2)$;
 $\frac{\partial z}{\partial v} = (-4)(2) \sin \frac{\pi}{4} \ln(2 \sin \frac{\pi}{4}) + \frac{(4)(2)(\cos^2 \frac{\pi}{4})}{(\sin \frac{\pi}{4})} = -4\sqrt{2} \ln \sqrt{2} + 4\sqrt{2} = -2\sqrt{2} \ln 2 + 4\sqrt{2}$
8. (a) $\frac{\partial z}{\partial u} = \left[\frac{\left(\frac{1}{y}\right)}{\left(\frac{x}{y}\right)^2 + 1} \right] \cos v + \left[\frac{\left(\frac{-x}{y^2}\right)}{\left(\frac{x}{y}\right)^2 + 1} \right] \sin v = \frac{y \cos v}{x^2 + y^2} - \frac{x \sin v}{x^2 + y^2} = \frac{(u \sin v)(\cos v) - (u \cos v)(\sin v)}{u^2} = 0$;
 $\frac{\partial z}{\partial v} = \left[\frac{\left(\frac{1}{y}\right)}{\left(\frac{x}{y}\right)^2 + 1} \right] (-u \sin v) + \left[\frac{\left(\frac{-x}{y^2}\right)}{\left(\frac{x}{y}\right)^2 + 1} \right] u \cos v = -\frac{yu \sin v}{x^2 + y^2} - \frac{xu \cos v}{x^2 + y^2} = \frac{-(u \sin v)(u \sin v) - (u \cos v)(u \cos v)}{u^2}$
 $= -\sin^2 v - \cos^2 v = -1$; $z = \tan^{-1} \left(\frac{x}{y} \right) = \tan^{-1}(\cot v) \Rightarrow \frac{\partial z}{\partial u} = 0$ and $\frac{\partial z}{\partial v} = \left(\frac{1}{1 + \cot^2 v} \right) (-\csc^2 v)$
 $= \frac{-1}{\sin^2 v + \cos^2 v} = -1$
- (b) At $(1.3, \frac{\pi}{6})$: $\frac{\partial z}{\partial u} = 0$ and $\frac{\partial z}{\partial v} = -1$
9. (a) $\frac{\partial w}{\partial u} = \frac{\partial w}{\partial x} \frac{\partial x}{\partial u} + \frac{\partial w}{\partial y} \frac{\partial y}{\partial u} + \frac{\partial w}{\partial z} \frac{\partial z}{\partial u} = (y+z)(1) + (x+z)(1) + (y+x)(v) = x+y+2z+v(y+x)$
 $= (u+v) + (u-v) + 2uv + v(2u) = 2u + 4uv$; $\frac{\partial w}{\partial v} = \frac{\partial w}{\partial x} \frac{\partial x}{\partial v} + \frac{\partial w}{\partial y} \frac{\partial y}{\partial v} + \frac{\partial w}{\partial z} \frac{\partial z}{\partial v}$
 $= (y+z)(1) + (x+z)(-1) + (y+x)(u) = y-x + (y+x)u = -2v + (2u)u = -2v + 2u^2$;
 $w = xy + yz + xz = (u^2 - v^2) + (u^2v - uv^2) + (u^2v + uv^2) = u^2 - v^2 + 2u^2v \Rightarrow \frac{\partial w}{\partial u} = 2u + 4uv$ and
 $\frac{\partial w}{\partial v} = -2v + 2u^2$
- (b) At $(\frac{1}{2}, 1)$: $\frac{\partial w}{\partial u} = 2(\frac{1}{2}) + 4(\frac{1}{2})(1) = 3$ and $\frac{\partial w}{\partial v} = -2(1) + 2(\frac{1}{2})^2 = -\frac{3}{2}$
10. (a) $\frac{\partial w}{\partial u} = \left(\frac{2x}{x^2 + y^2 + z^2} \right) (e^v \sin u + ue^v \cos u) + \left(\frac{2y}{x^2 + y^2 + z^2} \right) (e^v \cos u - ue^v \sin u) + \left(\frac{2z}{x^2 + y^2 + z^2} \right) (e^v)$
 $= \left(\frac{2ue^v \sin u}{u^2 e^{2v} \sin^2 u + u^2 e^{2v} \cos^2 u + u^2 e^{2v}} \right) (e^v \sin u + ue^v \cos u)$
 $+ \left(\frac{2ue^v \cos u}{u^2 e^{2v} \sin^2 u + u^2 e^{2v} \cos^2 u + u^2 e^{2v}} \right) (e^v \cos u - ue^v \sin u)$
 $+ \left(\frac{2ue^v}{u^2 e^{2v} \sin^2 u + u^2 e^{2v} \cos^2 u + u^2 e^{2v}} \right) (e^v) = \frac{2}{u}$;
 $\frac{\partial w}{\partial v} = \left(\frac{2x}{x^2 + y^2 + z^2} \right) (ue^v \sin u) + \left(\frac{2y}{x^2 + y^2 + z^2} \right) (ue^v \cos u) + \left(\frac{2z}{x^2 + y^2 + z^2} \right) (ue^v)$
 $= \left(\frac{2ue^v \sin u}{u^2 e^{2v} \sin^2 u + u^2 e^{2v} \cos^2 u + u^2 e^{2v}} \right) (ue^v \sin u)$
 $+ \left(\frac{2ue^v \cos u}{u^2 e^{2v} \sin^2 u + u^2 e^{2v} \cos^2 u + u^2 e^{2v}} \right) (ue^v \cos u)$
 $+ \left(\frac{2ue^v}{u^2 e^{2v} \sin^2 u + u^2 e^{2v} \cos^2 u + u^2 e^{2v}} \right) (ue^v) = 2$; $w = \ln(u^2 e^{2v} \sin^2 u + u^2 e^{2v} \cos^2 u + u^2 e^{2v}) = \ln(2u^2 e^{2v})$
 $= \ln 2 + 2 \ln u + 2v \Rightarrow \frac{\partial w}{\partial u} = \frac{2}{u}$ and $\frac{\partial w}{\partial v} = 2$
- (b) At $(-2, 0)$: $\frac{\partial w}{\partial u} = \frac{2}{-2} = -1$ and $\frac{\partial w}{\partial v} = 2$
11. (a) $\frac{\partial u}{\partial x} = \frac{\partial u}{\partial p} \frac{\partial p}{\partial x} + \frac{\partial u}{\partial q} \frac{\partial q}{\partial x} + \frac{\partial u}{\partial r} \frac{\partial r}{\partial x} = \frac{1}{q-r} + \frac{r-p}{(q-r)^2} + \frac{p-q}{(q-r)^2} = \frac{q-r+r-p+p-q}{(q-r)^2} = 0$;
 $\frac{\partial u}{\partial y} = \frac{\partial u}{\partial p} \frac{\partial p}{\partial y} + \frac{\partial u}{\partial q} \frac{\partial q}{\partial y} + \frac{\partial u}{\partial r} \frac{\partial r}{\partial y} = \frac{1}{q-r} - \frac{r-p}{(q-r)^2} + \frac{p-q}{(q-r)^2} = \frac{q-r-r+p+p-q}{(q-r)^2} = \frac{2p-2r}{(q-r)^2}$
 $= \frac{(2x+2y+2z) - (2x+2y-2z)}{(2z-2y)^2} = \frac{z}{(z-y)^2}$; $\frac{\partial u}{\partial z} = \frac{\partial u}{\partial p} \frac{\partial p}{\partial z} + \frac{\partial u}{\partial q} \frac{\partial q}{\partial z} + \frac{\partial u}{\partial r} \frac{\partial r}{\partial z}$
 $= \frac{1}{q-r} + \frac{r-p}{(q-r)^2} - \frac{p-q}{(q-r)^2} = \frac{q-r+r-p-p+q}{(q-r)^2} = \frac{2q-2p}{(q-r)^2} = \frac{-4y}{(2z-2y)^2} = -\frac{y}{(z-y)^2}$;

$$u = \frac{p-q}{q-r} = \frac{2y}{2z-2y} = \frac{y}{z-y} \Rightarrow \frac{\partial u}{\partial x} = 0, \frac{\partial u}{\partial y} = \frac{(z-y)-y(-1)}{(z-y)^2} = \frac{z}{(z-y)^2}, \text{ and } \frac{\partial u}{\partial z} = \frac{(z-y)(0)-y(1)}{(z-y)^2} = -\frac{y}{(z-y)^2}$$

(b) At $(\sqrt{3}, 2, 1)$: $\frac{\partial u}{\partial x} = 0, \frac{\partial u}{\partial y} = \frac{1}{(1-2)^2} = 1, \text{ and } \frac{\partial u}{\partial z} = \frac{-2}{(1-2)^2} = -2$

12. (a) $\frac{\partial u}{\partial x} = \frac{e^{qr}}{\sqrt{1-p^2}} (\cos x) + (re^{qr} \sin^{-1} p) (0) + (qe^{qr} \sin^{-1} p) (0) = \frac{e^{qr} \cos x}{\sqrt{1-p^2}} = \frac{e^{z \ln y} \cos x}{\sqrt{1-\sin^2 x}} = y^z$ if $-\frac{\pi}{2} < x < \frac{\pi}{2}$;
 $\frac{\partial u}{\partial y} = \frac{e^{qr}}{\sqrt{1-p^2}} (0) + (re^{qr} \sin^{-1} p) \left(\frac{z^2}{y}\right) + (qe^{qr} \sin^{-1} p) (0) = \frac{z^2 re^{qr} \sin^{-1} p}{y} = \frac{z^2 (\frac{1}{z}) y^z x}{y} = xzy^{z-1}$;
 $\frac{\partial u}{\partial z} = \frac{e^{qr}}{\sqrt{1-p^2}} (0) + (re^{qr} \sin^{-1} p) (2z \ln y) + (qe^{qr} \sin^{-1} p) \left(-\frac{1}{z^2}\right) = (2zre^{qr} \sin^{-1} p) (\ln y) - \frac{qe^{qr} \sin^{-1} p}{z^2}$
 $= (2z) \left(\frac{1}{z}\right) (y^z x \ln y) - \frac{(z^2 \ln y)(y^z)x}{z^2} = xy^z \ln y$; $u = e^{z \ln y} \sin^{-1}(\sin x) = xy^z$ if $-\frac{\pi}{2} \leq x \leq \frac{\pi}{2} \Rightarrow \frac{\partial u}{\partial x} = y^z$,
 $\frac{\partial u}{\partial y} = xzy^{z-1}$, and $\frac{\partial u}{\partial z} = xy^z \ln y$ from direct calculations

(b) At $(\frac{\pi}{4}, \frac{1}{2}, -\frac{1}{2})$: $\frac{\partial u}{\partial x} = \left(\frac{1}{2}\right)^{-1/2} = \sqrt{2}, \frac{\partial u}{\partial y} = \left(\frac{\pi}{4}\right) \left(-\frac{1}{2}\right) \left(\frac{1}{2}\right)^{(-1/2)-1} = -\frac{\pi\sqrt{2}}{4}, \frac{\partial u}{\partial z} = \left(\frac{\pi}{4}\right) \left(\frac{1}{2}\right)^{-1/2} \ln\left(\frac{1}{2}\right) = -\frac{\pi\sqrt{2} \ln 2}{4}$

13. $\frac{dz}{dt} = \frac{\partial z}{\partial x} \frac{dx}{dt} + \frac{\partial z}{\partial y} \frac{dy}{dt}$

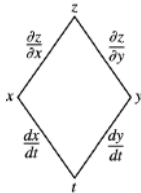

14. $\frac{dz}{dt} = \frac{\partial z}{\partial u} \frac{du}{dt} + \frac{\partial z}{\partial v} \frac{dv}{dt} + \frac{\partial z}{\partial w} \frac{dw}{dt}$

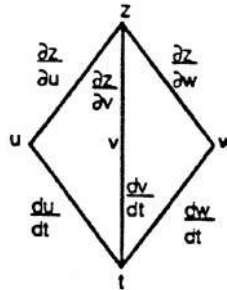

15. $\frac{\partial w}{\partial u} = \frac{\partial w}{\partial x} \frac{\partial x}{\partial u} + \frac{\partial w}{\partial y} \frac{\partial y}{\partial u} + \frac{\partial w}{\partial z} \frac{\partial z}{\partial u}$

$\frac{\partial w}{\partial v} = \frac{\partial w}{\partial x} \frac{\partial x}{\partial v} + \frac{\partial w}{\partial y} \frac{\partial y}{\partial v} + \frac{\partial w}{\partial z} \frac{\partial z}{\partial v}$

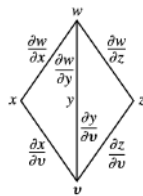
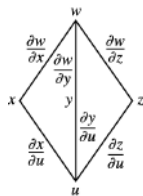

16. $\frac{\partial w}{\partial x} = \frac{\partial w}{\partial r} \frac{\partial r}{\partial x} + \frac{\partial w}{\partial s} \frac{\partial s}{\partial x} + \frac{\partial w}{\partial t} \frac{\partial t}{\partial x}$

$\frac{\partial w}{\partial y} = \frac{\partial w}{\partial r} \frac{\partial r}{\partial y} + \frac{\partial w}{\partial s} \frac{\partial s}{\partial y} + \frac{\partial w}{\partial t} \frac{\partial t}{\partial y}$

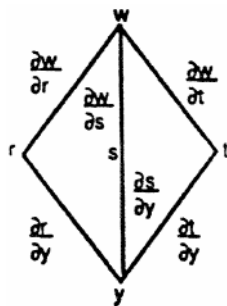
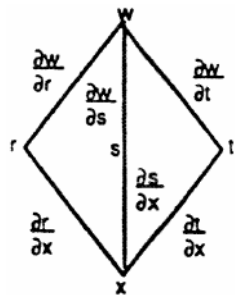

17. $\frac{\partial w}{\partial u} = \frac{\partial w}{\partial x} \frac{\partial x}{\partial u} + \frac{\partial w}{\partial y} \frac{\partial y}{\partial u}$

$\frac{\partial w}{\partial v} = \frac{\partial w}{\partial x} \frac{\partial x}{\partial v} + \frac{\partial w}{\partial y} \frac{\partial y}{\partial v}$

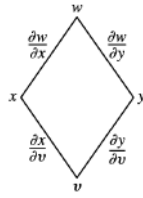
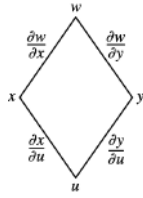

18. $\frac{\partial w}{\partial x} = \frac{\partial w}{\partial u} \frac{\partial u}{\partial x} + \frac{\partial w}{\partial v} \frac{\partial v}{\partial x}$

$\frac{\partial w}{\partial y} = \frac{\partial w}{\partial u} \frac{\partial u}{\partial y} + \frac{\partial w}{\partial v} \frac{\partial v}{\partial y}$

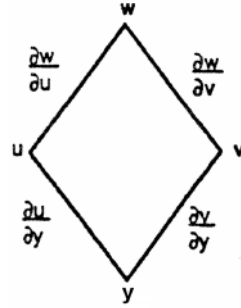
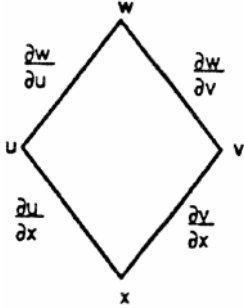

19. $\frac{\partial z}{\partial t} = \frac{\partial z}{\partial x} \frac{\partial x}{\partial t} + \frac{\partial z}{\partial y} \frac{\partial y}{\partial t}$

$\frac{\partial z}{\partial s} = \frac{\partial z}{\partial x} \frac{\partial x}{\partial s} + \frac{\partial z}{\partial y} \frac{\partial y}{\partial s}$

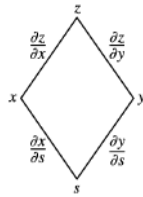
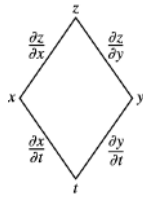

20. $\frac{\partial y}{\partial r} = \frac{dy}{du} \frac{\partial u}{\partial r}$

21. $\frac{\partial w}{\partial s} = \frac{dw}{du} \frac{\partial u}{\partial s}$ $\frac{\partial w}{\partial t} = \frac{dw}{du} \frac{\partial u}{\partial t}$

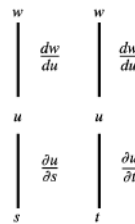
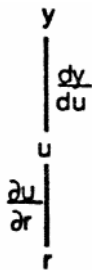

22. $\frac{\partial w}{\partial p} = \frac{\partial w}{\partial x} \frac{\partial x}{\partial p} + \frac{\partial w}{\partial y} \frac{\partial y}{\partial p} + \frac{\partial w}{\partial z} \frac{\partial z}{\partial p} + \frac{\partial w}{\partial v} \frac{\partial v}{\partial p}$

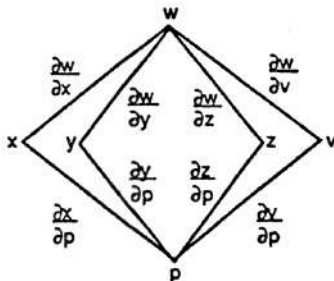

23. $\frac{\partial w}{\partial r} = \frac{\partial w}{\partial x} \frac{dx}{dr} + \frac{\partial w}{\partial y} \frac{dy}{dr} = \frac{\partial w}{\partial x} \frac{dx}{dr}$ since $\frac{dy}{dr} = 0$

$\frac{\partial w}{\partial s} = \frac{\partial w}{\partial x} \frac{dx}{ds} + \frac{\partial w}{\partial y} \frac{dy}{ds} = \frac{\partial w}{\partial y} \frac{dy}{ds}$ since $\frac{dx}{ds} = 0$

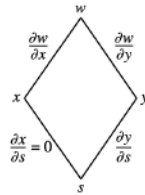
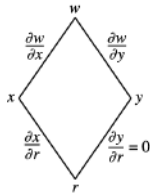

24. $\frac{\partial w}{\partial s} = \frac{\partial w}{\partial x} \frac{\partial x}{\partial s} + \frac{\partial w}{\partial y} \frac{\partial y}{\partial s}$

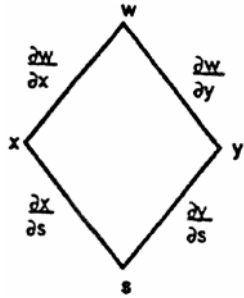

25. Let $F(x, y) = x^3 - 2y^2 + xy = 0 \Rightarrow F_x(x, y) = 3x^2 + y$
 and $F_y(x, y) = -4y + x \Rightarrow \frac{dy}{dx} = -\frac{F_x}{F_y} = -\frac{3x^2 + y}{-4y + x}$
 $\Rightarrow \frac{dy}{dx}(1, 1) = \frac{4}{3}$

26. Let $F(x, y) = xy + y^2 - 3x - 3 = 0 \Rightarrow F_x(x, y) = y - 3$ and $F_y(x, y) = x + 2y \Rightarrow \frac{dy}{dx} = -\frac{F_x}{F_y} = -\frac{y-3}{x+2y}$
 $\Rightarrow \frac{dy}{dx}(-1, 1) = 2$

27. Let $F(x, y) = x^2 + xy + y^2 - 7 = 0 \Rightarrow F_x(x, y) = 2x + y$ and $F_y(x, y) = x + 2y \Rightarrow \frac{dy}{dx} = -\frac{F_x}{F_y} = -\frac{2x+y}{x+2y}$
 $\Rightarrow \frac{dy}{dx}(1, 2) = -\frac{4}{5}$

28. Let $F(x, y) = xe^y + \sin xy + y - \ln 2 = 0 \Rightarrow F_x(x, y) = e^y + y \cos xy$ and $F_y(x, y) = xe^y + x \sin xy + 1$
 $\Rightarrow \frac{dy}{dx} = -\frac{F_x}{F_y} = -\frac{e^y + y \cos xy}{xe^y + x \sin xy + 1} \Rightarrow \frac{dy}{dx}(0, \ln 2) = -(2 + \ln 2)$

29. Let $F(x, y, z) = z^3 - xy + yz + y^3 - 2 = 0 \Rightarrow F_x(x, y, z) = -y, F_y(x, y, z) = -x + z + 3y^2, F_z(x, y, z) = 3z^2 + y$
 $\Rightarrow \frac{\partial z}{\partial x} = -\frac{F_x}{F_z} = -\frac{-y}{3z^2 + y} = \frac{y}{3z^2 + y} \Rightarrow \frac{\partial z}{\partial x}(1, 1, 1) = \frac{1}{4}; \frac{\partial z}{\partial y} = -\frac{F_y}{F_z} = -\frac{-x + z + 3y^2}{3z^2 + y} = \frac{x - z - 3y^2}{3z^2 + y}$
 $\Rightarrow \frac{\partial z}{\partial y}(1, 1, 1) = -\frac{3}{4}$

30. Let $F(x, y, z) = \frac{1}{x} + \frac{1}{y} + \frac{1}{z} - 1 = 0 \Rightarrow F_x(x, y, z) = -\frac{1}{x^2}, F_y(x, y, z) = -\frac{1}{y^2}, F_z(x, y, z) = -\frac{1}{z^2}$
 $\Rightarrow \frac{\partial z}{\partial x} = -\frac{F_x}{F_z} = -\frac{(-\frac{1}{x^2})}{(-\frac{1}{z^2})} = -\frac{z^2}{x^2} \Rightarrow \frac{\partial z}{\partial x}(2, 3, 6) = -9; \frac{\partial z}{\partial y} = -\frac{F_y}{F_z} = -\frac{(-\frac{1}{y^2})}{(-\frac{1}{z^2})} = -\frac{z^2}{y^2} \Rightarrow \frac{\partial z}{\partial y}(2, 3, 6) = -4$

31. Let $F(x, y, z) = \sin(x + y) + \sin(y + z) + \sin(x + z) = 0 \Rightarrow F_x(x, y, z) = \cos(x + y) + \cos(x + z),$
 $F_y(x, y, z) = \cos(x + y) + \cos(y + z), F_z(x, y, z) = \cos(y + z) + \cos(x + z) \Rightarrow \frac{\partial z}{\partial x} = -\frac{F_x}{F_z}$
 $= -\frac{\cos(x + y) + \cos(x + z)}{\cos(y + z) + \cos(x + z)} \Rightarrow \frac{\partial z}{\partial x}(\pi, \pi, \pi) = -1; \frac{\partial z}{\partial y} = -\frac{F_y}{F_z} = -\frac{\cos(x + y) + \cos(y + z)}{\cos(y + z) + \cos(x + z)} \Rightarrow \frac{\partial z}{\partial y}(\pi, \pi, \pi) = -1$

32. Let $F(x, y, z) = xe^y + ye^z + 2 \ln x - 2 - 3 \ln 2 = 0 \Rightarrow F_x(x, y, z) = e^y + \frac{2}{x}, F_y(x, y, z) = xe^y + e^z, F_z(x, y, z) = ye^z$
 $\Rightarrow \frac{\partial z}{\partial x} = -\frac{F_x}{F_z} = -\frac{(e^y + \frac{2}{x})}{ye^z} \Rightarrow \frac{\partial z}{\partial x}(1, \ln 2, \ln 3) = -\frac{4}{3 \ln 2}; \frac{\partial z}{\partial y} = -\frac{F_y}{F_z} = -\frac{xe^y + e^z}{ye^z} \Rightarrow \frac{\partial z}{\partial y}(1, \ln 2, \ln 3) = -\frac{5}{3 \ln 2}$

33. $\frac{\partial w}{\partial r} = \frac{\partial w}{\partial x} \frac{\partial x}{\partial r} + \frac{\partial w}{\partial y} \frac{\partial y}{\partial r} + \frac{\partial w}{\partial z} \frac{\partial z}{\partial r} = 2(x + y + z)(1) + 2(x + y + z)[- \sin(r + s)] + 2(x + y + z)[\cos(r + s)]$
 $= 2(x + y + z)[1 - \sin(r + s) + \cos(r + s)] = 2[r - s + \cos(r + s) + \sin(r + s)][1 - \sin(r + s) + \cos(r + s)]$

$$\Rightarrow \frac{\partial w}{\partial r} \Big|_{r=1, s=-1} = 2(3)(2) = 12$$

$$34. \frac{\partial w}{\partial v} = \frac{\partial w}{\partial x} \frac{\partial x}{\partial v} + \frac{\partial w}{\partial y} \frac{\partial y}{\partial v} + \frac{\partial w}{\partial z} \frac{\partial z}{\partial v} = y \left(\frac{2v}{u} \right) + x(1) + \left(\frac{1}{z} \right) (0) = (u+v) \left(\frac{2v}{u} \right) + \frac{v^2}{u} \Rightarrow \frac{\partial w}{\partial v} \Big|_{u=-1, v=2} = (1) \left(\frac{4}{-1} \right) + \left(\frac{4}{-1} \right) = -8$$

$$35. \frac{\partial w}{\partial v} = \frac{\partial w}{\partial x} \frac{\partial x}{\partial v} + \frac{\partial w}{\partial y} \frac{\partial y}{\partial v} = \left(2x - \frac{y}{x^2} \right) (-2) + \left(\frac{1}{x} \right) (1) = \left[2(u-2v+1) - \frac{2u+v-2}{(u-2v+1)^2} \right] (-2) + \frac{1}{u-2v+1} \Rightarrow \frac{\partial w}{\partial v} \Big|_{u=0, v=0} = -7$$

$$36. \frac{\partial z}{\partial u} = \frac{\partial z}{\partial x} \frac{\partial x}{\partial u} + \frac{\partial z}{\partial y} \frac{\partial y}{\partial u} = (y \cos xy + \sin y)(2u) + (x \cos xy + x \cos y)(v) = [uv \cos(u^3v + uv^3) + \sin uv](2u) + [(u^2 + v^2) \cos(u^3v + uv^3) + (u^2 + v^2) \cos uv](v) \Rightarrow \frac{\partial z}{\partial u} \Big|_{u=0, v=1} = 0 + (\cos 0 + \cos 0)(1) = 2$$

$$37. \frac{\partial z}{\partial u} = \frac{dz}{dx} \frac{\partial x}{\partial u} = \left(\frac{5}{1+x^2} \right) e^u = \left[\frac{5}{1+(e^u + \ln v)^2} \right] e^u \Rightarrow \frac{\partial z}{\partial u} \Big|_{u=\ln 2, v=1} = \left[\frac{5}{1+(2)^2} \right] (2) = 2; \frac{\partial z}{\partial v} = \frac{dz}{dx} \frac{\partial x}{\partial v} = \left(\frac{5}{1+x^2} \right) \left(\frac{1}{v} \right) = \left[\frac{5}{1+(e^u + \ln v)^2} \right] \left(\frac{1}{v} \right) \Rightarrow \frac{\partial z}{\partial v} \Big|_{u=\ln 2, v=1} = \left[\frac{5}{1+(2)^2} \right] (1) = 1$$

$$38. \frac{\partial z}{\partial u} = \frac{dz}{dq} \frac{\partial q}{\partial u} = \left(\frac{1}{q} \right) \left(\frac{\sqrt{v+3}}{1+u^2} \right) = \left(\frac{1}{\sqrt{v+3} \tan^{-1} u} \right) \left(\frac{\sqrt{v+3}}{1+u^2} \right) = \frac{1}{(\tan^{-1} u)(1+u^2)} \Rightarrow \frac{\partial z}{\partial u} \Big|_{u=1, v=-2} = \frac{1}{(\tan^{-1} 1)(1+1^2)} = \frac{2}{\pi}; \frac{\partial z}{\partial v} = \frac{dz}{dq} \frac{\partial q}{\partial v} = \left(\frac{1}{q} \right) \left(\frac{\tan^{-1} u}{2\sqrt{v+3}} \right) = \left(\frac{1}{\sqrt{v+3} \tan^{-1} u} \right) \left(\frac{\tan^{-1} u}{2\sqrt{v+3}} \right) = \frac{1}{2(v+3)} \Rightarrow \frac{\partial z}{\partial v} \Big|_{u=1, v=-2} = \frac{1}{2}$$

$$39. V = IR \Rightarrow \frac{\partial V}{\partial I} = R \text{ and } \frac{\partial V}{\partial R} = I; \frac{dV}{dt} = \frac{\partial V}{\partial I} \frac{dI}{dt} + \frac{\partial V}{\partial R} \frac{dR}{dt} = R \frac{dI}{dt} + I \frac{dR}{dt} \Rightarrow -0.01 \text{ volts/sec} = (600 \text{ ohms}) \frac{dI}{dt} + (0.04 \text{ amps})(0.5 \text{ ohms/sec}) \Rightarrow \frac{dI}{dt} = -0.00005 \text{ amps/sec}$$

$$40. V = abc \Rightarrow \frac{dV}{dt} = \frac{\partial V}{\partial a} \frac{da}{dt} + \frac{\partial V}{\partial b} \frac{db}{dt} + \frac{\partial V}{\partial c} \frac{dc}{dt} = (bc) \frac{da}{dt} + (ac) \frac{db}{dt} + (ab) \frac{dc}{dt} \Rightarrow \frac{dV}{dt} \Big|_{a=1, b=2, c=3} = (2 \text{ m})(3 \text{ m})(1 \text{ m/sec}) + (1 \text{ m})(3 \text{ m})(1 \text{ m/sec}) + (1 \text{ m})(2 \text{ m})(-3 \text{ m/sec}) = 3 \text{ m}^3/\text{sec}$$

and the volume is increasing; $S = 2ab + 2ac + 2bc \Rightarrow \frac{dS}{dt} = \frac{\partial S}{\partial a} \frac{da}{dt} + \frac{\partial S}{\partial b} \frac{db}{dt} + \frac{\partial S}{\partial c} \frac{dc}{dt} = 2(b+c) \frac{da}{dt} + 2(a+c) \frac{db}{dt} + 2(a+b) \frac{dc}{dt} \Rightarrow \frac{dS}{dt} \Big|_{a=1, b=2, c=3} = 2(5 \text{ m})(1 \text{ m/sec}) + 2(4 \text{ m})(1 \text{ m/sec}) + 2(3 \text{ m})(-3 \text{ m/sec}) = 0 \text{ m}^2/\text{sec}$ and the surface area is not changing;

$$D = \sqrt{a^2 + b^2 + c^2} \Rightarrow \frac{dD}{dt} = \frac{\partial D}{\partial a} \frac{da}{dt} + \frac{\partial D}{\partial b} \frac{db}{dt} + \frac{\partial D}{\partial c} \frac{dc}{dt} = \frac{1}{\sqrt{a^2 + b^2 + c^2}} \left(a \frac{da}{dt} + b \frac{db}{dt} + c \frac{dc}{dt} \right) \Rightarrow \frac{dD}{dt} \Big|_{a=1, b=2, c=3} = \left(\frac{1}{\sqrt{14} \text{ m}} \right) [(1 \text{ m})(1 \text{ m/sec}) + (2 \text{ m})(1 \text{ m/sec}) + (3 \text{ m})(-3 \text{ m/sec})] = -\frac{6}{\sqrt{14}} \text{ m/sec} < 0 \Rightarrow \text{the diagonals are decreasing in length}$$

$$41. \frac{\partial f}{\partial x} = \frac{\partial f}{\partial u} \frac{\partial u}{\partial x} + \frac{\partial f}{\partial v} \frac{\partial v}{\partial x} + \frac{\partial f}{\partial w} \frac{\partial w}{\partial x} = \frac{\partial f}{\partial u} (1) + \frac{\partial f}{\partial v} (0) + \frac{\partial f}{\partial w} (-1) = \frac{\partial f}{\partial u} - \frac{\partial f}{\partial w}, \frac{\partial f}{\partial y} = \frac{\partial f}{\partial u} \frac{\partial u}{\partial y} + \frac{\partial f}{\partial v} \frac{\partial v}{\partial y} + \frac{\partial f}{\partial w} \frac{\partial w}{\partial y} = \frac{\partial f}{\partial u} (-1) + \frac{\partial f}{\partial v} (1) + \frac{\partial f}{\partial w} (0) = -\frac{\partial f}{\partial u} + \frac{\partial f}{\partial v}, \text{ and } \frac{\partial f}{\partial z} = \frac{\partial f}{\partial u} \frac{\partial u}{\partial z} + \frac{\partial f}{\partial v} \frac{\partial v}{\partial z} + \frac{\partial f}{\partial w} \frac{\partial w}{\partial z} = \frac{\partial f}{\partial u} (0) + \frac{\partial f}{\partial v} (-1) + \frac{\partial f}{\partial w} (1) = -\frac{\partial f}{\partial v} + \frac{\partial f}{\partial w} \Rightarrow \frac{\partial f}{\partial x} + \frac{\partial f}{\partial y} + \frac{\partial f}{\partial z} = 0$$

$$42. (a) \frac{\partial w}{\partial r} = f_x \frac{\partial x}{\partial r} + f_y \frac{\partial y}{\partial r} = f_x \cos \theta + f_y \sin \theta \text{ and } \frac{\partial w}{\partial \theta} = f_x(-r \sin \theta) + f_y(r \cos \theta) \Rightarrow \frac{1}{r} \frac{\partial w}{\partial \theta} = -f_x \sin \theta + f_y \cos \theta$$

$$(b) \frac{\partial w}{\partial r} \sin \theta = f_x \sin \theta \cos \theta + f_y \sin^2 \theta \text{ and } \left(\frac{\cos \theta}{r} \right) \frac{\partial w}{\partial \theta} = -f_x \sin \theta \cos \theta + f_y \cos^2 \theta \Rightarrow f_y = (\sin \theta) \frac{\partial w}{\partial r} + \left(\frac{\cos \theta}{r} \right) \frac{\partial w}{\partial \theta}; \text{ then } \frac{\partial w}{\partial r} = f_x \cos \theta + \left[(\sin \theta) \frac{\partial w}{\partial r} + \left(\frac{\cos \theta}{r} \right) \frac{\partial w}{\partial \theta} \right] (\sin \theta) \Rightarrow f_x \cos \theta = \frac{\partial w}{\partial r} - (\sin^2 \theta) \frac{\partial w}{\partial r} - \left(\frac{\sin \theta \cos \theta}{r} \right) \frac{\partial w}{\partial \theta} = (1 - \sin^2 \theta) \frac{\partial w}{\partial r} - \left(\frac{\sin \theta \cos \theta}{r} \right) \frac{\partial w}{\partial \theta} \Rightarrow f_x = (\cos \theta) \frac{\partial w}{\partial r} - \left(\frac{\sin \theta}{r} \right) \frac{\partial w}{\partial \theta}$$

$$(c) (f_x)^2 = (\cos^2 \theta) \left(\frac{\partial w}{\partial r} \right)^2 - \left(\frac{2 \sin \theta \cos \theta}{r} \right) \left(\frac{\partial w}{\partial r} \frac{\partial w}{\partial \theta} \right) + \left(\frac{\sin^2 \theta}{r^2} \right) \left(\frac{\partial w}{\partial \theta} \right)^2 \text{ and } (f_y)^2 = (\sin^2 \theta) \left(\frac{\partial w}{\partial r} \right)^2 + \left(\frac{2 \sin \theta \cos \theta}{r} \right) \left(\frac{\partial w}{\partial r} \frac{\partial w}{\partial \theta} \right) + \left(\frac{\cos^2 \theta}{r^2} \right) \left(\frac{\partial w}{\partial \theta} \right)^2 \Rightarrow (f_x)^2 + (f_y)^2 = \left(\frac{\partial w}{\partial r} \right)^2 + \frac{1}{r^2} \left(\frac{\partial w}{\partial \theta} \right)^2$$

$$\begin{aligned}
 43. \quad w_x &= \frac{\partial w}{\partial x} = \frac{\partial w}{\partial u} \frac{\partial u}{\partial x} + \frac{\partial w}{\partial v} \frac{\partial v}{\partial x} = x \frac{\partial w}{\partial u} + y \frac{\partial w}{\partial v} \Rightarrow w_{xx} = \frac{\partial w}{\partial u} + x \frac{\partial}{\partial x} \left(\frac{\partial w}{\partial u} \right) + y \frac{\partial}{\partial x} \left(\frac{\partial w}{\partial v} \right) \\
 &= \frac{\partial w}{\partial u} + x \left(\frac{\partial^2 w}{\partial u^2} \frac{\partial u}{\partial x} + \frac{\partial^2 w}{\partial v \partial u} \frac{\partial v}{\partial x} \right) + y \left(\frac{\partial^2 w}{\partial u \partial v} \frac{\partial u}{\partial x} + \frac{\partial^2 w}{\partial v^2} \frac{\partial v}{\partial x} \right) = \frac{\partial w}{\partial u} + x \left(x \frac{\partial^2 w}{\partial u^2} + y \frac{\partial^2 w}{\partial v \partial u} \right) + y \left(x \frac{\partial^2 w}{\partial u \partial v} + y \frac{\partial^2 w}{\partial v^2} \right) \\
 &= \frac{\partial w}{\partial u} + x^2 \frac{\partial^2 w}{\partial u^2} + 2xy \frac{\partial^2 w}{\partial v \partial u} + y^2 \frac{\partial^2 w}{\partial v^2}; \quad w_y = \frac{\partial w}{\partial y} = \frac{\partial w}{\partial u} \frac{\partial u}{\partial y} + \frac{\partial w}{\partial v} \frac{\partial v}{\partial y} = -y \frac{\partial w}{\partial u} + x \frac{\partial w}{\partial v} \\
 \Rightarrow w_{yy} &= -\frac{\partial w}{\partial u} - y \left(\frac{\partial^2 w}{\partial u^2} \frac{\partial u}{\partial y} + \frac{\partial^2 w}{\partial v \partial u} \frac{\partial v}{\partial y} \right) + x \left(\frac{\partial^2 w}{\partial u \partial v} \frac{\partial u}{\partial y} + \frac{\partial^2 w}{\partial v^2} \frac{\partial v}{\partial y} \right) \\
 &= -\frac{\partial w}{\partial u} - y \left(-y \frac{\partial^2 w}{\partial u^2} + x \frac{\partial^2 w}{\partial v \partial u} \right) + x \left(-y \frac{\partial^2 w}{\partial u \partial v} + x \frac{\partial^2 w}{\partial v^2} \right) = -\frac{\partial w}{\partial u} + y^2 \frac{\partial^2 w}{\partial u^2} - 2xy \frac{\partial^2 w}{\partial v \partial u} + x^2 \frac{\partial^2 w}{\partial v^2}; \text{ thus} \\
 w_{xx} + w_{yy} &= (x^2 + y^2) \frac{\partial^2 w}{\partial u^2} + (x^2 + y^2) \frac{\partial^2 w}{\partial v^2} = (x^2 + y^2)(w_{uu} + w_{vv}) = 0, \text{ since } w_{uu} + w_{vv} = 0
 \end{aligned}$$

$$\begin{aligned}
 44. \quad \frac{\partial w}{\partial x} &= f'(u)(1) + g'(v)(1) = f'(u) + g'(v) \Rightarrow w_{xx} = f''(u)(1) + g''(v)(1) = f''(u) + g''(v); \\
 \frac{\partial w}{\partial y} &= f'(u)(i) + g'(v)(-i) \Rightarrow w_{yy} = f''(u)(i^2) + g''(v)(i^2) = -f''(u) - g''(v) \Rightarrow w_{xx} + w_{yy} = 0
 \end{aligned}$$

$$\begin{aligned}
 45. \quad f_x(x, y, z) &= \cos t, \quad f_y(x, y, z) = \sin t, \quad \text{and } f_z(x, y, z) = t^2 + t - 2 \Rightarrow \frac{df}{dt} = \frac{\partial f}{\partial x} \frac{dx}{dt} + \frac{\partial f}{\partial y} \frac{dy}{dt} + \frac{\partial f}{\partial z} \frac{dz}{dt} \\
 &= (\cos t)(-\sin t) + (\sin t)(\cos t) + (t^2 + t - 2)(1) = t^2 + t - 2; \quad \frac{df}{dt} = 0 \Rightarrow t^2 + t - 2 = 0 \Rightarrow t = -2 \\
 \text{or } t &= 1; \quad t = -2 \Rightarrow x = \cos(-2), \quad y = \sin(-2), \quad z = -2 \text{ for the point } (\cos(-2), \sin(-2), -2); \quad t = 1 \Rightarrow x = \cos 1, \\
 &y = \sin 1, \quad z = 1 \text{ for the point } (\cos 1, \sin 1, 1)
 \end{aligned}$$

$$\begin{aligned}
 46. \quad \frac{dw}{dt} &= \frac{\partial w}{\partial x} \frac{dx}{dt} + \frac{\partial w}{\partial y} \frac{dy}{dt} + \frac{\partial w}{\partial z} \frac{dz}{dt} = (2xe^{2y} \cos 3z)(-\sin t) + (2x^2e^{2y} \cos 3z) \left(\frac{1}{1+t^2} \right) + (-3x^2e^{2y} \sin 3z)(1) \\
 &= -2xe^{2y} \cos 3z \sin t + \frac{2x^2e^{2y} \cos 3z}{1+t^2} - 3x^2e^{2y} \sin 3z; \text{ at the point on the curve } z = 0 \Rightarrow t = z = 0 \\
 \Rightarrow \frac{dw}{dt} \Big|_{(1, \ln 2, 0)} &= 0 + \frac{2(1)^2(4)(1)}{2} - 0 = 4
 \end{aligned}$$

$$\begin{aligned}
 47. \quad (a) \quad \frac{\partial T}{\partial x} &= 8x - 4y \text{ and } \frac{\partial T}{\partial y} = 8y - 4x \Rightarrow \frac{dT}{dt} = \frac{\partial T}{\partial x} \frac{dx}{dt} + \frac{\partial T}{\partial y} \frac{dy}{dt} = (8x - 4y)(-\sin t) + (8y - 4x)(\cos t) \\
 &= (8 \cos t - 4 \sin t)(-\sin t) + (8 \sin t - 4 \cos t)(\cos t) = 4 \sin^2 t - 4 \cos^2 t \Rightarrow \frac{dT}{dt} = 16 \sin t \cos t; \\
 \frac{dT}{dt} &= 0 \Rightarrow 4 \sin^2 t - 4 \cos^2 t = 0 \Rightarrow \sin^2 t = \cos^2 t \Rightarrow \sin t = \cos t \text{ or } \sin t = -\cos t \Rightarrow t = \frac{\pi}{4}, \frac{5\pi}{4}, \frac{3\pi}{4}, \frac{7\pi}{4} \text{ on} \\
 &\text{the interval } 0 \leq t \leq 2\pi;
 \end{aligned}$$

$$\frac{d^2T}{dt^2} \Big|_{t=\frac{\pi}{4}} = 16 \sin \frac{\pi}{4} \cos \frac{\pi}{4} > 0 \Rightarrow T \text{ has a minimum at } (x, y) = \left(\frac{\sqrt{2}}{2}, \frac{\sqrt{2}}{2} \right);$$

$$\frac{d^2T}{dt^2} \Big|_{t=\frac{3\pi}{4}} = 16 \sin \frac{3\pi}{4} \cos \frac{3\pi}{4} < 0 \Rightarrow T \text{ has a maximum at } (x, y) = \left(-\frac{\sqrt{2}}{2}, \frac{\sqrt{2}}{2} \right);$$

$$\frac{d^2T}{dt^2} \Big|_{t=\frac{5\pi}{4}} = 16 \sin \frac{5\pi}{4} \cos \frac{5\pi}{4} > 0 \Rightarrow T \text{ has a minimum at } (x, y) = \left(-\frac{\sqrt{2}}{2}, -\frac{\sqrt{2}}{2} \right);$$

$$\frac{d^2T}{dt^2} \Big|_{t=\frac{7\pi}{4}} = 16 \sin \frac{7\pi}{4} \cos \frac{7\pi}{4} < 0 \Rightarrow T \text{ has a maximum at } (x, y) = \left(\frac{\sqrt{2}}{2}, -\frac{\sqrt{2}}{2} \right)$$

$$\begin{aligned}
 (b) \quad T &= 4x^2 - 4xy + 4y^2 \Rightarrow \frac{\partial T}{\partial x} = 8x - 4y, \text{ and } \frac{\partial T}{\partial y} = 8y - 4x \text{ so the extreme values occur at the four points} \\
 \text{found in part (a): } T \left(-\frac{\sqrt{2}}{2}, \frac{\sqrt{2}}{2} \right) &= T \left(\frac{\sqrt{2}}{2}, -\frac{\sqrt{2}}{2} \right) = 4 \left(\frac{1}{2} \right) - 4 \left(-\frac{1}{2} \right) + 4 \left(\frac{1}{2} \right) = 6, \text{ the maximum and} \\
 T \left(\frac{\sqrt{2}}{2}, \frac{\sqrt{2}}{2} \right) &= T \left(-\frac{\sqrt{2}}{2}, -\frac{\sqrt{2}}{2} \right) = 4 \left(\frac{1}{2} \right) - 4 \left(\frac{1}{2} \right) + 4 \left(\frac{1}{2} \right) = 2, \text{ the minimum}
 \end{aligned}$$

$$\begin{aligned}
 48. \quad (a) \quad \frac{\partial T}{\partial x} &= y \text{ and } \frac{\partial T}{\partial y} = x \Rightarrow \frac{dT}{dt} = \frac{\partial T}{\partial x} \frac{dx}{dt} + \frac{\partial T}{\partial y} \frac{dy}{dt} = y \left(-2\sqrt{2} \sin t \right) + x \left(\sqrt{2} \cos t \right) \\
 &= \left(\sqrt{2} \sin t \right) \left(-2\sqrt{2} \sin t \right) + \left(2\sqrt{2} \cos t \right) \left(\sqrt{2} \cos t \right) = -4 \sin^2 t + 4 \cos^2 t = -4 \sin^2 t + 4(1 - \sin^2 t) \\
 &= 4 - 8 \sin^2 t \Rightarrow \frac{dT}{dt} = -16 \sin t \cos t; \quad \frac{dT}{dt} = 0 \Rightarrow 4 - 8 \sin^2 t = 0 \Rightarrow \sin^2 t = \frac{1}{2} \Rightarrow \sin t = \pm \frac{1}{\sqrt{2}} \Rightarrow t = \frac{\pi}{4},
 \end{aligned}$$

$$\frac{3\pi}{4}, \frac{5\pi}{4}, \frac{7\pi}{4} \text{ on the interval } 0 \leq t \leq 2\pi;$$

$$\frac{d^2T}{dt^2} \Big|_{t=\frac{\pi}{4}} = -8 \sin 2 \left(\frac{\pi}{4} \right) = -8 \Rightarrow T \text{ has a maximum at } (x, y) = (2, 1);$$

$$\frac{d^2T}{dt^2} \Big|_{t=\frac{3\pi}{4}} = -8 \sin 2 \left(\frac{3\pi}{4} \right) = 8 \Rightarrow T \text{ has a minimum at } (x, y) = (-2, 1);$$

$$\frac{d^2T}{dt^2} \Big|_{t=\frac{5\pi}{4}} = -8 \sin 2 \left(\frac{5\pi}{4} \right) = -8 \Rightarrow T \text{ has a maximum at } (x, y) = (-2, -1);$$

$$\frac{d^2T}{dt^2} \Big|_{t=\frac{7\pi}{4}} = -8 \sin 2 \left(\frac{7\pi}{4} \right) = 8 \Rightarrow T \text{ has a minimum at } (x, y) = (2, -1)$$

- (b) $T = xy - 2 \Rightarrow \frac{\partial T}{\partial x} = y$ and $\frac{\partial T}{\partial y} = x$ so the extreme values occur at the four points found in part (a):
 $T(2, 1) = T(-2, -1) = 0$, the maximum and $T(-2, 1) = T(2, -1) = -4$, the minimum

49. $G(u, x) = \int_a^u g(t, x) dt$ where $u = f(x) \Rightarrow \frac{dG}{dx} = \frac{\partial G}{\partial u} \frac{du}{dx} + \frac{\partial G}{\partial x} \frac{dx}{dx} = g(u, x)f'(x) + \int_a^u g_x(t, x) dt$; thus
 $F(x) = \int_0^{x^2} \sqrt{t^4 + x^3} dt \Rightarrow F'(x) = \sqrt{(x^2)^4 + x^3} (2x) + \int_0^{x^2} \frac{\partial}{\partial x} \sqrt{t^4 + x^3} dt = 2x\sqrt{x^8 + x^3} + \int_0^{x^2} \frac{3x^2}{2\sqrt{t^4 + x^3}} dt$

50. Using the result in Exercise 49, $F(x) = \int_{x^2}^1 \sqrt{t^3 + x^2} dt = - \int_1^{x^2} \sqrt{t^3 + x^2} dt \Rightarrow F'(x)$
 $= \left[-\sqrt{(x^2)^3 + x^2} x^2 - \int_1^{x^2} \frac{\partial}{\partial x} \sqrt{t^3 + x^2} dt \right] = -x^2\sqrt{x^6 + x^2} + \int_{x^2}^1 \frac{x}{\sqrt{t^3 + x^2}} dt$

14.5 DIRECTIONAL DERIVATIVES AND GRADIENT VECTORS

1. $\frac{\partial f}{\partial x} = -1, \frac{\partial f}{\partial y} = 1 \Rightarrow \nabla f = -\mathbf{i} + \mathbf{j}; f(2, 1) = -1$
 $\Rightarrow -1 = y - x$ is the level curve

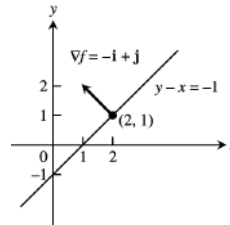

2. $\frac{\partial f}{\partial x} = \frac{2x}{x^2 + y^2} \Rightarrow \frac{\partial f}{\partial x}(1, 1) = 1; \frac{\partial f}{\partial y} = \frac{2y}{x^2 + y^2}$
 $\Rightarrow \frac{\partial f}{\partial y}(1, 1) = 1 \Rightarrow \nabla f = \mathbf{i} + \mathbf{j}; f(1, 1) = \ln 2 \Rightarrow \ln 2$
 $= \ln(x^2 + y^2) \Rightarrow 2 = x^2 + y^2$ is the level curve

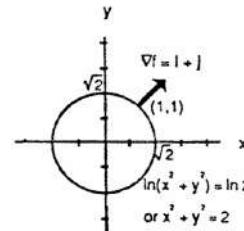

3. $\frac{\partial g}{\partial x} = -2x \Rightarrow \frac{\partial g}{\partial x}(-1, 0) = 2; \frac{\partial g}{\partial y} = 1$
 $\Rightarrow \nabla g = 2\mathbf{i} + \mathbf{j}; g(-1, 0) = -1$
 $\Rightarrow -1 = y - x^2$ is the level curve

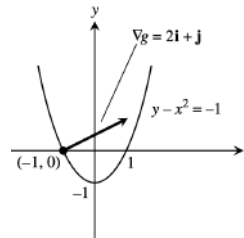

4. $\frac{\partial g}{\partial x} = x \Rightarrow \frac{\partial g}{\partial x}(\sqrt{2}, 1) = \sqrt{2}; \frac{\partial g}{\partial y} = -y$
 $\Rightarrow \frac{\partial g}{\partial y}(\sqrt{2}, 1) = -1 \Rightarrow \nabla g = \sqrt{2}\mathbf{i} - \mathbf{j};$
 $g(\sqrt{2}, 1) = \frac{1}{2} \Rightarrow \frac{1}{2} = \frac{x^2}{2} - \frac{y^2}{2}$ or $1 = x^2 - y^2$ is the level curve
 curve

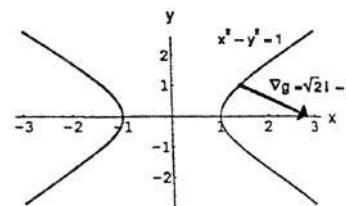

5. $\frac{\partial f}{\partial x} = 2x + \frac{z}{x} \Rightarrow \frac{\partial f}{\partial x}(1, 1, 1) = 3; \frac{\partial f}{\partial y} = 2y \Rightarrow \frac{\partial f}{\partial y}(1, 1, 1) = 2; \frac{\partial f}{\partial z} = -4z + \ln x \Rightarrow \frac{\partial f}{\partial z}(1, 1, 1) = -4;$
 thus $\nabla f = 3\mathbf{i} + 2\mathbf{j} - 4\mathbf{k}$

6. $\frac{\partial f}{\partial x} = -6xz + \frac{z}{x^2z^2+1} \Rightarrow \frac{\partial f}{\partial x}(1, 1, 1) = -\frac{11}{2}$; $\frac{\partial f}{\partial y} = -6yz \Rightarrow \frac{\partial f}{\partial y}(1, 1, 1) = -6$; $\frac{\partial f}{\partial z} = 6z^2 - 3(x^2 + y^2) + \frac{x}{x^2z^2+1}$
 $\Rightarrow \frac{\partial f}{\partial z}(1, 1, 1) = \frac{1}{2}$; thus $\nabla f = -\frac{11}{2}\mathbf{i} - 6\mathbf{j} + \frac{1}{2}\mathbf{k}$
7. $\frac{\partial f}{\partial x} = -\frac{x}{(x^2+y^2+z^2)^{3/2}} + \frac{1}{x} \Rightarrow \frac{\partial f}{\partial x}(-1, 2, -2) = -\frac{26}{27}$; $\frac{\partial f}{\partial y} = -\frac{y}{(x^2+y^2+z^2)^{3/2}} + \frac{1}{y} \Rightarrow \frac{\partial f}{\partial y}(-1, 2, -2) = \frac{23}{54}$;
 $\frac{\partial f}{\partial z} = -\frac{z}{(x^2+y^2+z^2)^{3/2}} + \frac{1}{z} \Rightarrow \frac{\partial f}{\partial z}(-1, 2, -2) = -\frac{23}{54}$; thus $\nabla f = -\frac{26}{27}\mathbf{i} + \frac{23}{54}\mathbf{j} - \frac{23}{54}\mathbf{k}$
8. $\frac{\partial f}{\partial x} = e^{x+y} \cos z + \frac{y+1}{\sqrt{1-x^2}} \Rightarrow \frac{\partial f}{\partial x}(0, 0, \frac{\pi}{6}) = \frac{\sqrt{3}}{2} + 1$; $\frac{\partial f}{\partial y} = e^{x+y} \cos z + \sin^{-1} x \Rightarrow \frac{\partial f}{\partial y}(0, 0, \frac{\pi}{6}) = \frac{\sqrt{3}}{2}$;
 $\frac{\partial f}{\partial z} = -e^{x+y} \sin z \Rightarrow \frac{\partial f}{\partial z}(0, 0, \frac{\pi}{6}) = -\frac{1}{2}$; thus $\nabla f = \left(\frac{\sqrt{3}+2}{2}\right)\mathbf{i} + \frac{\sqrt{3}}{2}\mathbf{j} - \frac{1}{2}\mathbf{k}$
9. $\mathbf{u} = \frac{\mathbf{v}}{|\mathbf{v}|} = \frac{4\mathbf{i}+3\mathbf{j}}{\sqrt{4^2+3^2}} = \frac{4}{5}\mathbf{i} + \frac{3}{5}\mathbf{j}$; $f_x(x, y) = 2y \Rightarrow f_x(5, 5) = 10$; $f_y(x, y) = 2x - 6y \Rightarrow f_y(5, 5) = -20$
 $\Rightarrow \nabla f = 10\mathbf{i} - 20\mathbf{j} \Rightarrow (\mathbf{D}_u f)_{P_0} = \nabla f \cdot \mathbf{u} = 10\left(\frac{4}{5}\right) - 20\left(\frac{3}{5}\right) = -4$
10. $\mathbf{u} = \frac{\mathbf{v}}{|\mathbf{v}|} = \frac{3\mathbf{i}-4\mathbf{j}}{\sqrt{3^2+(-4)^2}} = \frac{3}{5}\mathbf{i} - \frac{4}{5}\mathbf{j}$; $f_x(x, y) = 4x \Rightarrow f_x(-1, 1) = -4$; $f_y(x, y) = 2y \Rightarrow f_y(-1, 1) = 2$
 $\Rightarrow \nabla f = -4\mathbf{i} + 2\mathbf{j} \Rightarrow (\mathbf{D}_u f)_{P_0} = \nabla f \cdot \mathbf{u} = -\frac{12}{5} - \frac{8}{5} = -4$
11. $\mathbf{u} = \frac{\mathbf{v}}{|\mathbf{v}|} = \frac{12\mathbf{i}+5\mathbf{j}}{\sqrt{12^2+5^2}} = \frac{12}{13}\mathbf{i} + \frac{5}{13}\mathbf{j}$; $g_x(x, y) = 1 + \frac{y^2}{x^2} + \frac{2y\sqrt{3}}{2xy\sqrt{4x^2y^2-1}} \Rightarrow g_x(1, 1) = 3$; $g_y(x, y)$
 $= -\frac{2y}{x} + \frac{2x\sqrt{3}}{2xy\sqrt{4x^2y^2-1}} \Rightarrow g_y(1, 1) = -1 \Rightarrow \nabla g = 3\mathbf{i} - \mathbf{j} \Rightarrow (\mathbf{D}_u g)_{P_0} = \nabla g \cdot \mathbf{u} = \frac{36}{13} - \frac{5}{13} = \frac{31}{13}$
12. $\mathbf{u} = \frac{\mathbf{v}}{|\mathbf{v}|} = \frac{3\mathbf{i}-2\mathbf{j}}{\sqrt{3^2+(-2)^2}} = \frac{3}{\sqrt{13}}\mathbf{i} - \frac{2}{\sqrt{13}}\mathbf{j}$; $h_x(x, y) = \frac{(-\frac{y}{x^2})}{(\frac{y}{x})^2+1} + \frac{(\frac{y}{x})\sqrt{3}}{\sqrt{1-(\frac{x^2y^2}{4})}} \Rightarrow h_x(1, 1) = \frac{1}{2}$;
 $h_y(x, y) = \frac{(\frac{1}{x})}{(\frac{y}{x})^2+1} + \frac{(\frac{y}{x})\sqrt{3}}{\sqrt{1-(\frac{x^2y^2}{4})}} \Rightarrow h_y(1, 1) = \frac{3}{2} \Rightarrow \nabla h = \frac{1}{2}\mathbf{i} + \frac{3}{2}\mathbf{j} \Rightarrow (\mathbf{D}_u h)_{P_0} = \nabla h \cdot \mathbf{u} = \frac{3}{2\sqrt{13}} - \frac{6}{2\sqrt{13}}$
 $= -\frac{3}{2\sqrt{13}}$
13. $\mathbf{u} = \frac{\mathbf{v}}{|\mathbf{v}|} = \frac{3\mathbf{i}+6\mathbf{j}-2\mathbf{k}}{\sqrt{3^2+6^2+(-2)^2}} = \frac{3}{7}\mathbf{i} + \frac{6}{7}\mathbf{j} - \frac{2}{7}\mathbf{k}$; $f_x(x, y, z) = y + z \Rightarrow f_x(1, -1, 2) = 1$; $f_y(x, y, z) = x + z$
 $\Rightarrow f_y(1, -1, 2) = 3$; $f_z(x, y, z) = y + x \Rightarrow f_z(1, -1, 2) = 0 \Rightarrow \nabla f = \mathbf{i} + 3\mathbf{j} \Rightarrow (\mathbf{D}_u f)_{P_0} = \nabla f \cdot \mathbf{u} = \frac{3}{7} + \frac{18}{7} = 3$
14. $\mathbf{u} = \frac{\mathbf{v}}{|\mathbf{v}|} = \frac{\mathbf{i}+\mathbf{j}+\mathbf{k}}{\sqrt{1^2+1^2+1^2}} = \frac{1}{\sqrt{3}}\mathbf{i} + \frac{1}{\sqrt{3}}\mathbf{j} + \frac{1}{\sqrt{3}}\mathbf{k}$; $f_x(x, y, z) = 2x \Rightarrow f_x(1, 1, 1) = 2$; $f_y(x, y, z) = 4y$
 $\Rightarrow f_y(1, 1, 1) = 4$; $f_z(x, y, z) = -6z \Rightarrow f_z(1, 1, 1) = -6 \Rightarrow \nabla f = 2\mathbf{i} + 4\mathbf{j} - 6\mathbf{k} \Rightarrow (\mathbf{D}_u f)_{P_0} = \nabla f \cdot \mathbf{u}$
 $= 2\left(\frac{1}{\sqrt{3}}\right) + 4\left(\frac{1}{\sqrt{3}}\right) - 6\left(\frac{1}{\sqrt{3}}\right) = 0$
15. $\mathbf{u} = \frac{\mathbf{v}}{|\mathbf{v}|} = \frac{2\mathbf{i}+\mathbf{j}-2\mathbf{k}}{\sqrt{2^2+1^2+(-2)^2}} = \frac{2}{3}\mathbf{i} + \frac{1}{3}\mathbf{j} - \frac{2}{3}\mathbf{k}$; $g_x(x, y, z) = 3e^x \cos yz \Rightarrow g_x(0, 0, 0) = 3$; $g_y(x, y, z) = -3ze^x \sin yz$
 $\Rightarrow g_y(0, 0, 0) = 0$; $g_z(x, y, z) = -3ye^x \sin yz \Rightarrow g_z(0, 0, 0) = 0 \Rightarrow \nabla g = 3\mathbf{i} \Rightarrow (\mathbf{D}_u g)_{P_0} = \nabla g \cdot \mathbf{u} = 2$
16. $\mathbf{u} = \frac{\mathbf{v}}{|\mathbf{v}|} = \frac{\mathbf{i}+2\mathbf{j}+2\mathbf{k}}{\sqrt{1^2+2^2+2^2}} = \frac{1}{3}\mathbf{i} + \frac{2}{3}\mathbf{j} + \frac{2}{3}\mathbf{k}$; $h_x(x, y, z) = -y \sin xy + \frac{1}{x} \Rightarrow h_x(1, 0, \frac{1}{2}) = 1$;
 $h_y(x, y, z) = -x \sin xy + ze^{yz} \Rightarrow h_y(1, 0, \frac{1}{2}) = \frac{1}{2}$; $h_z(x, y, z) = ye^{yz} + \frac{1}{z} \Rightarrow h_z(1, 0, \frac{1}{2}) = 2 \Rightarrow \nabla h = \mathbf{i} + \frac{1}{2}\mathbf{j} + 2\mathbf{k}$
 $\Rightarrow (\mathbf{D}_u h)_{P_0} = \nabla h \cdot \mathbf{u} = \frac{1}{3} + \frac{1}{3} + \frac{4}{3} = 2$
17. $\nabla f = (2x + y)\mathbf{i} + (x + 2y)\mathbf{j} \Rightarrow \nabla f(-1, 1) = -\mathbf{i} + \mathbf{j} \Rightarrow \mathbf{u} = \frac{\nabla f}{|\nabla f|} = \frac{-\mathbf{i}+\mathbf{j}}{\sqrt{(-1)^2+1^2}} = -\frac{1}{\sqrt{2}}\mathbf{i} + \frac{1}{\sqrt{2}}\mathbf{j}$; f increases
most rapidly in the direction $\mathbf{u} = -\frac{1}{\sqrt{2}}\mathbf{i} + \frac{1}{\sqrt{2}}\mathbf{j}$ and decreases most rapidly in the direction $-\mathbf{u} = \frac{1}{\sqrt{2}}\mathbf{i} - \frac{1}{\sqrt{2}}\mathbf{j}$;
 $(\mathbf{D}_u f)_{P_0} = \nabla f \cdot \mathbf{u} = |\nabla f| = \sqrt{2}$ and $(\mathbf{D}_{-u} f)_{P_0} = -\sqrt{2}$

18. $\nabla f = (2xy + ye^{xy} \sin y)\mathbf{i} + (x^2 + xe^{xy} \sin y + e^{xy} \cos y)\mathbf{j} \Rightarrow \nabla f(1, 0) = 2\mathbf{j} \Rightarrow \mathbf{u} = \frac{\nabla f}{|\nabla f|} = \mathbf{j}$; f increases most rapidly in the direction $\mathbf{u} = \mathbf{j}$ and decreases most rapidly in the direction $-\mathbf{u} = -\mathbf{j}$; $(D_{\mathbf{u}}f)_{P_0} = \nabla f \cdot \mathbf{u} = |\nabla f| = 2$ and $(D_{-\mathbf{u}}f)_{P_0} = -2$

19. $\nabla f = \frac{1}{y}\mathbf{i} - \left(\frac{x}{y^2} + z\right)\mathbf{j} - y\mathbf{k} \Rightarrow \nabla f(4, 1, 1) = \mathbf{i} - 5\mathbf{j} - \mathbf{k} \Rightarrow \mathbf{u} = \frac{\nabla f}{|\nabla f|} = \frac{\mathbf{i} - 5\mathbf{j} - \mathbf{k}}{\sqrt{1^2 + (-5)^2 + (-1)^2}}$
 $= \frac{1}{3\sqrt{3}}\mathbf{i} - \frac{5}{3\sqrt{3}}\mathbf{j} - \frac{1}{3\sqrt{3}}\mathbf{k}$; f increases most rapidly in the direction of $\mathbf{u} = \frac{1}{3\sqrt{3}}\mathbf{i} - \frac{5}{3\sqrt{3}}\mathbf{j} - \frac{1}{3\sqrt{3}}\mathbf{k}$ and decreases most rapidly in the direction $-\mathbf{u} = -\frac{1}{3\sqrt{3}}\mathbf{i} + \frac{5}{3\sqrt{3}}\mathbf{j} + \frac{1}{3\sqrt{3}}\mathbf{k}$; $(D_{\mathbf{u}}f)_{P_0} = \nabla f \cdot \mathbf{u} = |\nabla f| = 3\sqrt{3}$ and $(D_{-\mathbf{u}}f)_{P_0} = -3\sqrt{3}$

20. $\nabla g = e^y\mathbf{i} + xe^y\mathbf{j} + 2z\mathbf{k} \Rightarrow \nabla g(1, \ln 2, \frac{1}{2}) = 2\mathbf{i} + 2\mathbf{j} + \mathbf{k} \Rightarrow \mathbf{u} = \frac{\nabla g}{|\nabla g|} = \frac{2\mathbf{i} + 2\mathbf{j} + \mathbf{k}}{\sqrt{2^2 + 2^2 + 1^2}} = \frac{2}{3}\mathbf{i} + \frac{2}{3}\mathbf{j} + \frac{1}{3}\mathbf{k}$;
 g increases most rapidly in the direction $\mathbf{u} = \frac{2}{3}\mathbf{i} + \frac{2}{3}\mathbf{j} + \frac{1}{3}\mathbf{k}$ and decreases most rapidly in the direction $-\mathbf{u} = -\frac{2}{3}\mathbf{i} - \frac{2}{3}\mathbf{j} - \frac{1}{3}\mathbf{k}$; $(D_{\mathbf{u}}g)_{P_0} = \nabla g \cdot \mathbf{u} = |\nabla g| = 3$ and $(D_{-\mathbf{u}}g)_{P_0} = -3$

21. $\nabla f = \left(\frac{1}{x} + \frac{1}{x}\right)\mathbf{i} + \left(\frac{1}{y} + \frac{1}{y}\right)\mathbf{j} + \left(\frac{1}{z} + \frac{1}{z}\right)\mathbf{k} \Rightarrow \nabla f(1, 1, 1) = 2\mathbf{i} + 2\mathbf{j} + 2\mathbf{k} \Rightarrow \mathbf{u} = \frac{\nabla f}{|\nabla f|} = \frac{1}{\sqrt{3}}\mathbf{i} + \frac{1}{\sqrt{3}}\mathbf{j} + \frac{1}{\sqrt{3}}\mathbf{k}$;
 f increases most rapidly in the direction $\mathbf{u} = \frac{1}{\sqrt{3}}\mathbf{i} + \frac{1}{\sqrt{3}}\mathbf{j} + \frac{1}{\sqrt{3}}\mathbf{k}$ and decreases most rapidly in the direction $-\mathbf{u} = -\frac{1}{\sqrt{3}}\mathbf{i} - \frac{1}{\sqrt{3}}\mathbf{j} - \frac{1}{\sqrt{3}}\mathbf{k}$; $(D_{\mathbf{u}}f)_{P_0} = \nabla f \cdot \mathbf{u} = |\nabla f| = 2\sqrt{3}$ and $(D_{-\mathbf{u}}f)_{P_0} = -2\sqrt{3}$

22. $\nabla h = \left(\frac{2x}{x^2 + y^2 - 1}\right)\mathbf{i} + \left(\frac{2y}{x^2 + y^2 - 1} + 1\right)\mathbf{j} + 6\mathbf{k} \Rightarrow \nabla h(1, 1, 0) = 2\mathbf{i} + 3\mathbf{j} + 6\mathbf{k} \Rightarrow \mathbf{u} = \frac{\nabla h}{|\nabla h|} = \frac{2\mathbf{i} + 3\mathbf{j} + 6\mathbf{k}}{\sqrt{2^2 + 3^2 + 6^2}}$
 $= \frac{2}{7}\mathbf{i} + \frac{3}{7}\mathbf{j} + \frac{6}{7}\mathbf{k}$; h increases most rapidly in the direction $\mathbf{u} = \frac{2}{7}\mathbf{i} + \frac{3}{7}\mathbf{j} + \frac{6}{7}\mathbf{k}$ and decreases most rapidly in the direction $-\mathbf{u} = -\frac{2}{7}\mathbf{i} - \frac{3}{7}\mathbf{j} - \frac{6}{7}\mathbf{k}$; $(D_{\mathbf{u}}h)_{P_0} = \nabla h \cdot \mathbf{u} = |\nabla h| = 7$ and $(D_{-\mathbf{u}}h)_{P_0} = -7$

23. $\nabla f = 2x\mathbf{i} + 2y\mathbf{j} \Rightarrow \nabla f(\sqrt{2}, \sqrt{2}) = 2\sqrt{2}\mathbf{i} + 2\sqrt{2}\mathbf{j}$
 \Rightarrow Tangent line: $2\sqrt{2}(x - \sqrt{2}) + 2\sqrt{2}(y - \sqrt{2}) = 0$
 $\Rightarrow \sqrt{2}x + \sqrt{2}y = 4$

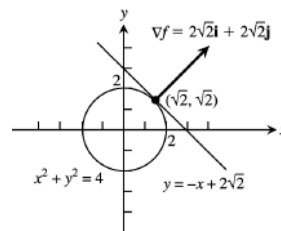

24. $\nabla f = 2x\mathbf{i} - \mathbf{j} \Rightarrow \nabla f(\sqrt{2}, 1) = 2\sqrt{2}\mathbf{i} - \mathbf{j}$
 \Rightarrow Tangent line: $2\sqrt{2}(x - \sqrt{2}) - (y - 1) = 0$
 $\Rightarrow y = 2\sqrt{2}x - 3$

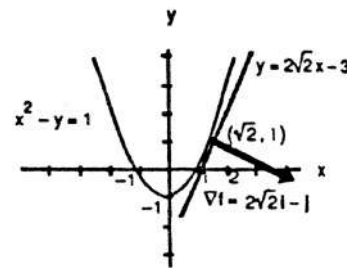

25. $\nabla f = y\mathbf{i} + x\mathbf{j} \Rightarrow \nabla f(2, -2) = -2\mathbf{i} + 2\mathbf{j}$
 \Rightarrow Tangent line: $-2(x - 2) + 2(y + 2) = 0$
 $\Rightarrow y = x - 4$

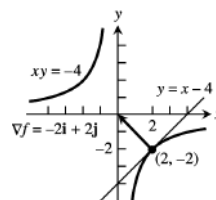

26. $\nabla f = (2x - y)\mathbf{i} + (2y - x)\mathbf{j} \Rightarrow \nabla f(-1, 2) = -4\mathbf{i} + 5\mathbf{j}$
 \Rightarrow Tangent line: $-4(x + 1) + 5(y - 2) = 0$
 $\Rightarrow -4x + 5y - 14 = 0$

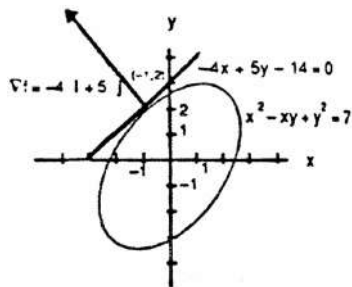

27. $\nabla f = y\mathbf{i} + (x + 2y)\mathbf{j} \Rightarrow \nabla f(3, 2) = 2\mathbf{i} + 7\mathbf{j}$; a vector orthogonal to ∇f is $\mathbf{v} = 7\mathbf{i} - 2\mathbf{j} \Rightarrow \mathbf{u} = \frac{\mathbf{v}}{|\mathbf{v}|} = \frac{7\mathbf{i} - 2\mathbf{j}}{\sqrt{7^2 + (-2)^2}}$
 $= \frac{7}{\sqrt{53}}\mathbf{i} - \frac{2}{\sqrt{53}}\mathbf{j}$ and $-\mathbf{u} = -\frac{7}{\sqrt{53}}\mathbf{i} + \frac{2}{\sqrt{53}}\mathbf{j}$ are the directions where the derivative is zero
28. $\nabla f = \frac{4xy^2}{(x^2 + y^2)^2}\mathbf{i} - \frac{4x^2y}{(x^2 + y^2)^2}\mathbf{j} \Rightarrow \nabla f(1, 1) = \mathbf{i} - \mathbf{j}$; a vector orthogonal to ∇f is $\mathbf{v} = \mathbf{i} + \mathbf{j}$
 $\Rightarrow \mathbf{u} = \frac{\mathbf{v}}{|\mathbf{v}|} = \frac{\mathbf{i} + \mathbf{j}}{\sqrt{1^2 + 1^2}} = \frac{1}{\sqrt{2}}\mathbf{i} + \frac{1}{\sqrt{2}}\mathbf{j}$ and $-\mathbf{u} = -\frac{1}{\sqrt{2}}\mathbf{i} - \frac{1}{\sqrt{2}}\mathbf{j}$ are the directions where the derivative is zero
29. $\nabla f = (2x - 3y)\mathbf{i} + (-3x + 8y)\mathbf{j} \Rightarrow \nabla f(1, 2) = -4\mathbf{i} + 13\mathbf{j} \Rightarrow |\nabla f(1, 2)| = \sqrt{(-4)^2 + (13)^2} = \sqrt{185}$; no, the maximum rate of change is $\sqrt{185} < 14$
30. $\nabla T = 2y\mathbf{i} + (2x - z)\mathbf{j} - y\mathbf{k} \Rightarrow \nabla T(1, -1, 1) = -2\mathbf{i} + \mathbf{j} + \mathbf{k} \Rightarrow |\nabla T(1, -1, 1)| = \sqrt{(-2)^2 + 1^2 + 1^2} = \sqrt{6}$; no, the minimum rate of change is $-\sqrt{6} > -3$
31. $\nabla f = f_x(1, 2)\mathbf{i} + f_y(1, 2)\mathbf{j}$ and $\mathbf{u}_1 = \frac{\mathbf{i} + \mathbf{j}}{\sqrt{1^2 + 1^2}} = \frac{1}{\sqrt{2}}\mathbf{i} + \frac{1}{\sqrt{2}}\mathbf{j} \Rightarrow (D_{\mathbf{u}_1}f)(1, 2) = f_x(1, 2)\left(\frac{1}{\sqrt{2}}\right) + f_y(1, 2)\left(\frac{1}{\sqrt{2}}\right)$
 $= 2\sqrt{2} \Rightarrow f_x(1, 2) + f_y(1, 2) = 4$; $\mathbf{u}_2 = -\mathbf{j} \Rightarrow (D_{\mathbf{u}_2}f)(1, 2) = f_x(1, 2)(0) + f_y(1, 2)(-1) = -3 \Rightarrow -f_y(1, 2) = -3$
 $\Rightarrow f_y(1, 2) = 3$; then $f_x(1, 2) + 3 = 4 \Rightarrow f_x(1, 2) = 1$; thus $\nabla f(1, 2) = \mathbf{i} + 3\mathbf{j}$ and $\mathbf{u} = \frac{\mathbf{v}}{|\mathbf{v}|} = \frac{-\mathbf{i} - 2\mathbf{j}}{\sqrt{(-1)^2 + (-2)^2}}$
 $= -\frac{1}{\sqrt{5}}\mathbf{i} - \frac{2}{\sqrt{5}}\mathbf{j} \Rightarrow (D_{\mathbf{u}}f)_{P_0} = \nabla f \cdot \mathbf{u} = -\frac{1}{\sqrt{5}} - \frac{6}{\sqrt{5}} = -\frac{7}{\sqrt{5}}$
32. (a) $(D_{\mathbf{u}}f)_P = 2\sqrt{3} \Rightarrow |\nabla f| = 2\sqrt{3}$; $\mathbf{u} = \frac{\mathbf{v}}{|\mathbf{v}|} = \frac{\mathbf{i} + \mathbf{j} - \mathbf{k}}{\sqrt{1^2 + 1^2 + (-1)^2}} = \frac{1}{\sqrt{3}}\mathbf{i} + \frac{1}{\sqrt{3}}\mathbf{j} - \frac{1}{\sqrt{3}}\mathbf{k}$; thus $\mathbf{u} = \frac{\nabla f}{|\nabla f|}$
 $\Rightarrow \nabla f = |\nabla f|\mathbf{u} \Rightarrow \nabla f = 2\sqrt{3}\left(\frac{1}{\sqrt{3}}\mathbf{i} + \frac{1}{\sqrt{3}}\mathbf{j} - \frac{1}{\sqrt{3}}\mathbf{k}\right) = 2\mathbf{i} + 2\mathbf{j} - 2\mathbf{k}$
 (b) $\mathbf{v} = \mathbf{i} + \mathbf{j} \Rightarrow \mathbf{u} = \frac{\mathbf{v}}{|\mathbf{v}|} = \frac{\mathbf{i} + \mathbf{j}}{\sqrt{1^2 + 1^2}} = \frac{1}{\sqrt{2}}\mathbf{i} + \frac{1}{\sqrt{2}}\mathbf{j} \Rightarrow (D_{\mathbf{u}}f)_{P_0} = \nabla f \cdot \mathbf{u} = 2\left(\frac{1}{\sqrt{2}}\right) + 2\left(\frac{1}{\sqrt{2}}\right) - 2(0) = 2\sqrt{2}$
33. The directional derivative is the scalar component. With ∇f evaluated at P_0 , the scalar component of ∇f in the direction of \mathbf{u} is $\nabla f \cdot \mathbf{u} = (D_{\mathbf{u}}f)_{P_0}$.
34. $D_{\mathbf{i}}f = \nabla f \cdot \mathbf{i} = (f_x\mathbf{i} + f_y\mathbf{j} + f_z\mathbf{k}) \cdot \mathbf{i} = f_x$; similarly, $D_{\mathbf{j}}f = \nabla f \cdot \mathbf{j} = f_y$ and $D_{\mathbf{k}}f = \nabla f \cdot \mathbf{k} = f_z$
35. If (x, y) is a point on the line, then $\mathbf{T}(x, y) = (x - x_0)\mathbf{i} + (y - y_0)\mathbf{j}$ is a vector parallel to the line $\Rightarrow \mathbf{T} \cdot \mathbf{N} = 0$
 $\Rightarrow A(x - x_0) + B(y - y_0) = 0$, as claimed.
36. (a) $\nabla(kf) = \frac{\partial(kf)}{\partial x}\mathbf{i} + \frac{\partial(kf)}{\partial y}\mathbf{j} + \frac{\partial(kf)}{\partial z}\mathbf{k} = k\left(\frac{\partial f}{\partial x}\right)\mathbf{i} + k\left(\frac{\partial f}{\partial y}\right)\mathbf{j} + k\left(\frac{\partial f}{\partial z}\right)\mathbf{k} = k\left(\frac{\partial f}{\partial x}\mathbf{i} + \frac{\partial f}{\partial y}\mathbf{j} + \frac{\partial f}{\partial z}\mathbf{k}\right) = k\nabla f$
 (b) $\nabla(f + g) = \frac{\partial(f+g)}{\partial x}\mathbf{i} + \frac{\partial(f+g)}{\partial y}\mathbf{j} + \frac{\partial(f+g)}{\partial z}\mathbf{k} = \left(\frac{\partial f}{\partial x} + \frac{\partial g}{\partial x}\right)\mathbf{i} + \left(\frac{\partial f}{\partial y} + \frac{\partial g}{\partial y}\right)\mathbf{j} + \left(\frac{\partial f}{\partial z} + \frac{\partial g}{\partial z}\right)\mathbf{k}$
 $= \frac{\partial f}{\partial x}\mathbf{i} + \frac{\partial g}{\partial x}\mathbf{i} + \frac{\partial f}{\partial y}\mathbf{j} + \frac{\partial g}{\partial y}\mathbf{j} + \frac{\partial f}{\partial z}\mathbf{k} + \frac{\partial g}{\partial z}\mathbf{k} = \left(\frac{\partial f}{\partial x}\mathbf{i} + \frac{\partial f}{\partial y}\mathbf{j} + \frac{\partial f}{\partial z}\mathbf{k}\right) + \left(\frac{\partial g}{\partial x}\mathbf{i} + \frac{\partial g}{\partial y}\mathbf{j} + \frac{\partial g}{\partial z}\mathbf{k}\right) = \nabla f + \nabla g$
 (c) $\nabla(f - g) = \nabla f - \nabla g$ (Substitute $-g$ for g in part (b) above)

$$\begin{aligned}
 \text{(d)} \quad \nabla(fg) &= \frac{\partial(fg)}{\partial x} \mathbf{i} + \frac{\partial(fg)}{\partial y} \mathbf{j} + \frac{\partial(fg)}{\partial z} \mathbf{k} = \left(\frac{\partial f}{\partial x} g + \frac{\partial g}{\partial x} f \right) \mathbf{i} + \left(\frac{\partial f}{\partial y} g + \frac{\partial g}{\partial y} f \right) \mathbf{j} + \left(\frac{\partial f}{\partial z} g + \frac{\partial g}{\partial z} f \right) \mathbf{k} \\
 &= \left(\frac{\partial f}{\partial x} g \right) \mathbf{i} + \left(\frac{\partial g}{\partial x} f \right) \mathbf{i} + \left(\frac{\partial f}{\partial y} g \right) \mathbf{j} + \left(\frac{\partial g}{\partial y} f \right) \mathbf{j} + \left(\frac{\partial f}{\partial z} g \right) \mathbf{k} + \left(\frac{\partial g}{\partial z} f \right) \mathbf{k} \\
 &= f \left(\frac{\partial g}{\partial x} \mathbf{i} + \frac{\partial g}{\partial y} \mathbf{j} + \frac{\partial g}{\partial z} \mathbf{k} \right) + g \left(\frac{\partial f}{\partial x} \mathbf{i} + \frac{\partial f}{\partial y} \mathbf{j} + \frac{\partial f}{\partial z} \mathbf{k} \right) = f \nabla g + g \nabla f \\
 \text{(e)} \quad \nabla \left(\frac{f}{g} \right) &= \frac{\partial \left(\frac{f}{g} \right)}{\partial x} \mathbf{i} + \frac{\partial \left(\frac{f}{g} \right)}{\partial y} \mathbf{j} + \frac{\partial \left(\frac{f}{g} \right)}{\partial z} \mathbf{k} = \left(\frac{g \frac{\partial f}{\partial x} - f \frac{\partial g}{\partial x}}{g^2} \right) \mathbf{i} + \left(\frac{g \frac{\partial f}{\partial y} - f \frac{\partial g}{\partial y}}{g^2} \right) \mathbf{j} + \left(\frac{g \frac{\partial f}{\partial z} - f \frac{\partial g}{\partial z}}{g^2} \right) \mathbf{k} \\
 &= \left(\frac{g \frac{\partial f}{\partial x} \mathbf{i} + g \frac{\partial f}{\partial y} \mathbf{j} + g \frac{\partial f}{\partial z} \mathbf{k}}{g^2} \right) - \left(\frac{f \frac{\partial g}{\partial x} \mathbf{i} + f \frac{\partial g}{\partial y} \mathbf{j} + f \frac{\partial g}{\partial z} \mathbf{k}}{g^2} \right) = \frac{g \left(\frac{\partial f}{\partial x} \mathbf{i} + \frac{\partial f}{\partial y} \mathbf{j} + \frac{\partial f}{\partial z} \mathbf{k} \right)}{g^2} - \frac{f \left(\frac{\partial g}{\partial x} \mathbf{i} + \frac{\partial g}{\partial y} \mathbf{j} + \frac{\partial g}{\partial z} \mathbf{k} \right)}{g^2} \\
 &= \frac{g \nabla f}{g^2} - \frac{f \nabla g}{g^2} = \frac{g \nabla f - f \nabla g}{g^2}
 \end{aligned}$$

14.6 TANGENT PLANES AND DIFFERENTIALS

- (a) $\nabla f = 2x\mathbf{i} + 2y\mathbf{j} + 2z\mathbf{k} \Rightarrow \nabla f(1, 1, 1) = 2\mathbf{i} + 2\mathbf{j} + 2\mathbf{k} \Rightarrow$ Tangent plane: $2(x - 1) + 2(y - 1) + 2(z - 1) = 0$
 $\Rightarrow x + y + z = 3;$

(b) Normal line: $x = 1 + 2t, y = 1 + 2t, z = 1 + 2t$
- (a) $\nabla f = 2x\mathbf{i} + 2y\mathbf{j} - 2z\mathbf{k} \Rightarrow \nabla f(3, 5, -4) = 6\mathbf{i} + 10\mathbf{j} + 8\mathbf{k} \Rightarrow$ Tangent plane: $6(x - 3) + 10(y - 5) + 8(z + 4) = 0$
 $\Rightarrow 3x + 5y + 4z = 18;$

(b) Normal line: $x = 3 + 6t, y = 5 + 10t, z = -4 + 8t$
- (a) $\nabla f = -2x\mathbf{i} + 2z\mathbf{k} \Rightarrow \nabla f(2, 0, 2) = -4\mathbf{i} + 2\mathbf{k} \Rightarrow$ Tangent plane: $-4(x - 2) + 2(z - 2) = 0$
 $\Rightarrow -4x + 2z + 4 = 0 \Rightarrow -2x + z + 2 = 0;$

(b) Normal line: $x = 2 - 4t, y = 0, z = 2 + 2t$
- (a) $\nabla f = (2x + 2y)\mathbf{i} + (2x - 2y)\mathbf{j} + 2z\mathbf{k} \Rightarrow \nabla f(1, -1, 3) = 4\mathbf{j} + 6\mathbf{k} \Rightarrow$ Tangent plane: $4(y + 1) + 6(z - 3) = 0$
 $\Rightarrow 2y + 3z = 7;$

(b) Normal line: $x = 1, y = -1 + 4t, z = 3 + 6t$
- (a) $\nabla f = (-\pi \sin \pi x - 2xy + ze^{xz})\mathbf{i} + (-x^2 + z)\mathbf{j} + (xe^{xz} + y)\mathbf{k} \Rightarrow \nabla f(0, 1, 2) = 2\mathbf{i} + 2\mathbf{j} + \mathbf{k} \Rightarrow$ Tangent plane:
 $2(x - 0) + 2(y - 1) + 1(z - 2) = 0 \Rightarrow 2x + 2y + z - 4 = 0;$

(b) Normal line: $x = 2t, y = 1 + 2t, z = 2 + t$
- (a) $\nabla f = (2x - y)\mathbf{i} - (x + 2y)\mathbf{j} - \mathbf{k} \Rightarrow \nabla f(1, 1, -1) = \mathbf{i} - 3\mathbf{j} - \mathbf{k} \Rightarrow$ Tangent plane:
 $1(x - 1) - 3(y - 1) - 1(z + 1) = 0 \Rightarrow x - 3y - z = -1;$

(b) Normal line: $x = 1 + t, y = 1 - 3t, z = -1 - t$
- (a) $\nabla f = \mathbf{i} + \mathbf{j} + \mathbf{k}$ for all points $\Rightarrow \nabla f(0, 1, 0) = \mathbf{i} + \mathbf{j} + \mathbf{k} \Rightarrow$ Tangent plane: $1(x - 0) + 1(y - 1) + 1(z - 0) = 0$
 $\Rightarrow x + y + z - 1 = 0;$

(b) Normal line: $x = t, y = 1 + t, z = t$
- (a) $\nabla f = (2x - 2y - 1)\mathbf{i} + (2y - 2x + 3)\mathbf{j} - \mathbf{k} \Rightarrow \nabla f(2, -3, 18) = 9\mathbf{i} - 7\mathbf{j} - \mathbf{k} \Rightarrow$ Tangent plane:
 $9(x - 2) - 7(y + 3) - 1(z - 18) = 0 \Rightarrow 9x - 7y - z = 21;$

(b) Normal line: $x = 2 + 9t, y = -3 - 7t, z = 18 - t$
- $z = f(x, y) = \ln(x^2 + y^2) \Rightarrow f_x(x, y) = \frac{2x}{x^2 + y^2}$ and $f_y(x, y) = \frac{2y}{x^2 + y^2} \Rightarrow f_x(1, 0) = 2$ and $f_y(1, 0) = 0 \Rightarrow$ from Eq. (4) the tangent plane at $(1, 0, 0)$ is $2(x - 1) - z = 0$ or $2x - z - 2 = 0$

10. $z = f(x, y) = e^{-(x^2+y^2)} \Rightarrow f_x(x, y) = -2xe^{-(x^2+y^2)}$ and $f_y(x, y) = -2ye^{-(x^2+y^2)} \Rightarrow f_x(0, 0) = 0$ and $f_y(0, 0) = 0$
 \Rightarrow from Eq. (4) the tangent plane at $(0, 0, 1)$ is $z - 1 = 0$ or $z = 1$

11. $z = f(x, y) = \sqrt{y-x} \Rightarrow f_x(x, y) = -\frac{1}{2}(y-x)^{-1/2}$ and $f_y(x, y) = \frac{1}{2}(y-x)^{-1/2} \Rightarrow f_x(1, 2) = -\frac{1}{2}$ and $f_y(1, 2) = \frac{1}{2}$
 \Rightarrow from Eq. (4) the tangent plane at $(1, 2, 1)$ is $-\frac{1}{2}(x-1) + \frac{1}{2}(y-2) - (z-1) = 0 \Rightarrow x - y + 2z - 1 = 0$

12. $z = f(x, y) = 4x^2 + y^2 \Rightarrow f_x(x, y) = 8x$ and $f_y(x, y) = 2y \Rightarrow f_x(1, 1) = 8$ and $f_y(1, 1) = 2 \Rightarrow$ from Eq. (4) the tangent plane at $(1, 1, 5)$ is $8(x-1) + 2(y-1) - (z-5) = 0$ or $8x + 2y - z - 5 = 0$

13. $\nabla f = \mathbf{i} + 2y\mathbf{j} + 2\mathbf{k} \Rightarrow \nabla f(1, 1, 1) = \mathbf{i} + 2\mathbf{j} + 2\mathbf{k}$ and $\nabla g = \mathbf{i}$ for all points; $\mathbf{v} = \nabla f \times \nabla g$
 $\Rightarrow \mathbf{v} = \begin{vmatrix} \mathbf{i} & \mathbf{j} & \mathbf{k} \\ 1 & 2 & 2 \\ 1 & 0 & 0 \end{vmatrix} = 2\mathbf{j} - 2\mathbf{k} \Rightarrow$ Tangent line: $x = 1, y = 1 + 2t, z = 1 - 2t$

14. $\nabla f = yz\mathbf{i} + xz\mathbf{j} + xy\mathbf{k} \Rightarrow \nabla f(1, 1, 1) = \mathbf{i} + \mathbf{j} + \mathbf{k}$; $\nabla g = 2x\mathbf{i} + 4y\mathbf{j} + 6z\mathbf{k} \Rightarrow \nabla g(1, 1, 1) = 2\mathbf{i} + 4\mathbf{j} + 6\mathbf{k}$;
 $\Rightarrow \mathbf{v} = \nabla f \times \nabla g \Rightarrow \begin{vmatrix} \mathbf{i} & \mathbf{j} & \mathbf{k} \\ 1 & 1 & 1 \\ 2 & 4 & 6 \end{vmatrix} = 2\mathbf{i} - 4\mathbf{j} + 2\mathbf{k} \Rightarrow$ Tangent line: $x = 1 + 2t, y = 1 - 4t, z = 1 + 2t$

15. $\nabla f = 2x\mathbf{i} + 2\mathbf{j} + 2\mathbf{k} \Rightarrow \nabla f(1, 1, \frac{1}{2}) = 2\mathbf{i} + 2\mathbf{j} + 2\mathbf{k}$ and $\nabla g = \mathbf{j}$ for all points; $\mathbf{v} = \nabla f \times \nabla g$
 $\Rightarrow \mathbf{v} = \begin{vmatrix} \mathbf{i} & \mathbf{j} & \mathbf{k} \\ 2 & 2 & 2 \\ 0 & 1 & 0 \end{vmatrix} = -2\mathbf{i} + 2\mathbf{k} \Rightarrow$ Tangent line: $x = 1 - 2t, y = 1, z = \frac{1}{2} + 2t$

16. $\nabla f = \mathbf{i} + 2y\mathbf{j} + \mathbf{k} \Rightarrow \nabla f(\frac{1}{2}, 1, \frac{1}{2}) = \mathbf{i} + 2\mathbf{j} + \mathbf{k}$ and $\nabla g = \mathbf{j}$ for all points; $\mathbf{v} = \nabla f \times \nabla g$
 $\Rightarrow \mathbf{v} = \begin{vmatrix} \mathbf{i} & \mathbf{j} & \mathbf{k} \\ 1 & 2 & 1 \\ 0 & 1 & 0 \end{vmatrix} = -\mathbf{i} + \mathbf{k} \Rightarrow$ Tangent line: $x = \frac{1}{2} - t, y = 1, z = \frac{1}{2} + t$

17. $\nabla f = (3x^2 + 6xy^2 + 4y)\mathbf{i} + (6x^2y + 3y^2 + 4x)\mathbf{j} - 2z\mathbf{k} \Rightarrow \nabla f(1, 1, 3) = 13\mathbf{i} + 13\mathbf{j} - 6\mathbf{k}$; $\nabla g = 2x\mathbf{i} + 2y\mathbf{j} + 2z\mathbf{k}$
 $\Rightarrow \nabla g(1, 1, 3) = 2\mathbf{i} + 2\mathbf{j} + 6\mathbf{k}$; $\mathbf{v} = \nabla f \times \nabla g \Rightarrow \mathbf{v} = \begin{vmatrix} \mathbf{i} & \mathbf{j} & \mathbf{k} \\ 13 & 13 & -6 \\ 2 & 2 & 6 \end{vmatrix} = 90\mathbf{i} - 90\mathbf{j} \Rightarrow$ Tangent line:
 $x = 1 + 90t, y = 1 - 90t, z = 3$

18. $\nabla f = 2x\mathbf{i} + 2y\mathbf{j} \Rightarrow \nabla f(\sqrt{2}, \sqrt{2}, 4) = 2\sqrt{2}\mathbf{i} + 2\sqrt{2}\mathbf{j}$; $\nabla g = 2x\mathbf{i} + 2y\mathbf{j} - \mathbf{k} \Rightarrow \nabla g(\sqrt{2}, \sqrt{2}, 4)$
 $= 2\sqrt{2}\mathbf{i} + 2\sqrt{2}\mathbf{j} - \mathbf{k}$; $\mathbf{v} = \nabla f \times \nabla g \Rightarrow \mathbf{v} = \begin{vmatrix} \mathbf{i} & \mathbf{j} & \mathbf{k} \\ 2\sqrt{2} & 2\sqrt{2} & 0 \\ 2\sqrt{2} & 2\sqrt{2} & -1 \end{vmatrix} = -2\sqrt{2}\mathbf{i} + 2\sqrt{2}\mathbf{j} \Rightarrow$ Tangent line:
 $x = \sqrt{2} - 2\sqrt{2}t, y = \sqrt{2} + 2\sqrt{2}t, z = 4$

19. $\nabla f = \left(\frac{x}{x^2+y^2+z^2}\right)\mathbf{i} + \left(\frac{y}{x^2+y^2+z^2}\right)\mathbf{j} + \left(\frac{z}{x^2+y^2+z^2}\right)\mathbf{k} \Rightarrow \nabla f(3, 4, 12) = \frac{3}{169}\mathbf{i} + \frac{4}{169}\mathbf{j} + \frac{12}{169}\mathbf{k}$;
 $\mathbf{u} = \frac{\mathbf{v}}{|\mathbf{v}|} = \frac{3\mathbf{i} + 6\mathbf{j} - 2\mathbf{k}}{\sqrt{3^2+6^2+(-2)^2}} = \frac{3}{7}\mathbf{i} + \frac{6}{7}\mathbf{j} - \frac{2}{7}\mathbf{k} \Rightarrow \nabla f \cdot \mathbf{u} = \frac{9}{1183}$ and $df = (\nabla f \cdot \mathbf{u}) ds = \left(\frac{9}{1183}\right)(0.1) \approx 0.0008$

20. $\nabla f = (e^x \cos yz)\mathbf{i} - (ze^x \sin yz)\mathbf{j} - (ye^x \sin yz)\mathbf{k} \Rightarrow \nabla f(0, 0, 0) = \mathbf{i}$; $\mathbf{u} = \frac{\mathbf{v}}{|\mathbf{v}|} = \frac{2\mathbf{i} + 2\mathbf{j} - 2\mathbf{k}}{\sqrt{2^2+2^2+(-2)^2}}$
 $= \frac{1}{3}\mathbf{i} + \frac{1}{3}\mathbf{j} - \frac{1}{3}\mathbf{k} \Rightarrow \nabla f \cdot \mathbf{u} = \frac{1}{3}$ and $df = (\nabla f \cdot \mathbf{u}) ds = \frac{1}{3}(0.1) \approx 0.0577$

21. $\nabla g = (1 + \cos z)\mathbf{i} + (1 - \sin z)\mathbf{j} + (-x \sin z - y \cos z)\mathbf{k} \Rightarrow \nabla g(2, -1, 0) = 2\mathbf{i} + \mathbf{j} + \mathbf{k}; \mathbf{A} = \vec{P_0P_1} = -2\mathbf{i} + 2\mathbf{j} + 2\mathbf{k}$
 $\Rightarrow \mathbf{u} = \frac{\mathbf{v}}{|\mathbf{v}|} = \frac{-2\mathbf{i} + 2\mathbf{j} + 2\mathbf{k}}{\sqrt{(-2)^2 + 2^2 + 2^2}} = -\frac{1}{\sqrt{3}}\mathbf{i} + \frac{1}{\sqrt{3}}\mathbf{j} + \frac{1}{\sqrt{3}}\mathbf{k} \Rightarrow \nabla g \cdot \mathbf{u} = 0$ and $dg = (\nabla g \cdot \mathbf{u}) ds = (0)(0.2) = 0$
22. $\nabla h = [-\pi y \sin(\pi xy) + z^2]\mathbf{i} - [\pi x \sin(\pi xy)]\mathbf{j} + 2xz\mathbf{k} \Rightarrow \nabla h(-1, -1, -1) = (\pi \sin \pi + 1)\mathbf{i} + (\pi \sin \pi)\mathbf{j} + 2\mathbf{k}$
 $= \mathbf{i} + 2\mathbf{k}; \mathbf{v} = \vec{P_0P_1} = \mathbf{i} + \mathbf{j} + \mathbf{k}$ where $P_1 = (0, 0, 0) \Rightarrow \mathbf{u} = \frac{\mathbf{v}}{|\mathbf{v}|} = \frac{\mathbf{i} + \mathbf{j} + \mathbf{k}}{\sqrt{1^2 + 1^2 + 1^2}} = \frac{1}{\sqrt{3}}\mathbf{i} + \frac{1}{\sqrt{3}}\mathbf{j} + \frac{1}{\sqrt{3}}\mathbf{k}$
 $\Rightarrow \nabla h \cdot \mathbf{u} = \frac{3}{\sqrt{3}} = \sqrt{3}$ and $dh = (\nabla h \cdot \mathbf{u}) ds = \sqrt{3}(0.1) \approx 0.1732$
23. (a) The unit tangent vector at $(\frac{1}{2}, \frac{\sqrt{3}}{2})$ in the direction of motion is $\mathbf{u} = \frac{\sqrt{3}}{2}\mathbf{i} - \frac{1}{2}\mathbf{j}$;
 $\nabla T = (\sin 2y)\mathbf{i} + (2x \cos 2y)\mathbf{j} \Rightarrow \nabla T(\frac{1}{2}, \frac{\sqrt{3}}{2}) = (\sin \sqrt{3})\mathbf{i} + (\cos \sqrt{3})\mathbf{j} \Rightarrow D_u T(\frac{1}{2}, \frac{\sqrt{3}}{2}) = \nabla T \cdot \mathbf{u}$
 $= \frac{\sqrt{3}}{2} \sin \sqrt{3} - \frac{1}{2} \cos \sqrt{3} \approx 0.935^\circ \text{ C/ft}$
- (b) $\mathbf{r}(t) = (\sin 2t)\mathbf{i} + (\cos 2t)\mathbf{j} \Rightarrow \mathbf{v}(t) = (2 \cos 2t)\mathbf{i} - (2 \sin 2t)\mathbf{j}$ and $|\mathbf{v}| = 2$; $\frac{dT}{dt} = \frac{\partial T}{\partial x} \frac{dx}{dt} + \frac{\partial T}{\partial y} \frac{dy}{dt}$
 $= \nabla T \cdot \mathbf{v} = (\nabla T \cdot \frac{\mathbf{v}}{|\mathbf{v}|}) |\mathbf{v}| = (D_u T) |\mathbf{v}|$, where $\mathbf{u} = \frac{\mathbf{v}}{|\mathbf{v}|}$; at $(\frac{1}{2}, \frac{\sqrt{3}}{2})$ we have $\mathbf{u} = \frac{\sqrt{3}}{2}\mathbf{i} - \frac{1}{2}\mathbf{j}$ from part (a)
 $\Rightarrow \frac{dT}{dt} = (\frac{\sqrt{3}}{2} \sin \sqrt{3} - \frac{1}{2} \cos \sqrt{3}) \cdot 2 = \sqrt{3} \sin \sqrt{3} - \cos \sqrt{3} \approx 1.87^\circ \text{ C/sec}$
24. (a) $\nabla T = (4x - yz)\mathbf{i} - xz\mathbf{j} - xy\mathbf{k} \Rightarrow \nabla T(8, 6, -4) = 56\mathbf{i} + 32\mathbf{j} - 48\mathbf{k}; \mathbf{r}(t) = 2t^2\mathbf{i} + 3t\mathbf{j} - t^2\mathbf{k} \Rightarrow$ the particle is
at the point $P(8, 6, -4)$ when $t = 2$; $\mathbf{v}(t) = 4t\mathbf{i} + 3\mathbf{j} - 2t\mathbf{k} \Rightarrow \mathbf{v}(2) = 8\mathbf{i} + 3\mathbf{j} - 4\mathbf{k} \Rightarrow \mathbf{u} = \frac{\mathbf{v}}{|\mathbf{v}|}$
 $= \frac{8}{\sqrt{89}}\mathbf{i} + \frac{3}{\sqrt{89}}\mathbf{j} - \frac{4}{\sqrt{89}}\mathbf{k} \Rightarrow D_u T(8, 6, -4) = \nabla T \cdot \mathbf{u} = \frac{1}{\sqrt{89}} [56 \cdot 8 + 32 \cdot 3 - 48 \cdot (-4)] = \frac{736}{\sqrt{89}}^\circ \text{ C/m}$
- (b) $\frac{dT}{dt} = \frac{\partial T}{\partial x} \frac{dx}{dt} + \frac{\partial T}{\partial y} \frac{dy}{dt} = \nabla T \cdot \mathbf{v} = (\nabla T \cdot \mathbf{u}) |\mathbf{v}| \Rightarrow$ at $t = 2$, $\frac{dT}{dt} = D_u T|_{t=2} \mathbf{v}(2) = (\frac{736}{\sqrt{89}}) \sqrt{89} = 736^\circ \text{ C/sec}$
25. (a) $f(0, 0) = 1, f_x(x, y) = 2x \Rightarrow f_x(0, 0) = 0, f_y(x, y) = 2y \Rightarrow f_y(0, 0) = 0 \Rightarrow L(x, y) = 1 + 0(x - 0) + 0(y - 0) = 1$
(b) $f(1, 1) = 3, f_x(1, 1) = 2, f_y(1, 1) = 2 \Rightarrow L(x, y) = 3 + 2(x - 1) + 2(y - 1) = 2x + 2y - 1$
26. (a) $f(0, 0) = 4, f_x(x, y) = 2(x + y + 2) \Rightarrow f_x(0, 0) = 4, f_y(x, y) = 2(x + y + 2) \Rightarrow f_y(0, 0) = 4$
 $\Rightarrow L(x, y) = 4 + 4(x - 0) + 4(y - 0) = 4x + 4y + 4$
- (b) $f(1, 2) = 25, f_x(1, 2) = 10, f_y(1, 2) = 10 \Rightarrow L(x, y) = 25 + 10(x - 1) + 10(y - 2) = 10x + 10y - 5$
27. (a) $f(0, 0) = 5, f_x(x, y) = 3$ for all $(x, y), f_y(x, y) = -4$ for all $(x, y) \Rightarrow L(x, y) = 5 + 3(x - 0) - 4(y - 0)$
 $= 3x - 4y + 5$
- (b) $f(1, 1) = 4, f_x(1, 1) = 3, f_y(1, 1) = -4 \Rightarrow L(x, y) = 4 + 3(x - 1) - 4(y - 1) = 3x - 4y + 5$
28. (a) $f(1, 1) = 1, f_x(x, y) = 3x^2y^4 \Rightarrow f_x(1, 1) = 3, f_y(x, y) = 4x^3y^3 \Rightarrow f_y(1, 1) = 4$
 $\Rightarrow L(x, y) = 1 + 3(x - 1) + 4(y - 1) = 3x + 4y - 6$
- (b) $f(0, 0) = 0, f_x(0, 0) = 0, f_y(0, 0) = 0 \Rightarrow L(x, y) = 0$
29. (a) $f(0, 0) = 1, f_x(x, y) = e^x \cos y \Rightarrow f_x(0, 0) = 1, f_y(x, y) = -e^x \sin y \Rightarrow f_y(0, 0) = 0$
 $\Rightarrow L(x, y) = 1 + 1(x - 0) + 0(y - 0) = x + 1$
- (b) $f(0, \frac{\pi}{2}) = 0, f_x(0, \frac{\pi}{2}) = 0, f_y(0, \frac{\pi}{2}) = -1 \Rightarrow L(x, y) = 0 + 0(x - 0) - 1(y - \frac{\pi}{2}) = -y + \frac{\pi}{2}$
30. (a) $f(0, 0) = 1, f_x(x, y) = -e^{2y-x} \Rightarrow f_x(0, 0) = -1, f_y(x, y) = 2e^{2y-x} \Rightarrow f_y(0, 0) = 2$
 $\Rightarrow L(x, y) = 1 - 1(x - 0) + 2(y - 0) = -x + 2y + 1$
- (b) $f(1, 2) = e^3, f_x(1, 2) = -e^3, f_y(1, 2) = 2e^3 \Rightarrow L(x, y) = e^3 - e^3(x - 1) + 2e^3(y - 2)$
 $= -e^3x + 2e^3y - 2e^3$

31. $f(2, 1) = 3$, $f_x(x, y) = 2x - 3y \Rightarrow f_x(2, 1) = 1$, $f_y(x, y) = -3x \Rightarrow f_y(2, 1) = -6 \Rightarrow L(x, y) = 3 + 1(x - 2) - 6(y - 1)$
 $= 7 + x - 6y$; $f_{xx}(x, y) = 2$, $f_{yy}(x, y) = 0$, $f_{xy}(x, y) = -3 \Rightarrow M = 3$; thus $|E(x, y)| \leq \left(\frac{1}{2}\right) (3) (|x - 2| + |y - 1|)^2$
 $\leq \left(\frac{3}{2}\right) (0.1 + 0.1)^2 = 0.06$
32. $f(2, 2) = 11$, $f_x(x, y) = x + y + 3 \Rightarrow f_x(2, 2) = 7$, $f_y(x, y) = x + \frac{y}{2} - 3 \Rightarrow f_y(2, 2) = 0$
 $\Rightarrow L(x, y) = 11 + 7(x - 2) + 0(y - 2) = 7x - 3$; $f_{xx}(x, y) = 1$, $f_{yy}(x, y) = \frac{1}{2}$, $f_{xy}(x, y) = 1$
 $\Rightarrow M = 1$; thus $|E(x, y)| \leq \left(\frac{1}{2}\right) (1) (|x - 2| + |y - 2|)^2 \leq \left(\frac{1}{2}\right) (0.1 + 0.1)^2 = 0.02$
33. $f(0, 0) = 1$, $f_x(x, y) = \cos y \Rightarrow f_x(0, 0) = 1$, $f_y(x, y) = 1 - x \sin y \Rightarrow f_y(0, 0) = 1$
 $\Rightarrow L(x, y) = 1 + 1(x - 0) + 1(y - 0) = x + y + 1$; $f_{xx}(x, y) = 0$, $f_{yy}(x, y) = -x \cos y$, $f_{xy}(x, y) = -\sin y \Rightarrow M = 1$;
thus $|E(x, y)| \leq \left(\frac{1}{2}\right) (1) (|x| + |y|)^2 \leq \left(\frac{1}{2}\right) (0.2 + 0.2)^2 = 0.08$
34. $f(1, 2) = 6$, $f_x(x, y) = y^2 - y \sin(x - 1) \Rightarrow f_x(1, 2) = 4$, $f_y(x, y) = 2xy + \cos(x - 1) \Rightarrow f_y(1, 2) = 5$
 $\Rightarrow L(x, y) = 6 + 4(x - 1) + 5(y - 2) = 4x + 5y - 8$; $f_{xx}(x, y) = -y \cos(x - 1)$, $f_{yy}(x, y) = 2x$,
 $f_{xy}(x, y) = 2y - \sin(x - 1)$; $|x - 1| \leq 0.1 \Rightarrow 0.9 \leq x \leq 1.1$ and $|y - 2| \leq 0.1 \Rightarrow 1.9 \leq y \leq 2.1$; thus the max of
 $|f_{xx}(x, y)|$ on R is 2.1, the max of $|f_{yy}(x, y)|$ on R is 2.2, and the max of $|f_{xy}(x, y)|$ on R is $2(2.1) - \sin(0.9 - 1)$
 $\leq 4.3 \Rightarrow M = 4.3$; thus $|E(x, y)| \leq \left(\frac{1}{2}\right) (4.3) (|x - 1| + |y - 2|)^2 \leq (2.15)(0.1 + 0.1)^2 = 0.086$
35. $f(0, 0) = 1$, $f_x(x, y) = e^x \cos y \Rightarrow f_x(0, 0) = 1$, $f_y(x, y) = -e^x \sin y \Rightarrow f_y(0, 0) = 0$
 $\Rightarrow L(x, y) = 1 + 1(x - 0) + 0(y - 0) = 1 + x$; $f_{xx}(x, y) = e^x \cos y$, $f_{yy}(x, y) = -e^x \cos y$, $f_{xy}(x, y) = -e^x \sin y$;
 $|x| \leq 0.1 \Rightarrow -0.1 \leq x \leq 0.1$ and $|y| \leq 0.1 \Rightarrow -0.1 \leq y \leq 0.1$; thus the max of $|f_{xx}(x, y)|$ on R is $e^{0.1} \cos(0.1)$
 ≤ 1.11 , the max of $|f_{yy}(x, y)|$ on R is $e^{0.1} \cos(0.1) \leq 1.11$, and the max of $|f_{xy}(x, y)|$ on R is $e^{0.1} \sin(0.1)$
 $\leq 0.12 \Rightarrow M = 1.11$; thus $|E(x, y)| \leq \left(\frac{1}{2}\right) (1.11) (|x| + |y|)^2 \leq (0.555)(0.1 + 0.1)^2 = 0.0222$
36. $f(1, 1) = 0$, $f_x(x, y) = \frac{1}{x} \Rightarrow f_x(1, 1) = 1$, $f_y(x, y) = \frac{1}{y} \Rightarrow f_y(1, 1) = 1 \Rightarrow L(x, y) = 0 + 1(x - 1) + 1(y - 1)$
 $= x + y - 2$; $f_{xx}(x, y) = -\frac{1}{x^2}$, $f_{yy}(x, y) = -\frac{1}{y^2}$, $f_{xy}(x, y) = 0$; $|x - 1| \leq 0.2 \Rightarrow 0.98 \leq x \leq 1.2$ so the max of
 $|f_{xx}(x, y)|$ on R is $\frac{1}{(0.98)^2} \leq 1.04$; $|y - 1| \leq 0.2 \Rightarrow 0.98 \leq y \leq 1.2$ so the max of $|f_{yy}(x, y)|$ on R is
 $\frac{1}{(0.98)^2} \leq 1.04 \Rightarrow M = 1.04$; thus $|E(x, y)| \leq \left(\frac{1}{2}\right) (1.04) (|x - 1| + |y - 1|)^2 \leq (0.52)(0.2 + 0.2)^2 = 0.0832$
37. (a) $f(1, 1, 1) = 3$, $f_x(1, 1, 1) = y + z|_{(1,1,1)} = 2$, $f_y(1, 1, 1) = x + z|_{(1,1,1)} = 2$, $f_z(1, 1, 1) = y + x|_{(1,1,1)} = 2$
 $\Rightarrow L(x, y, z) = 3 + 2(x - 1) + 2(y - 1) + 2(z - 1) = 2x + 2y + 2z - 3$
(b) $f(1, 0, 0) = 0$, $f_x(1, 0, 0) = 0$, $f_y(1, 0, 0) = 1$, $f_z(1, 0, 0) = 1 \Rightarrow L(x, y, z) = 0 + 0(x - 1) + (y - 0) + (z - 0)$
 $= y + z$
(c) $f(0, 0, 0) = 0$, $f_x(0, 0, 0) = 0$, $f_y(0, 0, 0) = 0$, $f_z(0, 0, 0) = 0 \Rightarrow L(x, y, z) = 0$
38. (a) $f(1, 1, 1) = 3$, $f_x(1, 1, 1) = 2x|_{(1,1,1)} = 2$, $f_y(1, 1, 1) = 2y|_{(1,1,1)} = 2$, $f_z(1, 1, 1) = 2z|_{(1,1,1)} = 2$
 $\Rightarrow L(x, y, z) = 3 + 2(x - 1) + 2(y - 1) + 2(z - 1) = 2x + 2y + 2z - 3$
(b) $f(0, 1, 0) = 1$, $f_x(0, 1, 0) = 0$, $f_y(0, 1, 0) = 2$, $f_z(0, 1, 0) = 0 \Rightarrow L(x, y, z) = 1 + 0(x - 0) + 2(y - 1) + 0(z - 0)$
 $= 2y - 1$
(c) $f(1, 0, 0) = 1$, $f_x(1, 0, 0) = 2$, $f_y(1, 0, 0) = 0$, $f_z(1, 0, 0) = 0 \Rightarrow L(x, y, z) = 1 + 2(x - 1) + 0(y - 0) + 0(z - 0)$
 $= 2x - 1$
39. (a) $f(1, 0, 0) = 1$, $f_x(1, 0, 0) = \frac{x}{\sqrt{x^2 + y^2 + z^2}} \Big|_{(1,0,0)} = 1$, $f_y(1, 0, 0) = \frac{y}{\sqrt{x^2 + y^2 + z^2}} \Big|_{(1,0,0)} = 0$,
 $f_z(1, 0, 0) = \frac{z}{\sqrt{x^2 + y^2 + z^2}} \Big|_{(1,0,0)} = 0 \Rightarrow L(x, y, z) = 1 + 1(x - 1) + 0(y - 0) + 0(z - 0) = x$

$$(b) f(1, 1, 0) = \sqrt{2}, f_x(1, 1, 0) = \frac{1}{\sqrt{2}}, f_y(1, 1, 0) = \frac{1}{\sqrt{2}}, f_z(1, 1, 0) = 0$$

$$\Rightarrow L(x, y, z) = \sqrt{2} + \frac{1}{\sqrt{2}}(x - 1) + \frac{1}{\sqrt{2}}(y - 1) + 0(z - 0) = \frac{1}{\sqrt{2}}x + \frac{1}{\sqrt{2}}y$$

$$(c) f(1, 2, 2) = 3, f_x(1, 2, 2) = \frac{1}{3}, f_y(1, 2, 2) = \frac{2}{3}, f_z(1, 2, 2) = \frac{2}{3} \Rightarrow L(x, y, z) = 3 + \frac{1}{3}(x - 1) + \frac{2}{3}(y - 2) + \frac{2}{3}(z - 2) \\ = \frac{1}{3}x + \frac{2}{3}y + \frac{2}{3}z$$

$$40. (a) f\left(\frac{\pi}{2}, 1, 1\right) = 1, f_x\left(\frac{\pi}{2}, 1, 1\right) = \frac{y \cos xy}{z} \Big|_{\left(\frac{\pi}{2}, 1, 1\right)} = 0, f_y\left(\frac{\pi}{2}, 1, 1\right) = \frac{x \cos xy}{z} \Big|_{\left(\frac{\pi}{2}, 1, 1\right)} = 0,$$

$$f_z\left(\frac{\pi}{2}, 1, 1\right) = \frac{-\sin xy}{z^2} \Big|_{\left(\frac{\pi}{2}, 1, 1\right)} = -1 \Rightarrow L(x, y, z) = 1 + 0(x - \frac{\pi}{2}) + 0(y - 1) - 1(z - 1) = 2 - z$$

$$(b) f(2, 0, 1) = 0, f_x(2, 0, 1) = 0, f_y(2, 0, 1) = 2, f_z(2, 0, 1) = 0 \Rightarrow L(x, y, z) = 0 + 0(x - 2) + 2(y - 0) + 0(z - 1) = 2y$$

$$41. (a) f(0, 0, 0) = 2, f_x(0, 0, 0) = e^x \Big|_{(0,0,0)} = 1, f_y(0, 0, 0) = -\sin(y + z) \Big|_{(0,0,0)} = 0,$$

$$f_z(0, 0, 0) = -\sin(y + z) \Big|_{(0,0,0)} = 0 \Rightarrow L(x, y, z) = 2 + 1(x - 0) + 0(y - 0) + 0(z - 0) = 2 + x$$

$$(b) f\left(0, \frac{\pi}{2}, 0\right) = 1, f_x\left(0, \frac{\pi}{2}, 0\right) = 1, f_y\left(0, \frac{\pi}{2}, 0\right) = -1, f_z\left(0, \frac{\pi}{2}, 0\right) = -1 \Rightarrow L(x, y, z)$$

$$= 1 + 1(x - 0) - 1(y - \frac{\pi}{2}) - 1(z - 0) = x - y - z + \frac{\pi}{2} + 1$$

$$(c) f\left(0, \frac{\pi}{4}, \frac{\pi}{4}\right) = 1, f_x\left(0, \frac{\pi}{4}, \frac{\pi}{4}\right) = 1, f_y\left(0, \frac{\pi}{4}, \frac{\pi}{4}\right) = -1, f_z\left(0, \frac{\pi}{4}, \frac{\pi}{4}\right) = -1 \Rightarrow L(x, y, z)$$

$$= 1 + 1(x - 0) - 1(y - \frac{\pi}{4}) - 1(z - \frac{\pi}{4}) = x - y - z + \frac{\pi}{2} + 1$$

$$42. (a) f(1, 0, 0) = 0, f_x(1, 0, 0) = \frac{yz}{(xyz)^2 + 1} \Big|_{(1,0,0)} = 0, f_y(1, 0, 0) = \frac{xz}{(xyz)^2 + 1} \Big|_{(1,0,0)} = 0,$$

$$f_z(1, 0, 0) = \frac{xy}{(xyz)^2 + 1} \Big|_{(1,0,0)} = 0 \Rightarrow L(x, y, z) = 0$$

$$(b) f(1, 1, 0) = 0, f_x(1, 1, 0) = 0, f_y(1, 1, 0) = 0, f_z(1, 1, 0) = 1 \Rightarrow L(x, y, z) = 0 + 0(x - 1) + 0(y - 1) + 1(z - 0) = z$$

$$(c) f(1, 1, 1) = \frac{\pi}{4}, f_x(1, 1, 1) = \frac{1}{2}, f_y(1, 1, 1) = \frac{1}{2}, f_z(1, 1, 1) = \frac{1}{2} \Rightarrow L(x, y, z) = \frac{\pi}{4} + \frac{1}{2}(x - 1) + \frac{1}{2}(y - 1) + \frac{1}{2}(z - 1) \\ = \frac{1}{2}x + \frac{1}{2}y + \frac{1}{2}z + \frac{\pi}{4} - \frac{3}{2}$$

$$43. f(x, y, z) = xz - 3yz + 2 \text{ at } P_0(1, 1, 2) \Rightarrow f(1, 1, 2) = -2; f_x = z, f_y = -3z, f_z = x - 3y \Rightarrow L(x, y, z)$$

$$= -2 + 2(x - 1) - 6(y - 1) - 2(z - 2) = 2x - 6y - 2z + 6; f_{xx} = 0, f_{yy} = 0, f_{zz} = 0, f_{xy} = 0, f_{yz} = -3$$

$$\Rightarrow M = 3; \text{ thus, } |E(x, y, z)| \leq \left(\frac{1}{2}\right)(3)(0.01 + 0.01 + 0.02)^2 = 0.0024$$

$$44. f(x, y, z) = x^2 + xy + yz + \frac{1}{4}z^2 \text{ at } P_0(1, 1, 2) \Rightarrow f(1, 1, 2) = 5; f_x = 2x + y, f_y = x + z, f_z = y + \frac{1}{2}z$$

$$\Rightarrow L(x, y, z) = 5 + 3(x - 1) + 3(y - 1) + 2(z - 2) = 3x + 3y + 2z - 5; f_{xx} = 2, f_{yy} = 0, f_{zz} = \frac{1}{2}, f_{xy} = 1, f_{xz} = 0,$$

$$f_{yz} = 1 \Rightarrow M = 2; \text{ thus } |E(x, y, z)| \leq \left(\frac{1}{2}\right)(2)(0.01 + 0.01 + 0.08)^2 = 0.01$$

$$45. f(x, y, z) = xy + 2yz - 3xz \text{ at } P_0(1, 1, 0) \Rightarrow f(1, 1, 0) = 1; f_x = y - 3z, f_y = x + 2z, f_z = 2y - 3x$$

$$\Rightarrow L(x, y, z) = 1 + (x - 1) + (y - 1) - (z - 0) = x + y - z - 1; f_{xx} = 0, f_{yy} = 0, f_{zz} = 0, f_{xy} = 1, f_{xz} = -3,$$

$$f_{yz} = 2 \Rightarrow M = 3; \text{ thus } |E(x, y, z)| \leq \left(\frac{1}{2}\right)(3)(0.01 + 0.01 + 0.01)^2 = 0.00135$$

$$46. f(x, y, z) = \sqrt{2} \cos x \sin(y + z) \text{ at } P_0\left(0, 0, \frac{\pi}{4}\right) \Rightarrow f\left(0, 0, \frac{\pi}{4}\right) = 1; f_x = -\sqrt{2} \sin x \sin(y + z),$$

$$f_y = \sqrt{2} \cos x \cos(y + z), f_z = \sqrt{2} \cos x \cos(y + z) \Rightarrow L(x, y, z) = 1 - 0(x - 0) + (y - 0) + (z - \frac{\pi}{4})$$

$$= y + z - \frac{\pi}{4} + 1; f_{xx} = -\sqrt{2} \cos x \sin(y + z), f_{yy} = -\sqrt{2} \cos x \sin(y + z), f_{zz} = -\sqrt{2} \cos x \sin(y + z),$$

$$f_{xy} = -\sqrt{2} \sin x \cos(y + z), f_{xz} = -\sqrt{2} \sin x \cos(y + z), f_{yz} = -\sqrt{2} \cos x \sin(y + z). \text{ The absolute value of}$$

$$\text{each of these second partial derivatives is bounded above by } \sqrt{2} \Rightarrow M = \sqrt{2}; \text{ thus } |E(x, y, z)|$$

$$\leq \left(\frac{1}{2}\right)\left(\sqrt{2}\right)(0.01 + 0.01 + 0.01)^2 = 0.000636.$$

47. $T_x(x, y) = e^y + e^{-y}$ and $T_y(x, y) = x(e^y - e^{-y}) \Rightarrow dT = T_x(x, y) dx + T_y(x, y) dy$
 $= (e^y + e^{-y}) dx + x(e^y - e^{-y}) dy \Rightarrow dT|_{(2, \ln 2)} = 2.5 dx + 3.0 dy$. If $|dx| \leq 0.1$ and $|dy| \leq 0.02$, then the maximum possible error in the computed value of T is $(2.5)(0.1) + (3.0)(0.02) = 0.31$ in magnitude.
48. $V_r = 2\pi rh$ and $V_h = \pi r^2 \Rightarrow dV = V_r dr + V_h dh \Rightarrow \frac{dV}{V} = \frac{2\pi rh dr + \pi r^2 dh}{\pi r^2 h} = \frac{2}{r} dr + \frac{1}{h} dh$; now $|\frac{dr}{r} \cdot 100| \leq 1$ and $|\frac{dh}{h} \cdot 100| \leq 1 \Rightarrow |\frac{dV}{V} \cdot 100| \leq |(2 \frac{dr}{r})(100) + (\frac{dh}{h})(100)| \leq 2|\frac{dr}{r} \cdot 100| + |\frac{dh}{h} \cdot 100| \leq 2(1) + 1 = 3 \Rightarrow 3\%$
49. $V_r = 2\pi rh$ and $V_h = \pi r^2 \Rightarrow dV = V_r dr + V_h dh \Rightarrow dV = 2\pi rh dr + \pi r^2 dh \Rightarrow dV|_{(5, 12)} = 120\pi dr + 25\pi dh$;
 $|dr| \leq 0.1$ cm and $|dh| \leq 0.1$ cm $\Rightarrow dV \leq (120\pi)(0.1) + (25\pi)(0.1) = 14.5\pi$ cm³; $V(5, 12) = 300\pi$ cm³
 \Rightarrow maximum percentage error is $\pm \frac{14.5\pi}{300\pi} \times 100 = \pm 4.83\%$
50. (a) $\frac{1}{R} = \frac{1}{R_1} + \frac{1}{R_2} \Rightarrow -\frac{1}{R^2} dR = -\frac{1}{R_1^2} dR_1 - \frac{1}{R_2^2} dR_2 \Rightarrow dR = \left(\frac{R}{R_1}\right)^2 dR_1 + \left(\frac{R}{R_2}\right)^2 dR_2$
 (b) $dR = R^2 \left[\left(\frac{1}{R_1^2}\right) dR_1 + \left(\frac{1}{R_2^2}\right) dR_2 \right] \Rightarrow dR|_{(100, 400)} = R^2 \left[\frac{1}{(100)^2} dR_1 + \frac{1}{(400)^2} dR_2 \right] \Rightarrow R$ will be more sensitive to a variation in R_1 since $\frac{1}{(100)^2} > \frac{1}{(400)^2}$
 (c) From part (a), $dR = \left(\frac{R}{R_1}\right)^2 dR_1 + \left(\frac{R}{R_2}\right)^2 dR_2$ so that R_1 changing from 20 to 20.1 ohms $\Rightarrow dR_1 = 0.1$ ohm and R_2 changing from 25 to 24.9 ohms $\Rightarrow dR_2 = -0.1$ ohms; $\frac{1}{R} = \frac{1}{R_1} + \frac{1}{R_2} \Rightarrow R = \frac{100}{9}$ ohms
 $\Rightarrow dR|_{(20, 25)} = \frac{(100)^2}{(20)^2} (0.1) + \frac{(100)^2}{(25)^2} (-0.1) \approx 0.011$ ohms \Rightarrow percentage change is $\frac{dR}{R}|_{(20, 25)} \times 100 = \frac{0.011}{\frac{100}{9}} \times 100 \approx 0.1\%$
51. $A = xy \Rightarrow dA = x dy + y dx$; if $x > y$ then a 1-unit change in y gives a greater change in dA than a 1-unit change in x . Thus, pay more attention to y which is the smaller of the two dimensions.
52. (a) $f_x(x, y) = 2x(y + 1) \Rightarrow f_x(1, 0) = 2$ and $f_y(x, y) = x^2 \Rightarrow f_y(1, 0) = 1 \Rightarrow df = 2 dx + 1 dy \Rightarrow df$ is more sensitive to changes in x
 (b) $df = 0 \Rightarrow 2 dx + dy = 0 \Rightarrow 2 \frac{dx}{dy} + 1 = 0 \Rightarrow \frac{dx}{dy} = -\frac{1}{2}$
53. (a) $r^2 = x^2 + y^2 \Rightarrow 2r dr = 2x dx + 2y dy \Rightarrow dr = \frac{x}{r} dx + \frac{y}{r} dy \Rightarrow dr|_{(3, 4)} = \left(\frac{3}{5}\right) (\pm 0.01) + \left(\frac{4}{5}\right) (\pm 0.01) = \pm \frac{0.07}{5} = \pm 0.014 \Rightarrow \left|\frac{dr}{r} \times 100\right| = \left|\pm \frac{0.014}{\frac{5}{5}} \times 100\right| = 0.28\%$; $d\theta = \frac{\left(-\frac{y}{x^2}\right)}{\left(\frac{y}{x}\right)^2 + 1} dx + \frac{\left(\frac{1}{x}\right)}{\left(\frac{y}{x}\right)^2 + 1} dy = \frac{-y}{y^2 + x^2} dx + \frac{x}{y^2 + x^2} dy \Rightarrow d\theta|_{(3, 4)} = \left(\frac{-4}{25}\right) (\pm 0.01) + \left(\frac{3}{25}\right) (\pm 0.01) = \frac{\mp 0.04}{25} + \frac{\pm 0.03}{25} \Rightarrow$ maximum change in $d\theta$ occurs when dx and dy have opposite signs ($dx = 0.01$ and $dy = -0.01$ or vice versa) $\Rightarrow d\theta = \frac{\pm 0.07}{25} \approx \pm 0.0028$; $\theta = \tan^{-1}\left(\frac{4}{3}\right) \approx 0.927255218 \Rightarrow \left|\frac{d\theta}{\theta} \times 100\right| = \left|\frac{\pm 0.0028}{0.927255218} \times 100\right| \approx 0.30\%$
 (b) the radius r is more sensitive to changes in y , and the angle θ is more sensitive to changes in x
54. (a) $V = \pi r^2 h \Rightarrow dV = 2\pi r h dr + \pi r^2 dh \Rightarrow$ at $r = 1$ and $h = 5$ we have $dV = 10\pi dr + \pi dh \Rightarrow$ the volume is about 10 times more sensitive to a change in r
 (b) $dV = 0 \Rightarrow 0 = 2\pi r h dr + \pi r^2 dh = 2h dr + r dh = 10 dr + dh \Rightarrow dr = -\frac{1}{10} dh$; choose $dh = 1.5 \Rightarrow dr = -0.15 \Rightarrow h = 6.5$ in. and $r = 0.85$ in. is one solution for $\Delta V \approx dV = 0$
55. $f(a, b, c, d) = \begin{vmatrix} a & b \\ c & d \end{vmatrix} = ad - bc \Rightarrow f_a = d, f_b = -c, f_c = -b, f_d = a \Rightarrow df = d da - c db - b dc + a dd$; since $|a|$ is much greater than $|b|, |c|$, and $|d|$, the function f is most sensitive to a change in d .

56. $u_x = e^y$, $u_y = xe^y + \sin z$, $u_z = y \cos z \Rightarrow du = e^y dx + (xe^y + \sin z) dy + (y \cos z) dz$
 $\Rightarrow du|_{(2, \ln 3, \frac{\pi}{2})} = 3 dx + 7 dy + 0 dz = 3 dx + 7 dy \Rightarrow$ magnitude of the maximum possible error
 $\leq 3(0.2) + 7(0.6) = 4.8$
57. $Q_k = \frac{1}{2} \left(\frac{2KM}{h}\right)^{-1/2} \left(\frac{2M}{h}\right)$, $Q_M = \frac{1}{2} \left(\frac{2KM}{h}\right)^{-1/2} \left(\frac{2K}{h}\right)$, and $Q_h = \frac{1}{2} \left(\frac{2KM}{h}\right)^{-1/2} \left(\frac{-2KM}{h^2}\right)$
 $\Rightarrow dQ = \frac{1}{2} \left(\frac{2KM}{h}\right)^{-1/2} \left(\frac{2M}{h}\right) dK + \frac{1}{2} \left(\frac{2KM}{h}\right)^{-1/2} \left(\frac{2K}{h}\right) dM + \frac{1}{2} \left(\frac{2KM}{h}\right)^{-1/2} \left(\frac{-2KM}{h^2}\right) dh$
 $= \frac{1}{2} \left(\frac{2KM}{h}\right)^{-1/2} \left[\frac{2M}{h} dK + \frac{2K}{h} dM - \frac{2KM}{h^2} dh\right] \Rightarrow dQ|_{(2, 20, 0.05)}$
 $= \frac{1}{2} \left[\frac{(2)(2)(20)}{0.05}\right]^{-1/2} \left[\frac{(2)(20)}{0.05} dK + \frac{(2)(2)}{0.05} dM - \frac{(2)(2)(20)}{(0.05)^2} dh\right] = (0.0125)(800 dK + 80 dM - 32,000 dh)$
 $\Rightarrow Q$ is most sensitive to changes in h
58. $A = \frac{1}{2} ab \sin C \Rightarrow A_a = \frac{1}{2} b \sin C$, $A_b = \frac{1}{2} a \sin C$, $A_c = \frac{1}{2} ab \cos C$
 $\Rightarrow dA = \left(\frac{1}{2} b \sin C\right) da + \left(\frac{1}{2} a \sin C\right) db + \left(\frac{1}{2} ab \cos C\right) dC$; $dC = |2^\circ| = |0.0349|$ radians, $da = |0.5|$ ft,
 $db = |0.5|$ ft; at $a = 150$ ft, $b = 200$ ft, and $C = 60^\circ$, we see that the change is approximately
 $dA = \frac{1}{2} (200)(\sin 60^\circ) |0.5| + \frac{1}{2} (150)(\sin 60^\circ) |0.5| + \frac{1}{2} (200)(150)(\cos 60^\circ) |0.0349| = \pm 338 \text{ ft}^2$
59. $z = f(x, y) \Rightarrow g(x, y, z) = f(x, y) - z = 0 \Rightarrow g_x(x, y, z) = f_x(x, y)$, $g_y(x, y, z) = f_y(x, y)$ and $g_z(x, y, z) = -1$
 $\Rightarrow g_x(x_0, y_0, f(x_0, y_0)) = f_x(x_0, y_0)$, $g_y(x_0, y_0, f(x_0, y_0)) = f_y(x_0, y_0)$ and $g_z(x_0, y_0, f(x_0, y_0)) = -1 \Rightarrow$ the tangent
plane at the point P_0 is $f_x(x_0, y_0)(x - x_0) + f_y(x_0, y_0)(y - y_0) - [z - f(x_0, y_0)] = 0$ or
 $z = f_x(x_0, y_0)(x - x_0) + f_y(x_0, y_0)(y - y_0) + f(x_0, y_0)$
60. $\nabla f = 2x\mathbf{i} + 2y\mathbf{j} = 2(\cos t + t \sin t)\mathbf{i} + 2(\sin t - t \cos t)\mathbf{j}$ and $\mathbf{v} = (t \cos t)\mathbf{i} + (t \sin t)\mathbf{j} \Rightarrow \mathbf{u} = \frac{\mathbf{v}}{|\mathbf{v}|}$
 $= \frac{(t \cos t)\mathbf{i} + (t \sin t)\mathbf{j}}{\sqrt{(t \cos t)^2 + (t \sin t)^2}} = (\cos t)\mathbf{i} + (\sin t)\mathbf{j}$ since $t > 0 \Rightarrow (D_{\mathbf{u}}f)_{P_0} = \nabla f \cdot \mathbf{u}$
 $= 2(\cos t + t \sin t)(\cos t) + 2(\sin t - t \cos t)(\sin t) = 2$
61. $\nabla f = 2x\mathbf{i} + 2y\mathbf{j} + 2z\mathbf{k} = (2 \cos t)\mathbf{i} + (2 \sin t)\mathbf{j} + 2t\mathbf{k}$ and $\mathbf{v} = (-\sin t)\mathbf{i} + (\cos t)\mathbf{j} + \mathbf{k} \Rightarrow \mathbf{u} = \frac{\mathbf{v}}{|\mathbf{v}|}$
 $= \frac{(-\sin t)\mathbf{i} + (\cos t)\mathbf{j} + \mathbf{k}}{\sqrt{(\sin t)^2 + (\cos t)^2 + 1}} = \left(\frac{-\sin t}{\sqrt{2}}\right)\mathbf{i} + \left(\frac{\cos t}{\sqrt{2}}\right)\mathbf{j} + \frac{1}{\sqrt{2}}\mathbf{k} \Rightarrow (D_{\mathbf{u}}f)_{P_0} = \nabla f \cdot \mathbf{u}$
 $= (2 \cos t) \left(\frac{-\sin t}{\sqrt{2}}\right) + (2 \sin t) \left(\frac{\cos t}{\sqrt{2}}\right) + (2t) \left(\frac{1}{\sqrt{2}}\right) = \frac{2t}{\sqrt{2}} \Rightarrow (D_{\mathbf{u}}f) \left(\frac{-\pi}{4}\right) = \frac{-\pi}{2\sqrt{2}}$, $(D_{\mathbf{u}}f)(0) = 0$ and
 $(D_{\mathbf{u}}f) \left(\frac{\pi}{4}\right) = \frac{\pi}{2\sqrt{2}}$
62. $\mathbf{r} = \sqrt{t}\mathbf{i} + \sqrt{t}\mathbf{j} - \frac{1}{4}(t+3)\mathbf{k} \Rightarrow \mathbf{v} = \frac{1}{2}t^{-1/2}\mathbf{i} + \frac{1}{2}t^{-1/2}\mathbf{j} - \frac{1}{4}\mathbf{k}$; $t = 1 \Rightarrow x = 1, y = 1, z = -1 \Rightarrow P_0 = (1, 1, -1)$
and $\mathbf{v}(1) = \frac{1}{2}\mathbf{i} + \frac{1}{2}\mathbf{j} - \frac{1}{4}\mathbf{k}$; $f(x, y, z) = x^2 + y^2 - z - 3 = 0 \Rightarrow \nabla f = 2x\mathbf{i} + 2y\mathbf{j} - \mathbf{k}$
 $\Rightarrow \nabla f(1, 1, -1) = 2\mathbf{i} + 2\mathbf{j} - \mathbf{k}$; therefore $\mathbf{v} = \frac{1}{4}(\nabla f) \Rightarrow$ the curve is normal to the surface
63. $\mathbf{r} = \sqrt{t}\mathbf{i} + \sqrt{t}\mathbf{j} + (2t-1)\mathbf{k} \Rightarrow \mathbf{v} = \frac{1}{2}t^{-1/2}\mathbf{i} + \frac{1}{2}t^{-1/2}\mathbf{j} + 2\mathbf{k}$; $t = 1 \Rightarrow x = 1, y = 1, z = 1 \Rightarrow P_0 = (1, 1, 1)$ and
 $\mathbf{v}(1) = \frac{1}{2}\mathbf{i} + \frac{1}{2}\mathbf{j} + 2\mathbf{k}$; $f(x, y, z) = x^2 + y^2 - z - 1 = 0 \Rightarrow \nabla f = 2x\mathbf{i} + 2y\mathbf{j} - \mathbf{k} \Rightarrow \nabla f(1, 1, 1) = 2\mathbf{i} + 2\mathbf{j} - \mathbf{k}$;
now $\mathbf{v}(1) \cdot \nabla f(1, 1, 1) = 0$, thus the curve is tangent to the surface when $t = 1$

14.7 EXTREME VALUES AND SADDLE POINTS

1. $f_x(x, y) = 2x + y + 3 = 0$ and $f_y(x, y) = x + 2y - 3 = 0 \Rightarrow x = -3$ and $y = 3 \Rightarrow$ critical point is $(-3, 3)$;
 $f_{xx}(-3, 3) = 2$, $f_{yy}(-3, 3) = 2$, $f_{xy}(-3, 3) = 1 \Rightarrow f_{xx}f_{yy} - f_{xy}^2 = 3 > 0$ and $f_{xx} > 0 \Rightarrow$ local minimum of
 $f(-3, 3) = -5$

2. $f_x(x, y) = 2x + 3y - 6 = 0$ and $f_y(x, y) = 3x + 6y + 3 = 0 \Rightarrow x = 15$ and $y = -8 \Rightarrow$ critical point is $(15, -8)$;
 $f_{xx}(15, -8) = 2$, $f_{yy}(15, -8) = 6$, $f_{xy}(15, -8) = 3 \Rightarrow f_{xx}f_{yy} - f_{xy}^2 = 3 > 0$ and $f_{xx} > 0 \Rightarrow$ local minimum of
 $f(15, -8) = -63$
3. $f_x(x, y) = 2y - 10x + 4 = 0$ and $f_y(x, y) = 2x - 4y + 4 = 0 \Rightarrow x = \frac{2}{3}$ and $y = \frac{4}{3} \Rightarrow$ critical point is $(\frac{2}{3}, \frac{4}{3})$;
 $f_{xx}(\frac{2}{3}, \frac{4}{3}) = -10$, $f_{yy}(\frac{2}{3}, \frac{4}{3}) = -4$, $f_{xy}(\frac{2}{3}, \frac{4}{3}) = 2 \Rightarrow f_{xx}f_{yy} - f_{xy}^2 = 36 > 0$ and $f_{xx} < 0 \Rightarrow$ local maximum of
 $f(\frac{2}{3}, \frac{4}{3}) = 0$
4. $f_x(x, y) = 2y - 10x + 4 = 0$ and $f_y(x, y) = 2x - 4y = 0 \Rightarrow x = \frac{4}{9}$ and $y = \frac{2}{9} \Rightarrow$ critical point is $(\frac{4}{9}, \frac{2}{9})$;
 $f_{xx}(\frac{4}{9}, \frac{2}{9}) = -10$, $f_{yy}(\frac{4}{9}, \frac{2}{9}) = -4$, $f_{xy}(\frac{4}{9}, \frac{2}{9}) = 2 \Rightarrow f_{xx}f_{yy} - f_{xy}^2 = 36 > 0$ and $f_{xx} < 0 \Rightarrow$ local maximum of
 $f(\frac{4}{9}, \frac{2}{9}) = -\frac{28}{9}$
5. $f_x(x, y) = 2x + y + 3 = 0$ and $f_y(x, y) = x + 2 = 0 \Rightarrow x = -2$ and $y = 1 \Rightarrow$ critical point is $(-2, 1)$;
 $f_{xx}(-2, 1) = 2$, $f_{yy}(-2, 1) = 0$, $f_{xy}(-2, 1) = 1 \Rightarrow f_{xx}f_{yy} - f_{xy}^2 = -1 < 0 \Rightarrow$ saddle point
6. $f_x(x, y) = y - 2 = 0$ and $f_y(x, y) = 2y + x - 2 = 0 \Rightarrow x = -2$ and $y = 2 \Rightarrow$ critical point is $(-2, 2)$;
 $f_{xx}(-2, 2) = 0$, $f_{yy}(-2, 2) = 2$, $f_{xy}(-2, 2) = 1 \Rightarrow f_{xx}f_{yy} - f_{xy}^2 = -1 < 0 \Rightarrow$ saddle point
7. $f_x(x, y) = 5y - 14x + 3 = 0$ and $f_y(x, y) = 5x - 6 = 0 \Rightarrow x = \frac{6}{5}$ and $y = \frac{69}{25} \Rightarrow$ critical point is $(\frac{6}{5}, \frac{69}{25})$;
 $f_{xx}(\frac{6}{5}, \frac{69}{25}) = -14$, $f_{yy}(\frac{6}{5}, \frac{69}{25}) = 0$, $f_{xy}(\frac{6}{5}, \frac{69}{25}) = 5 \Rightarrow f_{xx}f_{yy} - f_{xy}^2 = -25 < 0 \Rightarrow$ saddle point
8. $f_x(x, y) = 2y - 2x + 3 = 0$ and $f_y(x, y) = 2x - 4y = 0 \Rightarrow x = 3$ and $y = \frac{3}{2} \Rightarrow$ critical point is $(3, \frac{3}{2})$;
 $f_{xx}(3, \frac{3}{2}) = -2$, $f_{yy}(3, \frac{3}{2}) = -4$, $f_{xy}(3, \frac{3}{2}) = 2 \Rightarrow f_{xx}f_{yy} - f_{xy}^2 = 4 > 0$ and $f_{xx} < 0 \Rightarrow$ local maximum of
 $f(3, \frac{3}{2}) = \frac{17}{2}$
9. $f_x(x, y) = 2x - 4y = 0$ and $f_y(x, y) = -4x + 2y + 6 = 0 \Rightarrow x = 2$ and $y = 1 \Rightarrow$ critical point is $(2, 1)$;
 $f_{xx}(2, 1) = 2$, $f_{yy}(2, 1) = 2$, $f_{xy}(2, 1) = -4 \Rightarrow f_{xx}f_{yy} - f_{xy}^2 = -12 < 0 \Rightarrow$ saddle point
10. $f_x(x, y) = 6x + 6y - 2 = 0$ and $f_y(x, y) = 6x + 14y + 4 = 0 \Rightarrow x = \frac{13}{12}$ and $y = -\frac{3}{4} \Rightarrow$ critical point is $(\frac{13}{12}, -\frac{3}{4})$;
 $f_{xx}(\frac{13}{12}, -\frac{3}{4}) = 6$, $f_{yy}(\frac{13}{12}, -\frac{3}{4}) = 14$, $f_{xy}(\frac{13}{12}, -\frac{3}{4}) = 6 \Rightarrow f_{xx}f_{yy} - f_{xy}^2 = 48 > 0$ and $f_{xx} > 0 \Rightarrow$ local minimum of
 $f(\frac{13}{12}, -\frac{3}{4}) = -\frac{31}{12}$
11. $f_x(x, y) = 4x + 3y - 5 = 0$ and $f_y(x, y) = 3x + 8y + 2 = 0 \Rightarrow x = 2$ and $y = -1 \Rightarrow$ critical point is $(2, -1)$;
 $f_{xx}(2, -1) = 4$, $f_{yy}(2, -1) = 8$, $f_{xy}(2, -1) = 3 \Rightarrow f_{xx}f_{yy} - f_{xy}^2 = 23 > 0$ and $f_{xx} > 0 \Rightarrow$ local minimum of
 $f(2, -1) = -6$
12. $f_x(x, y) = 8x - 6y - 20 = 0$ and $f_y(x, y) = -6x + 10y + 26 = 0 \Rightarrow x = 1$ and $y = -2 \Rightarrow$ critical point is $(1, -2)$;
 $f_{xx}(1, -2) = 8$, $f_{yy}(1, -2) = 10$, $f_{xy}(1, -2) = -6 \Rightarrow f_{xx}f_{yy} - f_{xy}^2 = 44 > 0$ and $f_{xx} > 0 \Rightarrow$ local minimum of
 $f(1, -2) = -36$
13. $f_x(x, y) = 2x - 2 = 0$ and $f_y(x, y) = -2y + 4 = 0 \Rightarrow x = 1$ and $y = 2 \Rightarrow$ critical point is $(1, 2)$; $f_{xx}(1, 2) = 2$,
 $f_{yy}(1, 2) = -2$, $f_{xy}(1, 2) = 0 \Rightarrow f_{xx}f_{yy} - f_{xy}^2 = -4 < 0 \Rightarrow$ saddle point
14. $f_x(x, y) = 2x - 2y - 2 = 0$ and $f_y(x, y) = -2x + 4y + 2 = 0 \Rightarrow x = 1$ and $y = 0 \Rightarrow$ critical point is $(1, 0)$;
 $f_{xx}(1, 0) = 2$, $f_{yy}(1, 0) = 4$, $f_{xy}(1, 0) = -2 \Rightarrow f_{xx}f_{yy} - f_{xy}^2 = 4 > 0$ and $f_{xx} > 0 \Rightarrow$ local minimum of
 $f(1, 0) = 0$

15. $f_x(x, y) = 2x + 2y = 0$ and $f_y(x, y) = 2x = 0 \Rightarrow x = 0$ and $y = 0 \Rightarrow$ critical point is $(0, 0)$; $f_{xx}(0, 0) = 2$,
 $f_{yy}(0, 0) = 0$, $f_{xy}(0, 0) = 2 \Rightarrow f_{xx}f_{yy} - f_{xy}^2 = -4 < 0 \Rightarrow$ saddle point
16. $f_x(x, y) = 2 - 4x - 2y = 0$ and $f_y(x, y) = 2 - 2x - 2y = 0 \Rightarrow x = 0$ and $y = 1 \Rightarrow$ critical point is $(0, 1)$;
 $f_{xx}(0, 1) = -4$, $f_{yy}(0, 1) = -2$, $f_{xy}(0, 1) = -2 \Rightarrow f_{xx}f_{yy} - f_{xy}^2 = 4 > 0$ and $f_{xx} < 0 \Rightarrow$ local maximum of $f(0, 1) = 4$
17. $f_x(x, y) = 3x^2 - 2y = 0$ and $f_y(x, y) = -3y^2 - 2x = 0 \Rightarrow x = 0$ and $y = 0$, or $x = -\frac{2}{3}$ and $y = \frac{2}{3} \Rightarrow$ critical points
are $(0, 0)$ and $(-\frac{2}{3}, \frac{2}{3})$; for $(0, 0)$: $f_{xx}(0, 0) = 6x|_{(0,0)} = 0$, $f_{yy}(0, 0) = -6y|_{(0,0)} = 0$, $f_{xy}(0, 0) = -2$
 $\Rightarrow f_{xx}f_{yy} - f_{xy}^2 = -4 < 0 \Rightarrow$ saddle point; for $(-\frac{2}{3}, \frac{2}{3})$: $f_{xx}(-\frac{2}{3}, \frac{2}{3}) = -4$, $f_{yy}(-\frac{2}{3}, \frac{2}{3}) = -4$, $f_{xy}(-\frac{2}{3}, \frac{2}{3}) = -2$
 $\Rightarrow f_{xx}f_{yy} - f_{xy}^2 = 12 > 0$ and $f_{xx} < 0 \Rightarrow$ local maximum of $f(-\frac{2}{3}, \frac{2}{3}) = \frac{170}{27}$
18. $f_x(x, y) = 3x^2 + 3y = 0$ and $f_y(x, y) = 3x + 3y^2 = 0 \Rightarrow x = 0$ and $y = 0$, or $x = -1$ and $y = -1 \Rightarrow$ critical points
are $(0, 0)$ and $(-1, -1)$; for $(0, 0)$: $f_{xx}(0, 0) = 6x|_{(0,0)} = 0$, $f_{yy}(0, 0) = 6y|_{(0,0)} = 0$, $f_{xy}(0, 0) = 3 \Rightarrow f_{xx}f_{yy} - f_{xy}^2$
 $= -9 < 0 \Rightarrow$ saddle point; for $(-1, -1)$: $f_{xx}(-1, -1) = -6$, $f_{yy}(-1, -1) = -6$, $f_{xy}(-1, -1) = 3 \Rightarrow f_{xx}f_{yy} - f_{xy}^2$
 $= 27 > 0$ and $f_{xx} < 0 \Rightarrow$ local maximum of $f(-1, -1) = 1$
19. $f_x(x, y) = 12x - 6x^2 + 6y = 0$ and $f_y(x, y) = 6y + 6x = 0 \Rightarrow x = 0$ and $y = 0$, or $x = 1$ and $y = -1 \Rightarrow$ critical
points are $(0, 0)$ and $(1, -1)$; for $(0, 0)$: $f_{xx}(0, 0) = 12 - 12x|_{(0,0)} = 12$, $f_{yy}(0, 0) = 6$, $f_{xy}(0, 0) = 6 \Rightarrow f_{xx}f_{yy} - f_{xy}^2$
 $= 36 > 0$ and $f_{xx} > 0 \Rightarrow$ local minimum of $f(0, 0) = 0$; for $(1, -1)$: $f_{xx}(1, -1) = 0$, $f_{yy}(1, -1) = 6$,
 $f_{xy}(1, -1) = 6 \Rightarrow f_{xx}f_{yy} - f_{xy}^2 = -36 < 0 \Rightarrow$ saddle point
20. $f_x(x, y) = -6x + 6y = 0 \Rightarrow x = y$; $f_y(x, y) = 6y - 6y^2 + 6x = 0 \Rightarrow 12y - 6y^2 = 0 \Rightarrow 6y(2 - y) = 0 \Rightarrow y = 0$ or
 $y = 2 \Rightarrow (0, 0)$ and $(2, 2)$ are the critical points; $f_{xx}(x, y) = -6$, $f_{yy}(x, y) = 6 - 12y$, $f_{xy}(x, y) = 6$; for $(0, 0)$:
 $f_{xx}(0, 0) = -6$, $f_{yy}(0, 0) = 6$, $f_{xy}(0, 0) = 6 \Rightarrow f_{xx}f_{yy} - f_{xy}^2 = -72 < 0 \Rightarrow$ saddle point; for $(2, 2)$: $f_{xx}(2, 2) = -6$,
 $f_{yy}(2, 2) = -18$, $f_{xy}(2, 2) = 6 \Rightarrow f_{xx}f_{yy} - f_{xy}^2 = 72 > 0$ and $f_{xx} < 0 \Rightarrow$ local maximum of $f(2, 2) = 8$
21. $f_x(x, y) = 27x^2 - 4y = 0$ and $f_y(x, y) = y^2 - 4x = 0 \Rightarrow x = 0$ and $y = 0$, or $x = \frac{4}{9}$ and $y = \frac{4}{3} \Rightarrow$ critical points are
 $(0, 0)$ and $(\frac{4}{9}, \frac{4}{3})$; for $(0, 0)$: $f_{xx}(0, 0) = 54x|_{(0,0)} = 0$, $f_{yy}(0, 0) = 2y|_{(0,0)} = 0$, $f_{xy}(0, 0) = -4 \Rightarrow f_{xx}f_{yy} - f_{xy}^2$
 $= -16 < 0 \Rightarrow$ saddle point; for $(\frac{4}{9}, \frac{4}{3})$: $f_{xx}(\frac{4}{9}, \frac{4}{3}) = 24$, $f_{yy}(\frac{4}{9}, \frac{4}{3}) = \frac{8}{3}$, $f_{xy}(\frac{4}{9}, \frac{4}{3}) = -4 \Rightarrow f_{xx}f_{yy} - f_{xy}^2 = 48 > 0$
and $f_{xx} > 0 \Rightarrow$ local minimum of $f(\frac{4}{9}, \frac{4}{3}) = -\frac{64}{81}$
22. $f_x(x, y) = 24x^2 + 6y = 0 \Rightarrow y = -4x^2$; $f_y(x, y) = 3y^2 + 6x = 0 \Rightarrow 3(-4x^2)^2 + 6x = 0 \Rightarrow 16x^4 + 2x = 0$
 $\Rightarrow 2x(8x^3 + 1) = 0 \Rightarrow x = 0$ or $x = -\frac{1}{2} \Rightarrow (0, 0)$ and $(-\frac{1}{2}, -1)$ are the critical points; $f_{xx}(x, y) = 48x$,
 $f_{yy}(x, y) = 6y$, and $f_{xy}(x, y) = 6$; for $(0, 0)$: $f_{xx}(0, 0) = 0$, $f_{yy}(0, 0) = 0$, $f_{xy}(0, 0) = 6 \Rightarrow f_{xx}f_{yy} - f_{xy}^2 = -36 < 0$
 \Rightarrow saddle point; for $(-\frac{1}{2}, -1)$: $f_{xx}(-\frac{1}{2}, -1) = -24$, $f_{yy}(-\frac{1}{2}, -1) = -6$, $f_{xy}(-\frac{1}{2}, -1) = 6$
 $\Rightarrow f_{xx}f_{yy} - f_{xy}^2 = 108 > 0$ and $f_{xx} < 0 \Rightarrow$ local maximum of $f(-\frac{1}{2}, -1) = 1$
23. $f_x(x, y) = 3x^2 + 6x = 0 \Rightarrow x = 0$ or $x = -2$; $f_y(x, y) = 3y^2 - 6y = 0 \Rightarrow y = 0$ or $y = 2 \Rightarrow$ the critical points are
 $(0, 0)$, $(0, 2)$, $(-2, 0)$, and $(-2, 2)$; for $(0, 0)$: $f_{xx}(0, 0) = 6x + 6|_{(0,0)} = 6$, $f_{yy}(0, 0) = 6y - 6|_{(0,0)} = -6$,
 $f_{xy}(0, 0) = 0 \Rightarrow f_{xx}f_{yy} - f_{xy}^2 = -36 < 0 \Rightarrow$ saddle point; for $(0, 2)$: $f_{xx}(0, 2) = 6$, $f_{yy}(0, 2) = 6$, $f_{xy}(0, 2) = 0$
 $\Rightarrow f_{xx}f_{yy} - f_{xy}^2 = 36 > 0$ and $f_{xx} > 0 \Rightarrow$ local minimum of $f(0, 2) = -12$; for $(-2, 0)$: $f_{xx}(-2, 0) = -6$,
 $f_{yy}(-2, 0) = -6$, $f_{xy}(-2, 0) = 0 \Rightarrow f_{xx}f_{yy} - f_{xy}^2 = 36 > 0$ and $f_{xx} < 0 \Rightarrow$ local maximum of $f(-2, 0) = -4$;
for $(-2, 2)$: $f_{xx}(-2, 2) = -6$, $f_{yy}(-2, 2) = 6$, $f_{xy}(-2, 2) = 0 \Rightarrow f_{xx}f_{yy} - f_{xy}^2 = -36 < 0 \Rightarrow$ saddle point

24. $f_x(x, y) = 6x^2 - 18x = 0 \Rightarrow 6x(x - 3) = 0 \Rightarrow x = 0$ or $x = 3$; $f_y(x, y) = 6y^2 + 6y - 12 = 0 \Rightarrow 6(y + 2)(y - 1) = 0 \Rightarrow y = -2$ or $y = 1 \Rightarrow$ the critical points are $(0, -2)$, $(0, 1)$, $(3, -2)$, and $(3, 1)$; $f_{xx}(x, y) = 12x - 18$, $f_{yy}(x, y) = 12y + 6$, and $f_{xy}(x, y) = 0$; for $(0, -2)$: $f_{xx}(0, -2) = -18$, $f_{yy}(0, -2) = -18$, $f_{xy}(0, -2) = 0 \Rightarrow f_{xx}f_{yy} - f_{xy}^2 = 324 > 0$ and $f_{xx} < 0 \Rightarrow$ local maximum of $f(0, -2) = 20$; for $(0, 1)$: $f_{xx}(0, 1) = -18$, $f_{yy}(0, 1) = 18$, $f_{xy}(0, 1) = 0 \Rightarrow f_{xx}f_{yy} - f_{xy}^2 = -324 < 0 \Rightarrow$ saddle point; for $(3, -2)$: $f_{xx}(3, -2) = 18$, $f_{yy}(3, -2) = -18$, $f_{xy}(3, -2) = 0 \Rightarrow f_{xx}f_{yy} - f_{xy}^2 = -324 < 0 \Rightarrow$ saddle point; for $(3, 1)$: $f_{xx}(3, 1) = 18$, $f_{yy}(3, 1) = 18$, $f_{xy}(3, 1) = 0 \Rightarrow f_{xx}f_{yy} - f_{xy}^2 = 324 > 0$ and $f_{xx} > 0 \Rightarrow$ local minimum of $f(3, 1) = -34$

25. $f_x(x, y) = 4y - 4x^3 = 0$ and $f_y(x, y) = 4x - 4y^3 = 0 \Rightarrow x = y \Rightarrow x(1 - x^2) = 0 \Rightarrow x = 0, 1, -1 \Rightarrow$ the critical points are $(0, 0)$, $(1, 1)$, and $(-1, -1)$; for $(0, 0)$: $f_{xx}(0, 0) = -12x^2|_{(0,0)} = 0$, $f_{yy}(0, 0) = -12y^2|_{(0,0)} = 0$, $f_{xy}(0, 0) = 4 \Rightarrow f_{xx}f_{yy} - f_{xy}^2 = -16 < 0 \Rightarrow$ saddle point; for $(1, 1)$: $f_{xx}(1, 1) = -12$, $f_{yy}(1, 1) = -12$, $f_{xy}(1, 1) = 4 \Rightarrow f_{xx}f_{yy} - f_{xy}^2 = 128 > 0$ and $f_{xx} < 0 \Rightarrow$ local maximum of $f(1, 1) = 2$; for $(-1, -1)$: $f_{xx}(-1, -1) = -12$, $f_{yy}(-1, -1) = -12$, $f_{xy}(-1, -1) = 4 \Rightarrow f_{xx}f_{yy} - f_{xy}^2 = 128 > 0$ and $f_{xx} < 0 \Rightarrow$ local maximum of $f(-1, -1) = 2$

26. $f_x(x, y) = 4x^3 + 4y = 0$ and $f_y(x, y) = 4y^3 + 4x = 0 \Rightarrow x = -y \Rightarrow -x^3 + x = 0 \Rightarrow x(1 - x^2) = 0 \Rightarrow x = 0, 1, -1 \Rightarrow$ the critical points are $(0, 0)$, $(1, -1)$, and $(-1, 1)$; $f_{xx}(x, y) = 12x^2$, $f_{yy}(x, y) = 12y^2$, and $f_{xy}(x, y) = 4$; for $(0, 0)$: $f_{xx}(0, 0) = 0$, $f_{yy}(0, 0) = 0$, $f_{xy}(0, 0) = 4 \Rightarrow f_{xx}f_{yy} - f_{xy}^2 = -16 < 0 \Rightarrow$ saddle point; for $(1, -1)$: $f_{xx}(1, -1) = 12$, $f_{yy}(1, -1) = 12$, $f_{xy}(1, -1) = 4 \Rightarrow f_{xx}f_{yy} - f_{xy}^2 = 128 > 0$ and $f_{xx} > 0 \Rightarrow$ local minimum of $f(1, -1) = -2$; for $(-1, 1)$: $f_{xx}(-1, 1) = 12$, $f_{yy}(-1, 1) = 12$, $f_{xy}(-1, 1) = 4 \Rightarrow f_{xx}f_{yy} - f_{xy}^2 = 128 > 0$ and $f_{xx} > 0 \Rightarrow$ local minimum of $f(-1, 1) = -2$

27. $f_x(x, y) = \frac{-2x}{(x^2 + y^2 - 1)^2} = 0$ and $f_y(x, y) = \frac{-2y}{(x^2 + y^2 - 1)^2} = 0 \Rightarrow x = 0$ and $y = 0 \Rightarrow$ the critical point is $(0, 0)$;
 $f_{xx} = \frac{4x^2 - 2y^2 + 2}{(x^2 + y^2 - 1)^3}$, $f_{yy} = \frac{-2x^2 + 4y^2 + 2}{(x^2 + y^2 - 1)^3}$, $f_{xy} = \frac{8xy}{(x^2 + y^2 - 1)^3}$; $f_{xx}(0, 0) = -2$, $f_{yy}(0, 0) = -2$, $f_{xy}(0, 0) = 0 \Rightarrow f_{xx}f_{yy} - f_{xy}^2 = 4 > 0$ and $f_{xx} < 0 \Rightarrow$ local maximum of $f(0, 0) = -1$

28. $f_x(x, y) = -\frac{1}{x^2} + y = 0$ and $f_y(x, y) = x - \frac{1}{y^2} = 0 \Rightarrow x = 1$ and $y = 1 \Rightarrow$ the critical point is $(1, 1)$;
 $f_{xx} = \frac{2}{x^3}$, $f_{yy} = \frac{2}{y^3}$, $f_{xy} = 1$; $f_{xx}(1, 1) = 2$, $f_{yy}(1, 1) = 2$, $f_{xy}(1, 1) = 1 \Rightarrow f_{xx}f_{yy} - f_{xy}^2 = 3 > 0$ and $f_{xx} > 2 \Rightarrow$ local minimum of $f(1, 1) = 3$

29. $f_x(x, y) = y \cos x = 0$ and $f_y(x, y) = \sin x = 0 \Rightarrow x = n\pi$, n an integer, and $y = 0 \Rightarrow$ the critical points are $(n\pi, 0)$, n an integer (Note: $\cos x$ and $\sin x$ cannot both be 0 for the same x , so $\sin x$ must be 0 and $y = 0$);
 $f_{xx} = -y \sin x$, $f_{yy} = 0$, $f_{xy} = \cos x$; $f_{xx}(n\pi, 0) = 0$, $f_{yy}(n\pi, 0) = 0$, $f_{xy}(n\pi, 0) = 1$ if n is even and $f_{xy}(n\pi, 0) = -1$ if n is odd $\Rightarrow f_{xx}f_{yy} - f_{xy}^2 = -1 < 0 \Rightarrow$ saddle point.

30. $f_x(x, y) = 2e^{2x} \cos y = 0$ and $f_y(x, y) = -e^{2x} \sin y = 0 \Rightarrow$ no solution since $e^{2x} \neq 0$ for any x and the functions $\cos y$ and $\sin y$ cannot equal 0 for the same $y \Rightarrow$ no critical points \Rightarrow no extrema and no saddle points

31. (i) On OA, $f(x, y) = f(0, y) = y^2 - 4y + 1$ on $0 \leq y \leq 2$;

$f'(0, y) = 2y - 4 = 0 \Rightarrow y = 2$;
 $f(0, 0) = 1$ and $f(0, 2) = -3$

(ii) On AB, $f(x, y) = f(x, 2) = 2x^2 - 4x - 3$ on $0 \leq x \leq 1$;

$f'(x, 2) = 4x - 4 = 0 \Rightarrow x = 1$;
 $f(0, 2) = -3$ and $f(1, 2) = -5$

(iii) On OB, $f(x, y) = f(x, 2x) = 6x^2 - 12x + 1$ on

$0 \leq x \leq 1$; endpoint values have been found above;

$f'(x, 2x) = 12x - 12 = 0 \Rightarrow x = 1$ and $y = 2$, but $(1, 2)$ is not an interior point of OB

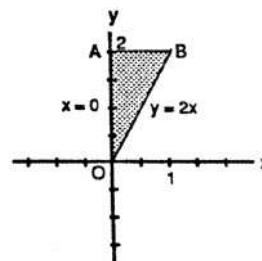

- (iv) For interior points of the triangular region, $f_x(x, y) = 4x - 4 = 0$ and $f_y(x, y) = 2y - 4 = 0$
 $\Rightarrow x = 1$ and $y = 2$, but $(1, 2)$ is not an interior point of the region. Therefore, the absolute maximum is 1 at $(0, 0)$ and the absolute minimum is -5 at $(1, 2)$.

32. (i) On OA, $D(x, y) = D(0, y) = y^2 + 1$ on $0 \leq y \leq 4$;
 $D'(0, y) = 2y = 0 \Rightarrow y = 0$; $D(0, 0) = 1$ and
 $D(0, 4) = 17$
- (ii) On AB, $D(x, y) = D(x, 4) = x^2 - 4x + 17$ on
 $0 \leq x \leq 4$; $D'(x, 4) = 2x - 4 = 0 \Rightarrow x = 2$ and $(2, 4)$
 is an interior point of AB; $D(2, 4) = 13$ and
 $D(4, 4) = D(0, 4) = 17$
- (iii) On OB, $D(x, y) = D(x, x) = x^2 + 1$ on $0 \leq x \leq 4$;
 $D'(x, x) = 2x = 0 \Rightarrow x = 0$ and $y = 0$, which is not an interior point of OB; endpoint values have been found above
- (iv) For interior points of the triangular region, $f_x(x, y) = 2x - y = 0$ and $f_y(x, y) = -x + 2y = 0 \Rightarrow x = 0$ and $y = 0$, which is not an interior point of the region. Therefore, the absolute maximum is 17 at $(0, 4)$ and $(4, 4)$, and the absolute minimum is 1 at $(0, 0)$.

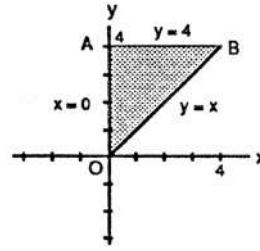

33. (i) On OA, $f(x, y) = f(0, y) = y^2$ on $0 \leq y \leq 2$;
 $f'(0, y) = 2y = 0 \Rightarrow y = 0$ and $x = 0$; $f(0, 0) = 0$ and
 $f(0, 2) = 4$
- (ii) On OB, $f(x, y) = f(x, 0) = x^2$ on $0 \leq x \leq 1$;
 $f'(x, 0) = 2x = 0 \Rightarrow x = 0$ and $y = 0$; $f(0, 0) = 0$ and
 $f(1, 0) = 1$
- (iii) On AB, $f(x, y) = f(x, -2x + 2) = 5x^2 - 8x + 4$ on
 $0 \leq x \leq 1$; $f'(x, -2x + 2) = 10x - 8 = 0 \Rightarrow x = \frac{4}{5}$
 and $y = \frac{2}{5}$; $f(\frac{4}{5}, \frac{2}{5}) = \frac{4}{5}$; endpoint values have been found above.
- (iv) For interior points of the triangular region, $f_x(x, y) = 2x = 0$ and $f_y(x, y) = 2y = 0 \Rightarrow x = 0$ and $y = 0$, but $(0, 0)$ is not an interior point of the region. Therefore the absolute maximum is 4 at $(0, 2)$ and the absolute minimum is 0 at $(0, 0)$.

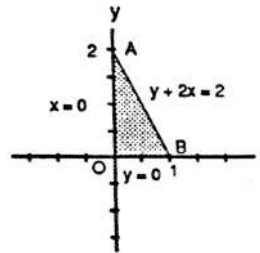

34. (i) On AB, $T(x, y) = T(0, y) = y^2$ on $-3 \leq y \leq 3$;
 $T'(0, y) = 2y = 0 \Rightarrow y = 0$ and $x = 0$; $T(0, 0) = 0$,
 $T(0, -3) = 9$, and $T(0, 3) = 9$
- (ii) On BC, $T(x, y) = T(x, 3) = x^2 - 3x + 9$ on $0 \leq x \leq 5$;
 $T'(x, 3) = 2x - 3 = 0 \Rightarrow x = \frac{3}{2}$ and $y = 3$;
 $T(\frac{3}{2}, 3) = \frac{27}{4}$ and $T(5, 3) = 19$
- (iii) On CD, $T(x, y) = T(5, y) = y^2 + 5y - 5$ on
 $-3 \leq y \leq 3$; $T'(5, y) = 2y + 5 = 0 \Rightarrow y = -\frac{5}{2}$ and
 $x = 5$; $T(5, -\frac{5}{2}) = -\frac{45}{4}$, $T(5, -3) = -11$ and $T(5, 3) = 19$
- (iv) On AD, $T(x, y) = T(x, -3) = x^2 - 9x + 9$ on $0 \leq x \leq 5$; $T'(x, -3) = 2x - 9 = 0 \Rightarrow x = \frac{9}{2}$ and $y = -3$;
 $T(\frac{9}{2}, -3) = -\frac{45}{4}$, $T(0, -3) = 9$ and $T(5, -3) = -11$
- (v) For interior points of the rectangular region, $T_x(x, y) = 2x + y - 6 = 0$ and $T_y(x, y) = x + 2y = 0 \Rightarrow x = 4$ and $y = -2 \Rightarrow (4, -2)$ is an interior critical point with $T(4, -2) = -12$. Therefore the absolute maximum is 19 at $(5, 3)$ and the absolute minimum is -12 at $(4, -2)$.

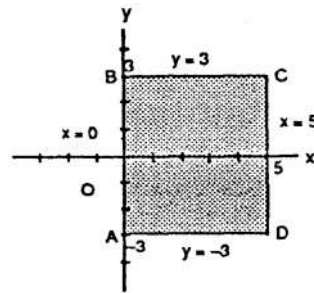

35. (i) On OC, $T(x, y) = T(x, 0) = x^2 - 6x + 2$ on $0 \leq x \leq 5$; $T'(x, 0) = 2x - 6 = 0 \Rightarrow x = 3$ and $y = 0$; $T(3, 0) = -7$, $T(0, 0) = 2$, and $T(5, 0) = -3$
- (ii) On CB, $T(x, y) = T(5, y) = y^2 + 5y - 3$ on $-3 \leq y \leq 0$; $T'(5, y) = 2y + 5 = 0 \Rightarrow y = -\frac{5}{2}$ and $x = 5$; $T(5, -\frac{5}{2}) = -\frac{37}{4}$ and $T(5, -3) = -9$
- (iii) On AB, $T(x, y) = T(x, -3) = x^2 - 9x + 11$ on $0 \leq x \leq 5$; $T'(x, -3) = 2x - 9 = 0 \Rightarrow x = \frac{9}{2}$ and $y = -3$; $T(\frac{9}{2}, -3) = -\frac{37}{4}$ and $T(0, -3) = 11$
- (iv) On AO, $T(x, y) = T(0, y) = y^2 + 2$ on $-3 \leq y \leq 0$; $T'(0, y) = 2y = 0 \Rightarrow y = 0$ and $x = 0$, but $(0, 0)$ is not an interior point of AO
- (v) For interior points of the rectangular region, $T_x(x, y) = 2x + y - 6 = 0$ and $T_y(x, y) = x + 2y = 0 \Rightarrow x = 4$ and $y = -2$, an interior critical point with $T(4, -2) = -10$. Therefore the absolute maximum is 11 at $(0, -3)$ and the absolute minimum is -10 at $(4, -2)$.

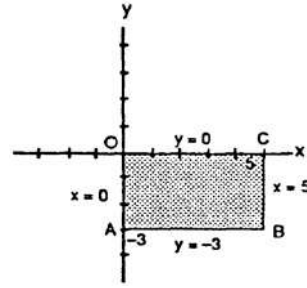

36. (i) On OA, $f(x, y) = f(0, y) = -24y^2$ on $0 \leq y \leq 1$; $f'(0, y) = -48y = 0 \Rightarrow y = 0$ and $x = 0$, but $(0, 0)$ is not an interior point of OA; $f(0, 0) = 0$ and $f(0, 1) = -24$
- (ii) On AB, $f(x, y) = f(x, 1) = 48x - 32x^3 - 24$ on $0 \leq x \leq 1$; $f'(x, 1) = 48 - 96x^2 = 0 \Rightarrow x = \frac{1}{\sqrt{2}}$ and $y = 1$, or $x = -\frac{1}{\sqrt{2}}$ and $y = 1$, but $(-\frac{1}{\sqrt{2}}, 1)$ is not in the interior of AB; $f(\frac{1}{\sqrt{2}}, 1) = 16\sqrt{2} - 24$ and $f(1, 1) = -8$
- (iii) On BC, $f(x, y) = f(1, y) = 48y - 32 - 24y^2$ on $0 \leq y \leq 1$; $f'(1, y) = 48 - 48y = 0 \Rightarrow y = 1$ and $x = 1$, but $(1, 1)$ is not an interior point of BC; $f(1, 0) = -32$ and $f(1, 1) = -8$
- (iv) On OC, $f(x, y) = f(x, 0) = -32x^3$ on $0 \leq x \leq 1$; $f'(x, 0) = -96x^2 = 0 \Rightarrow x = 0$ and $y = 0$, but $(0, 0)$ is not an interior point of OC; $f(0, 0) = 0$ and $f(1, 0) = -32$
- (v) For interior points of the rectangular region, $f_x(x, y) = 48y - 96x^2 = 0$ and $f_y(x, y) = 48x - 48y = 0 \Rightarrow x = 0$ and $y = 0$, or $x = \frac{1}{2}$ and $y = \frac{1}{2}$, but $(0, 0)$ is not an interior point of the region; $f(\frac{1}{2}, \frac{1}{2}) = 2$. Therefore the absolute maximum is 2 at $(\frac{1}{2}, \frac{1}{2})$ and the absolute minimum is -32 at $(1, 0)$.

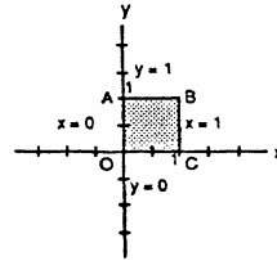

37. (i) On AB, $f(x, y) = f(1, y) = 3 \cos y$ on $-\frac{\pi}{4} \leq y \leq \frac{\pi}{4}$; $f'(1, y) = -3 \sin y = 0 \Rightarrow y = 0$ and $x = 1$; $f(1, 0) = 3$, $f(1, -\frac{\pi}{4}) = \frac{3\sqrt{2}}{2}$, and $f(1, \frac{\pi}{4}) = \frac{3\sqrt{2}}{2}$
- (ii) On CD, $f(x, y) = f(3, y) = 3 \cos y$ on $-\frac{\pi}{4} \leq y \leq \frac{\pi}{4}$; $f'(3, y) = -3 \sin y = 0 \Rightarrow y = 0$ and $x = 3$; $f(3, 0) = 3$, $f(3, -\frac{\pi}{4}) = \frac{3\sqrt{2}}{2}$ and $f(3, \frac{\pi}{4}) = \frac{3\sqrt{2}}{2}$
- (iii) On BC, $f(x, y) = f(x, \frac{\pi}{4}) = \frac{\sqrt{2}}{2}(4x - x^2)$ on $1 \leq x \leq 3$; $f'(x, \frac{\pi}{4}) = \sqrt{2}(2 - x) = 0 \Rightarrow x = 2$ and $y = \frac{\pi}{4}$; $f(2, \frac{\pi}{4}) = 2\sqrt{2}$, $f(1, \frac{\pi}{4}) = \frac{3\sqrt{2}}{2}$, and $f(3, \frac{\pi}{4}) = \frac{3\sqrt{2}}{2}$
- (iv) On AD, $f(x, y) = f(x, -\frac{\pi}{4}) = \frac{\sqrt{2}}{2}(4x - x^2)$ on $1 \leq x \leq 3$; $f'(x, -\frac{\pi}{4}) = \sqrt{2}(2 - x) = 0 \Rightarrow x = 2$ and $y = -\frac{\pi}{4}$; $f(2, -\frac{\pi}{4}) = 2\sqrt{2}$, $f(1, -\frac{\pi}{4}) = \frac{3\sqrt{2}}{2}$, and $f(3, -\frac{\pi}{4}) = \frac{3\sqrt{2}}{2}$
- (v) For interior points of the region, $f_x(x, y) = (4 - 2x) \cos y = 0$ and $f_y(x, y) = -(4x - x^2) \sin y = 0 \Rightarrow x = 2$ and $y = 0$, which is an interior critical point with $f(2, 0) = 4$. Therefore the absolute maximum is 4 at

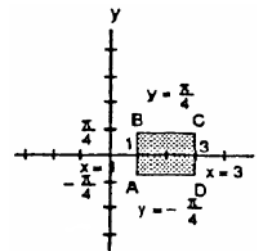

(2, 0) and the absolute minimum is $\frac{3\sqrt{2}}{2}$ at $(3, -\frac{\pi}{4})$, $(3, \frac{\pi}{4})$, $(1, -\frac{\pi}{4})$, and $(1, \frac{\pi}{4})$.

38. (i) On OA, $f(x, y) = f(0, y) = 2y + 1$ on $0 \leq y \leq 1$;
 $f'(0, y) = 2 \Rightarrow$ no interior critical points; $f(0, 0) = 1$
 and $f(0, 1) = 3$
- (ii) On OB, $f(x, y) = f(x, 0) = 4x + 1$ on $0 \leq x \leq 1$;
 $f'(x, 0) = 4 \Rightarrow$ no interior critical points; $f(1, 0) = 5$
- (iii) On AB, $f(x, y) = f(x, -x + 1) = 8x^2 - 6x + 3$ on
 $0 \leq x \leq 1$; $f'(x, -x + 1) = 16x - 6 = 0 \Rightarrow x = \frac{3}{8}$
 and $y = \frac{5}{8}$; $f(\frac{3}{8}, \frac{5}{8}) = \frac{15}{8}$, $f(0, 1) = 3$, and $f(1, 0) = 5$
- (iv) For interior points of the triangular region, $f_x(x, y) = 4 - 8y = 0$ and $f_y(x, y) = -8x + 2 = 0$
 $\Rightarrow y = \frac{1}{2}$ and $x = \frac{1}{4}$ which is an interior critical point with $f(\frac{1}{4}, \frac{1}{2}) = 2$. Therefore the absolute maximum is 5 at
 (1, 0) and the absolute minimum is 1 at (0, 0).

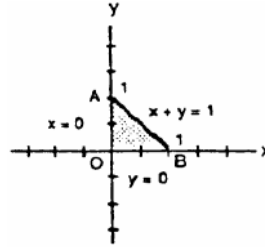

39. Let $F(a, b) = \int_a^b (6 - x - x^2) dx$ where $a \leq b$. The boundary of the domain of F is the line $a = b$ in the ab -plane, and $F(a, a) = 0$, so F is identically 0 on the boundary of its domain. For interior critical points we have: $\frac{\partial F}{\partial a} = -(6 - a - a^2) = 0 \Rightarrow a = -3, 2$ and $\frac{\partial F}{\partial b} = (6 - b - b^2) = 0 \Rightarrow b = -3, 2$. Since $a \leq b$, there is only one interior critical point $(-3, 2)$ and $F(-3, 2) = \int_{-3}^2 (6 - x - x^2) dx$ gives the area under the parabola $y = 6 - x - x^2$ that is above the x -axis. Therefore, $a = -3$ and $b = 2$.

40. Let $F(a, b) = \int_a^b (24 - 2x - x^2)^{1/3} dx$ where $a \leq b$. The boundary of the domain of F is the line $a = b$ and on this line F is identically 0. For interior critical points we have: $\frac{\partial F}{\partial a} = -(24 - 2a - a^2)^{1/3} = 0 \Rightarrow a = 4, -6$ and $\frac{\partial F}{\partial b} = (24 - 2b - b^2)^{1/3} = 0 \Rightarrow b = 4, -6$. Since $a \leq b$, there is only one critical point $(-6, 4)$ and $F(-6, 4) = \int_{-6}^4 (24 - 2x - x^2) dx$ gives the area under the curve $y = (24 - 2x - x^2)^{1/3}$ that is above the x -axis. Therefore, $a = -6$ and $b = 4$.

41. $T_x(x, y) = 2x - 1 = 0$ and $T_y(x, y) = 4y = 0 \Rightarrow x = \frac{1}{2}$ and $y = 0$ with $T(\frac{1}{2}, 0) = -\frac{1}{4}$; on the boundary $x^2 + y^2 = 1$: $T(x, y) = -x^2 - x + 2$ for $-1 \leq x \leq 1 \Rightarrow T'(x, y) = -2x - 1 = 0 \Rightarrow x = -\frac{1}{2}$ and $y = \pm \frac{\sqrt{3}}{2}$;
 $T(-\frac{1}{2}, \frac{\sqrt{3}}{2}) = \frac{9}{4}$, $T(-\frac{1}{2}, -\frac{\sqrt{3}}{2}) = \frac{9}{4}$, $T(-1, 0) = 2$, and $T(1, 0) = 0 \Rightarrow$ the hottest is $2\frac{1}{4}^\circ$ at $(-\frac{1}{2}, \frac{\sqrt{3}}{2})$ and $(-\frac{1}{2}, -\frac{\sqrt{3}}{2})$; the coldest is $-\frac{1}{4}^\circ$ at $(\frac{1}{2}, 0)$.

42. $f_x(x, y) = y + 2 - \frac{2}{x} = 0$ and $f_y(x, y) = x - \frac{1}{y} = 0 \Rightarrow x = \frac{1}{2}$ and $y = 2$; $f_{xx}(\frac{1}{2}, 2) = \frac{2}{x^2} \Big|_{(\frac{1}{2}, 2)} = 8$,
 $f_{yy}(\frac{1}{2}, 2) = \frac{1}{y^2} \Big|_{(\frac{1}{2}, 2)} = \frac{1}{4}$, $f_{xy}(\frac{1}{2}, 2) = 1 \Rightarrow f_{xx}f_{yy} - f_{xy}^2 = 1 > 0$ and $f_{xx} > 0 \Rightarrow$ a local minimum of $f(\frac{1}{2}, 2)$
 $= 2 - \ln \frac{1}{2} = 2 + \ln 2$

43. (a) $f_x(x, y) = 2x - 4y = 0$ and $f_y(x, y) = 2y - 4x = 0 \Rightarrow x = 0$ and $y = 0$; $f_{xx}(0, 0) = 2$, $f_{yy}(0, 0) = 2$,
 $f_{xy}(0, 0) = -4 \Rightarrow f_{xx}f_{yy} - f_{xy}^2 = -12 < 0 \Rightarrow$ saddle point at $(0, 0)$
- (b) $f_x(x, y) = 2x - 2 = 0$ and $f_y(x, y) = 2y - 4 = 0 \Rightarrow x = 1$ and $y = 2$; $f_{xx}(1, 2) = 2$, $f_{yy}(1, 2) = 2$,
 $f_{xy}(1, 2) = 0 \Rightarrow f_{xx}f_{yy} - f_{xy}^2 = 4 > 0$ and $f_{xx} > 0 \Rightarrow$ local minimum at $(1, 2)$
- (c) $f_x(x, y) = 9x^2 - 9 = 0$ and $f_y(x, y) = 2y + 4 = 0 \Rightarrow x = \pm 1$ and $y = -2$; $f_{xx}(1, -2) = 18x \Big|_{(1, -2)} = 18$,
 $f_{yy}(1, -2) = 2$, $f_{xy}(1, -2) = 0 \Rightarrow f_{xx}f_{yy} - f_{xy}^2 = 36 > 0$ and $f_{xx} > 0 \Rightarrow$ local minimum at $(1, -2)$;
 $f_{xx}(-1, -2) = -18$, $f_{yy}(-1, -2) = 2$, $f_{xy}(-1, -2) = 0 \Rightarrow f_{xx}f_{yy} - f_{xy}^2 = -36 < 0 \Rightarrow$ saddle point at $(-1, -2)$

44. (a) Minimum at $(0, 0)$ since $f(x, y) > 0$ for all other (x, y)
 (b) Maximum of 1 at $(0, 0)$ since $f(x, y) < 1$ for all other (x, y)
 (c) Neither since $f(x, y) < 0$ for $x < 0$ and $f(x, y) > 0$ for $x > 0$
 (d) Neither since $f(x, y) < 0$ for $x < 0$ and $f(x, y) > 0$ for $x > 0$
 (e) Neither since $f(x, y) < 0$ for $x < 0$ and $y > 0$, but $f(x, y) > 0$ for $x > 0$ and $y > 0$
 (f) Minimum at $(0, 0)$ since $f(x, y) > 0$ for all other (x, y)
45. If $k = 0$, then $f(x, y) = x^2 + y^2 \Rightarrow f_x(x, y) = 2x = 0$ and $f_y(x, y) = 2y = 0 \Rightarrow x = 0$ and $y = 0 \Rightarrow (0, 0)$ is the only critical point. If $k \neq 0$, $f_x(x, y) = 2x + ky = 0 \Rightarrow y = -\frac{2}{k}x$; $f_y(x, y) = kx + 2y = 0 \Rightarrow kx + 2(-\frac{2}{k}x) = 0 \Rightarrow kx - \frac{4x}{k} = 0 \Rightarrow (k - \frac{4}{k})x = 0 \Rightarrow x = 0$ or $k = \pm 2 \Rightarrow y = (-\frac{2}{k})(0) = 0$ or $y = \pm x$; in any case $(0, 0)$ is a critical point.
46. (See Exercise 45 above): $f_{xx}(x, y) = 2$, $f_{yy}(x, y) = 2$, and $f_{xy}(x, y) = k \Rightarrow f_{xx}f_{yy} - f_{xy}^2 = 4 - k^2$; f will have a saddle point at $(0, 0)$ if $4 - k^2 < 0 \Rightarrow k > 2$ or $k < -2$; f will have a local minimum at $(0, 0)$ if $4 - k^2 > 0 \Rightarrow -2 < k < 2$; the test is inconclusive if $4 - k^2 = 0 \Rightarrow k = \pm 2$.
47. No; for example $f(x, y) = xy$ has a saddle point at $(a, b) = (0, 0)$ where $f_x = f_y = 0$.
48. If $f_{xx}(a, b)$ and $f_{yy}(a, b)$ differ in sign, then $f_{xx}(a, b)f_{yy}(a, b) < 0$ so $f_{xx}f_{yy} - f_{xy}^2 < 0$. The surface must therefore have a saddle point at (a, b) by the second derivative test.
49. We want the point on $z = 10 - x^2 - y^2$ where the tangent plane is parallel to the plane $x + 2y + 3z = 0$. To find a normal vector to $z = 10 - x^2 - y^2$ let $w = z + x^2 + y^2 - 10$. Then $\nabla w = 2x\mathbf{i} + 2y\mathbf{j} + \mathbf{k}$ is normal to $z = 10 - x^2 - y^2$ at (x, y) . The vector ∇w is parallel to $\mathbf{i} + 2\mathbf{j} + 3\mathbf{k}$ which is normal to the plane $x + 2y + 3z = 0$ if $6x\mathbf{i} + 6y\mathbf{j} + 3\mathbf{k} = \mathbf{i} + 2\mathbf{j} + 3\mathbf{k}$ or $x = \frac{1}{6}$ and $y = \frac{1}{3}$. Thus the point is $(\frac{1}{6}, \frac{1}{3}, 10 - \frac{1}{36} - \frac{1}{9})$ or $(\frac{1}{6}, \frac{1}{3}, \frac{355}{36})$.
50. We want the point on $z = x^2 + y^2 + 10$ where the tangent plane is parallel to the plane $x + 2y - z = 0$. Let $w = z - x^2 - y^2 - 10$, then $\nabla w = -2x\mathbf{i} - 2y\mathbf{j} + \mathbf{k}$ is normal to $z = x^2 + y^2 + 10$ at (x, y) . The vector ∇w is parallel to $\mathbf{i} + 2\mathbf{j} - \mathbf{k}$ which is normal to the plane if $x = \frac{1}{2}$ and $y = 1$. Thus the point $(\frac{1}{2}, 1, \frac{1}{4} + 1 + 10)$ or $(\frac{1}{2}, 1, \frac{45}{4})$ is the point on the surface $z = x^2 + y^2 + 10$ nearest the plane $x + 2y - z = 0$.
51. No, because the domain $x \geq 0$ and $y \geq 0$ is unbounded since x and y can be as large as we please. Absolute extrema are guaranteed for continuous functions defined over closed and bounded domains in the plane. Since the domain is unbounded, the continuous function $f(x, y) = x + y$ need not have an absolute maximum (although, in this case, it does have an absolute minimum value of $f(0, 0) = 0$).
52. (a) (i) On $x = 0$, $f(x, y) = f(0, y) = y^2 - y + 1$ for $0 \leq y \leq 1$; $f'(0, y) = 2y - 1 = 0 \Rightarrow y = \frac{1}{2}$ and $x = 0$;
 $f(0, \frac{1}{2}) = \frac{3}{4}$, $f(0, 0) = 1$, and $f(0, 1) = 1$
 (ii) On $y = 1$, $f(x, y) = f(x, 1) = x^2 + x + 1$ for $0 \leq x \leq 1$; $f'(x, 1) = 2x + 1 = 0 \Rightarrow x = -\frac{1}{2}$ and $y = 1$, but $(-\frac{1}{2}, 1)$ is outside the domain; $f(0, 1) = 1$ and $f(1, 1) = 3$
 (iii) On $x = 1$, $f(x, y) = f(1, y) = y^2 + y + 1$ for $0 \leq y \leq 1$; $f'(1, y) = 2y + 1 = 0 \Rightarrow y = -\frac{1}{2}$ and $x = 1$, but $(1, -\frac{1}{2})$ is outside the domain; $f(1, 0) = 1$ and $f(1, 1) = 3$
 (iv) On $y = 0$, $f(x, y) = f(x, 0) = x^2 - x + 1$ for $0 \leq x \leq 1$; $f'(x, 0) = 2x - 1 = 0 \Rightarrow x = \frac{1}{2}$ and $y = 0$;
 $f(\frac{1}{2}, 0) = \frac{3}{4}$; $f(0, 0) = 1$, and $f(1, 0) = 1$
 (v) On the interior of the square, $f_x(x, y) = 2x + 2y - 1 = 0$ and $f_y(x, y) = 2y + 2x - 1 = 0 \Rightarrow 2x + 2y = 1 \Rightarrow (x + y) = \frac{1}{2}$. Then $f(x, y) = x^2 + y^2 + 2xy - x - y + 1 = (x + y)^2 - (x + y) + 1 = \frac{3}{4}$ is the absolute minimum value when $2x + 2y = 1$.

(b) The absolute maximum is $f(1, 1) = 3$.

53. (a) $\frac{df}{dt} = \frac{\partial f}{\partial x} \frac{dx}{dt} + \frac{\partial f}{\partial y} \frac{dy}{dt} = \frac{dx}{dt} + \frac{dy}{dt} = -2 \sin t + 2 \cos t = 0 \Rightarrow \cos t = \sin t \Rightarrow x = y$
- (i) On the semicircle $x^2 + y^2 = 4$, $y \geq 0$, we have $t = \frac{\pi}{4}$ and $x = y = \sqrt{2} \Rightarrow f(\sqrt{2}, \sqrt{2}) = 2\sqrt{2}$. At the endpoints, $f(-2, 0) = -2$ and $f(2, 0) = 2$. Therefore the absolute minimum is $f(-2, 0) = -2$ when $t = \pi$; the absolute maximum is $f(\sqrt{2}, \sqrt{2}) = 2\sqrt{2}$ when $t = \frac{\pi}{4}$.
- (ii) On the quartercircle $x^2 + y^2 = 4$, $x \geq 0$ and $y \geq 0$, the endpoints give $f(0, 2) = 2$ and $f(2, 0) = 2$. Therefore the absolute minimum is $f(2, 0) = 2$ and $f(0, 2) = 2$ when $t = 0, \frac{\pi}{2}$ respectively; the absolute maximum is $f(\sqrt{2}, \sqrt{2}) = 2\sqrt{2}$ when $t = \frac{\pi}{4}$.
- (b) $\frac{dg}{dt} = \frac{\partial g}{\partial x} \frac{dx}{dt} + \frac{\partial g}{\partial y} \frac{dy}{dt} = y \frac{dx}{dt} + x \frac{dy}{dt} = -4 \sin^2 t + 4 \cos^2 t = 0 \Rightarrow \cos t = \pm \sin t \Rightarrow x = \pm y$.
- (i) On the semicircle $x^2 + y^2 = 4$, $y \geq 0$, we obtain $x = y = \sqrt{2}$ at $t = \frac{\pi}{4}$ and $x = -\sqrt{2}$, $y = \sqrt{2}$ at $t = \frac{3\pi}{4}$. Then $g(\sqrt{2}, \sqrt{2}) = 2$ and $g(-\sqrt{2}, \sqrt{2}) = -2$. At the endpoints, $g(-2, 0) = g(2, 0) = 0$. Therefore the absolute minimum is $g(-\sqrt{2}, \sqrt{2}) = -2$ when $t = \frac{3\pi}{4}$; the absolute maximum is $g(\sqrt{2}, \sqrt{2}) = 2$ when $t = \frac{\pi}{4}$.
- (ii) On the quartercircle $x^2 + y^2 = 4$, $x \geq 0$ and $y \geq 0$, the endpoints give $g(0, 2) = 0$ and $g(2, 0) = 0$. Therefore the absolute minimum is $g(2, 0) = 0$ and $g(0, 2) = 0$ when $t = 0, \frac{\pi}{2}$ respectively; the absolute maximum is $g(\sqrt{2}, \sqrt{2}) = 2$ when $t = \frac{\pi}{4}$.
- (c) $\frac{dh}{dt} = \frac{\partial h}{\partial x} \frac{dx}{dt} + \frac{\partial h}{\partial y} \frac{dy}{dt} = 4x \frac{dx}{dt} + 2y \frac{dy}{dt} = (8 \cos t)(-2 \sin t) + (4 \sin t)(2 \cos t) = -8 \cos t \sin t = 0 \Rightarrow t = 0, \frac{\pi}{2}, \pi$ yielding the points $(2, 0)$, $(0, 2)$ for $0 \leq t \leq \pi$.
- (i) On the semicircle $x^2 + y^2 = 4$, $y \geq 0$ we have $h(2, 0) = 8$, $h(0, 2) = 4$, and $h(-2, 0) = 8$. Therefore, the absolute minimum is $h(0, 2) = 4$ when $t = \frac{\pi}{2}$; the absolute maximum is $h(2, 0) = 8$ and $h(-2, 0) = 8$ when $t = 0, \pi$ respectively.
- (ii) On the quartercircle $x^2 + y^2 = 4$, $x \geq 0$ and $y \geq 0$ the absolute minimum is $h(0, 2) = 4$ when $t = \frac{\pi}{2}$; the absolute maximum is $h(2, 0) = 8$ when $t = 0$.
54. (a) $\frac{df}{dt} = \frac{\partial f}{\partial x} \frac{dx}{dt} + \frac{\partial f}{\partial y} \frac{dy}{dt} = 2 \frac{dx}{dt} + 3 \frac{dy}{dt} = -6 \sin t + 6 \cos t = 0 \Rightarrow \sin t = \cos t \Rightarrow t = \frac{\pi}{4}$ for $0 \leq t \leq \pi$.
- (i) On the semi-ellipse, $\frac{x^2}{9} + \frac{y^2}{4} = 1$, $y \geq 0$, $f(x, y) = 2x + 3y = 6 \cos t + 6 \sin t = 6 \left(\frac{\sqrt{2}}{2}\right) + 6 \left(\frac{\sqrt{2}}{2}\right) = 6\sqrt{2}$ at $t = \frac{\pi}{4}$. At the endpoints, $f(-3, 0) = -6$ and $f(3, 0) = 6$. The absolute minimum is $f(-3, 0) = -6$ when $t = \pi$; the absolute maximum is $f\left(\frac{3\sqrt{2}}{2}, \sqrt{2}\right) = 6\sqrt{2}$ when $t = \frac{\pi}{4}$.
- (ii) On the quarter ellipse, at the endpoints $f(0, 2) = 6$ and $f(3, 0) = 6$. The absolute minimum is $f(3, 0) = 6$ and $f(0, 2) = 6$ when $t = 0, \frac{\pi}{2}$ respectively; the absolute maximum is $f\left(\frac{3\sqrt{2}}{2}, \sqrt{2}\right) = 6\sqrt{2}$ when $t = \frac{\pi}{4}$.
- (b) $\frac{dg}{dt} = \frac{\partial g}{\partial x} \frac{dx}{dt} + \frac{\partial g}{\partial y} \frac{dy}{dt} = y \frac{dx}{dt} + x \frac{dy}{dt} = (2 \sin t)(-3 \sin t) + (3 \cos t)(2 \cos t) = 6(\cos^2 t - \sin^2 t) = 6 \cos 2t = 0 \Rightarrow t = \frac{\pi}{4}, \frac{3\pi}{4}$ for $0 \leq t \leq \pi$.
- (i) On the semi-ellipse, $g(x, y) = xy = 6 \sin t \cos t$. Then $g\left(\frac{3\sqrt{2}}{2}, \sqrt{2}\right) = 3$ when $t = \frac{\pi}{4}$, and $g\left(-\frac{3\sqrt{2}}{2}, \sqrt{2}\right) = -3$ when $t = \frac{3\pi}{4}$. At the endpoints, $g(-3, 0) = g(3, 0) = 0$. The absolute minimum is $g\left(-\frac{3\sqrt{2}}{2}, \sqrt{2}\right) = -3$ when $t = \frac{3\pi}{4}$; the absolute maximum is $g\left(\frac{3\sqrt{2}}{2}, \sqrt{2}\right) = 3$ when $t = \frac{\pi}{4}$.
- (ii) On the quarter ellipse, at the endpoints $g(0, 2) = 0$ and $g(3, 0) = 0$. The absolute minimum is $g(3, 0) = 0$ and $g(0, 2) = 0$ at $t = 0, \frac{\pi}{2}$ respectively; the absolute maximum is $g\left(\frac{3\sqrt{2}}{2}, \sqrt{2}\right) = 3$ when $t = \frac{\pi}{4}$.

(c) $\frac{dh}{dt} = \frac{\partial h}{\partial x} \frac{dx}{dt} + \frac{\partial h}{\partial y} \frac{dy}{dt} = 2x \frac{dx}{dt} + 6y \frac{dy}{dt} = (6 \cos t)(-3 \sin t) + (12 \sin t)(2 \cos t) = 6 \sin t \cos t = 0$
 $\Rightarrow t = 0, \frac{\pi}{2}, \pi$ for $0 \leq t \leq \pi$, yielding the points $(3, 0)$, $(0, 2)$, and $(-3, 0)$.

(i) On the semi-ellipse, $y \geq 0$ so that $h(3, 0) = 9$, $h(0, 2) = 12$, and $h(-3, 0) = 9$. The absolute minimum is $h(3, 0) = 9$ and $h(-3, 0) = 9$ when $t = 0, \pi$ respectively; the absolute maximum is $h(0, 2) = 12$ when $t = \frac{\pi}{2}$.

(ii) On the quarter ellipse, the absolute minimum is $h(3, 0) = 9$ when $t = 0$; the absolute maximum is $h(0, 2) = 12$ when $t = \frac{\pi}{2}$.

55. $\frac{df}{dt} = \frac{\partial f}{\partial x} \frac{dx}{dt} + \frac{\partial f}{\partial y} \frac{dy}{dt} = y \frac{dx}{dt} + x \frac{dy}{dt}$

(i) $x = 2t$ and $y = t + 1 \Rightarrow \frac{df}{dt} = (t + 1)(2) + (2t)(1) = 4t + 2 = 0 \Rightarrow t = -\frac{1}{2} \Rightarrow x = -1$ and $y = \frac{1}{2}$ with $f(-1, \frac{1}{2}) = -\frac{1}{2}$. The absolute minimum is $f(-1, \frac{1}{2}) = -\frac{1}{2}$ when $t = -\frac{1}{2}$; there is no absolute maximum.

(ii) For the endpoints: $t = -1 \Rightarrow x = -2$ and $y = 0$ with $f(-2, 0) = 0$; $t = 0 \Rightarrow x = 0$ and $y = 1$ with $f(0, 1) = 0$. The absolute minimum is $f(-1, \frac{1}{2}) = -\frac{1}{2}$ when $t = -\frac{1}{2}$; the absolute maximum is $f(0, 1) = 0$ and $f(-2, 0) = 0$ when $t = -1, 0$ respectively.

(iii) There are no interior critical points. For the endpoints: $t = 0 \Rightarrow x = 0$ and $y = 1$ with $f(0, 1) = 0$; $t = 1 \Rightarrow x = 2$ and $y = 2$ with $f(2, 2) = 4$. The absolute minimum is $f(0, 1) = 0$ when $t = 0$; the absolute maximum is $f(2, 2) = 4$ when $t = 1$.

56. (a) $\frac{df}{dt} = \frac{\partial f}{\partial x} \frac{dx}{dt} + \frac{\partial f}{\partial y} \frac{dy}{dt} = 2x \frac{dx}{dt} + 2y \frac{dy}{dt}$

(i) $x = t$ and $y = 2 - 2t \Rightarrow \frac{df}{dt} = (2t)(1) + 2(2 - 2t)(-2) = 10t - 8 = 0 \Rightarrow t = \frac{4}{5} \Rightarrow x = \frac{4}{5}$ and $y = \frac{2}{5}$ with $f(\frac{4}{5}, \frac{2}{5}) = \frac{16}{25} + \frac{4}{25} = \frac{4}{5}$. The absolute minimum is $f(\frac{4}{5}, \frac{2}{5}) = \frac{4}{5}$ when $t = \frac{4}{5}$; there is no absolute maximum along the line.

(ii) For the endpoints: $t = 0 \Rightarrow x = 0$ and $y = 2$ with $f(0, 2) = 4$; $t = 1 \Rightarrow x = 1$ and $y = 0$ with $f(1, 0) = 1$. The absolute minimum is $f(\frac{4}{5}, \frac{2}{5}) = \frac{4}{5}$ at the interior critical point when $t = \frac{4}{5}$; the absolute maximum is $f(0, 2) = 4$ at the endpoint when $t = 0$.

(b) $\frac{dg}{dt} = \frac{\partial g}{\partial x} \frac{dx}{dt} + \frac{\partial g}{\partial y} \frac{dy}{dt} = \left[\frac{-2x}{(x^2 + y^2)^2} \right] \frac{dx}{dt} + \left[\frac{-2y}{(x^2 + y^2)^2} \right] \frac{dy}{dt}$

(i) $x = t$ and $y = 2 - 2t \Rightarrow x^2 + y^2 = 5t^2 - 8t + 4 \Rightarrow \frac{dg}{dt} = -(5t^2 - 8t + 4)^{-2} [(-2t)(1) + (-2)(2 - 2t)(-2)] = -(5t^2 - 8t + 4)^{-2} (-10t + 8) = 0 \Rightarrow t = \frac{4}{5} \Rightarrow x = \frac{4}{5}$ and $y = \frac{2}{5}$ with $g(\frac{4}{5}, \frac{2}{5}) = \frac{1}{(\frac{4}{5})^2} = \frac{5}{4}$. The absolute maximum is $g(\frac{4}{5}, \frac{2}{5}) = \frac{5}{4}$ when $t = \frac{4}{5}$; there is no absolute minimum along the line since x and y can be as large as we please.

(ii) For the endpoints: $t = 0 \Rightarrow x = 0$ and $y = 2$ with $g(0, 2) = \frac{1}{4}$; $t = 1 \Rightarrow x = 1$ and $y = 0$ with $g(1, 0) = 1$. The absolute minimum is $g(0, 2) = \frac{1}{4}$ when $t = 0$; the absolute maximum is $g(\frac{4}{5}, \frac{2}{5}) = \frac{5}{4}$ when $t = \frac{4}{5}$.

57. $m = \frac{(2)(-1) - 3(-14)}{(2)^2 - 3(10)} = -\frac{20}{13}$ and

$b = \frac{1}{3} [-1 - (-\frac{20}{13})(2)] = \frac{9}{13}$
 $\Rightarrow y = -\frac{20}{13}x + \frac{9}{13}; y|_{x=4} = -\frac{71}{13}$

k	x_k	y_k	x_k^2	$x_k y_k$
1	-1	2	1	-2
2	0	1	0	0
3	3	-4	9	-12
Σ	2	-1	10	-14

58. $m = \frac{(0)(5) - 3(6)}{(0)^2 - 3(8)} = \frac{3}{4}$ and

$b = \frac{1}{3} [5 - \frac{3}{4}(0)] = \frac{5}{3}$
 $\Rightarrow y = \frac{3}{4}x + \frac{5}{3}; y|_{x=4} = \frac{14}{3}$

k	x_k	y_k	x_k^2	$x_k y_k$
1	-2	0	4	0
2	0	2	0	0
3	2	3	4	6
Σ	0	5	8	6

59. $m = \frac{(3)(5) - 3(8)}{(3)^2 - 3(5)} = \frac{3}{2}$ and
 $b = \frac{1}{3} \left[5 - \frac{3}{2}(3) \right] = \frac{1}{6}$
 $\Rightarrow y = \frac{3}{2}x + \frac{1}{6}; y|_{x=4} = \frac{37}{6}$

k	x_k	y_k	x_k^2	$x_k y_k$
1	0	0	0	0
2	1	2	1	2
3	2	3	4	6
Σ	3	5	5	8

60. $m = \frac{(5)(5) - 3(10)}{(5)^2 - 3(13)} = \frac{5}{14}$ and
 $b = \frac{1}{3} \left[5 - \frac{5}{14}(5) \right] = \frac{15}{14}$
 $\Rightarrow y = \frac{5}{14}x + \frac{15}{14}; y|_{x=4} = \frac{35}{14} = \frac{5}{2}$

k	x_k	y_k	x_k^2	$x_k y_k$
1	0	1	0	0
2	2	2	4	4
3	3	2	9	6
Σ	5	5	13	10

61. $m = \frac{(162)(41.32) - 6(1192.8)}{(162)^2 - 6(5004)} \approx 0.122$ and
 $b = \frac{1}{6} [41.32 - (0.122)(162)] \approx 3.59$
 $\Rightarrow y = 0.122x + 3.59$

k	x_k	y_k	x_k^2	$x_k y_k$
1	12	5.27	144	63.24
2	18	5.68	324	102.24
3	24	6.25	576	150
4	30	7.21	900	216.3
5	36	8.20	1296	295.2
6	42	8.71	1764	365.82
Σ	162	41.32	5004	1192.8

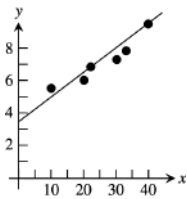

62. $m = \frac{(0.001863)(91) - 4(0.065852)}{(0.001863)^2 - 4(0.000001323)} \approx 51,545$
 and $b = \frac{1}{4} (91 - 51,545(0.001863)) \approx -1.26$
 $\Rightarrow F = 51,545 \frac{1}{D^2} - 1.26$

k	$\left(\frac{1}{D^2}\right)_k$	F_k	$\left(\frac{1}{D^2}\right)_k^2$	$\left(\frac{1}{D^2}\right)_k F_k$
1	0.001	51	0.000001	0.051
2	0.0005	22	0.00000025	0.011
3	0.00024	14	0.0000000576	0.00336
4	0.000123	4	0.0000000153	0.000492
Σ	0.001863	91	0.000001323	0.065852

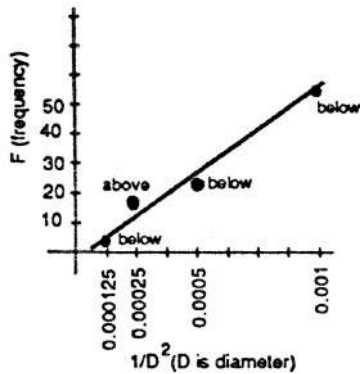

63. (b) $m = \frac{(3201)(17,785) - 10(5,710,292)}{(3201)^2 - 10(1,430,389)}$
 ≈ 0.0427 and $b = \frac{1}{10} [17,785 - (0.0427)(3201)]$
 $\approx 1764.8 \Rightarrow y = 0.0427K + 1764.8$

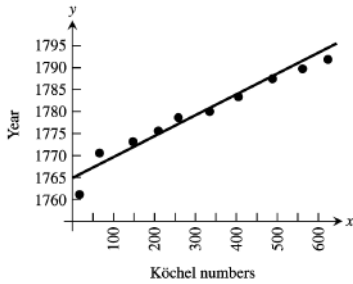

(c) $K = 364 \Rightarrow y = (0.0427)(364)$
 $\Rightarrow y = (0.0427)(364) + 1764.8 \approx 1780$

64. $m = \frac{(123)(140) - 16(1431)}{(123)^2 - 16(1287)} \approx 1.04$ and
 $b = \frac{1}{16} [140 - (1.04)(123)] \approx 0.755$
 $\Rightarrow y = 1.04x + 0.755$

k	K_k	y_k	K^2	$K_k y_k$
1	1	1761	1	1761
2	75	1771	5625	132,825
3	155	1772	24,025	274,660
4	219	1775	47,961	388,725
5	271	1777	73,441	481,567
6	351	1780	123,201	624,780
7	425	1783	180,625	757,775
8	503	1786	253,009	898,358
9	575	1789	330,625	1,028,675
10	626	1791	391,876	1,121,166
Σ	3201	17,785	1,430,389	5,710,292

k	x_k	y_k	x_k^2	$x_k y_k$
1	3	3	9	9
2	2	2	4	4
3	4	6	16	24
4	2	3	4	6
5	5	4	25	20
6	5	3	25	15
7	9	11	81	99
8	12	9	144	108
9	8	10	64	80
10	13	16	169	208
11	14	13	196	182
12	3	5	9	15
13	4	6	16	24
14	13	19	169	247
15	10	15	100	150
16	16	15	256	240
Σ	123	140	1287	1431

65-70. Example CAS commands:

Maple:

```
f := (x,y) -> x^2+y^3-3*x*y;
x0,x1 := -5,5;
y0,y1 := -5,5;
plot3d( f(x,y), x=x0..x1, y=y0..y1, axes=boxed, shading=zhue, title="#65(a) (Section 14.7)");
plot3d( f(x,y), x=x0..x1, y=y0..y1, grid=[40,40], axes=boxed, shading=zhue, style=patchcontour, title="#65(b)
(Section 14.7)");
fx := D[1](f); # (c)
fy := D[2](f);
crit_pts := solve( {fx(x,y)=0,fy(x,y)=0}, {x,y} );
fxx := D[1](fx); # (d)
fxy := D[2](fx);
fyy := D[2](fy);
discr := unapply( fxx(x,y)*fyy(x,y)-fxy(x,y)^2, (x,y) );
for CP in { crit_pts } do # (e)
    eval( [x,y,fxx(x,y),discr(x,y)], CP );
```

end do;
 # (0,0) is a saddle point
 # (9/4, 3/2) is a local minimum

Mathematica: (assigned functions and bounds will vary)

```
Clear[x,y,f]
f[x_,y_]:= x^2 + y^3 - 3x y
xmin=-5; xmax=5; ymin=-5; ymax=5;
Plot3D[f[x,y], {x, xmin, xmax}, {y, ymin, ymax}, AxesLabel -> {x, y, z}]
ContourPlot[f[x,y], {x, xmin, xmax}, {y, ymin, ymax}, ContourShading -> False, Contours -> 40]
fx= D[f[x,y], x];
fy= D[f[x,y], y];
critical=Solve[{fx==0, fy==0},{x, y}]
fxx= D[fx, x];
fxy= D[fx, y];
fyy= D[fy, y];
discriminant= fxx fyy - fxy^2
{{x, y}, f[x, y], discriminant, fxx} /.critical
```

14.8 LAGRANGE MULTIPLIERS

1. $\nabla f = y\mathbf{i} + x\mathbf{j}$ and $\nabla g = 2x\mathbf{i} + 4y\mathbf{j}$ so that $\nabla f = \lambda \nabla g \Rightarrow y\mathbf{i} + x\mathbf{j} = \lambda(2x\mathbf{i} + 4y\mathbf{j}) \Rightarrow y = 2x\lambda$ and $x = 4y\lambda$
 $\Rightarrow x = 8x\lambda^2 \Rightarrow \lambda = \pm \frac{\sqrt{2}}{4}$ or $x = 0$.

CASE 1: If $x = 0$, then $y = 0$. But $(0, 0)$ is not on the ellipse so $x \neq 0$.

CASE 2: $x \neq 0 \Rightarrow \lambda = \pm \frac{\sqrt{2}}{4} \Rightarrow x = \pm \sqrt{2}y \Rightarrow (\pm \sqrt{2}y)^2 + 2y^2 = 1 \Rightarrow y = \pm \frac{1}{2}$.

Therefore f takes on its extreme values at $(\pm \frac{\sqrt{2}}{2}, \frac{1}{2})$ and $(\pm \frac{\sqrt{2}}{2}, -\frac{1}{2})$. The extreme values of f on the ellipse are $\pm \frac{\sqrt{2}}{2}$.

2. $\nabla f = y\mathbf{i} + x\mathbf{j}$ and $\nabla g = 2x\mathbf{i} + 2y\mathbf{j}$ so that $\nabla f = \lambda \nabla g \Rightarrow y\mathbf{i} + x\mathbf{j} = \lambda(2x\mathbf{i} + 2y\mathbf{j}) \Rightarrow y = 2x\lambda$ and $x = 2y\lambda$
 $\Rightarrow x = 4x\lambda^2 \Rightarrow x = 0$ or $\lambda = \pm \frac{1}{2}$.

CASE 1: If $x = 0$, then $y = 0$. But $(0, 0)$ is not on the circle $x^2 + y^2 - 10 = 0$ so $x \neq 0$.

CASE 2: $x \neq 0 \Rightarrow \lambda = \pm \frac{1}{2} \Rightarrow y = 2x(\pm \frac{1}{2}) = \pm x \Rightarrow x^2 + (\pm x)^2 - 10 = 0 \Rightarrow x = \pm \sqrt{5} \Rightarrow y = \pm \sqrt{5}$.

Therefore f takes on its extreme values at $(\pm \sqrt{5}, \sqrt{5})$ and $(\pm \sqrt{5}, -\sqrt{5})$. The extreme values of f on the circle are 5 and -5.

3. $\nabla f = -2x\mathbf{i} - 2y\mathbf{j}$ and $\nabla g = \mathbf{i} + 3\mathbf{j}$ so that $\nabla f = \lambda \nabla g \Rightarrow -2x\mathbf{i} - 2y\mathbf{j} = \lambda(\mathbf{i} + 3\mathbf{j}) \Rightarrow x = -\frac{\lambda}{2}$ and $y = -\frac{3\lambda}{2}$
 $\Rightarrow (-\frac{\lambda}{2}) + 3(-\frac{3\lambda}{2}) = 10 \Rightarrow \lambda = -2 \Rightarrow x = 1$ and $y = 3 \Rightarrow f$ takes on its extreme value at $(1, 3)$ on the line.

The extreme value is $f(1, 3) = 49 - 1 - 9 = 39$.

4. $\nabla f = 2xy\mathbf{i} + x^2\mathbf{j}$ and $\nabla g = \mathbf{i} + \mathbf{j}$ so that $\nabla f = \lambda \nabla g \Rightarrow 2xy\mathbf{i} + x^2\mathbf{j} = \lambda(\mathbf{i} + \mathbf{j}) \Rightarrow 2xy = \lambda$ and $x^2 = \lambda$
 $\Rightarrow 2xy = x^2 \Rightarrow x = 0$ or $2y = x$.

CASE 1: If $x = 0$, then $x + y = 3 \Rightarrow y = 3$.

CASE 2: If $x \neq 0$, then $2y = x$ so that $x + y = 3 \Rightarrow 2y + y = 3 \Rightarrow y = 1 \Rightarrow x = 2$.

Therefore f takes on its extreme values at $(0, 3)$ and $(2, 1)$. The extreme values of f are $f(0, 3) = 0$ and $f(2, 1) = 4$.

5. We optimize $f(x, y) = x^2 + y^2$, the square of the distance to the origin, subject to the constraint $g(x, y) = xy^2 - 54 = 0$. Thus $\nabla f = 2x\mathbf{i} + 2y\mathbf{j}$ and $\nabla g = y^2\mathbf{i} + 2xy\mathbf{j}$ so that $\nabla f = \lambda \nabla g \Rightarrow 2x\mathbf{i} + 2y\mathbf{j} = \lambda(y^2\mathbf{i} + 2xy\mathbf{j}) \Rightarrow 2x = \lambda y^2$ and $2y = 2\lambda xy$.
 CASE 1: If $y = 0$, then $x = 0$. But $(0, 0)$ does not satisfy the constraint $xy^2 = 54$ so $y \neq 0$.
 CASE 2: If $y \neq 0$, then $2 = 2\lambda x \Rightarrow x = \frac{1}{\lambda} \Rightarrow 2\left(\frac{1}{\lambda}\right) = \lambda y^2 \Rightarrow y^2 = \frac{2}{\lambda^2}$. Then $xy^2 = 54 \Rightarrow \left(\frac{1}{\lambda}\right)\left(\frac{2}{\lambda^2}\right) = 54 \Rightarrow \lambda^3 = \frac{1}{27} \Rightarrow \lambda = \frac{1}{3} \Rightarrow x = 3$ and $y^2 = 18 \Rightarrow x = 3$ and $y = \pm 3\sqrt{2}$.
 Therefore $(3, \pm 3\sqrt{2})$ are the points on the curve $xy^2 = 54$ nearest the origin (since $xy^2 = 54$ has points increasingly far away as y gets close to 0, no points are farthest away).
6. We optimize $f(x, y) = x^2 + y^2$, the square of the distance to the origin subject to the constraint $g(x, y) = x^2y - 2 = 0$. Thus $\nabla f = 2x\mathbf{i} + 2y\mathbf{j}$ and $\nabla g = 2xy\mathbf{i} + x^2\mathbf{j}$ so that $\nabla f = \lambda \nabla g \Rightarrow 2x = 2xy\lambda$ and $2y = x^2\lambda \Rightarrow \lambda = \frac{2y}{x^2}$, since $x = 0 \Rightarrow y = 0$ (but $g(0, 0) \neq 0$). Thus $x \neq 0$ and $2x = 2xy\left(\frac{2y}{x^2}\right) \Rightarrow x^2 = 2y^2 \Rightarrow (2y^2)y - 2 = 0 \Rightarrow y = 1$ (since $y > 0$) $\Rightarrow x = \pm\sqrt{2}$. Therefore $(\pm\sqrt{2}, 1)$ are the points on the curve $x^2y = 2$ nearest the origin (since $x^2y = 2$ has points increasingly far away as x gets close to 0, no points are farthest away).
7. (a) $\nabla f = \mathbf{i} + \mathbf{j}$ and $\nabla g = y\mathbf{i} + x\mathbf{j}$ so that $\nabla f = \lambda \nabla g \Rightarrow \mathbf{i} + \mathbf{j} = \lambda(y\mathbf{i} + x\mathbf{j}) \Rightarrow 1 = \lambda y$ and $1 = \lambda x \Rightarrow y = \frac{1}{\lambda}$ and $x = \frac{1}{\lambda} \Rightarrow \frac{1}{\lambda^2} = 16 \Rightarrow \lambda = \pm\frac{1}{4}$. Use $\lambda = \frac{1}{4}$ since $x > 0$ and $y > 0$. Then $x = 4$ and $y = 4 \Rightarrow$ the minimum value is 8 at the point $(4, 4)$. Now, $xy = 16$, $x > 0$, $y > 0$ is a branch of a hyperbola in the first quadrant with the x - and y -axes as asymptotes. The equations $x + y = c$ give a family of parallel lines with $m = -1$. As these lines move away from the origin, the number c increases. Thus the minimum value of c occurs where $x + y = c$ is tangent to the hyperbola's branch.
 (b) $\nabla f = y\mathbf{i} + x\mathbf{j}$ and $\nabla g = \mathbf{i} + \mathbf{j}$ so that $\nabla f = \lambda \nabla g \Rightarrow y\mathbf{i} + x\mathbf{j} = \lambda(\mathbf{i} + \mathbf{j}) \Rightarrow y = \lambda = x$ $y + y = 16 \Rightarrow y = 8 \Rightarrow x = 8 \Rightarrow f(8, 8) = 64$ is the maximum value. The equations $xy = c$ ($x > 0$ and $y > 0$ or $x < 0$ and $y < 0$ to get a maximum value) give a family of hyperbolas in the first and third quadrants with the x - and y -axes as asymptotes. The maximum value of c occurs where the hyperbola $xy = c$ is tangent to the line $x + y = 16$.
8. Let $f(x, y) = x^2 + y^2$ be the square of the distance from the origin. Then $\nabla f = 2x\mathbf{i} + 2y\mathbf{j}$ and $\nabla g = (2x + y)\mathbf{i} + (2y + x)\mathbf{j}$ so that $\nabla f = \lambda \nabla g \Rightarrow 2x = \lambda(2x + y)$ and $2y = \lambda(2y + x) \Rightarrow \frac{2y}{2y+x} = \lambda \Rightarrow 2x = \left(\frac{2y}{2y+x}\right)(2x + y) \Rightarrow x(2y + x) = y(2x + y) \Rightarrow x^2 = y^2 \Rightarrow y = \pm x$.
 CASE 1: $y = x \Rightarrow x^2 + x(x) + x^2 - 1 = 0 \Rightarrow x = \pm\frac{1}{\sqrt{3}}$ and $y = x$.
 CASE 2: $y = -x \Rightarrow x^2 + x(-x) + (-x)^2 - 1 = 0 \Rightarrow x = \pm 1$ and $y = -x$. Thus $f\left(\frac{1}{\sqrt{3}}, \frac{1}{\sqrt{3}}\right) = \frac{2}{3} = f\left(-\frac{1}{\sqrt{3}}, -\frac{1}{\sqrt{3}}\right)$ and $f(1, -1) = 2 = f(-1, 1)$.
 Therefore the points $(1, -1)$ and $(-1, 1)$ are the farthest away; $\left(\frac{1}{\sqrt{3}}, \frac{1}{\sqrt{3}}\right)$ and $\left(-\frac{1}{\sqrt{3}}, -\frac{1}{\sqrt{3}}\right)$ are the closest points to the origin.
9. $V = \pi r^2 h \Rightarrow 16\pi = \pi r^2 h \Rightarrow 16 = r^2 h \Rightarrow g(r, h) = r^2 h - 16$; $S = 2\pi r h + 2\pi r^2 \Rightarrow \nabla S = (2\pi h + 4\pi r)\mathbf{i} + 2\pi r\mathbf{j}$ and $\nabla g = 2r h\mathbf{i} + r^2\mathbf{j}$ so that $\nabla S = \lambda \nabla g \Rightarrow (2\pi h + 4\pi r)\mathbf{i} + 2\pi r\mathbf{j} = \lambda(2r h\mathbf{i} + r^2\mathbf{j}) \Rightarrow 2\pi h + 4\pi r = 2r h\lambda$ and $2\pi r = \lambda r^2 \Rightarrow r = 0$ or $\lambda = \frac{2\pi}{r}$. But $r = 0$ gives no physical can, so $r \neq 0 \Rightarrow \lambda = \frac{2\pi}{r} \Rightarrow 2\pi h + 4\pi r = 2r h\left(\frac{2\pi}{r}\right) \Rightarrow 2r = h \Rightarrow 16 = r^2(2r) \Rightarrow r = 2 \Rightarrow h = 4$; thus $r = 2$ cm and $h = 4$ cm give the only extreme surface area of 24π cm². Since $r = 4$ cm and $h = 1$ cm $\Rightarrow V = 16\pi$ cm³ and $S = 40\pi$ cm², which is a larger surface area, then 24π cm² must be the minimum surface area.

10. For a cylinder of radius r and height h we want to maximize the surface area $S = 2\pi rh$ subject to the constraint $g(r, h) = r^2 + \left(\frac{h}{2}\right)^2 - a^2 = 0$. Thus $\nabla S = 2\pi h\mathbf{i} + 2\pi r\mathbf{j}$ and $\nabla g = 2r\mathbf{i} + \frac{h}{2}\mathbf{j}$ so that $\nabla S = \lambda \nabla g \Rightarrow 2\pi h = 2\lambda r$ and $2\pi r = \frac{\lambda h}{2} \Rightarrow \frac{\pi h}{r} = \lambda$ and $2\pi r = \left(\frac{\pi h}{r}\right)\left(\frac{h}{2}\right) \Rightarrow 4r^2 = h^2 \Rightarrow h = 2r \Rightarrow r^2 + \frac{4r^2}{4} = a^2 \Rightarrow 2r^2 = a^2 \Rightarrow r = \frac{a}{\sqrt{2}} \Rightarrow h = a\sqrt{2} \Rightarrow S = 2\pi\left(\frac{a}{\sqrt{2}}\right)\left(a\sqrt{2}\right) = 2\pi a^2$.
11. $A = (2x)(2y) = 4xy$ subject to $g(x, y) = \frac{x^2}{16} + \frac{y^2}{9} - 1 = 0$; $\nabla A = 4y\mathbf{i} + 4x\mathbf{j}$ and $\nabla g = \frac{x}{8}\mathbf{i} + \frac{2y}{9}\mathbf{j}$ so that $\nabla A = \lambda \nabla g \Rightarrow 4y\mathbf{i} + 4x\mathbf{j} = \lambda\left(\frac{x}{8}\mathbf{i} + \frac{2y}{9}\mathbf{j}\right) \Rightarrow 4y = \left(\frac{x}{8}\right)\lambda$ and $4x = \left(\frac{2y}{9}\right)\lambda \Rightarrow \lambda = \frac{32y}{x}$ and $4x = \left(\frac{2y}{9}\right)\left(\frac{32y}{x}\right) \Rightarrow y = \pm \frac{3}{4}x \Rightarrow \frac{x^2}{16} + \frac{\left(\pm\frac{3}{4}x\right)^2}{9} = 1 \Rightarrow x^2 = 8 \Rightarrow x = \pm 2\sqrt{2}$. We use $x = 2\sqrt{2}$ since x represents distance. Then $y = \frac{3}{4}\left(2\sqrt{2}\right) = \frac{3\sqrt{2}}{2}$, so the length is $2x = 4\sqrt{2}$ and the width is $2y = 3\sqrt{2}$.
12. $P = 4x + 4y$ subject to $g(x, y) = \frac{x^2}{a^2} + \frac{y^2}{b^2} - 1 = 0$; $\nabla P = 4\mathbf{i} + 4\mathbf{j}$ and $\nabla g = \frac{2x}{a^2}\mathbf{i} + \frac{2y}{b^2}\mathbf{j}$ so that $\nabla P = \lambda \nabla g \Rightarrow 4 = \left(\frac{2x}{a^2}\right)\lambda$ and $4 = \left(\frac{2y}{b^2}\right)\lambda \Rightarrow \lambda = \frac{2a^2}{x}$ and $4 = \left(\frac{2y}{b^2}\right)\left(\frac{2a^2}{x}\right) \Rightarrow y = \left(\frac{b^2}{a^2}\right)x \Rightarrow \frac{x^2}{a^2} + \frac{\left(\frac{b^2}{a^2}\right)^2 x^2}{b^2} = 1 \Rightarrow \frac{x^2}{a^2} + \frac{b^2 x^2}{a^4} = 1 \Rightarrow (a^2 + b^2)x^2 = a^4 \Rightarrow x = \frac{a^2}{\sqrt{a^2 + b^2}}$, since $x > 0 \Rightarrow y = \left(\frac{b^2}{a^2}\right)x = \frac{b^2}{\sqrt{a^2 + b^2}} \Rightarrow \text{width} = 2x = \frac{2a^2}{\sqrt{a^2 + b^2}}$ and height $= 2y = \frac{2b^2}{\sqrt{a^2 + b^2}} \Rightarrow \text{perimeter is } P = 4x + 4y = \frac{4a^2 + 4b^2}{\sqrt{a^2 + b^2}} = 4\sqrt{a^2 + b^2}$
13. $\nabla f = 2x\mathbf{i} + 2y\mathbf{j}$ and $\nabla g = (2x - 2)\mathbf{i} + (2y - 4)\mathbf{j}$ so that $\nabla f = \lambda \nabla g = 2x\mathbf{i} + 2y\mathbf{j} = \lambda[(2x - 2)\mathbf{i} + (2y - 4)\mathbf{j}] \Rightarrow 2x = \lambda(2x - 2)$ and $2y = \lambda(2y - 4) \Rightarrow x = \frac{\lambda}{\lambda - 1}$ and $y = \frac{2\lambda}{\lambda - 1}$, $\lambda \neq 1 \Rightarrow y = 2x \Rightarrow x^2 - 2x + (2x)^2 - 4(2x) = 0 \Rightarrow x = 0$ and $y = 0$, or $x = 2$ and $y = 4$. Therefore $f(0, 0) = 0$ is the minimum value and $f(2, 4) = 20$ is the maximum value. (Note that $\lambda = 1$ gives $2x = 2x - 2$ or $0 = -2$, which is impossible.)
14. $\nabla f = 3\mathbf{i} - \mathbf{j}$ and $\nabla g = 2x\mathbf{i} + 2y\mathbf{j}$ so that $\nabla f = \lambda \nabla g \Rightarrow 3 = 2\lambda x$ and $-1 = 2\lambda y \Rightarrow \lambda = \frac{3}{2x}$ and $-1 = 2\left(\frac{3}{2x}\right)y \Rightarrow y = -\frac{x}{3} \Rightarrow x^2 + \left(-\frac{x}{3}\right)^2 = 4 \Rightarrow 10x^2 = 36 \Rightarrow x = \pm \frac{6}{\sqrt{10}} \Rightarrow x = \frac{6}{\sqrt{10}}$ and $y = -\frac{2}{\sqrt{10}}$, or $x = -\frac{6}{\sqrt{10}}$ and $y = \frac{2}{\sqrt{10}}$. Therefore $f\left(\frac{6}{\sqrt{10}}, -\frac{2}{\sqrt{10}}\right) = \frac{20}{\sqrt{10}} + 6 = 2\sqrt{10} + 6 \approx 12.325$ is the maximum value, and $f\left(-\frac{6}{\sqrt{10}}, \frac{2}{\sqrt{10}}\right) = -2\sqrt{10} + 6 \approx -0.325$ is the minimum value.
15. $\nabla T = (8x - 4y)\mathbf{i} + (-4x + 2y)\mathbf{j}$ and $g(x, y) = x^2 + y^2 - 25 = 0 \Rightarrow \nabla g = 2x\mathbf{i} + 2y\mathbf{j}$ so that $\nabla T = \lambda \nabla g \Rightarrow (8x - 4y)\mathbf{i} + (-4x + 2y)\mathbf{j} = \lambda(2x\mathbf{i} + 2y\mathbf{j}) \Rightarrow 8x - 4y = 2\lambda x$ and $-4x + 2y = 2\lambda y \Rightarrow y = \frac{-2x}{\lambda - 1}$, $\lambda \neq 1 \Rightarrow 8x - 4\left(\frac{-2x}{\lambda - 1}\right) = 2\lambda x \Rightarrow x = 0$, or $\lambda = 0$, or $\lambda = 5$.
- CASE 1: $x = 0 \Rightarrow y = 0$; but $(0, 0)$ is not on $x^2 + y^2 = 25$ so $x \neq 0$.
- CASE 2: $\lambda = 0 \Rightarrow y = 2x \Rightarrow x^2 + (2x)^2 = 25 \Rightarrow x = \pm\sqrt{5}$ and $y = 2x$.
- CASE 3: $\lambda = 5 \Rightarrow y = \frac{-2x}{4} = -\frac{x}{2} \Rightarrow x^2 + \left(-\frac{x}{2}\right)^2 = 25 \Rightarrow x = \pm 2\sqrt{5} \Rightarrow x = 2\sqrt{5}$ and $y = -\sqrt{5}$, or $x = -2\sqrt{5}$ and $y = \sqrt{5}$.
- Therefore $T\left(\sqrt{5}, 2\sqrt{5}\right) = 0^\circ = T\left(-\sqrt{5}, -2\sqrt{5}\right)$ is the minimum value and $T\left(2\sqrt{5}, -\sqrt{5}\right) = 125^\circ = T\left(-2\sqrt{5}, \sqrt{5}\right)$ is the maximum value. (Note: $\lambda = 1 \Rightarrow x = 0$ from the equation $-4x + 2y = 2\lambda y$; but we found $x \neq 0$ in CASE 1.)
16. The surface area is given by $S = 4\pi r^2 + 2\pi rh$ subject to the constraint $V(r, h) = \frac{4}{3}\pi r^3 + \pi r^2 h = 8000$. Thus $\nabla S = (8\pi r + 2\pi h)\mathbf{i} + 2\pi r\mathbf{j}$ and $\nabla V = (4\pi r^2 + 2\pi rh)\mathbf{i} + \pi r^2\mathbf{j}$ so that $\nabla S = \lambda \nabla V = (8\pi r + 2\pi h)\mathbf{i} + 2\pi r\mathbf{j} = \lambda[(4\pi r^2 + 2\pi rh)\mathbf{i} + \pi r^2\mathbf{j}] \Rightarrow 8\pi r + 2\pi h = \lambda(4\pi r^2 + 2\pi rh)$ and $2\pi r = \lambda\pi r^2 \Rightarrow r = 0$ or $2 = r\lambda$. But $r \neq 0$ so $2 = r\lambda \Rightarrow \lambda = \frac{2}{r} \Rightarrow 4r + h = \frac{2}{r}(2r^2 + rh) \Rightarrow h = 0 \Rightarrow$ the tank is a sphere (there is no cylindrical part) and $\frac{4}{3}\pi r^3 = 8000 \Rightarrow r = 10\left(\frac{6}{\pi}\right)^{1/3}$.

17. Let $f(x, y, z) = (x - 1)^2 + (y - 1)^2 + (z - 1)^2$ be the square of the distance from $(1, 1, 1)$. Then $\nabla f = 2(x - 1)\mathbf{i} + 2(y - 1)\mathbf{j} + 2(z - 1)\mathbf{k}$ and $\nabla g = \mathbf{i} + 2\mathbf{j} + 3\mathbf{k}$ so that $\nabla f = \lambda \nabla g$
 $\Rightarrow 2(x - 1)\mathbf{i} + 2(y - 1)\mathbf{j} + 2(z - 1)\mathbf{k} = \lambda(\mathbf{i} + 2\mathbf{j} + 3\mathbf{k}) \Rightarrow 2(x - 1) = \lambda, 2(y - 1) = 2\lambda, 2(z - 1) = 3\lambda$
 $\Rightarrow 2(y - 1) = 2[2(x - 1)]$ and $2(z - 1) = 3[2(x - 1)] \Rightarrow x = \frac{y+1}{2} \Rightarrow z + 2 = 3\left(\frac{y+1}{2}\right)$ or $z = \frac{3y-1}{2}$; thus
 $\frac{y+1}{2} + 2y + 3\left(\frac{3y-1}{2}\right) - 13 = 0 \Rightarrow y = 2 \Rightarrow x = \frac{3}{2}$ and $z = \frac{5}{2}$. Therefore the point $\left(\frac{3}{2}, 2, \frac{5}{2}\right)$ is closest (since no point on the plane is farthest from the point $(1, 1, 1)$).
18. Let $f(x, y, z) = (x - 1)^2 + (y + 1)^2 + (z - 1)^2$ be the square of the distance from $(1, -1, 1)$. Then $\nabla f = 2(x - 1)\mathbf{i} + 2(y + 1)\mathbf{j} + 2(z - 1)\mathbf{k}$ and $\nabla g = 2x\mathbf{i} + 2y\mathbf{j} + 2z\mathbf{k}$ so that $\nabla f = \lambda \nabla g \Rightarrow x - 1 = \lambda x, y + 1 = \lambda y$ and $z - 1 = \lambda z \Rightarrow x = \frac{1}{1-\lambda}, y = -\frac{1}{1-\lambda}$, and $z = \frac{1}{1-\lambda}$ for $\lambda \neq 1 \Rightarrow \left(\frac{1}{1-\lambda}\right)^2 + \left(\frac{-1}{1-\lambda}\right)^2 + \left(\frac{1}{1-\lambda}\right)^2 = 4$
 $\Rightarrow \frac{1}{1-\lambda} = \pm \frac{2}{\sqrt{3}} \Rightarrow x = \frac{2}{\sqrt{3}}, y = -\frac{2}{\sqrt{3}}, z = \frac{2}{\sqrt{3}}$ or $x = -\frac{2}{\sqrt{3}}, y = \frac{2}{\sqrt{3}}, z = -\frac{2}{\sqrt{3}}$. The largest value of f occurs where $x < 0, y > 0$, and $z < 0$ or at the point $\left(-\frac{2}{\sqrt{3}}, \frac{2}{\sqrt{3}}, -\frac{2}{\sqrt{3}}\right)$ on the sphere.
19. Let $f(x, y, z) = x^2 + y^2 + z^2$ be the square of the distance from the origin. Then $\nabla f = 2x\mathbf{i} + 2y\mathbf{j} + 2z\mathbf{k}$ and $\nabla g = 2x\mathbf{i} - 2y\mathbf{j} - 2z\mathbf{k}$ so that $\nabla f = \lambda \nabla g \Rightarrow 2x\mathbf{i} + 2y\mathbf{j} + 2z\mathbf{k} = \lambda(2x\mathbf{i} - 2y\mathbf{j} - 2z\mathbf{k}) \Rightarrow 2x = 2x\lambda, 2y = -2y\lambda$, and $2z = -2z\lambda \Rightarrow x = 0$ or $\lambda = 1$.
CASE 1: $\lambda = 1 \Rightarrow 2y = -2y \Rightarrow y = 0; 2z = -2z \Rightarrow z = 0 \Rightarrow x^2 - 1 = 0 \Rightarrow x = \pm 1$ and $y = z = 0$.
CASE 2: $x = 0 \Rightarrow -y^2 - z^2 = 1$, which has no solution.
Therefore the points on the unit circle $x^2 + y^2 = 1$, are the points on the surface $x^2 + y^2 - z^2 = 1$ closest to the origin. The minimum distance is 1.
20. Let $f(x, y, z) = x^2 + y^2 + z^2$ be the square of the distance to the origin. Then $\nabla f = 2x\mathbf{i} + 2y\mathbf{j} + 2z\mathbf{k}$ and $\nabla g = y\mathbf{i} + x\mathbf{j} - \mathbf{k}$ so that $\nabla f = \lambda \nabla g \Rightarrow 2x\mathbf{i} + 2y\mathbf{j} + 2z\mathbf{k} = \lambda(y\mathbf{i} + x\mathbf{j} - \mathbf{k}) \Rightarrow 2x = \lambda y, 2y = \lambda x$, and $2z = -\lambda$
 $\Rightarrow x = \frac{\lambda y}{2} \Rightarrow 2y = \lambda\left(\frac{\lambda y}{2}\right) \Rightarrow y = 0$ or $\lambda = \pm 2$.
CASE 1: $y = 0 \Rightarrow x = 0 \Rightarrow -z + 1 = 0 \Rightarrow z = 1$.
CASE 2: $\lambda = 2 \Rightarrow x = y$ and $z = -1 \Rightarrow x^2 - (-1) + 1 = 0 \Rightarrow x^2 + 2 = 0$, so no solution.
CASE 3: $\lambda = -2 \Rightarrow x = -y$ and $z = 1 \Rightarrow (-y)y - 1 + 1 = 0 \Rightarrow y = 0$, again.
Therefore $(0, 0, 1)$ is the point on the surface closest to the origin since this point gives the only extreme value and there is no maximum distance from the surface to the origin.
21. Let $f(x, y, z) = x^2 + y^2 + z^2$ be the square of the distance to the origin. Then $\nabla f = 2x\mathbf{i} + 2y\mathbf{j} + 2z\mathbf{k}$ and $\nabla g = -y\mathbf{i} - x\mathbf{j} + 2z\mathbf{k}$ so that $\nabla f = \lambda \nabla g \Rightarrow 2x\mathbf{i} + 2y\mathbf{j} + 2z\mathbf{k} = \lambda(-y\mathbf{i} - x\mathbf{j} + 2z\mathbf{k}) \Rightarrow 2x = -y\lambda, 2y = -x\lambda$, and $2z = 2z\lambda \Rightarrow \lambda = 1$ or $z = 0$.
CASE 1: $\lambda = 1 \Rightarrow 2x = -y$ and $2y = -x \Rightarrow y = 0$ and $x = 0 \Rightarrow z^2 - 4 = 0 \Rightarrow z = \pm 2$ and $x = y = 0$.
CASE 2: $z = 0 \Rightarrow -xy - 4 = 0 \Rightarrow y = -\frac{4}{x}$. Then $2x = \frac{4}{x}\lambda \Rightarrow \lambda = \frac{x^2}{2}$, and $-\frac{8}{x} = -x\lambda \Rightarrow -\frac{8}{x} = -x\left(\frac{x^2}{2}\right)$
 $\Rightarrow x^4 = 16 \Rightarrow x = \pm 2$. Thus, $x = 2$ and $y = -2$, or $x = -2$ and $y = 2$.
Therefore we get four points: $(2, -2, 0), (-2, 2, 0), (0, 0, 2)$ and $(0, 0, -2)$. But the points $(0, 0, 2)$ and $(0, 0, -2)$ are closest to the origin since they are 2 units away and the others are $2\sqrt{2}$ units away.
22. Let $f(x, y, z) = x^2 + y^2 + z^2$ be the square of the distance to the origin. Then $\nabla f = 2x\mathbf{i} + 2y\mathbf{j} + 2z\mathbf{k}$ and $\nabla g = yz\mathbf{i} + xz\mathbf{j} + xy\mathbf{k}$ so that $\nabla f = \lambda \nabla g \Rightarrow 2x = \lambda yz, 2y = \lambda xz$, and $2z = \lambda xy \Rightarrow 2x^2 = \lambda xyz$ and $2y^2 = \lambda yxz$
 $\Rightarrow x^2 = y^2 \Rightarrow y = \pm x \Rightarrow z = \pm x \Rightarrow x(\pm x)(\pm x) = 1 \Rightarrow x = \pm 1 \Rightarrow$ the points are $(1, 1, 1), (1, -1, -1), (-1, -1, 1)$, and $(-1, 1, -1)$.
23. $\nabla f = \mathbf{i} - 2\mathbf{j} + 5\mathbf{k}$ and $\nabla g = 2x\mathbf{i} + 2y\mathbf{j} + 2z\mathbf{k}$ so that $\nabla f = \lambda \nabla g \Rightarrow \mathbf{i} - 2\mathbf{j} + 5\mathbf{k} = \lambda(2x\mathbf{i} + 2y\mathbf{j} + 2z\mathbf{k}) \Rightarrow 1 = 2x\lambda$, $-2 = 2y\lambda$, and $5 = 2z\lambda \Rightarrow x = \frac{1}{2\lambda}, y = -\frac{1}{\lambda} = -2x$, and $z = \frac{5}{2\lambda} = 5x \Rightarrow x^2 + (-2x)^2 + (5x)^2 = 30 \Rightarrow x = \pm 1$.

Thus, $x = 1, y = -2, z = 5$ or $x = -1, y = 2, z = -5$. Therefore $f(1, -2, 5) = 30$ is the maximum value and $f(-1, 2, -5) = -30$ is the minimum value.

24. $\nabla f = \mathbf{i} + 2\mathbf{j} + 3\mathbf{k}$ and $\nabla g = 2x\mathbf{i} + 2y\mathbf{j} + 2z\mathbf{k}$ so that $\nabla f = \lambda \nabla g \Rightarrow \mathbf{i} + 2\mathbf{j} + 3\mathbf{k} = \lambda(2x\mathbf{i} + 2y\mathbf{j} + 2z\mathbf{k}) \Rightarrow 1 = 2x\lambda, 2 = 2y\lambda,$ and $3 = 2z\lambda \Rightarrow x = \frac{1}{2\lambda}, y = \frac{1}{\lambda} = 2x,$ and $z = \frac{3}{2\lambda} = 3x \Rightarrow x^2 + (2x)^2 + (3x)^2 = 25 \Rightarrow x = \pm \frac{5}{\sqrt{14}}.$

Thus, $x = \frac{5}{\sqrt{14}}, y = \frac{10}{\sqrt{14}}, z = \frac{15}{\sqrt{14}}$ or $x = -\frac{5}{\sqrt{14}}, y = -\frac{10}{\sqrt{14}}, z = -\frac{15}{\sqrt{14}}.$ Therefore $f\left(\frac{5}{\sqrt{14}}, \frac{10}{\sqrt{14}}, \frac{15}{\sqrt{14}}\right) = 5\sqrt{14}$ is the maximum value and $f\left(-\frac{5}{\sqrt{14}}, -\frac{10}{\sqrt{14}}, -\frac{15}{\sqrt{14}}\right) = -5\sqrt{14}$ is the minimum value.

25. $f(x, y, z) = x^2 + y^2 + z^2$ and $g(x, y, z) = x + y + z - 9 = 0 \Rightarrow \nabla f = 2x\mathbf{i} + 2y\mathbf{j} + 2z\mathbf{k}$ and $\nabla g = \mathbf{i} + \mathbf{j} + \mathbf{k}$ so that $\nabla f = \lambda \nabla g \Rightarrow 2x\mathbf{i} + 2y\mathbf{j} + 2z\mathbf{k} = \lambda(\mathbf{i} + \mathbf{j} + \mathbf{k}) \Rightarrow 2x = \lambda, 2y = \lambda,$ and $2z = \lambda \Rightarrow x = y = z \Rightarrow x + x + x - 9 = 0 \Rightarrow x = 3, y = 3,$ and $z = 3.$

26. $f(x, y, z) = xyz$ and $g(x, y, z) = x + y + z^2 - 16 = 0 \Rightarrow \nabla f = yz\mathbf{i} + xz\mathbf{j} + xy\mathbf{k}$ and $\nabla g = \mathbf{i} + \mathbf{j} + 2z\mathbf{k}$ so that $\nabla f = \lambda \nabla g \Rightarrow yz\mathbf{i} + xz\mathbf{j} + xy\mathbf{k} = \lambda(\mathbf{i} + \mathbf{j} + 2z\mathbf{k}) \Rightarrow yz = \lambda, xz = \lambda,$ and $xy = 2z\lambda \Rightarrow yz = xz \Rightarrow z = 0$ or $y = x.$ But $z > 0$ so that $y = x \Rightarrow x^2 = 2z\lambda$ and $xz = \lambda.$ Then $x^2 = 2z(xz) \Rightarrow x = 0$ or $x = 2z^2.$ But $x > 0$ so that $x = 2z^2 \Rightarrow y = 2z^2 \Rightarrow 2z^2 + 2z^2 + z^2 = 16 \Rightarrow z = \pm \frac{4}{\sqrt{5}}.$ We use $z = \frac{4}{\sqrt{5}}$ since $z > 0.$ Then $x = \frac{32}{5}$ and $y = \frac{32}{5}$ which yields $f\left(\frac{32}{5}, \frac{32}{5}, \frac{4}{\sqrt{5}}\right) = \frac{4096}{25\sqrt{5}}.$

27. $V = 6xyz$ and $g(x, y, z) = x^2 + y^2 + z^2 - 1 = 0 \Rightarrow \nabla V = 6yz\mathbf{i} + 6xz\mathbf{j} + 6xy\mathbf{k}$ and $\nabla g = 2x\mathbf{i} + 2y\mathbf{j} + 2z\mathbf{k}$ so that $\nabla V = \lambda \nabla g \Rightarrow 3yz = \lambda x, 3xz = \lambda y,$ and $3xy = \lambda z \Rightarrow 3xyz = \lambda x^2$ and $3xyz = \lambda y^2 \Rightarrow y = \pm x \Rightarrow z = \pm x \Rightarrow x^2 + x^2 + x^2 = 1 \Rightarrow x = \frac{1}{\sqrt{3}}$ since $x > 0 \Rightarrow$ the dimensions of the box are $\frac{2}{\sqrt{3}}$ by $\frac{2}{\sqrt{3}}$ by $\frac{2}{\sqrt{3}}$ for maximum volume. (Note that there is no minimum volume since the box could be made arbitrarily thin.)

28. $V = xyz$ with x, y, z all positive and $\frac{x}{a} + \frac{y}{b} + \frac{z}{c} = 1;$ thus $V = xyz$ and $g(x, y, z) = bcx + acy + abz - abc = 0 \Rightarrow \nabla V = yz\mathbf{i} + xz\mathbf{j} + xy\mathbf{k}$ and $\nabla g = bc\mathbf{i} + ac\mathbf{j} + ab\mathbf{k}$ so that $\nabla V = \lambda \nabla g \Rightarrow yz = \lambda bc, xz = \lambda ac,$ and $xy = \lambda ab \Rightarrow xyz = \lambda bcx, xyz = \lambda acy,$ and $xyz = \lambda abz \Rightarrow \lambda \neq 0.$ Also, $\lambda bcx = \lambda acy = \lambda abz \Rightarrow bx = ay, cy = bz,$ and $cx = az \Rightarrow y = \frac{b}{a}x$ and $z = \frac{c}{a}x.$ Then $\frac{x}{a} + \frac{y}{b} + \frac{z}{c} = 1 \Rightarrow \frac{x}{a} + \frac{1}{b}\left(\frac{b}{a}x\right) + \frac{1}{c}\left(\frac{c}{a}x\right) = 1 \Rightarrow \frac{3x}{a} = 1 \Rightarrow x = \frac{a}{3} \Rightarrow y = \left(\frac{b}{a}\right)\left(\frac{a}{3}\right) = \frac{b}{3}$ and $z = \left(\frac{c}{a}\right)\left(\frac{a}{3}\right) = \frac{c}{3} \Rightarrow V = xyz = \left(\frac{a}{3}\right)\left(\frac{b}{3}\right)\left(\frac{c}{3}\right) = \frac{abc}{27}$ is the maximum volume. (Note that there is no minimum volume since the box could be made arbitrarily thin.)

29. $\nabla T = 16x\mathbf{i} + 4z\mathbf{j} + (4y - 16)\mathbf{k}$ and $\nabla g = 8x\mathbf{i} + 2y\mathbf{j} + 8z\mathbf{k}$ so that $\nabla T = \lambda \nabla g \Rightarrow 16x\mathbf{i} + 4z\mathbf{j} + (4y - 16)\mathbf{k} = \lambda(8x\mathbf{i} + 2y\mathbf{j} + 8z\mathbf{k}) \Rightarrow 16x = 8x\lambda, 4z = 2y\lambda,$ and $4y - 16 = 8z\lambda \Rightarrow \lambda = 2$ or $x = 0.$

CASE 1: $\lambda = 2 \Rightarrow 4z = 2y(2) \Rightarrow z = y.$ Then $4z - 16 = 16z \Rightarrow z = -\frac{4}{3} \Rightarrow y = -\frac{4}{3}.$ Then

$$4x^2 + \left(-\frac{4}{3}\right)^2 + 4\left(-\frac{4}{3}\right)^2 = 16 \Rightarrow x = \pm \frac{4}{3}.$$

CASE 2: $x = 0 \Rightarrow \lambda = \frac{2z}{y} \Rightarrow 4y - 16 = 8z\left(\frac{2z}{y}\right) \Rightarrow y^2 - 4y = 4z^2 \Rightarrow 4(0)^2 + y^2 + (y^2 - 4y) - 16 = 0$

$$\Rightarrow y^2 - 2y - 8 = 0 \Rightarrow (y - 4)(y + 2) = 0 \Rightarrow y = 4 \text{ or } y = -2. \text{ Now } y = 4 \Rightarrow 4z^2 = 4^2 - 4(4)$$

$$\Rightarrow z = 0 \text{ and } y = -2 \Rightarrow 4z^2 = (-2)^2 - 4(-2) \Rightarrow z = \pm \sqrt{3}.$$

The temperatures are $T\left(\pm \frac{4}{3}, -\frac{4}{3}, -\frac{4}{3}\right) = 642\frac{2}{3}^\circ, T(0, 4, 0) = 600^\circ, T\left(0, -2, \sqrt{3}\right) = \left(600 - 24\sqrt{3}\right)^\circ,$ and

$T\left(0, -2, -\sqrt{3}\right) = \left(600 + 24\sqrt{3}\right)^\circ \approx 641.6^\circ.$ Therefore $\left(\pm \frac{4}{3}, -\frac{4}{3}, -\frac{4}{3}\right)$ are the hottest points on the space probe.

30. $\nabla T = 400yz^2\mathbf{i} + 400xz^2\mathbf{j} + 800xyz\mathbf{k}$ and $\nabla g = 2x\mathbf{i} + 2y\mathbf{j} + 2z\mathbf{k}$ so that $\nabla T = \lambda \nabla g \Rightarrow 400yz^2\mathbf{i} + 400xz^2\mathbf{j} + 800xyz\mathbf{k} = \lambda(2x\mathbf{i} + 2y\mathbf{j} + 2z\mathbf{k}) \Rightarrow 400yz^2 = 2x\lambda, 400xz^2 = 2y\lambda,$ and $800xyz = 2z\lambda.$

Solving this system yields the points $(0, \pm 1, 0), (\pm 1, 0, 0),$ and $\left(\pm \frac{1}{2}, \pm \frac{1}{2}, \pm \frac{\sqrt{2}}{2}\right).$ The corresponding

temperatures are $T(0, \pm 1, 0) = 0$, $T(\pm 1, 0, 0) = 0$, and $T\left(\pm \frac{1}{2}, \pm \frac{1}{2}, \pm \frac{\sqrt{2}}{2}\right) = \pm 50$. Therefore 50 is the maximum temperature at $\left(\frac{1}{2}, \frac{1}{2}, \pm \frac{\sqrt{2}}{2}\right)$ and $\left(-\frac{1}{2}, -\frac{1}{2}, \pm \frac{\sqrt{2}}{2}\right)$; -50 is the minimum temperature at $\left(\frac{1}{2}, -\frac{1}{2}, \pm \frac{\sqrt{2}}{2}\right)$ and $\left(-\frac{1}{2}, \frac{1}{2}, \pm \frac{\sqrt{2}}{2}\right)$.

31. $\nabla U = (y + 2)\mathbf{i} + x\mathbf{j}$ and $\nabla g = 2\mathbf{i} + \mathbf{j}$ so that $\nabla U = \lambda \nabla g \Rightarrow (y + 2)\mathbf{i} + x\mathbf{j} = \lambda(2\mathbf{i} + \mathbf{j}) \Rightarrow y + 2 = 2\lambda$ and $x = \lambda \Rightarrow y + 2 = 2x \Rightarrow y = 2x - 2 \Rightarrow 2x + (2x - 2) = 30 \Rightarrow x = 8$ and $y = 14$. Therefore $U(8, 14) = \$128$ is the maximum value of U under the constraint.
32. $\nabla M = (6 + z)\mathbf{i} - 2y\mathbf{j} + x\mathbf{k}$ and $\nabla g = 2x\mathbf{i} + 2y\mathbf{j} + 2z\mathbf{k}$ so that $\nabla M = \lambda \nabla g \Rightarrow (6 + z)\mathbf{i} - 2y\mathbf{j} + x\mathbf{k} = \lambda(2x\mathbf{i} + 2y\mathbf{j} + 2z\mathbf{k}) \Rightarrow 6 + z = 2x\lambda$, $-2y = 2y\lambda$, $x = 2z\lambda \Rightarrow \lambda = -1$ or $y = 0$.
CASE 1: $\lambda = -1 \Rightarrow 6 + z = -2x$ and $x = -2z \Rightarrow 6 + z = -2(-2z) \Rightarrow z = 2$ and $x = -4$. Then $(-4)^2 + y^2 + 2^2 - 36 = 0 \Rightarrow y = \pm 4$.
CASE 2: $y = 0$, $6 + z = 2x\lambda$, and $x = 2z\lambda \Rightarrow \lambda = \frac{x}{2z} \Rightarrow 6 + z = 2x\left(\frac{x}{2z}\right) \Rightarrow 6z + z^2 = x^2 \Rightarrow (6z + z^2) + 0^2 + z^2 = 36 \Rightarrow z = -6$ or $z = 3$. Now $z = -6 \Rightarrow x^2 = 0 \Rightarrow x = 0$; $z = 3 \Rightarrow x^2 = 27 \Rightarrow x = \pm 3\sqrt{3}$.
Therefore we have the points $(\pm 3\sqrt{3}, 0, 3)$, $(0, 0, -6)$, and $(-4, \pm 4, 2)$. Then $M(3\sqrt{3}, 0, 3) = 27\sqrt{3} + 60 \approx 106.8$, $M(-3\sqrt{3}, 0, 3) = 60 - 27\sqrt{3} \approx 13.2$, $M(0, 0, -6) = 60$, and $M(-4, 4, 2) = 12 = M(-4, -4, 2)$. Therefore, the weakest field is at $(-4, \pm 4, 2)$.
33. Let $g_1(x, y, z) = 2x - y = 0$ and $g_2(x, y, z) = y + z = 0 \Rightarrow \nabla g_1 = 2\mathbf{i} - \mathbf{j}$, $\nabla g_2 = \mathbf{j} + \mathbf{k}$, and $\nabla f = 2x\mathbf{i} + 2\mathbf{j} - 2z\mathbf{k}$ so that $\nabla f = \lambda \nabla g_1 + \mu \nabla g_2 \Rightarrow 2x\mathbf{i} + 2\mathbf{j} - 2z\mathbf{k} = \lambda(2\mathbf{i} - \mathbf{j}) + \mu(\mathbf{j} + \mathbf{k}) \Rightarrow 2x\mathbf{i} + 2\mathbf{j} - 2z\mathbf{k} = 2\lambda\mathbf{i} + (\mu - \lambda)\mathbf{j} + \mu\mathbf{k} \Rightarrow 2x = 2\lambda$, $2 = \mu - \lambda$, and $-2z = \mu \Rightarrow x = \lambda$. Then $2 = -2z - x \Rightarrow x = -2z - 2$ so that $2x - y = 0 \Rightarrow 2(-2z - 2) - y = 0 \Rightarrow -4z - 4 - y = 0$. This equation coupled with $y + z = 0$ implies $z = -\frac{4}{3}$ and $y = \frac{4}{3}$. Then $x = \frac{2}{3}$ so that $(\frac{2}{3}, \frac{4}{3}, -\frac{4}{3})$ is the point that gives the maximum value $f(\frac{2}{3}, \frac{4}{3}, -\frac{4}{3}) = (\frac{2}{3})^2 + 2(\frac{4}{3}) - (-\frac{4}{3})^2 = \frac{4}{3}$.
34. Let $g_1(x, y, z) = x + 2y + 3z - 6 = 0$ and $g_2(x, y, z) = x + 3y + 9z - 9 = 0 \Rightarrow \nabla g_1 = \mathbf{i} + 2\mathbf{j} + 3\mathbf{k}$, $\nabla g_2 = \mathbf{i} + 3\mathbf{j} + 9\mathbf{k}$, and $\nabla f = 2x\mathbf{i} + 2y\mathbf{j} + 2z\mathbf{k}$ so that $\nabla f = \lambda \nabla g_1 + \mu \nabla g_2 \Rightarrow 2x\mathbf{i} + 2y\mathbf{j} + 2z\mathbf{k} = \lambda(\mathbf{i} + 2\mathbf{j} + 3\mathbf{k}) + \mu(\mathbf{i} + 3\mathbf{j} + 9\mathbf{k}) \Rightarrow 2x = \lambda + \mu$, $2y = 2\lambda + 3\mu$, and $2z = 3\lambda + 9\mu$. Then $0 = x + 2y + 3z - 6 = \frac{1}{2}(\lambda + \mu) + (2\lambda + 3\mu) + (\frac{9}{2}\lambda + \frac{27}{2}\mu) - 6 \Rightarrow 7\lambda + 17\mu = 6$; $0 = x + 3y + 9z - 9 = \frac{1}{2}(\lambda + \mu) + (3\lambda + \frac{9}{2}\mu) + (\frac{27}{2}\lambda + \frac{81}{2}\mu) - 9 \Rightarrow 34\lambda + 91\mu = 18$. Solving these two equations for λ and μ gives $\lambda = \frac{240}{59}$ and $\mu = -\frac{78}{59} \Rightarrow x = \frac{\lambda + \mu}{2} = \frac{81}{59}$, $y = \frac{2\lambda + 3\mu}{2} = \frac{123}{59}$, and $z = \frac{3\lambda + 9\mu}{2} = \frac{9}{59}$. The minimum value is $f(\frac{81}{59}, \frac{123}{59}, \frac{9}{59}) = \frac{21,771}{59^2} = \frac{369}{59}$. (Note that there is no maximum value of f subject to the constraints because at least one of the variables x , y , or z can be made arbitrary and assume a value as large as we please.)
35. Let $f(x, y, z) = x^2 + y^2 + z^2$ be the square of the distance from the origin. We want to minimize $f(x, y, z)$ subject to the constraints $g_1(x, y, z) = y + 2z - 12 = 0$ and $g_2(x, y, z) = x + y - 6 = 0$. Thus $\nabla f = 2x\mathbf{i} + 2y\mathbf{j} + 2z\mathbf{k}$, $\nabla g_1 = \mathbf{j} + 2\mathbf{k}$, and $\nabla g_2 = \mathbf{i} + \mathbf{j}$ so that $\nabla f = \lambda \nabla g_1 + \mu \nabla g_2 \Rightarrow 2x = \mu$, $2y = \lambda + \mu$, and $2z = 2\lambda$. Then $0 = y + 2z - 12 = (\frac{\lambda}{2} + \frac{\mu}{2}) + 2\lambda - 12 \Rightarrow \frac{5}{2}\lambda + \frac{1}{2}\mu = 12 \Rightarrow 5\lambda + \mu = 24$; $0 = x + y - 6 = \frac{\mu}{2} + (\frac{\lambda}{2} + \frac{\mu}{2}) - 6 \Rightarrow \frac{1}{2}\lambda + \mu = 6 \Rightarrow \lambda + 2\mu = 12$. Solving these two equations for λ and μ gives $\lambda = 4$ and $\mu = 4 \Rightarrow x = \frac{\mu}{2} = 2$, $y = \frac{\lambda + \mu}{2} = 4$, and $z = \lambda = 4$. The point $(2, 4, 4)$ on the line of intersection is closest to the origin. (There is no maximum distance from the origin since points on the line can be arbitrarily far away.)
36. The maximum value is $f(\frac{2}{3}, \frac{4}{3}, -\frac{4}{3}) = \frac{4}{3}$ from Exercise 33 above.

37. Let $g_1(x, y, z) = z - 1 = 0$ and $g_2(x, y, z) = x^2 + y^2 + z^2 - 10 = 0 \Rightarrow \nabla g_1 = \mathbf{k}$, $\nabla g_2 = 2x\mathbf{i} + 2y\mathbf{j} + 2z\mathbf{k}$, and $\nabla f = 2xy\mathbf{z}\mathbf{i} + x^2z\mathbf{j} + x^2y\mathbf{k}$ so that $\nabla f = \lambda \nabla g_1 + \mu \nabla g_2 \Rightarrow 2xy\mathbf{z}\mathbf{i} + x^2z\mathbf{j} + x^2y\mathbf{k} = \lambda(\mathbf{k}) + \mu(2x\mathbf{i} + 2y\mathbf{j} + 2z\mathbf{k})$
 $\Rightarrow 2xyz = 2x\mu$, $x^2z = 2y\mu$, and $x^2y = 2z\mu + \lambda \Rightarrow xyz = x\mu \Rightarrow x = 0$ or $yz = \mu \Rightarrow \mu = y$ since $z = 1$.
CASE 1: $x = 0$ and $z = 1 \Rightarrow y^2 - 9 = 0$ (from g_2) $\Rightarrow y = \pm 3$ yielding the points $(0, \pm 3, 1)$.
CASE 2: $\mu = y \Rightarrow x^2z = 2y^2 \Rightarrow x^2 = 2y^2$ (since $z = 1$) $\Rightarrow 2y^2 + y^2 + 1 - 10 = 0$ (from g_2) $\Rightarrow 3y^2 - 9 = 0$
 $\Rightarrow y = \pm \sqrt{3} \Rightarrow x^2 = 2(\pm \sqrt{3})^2 \Rightarrow x = \pm \sqrt{6}$ yielding the points $(\pm \sqrt{6}, \pm \sqrt{3}, 1)$.
Now $f(0, \pm 3, 1) = 1$ and $f(\pm \sqrt{6}, \pm \sqrt{3}, 1) = 6(\pm \sqrt{3}) + 1 = 1 \pm 6\sqrt{3}$. Therefore the maximum of f is $1 + 6\sqrt{3}$ at $(\pm \sqrt{6}, \sqrt{3}, 1)$, and the minimum of f is $1 - 6\sqrt{3}$ at $(\pm \sqrt{6}, -\sqrt{3}, 1)$.
38. (a) Let $g_1(x, y, z) = x + y + z - 40 = 0$ and $g_2(x, y, z) = x + y - z = 0 \Rightarrow \nabla g_1 = \mathbf{i} + \mathbf{j} + \mathbf{k}$, $\nabla g_2 = \mathbf{i} + \mathbf{j} - \mathbf{k}$, and $\nabla w = yz\mathbf{i} + xz\mathbf{j} + xy\mathbf{k}$ so that $\nabla w = \lambda \nabla g_1 + \mu \nabla g_2 \Rightarrow yz\mathbf{i} + xz\mathbf{j} + xy\mathbf{k} = \lambda(\mathbf{i} + \mathbf{j} + \mathbf{k}) + \mu(\mathbf{i} + \mathbf{j} - \mathbf{k})$
 $\Rightarrow yz = \lambda + \mu$, $xz = \lambda + \mu$, and $xy = \lambda - \mu \Rightarrow yz = xz \Rightarrow z = 0$ or $y = x$.
CASE 1: $z = 0 \Rightarrow x + y = 40$ and $x + y = 0 \Rightarrow$ no solution.
CASE 2: $x = y \Rightarrow 2x + z - 40 = 0$ and $2x - z = 0 \Rightarrow z = 20 \Rightarrow x = 10$ and $y = 10 \Rightarrow w = (10)(10)(20) = 2000$
- (b) $\mathbf{n} = \begin{vmatrix} \mathbf{i} & \mathbf{j} & \mathbf{k} \\ 1 & 1 & 1 \\ 1 & 1 & -1 \end{vmatrix} = -2\mathbf{i} + 2\mathbf{j}$ is parallel to the line of intersection \Rightarrow the line is $x = -2t + 10$,
 $y = 2t + 10$, $z = 20$. Since $z = 20$, we see that $w = xyz = (-2t + 10)(2t + 10)(20) = (-4t^2 + 100)(20)$
which has its maximum when $t = 0 \Rightarrow x = 10$, $y = 10$, and $z = 20$.
39. Let $g_1(x, y, z) = y - x = 0$ and $g_2(x, y, z) = x^2 + y^2 + z^2 - 4 = 0$. Then $\nabla f = y\mathbf{i} + x\mathbf{j} + 2z\mathbf{k}$, $\nabla g_1 = -\mathbf{i} + \mathbf{j}$, and $\nabla g_2 = 2x\mathbf{i} + 2y\mathbf{j} + 2z\mathbf{k}$ so that $\nabla f = \lambda \nabla g_1 + \mu \nabla g_2 \Rightarrow y\mathbf{i} + x\mathbf{j} + 2z\mathbf{k} = \lambda(-\mathbf{i} + \mathbf{j}) + \mu(2x\mathbf{i} + 2y\mathbf{j} + 2z\mathbf{k})$
 $\Rightarrow y = -\lambda + 2x\mu$, $x = \lambda + 2y\mu$, and $2z = 2z\mu \Rightarrow z = 0$ or $\mu = 1$.
CASE 1: $z = 0 \Rightarrow x^2 + y^2 - 4 = 0 \Rightarrow 2x^2 - 4 = 0$ (since $x = y$) $\Rightarrow x = \pm \sqrt{2}$ and $y = \pm \sqrt{2}$ yielding the points $(\pm \sqrt{2}, \pm \sqrt{2}, 0)$.
CASE 2: $\mu = 1 \Rightarrow y = -\lambda + 2x$ and $x = \lambda + 2y \Rightarrow x + y = 2(x + y) \Rightarrow 2x = 2(2x)$ since $x = y \Rightarrow x = 0 \Rightarrow y = 0$
 $\Rightarrow z^2 - 4 = 0 \Rightarrow z = \pm 2$ yielding the points $(0, 0, \pm 2)$.
Now, $f(0, 0, \pm 2) = 4$ and $f(\pm \sqrt{2}, \pm \sqrt{2}, 0) = 2$. Therefore the maximum value of f is 4 at $(0, 0, \pm 2)$ and the minimum value of f is 2 at $(\pm \sqrt{2}, \pm \sqrt{2}, 0)$.
40. Let $f(x, y, z) = x^2 + y^2 + z^2$ be the square of the distance from the origin. We want to minimize $f(x, y, z)$ subject to the constraints $g_1(x, y, z) = 2y + 4z - 5 = 0$ and $g_2(x, y, z) = 4x^2 + 4y^2 - z^2 = 0$. Thus $\nabla f = 2x\mathbf{i} + 2y\mathbf{j} + 2z\mathbf{k}$, $\nabla g_1 = 2\mathbf{j} + 4\mathbf{k}$, and $\nabla g_2 = 8x\mathbf{i} + 8y\mathbf{j} - 2z\mathbf{k}$ so that $\nabla f = \lambda \nabla g_1 + \mu \nabla g_2 \Rightarrow 2x\mathbf{i} + 2y\mathbf{j} + 2z\mathbf{k} = \lambda(2\mathbf{j} + 4\mathbf{k}) + \mu(8x\mathbf{i} + 8y\mathbf{j} - 2z\mathbf{k}) \Rightarrow 2x = 8x\mu$, $2y = 2\lambda + 8y\mu$, and $2z = 4\lambda - 2z\mu \Rightarrow x = 0$ or $\mu = \frac{1}{4}$.
CASE 1: $x = 0 \Rightarrow 4(0)^2 + 4y^2 - z^2 = 0 \Rightarrow z = \pm 2y \Rightarrow 2y + 4(2y) - 5 = 0 \Rightarrow y = \frac{1}{2}$, or $2y + 4(-2y) - 5 = 0 \Rightarrow y = -\frac{5}{6}$ yielding the points $(0, \frac{1}{2}, 1)$ and $(0, -\frac{5}{6}, \frac{5}{3})$.
CASE 2: $\mu = \frac{1}{4} \Rightarrow y = \lambda + y \Rightarrow \lambda = 0 \Rightarrow 2z = 4(0) - 2z(\frac{1}{4}) \Rightarrow z = 0 \Rightarrow 2y + 4(0) = 5 \Rightarrow y = \frac{5}{2}$ and $(0)^2 = 4x^2 + 4(\frac{5}{2})^2 \Rightarrow$ no solution.
Then $f(0, \frac{1}{2}, 1) = \frac{5}{4}$ and $f(0, -\frac{5}{6}, \frac{5}{3}) = 25(\frac{1}{36} + \frac{1}{9}) = \frac{125}{36} \Rightarrow$ the point $(0, \frac{1}{2}, 1)$ is closest to the origin.
41. $\nabla f = \mathbf{i} + \mathbf{j}$ and $\nabla g = y\mathbf{i} + x\mathbf{j}$ so that $\nabla f = \lambda \nabla g \Rightarrow \mathbf{i} + \mathbf{j} = \lambda(y\mathbf{i} + x\mathbf{j}) \Rightarrow 1 = y\lambda$ and $1 = x\lambda \Rightarrow y = x$
 $\Rightarrow y^2 = 16 \Rightarrow y = \pm 4 \Rightarrow (4, 4)$ and $(-4, -4)$ are candidates for the location of extreme values. But as $x \rightarrow \infty$, $y \rightarrow \infty$ and $f(x, y) \rightarrow \infty$; as $x \rightarrow -\infty$, $y \rightarrow 0$ and $f(x, y) \rightarrow -\infty$. Therefore no maximum or minimum value exists subject to the constraint.

42. Let $f(A, B, C) = \sum_{k=1}^4 (Ax_k + By_k + C - z_k)^2 = C^2 + (B + C - 1)^2 + (A + B + C - 1)^2 + (A + C + 1)^2$. We want to minimize f . Then $f_A(A, B, C) = 4A + 2B + 4C$, $f_B(A, B, C) = 2A + 4B + 4C - 4$, and $f_C(A, B, C) = 4A + 4B + 8C - 2$. Set each partial derivative equal to 0 and solve the system to get $A = -\frac{1}{2}$, $B = \frac{3}{2}$, and $C = -\frac{1}{4}$ or the critical point of f is $(-\frac{1}{2}, \frac{3}{2}, -\frac{1}{4})$.

43. (a) Maximize $f(a, b, c) = a^2b^2c^2$ subject to $a^2 + b^2 + c^2 = r^2$. Thus $\nabla f = 2ab^2c^2\mathbf{i} + 2a^2bc^2\mathbf{j} + 2a^2b^2c\mathbf{k}$ and $\nabla g = 2a\mathbf{i} + 2b\mathbf{j} + 2c\mathbf{k}$ so that $\nabla f = \lambda \nabla g \Rightarrow 2ab^2c^2 = 2a\lambda$, $2a^2bc^2 = 2b\lambda$, and $2a^2b^2c = 2c\lambda \Rightarrow 2a^2b^2c^2 = 2a^2\lambda = 2b^2\lambda = 2c^2\lambda \Rightarrow \lambda = 0$ or $a^2 = b^2 = c^2$.

CASE 1: $\lambda = 0 \Rightarrow a^2b^2c^2 = 0$.

CASE 2: $a^2 = b^2 = c^2 \Rightarrow f(a, b, c) = a^2a^2a^2$ and $3a^2 = r^2 \Rightarrow f(a, b, c) = (\frac{r^2}{3})^3$ is the maximum value.

(b) The point $(\sqrt{a}, \sqrt{b}, \sqrt{c})$ is on the sphere if $a + b + c = r^2$. Moreover, by part (a), $abc = f(\sqrt{a}, \sqrt{b}, \sqrt{c}) \leq (\frac{r^2}{3})^3 \Rightarrow (abc)^{1/3} \leq \frac{r^2}{3} = \frac{a+b+c}{3}$, as claimed.

44. Let $f(x_1, x_2, \dots, x_n) = \sum_{i=1}^n a_i x_i = a_1 x_1 + a_2 x_2 + \dots + a_n x_n$ and $g(x_1, x_2, \dots, x_n) = x_1^2 + x_2^2 + \dots + x_n^2 - 1$. Then we want $\nabla f = \lambda \nabla g \Rightarrow a_1 = \lambda(2x_1), a_2 = \lambda(2x_2), \dots, a_n = \lambda(2x_n), \lambda \neq 0 \Rightarrow x_i = \frac{a_i}{2\lambda} \Rightarrow \frac{a_1^2}{4\lambda^2} + \frac{a_2^2}{4\lambda^2} + \dots + \frac{a_n^2}{4\lambda^2} = 1 \Rightarrow 4\lambda^2 = \sum_{i=1}^n a_i^2 \Rightarrow 2\lambda = (\sum_{i=1}^n a_i^2)^{1/2} \Rightarrow f(x_1, x_2, \dots, x_n) = \sum_{i=1}^n a_i x_i = \sum_{i=1}^n a_i (\frac{a_i}{2\lambda}) = \frac{1}{2\lambda} \sum_{i=1}^n a_i^2 = (\sum_{i=1}^n a_i^2)^{1/2}$ is the maximum value.

45-50. Example CAS commands:

Maple:

```
f := (x,y,z) -> x*y+y*z;
g1 := (x,y,z) -> x^2+y^2-2;
g2 := (x,y,z) -> x^2+z^2-2;
h := unapply( f(x,y,z)-lambda[1]*g1(x,y,z)-lambda[2]*g2(x,y,z), (x,y,z,lamba[1],lamba[2]) ); # (a)
hx := diff( h(x,y,z,lamba[1],lamba[2]), x ); # (b)
hy := diff( h(x,y,z,lamba[1],lamba[2]), y );
hz := diff( h(x,y,z,lamba[1],lamba[2]), z );
h11 := diff( h(x,y,z,lamba[1],lamba[2]), lamba[1] );
h12 := diff( h(x,y,z,lamba[1],lamba[2]), lamba[2] );
sys := { hx=0, hy=0, hz=0, h11=0, h12=0 };
q1 := solve( sys, {x,y,z,lamba[1],lamba[2]} ); # (c)
q2 := map(allvalues, {q1});
for p in q2 do # (d)
  eval( [x,y,z,f(x,y,z)], p );
  ``=evalf(eval( [x,y,z,f(x,y,z)], p ));
end do;
```

Mathematica: (assigned functions will vary)

```
Clear[x, y, z, lambda1, lambda2]
f[x_,y_,z_]:= x y + y z
g1[x_,y_,z_]:= x^2 + y^2 - 2
g2[x_,y_,z_]:= x^2 + z^2 - 2
h = f[x, y, z] - lambda1 g1[x, y, z] - lambda2 g2[x, y, z];
hx= D[h, x]; hy= D[h, y]; hz= D[h, z]; hL1=D[h, lambda1]; hL2= D[h, lambda2];
critical=Solve[{hx==0, hy==0, hz==0, hL1==0, hL2==0, g1[x,y,z]==0, g2[x,y,z]==0},
```

{x, y, z, lambda1, lambda2}]/N
 {{x, y, z}, f[x, y, z]}/.critical

14.9 PARTIAL DERIVATIVES WITH CONSTRAINED VARIABLES

1. $w = x^2 + y^2 + z^2$ and $z = x^2 + y^2$:

$$(a) \begin{pmatrix} y \\ z \end{pmatrix} \rightarrow \begin{pmatrix} x = x(y, z) \\ y = y \\ z = z \end{pmatrix} \rightarrow w \Rightarrow \left(\frac{\partial w}{\partial y}\right)_z = \frac{\partial w}{\partial x} \frac{\partial x}{\partial y} + \frac{\partial w}{\partial y} \frac{\partial y}{\partial y} + \frac{\partial w}{\partial z} \frac{\partial z}{\partial y}; \frac{\partial z}{\partial y} = 0 \text{ and } \frac{\partial z}{\partial y} = 2x \frac{\partial x}{\partial y} + 2y \frac{\partial y}{\partial y}$$

$$= 2x \frac{\partial x}{\partial y} + 2y \Rightarrow 0 = 2x \frac{\partial x}{\partial y} + 2y \Rightarrow \frac{\partial x}{\partial y} = -\frac{y}{x} \Rightarrow \left(\frac{\partial w}{\partial y}\right)_z = (2x) \left(-\frac{y}{x}\right) + (2y)(1) + (2z)(0) = -2y + 2y = 0$$

$$(b) \begin{pmatrix} x \\ z \end{pmatrix} \rightarrow \begin{pmatrix} x = x \\ y = y(x, z) \\ z = z \end{pmatrix} \rightarrow w \Rightarrow \left(\frac{\partial w}{\partial z}\right)_x = \frac{\partial w}{\partial x} \frac{\partial x}{\partial z} + \frac{\partial w}{\partial y} \frac{\partial y}{\partial z} + \frac{\partial w}{\partial z} \frac{\partial z}{\partial z}; \frac{\partial x}{\partial z} = 0 \text{ and } \frac{\partial z}{\partial z} = 2x \frac{\partial x}{\partial z} + 2y \frac{\partial y}{\partial z}$$

$$\Rightarrow 1 = 2y \frac{\partial y}{\partial z} \Rightarrow \frac{\partial y}{\partial z} = \frac{1}{2y} \Rightarrow \left(\frac{\partial w}{\partial z}\right)_x = (2x)(0) + (2y) \left(\frac{1}{2y}\right) + (2z)(1) = 1 + 2z$$

$$(c) \begin{pmatrix} y \\ z \end{pmatrix} \rightarrow \begin{pmatrix} x = x(y, z) \\ y = y \\ z = z \end{pmatrix} \rightarrow w \Rightarrow \left(\frac{\partial w}{\partial z}\right)_y = \frac{\partial w}{\partial x} \frac{\partial x}{\partial z} + \frac{\partial w}{\partial y} \frac{\partial y}{\partial z} + \frac{\partial w}{\partial z} \frac{\partial z}{\partial z}; \frac{\partial y}{\partial z} = 0 \text{ and } \frac{\partial z}{\partial z} = 2x \frac{\partial x}{\partial z} + 2y \frac{\partial y}{\partial z}$$

$$\Rightarrow 1 = 2x \frac{\partial x}{\partial z} \Rightarrow \frac{\partial x}{\partial z} = \frac{1}{2x} \Rightarrow \left(\frac{\partial w}{\partial z}\right)_y = (2x) \left(\frac{1}{2x}\right) + (2y)(0) + (2z)(1) = 1 + 2z$$

2. $w = x^2 + y - z + \sin t$ and $x + y = t$:

$$(a) \begin{pmatrix} x \\ y \\ z \end{pmatrix} \rightarrow \begin{pmatrix} x = x \\ y = y \\ z = z \\ t = x + y \end{pmatrix} \rightarrow w \Rightarrow \left(\frac{\partial w}{\partial y}\right)_{x,z} = \frac{\partial w}{\partial x} \frac{\partial x}{\partial y} + \frac{\partial w}{\partial y} \frac{\partial y}{\partial y} + \frac{\partial w}{\partial z} \frac{\partial z}{\partial y} + \frac{\partial w}{\partial t} \frac{\partial t}{\partial y}; \frac{\partial x}{\partial y} = 0, \frac{\partial z}{\partial y} = 0, \text{ and}$$

$$\frac{\partial t}{\partial y} = 1 \Rightarrow \left(\frac{\partial w}{\partial y}\right)_{x,t} = (2x)(0) + (1)(1) + (-1)(0) + (\cos t)(1) = 1 + \cos t = 1 + \cos(x + y)$$

$$(b) \begin{pmatrix} y \\ z \\ t \end{pmatrix} \rightarrow \begin{pmatrix} x = t - y \\ y = y \\ z = z \\ t = t \end{pmatrix} \rightarrow w \Rightarrow \left(\frac{\partial w}{\partial y}\right)_{z,t} = \frac{\partial w}{\partial x} \frac{\partial x}{\partial y} + \frac{\partial w}{\partial y} \frac{\partial y}{\partial y} + \frac{\partial w}{\partial z} \frac{\partial z}{\partial y} + \frac{\partial w}{\partial t} \frac{\partial t}{\partial y}; \frac{\partial z}{\partial y} = 0 \text{ and } \frac{\partial t}{\partial y} = 0$$

$$\Rightarrow \frac{\partial x}{\partial y} = \frac{\partial t}{\partial y} - \frac{\partial y}{\partial y} = -1 \Rightarrow \left(\frac{\partial w}{\partial y}\right)_{z,t} = (2x)(-1) + (1)(1) + (-1)(0) + (\cos t)(0) = 1 - 2(t - y) = 1 + 2y - 2t$$

$$(c) \begin{pmatrix} x \\ y \\ z \end{pmatrix} \rightarrow \begin{pmatrix} x = x \\ y = y \\ z = z \\ t = x + y \end{pmatrix} \rightarrow w \Rightarrow \left(\frac{\partial w}{\partial z}\right)_{x,y} = \frac{\partial w}{\partial x} \frac{\partial x}{\partial z} + \frac{\partial w}{\partial y} \frac{\partial y}{\partial z} + \frac{\partial w}{\partial z} \frac{\partial z}{\partial z} + \frac{\partial w}{\partial t} \frac{\partial t}{\partial z}; \frac{\partial x}{\partial z} = 0 \text{ and } \frac{\partial y}{\partial z} = 0$$

$$\Rightarrow \left(\frac{\partial w}{\partial z}\right)_{x,y} = (2x)(0) + (1)(0) + (-1)(1) + (\cos t)(0) = -1$$

$$(d) \begin{pmatrix} y \\ z \\ t \end{pmatrix} \rightarrow \begin{pmatrix} x = t - y \\ y = y \\ z = z \\ t = t \end{pmatrix} \rightarrow w \Rightarrow \left(\frac{\partial w}{\partial z}\right)_{y,t} = \frac{\partial w}{\partial x} \frac{\partial x}{\partial z} + \frac{\partial w}{\partial y} \frac{\partial y}{\partial z} + \frac{\partial w}{\partial z} \frac{\partial z}{\partial z} + \frac{\partial w}{\partial t} \frac{\partial t}{\partial z}; \frac{\partial y}{\partial z} = 0 \text{ and } \frac{\partial t}{\partial z} = 0$$

$$\Rightarrow \left(\frac{\partial w}{\partial z}\right)_{y,t} = (2x)(0) + (1)(0) + (-1)(1) + (\cos t)(0) = -1$$

$$(e) \begin{pmatrix} x \\ z \\ t \end{pmatrix} \rightarrow \begin{pmatrix} x = x \\ y = t - x \\ z = z \\ t = t \end{pmatrix} \rightarrow w \Rightarrow \left(\frac{\partial w}{\partial t}\right)_{x,z} = \frac{\partial w}{\partial x} \frac{\partial x}{\partial t} + \frac{\partial w}{\partial y} \frac{\partial y}{\partial t} + \frac{\partial w}{\partial z} \frac{\partial z}{\partial t} + \frac{\partial w}{\partial t} \frac{\partial t}{\partial t}; \frac{\partial x}{\partial t} = 0 \text{ and } \frac{\partial z}{\partial t} = 0$$

$$\Rightarrow \left(\frac{\partial w}{\partial t}\right)_{x,z} = (2x)(0) + (1)(1) + (-1)(0) + (\cos t)(1) = 1 + \cos t$$

$$(f) \begin{pmatrix} y \\ z \\ t \end{pmatrix} \rightarrow \begin{pmatrix} x = t - y \\ y = y \\ z = z \\ t = t \end{pmatrix} \rightarrow w \Rightarrow \left(\frac{\partial w}{\partial t}\right)_{y,z} = \frac{\partial w}{\partial x} \frac{\partial x}{\partial t} + \frac{\partial w}{\partial y} \frac{\partial y}{\partial t} + \frac{\partial w}{\partial z} \frac{\partial z}{\partial t} + \frac{\partial w}{\partial t} \frac{\partial t}{\partial t} \cdot \frac{\partial y}{\partial t} = 0 \text{ and } \frac{\partial z}{\partial t} = 0$$

$$\Rightarrow \left(\frac{\partial w}{\partial t}\right)_{y,z} = (2x)(1) + (1)(0) + (-1)(0) + (\cos t)(1) = \cos t + 2x = \cos t + 2(t - y)$$

3. $U = f(P, V, T)$ and $PV = nRT$

$$(a) \begin{pmatrix} P \\ V \\ T \end{pmatrix} \rightarrow \begin{pmatrix} P = P \\ V = V \\ T = \frac{PV}{nR} \end{pmatrix} \rightarrow U \Rightarrow \left(\frac{\partial U}{\partial P}\right)_V = \frac{\partial U}{\partial P} \frac{\partial P}{\partial P} + \frac{\partial U}{\partial V} \frac{\partial V}{\partial P} + \frac{\partial U}{\partial T} \frac{\partial T}{\partial P} = \frac{\partial U}{\partial P} + \left(\frac{\partial U}{\partial V}\right)(0) + \left(\frac{\partial U}{\partial T}\right)\left(\frac{V}{nR}\right)$$

$$= \frac{\partial U}{\partial P} + \left(\frac{\partial U}{\partial T}\right)\left(\frac{V}{nR}\right)$$

$$(b) \begin{pmatrix} V \\ T \end{pmatrix} \rightarrow \begin{pmatrix} P = \frac{nRT}{V} \\ V = V \\ T = T \end{pmatrix} \rightarrow U \Rightarrow \left(\frac{\partial U}{\partial T}\right)_V = \frac{\partial U}{\partial P} \frac{\partial P}{\partial T} + \frac{\partial U}{\partial V} \frac{\partial V}{\partial T} + \frac{\partial U}{\partial T} \frac{\partial T}{\partial T} = \left(\frac{\partial U}{\partial P}\right)\left(\frac{nR}{V}\right) + \left(\frac{\partial U}{\partial V}\right)(0) + \frac{\partial U}{\partial T}$$

$$= \left(\frac{\partial U}{\partial P}\right)\left(\frac{nR}{V}\right) + \frac{\partial U}{\partial T}$$

4. $w = x^2 + y^2 + z^2$ and $y \sin z + z \sin x = 0$

$$(a) \begin{pmatrix} x \\ y \\ z \end{pmatrix} \rightarrow \begin{pmatrix} x = x \\ y = y \\ z = z(x, y) \end{pmatrix} \rightarrow w \Rightarrow \left(\frac{\partial w}{\partial x}\right)_y = \frac{\partial w}{\partial x} \frac{\partial x}{\partial x} + \frac{\partial w}{\partial y} \frac{\partial y}{\partial x} + \frac{\partial w}{\partial z} \frac{\partial z}{\partial x} \cdot \frac{\partial y}{\partial x} = 0 \text{ and}$$

$$(y \cos z) \frac{\partial z}{\partial x} + (\sin x) \frac{\partial z}{\partial x} + z \cos x = 0 \Rightarrow \frac{\partial z}{\partial x} = \frac{-z \cos x}{y \cos z + \sin x}. \text{ At } (0, 1, \pi), \frac{\partial z}{\partial x} = \frac{-\pi}{-1} = \pi$$

$$\Rightarrow \left(\frac{\partial w}{\partial x}\right)_{y|_{(0,1,\pi)}} = (2x)(1) + (2y)(0) + (2z)(\pi)|_{(0,1,\pi)} = 2\pi^2$$

$$(b) \begin{pmatrix} y \\ z \end{pmatrix} \rightarrow \begin{pmatrix} x = x(y, z) \\ y = y \\ z = z \end{pmatrix} \rightarrow w \Rightarrow \left(\frac{\partial w}{\partial z}\right)_y = \frac{\partial w}{\partial x} \frac{\partial x}{\partial z} + \frac{\partial w}{\partial y} \frac{\partial y}{\partial z} + \frac{\partial w}{\partial z} \frac{\partial z}{\partial z} = (2x) \frac{\partial x}{\partial z} + (2y)(0) + (2z)(1)$$

$$= (2x) \frac{\partial x}{\partial z} + 2z. \text{ Now } (\sin z) \frac{\partial y}{\partial z} + y \cos z + \sin x + (z \cos x) \frac{\partial x}{\partial z} = 0 \text{ and } \frac{\partial y}{\partial z} = 0$$

$$\Rightarrow y \cos z + \sin x + (z \cos x) \frac{\partial x}{\partial z} = 0 \Rightarrow \frac{\partial x}{\partial z} = \frac{-y \cos z - \sin x}{z \cos x}. \text{ At } (0, 1, \pi), \frac{\partial x}{\partial z} = \frac{1-0}{(\pi)(1)} = \frac{1}{\pi}$$

$$\Rightarrow \left(\frac{\partial w}{\partial z}\right)_{y|_{(0,1,\pi)}} = 2(0) \left(\frac{1}{\pi}\right) + 2\pi = 2\pi$$

5. $w = x^2y^2 + yz - z^3$ and $x^2 + y^2 + z^2 = 6$

$$(a) \begin{pmatrix} x \\ y \\ z \end{pmatrix} \rightarrow \begin{pmatrix} x = x \\ y = y \\ z = z(x, y) \end{pmatrix} \rightarrow w \Rightarrow \left(\frac{\partial w}{\partial y}\right)_x = \frac{\partial w}{\partial x} \frac{\partial x}{\partial y} + \frac{\partial w}{\partial y} \frac{\partial y}{\partial y} + \frac{\partial w}{\partial z} \frac{\partial z}{\partial y}$$

$$= (2xy^2)(0) + (2x^2y + z)(1) + (y - 3z^2) \frac{\partial z}{\partial y} = 2x^2y + z + (y - 3z^2) \frac{\partial z}{\partial y}. \text{ Now } (2x) \frac{\partial x}{\partial y} + 2y + (2z) \frac{\partial z}{\partial y} = 0 \text{ and}$$

$$\frac{\partial x}{\partial y} = 0 \Rightarrow 2y + (2z) \frac{\partial z}{\partial y} = 0 \Rightarrow \frac{\partial z}{\partial y} = -\frac{y}{z}. \text{ At } (w, x, y, z) = (4, 2, 1, -1), \frac{\partial z}{\partial y} = -\frac{1}{-1} = 1 \Rightarrow \left(\frac{\partial w}{\partial y}\right)_{x|_{(4,2,1,-1)}}$$

$$= [(2)(2)^2(1) + (-1)] + [1 - 3(-1)^2](1) = 5$$

$$(b) \begin{pmatrix} y \\ z \end{pmatrix} \rightarrow \begin{pmatrix} x = x(y, z) \\ y = y \\ z = z \end{pmatrix} \rightarrow w \Rightarrow \left(\frac{\partial w}{\partial y}\right)_z = \frac{\partial w}{\partial x} \frac{\partial x}{\partial y} + \frac{\partial w}{\partial y} \frac{\partial y}{\partial y} + \frac{\partial w}{\partial z} \frac{\partial z}{\partial y}$$

$$= (2xy^2) \frac{\partial x}{\partial y} + (2x^2y + z)(1) + (y - 3z^2)(0) = (2x^2y) \frac{\partial x}{\partial y} + 2x^2y + z. \text{ Now } (2x) \frac{\partial x}{\partial y} + 2y + (2z) \frac{\partial z}{\partial y} = 0 \text{ and}$$

$$\frac{\partial z}{\partial y} = 0 \Rightarrow (2x) \frac{\partial x}{\partial y} + 2y = 0 \Rightarrow \frac{\partial x}{\partial y} = -\frac{y}{x}. \text{ At } (w, x, y, z) = (4, 2, 1, -1), \frac{\partial x}{\partial y} = -\frac{1}{2} \Rightarrow \left(\frac{\partial w}{\partial y}\right)_{z|_{(4,2,1,-1)}}$$

$$= (2)(2)(1)^2 \left(-\frac{1}{2}\right) + (2)(2)^2(1) + (-1) = 5$$

6. $y = uv \Rightarrow 1 = v \frac{\partial u}{\partial y} + u \frac{\partial v}{\partial y}; x = u^2 + v^2$ and $\frac{\partial x}{\partial y} = 0 \Rightarrow 0 = 2u \frac{\partial u}{\partial y} + 2v \frac{\partial v}{\partial y} \Rightarrow \frac{\partial v}{\partial y} = \left(-\frac{u}{v}\right) \frac{\partial u}{\partial y} \Rightarrow 1$

$$= v \frac{\partial u}{\partial y} + u \left(-\frac{u}{v} \frac{\partial u}{\partial y}\right) = \left(\frac{v^2 - u^2}{v}\right) \frac{\partial u}{\partial y} \Rightarrow \frac{\partial u}{\partial y} = \frac{v}{v^2 - u^2}. \text{ At } (u, v) = (\sqrt{2}, 1), \frac{\partial u}{\partial y} = \frac{1}{1^2 - (\sqrt{2})^2} = -1$$

$$\Rightarrow \left(\frac{\partial u}{\partial y}\right)_x = -1$$

7. $\begin{pmatrix} r \\ \theta \end{pmatrix} \rightarrow \begin{pmatrix} x = r \cos \theta \\ y = r \sin \theta \end{pmatrix} \Rightarrow \left(\frac{\partial x}{\partial r}\right)_\theta = \cos \theta; x^2 + y^2 = r^2 \Rightarrow 2x + 2y \frac{\partial y}{\partial x} = 2r \frac{\partial r}{\partial x}$ and $\frac{\partial y}{\partial x} = 0 \Rightarrow 2x = 2r \frac{\partial r}{\partial x}$
 $\Rightarrow \frac{\partial r}{\partial x} = \frac{x}{r} \Rightarrow \left(\frac{\partial r}{\partial x}\right)_y = \frac{x}{\sqrt{x^2 + y^2}}$

8. If $x, y,$ and z are independent, then $\left(\frac{\partial w}{\partial x}\right)_{y,z} = \frac{\partial w}{\partial x} \frac{\partial x}{\partial x} + \frac{\partial w}{\partial y} \frac{\partial y}{\partial x} + \frac{\partial w}{\partial z} \frac{\partial z}{\partial x} + \frac{\partial w}{\partial t} \frac{\partial t}{\partial x}$
 $= (2x)(1) + (-2y)(0) + (4)(0) + (1)\left(\frac{\partial t}{\partial x}\right) = 2x + \frac{\partial t}{\partial x}$. Thus $x + 2z + t = 25 \Rightarrow 1 + 0 + \frac{\partial t}{\partial x} = 0 \Rightarrow \frac{\partial t}{\partial x} = -1$
 $\Rightarrow \left(\frac{\partial w}{\partial x}\right)_{y,z} = 2x - 1$. On the other hand, if $x, y,$ and t are independent, then $\left(\frac{\partial w}{\partial x}\right)_{y,t}$
 $= \frac{\partial w}{\partial x} \frac{\partial x}{\partial x} + \frac{\partial w}{\partial y} \frac{\partial y}{\partial x} + \frac{\partial w}{\partial z} \frac{\partial z}{\partial x} + \frac{\partial w}{\partial t} \frac{\partial t}{\partial x} = (2x)(1) + (-2y)(0) + 4 \frac{\partial z}{\partial x} + (1)(0) = 2x + 4 \frac{\partial z}{\partial x}$. Thus, $x + 2z + t = 25$
 $\Rightarrow 1 + 2 \frac{\partial z}{\partial x} + 0 = 0 \Rightarrow \frac{\partial z}{\partial x} = -\frac{1}{2} \Rightarrow \left(\frac{\partial w}{\partial x}\right)_{y,t} = 2x + 4\left(-\frac{1}{2}\right) = 2x - 2$.

9. If x is a differentiable function of y and z , then $f(x, y, z) = 0 \Rightarrow \frac{\partial f}{\partial x} \frac{\partial x}{\partial y} + \frac{\partial f}{\partial y} \frac{\partial y}{\partial y} + \frac{\partial f}{\partial z} \frac{\partial z}{\partial y} = 0 \Rightarrow \frac{\partial f}{\partial x} + \frac{\partial f}{\partial y} \frac{\partial y}{\partial x} = 0$
 $\Rightarrow \left(\frac{\partial x}{\partial y}\right)_z = -\frac{\partial f/\partial y}{\partial f/\partial x}$. Similarly, if y is a differentiable function of x and z , $\left(\frac{\partial y}{\partial z}\right)_x = -\frac{\partial f/\partial z}{\partial f/\partial x}$ and if z is a
 differentiable function of x and y , $\left(\frac{\partial z}{\partial x}\right)_y = -\frac{\partial f/\partial x}{\partial f/\partial y}$. Then $\left(\frac{\partial x}{\partial y}\right)_z \left(\frac{\partial y}{\partial z}\right)_x \left(\frac{\partial z}{\partial x}\right)_y$
 $= \left(-\frac{\partial f/\partial y}{\partial f/\partial x}\right) \left(-\frac{\partial f/\partial z}{\partial f/\partial x}\right) \left(-\frac{\partial f/\partial x}{\partial f/\partial y}\right) = -1$.

10. $z = z + f(u)$ and $u = xy \Rightarrow \frac{\partial z}{\partial x} = 1 + \frac{df}{du} \frac{\partial u}{\partial x} = 1 + y \frac{df}{du}$; also $\frac{\partial z}{\partial y} = 0 + \frac{df}{du} \frac{\partial u}{\partial y} = x \frac{df}{du}$ so that $x \frac{\partial z}{\partial x} - y \frac{\partial z}{\partial y}$
 $= x\left(1 + y \frac{df}{du}\right) - y\left(x \frac{df}{du}\right) = x$

11. If x and y are independent, then $g(x, y, z) = 0 \Rightarrow \frac{\partial g}{\partial x} \frac{\partial x}{\partial y} + \frac{\partial g}{\partial y} \frac{\partial y}{\partial y} + \frac{\partial g}{\partial z} \frac{\partial z}{\partial y} = 0$ and $\frac{\partial x}{\partial y} = 0 \Rightarrow \frac{\partial g}{\partial y} + \frac{\partial g}{\partial z} \frac{\partial z}{\partial y} = 0$
 $\Rightarrow \left(\frac{\partial z}{\partial y}\right)_x = -\frac{\partial g/\partial y}{\partial g/\partial z}$, as claimed.

12. Let x and y be independent. Then $f(x, y, z, w) = 0, g(x, y, z, w) = 0$ and $\frac{\partial y}{\partial x} = 0$
 $\Rightarrow \frac{\partial f}{\partial x} \frac{\partial x}{\partial x} + \frac{\partial f}{\partial y} \frac{\partial y}{\partial x} + \frac{\partial f}{\partial z} \frac{\partial z}{\partial x} + \frac{\partial f}{\partial w} \frac{\partial w}{\partial x} = \frac{\partial f}{\partial x} + \frac{\partial f}{\partial z} \frac{\partial z}{\partial x} + \frac{\partial f}{\partial w} \frac{\partial w}{\partial x} = 0$ and
 $\frac{\partial g}{\partial x} \frac{\partial x}{\partial x} + \frac{\partial g}{\partial y} \frac{\partial y}{\partial x} + \frac{\partial g}{\partial z} \frac{\partial z}{\partial x} + \frac{\partial g}{\partial w} \frac{\partial w}{\partial x} = \frac{\partial g}{\partial x} + \frac{\partial g}{\partial z} \frac{\partial z}{\partial x} + \frac{\partial g}{\partial w} \frac{\partial w}{\partial x} = 0$ imply
 $\begin{cases} \frac{\partial f}{\partial z} \frac{\partial z}{\partial x} + \frac{\partial f}{\partial w} \frac{\partial w}{\partial x} = -\frac{\partial f}{\partial x} \\ \frac{\partial g}{\partial z} \frac{\partial z}{\partial x} + \frac{\partial g}{\partial w} \frac{\partial w}{\partial x} = -\frac{\partial g}{\partial x} \end{cases} \Rightarrow \left(\frac{\partial z}{\partial x}\right)_y = \frac{\begin{vmatrix} -\frac{\partial f}{\partial x} & \frac{\partial f}{\partial w} \\ -\frac{\partial g}{\partial x} & \frac{\partial g}{\partial w} \end{vmatrix}}{\begin{vmatrix} \frac{\partial f}{\partial z} & \frac{\partial f}{\partial w} \\ \frac{\partial g}{\partial z} & \frac{\partial g}{\partial w} \end{vmatrix}} = \frac{-\frac{\partial f}{\partial x} \frac{\partial g}{\partial w} + \frac{\partial g}{\partial x} \frac{\partial f}{\partial w}}{\frac{\partial f}{\partial z} \frac{\partial g}{\partial w} - \frac{\partial g}{\partial z} \frac{\partial f}{\partial w}} = -\frac{\frac{\partial f}{\partial x} \frac{\partial g}{\partial w} - \frac{\partial g}{\partial x} \frac{\partial f}{\partial w}}{\frac{\partial f}{\partial z} \frac{\partial g}{\partial w} - \frac{\partial g}{\partial z} \frac{\partial f}{\partial w}}$, as claimed.

Likewise, $f(x, y, z, w) = 0, g(x, y, z, w) = 0$ and $\frac{\partial x}{\partial y} = 0 \Rightarrow \frac{\partial f}{\partial x} \frac{\partial x}{\partial y} + \frac{\partial f}{\partial y} \frac{\partial y}{\partial y} + \frac{\partial f}{\partial z} \frac{\partial z}{\partial y} + \frac{\partial f}{\partial w} \frac{\partial w}{\partial y}$
 $= \frac{\partial f}{\partial y} + \frac{\partial f}{\partial z} \frac{\partial z}{\partial y} + \frac{\partial f}{\partial w} \frac{\partial w}{\partial y} = 0$ and (similarly) $\frac{\partial g}{\partial y} + \frac{\partial g}{\partial z} \frac{\partial z}{\partial y} + \frac{\partial g}{\partial w} \frac{\partial w}{\partial y} = 0$ imply

$$\begin{cases} \frac{\partial f}{\partial z} \frac{\partial z}{\partial y} + \frac{\partial f}{\partial w} \frac{\partial w}{\partial y} = -\frac{\partial f}{\partial y} \\ \frac{\partial g}{\partial z} \frac{\partial z}{\partial y} + \frac{\partial g}{\partial w} \frac{\partial w}{\partial y} = -\frac{\partial g}{\partial y} \end{cases} \Rightarrow \left(\frac{\partial w}{\partial y}\right)_x = \frac{\begin{vmatrix} \frac{\partial f}{\partial z} & -\frac{\partial f}{\partial y} \\ \frac{\partial g}{\partial z} & -\frac{\partial g}{\partial y} \end{vmatrix}}{\begin{vmatrix} \frac{\partial f}{\partial z} & \frac{\partial f}{\partial w} \\ \frac{\partial g}{\partial z} & \frac{\partial g}{\partial w} \end{vmatrix}} = \frac{\frac{\partial f}{\partial z} \frac{\partial g}{\partial y} - \frac{\partial g}{\partial z} \frac{\partial f}{\partial y}}{\frac{\partial f}{\partial z} \frac{\partial g}{\partial w} - \frac{\partial g}{\partial z} \frac{\partial f}{\partial w}} = -\frac{\frac{\partial f}{\partial z} \frac{\partial g}{\partial y} - \frac{\partial g}{\partial z} \frac{\partial f}{\partial y}}{\frac{\partial f}{\partial z} \frac{\partial g}{\partial w} - \frac{\partial g}{\partial z} \frac{\partial f}{\partial w}}$$
, as claimed.

14.10 TAYLOR'S FORMULA FOR TWO VARIABLES

1. $f(x, y) = xe^y \Rightarrow f_x = e^y, f_y = xe^y, f_{xx} = 0, f_{xy} = e^y, f_{yy} = xe^y$
 $\Rightarrow f(x, y) \approx f(0, 0) + xf_x(0, 0) + yf_y(0, 0) + \frac{1}{2}[x^2f_{xx}(0, 0) + 2xyf_{xy}(0, 0) + y^2f_{yy}(0, 0)]$
 $= 0 + x \cdot 1 + y \cdot 0 + \frac{1}{2}(x^2 \cdot 0 + 2xy \cdot 1 + y^2 \cdot 0) = x + xy$ quadratic approximation;
 $f_{xxx} = 0, f_{xxy} = 0, f_{xyy} = e^y, f_{yyy} = xe^y$

$$\begin{aligned} &\Rightarrow f(x, y) \approx \text{quadratic} + \frac{1}{6} [x^3 f_{xxx}(0, 0) + 3x^2 y f_{xxy}(0, 0) + 3xy^2 f_{xyy}(0, 0) + y^3 f_{yyy}(0, 0)] \\ &= x + xy + \frac{1}{6} (x^3 \cdot 0 + 3x^2 y \cdot 0 + 3xy^2 \cdot 1 + y^3 \cdot 0) = x + xy + \frac{1}{2} xy^2, \text{ cubic approximation} \end{aligned}$$

$$\begin{aligned} 2. \quad f(x, y) = e^x \cos y &\Rightarrow f_x = e^x \cos y, f_y = -e^x \sin y, f_{xx} = e^x \cos y, f_{xy} = -e^x \sin y, f_{yy} = -e^x \cos y \\ &\Rightarrow f(x, y) \approx f(0, 0) + x f_x(0, 0) + y f_y(0, 0) + \frac{1}{2} [x^2 f_{xx}(0, 0) + 2xy f_{xy}(0, 0) + y^2 f_{yy}(0, 0)] \\ &= 1 + x \cdot 1 + y \cdot 0 + \frac{1}{2} [x^2 \cdot 1 + 2xy \cdot 0 + y^2 \cdot (-1)] = 1 + x + \frac{1}{2} (x^2 - y^2), \text{ quadratic approximation;} \end{aligned}$$

$$\begin{aligned} f_{xxx} &= e^x \cos y, f_{xxy} = -e^x \sin y, f_{xyy} = -e^x \cos y, f_{yyy} = e^x \sin y \\ &\Rightarrow f(x, y) \approx \text{quadratic} + \frac{1}{6} [x^3 f_{xxx}(0, 0) + 3x^2 y f_{xxy}(0, 0) + 3xy^2 f_{xyy}(0, 0) + y^3 f_{yyy}(0, 0)] \\ &= 1 + x + \frac{1}{2} (x^2 - y^2) + \frac{1}{6} [x^3 \cdot 1 + 3x^2 y \cdot 0 + 3xy^2 \cdot (-1) + y^3 \cdot 0] \\ &= 1 + x + \frac{1}{2} (x^2 - y^2) + \frac{1}{6} (x^3 - 3xy^2), \text{ cubic approximation} \end{aligned}$$

$$\begin{aligned} 3. \quad f(x, y) = y \sin x &\Rightarrow f_x = y \cos x, f_y = \sin x, f_{xx} = -y \sin x, f_{xy} = \cos x, f_{yy} = 0 \\ &\Rightarrow f(x, y) \approx f(0, 0) + x f_x(0, 0) + y f_y(0, 0) + \frac{1}{2} [x^2 f_{xx}(0, 0) + 2xy f_{xy}(0, 0) + y^2 f_{yy}(0, 0)] \\ &= 0 + x \cdot 0 + y \cdot 0 + \frac{1}{2} (x^2 \cdot 0 + 2xy \cdot 1 + y^2 \cdot 0) = xy, \text{ quadratic approximation;} \end{aligned}$$

$$\begin{aligned} f_{xxx} &= -y \cos x, f_{xxy} = -\sin x, f_{xyy} = 0, f_{yyy} = 0 \\ &\Rightarrow f(x, y) \approx \text{quadratic} + \frac{1}{6} [x^3 f_{xxx}(0, 0) + 3x^2 y f_{xxy}(0, 0) + 3xy^2 f_{xyy}(0, 0) + y^3 f_{yyy}(0, 0)] \\ &= xy + \frac{1}{6} (x^3 \cdot 0 + 3x^2 y \cdot 0 + 3xy^2 \cdot 0 + y^3 \cdot 0) = xy, \text{ cubic approximation} \end{aligned}$$

$$\begin{aligned} 4. \quad f(x, y) = \sin x \cos y &\Rightarrow f_x = \cos x \cos y, f_y = -\sin x \sin y, f_{xx} = -\sin x \cos y, f_{xy} = -\cos x \sin y, \\ f_{yy} &= -\sin x \cos y \Rightarrow f(x, y) \approx f(0, 0) + x f_x(0, 0) + y f_y(0, 0) + \frac{1}{2} [x^2 f_{xx}(0, 0) + 2xy f_{xy}(0, 0) + y^2 f_{yy}(0, 0)] \\ &= 0 + x \cdot 1 + y \cdot 0 + \frac{1}{2} (x^2 \cdot 0 + 2xy \cdot 0 + y^2 \cdot 0) = x, \text{ quadratic approximation;} \end{aligned}$$

$$\begin{aligned} f_{xxx} &= -\cos x \cos y, f_{xxy} = \sin x \sin y, f_{xyy} = -\cos x \cos y, f_{yyy} = \sin x \sin y \\ &\Rightarrow f(x, y) \approx \text{quadratic} + \frac{1}{6} [x^3 f_{xxx}(0, 0) + 3x^2 y f_{xxy}(0, 0) + 3xy^2 f_{xyy}(0, 0) + y^3 f_{yyy}(0, 0)] \\ &= x + \frac{1}{6} [x^3 \cdot (-1) + 3x^2 y \cdot 0 + 3xy^2 \cdot (-1) + y^3 \cdot 0] = x - \frac{1}{6} (x^3 + 3xy^2), \text{ cubic approximation} \end{aligned}$$

$$\begin{aligned} 5. \quad f(x, y) = e^x \ln(1 + y) &\Rightarrow f_x = e^x \ln(1 + y), f_y = \frac{e^x}{1 + y}, f_{xx} = e^x \ln(1 + y), f_{xy} = \frac{e^x}{1 + y}, f_{yy} = -\frac{e^x}{(1 + y)^2} \\ &\Rightarrow f(x, y) \approx f(0, 0) + x f_x(0, 0) + y f_y(0, 0) + \frac{1}{2} [x^2 f_{xx}(0, 0) + 2xy f_{xy}(0, 0) + y^2 f_{yy}(0, 0)] \\ &= 0 + x \cdot 0 + y \cdot 1 + \frac{1}{2} [x^2 \cdot 0 + 2xy \cdot 1 + y^2 \cdot (-1)] = y + \frac{1}{2} (2xy - y^2), \text{ quadratic approximation;} \end{aligned}$$

$$\begin{aligned} f_{xxx} &= e^x \ln(1 + y), f_{xxy} = \frac{e^x}{1 + y}, f_{xyy} = -\frac{e^x}{(1 + y)^2}, f_{yyy} = \frac{2e^x}{(1 + y)^3} \\ &\Rightarrow f(x, y) \approx \text{quadratic} + \frac{1}{6} [x^3 f_{xxx}(0, 0) + 3x^2 y f_{xxy}(0, 0) + 3xy^2 f_{xyy}(0, 0) + y^3 f_{yyy}(0, 0)] \\ &= y + \frac{1}{2} (2xy - y^2) + \frac{1}{6} [x^3 \cdot 0 + 3x^2 y \cdot 1 + 3xy^2 \cdot (-1) + y^3 \cdot 2] \\ &= y + \frac{1}{2} (2xy - y^2) + \frac{1}{6} (3x^2 y - 3xy^2 + 2y^3), \text{ cubic approximation} \end{aligned}$$

$$\begin{aligned} 6. \quad f(x, y) = \ln(2x + y + 1) &\Rightarrow f_x = \frac{2}{2x + y + 1}, f_y = \frac{1}{2x + y + 1}, f_{xx} = \frac{-4}{(2x + y + 1)^2}, f_{xy} = \frac{-2}{(2x + y + 1)^2}, \\ f_{yy} &= \frac{-1}{(2x + y + 1)^2} \Rightarrow f(x, y) \approx f(0, 0) + x f_x(0, 0) + y f_y(0, 0) + \frac{1}{2} [x^2 f_{xx}(0, 0) + 2xy f_{xy}(0, 0) + y^2 f_{yy}(0, 0)] \\ &= 0 + x \cdot 2 + y \cdot 1 + \frac{1}{2} [x^2 \cdot (-4) + 2xy \cdot (-2) + y^2 \cdot (-1)] = 2x + y + \frac{1}{2} (-4x^2 - 4xy - y^2) \\ &= (2x + y) - \frac{1}{2} (2x + y)^2, \text{ quadratic approximation;} \end{aligned}$$

$$\begin{aligned} f_{xxx} &= \frac{16}{(2x + y + 1)^3}, f_{xxy} = \frac{8}{(2x + y + 1)^3}, f_{xyy} = \frac{4}{(2x + y + 1)^3}, f_{yyy} = \frac{2}{(2x + y + 1)^3} \\ &\Rightarrow f(x, y) \approx \text{quadratic} + \frac{1}{6} [x^3 f_{xxx}(0, 0) + 3x^2 y f_{xxy}(0, 0) + 3xy^2 f_{xyy}(0, 0) + y^3 f_{yyy}(0, 0)] \\ &= (2x + y) - \frac{1}{2} (2x + y)^2 + \frac{1}{6} (x^3 \cdot 16 + 3x^2 y \cdot 8 + 3xy^2 \cdot 4 + y^3 \cdot 2) \\ &= (2x + y) - \frac{1}{2} (2x + y)^2 + \frac{1}{3} (8x^3 + 12x^2 y + 6xy^2 + y^2) \\ &= (2x + y) - \frac{1}{2} (2x + y)^2 + \frac{1}{3} (2x + y)^3, \text{ cubic approximation} \end{aligned}$$

$$\begin{aligned} 7. \quad f(x, y) = \sin(x^2 + y^2) &\Rightarrow f_x = 2x \cos(x^2 + y^2), f_y = 2y \cos(x^2 + y^2), f_{xx} = 2 \cos(x^2 + y^2) - 4x^2 \sin(x^2 + y^2), \\ f_{xy} &= -4xy \sin(x^2 + y^2), f_{yy} = 2 \cos(x^2 + y^2) - 4y^2 \sin(x^2 + y^2) \end{aligned}$$

$$\begin{aligned} &\Rightarrow f(x, y) \approx f(0, 0) + xf_x(0, 0) + yf_y(0, 0) + \frac{1}{2} [x^2 f_{xx}(0, 0) + 2xyf_{xy}(0, 0) + y^2 f_{yy}(0, 0)] \\ &= 0 + x \cdot 0 + y \cdot 0 + \frac{1}{2} (x^2 \cdot 2 + 2xy \cdot 0 + y^2 \cdot 2) = x^2 + y^2, \text{ quadratic approximation;} \\ f_{xxx} &= -12x \sin(x^2 + y^2) - 8x^3 \cos(x^2 + y^2), f_{xxy} = -4y \sin(x^2 + y^2) - 8x^2 y \cos(x^2 + y^2), \\ f_{xyy} &= -4x \sin(x^2 + y^2) - 8xy^2 \cos(x^2 + y^2), f_{yyy} = -12y \sin(x^2 + y^2) - 8y^3 \cos(x^2 + y^2) \\ &\Rightarrow f(x, y) \approx \text{quadratic} + \frac{1}{6} [x^3 f_{xxx}(0, 0) + 3x^2 y f_{xxy}(0, 0) + 3xy^2 f_{xyy}(0, 0) + y^3 f_{yyy}(0, 0)] \\ &= x^2 + y^2 + \frac{1}{6} (x^3 \cdot 0 + 3x^2 y \cdot 0 + 3xy^2 \cdot 0 + y^3 \cdot 0) = x^2 + y^2, \text{ cubic approximation} \end{aligned}$$

$$\begin{aligned} 8. f(x, y) &= \cos(x^2 + y^2) \Rightarrow f_x = -2x \sin(x^2 + y^2), f_y = -2y \sin(x^2 + y^2), \\ f_{xx} &= -2 \sin(x^2 + y^2) - 4x^2 \cos(x^2 + y^2), f_{xy} = -4xy \cos(x^2 + y^2), f_{yy} = -2 \sin(x^2 + y^2) - 4y^2 \cos(x^2 + y^2) \\ &\Rightarrow f(x, y) \approx f(0, 0) + xf_x(0, 0) + yf_y(0, 0) + \frac{1}{2} [x^2 f_{xx}(0, 0) + 2xyf_{xy}(0, 0) + y^2 f_{yy}(0, 0)] \\ &= 1 + x \cdot 0 + y \cdot 0 + \frac{1}{2} [x^2 \cdot 0 + 2xy \cdot 0 + y^2 \cdot 0] = 1, \text{ quadratic approximation;} \\ f_{xxx} &= -12x \cos(x^2 + y^2) + 8x^3 \sin(x^2 + y^2), f_{xxy} = -4y \cos(x^2 + y^2) + 8x^2 y \sin(x^2 + y^2), \\ f_{xyy} &= -4x \cos(x^2 + y^2) + 8xy^2 \sin(x^2 + y^2), f_{yyy} = -12y \cos(x^2 + y^2) + 8y^3 \sin(x^2 + y^2) \\ &\Rightarrow f(x, y) \approx \text{quadratic} + \frac{1}{6} [x^3 f_{xxx}(0, 0) + 3x^2 y f_{xxy}(0, 0) + 3xy^2 f_{xyy}(0, 0) + y^3 f_{yyy}(0, 0)] \\ &= 1 + \frac{1}{6} (x^3 \cdot 0 + 3x^2 y \cdot 0 + 3xy^2 \cdot 0 + y^3 \cdot 0) = 1, \text{ cubic approximation} \end{aligned}$$

$$\begin{aligned} 9. f(x, y) &= \frac{1}{1-x-y} \Rightarrow f_x = \frac{1}{(1-x-y)^2} = f_y, f_{xx} = \frac{2}{(1-x-y)^3} = f_{xy} = f_{yy} \\ &\Rightarrow f(x, y) \approx f(0, 0) + xf_x(0, 0) + yf_y(0, 0) + \frac{1}{2} [x^2 f_{xx}(0, 0) + 2xyf_{xy}(0, 0) + y^2 f_{yy}(0, 0)] \\ &= 1 + x \cdot 1 + y \cdot 1 + \frac{1}{2} (x^2 \cdot 2 + 2xy \cdot 2 + y^2 \cdot 2) = 1 + (x + y) + (x^2 + 2xy + y^2) \\ &= 1 + (x + y) + (x + y)^2, \text{ quadratic approximation;} f_{xxx} = \frac{6}{(1-x-y)^4} = f_{xxy} = f_{xyy} = f_{yyy} \\ &\Rightarrow f(x, y) \approx \text{quadratic} + \frac{1}{6} [x^3 f_{xxx}(0, 0) + 3x^2 y f_{xxy}(0, 0) + 3xy^2 f_{xyy}(0, 0) + y^3 f_{yyy}(0, 0)] \\ &= 1 + (x + y) + (x + y)^2 + \frac{1}{6} (x^3 \cdot 6 + 3x^2 y \cdot 6 + 3xy^2 \cdot 6 + y^3 \cdot 6) \\ &= 1 + (x + y) + (x + y)^2 + (x^3 + 3x^2 y + 3xy^2 + y^3) = 1 + (x + y) + (x + y)^2 + (x + y)^3, \text{ cubic approximation} \end{aligned}$$

$$\begin{aligned} 10. f(x, y) &= \frac{1}{1-x-y+xy} \Rightarrow f_x = \frac{1-y}{(1-x-y+xy)^2}, f_y = \frac{1-x}{(1-x-y+xy)^2}, f_{xx} = \frac{2(1-y)^2}{(1-x-y+xy)^3}, \\ f_{xy} &= \frac{1}{(1-x-y+xy)^2}, f_{yy} = \frac{2(1-x)^2}{(1-x-y+xy)^3} \\ &\Rightarrow f(x, y) \approx f(0, 0) + xf_x(0, 0) + yf_y(0, 0) + \frac{1}{2} [x^2 f_{xx}(0, 0) + 2xyf_{xy}(0, 0) + y^2 f_{yy}(0, 0)] \\ &= 1 + x \cdot 1 + y \cdot 1 + \frac{1}{2} (x^2 \cdot 2 + 2xy \cdot 1 + y^2 \cdot 2) = 1 + x + y + x^2 + xy + y^2, \text{ quadratic approximation;} \\ f_{xxx} &= \frac{6(1-y)^3}{(1-x-y+xy)^4}, f_{xxy} = \frac{[-4(1-x-y+xy) + 6(1-y)(1-x)](1-y)}{(1-x-y+xy)^4}, \\ f_{xyy} &= \frac{[-4(1-x-y+xy) + 6(1-x)(1-y)](1-x)}{(1-x-y+xy)^4}, f_{yyy} = \frac{6(1-x)^3}{(1-x-y+xy)^4} \\ &\Rightarrow f(x, y) \approx \text{quadratic} + \frac{1}{6} [x^3 f_{xxx}(0, 0) + 3x^2 y f_{xxy}(0, 0) + 3xy^2 f_{xyy}(0, 0) + y^3 f_{yyy}(0, 0)] \\ &= 1 + x + y + x^2 + xy + y^2 + \frac{1}{6} (x^3 \cdot 6 + 3x^2 y \cdot 2 + 3xy^2 \cdot 2 + y^3 \cdot 6) \\ &= 1 + x + y + x^2 + xy + y^2 + x^3 + x^2 y + xy^2 + y^3, \text{ cubic approximation} \end{aligned}$$

$$\begin{aligned} 11. f(x, y) &= \cos x \cos y \Rightarrow f_x = -\sin x \cos y, f_y = -\cos x \sin y, f_{xx} = -\cos x \cos y, f_{xy} = \sin x \sin y, \\ f_{yy} &= -\cos x \cos y \Rightarrow f(x, y) \approx f(0, 0) + xf_x(0, 0) + yf_y(0, 0) + \frac{1}{2} [x^2 f_{xx}(0, 0) + 2xyf_{xy}(0, 0) + y^2 f_{yy}(0, 0)] \\ &= 1 + x \cdot 0 + y \cdot 0 + \frac{1}{2} [x^2 \cdot (-1) + 2xy \cdot 0 + y^2 \cdot (-1)] = 1 - \frac{x^2}{2} - \frac{y^2}{2}, \text{ quadratic approximation.} \\ &\text{Since all partial derivatives of } f \text{ are products of sines and cosines, the absolute value of these derivatives is less than or equal to } 1 \\ &\Rightarrow E(x, y) \leq \frac{1}{6} [(0.1)^3 + 3(0.1)^3 + 3(0.1)^3 + 0.1^3] \leq 0.00134. \end{aligned}$$

$$\begin{aligned} 12. f(x, y) &= e^x \sin y \Rightarrow f_x = e^x \sin y, f_y = e^x \cos y, f_{xx} = e^x \sin y, f_{xy} = e^x \cos y, f_{yy} = -e^x \sin y \\ &\Rightarrow f(x, y) \approx f(0, 0) + xf_x(0, 0) + yf_y(0, 0) + \frac{1}{2} [x^2 f_{xx}(0, 0) + 2xyf_{xy}(0, 0) + y^2 f_{yy}(0, 0)] \\ &= 0 + x \cdot 0 + y \cdot 1 + \frac{1}{2} (x^2 \cdot 0 + 2xy \cdot 1 + y^2 \cdot 0) = y + xy, \text{ quadratic approximation.} \\ &\text{Now, } f_{xxx} = e^x \sin y, f_{xxy} = e^x \cos y, f_{xyy} = -e^x \sin y, \text{ and } f_{yyy} = -e^x \cos y. \text{ Since } |x| \leq 0.1, |e^x \sin y| \leq |e^{0.1} \sin 0.1| \approx 0.11 \text{ and } \\ &|e^x \cos y| \leq |e^{0.1} \cos 0.1| \approx 1.11. \text{ Therefore,} \end{aligned}$$

$$E(x, y) \leq \frac{1}{6} [(0.11)(0.1)^3 + 3(1.11)(0.1)^3 + 3(0.11)(0.1)^3 + (1.11)(0.1)^3] \leq 0.000814.$$

CHAPTER 14 PRACTICE EXERCISES

1. Domain: All points in the xy -plane
 Range: $z \geq 0$

Level curves are ellipses with major axis along the y -axis and minor axis along the x -axis.

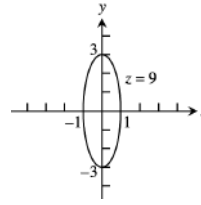

2. Domain: All points in the xy -plane
 Range: $0 < z < \infty$

Level curves are the straight lines $x + y = \ln z$ with slope -1 , and $z > 0$.

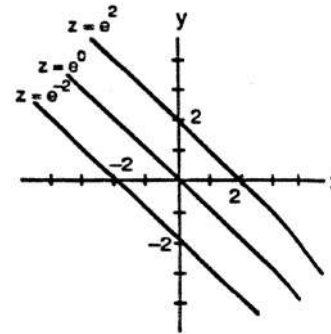

3. Domain: All (x, y) such that $x \neq 0$ and $y \neq 0$
 Range: $z \neq 0$

Level curves are hyperbolas with the x - and y -axes as asymptotes.

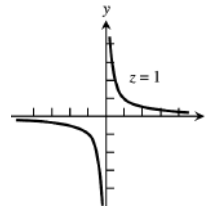

4. Domain: All (x, y) so that $x^2 - y \geq 0$
 Range: $z \geq 0$

Level curves are the parabolas $y = x^2 - c$, $c \geq 0$.

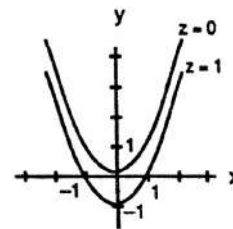

5. Domain: All points (x, y, z) in space
 Range: All real numbers

Level surfaces are paraboloids of revolution with the z -axis as axis.

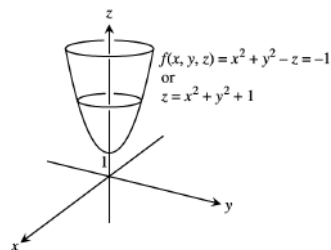

6. Domain: All points (x, y, z) in space
 Range: Nonnegative real numbers

Level surfaces are ellipsoids with center $(0, 0, 0)$.

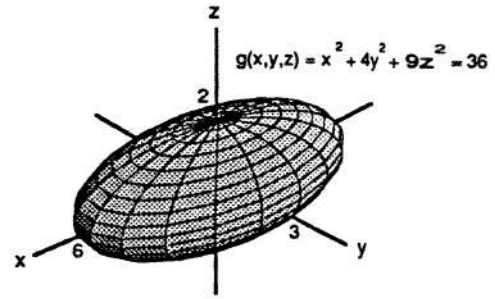

7. Domain: All (x, y, z) such that $(x, y, z) \neq (0, 0, 0)$
 Range: Positive real numbers

Level surfaces are spheres with center $(0, 0, 0)$ and radius $r > 0$.

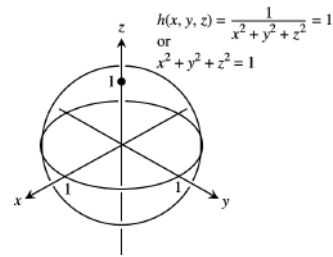

8. Domain: All points (x, y, z) in space
 Range: $(0, 1]$

Level surfaces are spheres with center $(0, 0, 0)$ and radius $r > 0$.

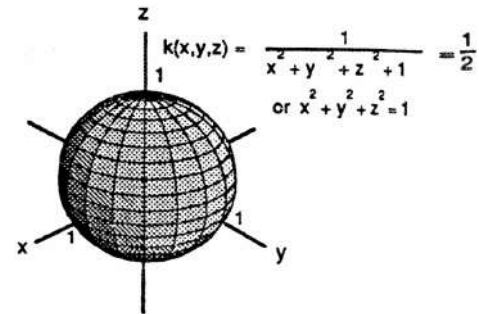

9. $\lim_{(x,y) \rightarrow (\pi, \ln 2)} e^y \cos x = e^{\ln 2} \cos \pi = (2)(-1) = -2$

10. $\lim_{(x,y) \rightarrow (0,0)} \frac{2+y}{x+\cos y} = \frac{2+0}{0+\cos 0} = 2$

11. $\lim_{\substack{(x,y) \rightarrow (1,1) \\ x \neq \pm y}} \frac{x-y}{x^2-y^2} = \lim_{\substack{(x,y) \rightarrow (1,1) \\ x \neq \pm y}} \frac{x-y}{(x-y)(x+y)} = \lim_{(x,y) \rightarrow (1,1)} \frac{1}{x+y} = \frac{1}{1+1} = \frac{1}{2}$

12. $\lim_{(x,y) \rightarrow (1,1)} \frac{x^3y^3-1}{xy-1} = \lim_{(x,y) \rightarrow (1,1)} \frac{(xy-1)(x^2y^2+xy+1)}{xy-1} = \lim_{(x,y) \rightarrow (1,1)} (x^2y^2+xy+1) = 1^2 \cdot 1^2 + 1 \cdot 1 + 1 = 3$

13. $P \rightarrow \lim_{(1,-1,e)} \ln |x+y+z| = \ln |1+(-1)+e| = \ln e = 1$

14. $P \rightarrow \lim_{(1,-1,-1)} \tan^{-1}(x+y+z) = \tan^{-1}(1+(-1)+(-1)) = \tan^{-1}(-1) = -\frac{\pi}{4}$

15. Let $y = kx^2, k \neq 1$. Then $\lim_{\substack{(x,y) \rightarrow (0,0) \\ y \neq x^2}} \frac{y}{x^2-y} = \lim_{(x,kx^2) \rightarrow (0,0)} \frac{kx^2}{x^2-kx^2} = \frac{k}{1-k^2}$ which gives different limits for different values of $k \Rightarrow$ the limit does not exist.

16. Let $y = kx, k \neq 0$. Then $\lim_{\substack{(x,y) \rightarrow (0,0) \\ xy \neq 0}} \frac{x^2+y^2}{xy} = \lim_{(x,kx) \rightarrow (0,0)} \frac{x^2+(kx)^2}{x(kx)} = \frac{1+k^2}{k}$ which gives different limits for

different values of $k \Rightarrow$ the limit does not exist.

17. Let $y = kx$. Then $\lim_{(x,y) \rightarrow (0,0)} \frac{x^2 - y^2}{x^2 + y^2} = \frac{x^2 - k^2x^2}{x^2 + k^2x^2} = \frac{1 - k^2}{1 + k^2}$ which gives different limits for different values of $k \Rightarrow$ the limit does not exist so $f(0, 0)$ cannot be defined in a way that makes f continuous at the origin.

18. Along the x -axis, $y = 0$ and $\lim_{(x,y) \rightarrow (0,0)} \frac{\sin(x-y)}{|x+y|} = \lim_{x \rightarrow 0} \frac{\sin x}{|x|} = \begin{cases} 1, & x > 0 \\ -1, & x < 0 \end{cases}$, so the limit fails to exist $\Rightarrow f$ is not continuous at $(0, 0)$.

$$19. \frac{\partial g}{\partial r} = \cos \theta + \sin \theta, \frac{\partial g}{\partial \theta} = -r \sin \theta + r \cos \theta$$

$$20. \frac{\partial f}{\partial x} = \frac{1}{2} \left(\frac{2x}{x^2 + y^2} \right) + \frac{\left(-\frac{y}{x^2} \right)}{1 + \left(\frac{y}{x} \right)^2} = \frac{x}{x^2 + y^2} - \frac{y}{x^2 + y^2} = \frac{x - y}{x^2 + y^2},$$

$$\frac{\partial f}{\partial y} = \frac{1}{2} \left(\frac{2y}{x^2 + y^2} \right) + \frac{\left(\frac{1}{x} \right)}{1 + \left(\frac{y}{x} \right)^2} = \frac{y}{x^2 + y^2} + \frac{x}{x^2 + y^2} = \frac{x + y}{x^2 + y^2}$$

$$21. \frac{\partial f}{\partial R_1} = -\frac{1}{R_1^2}, \frac{\partial f}{\partial R_2} = -\frac{1}{R_2^2}, \frac{\partial f}{\partial R_3} = -\frac{1}{R_3^2}$$

$$22. h_x(x, y, z) = 2\pi \cos(2\pi x + y - 3z), h_y(x, y, z) = \cos(2\pi x + y - 3z), h_z(x, y, z) = -3 \cos(2\pi x + y - 3z)$$

$$23. \frac{\partial P}{\partial n} = \frac{RT}{V}, \frac{\partial P}{\partial R} = \frac{nT}{V}, \frac{\partial P}{\partial T} = \frac{nR}{V}, \frac{\partial P}{\partial V} = -\frac{nRT}{V^2}$$

$$24. f_r(r, \ell, T, w) = -\frac{1}{2r^2\ell} \sqrt{\frac{T}{\pi w}}, f_\ell(r, \ell, T, w) = -\frac{1}{2r\ell^2} \sqrt{\frac{T}{\pi w}}, f_T(r, \ell, T, w) = \left(\frac{1}{2r\ell} \right) \left(\frac{1}{\sqrt{\pi w}} \right) \left(\frac{1}{2\sqrt{T}} \right)$$

$$= \frac{1}{4r\ell} \sqrt{\frac{1}{T\pi w}} = \frac{1}{4r\ell T} \sqrt{\frac{T}{\pi w}}, f_w(r, \ell, T, w) = \left(\frac{1}{2r\ell} \right) \sqrt{\frac{T}{\pi}} \left(-\frac{1}{2} w^{-3/2} \right) = -\frac{1}{4r\ell w} \sqrt{\frac{T}{\pi w}}$$

$$25. \frac{\partial g}{\partial x} = \frac{1}{y}, \frac{\partial g}{\partial y} = 1 - \frac{x}{y^2} \Rightarrow \frac{\partial^2 g}{\partial x^2} = 0, \frac{\partial^2 g}{\partial y^2} = \frac{2x}{y^3}, \frac{\partial^2 g}{\partial y \partial x} = \frac{\partial^2 g}{\partial x \partial y} = -\frac{1}{y^2}$$

$$26. g_x(x, y) = e^x + y \cos x, g_y(x, y) = \sin x \Rightarrow g_{xx}(x, y) = e^x - y \sin x, g_{yy}(x, y) = 0, g_{xy}(x, y) = g_{yx}(x, y) = \cos x$$

$$27. \frac{\partial f}{\partial x} = 1 + y - 15x^2 + \frac{2x}{x^2 + 1}, \frac{\partial f}{\partial y} = x \Rightarrow \frac{\partial^2 f}{\partial x^2} = -30x + \frac{2 - 2x^2}{(x^2 + 1)^2}, \frac{\partial^2 f}{\partial y^2} = 0, \frac{\partial^2 f}{\partial y \partial x} = \frac{\partial^2 f}{\partial x \partial y} = 1$$

$$28. f_x(x, y) = -3y, f_y(x, y) = 2y - 3x - \sin y + 7e^y \Rightarrow f_{xx}(x, y) = 0, f_{yy}(x, y) = 2 - \cos y + 7e^y, f_{xy}(x, y) = f_{yx}(x, y) = -3$$

$$29. \frac{\partial w}{\partial x} = y \cos(xy + \pi), \frac{\partial w}{\partial y} = x \cos(xy + \pi), \frac{dx}{dt} = e^t, \frac{dy}{dt} = \frac{1}{t+1}$$

$$\Rightarrow \frac{dw}{dt} = [y \cos(xy + \pi)]e^t + [x \cos(xy + \pi)] \left(\frac{1}{t+1} \right); t = 0 \Rightarrow x = 1 \text{ and } y = 0$$

$$\Rightarrow \left. \frac{dw}{dt} \right|_{t=0} = 0 \cdot 1 + [1 \cdot (-1)] \left(\frac{1}{0+1} \right) = -1$$

$$30. \frac{\partial w}{\partial x} = e^y, \frac{\partial w}{\partial y} = xe^y + \sin z, \frac{\partial w}{\partial z} = y \cos z + \sin z, \frac{dx}{dt} = t^{-1/2}, \frac{dy}{dt} = 1 + \frac{1}{t}, \frac{dz}{dt} = \pi$$

$$\Rightarrow \frac{dw}{dt} = e^y t^{-1/2} + (xe^y + \sin z) \left(1 + \frac{1}{t} \right) + (y \cos z + \sin z)\pi; t = 1 \Rightarrow x = 2, y = 0, \text{ and } z = \pi$$

$$\Rightarrow \left. \frac{dw}{dt} \right|_{t=1} = 1 \cdot 1 + (2 \cdot 1 - 0)(2) + (0 + 0)\pi = 5$$

$$31. \frac{\partial w}{\partial x} = 2 \cos(2x - y), \frac{\partial w}{\partial y} = -\cos(2x - y), \frac{\partial x}{\partial t} = 1, \frac{\partial x}{\partial s} = \cos s, \frac{\partial y}{\partial t} = s, \frac{\partial y}{\partial s} = r$$

$$\Rightarrow \frac{\partial w}{\partial t} = [2 \cos(2x - y)](1) + [-\cos(2x - y)](s); r = \pi \text{ and } s = 0 \Rightarrow x = \pi \text{ and } y = 0$$

$$\begin{aligned}\Rightarrow \frac{\partial w}{\partial r} \Big|_{(\pi,0)} &= (2 \cos 2\pi) - (\cos 2\pi)(0) = 2; \frac{\partial w}{\partial s} = [2 \cos(2x-y)](\cos s) + [-\cos(2x-y)](r) \\ \Rightarrow \frac{\partial w}{\partial s} \Big|_{(\pi,0)} &= (2 \cos 2\pi)(\cos 0) - (\cos 2\pi)(\pi) = 2 - \pi\end{aligned}$$

$$32. \frac{\partial w}{\partial u} = \frac{dw}{dx} \frac{\partial x}{\partial u} = \left(\frac{x}{1+x^2} - \frac{1}{x^2+1}\right) (2e^u \cos v); \mathbf{u} = \mathbf{v} = \mathbf{0} \Rightarrow x = 2 \Rightarrow \frac{\partial w}{\partial u} \Big|_{(0,0)} = \left(\frac{2}{5} - \frac{1}{5}\right) (2) = \frac{2}{5};$$

$$\frac{\partial w}{\partial v} = \frac{dw}{dx} \frac{\partial x}{\partial v} = \left(\frac{x}{1+x^2} - \frac{1}{x^2+1}\right) (-2e^u \sin v) \Rightarrow \frac{\partial w}{\partial v} \Big|_{(0,0)} = \left(\frac{2}{5} - \frac{1}{5}\right) (0) = 0$$

$$33. \frac{\partial f}{\partial x} = y + z, \frac{\partial f}{\partial y} = x + z, \frac{\partial f}{\partial z} = y + x, \frac{dx}{dt} = -\sin t, \frac{dy}{dt} = \cos t, \frac{dz}{dt} = -2 \sin 2t$$

$$\Rightarrow \frac{df}{dt} = -(y+z)(\sin t) + (x+z)(\cos t) - 2(y+x)(\sin 2t); t = 1 \Rightarrow x = \cos 1, y = \sin 1, \text{ and } z = \cos 2$$

$$\Rightarrow \frac{df}{dt} \Big|_{t=1} = -(\sin 1 + \cos 2)(\sin 1) + (\cos 1 + \cos 2)(\cos 1) - 2(\sin 1 + \cos 1)(\sin 2)$$

$$34. \frac{\partial w}{\partial x} = \frac{dw}{ds} \frac{\partial s}{\partial x} = (5) \frac{dw}{ds} \text{ and } \frac{\partial w}{\partial y} = \frac{dw}{ds} \frac{\partial s}{\partial y} = (1) \frac{dw}{ds} = \frac{dw}{ds} \Rightarrow \frac{\partial w}{\partial x} - 5 \frac{\partial w}{\partial y} = 5 \frac{dw}{ds} - 5 \frac{dw}{ds} = 0$$

$$35. F(x, y) = 1 - x - y^2 - \sin xy \Rightarrow F_x = -1 - y \cos xy \text{ and } F_y = -2y - x \cos xy \Rightarrow \frac{dy}{dx} = -\frac{F_x}{F_y} = -\frac{-1-y \cos xy}{-2y-x \cos xy}$$

$$= \frac{1+y \cos xy}{-2y-x \cos xy} \Rightarrow \text{at } (x, y) = (0, 1) \text{ we have } \frac{dy}{dx} \Big|_{(0,1)} = \frac{1+1}{-2} = -1$$

$$36. F(x, y) = 2xy + e^{x+y} - 2 \Rightarrow F_x = 2y + e^{x+y} \text{ and } F_y = 2x + e^{x+y} \Rightarrow \frac{dy}{dx} = -\frac{F_x}{F_y} = -\frac{2y+e^{x+y}}{2x+e^{x+y}}$$

$$\Rightarrow \text{at } (x, y) = (0, \ln 2) \text{ we have } \frac{dy}{dx} \Big|_{(0, \ln 2)} = -\frac{2 \ln 2 + 2}{0 + 2} = -(\ln 2 + 1)$$

$$37. \nabla f = (-\sin x \cos y)\mathbf{i} - (\cos x \sin y)\mathbf{j} \Rightarrow \nabla f \Big|_{\left(\frac{\pi}{4}, \frac{\pi}{4}\right)} = -\frac{1}{2}\mathbf{i} - \frac{1}{2}\mathbf{j} \Rightarrow |\nabla f| = \sqrt{\left(-\frac{1}{2}\right)^2 + \left(-\frac{1}{2}\right)^2} = \frac{1}{\sqrt{2}} = \frac{\sqrt{2}}{2};$$

$$\mathbf{u} = \frac{\nabla f}{|\nabla f|} = -\frac{\sqrt{2}}{2}\mathbf{i} - \frac{\sqrt{2}}{2}\mathbf{j} \Rightarrow f \text{ increases most rapidly in the direction } \mathbf{u} = -\frac{\sqrt{2}}{2}\mathbf{i} - \frac{\sqrt{2}}{2}\mathbf{j} \text{ and decreases most}$$

$$\text{rapidly in the direction } -\mathbf{u} = \frac{\sqrt{2}}{2}\mathbf{i} + \frac{\sqrt{2}}{2}\mathbf{j}; (D_{\mathbf{u}}f)_{P_0} = |\nabla f| = \frac{\sqrt{2}}{2} \text{ and } (D_{-\mathbf{u}}f)_{P_0} = -\frac{\sqrt{2}}{2};$$

$$\mathbf{u}_1 = \frac{\mathbf{v}}{|\mathbf{v}|} = \frac{3\mathbf{i}+4\mathbf{j}}{\sqrt{3^2+4^2}} = \frac{3}{5}\mathbf{i} + \frac{4}{5}\mathbf{j} \Rightarrow (D_{\mathbf{u}_1}f)_{P_0} = \nabla f \cdot \mathbf{u}_1 = \left(-\frac{1}{2}\right)\left(\frac{3}{5}\right) + \left(-\frac{1}{2}\right)\left(\frac{4}{5}\right) = -\frac{7}{10}$$

$$38. \nabla f = 2xe^{-2y}\mathbf{i} - 2x^2e^{-2y}\mathbf{j} \Rightarrow \nabla f \Big|_{(1,0)} = 2\mathbf{i} - 2\mathbf{j} \Rightarrow |\nabla f| = \sqrt{2^2 + (-2)^2} = 2\sqrt{2}; \mathbf{u} = \frac{\nabla f}{|\nabla f|} = \frac{1}{\sqrt{2}}\mathbf{i} - \frac{1}{\sqrt{2}}\mathbf{j}$$

$$\Rightarrow f \text{ increases most rapidly in the direction } \mathbf{u} = \frac{1}{\sqrt{2}}\mathbf{i} - \frac{1}{\sqrt{2}}\mathbf{j} \text{ and decreases most rapidly in the direction}$$

$$-\mathbf{u} = -\frac{1}{\sqrt{2}}\mathbf{i} + \frac{1}{\sqrt{2}}\mathbf{j}; (D_{\mathbf{u}}f)_{P_0} = |\nabla f| = 2\sqrt{2} \text{ and } (D_{-\mathbf{u}}f)_{P_0} = -2\sqrt{2}; \mathbf{u}_1 = \frac{\mathbf{v}}{|\mathbf{v}|} = \frac{\mathbf{i}+\mathbf{j}}{\sqrt{1^2+1^2}} = \frac{1}{\sqrt{2}}\mathbf{i} + \frac{1}{\sqrt{2}}\mathbf{j}$$

$$\Rightarrow (D_{\mathbf{u}_1}f)_{P_0} = \nabla f \cdot \mathbf{u}_1 = (2)\left(\frac{1}{\sqrt{2}}\right) + (-2)\left(\frac{1}{\sqrt{2}}\right) = 0$$

$$39. \nabla f = \left(\frac{2}{2x+3y+6z}\right)\mathbf{i} + \left(\frac{3}{2x+3y+6z}\right)\mathbf{j} + \left(\frac{6}{2x+3y+6z}\right)\mathbf{k} \Rightarrow \nabla f \Big|_{(-1,-1,1)} = 2\mathbf{i} + 3\mathbf{j} + 6\mathbf{k};$$

$$\mathbf{u} = \frac{\nabla f}{|\nabla f|} = \frac{2\mathbf{i}+3\mathbf{j}+6\mathbf{k}}{\sqrt{2^2+3^2+6^2}} = \frac{2}{7}\mathbf{i} + \frac{3}{7}\mathbf{j} + \frac{6}{7}\mathbf{k} \Rightarrow f \text{ increases most rapidly in the direction } \mathbf{u} = \frac{2}{7}\mathbf{i} + \frac{3}{7}\mathbf{j} + \frac{6}{7}\mathbf{k} \text{ and}$$

$$\text{decreases most rapidly in the direction } -\mathbf{u} = -\frac{2}{7}\mathbf{i} - \frac{3}{7}\mathbf{j} - \frac{6}{7}\mathbf{k}; (D_{\mathbf{u}}f)_{P_0} = |\nabla f| = 7, (D_{-\mathbf{u}}f)_{P_0} = -7;$$

$$\mathbf{u}_1 = \frac{\mathbf{v}}{|\mathbf{v}|} = \frac{2}{7}\mathbf{i} + \frac{3}{7}\mathbf{j} + \frac{6}{7}\mathbf{k} \Rightarrow (D_{\mathbf{u}_1}f)_{P_0} = (D_{\mathbf{u}}f)_{P_0} = 7$$

$$40. \nabla f = (2x+3y)\mathbf{i} + (3x+2)\mathbf{j} + (1-2z)\mathbf{k} \Rightarrow \nabla f \Big|_{(0,0,0)} = 2\mathbf{j} + \mathbf{k}; \mathbf{u} = \frac{\nabla f}{|\nabla f|} = \frac{2}{\sqrt{5}}\mathbf{j} + \frac{1}{\sqrt{5}}\mathbf{k} \Rightarrow f \text{ increases most}$$

$$\text{rapidly in the direction } \mathbf{u} = \frac{2}{\sqrt{5}}\mathbf{j} + \frac{1}{\sqrt{5}}\mathbf{k} \text{ and decreases most rapidly in the direction } -\mathbf{u} = -\frac{2}{\sqrt{5}}\mathbf{j} - \frac{1}{\sqrt{5}}\mathbf{k};$$

$$(D_{\mathbf{u}}f)_{P_0} = |\nabla f| = \sqrt{5} \text{ and } (D_{-\mathbf{u}}f)_{P_0} = -\sqrt{5}; \mathbf{u}_1 = \frac{\mathbf{v}}{|\mathbf{v}|} = \frac{\mathbf{i}+\mathbf{j}+\mathbf{k}}{\sqrt{1^2+1^2+1^2}} = \frac{1}{\sqrt{3}}\mathbf{i} + \frac{1}{\sqrt{3}}\mathbf{j} + \frac{1}{\sqrt{3}}\mathbf{k}$$

$$\Rightarrow (D_{\mathbf{u}_1}f)_{P_0} = \nabla f \cdot \mathbf{u}_1 = (0)\left(\frac{1}{\sqrt{3}}\right) + (2)\left(\frac{1}{\sqrt{3}}\right) + (1)\left(\frac{1}{\sqrt{3}}\right) = \frac{3}{\sqrt{3}} = \sqrt{3}$$

41. $\mathbf{r} = (\cos 3t)\mathbf{i} + (\sin 3t)\mathbf{j} + 3t\mathbf{k} \Rightarrow \mathbf{v}(t) = (-3 \sin 3t)\mathbf{i} + (3 \cos 3t)\mathbf{j} + 3\mathbf{k} \Rightarrow \mathbf{v}\left(\frac{\pi}{3}\right) = -3\mathbf{j} + 3\mathbf{k}$
 $\Rightarrow \mathbf{u} = -\frac{1}{\sqrt{2}}\mathbf{j} + \frac{1}{\sqrt{2}}\mathbf{k}; f(x, y, z) = xyz \Rightarrow \nabla f = yz\mathbf{i} + xz\mathbf{j} + xy\mathbf{k}; t = \frac{\pi}{3}$ yields the point on the helix $(-1, 0, \pi)$
 $\Rightarrow \nabla f|_{(-1,0,\pi)} = -\pi\mathbf{j} \Rightarrow \nabla f \cdot \mathbf{u} = (-\pi\mathbf{j}) \cdot \left(-\frac{1}{\sqrt{2}}\mathbf{j} + \frac{1}{\sqrt{2}}\mathbf{k}\right) = \frac{\pi}{\sqrt{2}}$

42. $f(x, y, z) = xyz \Rightarrow \nabla f = yz\mathbf{i} + xz\mathbf{j} + xy\mathbf{k};$ at $(1, 1, 1)$ we get $\nabla f = \mathbf{i} + \mathbf{j} + \mathbf{k} \Rightarrow$ the maximum value of $D_{\mathbf{u}}f|_{(1,1,1)} = |\nabla f| = \sqrt{3}$

43. (a) Let $\nabla f = a\mathbf{i} + b\mathbf{j}$ at $(1, 2)$. The direction toward $(2, 2)$ is determined by $\mathbf{v}_1 = (2 - 1)\mathbf{i} + (2 - 2)\mathbf{j} = \mathbf{i} = \mathbf{u}$ so that $\nabla f \cdot \mathbf{u} = 2 \Rightarrow a = 2$. The direction toward $(1, 1)$ is determined by $\mathbf{v}_2 = (1 - 1)\mathbf{i} + (1 - 2)\mathbf{j} = -\mathbf{j} = \mathbf{u}$ so that $\nabla f \cdot \mathbf{u} = -2 \Rightarrow -b = -2 \Rightarrow b = 2$. Therefore $\nabla f = 2\mathbf{i} + 2\mathbf{j}; f_x(1, 2) = f_y(1, 2) = 2$.
 (b) The direction toward $(4, 6)$ is determined by $\mathbf{v}_3 = (4 - 1)\mathbf{i} + (6 - 2)\mathbf{j} = 3\mathbf{i} + 4\mathbf{j} \Rightarrow \mathbf{u} = \frac{3}{5}\mathbf{i} + \frac{4}{5}\mathbf{j} \Rightarrow \nabla f \cdot \mathbf{u} = \frac{14}{5}$.

44. (a) True (b) False (c) True (d) True

45. $\nabla f = 2x\mathbf{i} + \mathbf{j} + 2z\mathbf{k} \Rightarrow$
 $\nabla f|_{(0,-1,-1)} = \mathbf{j} - 2\mathbf{k},$
 $\nabla f|_{(0,0,0)} = \mathbf{j},$
 $\nabla f|_{(0,-1,1)} = \mathbf{j} + 2\mathbf{k}$

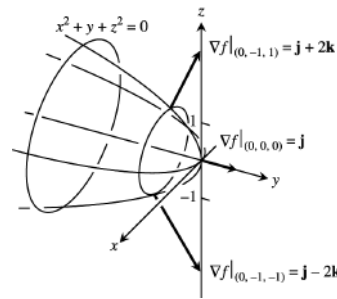

46. $\nabla f = 2y\mathbf{j} + 2z\mathbf{k} \Rightarrow$
 $\nabla f|_{(2,2,0)} = 4\mathbf{j},$
 $\nabla f|_{(2,-2,0)} = -4\mathbf{j},$
 $\nabla f|_{(2,0,2)} = 4\mathbf{k},$
 $\nabla f|_{(2,0,-2)} = -4\mathbf{k}$

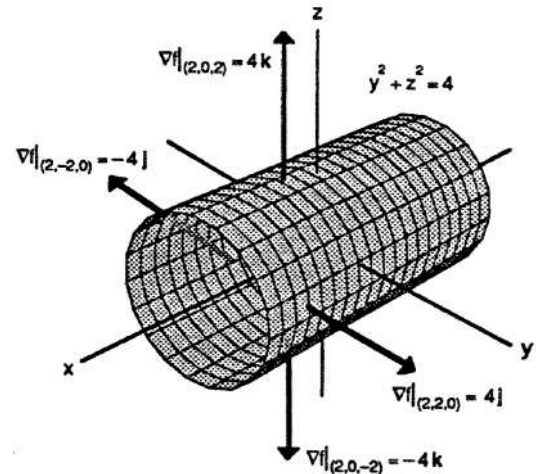

47. $\nabla f = 2x\mathbf{i} - \mathbf{j} - 5\mathbf{k} \Rightarrow \nabla f|_{(2,-1,1)} = 4\mathbf{i} - \mathbf{j} - 5\mathbf{k} \Rightarrow$ Tangent Plane: $4(x - 2) - (y + 1) - 5(z - 1) = 0$
 $\Rightarrow 4x - y - 5z = 4; \text{ Normal Line: } x = 2 + 4t, y = -1 - t, z = 1 - 5t$

48. $\nabla f = 2x\mathbf{i} + 2y\mathbf{j} + \mathbf{k} \Rightarrow \nabla f|_{(1,1,2)} = 2\mathbf{i} + 2\mathbf{j} + \mathbf{k} \Rightarrow$ Tangent Plane: $2(x - 1) + 2(y - 1) + (z - 2) = 0$
 $\Rightarrow 2x + 2y + z - 6 = 0; \text{ Normal Line: } x = 1 + 2t, y = 1 + 2t, z = 2 + t$

49. $\frac{\partial z}{\partial x} = \frac{2x}{x^2 + y^2} \Rightarrow \frac{\partial z}{\partial x}|_{(0,1,0)} = 0$ and $\frac{\partial z}{\partial y} = \frac{2y}{x^2 + y^2} \Rightarrow \frac{\partial z}{\partial y}|_{(0,1,0)} = 2;$ thus the tangent plane is $2(y - 1) - (z - 0) = 0$ or $2y - z - 2 = 0$

50. $\frac{\partial z}{\partial x} = -2x(x^2 + y^2)^{-2} \Rightarrow \frac{\partial z}{\partial x} \Big|_{(1,1,\frac{1}{2})} = -\frac{1}{2}$ and $\frac{\partial z}{\partial y} = -2y(x^2 + y^2)^{-2} \Rightarrow \frac{\partial z}{\partial y} \Big|_{(1,1,\frac{1}{2})} = -\frac{1}{2}$; thus the tangent plane is $-\frac{1}{2}(x-1) - \frac{1}{2}(y-1) - (z-\frac{1}{2}) = 0$ or $x + y + 2z - 3 = 0$

51. $\nabla f = (-\cos x)\mathbf{i} + \mathbf{j} \Rightarrow \nabla f|_{(\pi,1)} = \mathbf{i} + \mathbf{j} \Rightarrow$ the tangent line is $(x - \pi) + (y - 1) = 0 \Rightarrow x + y = \pi + 1$; the normal line is $y - 1 = 1(x - \pi) \Rightarrow y = x - \pi + 1$

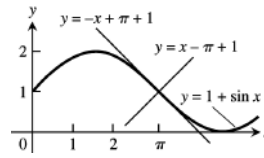

52. $\nabla f = -x\mathbf{i} + y\mathbf{j} \Rightarrow \nabla f|_{(1,2)} = -\mathbf{i} + 2\mathbf{j} \Rightarrow$ the tangent line is $-(x-1) + 2(y-2) = 0 \Rightarrow y = \frac{1}{2}x + \frac{3}{2}$; the normal line is $y - 2 = -2(x-1) \Rightarrow y = -2x + 4$

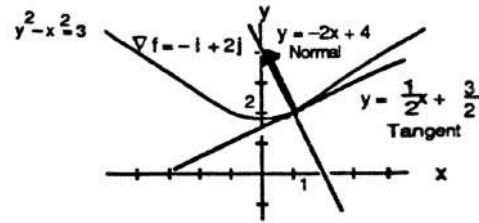

53. Let $f(x, y, z) = x^2 + 2y + 2z - 4$ and $g(x, y, z) = y - 1$. Then $\nabla f = 2x\mathbf{i} + 2\mathbf{j} + 2\mathbf{k}|_{(1,1,\frac{1}{2})} = 2\mathbf{i} + 2\mathbf{j} + 2\mathbf{k}$

and $\nabla g = \mathbf{j} \Rightarrow \nabla f \times \nabla g = \begin{vmatrix} \mathbf{i} & \mathbf{j} & \mathbf{k} \\ 2 & 2 & 2 \\ 0 & 1 & 0 \end{vmatrix} = -2\mathbf{i} + 2\mathbf{k} \Rightarrow$ the line is $x = 1 - 2t, y = 1, z = \frac{1}{2} + 2t$

54. Let $f(x, y, z) = x + y^2 + z - 2$ and $g(x, y, z) = y - 1$. Then $\nabla f = \mathbf{i} + 2y\mathbf{j} + \mathbf{k}|_{(\frac{1}{2},1,\frac{1}{2})} = \mathbf{i} + 2\mathbf{j} + \mathbf{k}$ and

$\nabla g = \mathbf{j} \Rightarrow \nabla f \times \nabla g = \begin{vmatrix} \mathbf{i} & \mathbf{j} & \mathbf{k} \\ 1 & 2 & 1 \\ 0 & 1 & 0 \end{vmatrix} = -\mathbf{i} + \mathbf{k} \Rightarrow$ the line is $x = \frac{1}{2} - t, y = 1, z = \frac{1}{2} + t$

55. $f(\frac{\pi}{4}, \frac{\pi}{4}) = \frac{1}{2}, f_x(\frac{\pi}{4}, \frac{\pi}{4}) = \cos x \cos y|_{(\pi/4, \pi/4)} = \frac{1}{2}, f_y(\frac{\pi}{4}, \frac{\pi}{4}) = -\sin x \sin y|_{(\pi/4, \pi/4)} = -\frac{1}{2}$
 $\Rightarrow L(x, y) = \frac{1}{2} + \frac{1}{2}(x - \frac{\pi}{4}) - \frac{1}{2}(y - \frac{\pi}{4}) = \frac{1}{2} + \frac{1}{2}x - \frac{1}{2}y; f_{xx}(x, y) = -\sin x \cos y, f_{yy}(x, y) = -\sin x \cos y,$ and $f_{xy}(x, y) = -\cos x \sin y$. Thus an upper bound for E depends on the bound M used for $|f_{xx}|, |f_{yy}|,$ and $|f_{xy}|$.

With $M = \frac{\sqrt{2}}{2}$ we have $|E(x, y)| \leq \frac{1}{2} \left(\frac{\sqrt{2}}{2}\right) (|x - \frac{\pi}{4}| + |y - \frac{\pi}{4}|)^2 \leq \frac{\sqrt{2}}{4} (0.2)^2 \leq 0.0142;$

with $M = 1, |E(x, y)| \leq \frac{1}{2} (1) (|x - \frac{\pi}{4}| + |y - \frac{\pi}{4}|)^2 = \frac{1}{2} (0.2)^2 = 0.02$.

56. $f(1, 1) = 0, f_x(1, 1) = y|_{(1,1)} = 1, f_y(1, 1) = x - 6y|_{(1,1)} = -5 \Rightarrow L(x, y) = (x - 1) - 5(y - 1) = x - 5y + 4;$

$f_{xx}(x, y) = 0, f_{yy}(x, y) = -6,$ and $f_{xy}(x, y) = 1 \Rightarrow$ maximum of $|f_{xx}|, |f_{yy}|,$ and $|f_{xy}|$ is 6 $\Rightarrow M = 6$

$\Rightarrow |E(x, y)| \leq \frac{1}{2} (6) (|x - 1| + |y - 1|)^2 = \frac{1}{2} (6)(0.1 + 0.2)^2 = 0.27$

57. $f(1, 0, 0) = 0, f_x(1, 0, 0) = y - 3z|_{(1,0,0)} = 0, f_y(1, 0, 0) = x + 2z|_{(1,0,0)} = 1, f_z(1, 0, 0) = 2y - 3x|_{(1,0,0)} = -3$

$\Rightarrow L(x, y, z) = 0(x - 1) + (y - 0) - 3(z - 0) = y - 3z; f(1, 1, 0) = 1, f_x(1, 1, 0) = 1, f_y(1, 1, 0) = 1, f_z(1, 1, 0) = -1$

$\Rightarrow L(x, y, z) = 1 + (x - 1) + (y - 1) - 1(z - 0) = x + y - z - 1$

58. $f(0, 0, \frac{\pi}{4}) = 1, f_x(0, 0, \frac{\pi}{4}) = -\sqrt{2} \sin x \sin(y + z)|_{(0,0,\pi/4)} = 0, f_y(0, 0, \frac{\pi}{4}) = \sqrt{2} \cos x \cos(y + z)|_{(0,0,\pi/4)} = 1,$

$f_z(0, 0, \frac{\pi}{4}) = \sqrt{2} \cos x \cos(y + z)|_{(0,0,\pi/4)} = 1 \Rightarrow L(x, y, z) = 1 + 1(y - 0) + 1(z - \frac{\pi}{4}) = 1 + y + z - \frac{\pi}{4};$

$f(\frac{\pi}{4}, \frac{\pi}{4}, 0) = \frac{\sqrt{2}}, f_x(\frac{\pi}{4}, \frac{\pi}{4}, 0) = -\frac{\sqrt{2}}, f_y(\frac{\pi}{4}, \frac{\pi}{4}, 0) = \frac{\sqrt{2}}, f_z(\frac{\pi}{4}, \frac{\pi}{4}, 0) = \frac{\sqrt{2}}$

$\Rightarrow L(x, y, z) = \frac{\sqrt{2}}{2} - \frac{\sqrt{2}}{2}(x - \frac{\pi}{4}) + \frac{\sqrt{2}}{2}(y - \frac{\pi}{4}) + \frac{\sqrt{2}}{2}(z - 0) = \frac{\sqrt{2}}{2} - \frac{\sqrt{2}}{2}x + \frac{\sqrt{2}}{2}y + \frac{\sqrt{2}}{2}z$

59. $V = \pi r^2 h \Rightarrow dV = 2\pi r h dr + \pi r^2 dh \Rightarrow dV|_{(1.5, 5280)} = 2\pi(1.5)(5280) dr + \pi(1.5)^2 dh = 15,840\pi dr + 2.25\pi dh$.
You should be more careful with the diameter since it has a greater effect on dV .

60. $df = (2x - y) dx + (-x + 2y) dy \Rightarrow df|_{(1,2)} = 3 dy \Rightarrow f$ is more sensitive to changes in y ; in fact, near the point $(1, 2)$ a change in x does not change f .

61. $dI = \frac{1}{R} dV - \frac{V}{R^2} dR \Rightarrow dI|_{(24,100)} = \frac{1}{100} dV - \frac{24}{100^2} dR \Rightarrow dI|_{dV=-1, dR=-20} = -0.01 + (480)(.0001) = 0.038$,
or increases by 0.038 amps; % change in $V = (100) \left(-\frac{1}{24}\right) \approx -4.17\%$; % change in $R = \left(-\frac{20}{100}\right) (100) = -20\%$;
 $I = \frac{24}{100} = 0.24 \Rightarrow$ estimated % change in $I = \frac{dI}{I} \times 100 = \frac{0.038}{0.24} \times 100 \approx 15.83\% \Rightarrow$ more sensitive to voltage change.

62. $A = \pi ab \Rightarrow dA = \pi b da + \pi a db \Rightarrow dA|_{(10,16)} = 16\pi da + 10\pi db$; $da = \pm 0.1$ and $db = \pm 0.1$
 $\Rightarrow dA = \pm 26\pi(0.1) = \pm 2.6\pi$ and $A = \pi(10)(16) = 160\pi \Rightarrow \left|\frac{dA}{A} \times 100\right| = \left|\frac{2.6\pi}{160\pi} \times 100\right| \approx 1.625\%$

63. (a) $y = uv \Rightarrow dy = v du + u dv$; percentage change in $u \leq 2\% \Rightarrow |du| \leq 0.02$, and percentage change in $v \leq 3\%$
 $\Rightarrow |dv| \leq 0.03$; $\frac{dy}{y} = \frac{v du + u dv}{uv} = \frac{du}{u} + \frac{dv}{v} \Rightarrow \left|\frac{dy}{y} \times 100\right| = \left|\frac{du}{u} \times 100 + \frac{dv}{v} \times 100\right| \leq \left|\frac{du}{u} \times 100\right| + \left|\frac{dv}{v} \times 100\right|$
 $\leq 2\% + 3\% = 5\%$

(b) $z = u + v \Rightarrow \frac{dz}{z} = \frac{du + dv}{u + v} = \frac{du}{u + v} + \frac{dv}{u + v} \leq \frac{du}{u} + \frac{dv}{v}$ (since $u > 0, v > 0$)
 $\Rightarrow \left|\frac{dz}{z} \times 100\right| \leq \left|\frac{du}{u} \times 100 + \frac{dv}{v} \times 100\right| = \left|\frac{dz}{z} \times 100\right|$

64. $C = \frac{7}{71.84w^{0.425}h^{0.725}} \Rightarrow C_w = \frac{(-0.425)(7)}{71.84w^{1.425}h^{0.725}}$ and $C_h = \frac{(-0.725)(7)}{71.84w^{0.425}h^{1.725}}$
 $\Rightarrow dC = \frac{-2.975}{71.84w^{1.425}h^{0.725}} dw + \frac{-5.075}{71.84w^{0.425}h^{1.725}} dh$; thus when $w = 70$ and $h = 180$ we have
 $dC|_{(70,180)} \approx -(0.00000225) dw - (0.00000149) dh \Rightarrow$ 1 kg error in weight has more effect

65. $f_x(x, y) = 2x - y + 2 = 0$ and $f_y(x, y) = -x + 2y + 2 = 0 \Rightarrow x = -2$ and $y = -2 \Rightarrow (-2, -2)$ is the critical point;
 $f_{xx}(-2, -2) = 2, f_{yy}(-2, -2) = 2, f_{xy}(-2, -2) = -1 \Rightarrow f_{xx}f_{yy} - f_{xy}^2 = 3 > 0$ and $f_{xx} > 0 \Rightarrow$ local minimum value
of $f(-2, -2) = -8$

66. $f_x(x, y) = 10x + 4y + 4 = 0$ and $f_y(x, y) = 4x - 4y - 4 = 0 \Rightarrow x = 0$ and $y = -1 \Rightarrow (0, -1)$ is the critical point;
 $f_{xx}(0, -1) = 10, f_{yy}(0, -1) = -4, f_{xy}(0, -1) = 4 \Rightarrow f_{xx}f_{yy} - f_{xy}^2 = -56 < 0 \Rightarrow$ saddle point with $f(0, -1) = 2$

67. $f_x(x, y) = 6x^2 + 3y = 0$ and $f_y(x, y) = 3x + 6y^2 = 0 \Rightarrow y = -2x^2$ and $3x + 6(4x^4) = 0 \Rightarrow x(1 + 8x^3) = 0$
 $\Rightarrow x = 0$ and $y = 0$, or $x = -\frac{1}{2}$ and $y = -\frac{1}{2} \Rightarrow$ the critical points are $(0, 0)$ and $(-\frac{1}{2}, -\frac{1}{2})$. For $(0, 0)$:
 $f_{xx}(0, 0) = 12x|_{(0,0)} = 0, f_{yy}(0, 0) = 12y|_{(0,0)} = 0, f_{xy}(0, 0) = 3 \Rightarrow f_{xx}f_{yy} - f_{xy}^2 = -9 < 0 \Rightarrow$ saddle point with
 $f(0, 0) = 0$. For $(-\frac{1}{2}, -\frac{1}{2})$: $f_{xx} = -6, f_{yy} = -6, f_{xy} = 3 \Rightarrow f_{xx}f_{yy} - f_{xy}^2 = 27 > 0$ and $f_{xx} < 0 \Rightarrow$ local maximum
value of $f(-\frac{1}{2}, -\frac{1}{2}) = \frac{1}{4}$

68. $f_x(x, y) = 3x^2 - 3y = 0$ and $f_y(x, y) = 3y^2 - 3x = 0 \Rightarrow y = x^2$ and $x^4 - x = 0 \Rightarrow x(x^3 - 1) = 0 \Rightarrow$ the critical
points are $(0, 0)$ and $(1, 1)$. For $(0, 0)$: $f_{xx}(0, 0) = 6x|_{(0,0)} = 0, f_{yy}(0, 0) = 6y|_{(0,0)} = 0, f_{xy}(0, 0) = -3$
 $\Rightarrow f_{xx}f_{yy} - f_{xy}^2 = -9 < 0 \Rightarrow$ saddle point with $f(0, 0) = 15$. For $(1, 1)$: $f_{xx}(1, 1) = 6, f_{yy}(1, 1) = 6, f_{xy}(1, 1) = -3$
 $\Rightarrow f_{xx}f_{yy} - f_{xy}^2 = 27 > 0$ and $f_{xx} > 0 \Rightarrow$ local minimum value of $f(1, 1) = 14$

69. $f_x(x, y) = 3x^2 + 6x = 0$ and $f_y(x, y) = 3y^2 - 6y = 0 \Rightarrow x(x + 2) = 0$ and $y(y - 2) = 0 \Rightarrow x = 0$ or $x = -2$ and
 $y = 0$ or $y = 2 \Rightarrow$ the critical points are $(0, 0), (0, 2), (-2, 0)$, and $(-2, 2)$. For $(0, 0)$: $f_{xx}(0, 0) = 6x + 6|_{(0,0)}$
 $= 6, f_{yy}(0, 0) = 6y - 6|_{(0,0)} = -6, f_{xy}(0, 0) = 0 \Rightarrow f_{xx}f_{yy} - f_{xy}^2 = -36 < 0 \Rightarrow$ saddle point with $f(0, 0) = 0$. For
 $(0, 2)$: $f_{xx}(0, 2) = 6, f_{yy}(0, 2) = 6, f_{xy}(0, 2) = 0 \Rightarrow f_{xx}f_{yy} - f_{xy}^2 = 36 > 0$ and $f_{xx} > 0 \Rightarrow$ local minimum value of

$f(0, 2) = -4$. For $(-2, 0)$: $f_{xx}(-2, 0) = -6$, $f_{yy}(-2, 0) = -6$, $f_{xy}(-2, 0) = 0 \Rightarrow f_{xx}f_{yy} - f_{xy}^2 = 36 > 0$ and $f_{xx} < 0$
 \Rightarrow local maximum value of $f(-2, 0) = 4$. For $(-2, 2)$: $f_{xx}(-2, 2) = -6$, $f_{yy}(-2, 2) = 6$, $f_{xy}(-2, 2) = 0$
 $\Rightarrow f_{xx}f_{yy} - f_{xy}^2 = -36 < 0 \Rightarrow$ saddle point with $f(-2, 2) = 0$.

70. $f_x(x, y) = 4x^3 - 16x = 0 \Rightarrow 4x(x^2 - 4) = 0 \Rightarrow x = 0, 2, -2$; $f_y(x, y) = 6y - 6 = 0 \Rightarrow y = 1$. Therefore the critical points are $(0, 1)$, $(2, 1)$, and $(-2, 1)$. For $(0, 1)$: $f_{xx}(0, 1) = 12x^2 - 16|_{(0,1)} = -16$, $f_{yy}(0, 1) = 6$, $f_{xy}(0, 1) = 0$
 $\Rightarrow f_{xx}f_{yy} - f_{xy}^2 = -96 < 0 \Rightarrow$ saddle point with $f(0, 1) = -3$. For $(2, 1)$: $f_{xx}(2, 1) = 32$, $f_{yy}(2, 1) = 6$, $f_{xy}(2, 1) = 0 \Rightarrow f_{xx}f_{yy} - f_{xy}^2 = 192 > 0$ and $f_{xx} > 0 \Rightarrow$ local minimum value of $f(2, 1) = -19$. For $(-2, 1)$: $f_{xx}(-2, 1) = 32$, $f_{yy}(-2, 1) = 6$, $f_{xy}(-2, 1) = 0 \Rightarrow f_{xx}f_{yy} - f_{xy}^2 = 192 > 0$ and $f_{xx} > 0 \Rightarrow$ local minimum value of $f(-2, 1) = -19$.

71. (i) On OA, $f(x, y) = f(0, y) = y^2 + 3y$ for $0 \leq y \leq 4$
 $\Rightarrow f'(0, y) = 2y + 3 = 0 \Rightarrow y = -\frac{3}{2}$. But $(0, -\frac{3}{2})$ is not in the region.

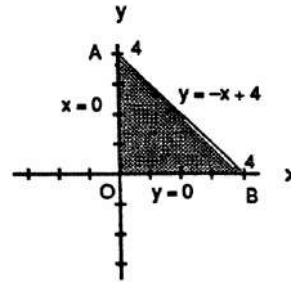

Endpoints: $f(0, 0) = 0$ and $f(0, 4) = 28$.

(ii) On AB, $f(x, y) = f(x, -x + 4) = x^2 - 10x + 28$ for $0 \leq x \leq 4 \Rightarrow f'(x, -x + 4) = 2x - 10 = 0$
 $\Rightarrow x = 5, y = -1$. But $(5, -1)$ is not in the region.

Endpoints: $f(4, 0) = 4$ and $f(0, 4) = 28$.

(iii) On OB, $f(x, y) = f(x, 0) = x^2 - 3x$ for $0 \leq x \leq 4 \Rightarrow f'(x, 0) = 2x - 3 \Rightarrow x = \frac{3}{2}$ and $y = 0 \Rightarrow (\frac{3}{2}, 0)$ is a critical point with $f(\frac{3}{2}, 0) = -\frac{9}{4}$.
 Endpoints: $f(0, 0) = 0$ and $f(4, 0) = 4$.

(iv) For the interior of the triangular region, $f_x(x, y) = 2x + y - 3 = 0$ and $f_y(x, y) = x + 2y + 3 = 0 \Rightarrow x = 3$ and $y = -3$. But $(3, -3)$ is not in the region. Therefore the absolute maximum is 28 at $(0, 4)$ and the absolute minimum is $-\frac{9}{4}$ at $(\frac{3}{2}, 0)$.

72. (i) On OA, $f(x, y) = f(0, y) = -y^2 + 4y + 1$ for $0 \leq y \leq 2 \Rightarrow f'(0, y) = -2y + 4 = 0 \Rightarrow y = 2$ and $x = 0$. But $(0, 2)$ is not in the interior of OA.
 Endpoints: $f(0, 0) = 1$ and $f(0, 2) = 5$.

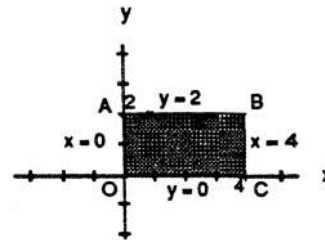

(ii) On AB, $f(x, y) = f(x, 2) = x^2 - 2x + 5$ for $0 \leq x \leq 4$
 $\Rightarrow f'(x, 2) = 2x - 2 = 0 \Rightarrow x = 1$ and $y = 2$
 $\Rightarrow (1, 2)$ is an interior critical point of AB with $f(1, 2) = 4$. Endpoints: $f(4, 2) = 13$ and $f(0, 2) = 5$.

(iii) On BC, $f(x, y) = f(4, y) = -y^2 + 4y + 9$ for $0 \leq y \leq 2 \Rightarrow f'(4, y) = -2y + 4 = 0 \Rightarrow y = 2$ and $x = 4$. But $(4, 2)$ is not in the interior of BC. Endpoints: $f(4, 0) = 9$ and $f(4, 2) = 13$.

(iv) On OC, $f(x, y) = f(x, 0) = x^2 - 2x + 1$ for $0 \leq x \leq 4 \Rightarrow f'(x, 0) = 2x - 2 = 0 \Rightarrow x = 1$ and $y = 0 \Rightarrow (1, 0)$ is an interior critical point of OC with $f(1, 0) = 0$. Endpoints: $f(0, 0) = 1$ and $f(4, 0) = 9$.

(v) For the interior of the rectangular region, $f_x(x, y) = 2x - 2 = 0$ and $f_y(x, y) = -2y + 4 = 0 \Rightarrow x = 1$ and $y = 2$. But $(1, 2)$ is not in the interior of the region. Therefore the absolute maximum is 13 at $(4, 2)$ and the absolute minimum is 0 at $(1, 0)$.

73. (i) On AB, $f(x, y) = f(-2, y) = y^2 - y - 4$ for $-2 \leq y \leq 2 \Rightarrow f'(-2, y) = 2y - 1 \Rightarrow y = \frac{1}{2}$ and $x = -2 \Rightarrow (-2, \frac{1}{2})$ is an interior critical point in AB with $f(-2, \frac{1}{2}) = -\frac{17}{4}$. Endpoints: $f(-2, -2) = 2$ and $f(2, 2) = -2$.

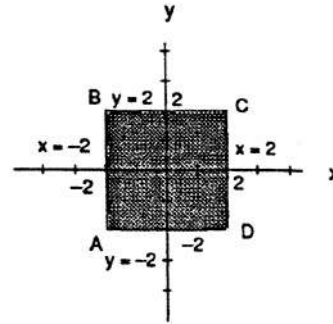

- (ii) On BC, $f(x, y) = f(x, 2) = -2$ for $-2 \leq x \leq 2 \Rightarrow f'(x, 2) = 0 \Rightarrow$ no critical points in the interior of BC. Endpoints: $f(-2, 2) = -2$ and $f(2, 2) = -2$.
- (iii) On CD, $f(x, y) = f(2, y) = y^2 - 5y + 4$ for $-2 \leq y \leq 2 \Rightarrow f'(2, y) = 2y - 5 = 0 \Rightarrow y = \frac{5}{2}$ and $x = 2$. But $(2, \frac{5}{2})$ is not in the region. Endpoints: $f(2, -2) = 18$ and $f(2, 2) = -2$.
- (iv) On AD, $f(x, y) = f(x, -2) = 4x + 10$ for $-2 \leq x \leq 2 \Rightarrow f'(x, -2) = 4 \Rightarrow$ no critical points in the interior of AD. Endpoints: $f(-2, -2) = 2$ and $f(2, -2) = 18$.
- (v) For the interior of the square, $f_x(x, y) = -y + 2 = 0$ and $f_y(x, y) = 2y - x - 3 = 0 \Rightarrow y = 2$ and $x = 1 \Rightarrow (1, 2)$ is an interior critical point of the square with $f(1, 2) = -2$. Therefore the absolute maximum is 18 at $(2, -2)$ and the absolute minimum is $-\frac{17}{4}$ at $(-2, \frac{1}{2})$.

74. (i) On OA, $f(x, y) = f(0, y) = 2y - y^2$ for $0 \leq y \leq 2 \Rightarrow f'(0, y) = 2 - 2y = 0 \Rightarrow y = 1$ and $x = 0 \Rightarrow (0, 1)$ is an interior critical point of OA with $f(0, 1) = 1$. Endpoints: $f(0, 0) = 0$ and $f(0, 2) = 0$.

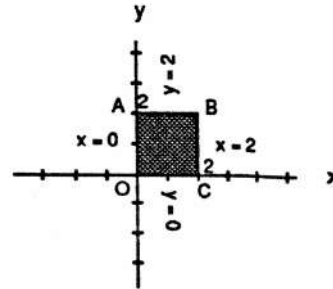

- (ii) On AB, $f(x, y) = f(x, 2) = 2x - x^2$ for $0 \leq x \leq 2 \Rightarrow f'(x, 2) = 2 - 2x = 0 \Rightarrow x = 1$ and $y = 2 \Rightarrow (1, 2)$ is an interior critical point of AB with $f(1, 2) = 1$. Endpoints: $f(0, 2) = 0$ and $f(2, 2) = 0$.
- (iii) On BC, $f(x, y) = f(2, y) = 2y - y^2$ for $0 \leq y \leq 2 \Rightarrow f'(2, y) = 2 - 2y = 0 \Rightarrow y = 1$ and $x = 2 \Rightarrow (2, 1)$ is an interior critical point of BC with $f(2, 1) = 1$. Endpoints: $f(2, 0) = 0$ and $f(2, 2) = 0$.
- (iv) On OC, $f(x, y) = f(x, 0) = 2x - x^2$ for $0 \leq x \leq 2 \Rightarrow f'(x, 0) = 2 - 2x = 0 \Rightarrow x = 1$ and $y = 0 \Rightarrow (1, 0)$ is an interior critical point of OC with $f(1, 0) = 1$. Endpoints: $f(0, 0) = 0$ and $f(2, 0) = 0$.
- (v) For the interior of the rectangular region, $f_x(x, y) = 2 - 2x = 0$ and $f_y(x, y) = 2 - 2y = 0 \Rightarrow x = 1$ and $y = 1 \Rightarrow (1, 1)$ is an interior critical point of the square with $f(1, 1) = 2$. Therefore the absolute maximum is 2 at $(1, 1)$ and the absolute minimum is 0 at the four corners $(0, 0)$, $(0, 2)$, $(2, 2)$, and $(2, 0)$.

75. (i) On AB, $f(x, y) = f(x, x + 2) = -2x + 4$ for $-2 \leq x \leq 2 \Rightarrow f'(x, x + 2) = -2 = 0 \Rightarrow$ no critical points in the interior of AB. Endpoints: $f(-2, 0) = 8$ and $f(2, 4) = 0$.

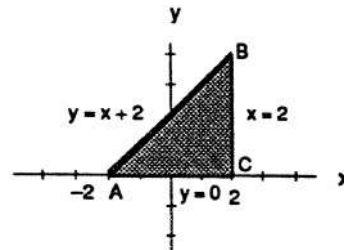

- (ii) On BC, $f(x, y) = f(2, y) = -y^2 + 4y$ for $0 \leq y \leq 4 \Rightarrow f'(2, y) = -2y + 4 = 0 \Rightarrow y = 2$ and $x = 2 \Rightarrow (2, 2)$ is an interior critical point of BC with $f(2, 2) = 4$. Endpoints: $f(2, 0) = 0$ and $f(2, 4) = 0$.
- (iii) On AC, $f(x, y) = f(x, 0) = x^2 - 2x$ for $-2 \leq x \leq 2 \Rightarrow f'(x, 0) = 2x - 2 \Rightarrow x = 1$ and $y = 0 \Rightarrow (1, 0)$ is an interior critical point of AC with $f(1, 0) = -1$. Endpoints: $f(-2, 0) = 8$ and $f(2, 0) = 0$.
- (iv) For the interior of the triangular region, $f_x(x, y) = 2x - 2 = 0$ and $f_y(x, y) = -2y + 4 = 0 \Rightarrow x = 1$ and $y = 2 \Rightarrow (1, 2)$ is an interior critical point of the region with $f(1, 2) = 3$. Therefore the absolute maximum is 8 at $(-2, 0)$ and the absolute minimum is -1 at $(1, 0)$.

76. (i) On AB, $f(x, y) = f(x, x) = 4x^2 - 2x^4 + 16$ for $-2 \leq x \leq 2 \Rightarrow f'(x, x) = 8x - 8x^3 = 0 \Rightarrow x = 0$ and $y = 0$, or $x = 1$ and $y = 1$, or $x = -1$ and $y = -1 \Rightarrow (0, 0), (1, 1), (-1, -1)$ are all interior points of AB with $f(0, 0) = 16, f(1, 1) = 18$, and $f(-1, -1) = 18$. Endpoints: $f(-2, -2) = 0$ and $f(2, 2) = 0$.

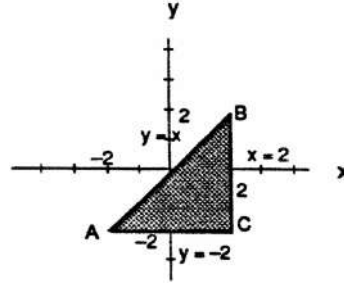

- (ii) On BC, $f(x, y) = f(2, y) = 8y - y^4$ for $-2 \leq y \leq 2 \Rightarrow f'(2, y) = 8 - 4y^3 = 0 \Rightarrow y = \sqrt[3]{2}$ and $x = 2 \Rightarrow (2, \sqrt[3]{2})$ is an interior critical point of BC with $f(2, \sqrt[3]{2}) = 6\sqrt[3]{2}$. Endpoints: $f(2, -2) = -32$ and $f(2, 2) = 0$.
- (iii) On AC, $f(x, y) = f(x, -2) = -8x - x^4$ for $-2 \leq x \leq 2 \Rightarrow f'(x, -2) = -8 - 4x^3 = 0 \Rightarrow x = \sqrt[3]{-2}$ and $y = -2 \Rightarrow (\sqrt[3]{-2}, -2)$ is an interior critical point of AC with $f(\sqrt[3]{-2}, -2) = 6\sqrt[3]{2}$. Endpoints: $f(-2, -2) = 0$ and $f(2, -2) = -32$.
- (iv) For the interior of the triangular region, $f_x(x, y) = 4y - 4x^3 = 0$ and $f_y(x, y) = 4x - 4y^3 = 0 \Rightarrow x = 0$ and $y = 0$, or $x = 1$ and $y = 1$ or $x = -1$ and $y = -1$. But neither of the points $(0, 0)$ and $(1, 1)$, or $(-1, -1)$ are interior to the region. Therefore the absolute maximum is 18 at $(1, 1)$ and $(-1, -1)$, and the absolute minimum is -32 at $(2, -2)$.

77. (i) On AB, $f(x, y) = f(-1, y) = y^3 - 3y^2 + 2$ for $-1 \leq y \leq 1 \Rightarrow f'(-1, y) = 3y^2 - 6y = 0 \Rightarrow y = 0$ and $x = -1$, or $y = 2$ and $x = -1 \Rightarrow (-1, 0)$ is an interior critical point of AB with $f(-1, 0) = 2$; $(-1, 2)$ is outside the boundary. Endpoints: $f(-1, -1) = -2$ and $f(-1, 1) = 0$.

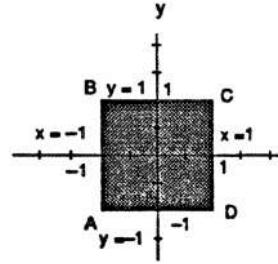

- (ii) On BC, $f(x, y) = f(x, 1) = x^3 + 3x^2 - 2$ for $-1 \leq x \leq 1 \Rightarrow f'(x, 1) = 3x^2 + 6x = 0 \Rightarrow x = 0$ and $y = 1$, or $x = -2$ and $y = 1 \Rightarrow (0, 1)$ is an interior critical point of BC with $f(0, 1) = -2$; $(-2, 1)$ is outside the boundary. Endpoints: $f(-1, 1) = 0$ and $f(1, 1) = 2$.
- (iii) On CD, $f(x, y) = f(1, y) = y^3 - 3y^2 + 4$ for $-1 \leq y \leq 1 \Rightarrow f'(1, y) = 3y^2 - 6y = 0 \Rightarrow y = 0$ and $x = 1$, or $y = 2$ and $x = 1 \Rightarrow (1, 0)$ is an interior critical point of CD with $f(1, 0) = 4$; $(1, 2)$ is outside the boundary. Endpoints: $f(1, 1) = 2$ and $f(1, -1) = 0$.
- (iv) On AD, $f(x, y) = f(x, -1) = x^3 + 3x^2 - 4$ for $-1 \leq x \leq 1 \Rightarrow f'(x, -1) = 3x^2 + 6x = 0 \Rightarrow x = 0$ and $y = -1$, or $x = -2$ and $y = -1 \Rightarrow (0, -1)$ is an interior point of AD with $f(0, -1) = -4$; $(-2, -1)$ is outside the boundary. Endpoints: $f(-1, -1) = -2$ and $f(1, -1) = 0$.
- (v) For the interior of the square, $f_x(x, y) = 3x^2 + 6x = 0$ and $f_y(x, y) = 3y^2 - 6y = 0 \Rightarrow x = 0$ or $x = -2$, and $y = 0$ or $y = 2 \Rightarrow (0, 0)$ is an interior critical point of the square region with $f(0, 0) = 0$; the points $(0, 2)$, $(-2, 0)$, and $(-2, 2)$ are outside the region. Therefore the absolute maximum is 4 at $(1, 0)$ and the absolute minimum is -4 at $(0, -1)$.

78. (i) On AB, $f(x, y) = f(-1, y) = y^3 - 3y$ for $-1 \leq y \leq 1$
 $\Rightarrow f'(-1, y) = 3y^2 - 3 = 0 \Rightarrow y = \pm 1$ and $x = -1$
yielding the corner points $(-1, -1)$ and $(-1, 1)$ with
 $f(-1, -1) = 2$ and $f(-1, 1) = -2$.
- (ii) On BC, $f(x, y) = f(x, 1) = x^3 + 3x + 2$ for
 $-1 \leq x \leq 1 \Rightarrow f'(x, 1) = 3x^2 + 3 = 0 \Rightarrow$ no
solution. Endpoints: $f(-1, 1) = -2$ and $f(1, 1) = 6$.
- (iii) On CD, $f(x, y) = f(1, y) = y^3 + 3y + 2$ for
 $-1 \leq y \leq 1 \Rightarrow f'(1, y) = 3y^2 + 3 = 0 \Rightarrow$ no
solution. Endpoints: $f(1, 1) = 6$ and $f(1, -1) = -2$.
- (iv) On AD, $f(x, y) = f(x, -1) = x^3 - 3x$ for $-1 \leq x \leq 1 \Rightarrow f'(x, -1) = 3x^2 - 3 = 0 \Rightarrow x = \pm 1$ and $y = -1$
yielding the corner points $(-1, -1)$ and $(1, -1)$ with $f(-1, -1) = 2$ and $f(1, -1) = -2$
- (v) For the interior of the square, $f_x(x, y) = 3x^2 + 3y = 0$ and $f_y(x, y) = 3y^2 + 3x = 0 \Rightarrow y = -x^2$ and
 $x^4 + x = 0 \Rightarrow x = 0$ or $x = -1 \Rightarrow y = 0$ or $y = -1 \Rightarrow (0, 0)$ is an interior critical point of the square
region with $f(0, 0) = 1$; $(-1, -1)$ is on the boundary. Therefore the absolute maximum is 6 at $(1, 1)$ and
the absolute minimum is -2 at $(1, -1)$ and $(-1, 1)$.

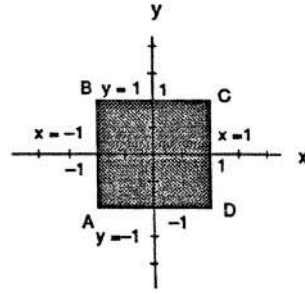

79. $\nabla f = 3x^2\mathbf{i} + 2y\mathbf{j}$ and $\nabla g = 2x\mathbf{i} + 2y\mathbf{j}$ so that $\nabla f = \lambda \nabla g \Rightarrow 3x^2\mathbf{i} + 2y\mathbf{j} = \lambda(2x\mathbf{i} + 2y\mathbf{j}) \Rightarrow 3x^2 = 2x\lambda$ and
 $2y = 2y\lambda \Rightarrow \lambda = 1$ or $y = 0$.

CASE 1: $\lambda = 1 \Rightarrow 3x^2 = 2x \Rightarrow x = 0$ or $x = \frac{2}{3}$; $x = 0 \Rightarrow y = \pm 1$ yielding the points $(0, 1)$ and $(0, -1)$; $x = \frac{2}{3}$
 $\Rightarrow y = \pm \frac{\sqrt{5}}{3}$ yielding the points $(\frac{2}{3}, \frac{\sqrt{5}}{3})$ and $(\frac{2}{3}, -\frac{\sqrt{5}}{3})$.

CASE 2: $y = 0 \Rightarrow x^2 - 1 = 0 \Rightarrow x = \pm 1$ yielding the points $(1, 0)$ and $(-1, 0)$.

Evaluations give $f(0, \pm 1) = 1$, $f(\frac{2}{3}, \pm \frac{\sqrt{5}}{3}) = \frac{23}{27}$, $f(1, 0) = 1$, and $f(-1, 0) = -1$. Therefore the absolute
maximum is 1 at $(0, \pm 1)$ and $(1, 0)$, and the absolute minimum is -1 at $(-1, 0)$.

80. $\nabla f = y\mathbf{i} + x\mathbf{j}$ and $\nabla g = 2x\mathbf{i} + 2y\mathbf{j}$ so that $\nabla f = \lambda \nabla g \Rightarrow y\mathbf{i} + x\mathbf{j} = \lambda(2x\mathbf{i} + 2y\mathbf{j}) \Rightarrow y = 2\lambda x$ and
 $xy = 2\lambda y \Rightarrow x = 2\lambda(2\lambda x) = 4\lambda^2 x \Rightarrow x = 0$ or $4\lambda^2 = 1$.

CASE 1: $x = 0 \Rightarrow y = 0$ but $(0, 0)$ does not lie on the circle, so no solution.

CASE 2: $4\lambda^2 = 1 \Rightarrow \lambda = \frac{1}{2}$ or $\lambda = -\frac{1}{2}$. For $\lambda = \frac{1}{2}$, $y = x \Rightarrow 1 = x^2 + y^2 = 2x^2 \Rightarrow x = y = \pm \frac{1}{\sqrt{2}}$ yielding the
points $(\frac{1}{\sqrt{2}}, \frac{1}{\sqrt{2}})$ and $(-\frac{1}{\sqrt{2}}, -\frac{1}{\sqrt{2}})$. For $\lambda = -\frac{1}{2}$, $y = -x \Rightarrow 1 = x^2 + y^2 = 2x^2 \Rightarrow x = \pm \frac{1}{\sqrt{2}}$ and
 $y = -x$ yielding the points $(-\frac{1}{\sqrt{2}}, \frac{1}{\sqrt{2}})$ and $(\frac{1}{\sqrt{2}}, -\frac{1}{\sqrt{2}})$.

Evaluations give the absolute maximum value $f(\frac{1}{\sqrt{2}}, \frac{1}{\sqrt{2}}) = f(-\frac{1}{\sqrt{2}}, -\frac{1}{\sqrt{2}}) = \frac{1}{2}$ and the absolute minimum
value $f(-\frac{1}{\sqrt{2}}, \frac{1}{\sqrt{2}}) = f(\frac{1}{\sqrt{2}}, -\frac{1}{\sqrt{2}}) = -\frac{1}{2}$.

81. (i) $f(x, y) = x^2 + 3y^2 + 2y$ on $x^2 + y^2 = 1 \Rightarrow \nabla f = 2x\mathbf{i} + (6y + 2)\mathbf{j}$ and $\nabla g = 2x\mathbf{i} + 2y\mathbf{j}$ so that $\nabla f = \lambda \nabla g$
 $\Rightarrow 2x\mathbf{i} + (6y + 2)\mathbf{j} = \lambda(2x\mathbf{i} + 2y\mathbf{j}) \Rightarrow 2x = 2x\lambda$ and $6y + 2 = 2y\lambda \Rightarrow \lambda = 1$ or $x = 0$.

CASE 1: $\lambda = 1 \Rightarrow 6y + 2 = 2y \Rightarrow y = -\frac{1}{2}$ and $x = \pm \frac{\sqrt{3}}{2}$ yielding the points $(\pm \frac{\sqrt{3}}{2}, -\frac{1}{2})$.

CASE 2: $x = 0 \Rightarrow y^2 = 1 \Rightarrow y = \pm 1$ yielding the points $(0, \pm 1)$.

Evaluations give $f(\pm \frac{\sqrt{3}}{2}, -\frac{1}{2}) = \frac{1}{2}$, $f(0, 1) = 5$, and $f(0, -1) = 1$. Therefore $\frac{1}{2}$ and 5 are the extreme
values on the boundary of the disk.

- (ii) For the interior of the disk, $f_x(x, y) = 2x = 0$ and $f_y(x, y) = 6y + 2 = 0 \Rightarrow x = 0$ and $y = -\frac{1}{3}$
 $\Rightarrow (0, -\frac{1}{3})$ is an interior critical point with $f(0, -\frac{1}{3}) = -\frac{1}{3}$. Therefore the absolute maximum of f on the
disk is 5 at $(0, 1)$ and the absolute minimum of f on the disk is $-\frac{1}{3}$ at $(0, -\frac{1}{3})$.

82. (i) $f(x, y) = x^2 + y^2 - 3x - xy$ on $x^2 + y^2 = 9 \Rightarrow \nabla f = (2x - 3 - y)\mathbf{i} + (2y - x)\mathbf{j}$ and $\nabla g = 2x\mathbf{i} + 2y\mathbf{j}$ so that $\nabla f = \lambda \nabla g \Rightarrow (2x - 3 - y)\mathbf{i} + (2y - x)\mathbf{j} = \lambda(2x\mathbf{i} + 2y\mathbf{j}) \Rightarrow 2x - 3 - y = 2x\lambda$ and $2y - x = 2y\lambda \Rightarrow 2x(1 - \lambda) - y = 3$ and $-x + 2y(1 - \lambda) = 0 \Rightarrow 1 - \lambda = \frac{x}{2y}$ and $(2x)\left(\frac{x}{2y}\right) - y = 3 \Rightarrow x^2 - y^2 = 3y \Rightarrow x^2 = y^2 + 3y$. Thus, $9 = x^2 + y^2 = y^2 + 3y + y^2 \Rightarrow 2y^2 + 3y - 9 = 0 \Rightarrow (2y - 3)(y + 3) = 0 \Rightarrow y = -3, \frac{3}{2}$. For $y = -3, x^2 + y^2 = 9 \Rightarrow x = 0$ yielding the point $(0, -3)$. For $y = \frac{3}{2}, x^2 + y^2 = 9 \Rightarrow x^2 + \frac{9}{4} = 9 \Rightarrow x^2 = \frac{27}{4} \Rightarrow x = \pm \frac{3\sqrt{3}}{2}$. Evaluations give $f(0, -3) = 9, f\left(-\frac{3\sqrt{3}}{2}, \frac{3}{2}\right) = 9 + \frac{27\sqrt{3}}{4} \approx 20.691$, and $f\left(\frac{3\sqrt{3}}{2}, \frac{3}{2}\right) = 9 - \frac{27\sqrt{3}}{4} \approx -2.691$.
- (ii) For the interior of the disk, $f_x(x, y) = 2x - 3 - y = 0$ and $f_y(x, y) = 2y - x = 0 \Rightarrow x = 2$ and $y = 1 \Rightarrow (2, 1)$ is an interior critical point of the disk with $f(2, 1) = -3$. Therefore, the absolute maximum of f on the disk is $9 + \frac{27\sqrt{3}}{4}$ at $\left(-\frac{3\sqrt{3}}{2}, \frac{3}{2}\right)$ and the absolute minimum of f on the disk is -3 at $(2, 1)$.
83. $\nabla f = \mathbf{i} - \mathbf{j} + \mathbf{k}$ and $\nabla g = 2x\mathbf{i} + 2y\mathbf{j} + 2z\mathbf{k}$ so that $\nabla f = \lambda \nabla g \Rightarrow \mathbf{i} - \mathbf{j} + \mathbf{k} = \lambda(2x\mathbf{i} + 2y\mathbf{j} + 2z\mathbf{k}) \Rightarrow 1 = 2x\lambda, -1 = 2y\lambda, 1 = 2z\lambda \Rightarrow x = -y = z = \frac{1}{\lambda}$. Thus $x^2 + y^2 + z^2 = 1 \Rightarrow 3x^2 = 1 \Rightarrow x = \pm \frac{1}{\sqrt{3}}$ yielding the points $\left(\frac{1}{\sqrt{3}}, -\frac{1}{\sqrt{3}}, \frac{1}{\sqrt{3}}\right)$ and $\left(-\frac{1}{\sqrt{3}}, \frac{1}{\sqrt{3}}, -\frac{1}{\sqrt{3}}\right)$. Evaluations give the absolute maximum value of $f\left(\frac{1}{\sqrt{3}}, -\frac{1}{\sqrt{3}}, \frac{1}{\sqrt{3}}\right) = \frac{3}{\sqrt{3}} = \sqrt{3}$ and the absolute minimum value of $f\left(-\frac{1}{\sqrt{3}}, \frac{1}{\sqrt{3}}, -\frac{1}{\sqrt{3}}\right) = -\sqrt{3}$.
84. Let $f(x, y, z) = x^2 + y^2 + z^2$ be the square of the distance to the origin and $g(x, y, z) = z^2 - xy - 4$. Then $\nabla f = 2x\mathbf{i} + 2y\mathbf{j} + 2z\mathbf{k}$ and $\nabla g = -y\mathbf{i} - x\mathbf{j} + 2z\mathbf{k}$ so that $\nabla f = \lambda \nabla g \Rightarrow 2x = -\lambda y, 2y = -\lambda x$, and $2z = 2\lambda z \Rightarrow z = 0$ or $\lambda = 1$.
- CASE 1: $z = 0 \Rightarrow xy = -4 \Rightarrow x = -\frac{4}{y}$ and $y = -\frac{4}{x} \Rightarrow 2\left(-\frac{4}{y}\right) = -\lambda y$ and $2\left(-\frac{4}{x}\right) = -\lambda x \Rightarrow \frac{8}{\lambda} = y^2$ and $\frac{8}{\lambda} = x^2 \Rightarrow y^2 = x^2 \Rightarrow y = \pm x$. But $y = x \Rightarrow x^2 = -4$ leads to no solution, so $y = -x \Rightarrow x^2 = 4 \Rightarrow x = \pm 2$ yielding the points $(-2, 2, 0)$ and $(2, -2, 0)$.
- CASE 2: $\lambda = 1 \Rightarrow 2x = -y$ and $2y = -x \Rightarrow 2y = -\left(-\frac{y}{2}\right) \Rightarrow 4y = y \Rightarrow y = 0 \Rightarrow x = 0 \Rightarrow z^2 - 4 = 0 \Rightarrow z = \pm 2$ yielding the points $(0, 0, -2)$ and $(0, 0, 2)$.
- Evaluations give $f(-2, 2, 0) = f(2, -2, 0) = 8$ and $f(0, 0, -2) = f(0, 0, 2) = 4$. Thus the points $(0, 0, -2)$ and $(0, 0, 2)$ on the surface are closest to the origin.
85. The cost is $f(x, y, z) = 2axy + 2bxz + 2cyz$ subject to the constraint $xyz = V$. Then $\nabla f = \lambda \nabla g \Rightarrow 2ay + 2bz = \lambda yz, 2ax + 2cz = \lambda xz$, and $2bx + 2cy = \lambda xy \Rightarrow 2axy + 2bxz = \lambda xyz, 2axy + 2cyz = \lambda xyz$, and $2bxz + 2cyz = \lambda xyz \Rightarrow 2axy + 2bxz = 2axy + 2cyz \Rightarrow y = \left(\frac{b}{c}\right)x$. Also $2axy + 2bxz = 2bxz + 2cyz \Rightarrow z = \left(\frac{a}{c}\right)x$. Then $x\left(\frac{b}{c}x\right)\left(\frac{a}{c}x\right) = V \Rightarrow x^3 = \frac{c^2V}{ab} \Rightarrow \text{width} = x = \left(\frac{c^2V}{ab}\right)^{1/3}$, Depth = $y = \left(\frac{b}{c}\right)\left(\frac{c^2V}{ab}\right)^{1/3} = \left(\frac{b^2V}{ac}\right)^{1/3}$, and Height = $z = \left(\frac{a}{c}\right)\left(\frac{c^2V}{ab}\right)^{1/3} = \left(\frac{a^2V}{bc}\right)^{1/3}$.
86. The volume of the pyramid in the first octant formed by the plane is $V(a, b, c) = \frac{1}{3}\left(\frac{1}{2}ab\right)c = \frac{1}{6}abc$. The point $(2, 1, 2)$ on the plane $\Rightarrow \frac{2}{a} + \frac{1}{b} + \frac{2}{c} = 1$. We want to minimize V subject to the constraint $2bc + ac + 2ab = abc$. Thus, $\nabla V = \frac{bc}{6}\mathbf{i} + \frac{ac}{6}\mathbf{j} + \frac{ab}{6}\mathbf{k}$ and $\nabla g = (c + 2b - bc)\mathbf{i} + (2c + 2a - ac)\mathbf{j} + (2b + a - ab)\mathbf{k}$ so that $\nabla V = \lambda \nabla g \Rightarrow \frac{bc}{6} = \lambda(c + 2b - bc), \frac{ac}{6} = \lambda(2c + 2a - ac)$, and $\frac{ab}{6} = \lambda(2b + a - ab) \Rightarrow \frac{abc}{6} = \lambda(ac + 2ab - abc), \frac{abc}{6} = \lambda(2bc + 2ab - abc)$, and $\frac{abc}{6} = \lambda(2bc + ac - abc) \Rightarrow \lambda ac = 2\lambda bc$ and $2\lambda ab = 2\lambda bc$. Now $\lambda \neq 0$ since $a \neq 0, b \neq 0$, and $c \neq 0 \Rightarrow ac = 2bc$ and $ab = bc \Rightarrow a = 2b = c$. Substituting into the constraint equation gives $\frac{2}{a} + \frac{2}{a} + \frac{2}{a} = 1 \Rightarrow a = 6 \Rightarrow b = 3$ and $c = 6$. Therefore the desired plane is $\frac{x}{6} + \frac{y}{3} + \frac{z}{6} = 1$ or $x + 2y + z = 6$.
87. $\nabla f = (y + z)\mathbf{i} + x\mathbf{j} + x\mathbf{k}, \nabla g = 2x\mathbf{i} + 2y\mathbf{j}$, and $\nabla h = z\mathbf{i} + x\mathbf{k}$ so that $\nabla f = \lambda \nabla g + \mu \nabla h \Rightarrow (y + z)\mathbf{i} + x\mathbf{j} + x\mathbf{k} = \lambda(2x\mathbf{i} + 2y\mathbf{j}) + \mu(z\mathbf{i} + x\mathbf{k}) \Rightarrow y + z = 2\lambda x + \mu z, x = 2\lambda y, x = \mu x \Rightarrow x = 0$

or $\mu = 1$.

CASE 1: $x = 0$ which is impossible since $xz = 1$.

CASE 2: $\mu = 1 \Rightarrow y + z = 2\lambda x + z \Rightarrow y = 2\lambda x$ and $x = 2\lambda y \Rightarrow y = (2\lambda)(2\lambda y) \Rightarrow y = 0$ or $4\lambda^2 = 1$. If $y = 0$, then $x^2 = 1 \Rightarrow x = \pm 1$ so with $xz = 1$ we obtain the points $(1, 0, 1)$ and $(-1, 0, -1)$. If $4\lambda^2 = 1$, then $\lambda = \pm \frac{1}{2}$. For $\lambda = -\frac{1}{2}$, $y = -x$ so $x^2 + y^2 = 1 \Rightarrow x^2 = \frac{1}{2} \Rightarrow x = \pm \frac{1}{\sqrt{2}}$ with $xz = 1 \Rightarrow z = \pm \sqrt{2}$, and we obtain the points $(\frac{1}{\sqrt{2}}, -\frac{1}{\sqrt{2}}, \sqrt{2})$ and $(-\frac{1}{\sqrt{2}}, \frac{1}{\sqrt{2}}, -\sqrt{2})$. For $\lambda = \frac{1}{2}$, $y = x \Rightarrow x^2 = \frac{1}{2} \Rightarrow x = \pm \frac{1}{\sqrt{2}}$ with $xz = 1 \Rightarrow z = \pm \sqrt{2}$, and we obtain the points $(\frac{1}{\sqrt{2}}, \frac{1}{\sqrt{2}}, \sqrt{2})$ and $(-\frac{1}{\sqrt{2}}, -\frac{1}{\sqrt{2}}, -\sqrt{2})$.

Evaluations give $f(1, 0, 1) = 1$, $f(-1, 0, -1) = 1$, $f(\frac{1}{\sqrt{2}}, -\frac{1}{\sqrt{2}}, \sqrt{2}) = \frac{1}{2}$, $f(-\frac{1}{\sqrt{2}}, \frac{1}{\sqrt{2}}, -\sqrt{2}) = \frac{1}{2}$, $f(\frac{1}{\sqrt{2}}, \frac{1}{\sqrt{2}}, \sqrt{2}) = \frac{3}{2}$, and $f(-\frac{1}{\sqrt{2}}, -\frac{1}{\sqrt{2}}, -\sqrt{2}) = \frac{3}{2}$. Therefore the absolute maximum is $\frac{3}{2}$ at $(\frac{1}{\sqrt{2}}, \frac{1}{\sqrt{2}}, \sqrt{2})$ and $(-\frac{1}{\sqrt{2}}, -\frac{1}{\sqrt{2}}, -\sqrt{2})$, and the absolute minimum is $\frac{1}{2}$ at $(-\frac{1}{\sqrt{2}}, \frac{1}{\sqrt{2}}, -\sqrt{2})$ and $(\frac{1}{\sqrt{2}}, -\frac{1}{\sqrt{2}}, \sqrt{2})$.

88. Let $f(x, y, z) = x^2 + y^2 + z^2$ be the square of the distance to the origin. Then $\nabla f = 2x\mathbf{i} + 2y\mathbf{j} + 2z\mathbf{k}$, $\nabla g = \mathbf{i} + \mathbf{j} + \mathbf{k}$, and $\nabla h = 4x\mathbf{i} + 4y\mathbf{j} - 2z\mathbf{k}$ so that $\nabla f = \lambda \nabla g + \mu \nabla h \Rightarrow 2x = \lambda + 4x\mu$, $2y = \lambda + 4y\mu$, and $2z = \lambda - 2z\mu \Rightarrow \lambda = 2x(1 - 2\mu) = 2y(1 - 2\mu) = 2z(1 + 2\mu) \Rightarrow x = y$ or $\mu = \frac{1}{2}$.

CASE 1: $x = y \Rightarrow z^2 = 4x^2 \Rightarrow z = \pm 2x$ so that $x + y + z = 1 \Rightarrow x + x + 2x = 1$ or $x + x - 2x = 1$ (impossible) $\Rightarrow x = \frac{1}{4} \Rightarrow y = \frac{1}{4}$ and $z = \frac{1}{2}$ yielding the point $(\frac{1}{4}, \frac{1}{4}, \frac{1}{2})$.

CASE 2: $\mu = \frac{1}{2} \Rightarrow \lambda = 0 \Rightarrow 0 = 2z(1 + 1) \Rightarrow z = 0$ so that $2x^2 + 2y^2 = 0 \Rightarrow x = y = 0$. But the origin $(0, 0, 0)$ fails to satisfy the first constraint $x + y + z = 1$.

Therefore, the point $(\frac{1}{4}, \frac{1}{4}, \frac{1}{2})$ on the curve of intersection is closest to the origin.

89. (a) y, z are independent with $w = x^2e^{yz}$ and $z = x^2 - y^2 \Rightarrow \frac{\partial w}{\partial y} = \frac{\partial w}{\partial x} \frac{\partial x}{\partial y} + \frac{\partial w}{\partial y} \frac{\partial y}{\partial y} + \frac{\partial w}{\partial z} \frac{\partial z}{\partial y}$
 $= (2xe^{yz}) \frac{\partial x}{\partial y} + (zx^2e^{yz})(1) + (yx^2e^{yz})(0)$; $z = x^2 - y^2 \Rightarrow 0 = 2x \frac{\partial x}{\partial y} - 2y \Rightarrow \frac{\partial x}{\partial y} = \frac{y}{x}$; therefore,
 $(\frac{\partial w}{\partial y})_z = (2xe^{yz}) (\frac{y}{x}) + zx^2e^{yz} = (2y + zx^2)e^{yz}$

(b) z, x are independent with $w = x^2e^{yz}$ and $z = x^2 - y^2 \Rightarrow \frac{\partial w}{\partial z} = \frac{\partial w}{\partial x} \frac{\partial x}{\partial z} + \frac{\partial w}{\partial y} \frac{\partial y}{\partial z} + \frac{\partial w}{\partial z} \frac{\partial z}{\partial z}$
 $= (2xe^{yz})(0) + (zx^2e^{yz}) \frac{\partial y}{\partial z} + (yx^2e^{yz})(1)$; $z = x^2 - y^2 \Rightarrow 1 = 0 - 2y \frac{\partial y}{\partial z} \Rightarrow \frac{\partial y}{\partial z} = -\frac{1}{2y}$; therefore,
 $(\frac{\partial w}{\partial z})_x = (zx^2e^{yz}) (-\frac{1}{2y}) + yx^2e^{yz} = x^2e^{yz} (y - \frac{z}{2y})$

(c) z, y are independent with $w = x^2e^{yz}$ and $z = x^2 - y^2 \Rightarrow \frac{\partial w}{\partial z} = \frac{\partial w}{\partial x} \frac{\partial x}{\partial z} + \frac{\partial w}{\partial y} \frac{\partial y}{\partial z} + \frac{\partial w}{\partial z} \frac{\partial z}{\partial z}$
 $= (2xe^{yz}) \frac{\partial x}{\partial z} + (zx^2e^{yz})(0) + (yx^2e^{yz})(1)$; $z = x^2 - y^2 \Rightarrow 1 = 2x \frac{\partial x}{\partial z} - 0 \Rightarrow \frac{\partial x}{\partial z} = \frac{1}{2x}$; therefore,
 $(\frac{\partial w}{\partial z})_y = (2xe^{yz}) (\frac{1}{2x}) + yx^2e^{yz} = (1 + x^2y)e^{yz}$

90. (a) T, P are independent with $U = f(P, V, T)$ and $PV = nRT \Rightarrow \frac{\partial U}{\partial T} = \frac{\partial U}{\partial P} \frac{\partial P}{\partial T} + \frac{\partial U}{\partial V} \frac{\partial V}{\partial T} + \frac{\partial U}{\partial T} \frac{\partial T}{\partial T}$
 $= (\frac{\partial U}{\partial P})(0) + (\frac{\partial U}{\partial V}) (\frac{\partial V}{\partial T}) + (\frac{\partial U}{\partial T})(1)$; $PV = nRT \Rightarrow P \frac{\partial V}{\partial T} = nR \Rightarrow \frac{\partial V}{\partial T} = \frac{nR}{P}$; therefore,
 $(\frac{\partial U}{\partial T})_P = (\frac{\partial U}{\partial V}) (\frac{nR}{P}) + \frac{\partial U}{\partial T}$

(b) V, T are independent with $U = f(P, V, T)$ and $PV = nRT \Rightarrow \frac{\partial U}{\partial V} = \frac{\partial U}{\partial P} \frac{\partial P}{\partial V} + \frac{\partial U}{\partial V} \frac{\partial V}{\partial V} + \frac{\partial U}{\partial T} \frac{\partial T}{\partial V}$
 $= (\frac{\partial U}{\partial P}) (\frac{\partial P}{\partial V}) + (\frac{\partial U}{\partial V})(1) + (\frac{\partial U}{\partial T})(0)$; $PV = nRT \Rightarrow V \frac{\partial P}{\partial V} + P = (nR) (\frac{\partial T}{\partial V}) = 0 \Rightarrow \frac{\partial P}{\partial V} = -\frac{P}{V}$; therefore,
 $(\frac{\partial U}{\partial V})_T = (\frac{\partial U}{\partial P}) (-\frac{P}{V}) + \frac{\partial U}{\partial V}$

91. Note that $x = r \cos \theta$ and $y = r \sin \theta \Rightarrow r = \sqrt{x^2 + y^2}$ and $\theta = \tan^{-1}(\frac{y}{x})$. Thus,

$$\frac{\partial w}{\partial x} = \frac{\partial w}{\partial r} \frac{\partial r}{\partial x} + \frac{\partial w}{\partial \theta} \frac{\partial \theta}{\partial x} = (\frac{\partial w}{\partial r}) \left(\frac{x}{\sqrt{x^2 + y^2}}\right) + (\frac{\partial w}{\partial \theta}) \left(\frac{-y}{x^2 + y^2}\right) = (\cos \theta) \frac{\partial w}{\partial r} - \left(\frac{\sin \theta}{r}\right) \frac{\partial w}{\partial \theta};$$

$$\frac{\partial w}{\partial y} = \frac{\partial w}{\partial r} \frac{\partial r}{\partial y} + \frac{\partial w}{\partial \theta} \frac{\partial \theta}{\partial y} = \left(\frac{\partial w}{\partial r}\right) \left(\frac{y}{\sqrt{x^2+y^2}}\right) + \left(\frac{\partial w}{\partial \theta}\right) \left(\frac{x}{x^2+y^2}\right) = (\sin \theta) \frac{\partial w}{\partial r} + \left(\frac{\cos \theta}{r}\right) \frac{\partial w}{\partial \theta}$$

92. $z_x = f_u \frac{\partial u}{\partial x} + f_v \frac{\partial v}{\partial x} = af_u + af_v$, and $z_y = f_u \frac{\partial u}{\partial y} + f_v \frac{\partial v}{\partial y} = bf_u - bf_v$

93. $\frac{\partial u}{\partial y} = b$ and $\frac{\partial u}{\partial x} = a \Rightarrow \frac{\partial w}{\partial u} = \frac{dw}{du} \frac{\partial u}{\partial x} = a \frac{dw}{du}$ and $\frac{\partial w}{\partial y} = \frac{dw}{du} \frac{\partial u}{\partial y} = b \frac{dw}{du} \Rightarrow \frac{1}{a} \frac{\partial w}{\partial x} = \frac{dw}{du}$ and $\frac{1}{b} \frac{\partial w}{\partial y} = \frac{dw}{du}$
 $\Rightarrow \frac{1}{a} \frac{\partial w}{\partial x} = \frac{1}{b} \frac{\partial w}{\partial y} \Rightarrow b \frac{\partial w}{\partial x} = a \frac{\partial w}{\partial y}$

94. $\frac{\partial w}{\partial x} = \frac{2x}{x^2+y^2+2z} = \frac{2(r+s)}{(r+s)^2+(r-s)^2+4rs} = \frac{2(r+s)}{2(r^2+2rs+s^2)} = \frac{1}{r+s}$, $\frac{\partial w}{\partial y} = \frac{2y}{x^2+y^2+2z} = \frac{2(r-s)}{2(r+s)^2} = \frac{r-s}{(r+s)^2}$,
 and $\frac{\partial w}{\partial z} = \frac{2}{x^2+y^2+2z} = \frac{1}{(r+s)^2} \Rightarrow \frac{\partial w}{\partial r} = \frac{\partial w}{\partial x} \frac{\partial x}{\partial r} + \frac{\partial w}{\partial y} \frac{\partial y}{\partial r} + \frac{\partial w}{\partial z} \frac{\partial z}{\partial r} = \frac{1}{r+s} + \frac{r-s}{(r+s)^2} + \left[\frac{1}{(r+s)^2}\right] (2s) = \frac{2r+2s}{(r+s)^2}$
 $= \frac{2}{r+s}$ and $\frac{\partial w}{\partial s} = \frac{\partial w}{\partial x} \frac{\partial x}{\partial s} + \frac{\partial w}{\partial y} \frac{\partial y}{\partial s} + \frac{\partial w}{\partial z} \frac{\partial z}{\partial s} = \frac{1}{r+s} - \frac{r-s}{(r+s)^2} + \left[\frac{1}{(r+s)^2}\right] (2r) = \frac{2}{r+s}$

95. $e^u \cos v - x = 0 \Rightarrow (e^u \cos v) \frac{\partial u}{\partial x} - (e^u \sin v) \frac{\partial v}{\partial x} = 1$; $e^u \sin v - y = 0 \Rightarrow (e^u \sin v) \frac{\partial u}{\partial x} + (e^u \cos v) \frac{\partial v}{\partial x} = 0$.

Solving this system yields $\frac{\partial u}{\partial x} = e^{-u} \cos v$ and $\frac{\partial v}{\partial x} = -e^{-u} \sin v$. Similarly, $e^u \cos v - x = 0$

$\Rightarrow (e^u \cos v) \frac{\partial u}{\partial y} - (e^u \sin v) \frac{\partial v}{\partial y} = 0$ and $e^u \sin v - y = 0 \Rightarrow (e^u \sin v) \frac{\partial u}{\partial y} + (e^u \cos v) \frac{\partial v}{\partial y} = 1$. Solving this

second system yields $\frac{\partial u}{\partial y} = e^{-u} \sin v$ and $\frac{\partial v}{\partial y} = e^{-u} \cos v$. Therefore $\left(\frac{\partial u}{\partial x} \mathbf{i} + \frac{\partial u}{\partial y} \mathbf{j}\right) \cdot \left(\frac{\partial v}{\partial x} \mathbf{i} + \frac{\partial v}{\partial y} \mathbf{j}\right)$

$= [(e^{-u} \cos v) \mathbf{i} + (e^{-u} \sin v) \mathbf{j}] \cdot [(-e^{-u} \sin v) \mathbf{i} + (e^{-u} \cos v) \mathbf{j}] = 0 \Rightarrow$ the vectors are orthogonal \Rightarrow the angle between the vectors is the constant $\frac{\pi}{2}$.

96. $\frac{\partial g}{\partial \theta} = \frac{\partial f}{\partial x} \frac{\partial x}{\partial \theta} + \frac{\partial f}{\partial y} \frac{\partial y}{\partial \theta} = (-r \sin \theta) \frac{\partial f}{\partial x} + (r \cos \theta) \frac{\partial f}{\partial y}$
 $\Rightarrow \frac{\partial^2 g}{\partial \theta^2} = (-r \sin \theta) \left(\frac{\partial^2 f}{\partial x^2} \frac{\partial x}{\partial \theta} + \frac{\partial^2 f}{\partial y \partial x} \frac{\partial y}{\partial \theta}\right) - (r \cos \theta) \frac{\partial f}{\partial x} + (r \cos \theta) \left(\frac{\partial^2 f}{\partial x \partial y} \frac{\partial x}{\partial \theta} + \frac{\partial^2 f}{\partial y^2} \frac{\partial y}{\partial \theta}\right) - (r \sin \theta) \frac{\partial f}{\partial y}$
 $= (-r \sin \theta) \left(\frac{\partial x}{\partial \theta} + \frac{\partial y}{\partial \theta}\right) - (r \cos \theta) + (r \cos \theta) \left(\frac{\partial x}{\partial \theta} + \frac{\partial y}{\partial \theta}\right) - (r \sin \theta)$
 $= (-r \sin \theta + r \cos \theta)(-r \sin \theta + r \cos \theta) - (r \cos \theta + r \sin \theta) = (-2)(-2) - (0 + 2) = 4 - 2 = 2$ at $(r, \theta) = \left(2, \frac{\pi}{2}\right)$.

97. $(y+z)^2 + (z-x)^2 = 16 \Rightarrow \nabla f = -2(z-x)\mathbf{i} + 2(y+z)\mathbf{j} + 2(y+2z-x)\mathbf{k}$; if the normal line is parallel to the yz -plane, then x is constant $\Rightarrow \frac{\partial f}{\partial x} = 0 \Rightarrow -2(z-x) = 0 \Rightarrow z = x \Rightarrow (y+z)^2 + (z-z)^2 = 16 \Rightarrow y+z = \pm 4$.
 Let $x = t \Rightarrow z = t \Rightarrow y = -t \pm 4$. Therefore the points are $(t, -t \pm 4, t)$, t a real number.

98. Let $f(x, y, z) = xy + yz + zx - x - z^2 = 0$. If the tangent plane is to be parallel to the xy -plane, then ∇f is perpendicular to the xy -plane $\Rightarrow \nabla f \cdot \mathbf{i} = 0$ and $\nabla f \cdot \mathbf{j} = 0$. Now $\nabla f = (y+z-1)\mathbf{i} + (x+z)\mathbf{j} + (y+x-2z)\mathbf{k}$ so that $\nabla f \cdot \mathbf{i} = y+z-1 = 0 \Rightarrow y+z = 1 \Rightarrow y = 1-z$, and $\nabla f \cdot \mathbf{j} = x+z = 0 \Rightarrow x = -z$. Then $-z(1-z) + (1-z)z + z(-z) - (-z) - z^2 = 0 \Rightarrow z - 2z^2 = 0 \Rightarrow z = \frac{1}{2}$ or $z = 0$. Now $z = \frac{1}{2} \Rightarrow x = -\frac{1}{2}$ and $y = \frac{1}{2} \Rightarrow \left(-\frac{1}{2}, \frac{1}{2}, \frac{1}{2}\right)$ is one desired point; $z = 0 \Rightarrow x = 0$ and $y = 1 \Rightarrow (0, 1, 0)$ is a second desired point.

99. $\nabla f = \lambda(x\mathbf{i} + y\mathbf{j} + z\mathbf{k}) \Rightarrow \frac{\partial f}{\partial x} = \lambda x \Rightarrow f(x, y, z) = \frac{1}{2} \lambda x^2 + g(y, z)$ for some function $g \Rightarrow \lambda y = \frac{\partial f}{\partial y} = \frac{\partial g}{\partial y}$
 $\Rightarrow g(y, z) = \frac{1}{2} \lambda y^2 + h(z)$ for some function $h \Rightarrow \lambda z = \frac{\partial f}{\partial z} = \frac{\partial g}{\partial z} = h'(z) \Rightarrow h(z) = \frac{1}{2} \lambda z^2 + C$ for some arbitrary constant $C \Rightarrow g(y, z) = \frac{1}{2} \lambda y^2 + \left(\frac{1}{2} \lambda z^2 + C\right) \Rightarrow f(x, y, z) = \frac{1}{2} \lambda x^2 + \frac{1}{2} \lambda y^2 + \frac{1}{2} \lambda z^2 + C \Rightarrow f(0, 0, a) = \frac{1}{2} \lambda a^2 + C$ and $f(0, 0, -a) = \frac{1}{2} \lambda (-a)^2 + C \Rightarrow f(0, 0, a) = f(0, 0, -a)$ for any constant a , as claimed.

100. $\left(\frac{df}{ds}\right)_{\mathbf{u}(0,0,0)} = \lim_{s \rightarrow 0} \frac{f(0+su_1, 0+su_2, 0+su_3) - f(0, 0, 0)}{s}, s > 0$
 $= \lim_{s \rightarrow 0} \frac{\sqrt{s^2 u_1^2 + s^2 u_2^2 + s^2 u_3^2} - 0}{s}, s > 0$

$$= \lim_{s \rightarrow 0} \frac{s\sqrt{u_1^2 + u_2^2 + u_3^2}}{s} = \lim_{s \rightarrow 0} |\mathbf{u}| = 1;$$

however, $\nabla f = \frac{x}{\sqrt{x^2+y^2+z^2}} \mathbf{i} + \frac{y}{\sqrt{x^2+y^2+z^2}} \mathbf{j} + \frac{z}{\sqrt{x^2+y^2+z^2}} \mathbf{k}$ fails to exist at the origin $(0, 0, 0)$

101. Let $f(x, y, z) = xy + z - 2 \Rightarrow \nabla f = y\mathbf{i} + x\mathbf{j} + \mathbf{k}$. At $(1, 1, 1)$, we have $\nabla f = \mathbf{i} + \mathbf{j} + \mathbf{k} \Rightarrow$ the normal line is $x = 1 + t, y = 1 + t, z = 1 + t$, so at $t = -1 \Rightarrow x = 0, y = 0, z = 0$ and the normal line passes through the origin.

102. (b) $f(x, y, z) = x^2 - y^2 + z^2 = 4$
 $\Rightarrow \nabla f = 2x\mathbf{i} - 2y\mathbf{j} + 2z\mathbf{k} \Rightarrow$ at $(2, -3, 3)$
 the gradient is $\nabla f = 4\mathbf{i} + 6\mathbf{j} + 6\mathbf{k}$ which is normal to the surface
 (c) Tangent plane: $4x + 6y + 6z = 8$ or
 $2x + 3y + 3z = 4$
 Normal line: $x = 2 + 4t, y = -3 + 6t, z = 3 + 6t$

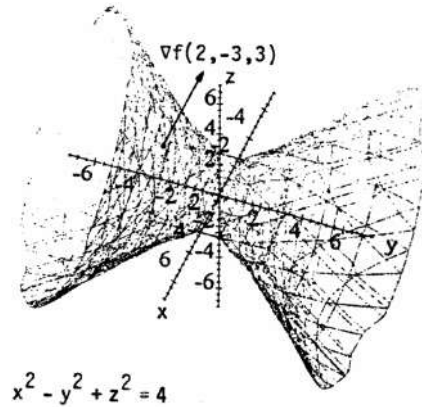

CHAPTER 14 ADDITIONAL AND ADVANCED EXERCISES

- By definition, $f_{xy}(0, 0) = \lim_{h \rightarrow 0} \frac{f_x(0, h) - f_x(0, 0)}{h}$ so we need to calculate the first partial derivatives in the numerator. For $(x, y) \neq (0, 0)$ we calculate $f_x(x, y)$ by applying the differentiation rules to the formula for $f(x, y)$: $f_x(x, y) = \frac{x^2y - y^3}{x^2 + y^2} + (xy) \frac{(x^2 + y^2)(2x) - (x^2 - y^2)(2x)}{(x^2 + y^2)^2} = \frac{x^2y - y^3}{x^2 + y^2} + \frac{4x^2y^3}{(x^2 + y^2)^2} \Rightarrow f_x(0, h) = -\frac{h^3}{h^2} = -h$. For $(x, y) = (0, 0)$ we apply the definition: $f_x(0, 0) = \lim_{h \rightarrow 0} \frac{f(h, 0) - f(0, 0)}{h} = \lim_{h \rightarrow 0} \frac{0 - 0}{h} = 0$. Then by definition $f_{xy}(0, 0) = \lim_{h \rightarrow 0} \frac{-h - 0}{h} = -1$. Similarly, $f_{yx}(0, 0) = \lim_{h \rightarrow 0} \frac{f_y(h, 0) - f_y(0, 0)}{h}$, so for $(x, y) \neq (0, 0)$ we have $f_y(x, y) = \frac{x^3 - xy^2}{x^2 + y^2} - \frac{4x^3y^2}{(x^2 + y^2)^2} \Rightarrow f_y(h, 0) = \frac{h^3}{h^2} = h$; for $(x, y) = (0, 0)$ we obtain $f_y(0, 0) = \lim_{h \rightarrow 0} \frac{f(0, h) - f(0, 0)}{h} = \lim_{h \rightarrow 0} \frac{0 - 0}{h} = 0$. Then by definition $f_{yx}(0, 0) = \lim_{h \rightarrow 0} \frac{h - 0}{h} = 1$. Note that $f_{xy}(0, 0) \neq f_{yx}(0, 0)$ in this case.
- $\frac{\partial w}{\partial x} = 1 + e^x \cos y \Rightarrow w = x + e^x \cos y + g(y)$; $\frac{\partial w}{\partial y} = -e^x \sin y + g'(y) = 2y - e^x \sin y \Rightarrow g'(y) = 2y \Rightarrow g(y) = y^2 + C$; $w = \ln 2$ when $x = \ln 2$ and $y = 0 \Rightarrow \ln 2 = \ln 2 + e^{\ln 2} \cos 0 + 0^2 + C \Rightarrow 0 = 2 + C \Rightarrow C = -2$. Thus, $w = x + e^x \cos y + g(y) = x + e^x \cos y + y^2 - 2$.
- Substitution of $u + u(x)$ and $v = v(x)$ in $g(u, v)$ gives $g(u(x), v(x))$ which is a function of the independent variable x . Then, $g(u, v) = \int_u^v f(t) dt \Rightarrow \frac{dg}{dx} = \frac{\partial g}{\partial u} \frac{du}{dx} + \frac{\partial g}{\partial v} \frac{dv}{dx} = \left(\frac{\partial}{\partial u} \int_u^v f(t) dt \right) \frac{du}{dx} + \left(\frac{\partial}{\partial v} \int_u^v f(t) dt \right) \frac{dv}{dx} = \left(-\frac{\partial}{\partial u} \int_u^u f(t) dt \right) \frac{du}{dx} + \left(\frac{\partial}{\partial v} \int_u^v f(t) dt \right) \frac{dv}{dx} = -f(u(x)) \frac{du}{dx} + f(v(x)) \frac{dv}{dx} = f(v(x)) \frac{dv}{dx} - f(u(x)) \frac{du}{dx}$
- Applying the chain rules, $f_x = \frac{df}{dr} \frac{\partial r}{\partial x} \Rightarrow f_{xx} = \left(\frac{d^2f}{dr^2} \right) \left(\frac{\partial r}{\partial x} \right)^2 + \frac{df}{dr} \frac{\partial^2 r}{\partial x^2}$. Similarly, $f_{yy} = \left(\frac{d^2f}{dr^2} \right) \left(\frac{\partial r}{\partial y} \right)^2 + \frac{df}{dr} \frac{\partial^2 r}{\partial y^2}$ and $f_{zz} = \left(\frac{d^2f}{dr^2} \right) \left(\frac{\partial r}{\partial z} \right)^2 + \frac{df}{dr} \frac{\partial^2 r}{\partial z^2}$. Moreover, $\frac{\partial r}{\partial x} = \frac{x}{\sqrt{x^2+y^2+z^2}} \Rightarrow \frac{\partial^2 r}{\partial x^2} = \frac{y^2+z^2}{(\sqrt{x^2+y^2+z^2})^3}$; $\frac{\partial r}{\partial y} = \frac{y}{\sqrt{x^2+y^2+z^2}} \Rightarrow \frac{\partial^2 r}{\partial y^2} = \frac{x^2+z^2}{(\sqrt{x^2+y^2+z^2})^3}$; and $\frac{\partial r}{\partial z} = \frac{z}{\sqrt{x^2+y^2+z^2}} \Rightarrow \frac{\partial^2 r}{\partial z^2} = \frac{x^2+y^2}{(\sqrt{x^2+y^2+z^2})^3}$. Next, $f_{xx} + f_{yy} + f_{zz} = 0 \Rightarrow \left(\frac{d^2f}{dr^2} \right) \left(\frac{x^2}{x^2+y^2+z^2} \right) + \left(\frac{df}{dr} \right) \left(\frac{y^2+z^2}{(\sqrt{x^2+y^2+z^2})^3} \right) + \left(\frac{d^2f}{dr^2} \right) \left(\frac{y^2}{x^2+y^2+z^2} \right) + \left(\frac{df}{dr} \right) \left(\frac{x^2+z^2}{(\sqrt{x^2+y^2+z^2})^3} \right) + \left(\frac{d^2f}{dr^2} \right) \left(\frac{z^2}{x^2+y^2+z^2} \right) + \left(\frac{df}{dr} \right) \left(\frac{x^2+y^2}{(\sqrt{x^2+y^2+z^2})^3} \right) = 0$

$$\begin{aligned}
& + \left(\frac{d^2f}{dr^2} \right) \left(\frac{z^2}{x^2+y^2+z^2} \right) + \left(\frac{df}{dr} \right) \left(\frac{x^2+y^2}{(\sqrt{x^2+y^2+z^2})^3} \right) = 0 \Rightarrow \frac{d^2f}{dr^2} + \left(\frac{2}{\sqrt{x^2+y^2+z^2}} \right) \frac{df}{dr} = 0 \Rightarrow \frac{d^2f}{dr^2} + \frac{2}{r} \frac{df}{dr} = 0 \\
& \Rightarrow \frac{d}{dr} \left(f' \right) = \left(-\frac{2}{r} \right) f', \text{ where } f' = \frac{df}{dr} \Rightarrow \frac{df'}{f'} = -\frac{2dr}{r} \Rightarrow \ln f' = -2 \ln r + \ln C \Rightarrow f' = Cr^{-2}, \text{ or} \\
& \frac{df}{dr} = Cr^{-2} \Rightarrow f(r) = -\frac{C}{r} + b = \frac{a}{r} + b \text{ for some constants } a \text{ and } b \text{ (setting } a = -C)
\end{aligned}$$

5. (a) Let $u = tx$, $v = ty$, and $w = f(u, v) = f(u(t, x), v(t, y)) = f(tx, ty) = t^n f(x, y)$, where t , x , and y are independent variables. Then $nt^{n-1}f(x, y) = \frac{\partial w}{\partial t} = \frac{\partial w}{\partial u} \frac{\partial u}{\partial t} + \frac{\partial w}{\partial v} \frac{\partial v}{\partial t} = x \frac{\partial w}{\partial u} + y \frac{\partial w}{\partial v}$. Now,

$$\frac{\partial w}{\partial x} = \frac{\partial w}{\partial u} \frac{\partial u}{\partial x} + \frac{\partial w}{\partial v} \frac{\partial v}{\partial x} = \left(\frac{\partial w}{\partial u} \right) (t) + \left(\frac{\partial w}{\partial v} \right) (0) = t \frac{\partial w}{\partial u} \Rightarrow \frac{\partial w}{\partial u} = \left(\frac{1}{t} \right) \left(\frac{\partial w}{\partial x} \right). \text{ Likewise,}$$

$$\frac{\partial w}{\partial y} = \frac{\partial w}{\partial u} \frac{\partial u}{\partial y} + \frac{\partial w}{\partial v} \frac{\partial v}{\partial y} = \left(\frac{\partial w}{\partial u} \right) (0) + \left(\frac{\partial w}{\partial v} \right) (t) \Rightarrow \frac{\partial w}{\partial v} = \left(\frac{1}{t} \right) \left(\frac{\partial w}{\partial y} \right). \text{ Therefore,}$$

$$nt^{n-1}f(x, y) = x \frac{\partial w}{\partial u} + y \frac{\partial w}{\partial v} = \left(\frac{x}{t} \right) \left(\frac{\partial w}{\partial x} \right) + \left(\frac{y}{t} \right) \left(\frac{\partial w}{\partial y} \right). \text{ When } t = 1, u = x, v = y, \text{ and } w = f(x, y)$$

$$\Rightarrow \frac{\partial w}{\partial x} = \frac{\partial f}{\partial x} \text{ and } \frac{\partial w}{\partial y} = \frac{\partial f}{\partial y} \Rightarrow nf(x, y) = x \frac{\partial f}{\partial x} + y \frac{\partial f}{\partial y}, \text{ as claimed.}$$

- (b) From part (a), $nt^{n-1}f(x, y) = x \frac{\partial w}{\partial u} + y \frac{\partial w}{\partial v}$. Differentiating with respect to t again we obtain

$$n(n-1)t^{n-2}f(x, y) = x \frac{\partial^2 w}{\partial u^2} \frac{\partial u}{\partial t} + x \frac{\partial^2 w}{\partial v \partial u} \frac{\partial v}{\partial t} + y \frac{\partial^2 w}{\partial u \partial v} \frac{\partial u}{\partial t} + y \frac{\partial^2 w}{\partial v^2} \frac{\partial v}{\partial t} = x^2 \frac{\partial^2 w}{\partial u^2} + 2xy \frac{\partial^2 w}{\partial u \partial v} + y^2 \frac{\partial^2 w}{\partial v^2}.$$

$$\text{Also from part (a), } \frac{\partial^2 w}{\partial x^2} = \frac{\partial}{\partial x} \left(\frac{\partial w}{\partial x} \right) = \frac{\partial}{\partial x} \left(t \frac{\partial w}{\partial u} \right) = t \frac{\partial^2 w}{\partial u^2} \frac{\partial u}{\partial x} + t \frac{\partial^2 w}{\partial v \partial u} \frac{\partial v}{\partial x} = t^2 \frac{\partial^2 w}{\partial u^2}, \frac{\partial^2 w}{\partial y^2} = \frac{\partial}{\partial y} \left(\frac{\partial w}{\partial y} \right)$$

$$= \frac{\partial}{\partial y} \left(t \frac{\partial w}{\partial v} \right) = t \frac{\partial^2 w}{\partial u \partial v} \frac{\partial u}{\partial y} + t \frac{\partial^2 w}{\partial v^2} \frac{\partial v}{\partial y} = t^2 \frac{\partial^2 w}{\partial v^2}, \text{ and } \frac{\partial^2 w}{\partial y \partial x} = \frac{\partial}{\partial y} \left(\frac{\partial w}{\partial x} \right) = \frac{\partial}{\partial y} \left(t \frac{\partial w}{\partial u} \right) = t \frac{\partial^2 w}{\partial u^2} \frac{\partial u}{\partial y} + t \frac{\partial^2 w}{\partial v \partial u} \frac{\partial v}{\partial y}$$

$$= t^2 \frac{\partial^2 w}{\partial v \partial u} \Rightarrow \left(\frac{1}{t^2} \right) \frac{\partial^2 w}{\partial x^2} = \frac{\partial^2 w}{\partial u^2}, \left(\frac{1}{t^2} \right) \frac{\partial^2 w}{\partial y^2} = \frac{\partial^2 w}{\partial v^2}, \text{ and } \left(\frac{1}{t^2} \right) \frac{\partial^2 w}{\partial y \partial x} = \frac{\partial^2 w}{\partial v \partial u}$$

$$\Rightarrow n(n-1)t^{n-2}f(x, y) = \left(\frac{x^2}{t^2} \right) \left(\frac{\partial^2 w}{\partial u^2} \right) + \left(\frac{2xy}{t^2} \right) \left(\frac{\partial^2 w}{\partial v \partial u} \right) + \left(\frac{y^2}{t^2} \right) \left(\frac{\partial^2 w}{\partial v^2} \right) \text{ for } t \neq 0. \text{ When } t = 1, w = f(x, y) \text{ and}$$

$$\text{we have } n(n-1)f(x, y) = x^2 \left(\frac{\partial^2 f}{\partial x^2} \right) + 2xy \left(\frac{\partial^2 f}{\partial x \partial y} \right) + y^2 \left(\frac{\partial^2 f}{\partial y^2} \right) \text{ as claimed.}$$

6. (a) $\lim_{r \rightarrow 0} \frac{\sin 6r}{6r} = \lim_{t \rightarrow 0} \frac{\sin t}{t} = 1$, where $t = 6r$

$$\begin{aligned}
\text{(b) } f_r(0, 0) &= \lim_{h \rightarrow 0} \frac{f(0+h, 0) - f(0, 0)}{h} = \lim_{h \rightarrow 0} \frac{\left(\frac{\sin 6h}{6h} \right) - 1}{h} = \lim_{h \rightarrow 0} \frac{\sin 6h - 6h}{6h^2} = \lim_{h \rightarrow 0} \frac{6 \cos 6h - 6}{12h} \\
&= \lim_{h \rightarrow 0} \frac{-36 \sin 6h}{12} = 0 \quad (\text{applying L'Hôpital's rule twice})
\end{aligned}$$

$$\text{(c) } f_\theta(r, \theta) = \lim_{h \rightarrow 0} \frac{f(r, \theta+h) - f(r, \theta)}{h} = \lim_{h \rightarrow 0} \frac{\left(\frac{\sin 6r}{6r} \right) - \left(\frac{\sin 6r}{6r} \right)}{h} = \lim_{h \rightarrow 0} \frac{0}{h} = 0$$

7. (a) $\mathbf{r} = x\mathbf{i} + y\mathbf{j} + z\mathbf{k} \Rightarrow r = |\mathbf{r}| = \sqrt{x^2 + y^2 + z^2}$ and $\nabla r = \frac{x}{\sqrt{x^2 + y^2 + z^2}} \mathbf{i} + \frac{y}{\sqrt{x^2 + y^2 + z^2}} \mathbf{j} + \frac{z}{\sqrt{x^2 + y^2 + z^2}} \mathbf{k}$
 $= \frac{\mathbf{r}}{r}$

$$\begin{aligned}
\text{(b) } r^n &= \left(\sqrt{x^2 + y^2 + z^2} \right)^n \\
&\Rightarrow \nabla (r^n) = nx(x^2 + y^2 + z^2)^{(n/2)-1} \mathbf{i} + ny(x^2 + y^2 + z^2)^{(n/2)-1} \mathbf{j} + nz(x^2 + y^2 + z^2)^{(n/2)-1} \mathbf{k} \\
&= nr^{n-2} \mathbf{r}
\end{aligned}$$

- (c) Let $n = 2$ in part (b). Then $\frac{1}{2} \nabla (r^2) = \mathbf{r} \Rightarrow \nabla \left(\frac{1}{2} r^2 \right) = \mathbf{r} \Rightarrow \frac{r^2}{2} = \frac{1}{2} (x^2 + y^2 + z^2)$ is the function.

$$\begin{aligned}
\text{(d) } d\mathbf{r} &= dx\mathbf{i} + dy\mathbf{j} + dz\mathbf{k} \Rightarrow \mathbf{r} \cdot d\mathbf{r} = x dx + y dy + z dz, \text{ and } d\mathbf{r} = r_x dx + r_y dy + r_z dz = \frac{x}{r} dx + \frac{y}{r} dy + \frac{z}{r} dz \\
&\Rightarrow \mathbf{r} \cdot d\mathbf{r} = x dx + y dy + z dz = \mathbf{r} \cdot d\mathbf{r}
\end{aligned}$$

$$\text{(e) } \mathbf{A} = a\mathbf{i} + b\mathbf{j} + c\mathbf{k} \Rightarrow \mathbf{A} \cdot \mathbf{r} = ax + by + cz \Rightarrow \nabla (\mathbf{A} \cdot \mathbf{r}) = a\mathbf{i} + b\mathbf{j} + c\mathbf{k} = \mathbf{A}$$

8. $f(g(t), h(t)) = c \Rightarrow 0 = \frac{df}{dt} = \frac{\partial f}{\partial x} \frac{dx}{dt} + \frac{\partial f}{\partial y} \frac{dy}{dt} = \left(\frac{\partial f}{\partial x} \mathbf{i} + \frac{\partial f}{\partial y} \mathbf{j} \right) \cdot \left(\frac{dx}{dt} \mathbf{i} + \frac{dy}{dt} \mathbf{j} \right)$, where $\frac{dx}{dt} \mathbf{i} + \frac{dy}{dt} \mathbf{j}$ is the tangent vector
 $\Rightarrow \nabla f$ is orthogonal to the tangent vector

9. $f(x, y, z) = xz^2 - yz + \cos xy - 1 \Rightarrow \nabla f = (z^2 - y \sin xy) \mathbf{i} + (-z - x \sin xy) \mathbf{j} + (2xz - y) \mathbf{k} \Rightarrow \nabla f(0, 0, 1) = \mathbf{i} - \mathbf{j}$
 \Rightarrow the tangent plane is $x - y = 0$; $\mathbf{r} = (\ln t)\mathbf{i} + (t \ln t)\mathbf{j} + t\mathbf{k} \Rightarrow \mathbf{r}' = \left(\frac{1}{t} \right) \mathbf{i} + (\ln t + 1)\mathbf{j} + \mathbf{k}$; $x = y = 0, z = 1$
 $\Rightarrow t = 1 \Rightarrow \mathbf{r}'(1) = \mathbf{i} + \mathbf{j} + \mathbf{k}$. Since $(\mathbf{i} + \mathbf{j} + \mathbf{k}) \cdot (\mathbf{i} - \mathbf{j}) = \mathbf{r}'(1) \cdot \nabla f = 0$, \mathbf{r} is parallel to the plane, and
 $\mathbf{r}(1) = 0\mathbf{i} + 0\mathbf{j} + \mathbf{k} \Rightarrow \mathbf{r}$ is contained in the plane.

10. Let $f(x, y, z) = x^3 + y^3 + z^3 - xyz \Rightarrow \nabla f = (3x^2 - yz)\mathbf{i} + (3y^2 - xz)\mathbf{j} + (3z^2 - xy)\mathbf{k} \Rightarrow \nabla f(0, -1, 1) = \mathbf{i} + 3\mathbf{j} + 3\mathbf{k}$
 \Rightarrow the tangent plane is $x + 3y + 3z = 0$; $\mathbf{r} = \left(\frac{t}{4} - 2\right)\mathbf{i} + \left(\frac{t}{4} - 3\right)\mathbf{j} + (\cos(t - 2))\mathbf{k}$
 $\Rightarrow \mathbf{r}' = \left(\frac{3t^2}{4}\right)\mathbf{i} - \left(\frac{4}{t^2}\right)\mathbf{j} - (\sin(t - 2))\mathbf{k}$; $x = 0, y = -1, z = 1 \Rightarrow t = 2 \Rightarrow \mathbf{r}'(2) = 3\mathbf{i} - \mathbf{j}$. Since
 $\mathbf{r}'(2) \cdot \nabla f = 0 \Rightarrow \mathbf{r}$ is parallel to the plane, and $\mathbf{r}(2) = -\mathbf{i} + \mathbf{k} \Rightarrow \mathbf{r}$ is contained in the plane.

11. $\frac{\partial z}{\partial x} = 3x^2 - 9y = 0$ and $\frac{\partial z}{\partial y} = 3y^2 - 9x = 0 \Rightarrow y = \frac{1}{3}x^2$ and $3\left(\frac{1}{3}x^2\right)^2 - 9x = 0 \Rightarrow \frac{1}{3}x^4 - 9x = 0$
 $\Rightarrow x(x^3 - 27) = 0 \Rightarrow x = 0$ or $x = 3$. Now $x = 0 \Rightarrow y = 0$ or $(0, 0)$ and $x = 3 \Rightarrow y = 3$ or $(3, 3)$. Next
 $\frac{\partial^2 z}{\partial x^2} = 6x, \frac{\partial^2 z}{\partial y^2} = 6y$, and $\frac{\partial^2 z}{\partial x \partial y} = -9$. For $(0, 0), \frac{\partial^2 z}{\partial x^2} \frac{\partial^2 z}{\partial y^2} - \left(\frac{\partial^2 z}{\partial x \partial y}\right)^2 = -81 \Rightarrow$ no extremum (a saddle point),
 and for $(3, 3), \frac{\partial^2 z}{\partial x^2} \frac{\partial^2 z}{\partial y^2} - \left(\frac{\partial^2 z}{\partial x \partial y}\right)^2 = 243 > 0$ and $\frac{\partial^2 z}{\partial x^2} = 18 > 0 \Rightarrow$ a local minimum.

12. $f(x, y) = 6xye^{-(2x+3y)} \Rightarrow f_x(x, y) = 6y(1 - 2x)e^{-(2x+3y)} = 0$ and $f_y(x, y) = 6x(1 - 3y)e^{-(2x+3y)} = 0 \Rightarrow x = 0$ and
 $y = 0$, or $x = \frac{1}{2}$ and $y = \frac{1}{3}$. The value $f(0, 0) = 0$ is on the boundary, and $f\left(\frac{1}{2}, \frac{1}{3}\right) = \frac{1}{e^2}$. On the positive y -axis,
 $f(0, y) = 0$, and on the positive x -axis, $f(x, 0) = 0$. As $x \rightarrow \infty$ or $y \rightarrow \infty$ we see that $f(x, y) \rightarrow 0$. Thus the
 absolute maximum of f in the closed first quadrant is $\frac{1}{e^2}$ at the point $\left(\frac{1}{2}, \frac{1}{3}\right)$.

13. Let $f(x, y, z) = \frac{x^2}{a^2} + \frac{y^2}{b^2} + \frac{z^2}{c^2} - 1 \Rightarrow \nabla f = \frac{2x}{a^2}\mathbf{i} + \frac{2y}{b^2}\mathbf{j} + \frac{2z}{c^2}\mathbf{k} \Rightarrow$ an equation of the plane tangent at the point
 $P_0(x_0, y_0, z_0)$ is $\left(\frac{2x_0}{a^2}\right)x + \left(\frac{2y_0}{b^2}\right)y + \left(\frac{2z_0}{c^2}\right)z = \frac{2x_0^2}{a^2} + \frac{2y_0^2}{b^2} + \frac{2z_0^2}{c^2} = 2$ or $\left(\frac{x_0}{a^2}\right)x + \left(\frac{y_0}{b^2}\right)y + \left(\frac{z_0}{c^2}\right)z = 1$.
 The intercepts of the plane are $\left(\frac{a^2}{x_0}, 0, 0\right), \left(0, \frac{b^2}{y_0}, 0\right)$ and $\left(0, 0, \frac{c^2}{z_0}\right)$. The volume of the tetrahedron formed
 by the plane and the coordinate planes is $V = \left(\frac{1}{3}\right)\left(\frac{1}{2}\right)\left(\frac{a^2}{x_0}\right)\left(\frac{b^2}{y_0}\right)\left(\frac{c^2}{z_0}\right) \Rightarrow$ we need to maximize
 $V(x, y, z) = \frac{(abc)^2}{6}(xyz)^{-1}$ subject to the constraint $f(x, y, z) = \frac{x^2}{a^2} + \frac{y^2}{b^2} + \frac{z^2}{c^2} = 1$. Thus,
 $\left[-\frac{(abc)^2}{6}\right]\left(\frac{1}{x^2yz}\right) = \frac{2x}{a^2}\lambda, \left[-\frac{(abc)^2}{6}\right]\left(\frac{1}{xy^2z}\right) = \frac{2y}{b^2}\lambda$, and $\left[-\frac{(abc)^2}{6}\right]\left(\frac{1}{xyz^2}\right) = \frac{2z}{c^2}\lambda$. Multiply the first equation
 by a^2yz , the second by b^2xz , and the third by c^2xy . Then equate the first and second $\Rightarrow a^2y^2 = b^2x^2$
 $\Rightarrow y = \frac{b}{a}x, x > 0$; equate the first and third $\Rightarrow a^2z^2 = c^2x^2 \Rightarrow z = \frac{c}{a}x, x > 0$; substitute into $f(x, y, z) = 0$
 $\Rightarrow x = \frac{a}{\sqrt{3}} \Rightarrow y = \frac{b}{\sqrt{3}} \Rightarrow z = \frac{c}{\sqrt{3}} \Rightarrow V = \frac{\sqrt{3}}{2}abc$.

14. $2(x - u) = -\lambda, 2(y - v) = \lambda, -2(x - u) = \mu, \text{ and } -2(y - v) = -2\mu v \Rightarrow x - u = v - y, x - u = -\frac{\mu}{2}$, and
 $y - v = \mu v \Rightarrow x - u = -\mu v = -\frac{\mu}{2} \Rightarrow v = \frac{1}{2}$ or $\mu = 0$.
 CASE 1: $\mu = 0 \Rightarrow x = u, y = v$, and $\lambda = 0$; then $y = x + 1 \Rightarrow v = u + 1$ and $v^2 = u \Rightarrow v = v^2 + 1$
 $\Rightarrow v^2 - v + 1 = 0 \Rightarrow v = \frac{1 \pm \sqrt{1-4}}{2} \Rightarrow$ no real solution.
 CASE 2: $v = \frac{1}{2}$ and $u = v^2 \Rightarrow u = \frac{1}{4}$; $x - \frac{1}{4} = \frac{1}{2} - y$ and $y = x + 1 \Rightarrow x - \frac{1}{4} = -x - \frac{1}{2} \Rightarrow 2x = -\frac{1}{4}$
 $\Rightarrow x = -\frac{1}{8} \Rightarrow y = \frac{7}{8}$. Then $f\left(-\frac{1}{8}, \frac{7}{8}, \frac{1}{4}, \frac{1}{2}\right) = \left(-\frac{1}{8} - \frac{1}{4}\right)^2 + \left(\frac{7}{8} - \frac{1}{2}\right)^2 = 2\left(\frac{3}{8}\right)^2 \Rightarrow$ the minimum distance
 is $\frac{3}{8}\sqrt{2}$. (Notice that f has no maximum value.)

15. Let (x_0, y_0) be any point in R . We must show $\lim_{(x,y) \rightarrow (x_0,y_0)} f(x, y) = f(x_0, y_0)$ or, equivalently that
 $\lim_{(h,k) \rightarrow (0,0)} |f(x_0 + h, y_0 + k) - f(x_0, y_0)| = 0$. Consider $f(x_0 + h, y_0 + k) - f(x_0, y_0)$
 $= [f(x_0 + h, y_0 + k) - f(x_0, y_0 + k)] + [f(x_0, y_0 + k) - f(x_0, y_0)]$. Let $F(x) = f(x, y_0 + k)$ and apply the Mean Value
 Theorem: there exists ξ with $x_0 < \xi < x_0 + h$ such that $F'(\xi)h = F(x_0 + h) - F(x_0) \Rightarrow hf_x(\xi, y_0 + k)$
 $= f(x_0 + h, y_0 + k) - f(x_0, y_0 + k)$. Similarly, $kf_y(x_0, \eta) = f(x_0, y_0 + k) - f(x_0, y_0)$ for some η with
 $y_0 < \eta < y_0 + k$. Then $|f(x_0 + h, y_0 + k) - f(x_0, y_0)| \leq |hf_x(\xi, y_0 + k)| + |kf_y(x_0, \eta)|$. If M, N are positive real
 numbers such that $|f_x| \leq M$ and $|f_y| \leq N$ for all (x, y) in the xy -plane, then $|f(x_0 + h, y_0 + k) - f(x_0, y_0)|$
 $\leq M|h| + N|k|$. As $(h, k) \rightarrow 0, |f(x_0 + h, y_0 + k) - f(x_0, y_0)| \rightarrow 0 \Rightarrow \lim_{(h,k) \rightarrow (0,0)} |f(x_0 + h, y_0 + k) - f(x_0, y_0)|$

$= 0 \Rightarrow f$ is continuous at (x_0, y_0) .

16. At extreme values, ∇f and $\mathbf{v} = \frac{d\mathbf{r}}{dt}$ are orthogonal because $\frac{df}{dt} = \nabla f \cdot \frac{d\mathbf{r}}{dt} = 0$ by the First Derivative Theorem for Local Extreme Values.

17. $\frac{\partial f}{\partial x} = 0 \Rightarrow f(x, y) = h(y)$ is a function of y only. Also, $\frac{\partial g}{\partial y} = \frac{\partial f}{\partial x} = 0 \Rightarrow g(x, y) = k(x)$ is a function of x only. Moreover, $\frac{\partial f}{\partial y} = \frac{\partial g}{\partial x} \Rightarrow h'(y) = k'(x)$ for all x and y . This can happen only if $h'(y) = k'(x) = c$ is a constant. Integration gives $h(y) = cy + c_1$ and $k(x) = cx + c_2$, where c_1 and c_2 are constants. Therefore $f(x, y) = cy + c_1$ and $g(x, y) = cx + c_2$. Then $f(1, 2) = g(1, 2) = 5 \Rightarrow 5 = 2c + c_1 = c + c_2$, and $f(0, 0) = 4 \Rightarrow c_1 = 4 \Rightarrow c = \frac{1}{2} \Rightarrow c_2 = \frac{9}{2}$. Thus, $f(x, y) = \frac{1}{2}y + 4$ and $g(x, y) = \frac{1}{2}x + \frac{9}{2}$.

18. Let $g(x, y) = D_u f(x, y) = f_x(x, y)\mathbf{a} + f_y(x, y)\mathbf{b}$. Then $D_u g(x, y) = g_x(x, y)\mathbf{a} + g_y(x, y)\mathbf{b}$
 $= f_{xx}(x, y)\mathbf{a}^2 + f_{yx}(x, y)\mathbf{a}\mathbf{b} + f_{xy}(x, y)\mathbf{b}\mathbf{a} + f_{yy}(x, y)\mathbf{b}^2 = f_{xx}(x, y)\mathbf{a}^2 + 2f_{xy}(x, y)\mathbf{a}\mathbf{b} + f_{yy}(x, y)\mathbf{b}^2$.

19. Since the particle is heat-seeking, at each point (x, y) it moves in the direction of maximal temperature increase, that is in the direction of $\nabla T(x, y) = (e^{-2y} \sin x)\mathbf{i} + (2e^{-2y} \cos x)\mathbf{j}$. Since $\nabla T(x, y)$ is parallel to the particle's velocity vector, it is tangent to the path $y = f(x)$ of the particle $\Rightarrow f'(x) = \frac{2e^{-2y} \cos x}{e^{-2y} \sin x} = 2 \cot x$. Integration gives $f(x) = 2 \ln |\sin x| + C$ and $f(\frac{\pi}{4}) = 0 \Rightarrow 0 = 2 \ln |\sin \frac{\pi}{4}| + C \Rightarrow C = -2 \ln \frac{\sqrt{2}}{2} = \ln \left(\frac{2}{\sqrt{2}}\right)^2 = \ln 2$. Therefore, the path of the particle is the graph of $y = 2 \ln |\sin x| + \ln 2$.

20. The line of travel is $x = t, y = t, z = 30 - 5t$, and the bullet hits the surface $z = 2x^2 + 3y^2$ when $30 - 5t = 2t^2 + 3t^2 \Rightarrow t^2 + t - 6 = 0 \Rightarrow (t + 3)(t - 2) = 0 \Rightarrow t = 2$ (since $t > 0$). Thus the bullet hits the surface at the point $(2, 2, 20)$. Now, the vector $4x\mathbf{i} + 6y\mathbf{j} - \mathbf{k}$ is normal to the surface at any (x, y, z) , so that $\mathbf{n} = 8\mathbf{i} + 12\mathbf{j} - \mathbf{k}$ is normal to the surface at $(2, 2, 20)$. If $\mathbf{v} = \mathbf{i} + \mathbf{j} - 5\mathbf{k}$, then the velocity of the particle after the ricochet is $\mathbf{w} = \mathbf{v} - 2 \text{proj}_{\mathbf{n}} \mathbf{v} = \mathbf{v} - \left(\frac{2\mathbf{v} \cdot \mathbf{n}}{|\mathbf{n}|^2}\right) \mathbf{n} = \mathbf{v} - \left(\frac{2 \cdot 25}{209}\right) \mathbf{n} = (\mathbf{i} + \mathbf{j} - 5\mathbf{k}) - \left(\frac{400}{209}\mathbf{i} + \frac{600}{209}\mathbf{j} - \frac{50}{209}\mathbf{k}\right)$
 $= -\frac{191}{209}\mathbf{i} - \frac{391}{209}\mathbf{j} - \frac{995}{209}\mathbf{k}$.

21. (a) \mathbf{k} is a vector normal to $z = 10 - x^2 - y^2$ at the point $(0, 0, 10)$. So directions tangential to S at $(0, 0, 10)$ will be unit vectors $\mathbf{u} = a\mathbf{i} + b\mathbf{j}$. Also, $\nabla T(x, y, z) = (2xy + 4)\mathbf{i} + (x^2 + 2yz + 14)\mathbf{j} + (y^2 + 1)\mathbf{k}$
 $\Rightarrow \nabla T(0, 0, 10) = 4\mathbf{i} + 14\mathbf{j} + \mathbf{k}$. We seek the unit vector $\mathbf{u} = a\mathbf{i} + b\mathbf{j}$ such that $D_u T(0, 0, 10) = (4\mathbf{i} + 14\mathbf{j} + \mathbf{k}) \cdot (a\mathbf{i} + b\mathbf{j}) = (4\mathbf{i} + 14\mathbf{j}) \cdot (a\mathbf{i} + b\mathbf{j})$ is a maximum. The maximum will occur when $a\mathbf{i} + b\mathbf{j}$ has the same direction as $4\mathbf{i} + 14\mathbf{j}$, or $\mathbf{u} = \frac{1}{\sqrt{53}}(2\mathbf{i} + 7\mathbf{j})$.

(b) A vector normal to S at $(1, 1, 8)$ is $\mathbf{n} = 2\mathbf{i} + 2\mathbf{j} + \mathbf{k}$. Now, $\nabla T(1, 1, 8) = 6\mathbf{i} + 31\mathbf{j} + 2\mathbf{k}$ and we seek the unit vector \mathbf{u} such that $D_u T(1, 1, 8) = \nabla T \cdot \mathbf{u}$ has its largest value. Now write $\nabla T = \mathbf{v} + \mathbf{w}$, where \mathbf{v} is parallel to ∇T and \mathbf{w} is orthogonal to ∇T . Then $D_u T = \nabla T \cdot \mathbf{u} = (\mathbf{v} + \mathbf{w}) \cdot \mathbf{u} = \mathbf{v} \cdot \mathbf{u} + \mathbf{w} \cdot \mathbf{u} = \mathbf{w} \cdot \mathbf{u}$. Thus $D_u T(1, 1, 8)$ is a maximum when \mathbf{u} has the same direction as \mathbf{w} . Now, $\mathbf{w} = \nabla T - \left(\frac{\nabla T \cdot \mathbf{n}}{|\mathbf{n}|^2}\right) \mathbf{n}$
 $= (6\mathbf{i} + 31\mathbf{j} + 2\mathbf{k}) - \left(\frac{12+62+2}{4+4+1}\right)(2\mathbf{i} + 2\mathbf{j} + \mathbf{k}) = (6 - \frac{152}{9})\mathbf{i} + (31 - \frac{152}{9})\mathbf{j} + (2 - \frac{76}{9})\mathbf{k}$
 $= -\frac{98}{9}\mathbf{i} + \frac{127}{9}\mathbf{j} - \frac{58}{9}\mathbf{k} \Rightarrow \mathbf{u} = \frac{\mathbf{w}}{|\mathbf{w}|} = -\frac{1}{\sqrt{29,097}}(98\mathbf{i} - 127\mathbf{j} + 58\mathbf{k})$.

22. Suppose the surface (boundary) of the mineral deposit is the graph of $z = f(x, y)$ (where the z -axis points up into the air). Then $-\frac{\partial f}{\partial x}\mathbf{i} - \frac{\partial f}{\partial y}\mathbf{j} + \mathbf{k}$ is an outer normal to the mineral deposit at (x, y) and $\frac{\partial f}{\partial x}\mathbf{i} + \frac{\partial f}{\partial y}\mathbf{j}$ points in the direction of steepest ascent of the mineral deposit. This is in the direction of the vector $\frac{\partial f}{\partial x}\mathbf{i} + \frac{\partial f}{\partial y}\mathbf{j}$ at $(0, 0)$ (the location of the 1st borehole) that the geologists should drill their fourth borehole. To approximate this vector we use the fact that $(0, 0, -1000)$, $(0, 100, -950)$, and $(100, 0, -1025)$ lie on the graph of $z = f(x, y)$. The plane containing these three points is a good approximation to the tangent plane to $z = f(x, y)$ at the point

(0, 0, 0). A normal to this plane is $\begin{vmatrix} \mathbf{i} & \mathbf{j} & \mathbf{k} \\ 0 & 100 & 50 \\ 100 & 0 & -25 \end{vmatrix} = -2500\mathbf{i} + 5000\mathbf{j} - 10,000\mathbf{k}$, or $-\mathbf{i} + 2\mathbf{j} - 4\mathbf{k}$. So at

(0, 0) the vector $\frac{\partial f}{\partial x} \mathbf{i} + \frac{\partial f}{\partial y} \mathbf{j}$ is approximately $-\mathbf{i} + 2\mathbf{j}$. Thus the geologists should drill their fourth borehole in the direction of $\frac{1}{\sqrt{5}}(-\mathbf{i} + 2\mathbf{j})$ from the first borehole.

23. $w = e^{rt} \sin \pi x \Rightarrow w_t = re^{rt} \sin \pi x$ and $w_x = \pi e^{rt} \cos \pi x \Rightarrow w_{xx} = -\pi^2 e^{rt} \sin \pi x$; $w_{xx} = \frac{1}{c^2} w_t$, where c^2 is the positive constant determined by the material of the rod $\Rightarrow -\pi^2 e^{rt} \sin \pi x = \frac{1}{c^2} (re^{rt} \sin \pi x)$
 $\Rightarrow (r + c^2 \pi^2) e^{rt} \sin \pi x = 0 \Rightarrow r = -c^2 \pi^2 \Rightarrow w = e^{-c^2 \pi^2 t} \sin \pi x$

24. $w = e^{rt} \sin kx \Rightarrow w_t = re^{rt} \sin kx$ and $w_x = ke^{rt} \cos kx \Rightarrow w_{xx} = -k^2 e^{rt} \sin kx$; $w_{xx} = \frac{1}{c^2} w_t$
 $\Rightarrow -k^2 e^{rt} \sin kx = \frac{1}{c^2} (re^{rt} \sin kx) \Rightarrow (r + c^2 k^2) e^{rt} \sin kx = 0 \Rightarrow r = -c^2 k^2 \Rightarrow w = e^{-c^2 k^2 t} \sin kx$.
 Now, $w(L, t) = 0 \Rightarrow e^{-c^2 k^2 t} \sin kL = 0 \Rightarrow kL = n\pi$ for n an integer $\Rightarrow k = \frac{n\pi}{L} \Rightarrow w = e^{-c^2 n^2 \pi^2 t / L^2} \sin \left(\frac{n\pi}{L} x \right)$.
 As $t \rightarrow \infty$, $w \rightarrow 0$ since $|\sin \left(\frac{n\pi}{L} x \right)| \leq 1$ and $e^{-c^2 n^2 \pi^2 t / L^2} \rightarrow 0$.

CHAPTER 15 MULTIPLE INTEGRALS

15.1 DOUBLE INTEGRALS

$$1. \int_0^3 \int_0^2 (4 - y^2) dy dx = \int_0^3 \left[4y - \frac{y^3}{3} \right]_0^2 dx = \frac{16}{3} \int_0^3 dx = 16$$

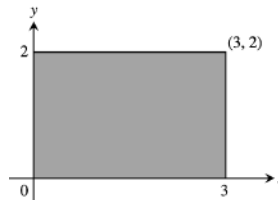

$$2. \int_0^3 \int_{-2}^0 ((x^2y - 2xy) dy dx = \int_0^3 \left[\frac{x^2y^2}{2} - xy^2 \right]_{-2}^0 dx$$

$$= \int_0^3 (4x - 2x^2) dx = \left[2x^2 - \frac{2x^3}{3} \right]_0^3 = 0$$

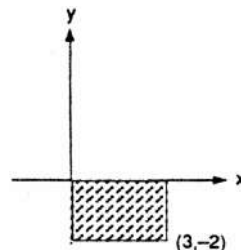

$$3. \int_{-1}^0 \int_{-1}^1 (x + y + 1) dx dy = \int_{-1}^0 \left[\frac{x^2}{2} + yx + x \right]_{-1}^1 dy$$

$$= \int_{-1}^0 (2y + 2) dy = [y^2 + 2y]_{-1}^0 = 1$$

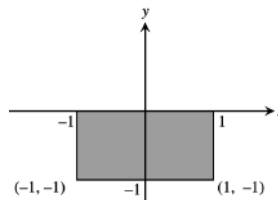

$$4. \int_{\pi}^{2\pi} \int_0^{\pi} (\sin x + \cos y) dx dy = \int_{\pi}^{2\pi} [(-\cos x) + (\cos y)x]_0^{\pi} dy$$

$$= \int_{\pi}^{2\pi} (\pi \cos y + 2) dy = [\pi \sin y + 2y]_{\pi}^{2\pi} = 2\pi$$

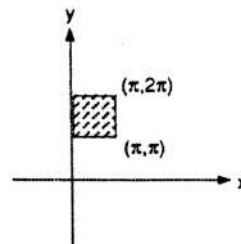

$$5. \int_0^{\pi} \int_0^x (x \sin y) dy dx = \int_0^{\pi} [-x \cos y]_0^x dx$$

$$= \int_0^{\pi} (x - x \cos x) dx = \left[\frac{x^2}{2} - (\cos x + x \sin x) \right]_0^{\pi}$$

$$= \frac{\pi^2}{2} + 2$$

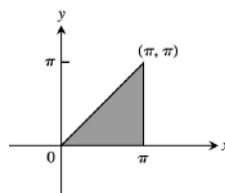

$$6. \int_0^{\pi} \int_0^{\sin x} y dy dx = \int_0^{\pi} \left[\frac{y^2}{2} \right]_0^{\sin x} dx = \int_0^{\pi} \frac{1}{2} \sin^2 x dx$$

$$= \frac{1}{4} \int_0^{\pi} (1 - \cos 2x) dx = \frac{1}{4} \left[x - \frac{1}{2} \sin 2x \right]_0^{\pi} = \frac{\pi}{4}$$

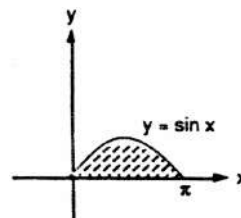

$$\begin{aligned}
 7. \int_1^{\ln 8} \int_0^{\ln y} e^{x+y} dx dy &= \int_1^{\ln 8} [e^{x+y}]_0^{\ln y} dy = \int_1^{\ln 8} (ye^y - e^y) dy \\
 &= [(y-1)e^y - e^y]_1^{\ln 8} = 8(\ln 8 - 1) - 8 + e \\
 &= 8 \ln 8 - 16 + e
 \end{aligned}$$

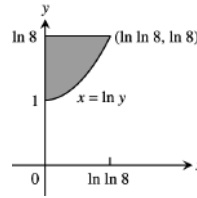

$$\begin{aligned}
 8. \int_1^2 \int_y^{y^2} dx dy &= \int_1^2 (y^2 - y) dy = \left[\frac{y^3}{3} - \frac{y^2}{2} \right]_1^2 \\
 &= \left(\frac{8}{3} - 2 \right) - \left(\frac{1}{3} - \frac{1}{2} \right) = \frac{7}{3} - \frac{3}{2} = \frac{5}{6}
 \end{aligned}$$

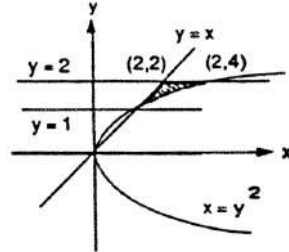

$$\begin{aligned}
 9. \int_0^1 \int_0^{y^2} 3y^3 e^{xy} dx dy &= \int_0^1 [3y^2 e^{xy}]_0^{y^2} dy \\
 &= \int_0^1 (3y^2 e^{y^3} - 3y^2) dy = [e^{y^3} - y^3]_0^1 = e - 2
 \end{aligned}$$

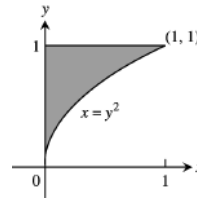

$$\begin{aligned}
 10. \int_1^4 \int_0^{\sqrt{x}} \frac{3}{2} e^{y/\sqrt{x}} dy dx &= \int_1^4 \left[\frac{3}{2} \sqrt{x} e^{y/\sqrt{x}} \right]_0^{\sqrt{x}} dx \\
 &= \frac{3}{2} (e - 1) \int_1^4 \sqrt{x} dx = \left[\frac{3}{2} (e - 1) \left(\frac{2}{3} \right) x^{3/2} \right]_1^4 = 7(e - 1)
 \end{aligned}$$

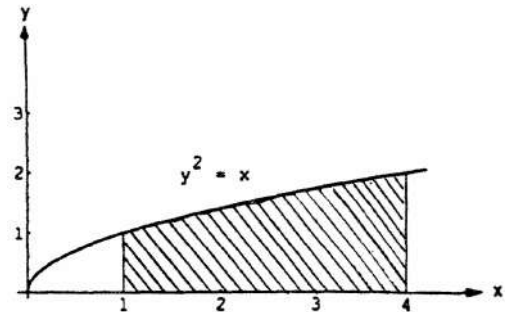

$$11. \int_1^2 \int_x^{2x} \frac{x}{y} dy dx = \int_1^2 [x \ln y]_x^{2x} dx = (\ln 2) \int_1^2 x dx = \frac{3}{2} \ln 2$$

$$12. \int_1^2 \int_1^2 \frac{1}{xy} dy dx = \int_1^2 \frac{1}{x} (\ln 2 - \ln 1) dx = (\ln 2) \int_1^2 dx = (\ln 2)^2$$

$$\begin{aligned}
 13. \int_0^1 \int_0^{1-x} (x^2 + y^2) dy dx &= \int_0^1 \left[x^2 y + \frac{y^3}{3} \right]_0^{1-x} dx = \int_0^1 \left[x^2(1-x) + \frac{(1-x)^3}{3} \right] dx \\
 &= \left[\frac{x^3}{3} - \frac{x^4}{4} - \frac{(1-x)^4}{12} \right]_0^1 = \left(\frac{1}{3} - \frac{1}{4} - 0 \right) - \left(0 - 0 - \frac{1}{12} \right) = \frac{1}{6}
 \end{aligned}$$

$$14. \int_0^1 \int_0^\pi y \cos xy dx dy = \int_0^1 [\sin xy]_0^\pi dy = \int_0^1 \sin \pi y dy = \left[-\frac{1}{\pi} \cos \pi y \right]_0^1 = -\frac{1}{\pi} (-1 - 1) = \frac{2}{\pi}$$

$$\begin{aligned}
 15. \int_0^1 \int_0^{1-u} (v - \sqrt{u}) dv du &= \int_0^1 \left[\frac{v^2}{2} - v\sqrt{u} \right]_0^{1-u} du = \int_0^1 \left[\frac{1-2u+u^2}{2} - \sqrt{u}(1-u) \right] du \\
 &= \int_0^1 \left(\frac{1}{2} - u + \frac{u^2}{2} - u^{1/2} + u^{3/2} \right) du = \left[\frac{u}{2} - \frac{u^2}{2} + \frac{u^3}{6} - \frac{2}{3} u^{3/2} + \frac{2}{5} u^{5/2} \right]_0^1 = \frac{1}{2} - \frac{1}{2} + \frac{1}{6} - \frac{2}{3} + \frac{2}{5} = -\frac{1}{2} + \frac{2}{5} = -\frac{1}{10}
 \end{aligned}$$

$$16. \int_1^2 \int_0^{\ln t} e^s \ln t \, ds \, dt = \int_1^2 [e^s \ln t]_0^{\ln t} \, dt = \int_1^2 (t \ln t - \ln t) \, dt = \left[\frac{t^2}{2} \ln t - \frac{t^2}{4} - t \ln t + t \right]_1^2$$

$$= (2 \ln 2 - 1 - 2 \ln 2 + 2) - \left(-\frac{1}{4} + 1\right) = \frac{1}{4}$$

$$17. \int_{-2}^0 \int_v^{-v} 2 \, dp \, dv = 2 \int_{-2}^0 [p]_v^{-v} \, dv = 2 \int_{-2}^0 -2v \, dv$$

$$= -2 [v^2]_{-2}^0 = 8$$

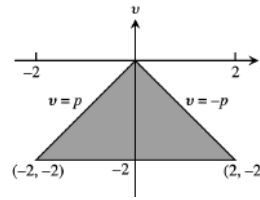

$$18. \int_0^1 \int_0^{\sqrt{1-s^2}} 8t \, dt \, ds = \int_0^1 [4t^2]_0^{\sqrt{1-s^2}} \, ds$$

$$= \int_0^1 4(1-s^2) \, ds = 4 \left[s - \frac{s^3}{3} \right]_0^1 = \frac{8}{3}$$

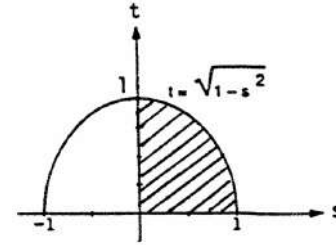

$$19. \int_{-\pi/3}^{\pi/3} \int_0^{\sec t} 3 \cos t \, du \, dt = \int_{-\pi/3}^{\pi/3} [(3 \cos t)u]_0^{\sec t} \, dt$$

$$= \int_{-\pi/3}^{\pi/3} 3 \, dt = 2\pi$$

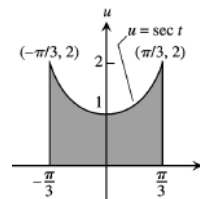

$$20. \int_0^3 \int_1^{4-2u} \frac{4-2u}{v^2} \, dv \, du = \int_0^3 \left[\frac{2u-4}{v} \right]_1^{4-2u} \, du$$

$$= \int_0^3 (3-2u) \, du = [3u - u^2]_0^3 = 0$$

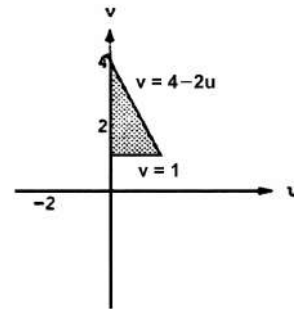

$$21. \int_2^4 \int_0^{(4-y)/2} dx \, dy$$

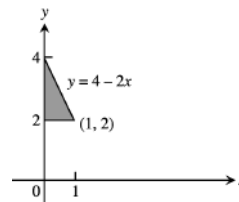

$$22. \int_{-2}^0 \int_0^{x+2} dy \, dx$$

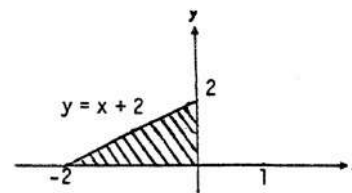

23. $\int_0^1 \int_{x^2}^x dy dx$

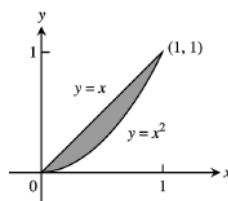

24. $\int_0^1 \int_{1-y}^{\sqrt{1-y}} dx dy$

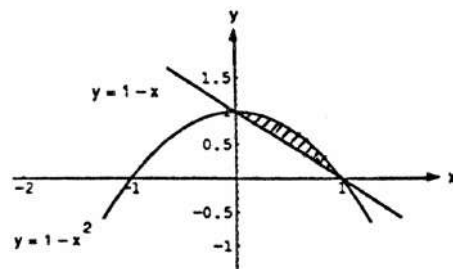

25. $\int_1^e \int_{\ln y}^1 dx dy$

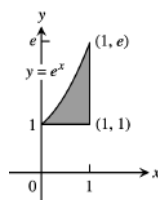

26. $\int_1^2 \int_0^{\ln x} dy dx$

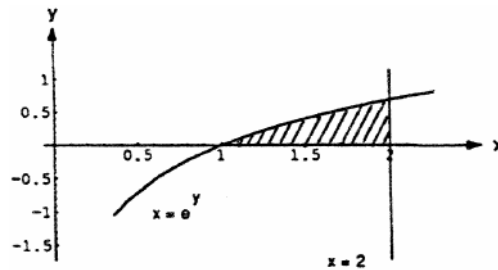

27. $\int_0^9 \int_0^{\frac{1}{2}\sqrt{9-y}} 16x dx dy$

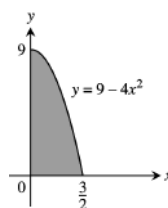

28. $\int_0^4 \int_0^{\sqrt{4-x}} y dy dx$

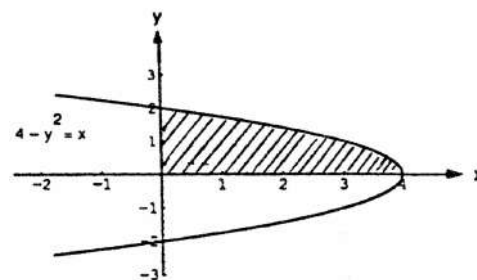

29. $\int_{-1}^1 \int_0^{\sqrt{1-x^2}} 3y \, dy \, dx$

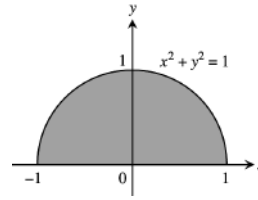

30. $\int_{-2}^2 \int_0^{\sqrt{4-y^2}} 6x \, dx \, dy$

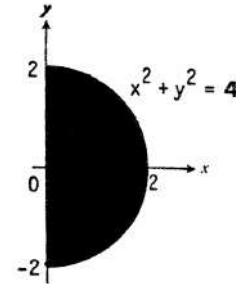

31. $\int_0^\pi \int_x^\pi \frac{\sin y}{y} \, dy \, dx = \int_0^\pi \int_0^y \frac{\sin y}{y} \, dx \, dy = \int_0^\pi \sin y \, dy = 2$

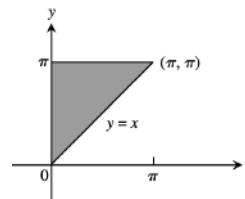

32. $\int_0^2 \int_x^2 2y^2 \sin xy \, dy \, dx = \int_0^2 \int_0^y 2y^2 \sin xy \, dx \, dy$
 $= \int_0^2 [-2y \cos xy]_0^y \, dy = \int_0^2 (-2y \cos y^2 + 2y) \, dy$
 $= [-\sin y^2 + y^2]_0^2 = 4 - \sin 4$

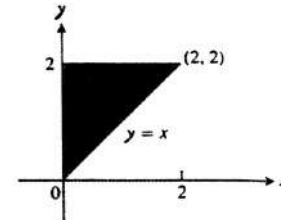

33. $\int_0^1 \int_y^1 x^2 e^{xy} \, dx \, dy = \int_0^1 \int_0^x x^2 e^{xy} \, dy \, dx = \int_0^1 [x e^{xy}]_0^x \, dx$
 $= \int_0^1 (x e^{x^2} - x) \, dx = \left[\frac{1}{2} e^{x^2} - \frac{x^2}{2} \right]_0^1 = \frac{e-2}{2}$

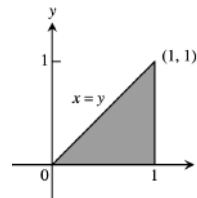

34. $\int_0^2 \int_0^{4-x^2} \frac{x e^{2y}}{4-y} \, dy \, dx = \int_0^4 \int_0^{\sqrt{4-y}} \frac{x e^{2y}}{4-y} \, dx \, dy$
 $= \int_0^4 \left[\frac{x^2 e^{2y}}{2(4-y)} \right]_0^{\sqrt{4-y}} \, dy = \int_0^4 \frac{e^{2y}}{2} \, dy = \left[\frac{e^{2y}}{4} \right]_0^4 = \frac{e^8 - 1}{4}$

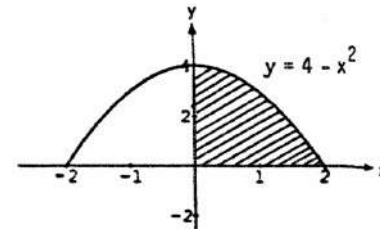

35. $\int_0^{2\sqrt{\ln 3}} \int_{y/2}^{\sqrt{\ln 3}} e^{x^2} \, dx \, dy = \int_0^{\sqrt{\ln 3}} \int_0^{2x} e^{x^2} \, dy \, dx$
 $= \int_0^{\sqrt{\ln 3}} 2x e^{x^2} \, dx = [e^{x^2}]_0^{\sqrt{\ln 3}} = e^{\ln 3} - 1 = 2$

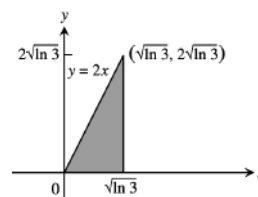

$$36. \int_0^3 \int_{\sqrt{x/3}}^1 e^{y^3} dy dx = \int_0^1 \int_0^{3y^2} e^{y^3} dx dy$$

$$= \int_0^1 3y^2 e^{y^3} dy = [e^{y^3}]_0^1 = e - 1$$

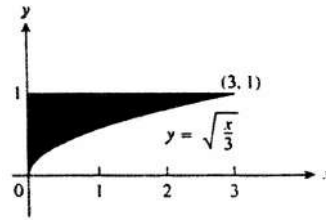

$$37. \int_0^{1/16} \int_{y^{1/4}}^{1/2} \cos(16\pi x^5) dx dy = \int_0^{1/2} \int_0^{x^4} \cos(16\pi x^5) dy dx$$

$$= \int_0^{1/2} x^4 \cos(16\pi x^5) dx = \left[\frac{\sin(16\pi x^5)}{80\pi} \right]_0^{1/2} = \frac{1}{80\pi}$$

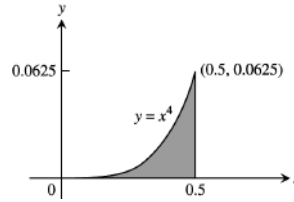

$$38. \int_0^8 \int_{\sqrt[3]{x}}^2 \frac{1}{y^4+1} dy dx = \int_0^2 \int_0^{y^3} \frac{1}{y^4+1} dx dy$$

$$= \int_0^2 \frac{y^3}{y^4+1} dy = \frac{1}{4} [\ln(y^4+1)]_0^2 = \frac{\ln 17}{4}$$

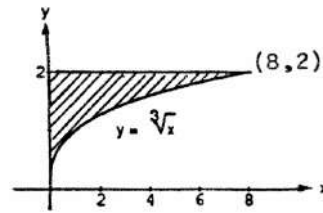

$$39. \iint_R (y - 2x^2) dA$$

$$= \int_{-1}^0 \int_{-x-1}^{x+1} (y - 2x^2) dy dx + \int_0^1 \int_{x-1}^{1-x} (y - 2x^2) dy dx$$

$$= \int_{-1}^0 \left[\frac{1}{2} y^2 - 2x^2 y \right]_{-x-1}^{x+1} dx + \int_0^1 \left[\frac{1}{2} y^2 - 2x^2 y \right]_{x-1}^{1-x} dx$$

$$= \int_{-1}^0 \left[\frac{1}{2} (x+1)^2 - 2x^2(x+1) - \frac{1}{2} (-x-1)^2 + 2x^2(-x-1) \right] dx$$

$$+ \int_0^1 \left[\frac{1}{2} (1-x)^2 - 2x^2(1-x) - \frac{1}{2} (x-1)^2 + 2x^2(x-1) \right] dx$$

$$= -4 \int_{-1}^0 (x^3 + x^2) dx + 4 \int_0^1 (x^3 - x^2) dx$$

$$= -4 \left[\frac{x^4}{4} + \frac{x^3}{3} \right]_{-1}^0 + 4 \left[\frac{x^4}{4} - \frac{x^3}{3} \right]_0^1 = 4 \left[\frac{(-1)^4}{4} + \frac{(-1)^3}{3} \right] + 4 \left(\frac{1}{4} - \frac{1}{3} \right) = 8 \left(\frac{3}{12} - \frac{4}{12} \right) = -\frac{8}{12} = -\frac{2}{3}$$

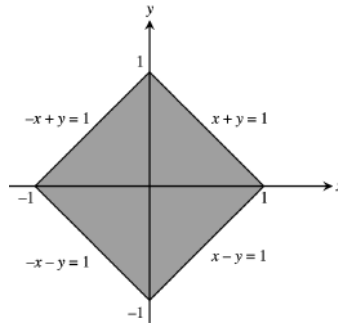

$$40. \iint_R xy dA = \int_0^{2/3} \int_x^{2x} xy dy dx + \int_{2/3}^1 \int_x^{2-x} xy dy dx$$

$$= \int_0^{2/3} \left[\frac{1}{2} xy^2 \right]_x^{2x} dx + \int_{2/3}^1 \left[\frac{1}{2} xy^2 \right]_x^{2-x} dx$$

$$= \int_0^{2/3} (2x^3 - \frac{1}{2} x^3) dx + \int_{2/3}^1 \left[\frac{1}{2} x(2-x)^2 - \frac{1}{2} x^3 \right] dx$$

$$= \int_0^{2/3} \frac{3}{2} x^3 dx + \int_{2/3}^1 (2x - x^2) dx$$

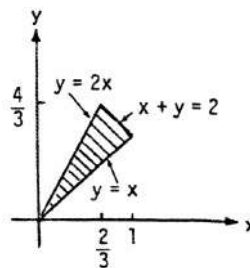

$$= \left[\frac{3}{8} x^4 \right]_0^{2/3} + \left[x^2 - \frac{2}{3} x^3 \right]_{2/3}^1 = \left(\frac{3}{8} \right) \left(\frac{16}{81} \right) + \left(1 - \frac{2}{3} \right) - \left[\frac{4}{9} - \left(\frac{2}{3} \right) \left(\frac{8}{27} \right) \right] = \frac{6}{81} + \frac{27}{81} - \left(\frac{36}{81} - \frac{16}{81} \right) = \frac{13}{81}$$

$$41. V = \int_0^1 \int_x^{2-x} (x^2 + y^2) dy dx = \int_0^1 \left[x^2 y + \frac{y^3}{3} \right]_x^{2-x} dx = \int_0^1 \left[2x^2 - \frac{7x^3}{3} + \frac{(2-x)^3}{3} \right] dx = \left[\frac{2x^3}{3} - \frac{7x^4}{12} - \frac{(2-x)^4}{12} \right]_0^1$$

$$= \left(\frac{2}{3} - \frac{7}{12} - \frac{1}{12} \right) - \left(0 - 0 - \frac{16}{12} \right) = \frac{4}{3}$$

$$42. V = \int_{-2}^1 \int_x^{2-x^2} x^2 dy dx = \int_{-2}^1 [x^2 y]_x^{2-x^2} dx = \int_{-2}^1 (2x^2 - x^4 - x^3) dx = \left[\frac{2}{3} x^3 - \frac{1}{5} x^5 - \frac{1}{4} x^4 \right]_{-2}^1$$

$$= \left(\frac{2}{3} - \frac{1}{5} - \frac{1}{4} \right) - \left(-\frac{16}{3} + \frac{32}{5} - \frac{16}{4} \right) = \left(\frac{40}{60} - \frac{12}{60} - \frac{15}{60} \right) - \left(-\frac{320}{60} + \frac{384}{60} - \frac{240}{60} \right) = \frac{189}{60} = \frac{63}{20}$$

43.
$$\begin{aligned} V &= \int_{-4}^1 \int_{3x}^{4-x^2} (x+4) \, dy \, dx = \int_{-4}^1 [xy + 4y]_{3x}^{4-x^2} \, dx = \int_{-4}^1 [x(4-x^2) + 4(4-x^2) - 3x^2 - 12x] \, dx \\ &= \int_{-4}^1 (-x^3 - 7x^2 - 8x + 16) \, dx = \left[-\frac{1}{4}x^4 - \frac{7}{3}x^3 - 4x^2 + 16x\right]_{-4}^1 = \left(-\frac{1}{4} - \frac{7}{3} + 12\right) - \left(\frac{64}{3} - 64\right) \\ &= \frac{157}{3} - \frac{1}{4} = \frac{625}{12} \end{aligned}$$
44.
$$\begin{aligned} V &= \int_0^2 \int_0^{\sqrt{4-x^2}} (3-y) \, dy \, dx = \int_0^2 \left[3y - \frac{y^2}{2}\right]_0^{\sqrt{4-x^2}} \, dx = \int_0^2 \left[3\sqrt{4-x^2} - \left(\frac{4-x^2}{2}\right)\right] \, dx \\ &= \left[\frac{3}{2}x\sqrt{4-x^2} + 6\sin^{-1}\left(\frac{x}{2}\right) - 2x + \frac{x^3}{6}\right]_0^2 = 6\left(\frac{\pi}{2}\right) - 4 + \frac{8}{6} = 3\pi - \frac{16}{6} = \frac{9\pi-8}{3} \end{aligned}$$
45.
$$V = \int_0^2 \int_0^3 (4-y^2) \, dx \, dy = \int_0^2 [4x - y^2x]_0^3 \, dy = \int_0^2 (12 - 3y^2) \, dy = [12y - y^3]_0^2 = 24 - 8 = 16$$
46.
$$\begin{aligned} V &= \int_0^2 \int_0^{4-x^2} (4-x^2-y) \, dy \, dx = \int_0^2 \left[(4-x^2)y - \frac{y^2}{2}\right]_0^{4-x^2} \, dx = \int_0^2 \frac{1}{2}(4-x^2)^2 \, dx = \int_0^2 \left(8 - 4x^2 + \frac{x^4}{2}\right) \, dx \\ &= \left[8x - \frac{4}{3}x^3 + \frac{1}{10}x^5\right]_0^2 = 16 - \frac{32}{3} + \frac{32}{10} = \frac{480-320+96}{30} = \frac{128}{15} \end{aligned}$$
47.
$$\begin{aligned} V &= \int_0^2 \int_0^{2-x} (12-3y^2) \, dy \, dx = \int_0^2 [12y - y^3]_0^{2-x} \, dx = \int_0^2 [24 - 12x - (2-x)^3] \, dx \\ &= \left[24x - 6x^2 + \frac{(2-x)^4}{4}\right]_0^2 = 20 \end{aligned}$$
48.
$$V = \int_{-1}^0 \int_{-x-1}^{x+1} (3-3x) \, dy \, dx + \int_0^1 \int_{x-1}^{1-x} (3-3x) \, dy \, dx = 6 \int_{-1}^0 (1-x^2) \, dx + 6 \int_0^1 (1-x)^2 \, dx = 4 + 2 = 6$$
49.
$$\begin{aligned} V &= \int_1^2 \int_{-1/x}^{1/x} (x+1) \, dy \, dx = \int_1^2 [xy + y]_{-1/x}^{1/x} \, dx = \int_1^2 \left[1 + \frac{1}{x} - \left(-1 - \frac{1}{x}\right)\right] \, dx = 2 \int_1^2 \left(1 + \frac{1}{x}\right) \, dx \\ &= 2 \left[x + \ln x\right]_1^2 = 2(1 + \ln 2) \end{aligned}$$
50.
$$\begin{aligned} V &= 4 \int_0^{\pi/3} \int_0^{\sec x} (1+y^2) \, dy \, dx = 4 \int_0^{\pi/3} \left[y + \frac{y^3}{3}\right]_0^{\sec x} \, dx = 4 \int_0^{\pi/3} \left(\sec x + \frac{\sec^3 x}{3}\right) \, dx \\ &= \frac{2}{3} [7 \ln |\sec x + \tan x| + \sec x \tan x]_0^{\pi/3} = \frac{2}{3} [7 \ln(2 + \sqrt{3}) + 2\sqrt{3}] \end{aligned}$$
51.
$$\int_1^\infty \int_{e^{-x}}^1 \frac{1}{x^3 y} \, dy \, dx = \int_1^\infty \left[\frac{\ln y}{x^3}\right]_{e^{-x}}^1 \, dx = \int_1^\infty -\left(\frac{-x}{x^3}\right) \, dx = -\lim_{b \rightarrow \infty} \left[\frac{1}{x}\right]_1^b = -\lim_{b \rightarrow \infty} \left(\frac{1}{b} - 1\right) = 1$$
52.
$$\begin{aligned} \int_{-1}^1 \int_{-1/\sqrt{1-x^2}}^{1/\sqrt{1-x^2}} (2y+1) \, dy \, dx &= \int_{-1}^1 [y^2 + y]_{-1/(1-x^2)^{1/2}}^{1/(1-x^2)^{1/2}} \, dx = \int_{-1}^1 \frac{2}{\sqrt{1-x^2}} \, dx = 4 \lim_{b \rightarrow 1^-} [\sin^{-1} x]_0^b \\ &= 4 \lim_{b \rightarrow 1^-} [\sin^{-1} b - 0] = 2\pi \end{aligned}$$
53.
$$\begin{aligned} \int_{-\infty}^\infty \int_{-\infty}^\infty \frac{1}{(x^2+1)(y^2+1)} \, dx \, dy &= 2 \int_0^\infty \left(\frac{2}{y^2+1}\right) \left(\lim_{b \rightarrow \infty} \tan^{-1} b - \tan^{-1} 0\right) \, dy = 2\pi \lim_{b \rightarrow \infty} \int_0^b \frac{1}{y^2+1} \, dy \\ &= 2\pi \left(\lim_{b \rightarrow \infty} \tan^{-1} b - \tan^{-1} 0\right) = (2\pi) \left(\frac{\pi}{2}\right) = \pi^2 \end{aligned}$$
54.
$$\begin{aligned} \int_0^\infty \int_0^\infty x e^{-(x+2y)} \, dx \, dy &= \int_0^\infty e^{-2y} \lim_{b \rightarrow \infty} [-xe^{-x} - e^{-x}]_0^b \, dy = \int_0^\infty e^{-2y} \lim_{b \rightarrow \infty} (-be^{-b} - e^{-b} + 1) \, dy \\ &= \int_0^\infty e^{-2y} \, dy = \frac{1}{2} \lim_{b \rightarrow \infty} (-e^{-2b} + 1) = \frac{1}{2} \end{aligned}$$
55.
$$\begin{aligned} \iint_R f(x,y) \, dA &\approx \frac{1}{4} f\left(-\frac{1}{2}, 0\right) + \frac{1}{8} f(0,0) + \frac{1}{8} f\left(\frac{1}{4}, 0\right) + \frac{1}{4} f\left(\frac{1}{2}, 0\right) + \frac{1}{4} f\left(-\frac{1}{2}, \frac{1}{2}\right) + \frac{1}{8} f\left(0, \frac{1}{2}\right) + \frac{1}{8} f\left(\frac{1}{4}, \frac{1}{2}\right) \\ &= \frac{1}{4} \left(-\frac{1}{2} + \frac{1}{2} + 0\right) + \frac{1}{8} \left(0 + \frac{1}{4} + \frac{1}{2} + \frac{3}{4}\right) = \frac{3}{16} \end{aligned}$$

$$\begin{aligned}
 56. \iint_R f(x, y) \, dA &\approx \frac{1}{4} \left[f\left(\frac{7}{4}, \frac{9}{4}\right) + f\left(\frac{9}{4}, \frac{9}{4}\right) + f\left(\frac{5}{4}, \frac{11}{4}\right) + f\left(\frac{7}{4}, \frac{11}{4}\right) + f\left(\frac{9}{4}, \frac{11}{4}\right) + f\left(\frac{11}{4}, \frac{11}{4}\right) + f\left(\frac{5}{4}, \frac{13}{4}\right) + f\left(\frac{7}{4}, \frac{13}{4}\right) \right. \\
 &\quad \left. + f\left(\frac{9}{4}, \frac{13}{4}\right) + f\left(\frac{11}{4}, \frac{13}{4}\right) + f\left(\frac{7}{4}, \frac{15}{4}\right) + f\left(\frac{9}{4}, \frac{15}{4}\right) \right] \\
 &= \frac{1}{16} (25 + 27 + 27 + 29 + 31 + 33 + 31 + 33 + 35 + 37 + 37 + 39) = \frac{384}{16} = 24
 \end{aligned}$$

57. The ray $\theta = \frac{\pi}{6}$ meets the circle $x^2 + y^2 = 4$ at the point $(\sqrt{3}, 1) \Rightarrow$ the ray is represented by the line $y = \frac{x}{\sqrt{3}}$.

$$\begin{aligned}
 \text{Thus, } \iint_R f(x, y) \, dA &= \int_0^{\sqrt{3}} \int_{x/\sqrt{3}}^{\sqrt{4-x^2}} \sqrt{4-x^2} \, dy \, dx = \int_0^{\sqrt{3}} \left[(4-x^2) - \frac{x}{\sqrt{3}} \sqrt{4-x^2} \right] dx = \left[4x - \frac{x^3}{3} + \frac{(4-x^2)^{3/2}}{3\sqrt{3}} \right]_0^{\sqrt{3}} \\
 &= \frac{20\sqrt{3}}{9}
 \end{aligned}$$

$$\begin{aligned}
 58. \int_2^\infty \int_0^{2-x} \frac{1}{(x^2-x)(y-1)^{2/3}} \, dy \, dx &= \int_2^\infty \left[\frac{3(y-1)^{1/3}}{(x^2-x)} \right]_0^{2-x} dx = \int_2^\infty \left(\frac{3}{x^2-x} + \frac{3}{x^2-x} \right) dx = 6 \int_2^\infty \frac{dx}{x(x-1)} \\
 &= 6 \lim_{b \rightarrow \infty} \int_2^b \left(\frac{1}{x-1} - \frac{1}{x} \right) dx = 6 \lim_{b \rightarrow \infty} [\ln(x-1) - \ln x]_2^b = 6 \lim_{b \rightarrow \infty} [\ln(b-1) - \ln b - \ln 1 + \ln 2] \\
 &= 6 \left[\lim_{b \rightarrow \infty} \ln \left(1 - \frac{1}{b} \right) + \ln 2 \right] = 6 \ln 2
 \end{aligned}$$

$$\begin{aligned}
 59. V &= \int_0^1 \int_x^{2-x} (x^2 + y^2) \, dy \, dx = \int_0^1 \left[x^2 y + \frac{y^3}{3} \right]_x^{2-x} dx \\
 &= \int_0^1 \left[2x^2 - \frac{7x^3}{3} + \frac{(2-x)^3}{3} \right] dx = \left[\frac{2x^3}{3} - \frac{7x^4}{12} - \frac{(2-x)^4}{12} \right]_0^1 \\
 &= \left(\frac{2}{3} - \frac{7}{12} - \frac{1}{12} \right) - (0 - 0 - \frac{16}{12}) = \frac{4}{3}
 \end{aligned}$$

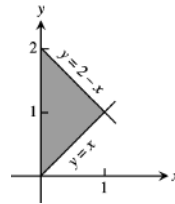

$$\begin{aligned}
 60. \int_0^2 (\tan^{-1} \pi x - \tan^{-1} x) \, dx &= \int_0^2 \int_x^{\pi x} \frac{1}{1+y^2} \, dy \, dx = \int_0^2 \int_{y/\pi}^y \frac{1}{1+y^2} \, dx \, dy + \int_2^{2\pi} \int_{y/\pi}^2 \frac{1}{1+y^2} \, dx \, dy \\
 &= \int_0^2 \frac{(1-\frac{1}{\pi})y}{1+y^2} \, dy + \int_2^{2\pi} \frac{(2-\frac{y}{\pi})}{1+y^2} \, dy = \left(\frac{\pi-1}{2\pi} \right) [\ln(1+y^2)]_0^2 + \left[2 \tan^{-1} y + \frac{1}{2\pi} \ln(1+y^2) \right]_2^{2\pi} \\
 &= \left(\frac{\pi-1}{2\pi} \right) \ln 5 + 2 \tan^{-1} 2\pi - \frac{1}{2\pi} \ln(1+4\pi^2) - 2 \tan^{-1} 2 + \frac{1}{2\pi} \ln 5 \\
 &= 2 \tan^{-1} 2\pi - 2 \tan^{-1} 2 - \frac{1}{2\pi} \ln(1+4\pi^2) + \frac{\ln 5}{2}
 \end{aligned}$$

61. To maximize the integral, we want the domain to include all points where the integrand is positive and to exclude all points where the integrand is negative. These criteria are met by the points (x, y) such that $4 - x^2 - 2y^2 \geq 0$ or $x^2 + 2y^2 \leq 4$, which is the ellipse $x^2 + 2y^2 = 4$ together with its interior.

62. To minimize the integral, we want the domain to include all points where the integrand is negative and to exclude all points where the integrand is positive. These criteria are met by the points (x, y) such that $x^2 + y^2 - 9 \leq 0$ or $x^2 + y^2 \leq 9$, which is the closed disk of radius 3 centered at the origin.

63. No, it is not possible. By Fubini's theorem, the two orders of integration must give the same result.

64. One way would be to partition R into two triangles with the line $y = 1$. The integral of f over R could then be written as a sum of integrals that could be evaluated by integrating first with respect to x and then with respect to y :

$$\int_R f(x, y) \, dA = \int_0^1 \int_{2-2y}^{2-(y/2)} f(x, y) \, dx \, dy + \int_1^2 \int_{y-1}^{2-(y/2)} f(x, y) \, dx \, dy.$$

Partitioning R with the line $x = 1$ would let us write the integral of f over R as a sum of iterated integrals with order $dy \, dx$.

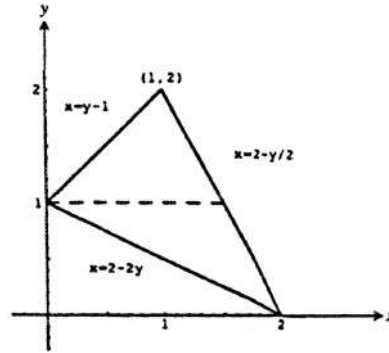

65.
$$\int_{-b}^b \int_{-b}^b e^{-x^2-y^2} \, dx \, dy = \int_{-b}^b \int_{-b}^b e^{-y^2} e^{-x^2} \, dx \, dy = \int_{-b}^b e^{-y^2} \left(\int_{-b}^b e^{-x^2} \, dx \right) \, dy = \left(\int_{-b}^b e^{-x^2} \, dx \right) \left(\int_{-b}^b e^{-y^2} \, dy \right)$$

$$= \left(\int_{-b}^b e^{-x^2} \, dx \right)^2 = \left(2 \int_0^b e^{-x^2} \, dx \right)^2 = 4 \left(\int_0^b e^{-x^2} \, dx \right)^2$$
; taking limits as $b \rightarrow \infty$ gives the stated result.

66.
$$\int_0^1 \int_0^3 \frac{x^2}{(y-1)^{2/3}} \, dy \, dx = \int_0^1 \int_0^3 \frac{x^2}{(y-1)^{2/3}} \, dx \, dy = \int_0^3 \frac{1}{(y-1)^{2/3}} \left[\frac{x^3}{3} \right]_0^1 \, dy = \frac{1}{3} \int_0^3 \frac{dy}{(y-1)^{2/3}}$$

$$= \frac{1}{3} \lim_{b \rightarrow 1^-} \int_0^b \frac{dy}{(y-1)^{2/3}} + \frac{1}{3} \lim_{b \rightarrow 1^+} \int_b^3 \frac{dy}{(y-1)^{2/3}} = \lim_{b \rightarrow 1^-} \left[(y-1)^{1/3} \right]_0^b + \lim_{b \rightarrow 1^+} \left[(y-1)^{1/3} \right]_b^3$$

$$= \left[\lim_{b \rightarrow 1^-} (b-1)^{1/3} - (-1)^{1/3} \right] - \left[\lim_{b \rightarrow 1^+} (b-1)^{1/3} - (2)^{1/3} \right] = (0 + 1) - (0 - \sqrt[3]{2}) = 1 + \sqrt[3]{2}$$

67-70. Example CAS commands:

Maple:

```
f := (x,y) -> 1/x/y;
q1 := Int( Int( f(x,y), y=1..x ), x=1..3 );
evalf( q1 );
value( q1 );
evalf( value(q1) );
```

71-76. Example CAS commands:

Maple:

```
f := (x,y) -> exp(x^2);
c,d := 0,1;
g1 := y -> 2*y;
g2 := y -> 4;
q5 := Int( Int( f(x,y), x=g1(y)..g2(y) ), y=c..d );
value( q5 );
plot3d( 0, x=g1(y)..g2(y), y=c..d, color=pink, style=patchngrid, axes=boxed, orientation=[-90,0],
        scaling=constrained, title="#71 (Section 15.1)" );
r5 := Int( Int( f(x,y), y=0..x/2 ), x=0..2 ) + Int( Int( f(x,y), y=0..1 ), x=2..4 );
value( r5 );
value( q5-r5 );
```

67-76. Example CAS commands:

Mathematica: (functions and bounds will vary)

You can integrate using the built-in integral signs or with the command **Integrate**. In the **Integrate** command, the integration begins with the variable on the right. (In this case, y going from 1 to x).

```
Clear[x, y, f]
f[x_, y_]:= 1 / (x y)
Integrate[f[x, y], {x, 1, 3}, {y, 1, x}]
```

To reverse the order of integration, it is best to first plot the region over which the integration extends. This can be done with `ImplicitPlot` and all bounds involving both x and y can be plotted. A graphics package must be loaded. Remember to use the double equal sign for the equations of the bounding curves.

```
Clear[x, y, f]
<<Graphics`ImplicitPlot`
ImplicitPlot[{x==2y, x==4, y==0, y==1},{x, 0, 4.1}, {y, 0, 1.1}];
f[x_, y_]:=Exp[x^2]
Integrate[f[x, y], {x, 0, 2}, {y, 0, x/2}] + Integrate[f[x, y], {x, 2, 4}, {y, 0, 1}]
```

To get a numerical value for the result, use the numerical integrator, **NIntegrate**. Verify that this equals the original.

```
Integrate[f[x, y], {x, 0, 2}, {y, 0, x/2}] + NIntegrate[f[x, y], {x, 2, 4}, {y, 0, 1}]
NIntegrate[f[x, y], {y, 0, 1}, {x, 2y, 4}]
```

Another way to show a region is with the `FilledPlot` command. This assumes that functions are given as $y = f(x)$.

```
Clear[x, y, f]
<<Graphics`FilledPlot`
FilledPlot[{x^2, 9},{x, 0,3}, AxesLabels -> {x, y}];
f[x_, y_]:= x Cos[y^2]
Integrate[f[x, y], {y, 0, 9}, {x, 0, Sqrt[y]}]
```

67. $\int_1^3 \int_1^x \frac{1}{xy} dy dx \approx 0.603$

68. $\int_0^1 \int_0^1 e^{-(x^2+y^2)} dy dx \approx 0.558$

69. $\int_0^1 \int_0^1 \tan^{-1} xy dy dx \approx 0.233$

70. $\int_{-1}^1 \int_0^{\sqrt{1-x^2}} 3\sqrt{1-x^2-y^2} dy dx \approx 3.142$

71. Evaluate the integrals:

$$\begin{aligned} & \int_0^1 \int_{2y}^4 e^{x^2} dx dy \\ &= \int_0^2 \int_0^{x/2} e^{x^2} dy dx + \int_2^4 \int_0^1 e^{x^2} dy dx \\ &= -\frac{1}{4} + \frac{1}{4}(e^4 - 2\sqrt{\pi} \operatorname{erfi}(2)) + 2\sqrt{\pi} \operatorname{erfi}(4) \\ &\approx 1.1494 \times 10^6 \end{aligned}$$

The following graphs was generated using Mathematica.

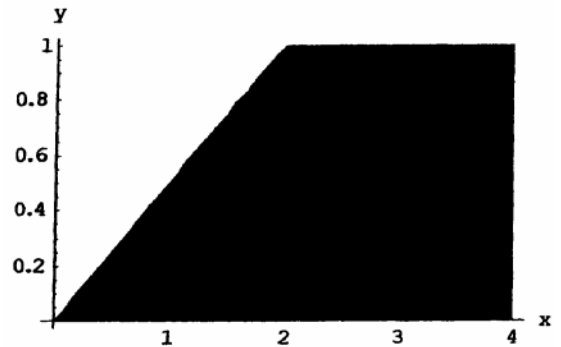

72. Evaluate the integrals:

$$\int_0^3 \int_{x^2}^9 x \cos(y^2) dy dx = \int_0^9 \int_0^{\sqrt{y}} x \cos(y^2) dx dy$$

$$= \frac{\sin(81)}{4} \approx -0.157472$$

The following graph was generated using Mathematica.

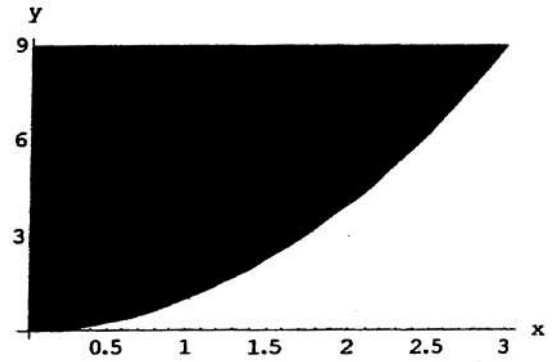

73. Evaluate the integrals:

$$\int_0^2 \int_{y^3}^{4\sqrt{2y}} (x^2y - xy^2) dx dy = \int_0^8 \int_{x^2/32}^{\sqrt[3]{x}} (x^2y - xy^2) dy dx$$

$$= \frac{67,520}{693} \approx 97.4315$$

The following graph was generated using Mathematica.

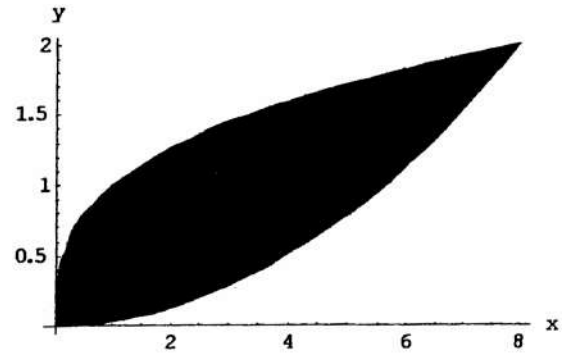

74. Evaluate the integrals:

$$\int_0^2 \int_0^{4-y^2} e^{xy} dx dy = \int_0^4 \int_0^{\sqrt{4-x}} e^{xy} dy dx$$

$$\approx 20.5648$$

The following graph was generated using Mathematica.

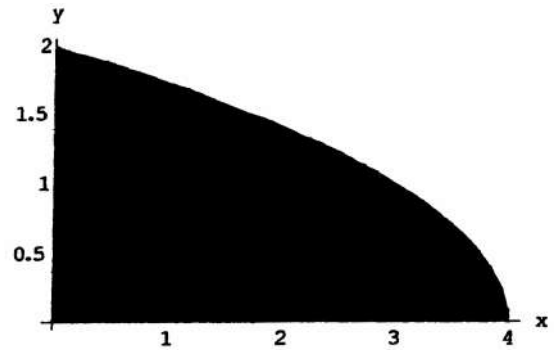

75. Evaluate the integrals:

$$\begin{aligned} & \int_1^2 \int_0^{x^2} \frac{1}{x+y} dy dx \\ &= \int_0^1 \int_1^2 \frac{1}{x+y} dx dy + \int_1^4 \int_{\sqrt{y}}^2 \frac{1}{x+y} dx dy \\ & -1 + \ln\left(\frac{27}{4}\right) \approx 0.909543 \end{aligned}$$

The following graphs was generated using Mathematica.

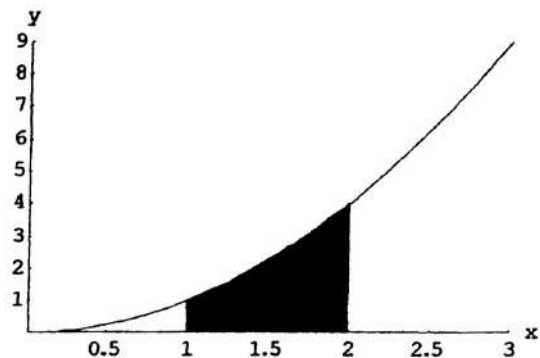

76. Evaluate the integrals:

$$\begin{aligned} & \int_1^2 \int_y^8 \frac{1}{\sqrt{x^2+y^2}} dx dy = \int_1^8 \int_1^{\sqrt[3]{x}} \frac{1}{\sqrt{x^2+y^2}} dy dx \\ & \approx 0.866649 \end{aligned}$$

The following graphs was generated using Mathematica.

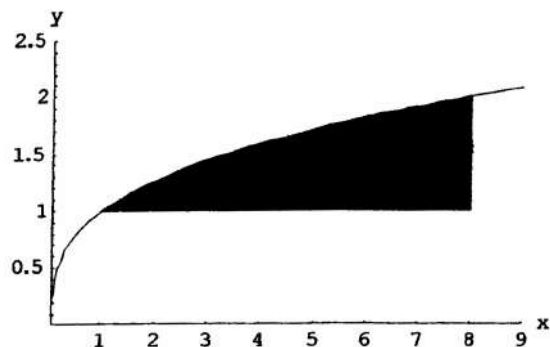

15.2 AREAS, MOMENTS, AND CENTERS OF MASS

$$\begin{aligned} 1. & \int_0^2 \int_0^{2-x} dy dx = \int_0^2 (2-x) dx = \left[2x - \frac{x^2}{2}\right]_0^2 = 2, \\ & \text{or } \int_0^2 \int_0^{2-y} dx dy = \int_0^2 (2-y) dy = 2 \end{aligned}$$

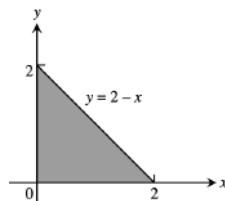

$$\begin{aligned} 2. & \int_0^2 \int_{2x}^4 dy dx = \int_0^2 (4-2x) dx = [4x - x^2]_0^2 = 4, \\ & \text{or } \int_0^4 \int_0^{y/2} dx dy = \int_0^4 \frac{y}{2} dy = 4 \end{aligned}$$

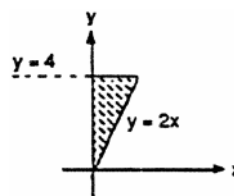

$$\begin{aligned} 3. & \int_{-2}^1 \int_{y-2}^{-y^2} dx dy = \int_{-2}^1 (-y^2 - y + 2) dy \\ &= \left[-\frac{y^3}{3} - \frac{y^2}{2} + 2y\right]_{-2}^1 \\ &= \left(-\frac{1}{3} - \frac{1}{2} + 2\right) - \left(\frac{8}{3} - 2 - 4\right) = \frac{9}{2} \end{aligned}$$

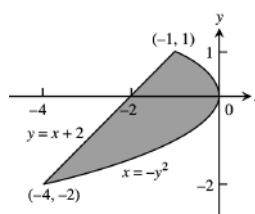

$$4. \int_0^2 \int_{-y}^{y-y^2} dx dy = \int_0^2 (2y - y^2) dy = \left[y^2 - \frac{y^3}{3} \right]_0^2 = 4 - \frac{8}{3} = \frac{4}{3}$$

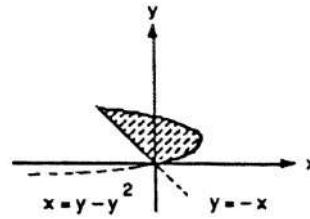

$$5. \int_0^{\ln 2} \int_0^{e^x} dy dx = \int_0^{\ln 2} e^x dx = [e^x]_0^{\ln 2} = 2 - 1 = 1$$

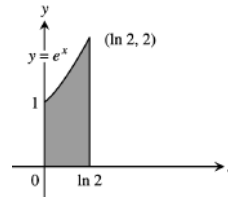

$$6. \int_1^e \int_{\ln x}^{2 \ln x} dy dx = \int_1^e \ln x dx = [x \ln x - x]_1^e = (e - e) - (0 - 1) = 1$$

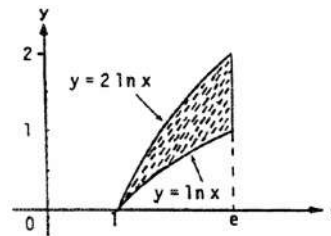

$$7. \int_0^1 \int_{y^2}^{2y-y^2} dx dy = \int_0^1 (2y - 2y^2) dy = \left[y^2 - \frac{2}{3} y^3 \right]_0^1 = \frac{1}{3}$$

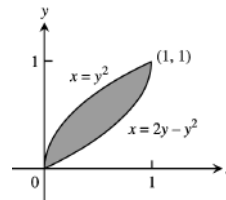

$$8. \int_{-1}^1 \int_{2y^2-2}^{y^2-1} dx dy = \int_{-1}^1 (y^2 - 1 - 2y^2 + 2) dy = \int_{-1}^1 (1 - y^2) dy = \left[y - \frac{y^3}{3} \right]_{-1}^1 = \frac{4}{3}$$

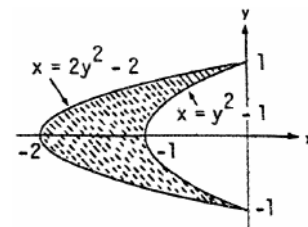

$$9. \int_0^6 \int_{y^2/3}^{2y} dx dy = \int_0^6 \left(2y - \frac{y^2}{3} \right) dy = \left[y^2 - \frac{y^3}{9} \right]_0^6 = 36 - \frac{216}{9} = 12$$

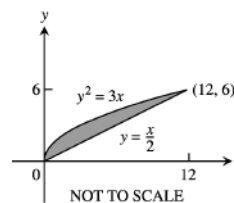

$$10. \int_0^3 \int_{-x}^{2x-x^2} dy dx = \int_0^3 (3x - x^2) dx = \left[\frac{3}{2} x^2 - \frac{1}{3} x^3 \right]_0^3 = \frac{27}{2} - 9 = \frac{9}{2}$$

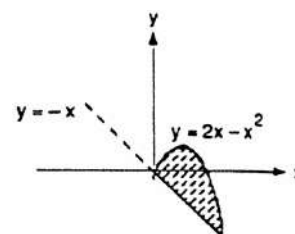

$$\begin{aligned}
 11. \int_0^{\pi/4} \int_{\sin x}^{\cos x} dy dx &= \int_0^{\pi/4} (\cos x - \sin x) dx = [\sin x + \cos x]_0^{\pi/4} \\
 &= \left(\frac{\sqrt{2}}{2} + \frac{\sqrt{2}}{2}\right) - (0 + 1) = \sqrt{2} - 1
 \end{aligned}$$

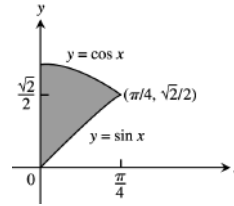

$$\begin{aligned}
 12. \int_{-1}^2 \int_{y^2}^{y+2} dx dy &= \int_{-1}^2 (y + 2 - y^2) dy = \left[\frac{y^2}{2} + 2y - \frac{y^3}{3}\right]_{-1}^2 \\
 &= (2 + 4 - \frac{8}{3}) - (\frac{1}{2} - 2 + \frac{1}{3}) = 5 - \frac{1}{2} = \frac{9}{2}
 \end{aligned}$$

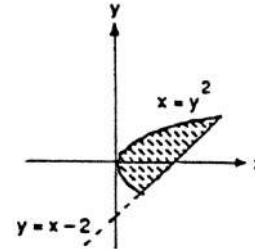

$$\begin{aligned}
 13. \int_{-1}^0 \int_{-2x}^{1-x} dy dx + \int_0^2 \int_{-x/2}^{1-x} dy dx &= \int_{-1}^0 (1+x) dx + \int_0^2 (1 - \frac{x}{2}) dx \\
 &= \left[x + \frac{x^2}{2}\right]_{-1}^0 + \left[x - \frac{x^2}{4}\right]_0^2 = -(-1 + \frac{1}{2}) + (2 - 1) = \frac{3}{2}
 \end{aligned}$$

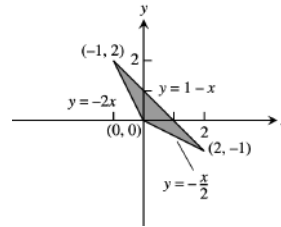

$$\begin{aligned}
 14. \int_0^2 \int_{x^2-4}^0 dy dx + \int_0^4 \int_0^{\sqrt{x}} dy dx &= \int_0^2 (4 - x^2) dx + \int_0^4 x^{1/2} dx \\
 &= \left[4x - \frac{x^3}{3}\right]_0^2 + \left[\frac{2}{3} x^{3/2}\right]_0^4 = (8 - \frac{8}{3}) + \frac{16}{3} = \frac{32}{3}
 \end{aligned}$$

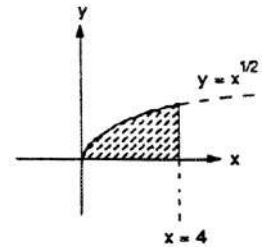
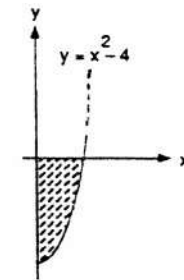

$$\begin{aligned}
 15. (a) \text{ average} &= \frac{1}{\pi^2} \int_0^\pi \int_0^\pi \sin(x+y) dy dx = \frac{1}{\pi^2} \int_0^\pi [-\cos(x+y)]_0^\pi dx = \frac{1}{\pi^2} \int_0^\pi [-\cos(x+\pi) + \cos x] dx \\
 &= \frac{1}{\pi^2} [-\sin(x+\pi) + \sin x]_0^\pi = \frac{1}{\pi^2} [(-\sin 2\pi + \sin \pi) - (-\sin \pi + \sin 0)] = 0
 \end{aligned}$$

$$\begin{aligned}
 (b) \text{ average} &= \frac{1}{(\frac{\pi}{2})^2} \int_0^{\pi/2} \int_0^{\pi/2} \sin(x+y) dy dx = \frac{2}{\pi^2} \int_0^{\pi/2} [-\cos(x+y)]_0^{\pi/2} dx = \frac{2}{\pi^2} \int_0^{\pi/2} [-\cos(x + \frac{\pi}{2}) + \cos x] dx \\
 &= \frac{2}{\pi^2} [-\sin(x + \frac{\pi}{2}) + \sin x]_0^{\pi/2} = \frac{2}{\pi^2} [(-\sin \frac{3\pi}{2} + \sin \pi) - (-\sin \frac{\pi}{2} + \sin 0)] = \frac{4}{\pi^2}
 \end{aligned}$$

$$16. \text{ average value over the square} = \int_0^1 \int_0^1 xy dy dx = \int_0^1 \left[\frac{xy^2}{2}\right]_0^1 dx = \int_0^1 \frac{x}{2} dx = \frac{1}{4} = 0.25;$$

$$\begin{aligned}
 \text{average value over the quarter circle} &= \frac{1}{(\frac{\pi}{4})} \int_0^1 \int_0^{\sqrt{1-x^2}} xy dy dx = \frac{4}{\pi} \int_0^1 \left[\frac{xy^2}{2}\right]_0^{\sqrt{1-x^2}} dx \\
 &= \frac{2}{\pi} \int_0^1 (x - x^3) dx = \frac{2}{\pi} \left[\frac{x^2}{2} - \frac{x^4}{4}\right]_0^1 = \frac{1}{2\pi} \approx 0.159. \text{ The average value over the square is larger.}
 \end{aligned}$$

$$17. \text{ average height} = \frac{1}{4} \int_0^2 \int_0^2 (x^2 + y^2) dy dx = \frac{1}{4} \int_0^2 \left[x^2 y + \frac{y^3}{3}\right]_0^2 dx = \frac{1}{4} \int_0^2 (2x^2 + \frac{8}{3}) dx = \frac{1}{2} \left[\frac{x^3}{3} + \frac{4x}{3}\right]_0^2 = \frac{8}{3}$$

18.
$$\begin{aligned} \text{average} &= \frac{1}{(\ln 2)^2} \int_{\ln 2}^{2 \ln 2} \int_{\ln 2}^{2 \ln 2} \frac{1}{xy} dy dx = \frac{1}{(\ln 2)^2} \int_{\ln 2}^{2 \ln 2} \left[\frac{\ln y}{x} \right]_{\ln 2}^{2 \ln 2} dx \\ &= \frac{1}{(\ln 2)^2} \int_{\ln 2}^{2 \ln 2} \frac{1}{x} (\ln 2 + \ln \ln 2 - \ln \ln 2) dx = \left(\frac{1}{\ln 2} \right) \int_{\ln 2}^{2 \ln 2} \frac{dx}{x} = \left(\frac{1}{\ln 2} \right) [\ln x]_{\ln 2}^{2 \ln 2} \\ &= \left(\frac{1}{\ln 2} \right) (\ln 2 + \ln \ln 2 - \ln \ln 2) = 1 \end{aligned}$$
19.
$$\begin{aligned} M &= \int_0^1 \int_x^{2-x^2} 3 dy dx = 3 \int_0^1 (2 - x^2 - x) dx = \frac{7}{2}; M_y = \int_0^1 \int_x^{2-x^2} 3x dy dx = 3 \int_0^1 [xy]_x^{2-x^2} dx \\ &= 3 \int_0^1 (2x - x^3 - x^2) dx = \frac{5}{4}; M_x = \int_0^1 \int_x^{2-x^2} 3y dy dx = \frac{3}{2} \int_0^1 [y^2]_x^{2-x^2} dx = \frac{3}{2} \int_0^1 (4 - 5x^2 + x^4) dx = \frac{19}{5} \\ &\Rightarrow \bar{x} = \frac{5}{14} \text{ and } \bar{y} = \frac{38}{35} \end{aligned}$$
20.
$$\begin{aligned} M &= \delta \int_0^3 \int_0^3 dy dx = \delta \int_0^3 3 dx = 9\delta; I_x = \delta \int_0^3 \int_0^3 y^2 dy dx = \delta \int_0^3 \left[\frac{y^3}{3} \right]_0^3 dx = 27\delta; R_x = \sqrt{\frac{I_x}{M}} = \sqrt{3}; \\ I_y &= \delta \int_0^3 \int_0^3 x^2 dy dx = \delta \int_0^3 [x^2 y]_0^3 dx = \delta \int_0^3 3x^2 dx = 27\delta; R_y = \sqrt{\frac{I_y}{M}} = \sqrt{3} \end{aligned}$$
21.
$$\begin{aligned} M &= \int_0^2 \int_{y^2/2}^{4-y} dx dy = \int_0^2 \left(4 - y - \frac{y^2}{2} \right) dy = \frac{14}{3}; M_y = \int_0^2 \int_{y^2/2}^{4-y} x dx dy = \frac{1}{2} \int_0^2 [x^2]_{y^2/2}^{4-y} dy \\ &= \frac{1}{2} \int_0^2 \left(16 - 8y + y^2 - \frac{y^4}{4} \right) dy = \frac{128}{15}; M_x = \int_0^2 \int_{y^2/2}^{4-y} y dx dy = \int_0^2 \left(4y - y^2 - \frac{y^3}{2} \right) dy = \frac{10}{3} \\ &\Rightarrow \bar{x} = \frac{64}{35} \text{ and } \bar{y} = \frac{5}{7} \end{aligned}$$
22.
$$\begin{aligned} M &= \int_0^3 \int_0^{3-x} dy dx = \int_0^3 (3 - x) dx = \frac{9}{2}; M_y = \int_0^3 \int_0^{3-x} x dy dx = \int_0^3 [xy]_0^{3-x} dx = \int_0^3 (3x - x^2) dx = \frac{9}{2} \\ &\Rightarrow \bar{x} = 1 \text{ and } \bar{y} = 1, \text{ by symmetry} \end{aligned}$$
23.
$$\begin{aligned} M &= 2 \int_0^1 \int_0^{\sqrt{1-x^2}} dy dx = 2 \int_0^1 \sqrt{1-x^2} dx = 2 \left(\frac{\pi}{4} \right) = \frac{\pi}{2}; M_x = 2 \int_0^1 \int_0^{\sqrt{1-x^2}} y dy dx = \int_0^1 [y^2]_0^{\sqrt{1-x^2}} dx \\ &= \int_0^1 (1 - x^2) dx = \left[x - \frac{x^3}{3} \right]_0^1 = \frac{2}{3} \Rightarrow \bar{y} = \frac{4}{3\pi} \text{ and } \bar{x} = 0, \text{ by symmetry} \end{aligned}$$
24.
$$\begin{aligned} M &= \frac{125\delta}{6}; M_y = \delta \int_0^5 \int_x^{6x-x^2} x dy dx = \delta \int_0^5 [xy]_x^{6x-x^2} dx = \delta \int_0^5 (5x^2 - x^3) dx = \frac{625\delta}{12}; \\ M_x &= \delta \int_0^5 \int_x^{6x-x^2} y dy dx = \frac{\delta}{2} \int_0^5 [y^2]_x^{6x-x^2} dx = \frac{\delta}{2} \int_0^5 (35x^2 - 12x^3 + x^4) dx = \frac{625\delta}{6} \Rightarrow \bar{x} = \frac{5}{2} \text{ and } \bar{y} = 5 \end{aligned}$$
25.
$$\begin{aligned} M &= \int_0^a \int_0^{\sqrt{a^2-x^2}} dy dx = \frac{\pi a^2}{4}; M_y = \int_0^a \int_0^{\sqrt{a^2-x^2}} x dy dx = \int_0^a [xy]_0^{\sqrt{a^2-x^2}} dx = \int_0^a x \sqrt{a^2 - x^2} dx = \frac{a^3}{3} \\ &\Rightarrow \bar{x} = \bar{y} = \frac{4a}{3\pi}, \text{ by symmetry} \end{aligned}$$
26.
$$\begin{aligned} M &= \int_0^\pi \int_0^{\sin x} dy dx = \int_0^\pi \sin x dx = 2; M_x = \int_0^\pi \int_0^{\sin x} y dy dx = \frac{1}{2} \int_0^\pi [y^2]_0^{\sin x} dx = \frac{1}{2} \int_0^\pi \sin^2 x dx \\ &= \frac{1}{4} \int_0^\pi (1 - \cos 2x) dx = \frac{\pi}{4} \Rightarrow \bar{x} = \frac{\pi}{2} \text{ and } \bar{y} = \frac{\pi}{8} \end{aligned}$$
27.
$$\begin{aligned} I_x &= \int_{-2}^2 \int_{-\sqrt{4-x^2}}^{\sqrt{4-x^2}} y^2 dy dx = \int_{-2}^2 \left[\frac{y^3}{3} \right]_{-\sqrt{4-x^2}}^{\sqrt{4-x^2}} dx = \frac{2}{3} \int_{-2}^2 (4 - x^2)^{3/2} dx = 4\pi; I_y = 4\pi, \text{ by symmetry}; \\ I_o &= I_x + I_y = 8\pi \end{aligned}$$
28.
$$I_y = \int_{-\pi}^{2\pi} \int_0^{(\sin^2 x)/x^2} x^2 dy dx = \int_{-\pi}^{2\pi} (\sin^2 x - 0) dx = \frac{1}{2} \int_{-\pi}^{2\pi} (1 - \cos 2x) dx = \frac{\pi}{2}$$
29.
$$\begin{aligned} M &= \int_{-\infty}^0 \int_0^{e^x} dy dx = \int_{-\infty}^0 e^x dx = \lim_{b \rightarrow -\infty} \int_b^0 e^x dx = 1 - \lim_{b \rightarrow -\infty} e^b = 1; M_y = \int_{-\infty}^0 \int_0^{e^x} x dy dx = \int_{-\infty}^0 x e^x dx \\ &= \lim_{b \rightarrow -\infty} \int_b^0 x e^x dx = \lim_{b \rightarrow -\infty} [x e^x - e^x]_b^0 = -1 - \lim_{b \rightarrow -\infty} (b e^b - e^b) = -1; M_x = \int_{-\infty}^0 \int_0^{e^x} y dy dx \end{aligned}$$

$$= \frac{1}{2} \int_{-\infty}^0 e^{2x} dx = \frac{1}{2} \lim_{b \rightarrow -\infty} \int_b^0 e^{2x} dx = \frac{1}{4} \Rightarrow \bar{x} = -1 \text{ and } \bar{y} = \frac{1}{4}$$

$$30. M_y = \int_0^{\infty} \int_0^{e^{-x^2/2}} x dy dx = \lim_{b \rightarrow \infty} \int_0^b x e^{-x^2/2} dx = - \lim_{b \rightarrow \infty} \left[\frac{1}{e^{x^2/2}} - 1 \right]_0^b = 1$$

$$31. M = \int_0^2 \int_{-y}^{y-y^2} (x+y) dx dy = \int_0^2 \left[\frac{x^2}{2} + xy \right]_{-y}^{y-y^2} dy = \int_0^2 \left(\frac{y^4}{2} - 2y^3 + 2y^2 \right) dy = \left[\frac{y^5}{10} - \frac{y^4}{2} + \frac{2y^3}{3} \right]_0^2 = \frac{8}{15};$$

$$I_x = \int_0^2 \int_{-y}^{y-y^2} y^2(x+y) dx dy = \int_0^2 \left[\frac{x^2 y^2}{2} + xy^3 \right]_{-y}^{y-y^2} dy = \int_0^2 \left(\frac{y^6}{2} - 2y^5 + 2y^4 \right) dy = \frac{64}{105};$$

$$R_x = \sqrt{\frac{I_x}{M}} = \sqrt{\frac{8}{7}} = 2\sqrt{\frac{2}{7}}$$

$$32. M = \int_{-\sqrt{3}/2}^{\sqrt{3}/2} \int_{4y^2}^{\sqrt{12-4y^2}} 5x dx dy = 5 \int_{-\sqrt{3}/2}^{\sqrt{3}/2} \left[\frac{x^2}{2} \right]_{4y^2}^{\sqrt{12-4y^2}} dy = \frac{5}{2} \int_{-\sqrt{3}/2}^{\sqrt{3}/2} (12 - 4y^2 - 16y^4) dy = 23\sqrt{3}$$

$$33. M = \int_0^1 \int_x^{2-x} (6x+3y+3) dy dx = \int_0^1 \left[6xy + \frac{3}{2}y^2 + 3y \right]_x^{2-x} dx = \int_0^1 (12 - 12x^2) dx = 8;$$

$$M_y = \int_0^1 \int_x^{2-x} x(6x+3y+3) dy dx = \int_0^1 (12x - 12x^3) dx = 3; M_x = \int_0^1 \int_x^{2-x} y(6x+3y+3) dy dx$$

$$= \int_0^1 (14 - 6x - 6x^2 - 2x^3) dx = \frac{17}{2} \Rightarrow \bar{x} = \frac{3}{8} \text{ and } \bar{y} = \frac{17}{16}$$

$$34. M = \int_0^1 \int_{y^2}^{2y-y^2} (y+1) dx dy = \int_0^1 (2y - 2y^3) dy = \frac{1}{2}; M_x = \int_0^1 \int_{y^2}^{2y-y^2} y(y+1) dx dy = \int_0^1 (2y^2 - 2y^4) dy = \frac{4}{15};$$

$$M_y = \int_0^1 \int_{y^2}^{2y-y^2} x(y+1) dx dy = \int_0^1 (2y^2 - 2y^4) dy = \frac{4}{15} \Rightarrow \bar{x} = \frac{8}{15} \text{ and } \bar{y} = \frac{8}{15}; I_x = \int_0^1 \int_{y^2}^{2y-y^2} y^2(y+1) dx dy$$

$$= 2 \int_0^1 (y^3 - y^5) dy = \frac{1}{6}$$

$$35. M = \int_0^1 \int_0^6 (x+y+1) dx dy = \int_0^1 (6y+24) dy = 27; M_x = \int_0^1 \int_0^6 y(x+y+1) dx dy = \int_0^1 y(6y+24) dy = 14;$$

$$M_y = \int_0^1 \int_0^6 x(x+y+1) dx dy = \int_0^1 (18y+90) dy = 99 \Rightarrow \bar{x} = \frac{11}{3} \text{ and } \bar{y} = \frac{14}{27}; I_y = \int_0^1 \int_0^6 x^2(x+y+1) dx dy$$

$$= 216 \int_0^1 \left(\frac{y}{3} + \frac{11}{6} \right) dy = 432; R_y = \sqrt{\frac{I_y}{M}} = 4$$

$$36. M = \int_{-1}^1 \int_{x^2}^1 (y+1) dy dx = - \int_{-1}^1 \left(\frac{y^2}{2} + x^2 - \frac{3}{2} \right) dx = \frac{32}{15}; M_x = \int_{-1}^1 \int_{x^2}^1 y(y+1) dy dx = \int_{-1}^1 \left(\frac{y^3}{3} - \frac{x^3}{3} - \frac{x^4}{2} \right) dx$$

$$= \frac{48}{35}; M_y = \int_{-1}^1 \int_{x^2}^1 x(y+1) dy dx = \int_{-1}^1 \left(\frac{3x}{2} - \frac{x^5}{2} - x^3 \right) dx = 0 \Rightarrow \bar{x} = 0 \text{ and } \bar{y} = \frac{9}{14}; I_y = \int_{-1}^1 \int_{x^2}^1 x^2(y+1) dy dx$$

$$= \int_{-1}^1 \left(\frac{3x^2}{2} - \frac{x^6}{2} - x^4 \right) dx = \frac{16}{35}; R_y = \sqrt{\frac{I_y}{M}} = \sqrt{\frac{3}{14}}$$

$$37. M = \int_{-1}^1 \int_0^{x^2} (7y+1) dy dx = \int_{-1}^1 \left(\frac{7x^4}{2} + x^2 \right) dx = \frac{31}{15}; M_x = \int_{-1}^1 \int_0^{x^2} y(7y+1) dy dx = \int_{-1}^1 \left(\frac{7x^6}{3} + \frac{x^4}{2} \right) dx = \frac{13}{15};$$

$$M_y = \int_{-1}^1 \int_0^{x^2} x(7y+1) dy dx = \int_{-1}^1 \left(\frac{7x^5}{2} + x^3 \right) dx = 0 \Rightarrow \bar{x} = 0 \text{ and } \bar{y} = \frac{13}{31}; I_y = \int_{-1}^1 \int_0^{x^2} x^2(7y+1) dy dx$$

$$= \int_{-1}^1 \left(\frac{7x^6}{2} + x^4 \right) dx = \frac{7}{5}; R_y = \sqrt{\frac{I_y}{M}} = \sqrt{\frac{21}{31}}$$

$$38. M = \int_0^{20} \int_{-1}^1 \left(1 + \frac{x}{20} \right) dy dx = \int_0^{20} \left(2 + \frac{x}{10} \right) dx = 60; M_x = \int_0^{20} \int_{-1}^1 y \left(1 + \frac{x}{20} \right) dy dx = \int_0^{20} \left[\left(1 + \frac{x}{20} \right) \left(\frac{y^2}{2} \right) \right]_{-1}^1 dx = 0;$$

$$M_y = \int_0^{20} \int_{-1}^1 x \left(1 + \frac{x}{20} \right) dy dx = \int_0^{20} \left(2x + \frac{x^2}{10} \right) dx = \frac{2000}{3} \Rightarrow \bar{x} = \frac{100}{9} \text{ and } \bar{y} = 0; I_x = \int_0^{20} \int_{-1}^1 y^2 \left(1 + \frac{x}{20} \right) dy dx$$

$$= \frac{2}{3} \int_0^{20} \left(1 + \frac{x}{20} \right) dx = 20; R_x = \sqrt{\frac{I_x}{M}} = \sqrt{\frac{1}{3}}$$

$$39. M = \int_0^1 \int_{-y}^y (y+1) dx dy = \int_0^1 (2y^2 + 2y) dy = \frac{5}{3}; M_x = \int_0^1 \int_{-y}^y y(y+1) dx dy = 2 \int_0^1 (y^3 + y^2) dy = \frac{7}{6};$$

$$M_y = \int_0^1 \int_{-y}^y x(y+1) dx dy = \int_0^1 0 dy = 0 \Rightarrow \bar{x} = 0 \text{ and } \bar{y} = \frac{7}{10}; I_x = \int_0^1 \int_{-y}^y y^2(y+1) dx dy = \int_0^1 (2y^4 + 2y^3) dy$$

$$= \frac{9}{10} \Rightarrow R_x = \sqrt{\frac{I_x}{M}} = \frac{3\sqrt{6}}{10}; I_y = \int_0^1 \int_{-y}^y x^2(y+1) dx dy = \frac{1}{3} \int_0^1 (2y^4 + 2y^3) dy = \frac{3}{10} \Rightarrow R_y = \sqrt{\frac{I_y}{M}} = \frac{3\sqrt{2}}{10};$$

$$I_o = I_x + I_y = \frac{6}{5} \Rightarrow R_o = \sqrt{\frac{I_o}{M}} = \frac{3\sqrt{2}}{5}$$

$$40. M = \int_0^1 \int_{-y}^y (3x^2 + 1) dx dy = \int_0^1 (2y^3 + 2y) dy = \frac{3}{2}; M_x = \int_0^1 \int_{-y}^y y(3x^2 + 1) dx dy = \int_0^1 (2y^4 + 2y^2) dy = \frac{16}{15};$$

$$M_y = \int_0^1 \int_{-y}^y x(3x^2 + 1) dx dy = 0 \Rightarrow \bar{x} = 0 \text{ and } \bar{y} = \frac{32}{45}; I_x = \int_0^1 \int_{-y}^y y^2(3x^2 + 1) dx dy = \int_0^1 (2y^5 + 2y^3) dy = \frac{5}{6}$$

$$\Rightarrow R_x = \sqrt{\frac{I_x}{M}} = \frac{\sqrt{5}}{3}; I_y = \int_0^1 \int_{-y}^y x^2(3x^2 + 1) dx dy = 2 \int_0^1 (\frac{3}{5}y^5 + \frac{1}{3}y^3) dy = \frac{11}{30} \Rightarrow R_y = \sqrt{\frac{I_y}{M}} = \sqrt{\frac{11}{45}};$$

$$I_o = I_x + I_y = \frac{6}{5} \Rightarrow R_o = \sqrt{\frac{I_o}{M}} = \frac{2}{\sqrt{5}}$$

$$41. \int_{-5}^5 \int_{-2}^0 \frac{10,000e^y}{1+|x|} dy dx = 10,000(1-e^{-2}) \int_{-5}^5 \frac{dx}{1+|x|} = 10,000(1-e^{-2}) \left[\int_{-5}^0 \frac{dx}{1-\frac{x}{2}} + \int_0^5 \frac{dx}{1+\frac{x}{2}} \right]$$

$$= 10,000(1-e^{-2}) \left[-2 \ln \left(1 - \frac{x}{2} \right) \right]_{-5}^0 + 10,000(1-e^{-2}) \left[2 \ln \left(1 + \frac{x}{2} \right) \right]_0^5$$

$$= 10,000(1-e^{-2}) \left[2 \ln \left(1 + \frac{5}{2} \right) \right] + 10,000(1-e^{-2}) \left[2 \ln \left(1 + \frac{5}{2} \right) \right] = 40,000(1-e^{-2}) \ln \left(\frac{7}{2} \right) \approx 43,329$$

$$42. \int_0^1 \int_{y^2}^{2y-y^2} 100(y+1) dx dy = \int_0^1 [100(y+1)x]_{y^2}^{2y-y^2} dy = \int_0^1 100(y+1)(2y-2y^2) dy = 200 \int_0^1 (y-y^3) dy$$

$$= 200 \left[\frac{y^2}{2} - \frac{y^4}{4} \right]_0^1 = (200) \left(\frac{1}{4} \right) = 50$$

$$43. M = \int_{-1}^1 \int_0^{a(1-x^2)} dy dx = 2a \int_0^1 (1-x^2) dx = 2a \left[x - \frac{x^3}{3} \right]_0^1 = \frac{4a}{3}; M_x = \int_{-1}^1 \int_0^{a(1-x^2)} y dy dx$$

$$= \frac{2a^2}{2} \int_0^1 (1-2x^2+x^4) dx = a^2 \left[x - \frac{2x^3}{3} + \frac{x^5}{5} \right]_0^1 = \frac{8a^2}{15} \Rightarrow \bar{y} = \frac{M_x}{M} = \frac{\left(\frac{8a^2}{15}\right)}{\left(\frac{4a}{3}\right)} = \frac{2a}{5}. \text{ The angle } \theta \text{ between the}$$

x-axis and the line segment from the fulcrum to the center of mass on the y-axis plus 45° must be no more than 90° if the center of mass is to lie on the left side of the line $x = 1 \Rightarrow \theta + \frac{\pi}{4} \leq \frac{\pi}{2} \Rightarrow \tan^{-1} \left(\frac{2a}{5} \right) \leq \frac{\pi}{4} \Rightarrow a \leq \frac{5}{2}$.

Thus, if $0 < a \leq \frac{5}{2}$, then the appliance will have to be tipped more than 45° to fall over.

$$44. f(a) = I_a = \int_0^4 \int_0^2 (y-a)^2 dy dx = \int_0^4 \left[\frac{(2-a)^3}{3} + \frac{a^3}{3} \right] dx = \frac{4}{3} [(2-a)^3 + a^3]; \text{ thus } f'(a) = 0 \Rightarrow -4(2-a)^2 + 4a^2$$

$$= 0 \Rightarrow a^2 - (2-a)^2 = 0 \Rightarrow -4 + 4a = 0 \Rightarrow a = 1. \text{ Since } f''(a) = 8(2-a) + 8a = 16 > 0, a = 1 \text{ gives a}$$

minimum value of I_a .

$$45. M = \int_0^1 \int_{-1/\sqrt{1-x^2}}^{1/\sqrt{1-x^2}} dy dx = \int_0^1 \frac{2}{\sqrt{1-x^2}} dx = [2 \sin^{-1} x]_0^1 = 2 \left(\frac{\pi}{2} - 0 \right) = \pi; M_y = \int_0^1 \int_{-1/\sqrt{1-x^2}}^{1/\sqrt{1-x^2}} x dy dx$$

$$= \int_0^1 \frac{2x}{\sqrt{1-x^2}} dx = \left[-2(1-x^2)^{1/2} \right]_0^1 = 2 \Rightarrow \bar{x} = \frac{2}{\pi} \text{ and } \bar{y} = 0 \text{ by symmetry}$$

$$46. (a) I = \int_{-L/2}^{L/2} \delta x^2 dx = \frac{\delta L^3}{12} \Rightarrow R = \sqrt{\frac{\delta L^3}{12} \cdot \frac{1}{\delta L}} = \frac{L}{2\sqrt{3}}$$

$$(b) I = \int_0^L \delta x^2 dx = \frac{\delta L^3}{3} \Rightarrow R = \sqrt{\frac{\delta L^3}{3} \cdot \frac{1}{\delta L}} = \frac{L}{\sqrt{3}}$$

$$47. (a) \frac{1}{2} = M = \int_0^1 \int_{y^2}^{2y-y^2} \delta dx dy = 2\delta \int_0^1 (y-y^2) dy = 2\delta \left[\frac{y^2}{2} - \frac{y^3}{3} \right]_0^1 = 2\delta \left(\frac{1}{6} \right) = \frac{\delta}{3} \Rightarrow \delta = \frac{3}{2}$$

(b) average value = $\frac{\int_0^1 \int_{y^2}^{2y-y^2} (y+1) dx dy}{\int_0^1 \int_{y^2}^{2y-y^2} dx dy} = \frac{(\frac{1}{2})}{(\frac{1}{3})} = \frac{3}{2} = \delta$, so the values are the same

48. Let (x_i, y_i) be the location of the weather station in county i for $i = 1, \dots, 254$. The average temperature in Texas at time t_0 is approximately $\frac{\sum_{i=1}^{254} T(x_i, y_i) \Delta_i A}{A}$, where $T(x_i, y_i)$ is the temperature at time t_0 at the weather station in county i , $\Delta_i A$ is the area of county i , and A is the area of Texas.

49. (a) $\bar{x} = \frac{M_x}{M} = 0 \Rightarrow M_y = \iint_R x \delta(x, y) dy dx = 0$

(b) $I_L = \iint_R (x - h)^2 \delta(x, y) dA = \iint_R x^2 \delta(x, y) dA - \iint_R 2hx \delta(x, y) dA + \iint_R h^2 \delta(x, y) dA$
 $= I_y - 0 + h^2 \iint_R \delta(x, y) dA = I_{c.m.} + mh^2$

50. (a) $I_{c.m.} = I_L - mh^2 \Rightarrow I_{x=5/7} = I_y - mh^2 = \frac{39}{5} - 14 \left(\frac{5}{7}\right)^2 = \frac{23}{35}$; $I_{y=11/14} = I_x - mh^2 = 12 - 14 \left(\frac{11}{14}\right)^2 = \frac{47}{14}$

(b) $I_{x=1} = I_{x=5/7} + mh^2 = \frac{23}{35} + 14 \left(\frac{2}{7}\right)^2 = \frac{9}{5}$; $I_{y=2} = I_{y=11/14} + mh^2 = \frac{47}{14} + 14 \left(\frac{17}{14}\right)^2 = 24$

51. $M_{x_{p_1+p_2}} = \iint_{R_1} y dA_1 + \iint_{R_2} y dA_2 = M_{x_1} + M_{x_2} \Rightarrow \bar{x} = \frac{M_{x_1} + M_{x_2}}{m_1 + m_2}$; likewise, $\bar{y} = \frac{M_{y_1} + M_{y_2}}{m_1 + m_2}$;

thus $\mathbf{c} = \bar{x}\mathbf{i} + \bar{y}\mathbf{j} = \frac{1}{m_1 + m_2} [(M_{x_1} + M_{x_2})\mathbf{i} + (M_{y_1} + M_{y_2})\mathbf{j}] = \frac{1}{m_1 + m_2} [(m_1\bar{x}_1 + m_2\bar{x}_2)\mathbf{i} + (m_1\bar{y}_1 + m_2\bar{y}_2)\mathbf{j}]$
 $= \frac{1}{m_1 + m_2} [m_1(\bar{x}_1\mathbf{i} + \bar{y}_1\mathbf{j}) + m_2(\bar{x}_2\mathbf{i} + \bar{y}_2\mathbf{j})] = \frac{m_1\mathbf{c}_1 + m_2\mathbf{c}_2}{m_1 + m_2}$

52. From Exercise 51 we have that Pappus's formula is true for $n = 2$. Assume that Pappus's formula is true for

$n = k - 1$, i.e., that $\mathbf{c}(k - 1) = \frac{\sum_{i=1}^{k-1} m_i \mathbf{c}_i}{\sum_{i=1}^{k-1} m_i}$. The first moment about x of k nonoverlapping plates is

$\sum_{i=1}^{k-1} \left(\iint_{R_i} y dA_i \right) + \iint_{R_k} y dA_k = M_{x_{c(k-1)}} + M_{x_k} \Rightarrow \bar{x} = \frac{M_{x_{c(k-1)}} + M_{x_k}}{\left(\sum_{i=1}^{k-1} m_i\right) + m_k}$; similarly, $\bar{y} = \frac{M_{y_{c(k-1)}} + M_{y_k}}{\left(\sum_{i=1}^{k-1} m_i\right) + m_k}$;

thus $\mathbf{c}(k) = \bar{x}\mathbf{i} + \bar{y}\mathbf{j} = \frac{1}{\sum_{i=1}^k m_i} [(M_{x_{c(k-1)}} + M_{x_k})\mathbf{i} + (M_{y_{c(k-1)}} + M_{y_k})\mathbf{j}]$

$= \frac{1}{\sum_{i=1}^k m_i} \left[\left(\left(\sum_{i=1}^{k-1} m_i \right) \bar{x}_c + m_k \bar{x}_k \right) \mathbf{i} + \left(\left(\sum_{i=1}^{k-1} m_i \right) \bar{y}_c + m_k \bar{y}_k \right) \mathbf{j} \right]$

$= \frac{1}{\sum_{i=1}^k m_i} \left[\left(\sum_{i=1}^{k-1} m_i \right) (\bar{x}_c \mathbf{i} + \bar{y}_c \mathbf{j}) + m_k (\bar{x}_k \mathbf{i} + \bar{y}_k \mathbf{j}) \right] = \frac{\left(\sum_{i=1}^{k-1} m_i\right) \mathbf{c}(k-1) + m_k \mathbf{c}_k}{\sum_{i=1}^k m_i}$

$= \frac{m_1 \mathbf{c}_1 + m_2 \mathbf{c}_2 + \dots + m_{k-1} \mathbf{c}_{k-1} + m_k \mathbf{c}_k}{m_1 + m_2 + \dots + m_{k-1} + m_k}$, and by mathematical induction the statement follows.

53. (a) $\mathbf{c} = \frac{8(\mathbf{i} + 3\mathbf{j}) + 2(3\mathbf{i} + 3.5\mathbf{j})}{8+2} = \frac{14\mathbf{i} + 31\mathbf{j}}{10} \Rightarrow \bar{x} = \frac{7}{5}$ and $\bar{y} = \frac{31}{10}$

(b) $\mathbf{c} = \frac{8(\mathbf{i} + 3\mathbf{j}) + 6(5\mathbf{i} + 2\mathbf{j})}{14} = \frac{38\mathbf{i} + 36\mathbf{j}}{14} \Rightarrow \bar{x} = \frac{19}{7}$ and $\bar{y} = \frac{18}{7}$

(c) $\mathbf{c} = \frac{2(3\mathbf{i} + 3.5\mathbf{j}) + 6(5\mathbf{i} + 2\mathbf{j})}{8} = \frac{36\mathbf{i} + 19\mathbf{j}}{8} \Rightarrow \bar{x} = \frac{9}{2}$ and $\bar{y} = \frac{19}{8}$

(d) $\mathbf{c} = \frac{8(\mathbf{i} + 3\mathbf{j}) + 2(3\mathbf{i} + 3.5\mathbf{j}) + 6(5\mathbf{i} + 2\mathbf{j})}{16} = \frac{44\mathbf{i} + 43\mathbf{j}}{16} \Rightarrow \bar{x} = \frac{11}{4}$ and $\bar{y} = \frac{43}{16}$

54. $\mathbf{c} = \frac{15 \left(\frac{3}{4}\mathbf{i} + 7\mathbf{j}\right) + 48(12\mathbf{i} + \mathbf{j})}{15+48} = \frac{15(3\mathbf{i} + 28\mathbf{j}) + 48(48\mathbf{i} + 4\mathbf{j})}{4 \cdot 63} = \frac{2349\mathbf{i} + 612\mathbf{j}}{4 \cdot 63} = \frac{261\mathbf{i} + 68\mathbf{j}}{4 \cdot 7}$
 $\Rightarrow \bar{x} = \frac{261}{28}$ and $\bar{y} = \frac{17}{7}$

55. Place the midpoint of the triangle's base at the origin and above the semicircle. Then the center of mass of the triangle is $(0, \frac{h}{3})$, and the center of mass of the disk is $(0, -\frac{4a}{3\pi})$ from Exercise 25. From

Pappus's formula, $\mathbf{c} = \frac{(ah)(\frac{h}{3}\mathbf{j}) + (\frac{\pi a^2}{2})(-\frac{4a}{3\pi}\mathbf{j})}{(ah + \frac{\pi a^2}{2})} = \frac{(\frac{ah^2 - 2a^3}{3})\mathbf{j}}{(ah + \frac{\pi a^2}{2})}$, so the centroid is on the boundary

if $ah^2 - 2a^3 = 0 \Rightarrow h^2 = 2a^2 \Rightarrow h = a\sqrt{2}$. In order for the center of mass to be inside T we must have $ah^2 - 2a^3 > 0$ or $h > a\sqrt{2}$.

56. Place the midpoint of the triangle's base at the origin and above the square. From Pappus's formula,

$\mathbf{c} = \frac{(\frac{sh}{2})(\frac{h}{3}\mathbf{j}) + s^2(-\frac{s}{2}\mathbf{j})}{(\frac{sh}{2} + s^2)}$, so the centroid is on the boundary if $\frac{sh^2}{6} - \frac{s^3}{2} = 0 \Rightarrow h^2 - 3s^2 = 0 \Rightarrow h = s\sqrt{3}$.

15.3 DOUBLE INTEGRALS IN POLAR FORM

- $\int_{-1}^1 \int_0^{\sqrt{1-x^2}} dy dx = \int_0^\pi \int_0^1 r dr d\theta = \frac{1}{2} \int_0^\pi d\theta = \frac{\pi}{2}$
- $\int_{-1}^1 \int_{-\sqrt{1-x^2}}^{\sqrt{1-x^2}} dy dx = \int_0^{2\pi} \int_0^1 r dr d\theta = \frac{1}{2} \int_0^{2\pi} d\theta = \pi$
- $\int_0^1 \int_0^{\sqrt{1-y^2}} (x^2 + y^2) dx dy = \int_0^{\pi/2} \int_0^1 r^3 dr d\theta = \frac{1}{4} \int_0^{\pi/2} d\theta = \frac{\pi}{8}$
- $\int_{-1}^1 \int_{-\sqrt{1-y^2}}^{\sqrt{1-y^2}} (x^2 + y^2) dx dy = \int_0^{2\pi} \int_0^1 r^3 dr d\theta = \frac{1}{4} \int_0^{2\pi} d\theta = \frac{\pi}{2}$
- $\int_{-a}^a \int_{-\sqrt{a^2-x^2}}^{\sqrt{a^2-x^2}} dy dx = \int_0^{2\pi} \int_0^a r dr d\theta = \frac{a^2}{2} \int_0^{2\pi} d\theta = \pi a^2$
- $\int_0^2 \int_0^{\sqrt{4-y^2}} (x^2 + y^2) dx dy = \int_0^{\pi/2} \int_0^2 r^3 dr d\theta = 4 \int_0^{\pi/2} d\theta = 2\pi$
- $\int_0^6 \int_0^y x dx dy = \int_{\pi/4}^{\pi/2} \int_0^{6 \csc \theta} r^2 \cos \theta dr d\theta = 72 \int_{\pi/4}^{\pi/2} \cot \theta \csc^2 \theta d\theta = -36 [\cot^2 \theta]_{\pi/4}^{\pi/2} = 36$
- $\int_0^2 \int_0^x y dy dx = \int_0^{\pi/4} \int_0^{2 \sec \theta} r^2 \sin \theta dr d\theta = \frac{8}{3} \int_0^{\pi/4} \tan \theta \sec^2 \theta d\theta = \frac{4}{3}$
- $\int_{-1}^0 \int_{-\sqrt{1-x^2}}^0 \frac{2}{1+\sqrt{x^2+y^2}} dy dx = \int_\pi^{3\pi/2} \int_0^1 \frac{2r}{1+r} dr d\theta = 2 \int_\pi^{3\pi/2} \int_0^1 (1 - \frac{1}{1+r}) dr d\theta = 2 \int_\pi^{3\pi/2} (1 - \ln 2) d\theta = (1 - \ln 2)\pi$
- $\int_{-1}^1 \int_{-\sqrt{1-y^2}}^0 \frac{4\sqrt{x^2+y^2}}{1+x^2+y^2} dx dy = \int_{\pi/2}^{3\pi/2} \int_0^1 \frac{4r^2}{1+r^2} dr d\theta = 4 \int_{\pi/2}^{3\pi/2} \int_0^1 (1 - \frac{1}{1+r^2}) dr d\theta = 4 \int_{\pi/2}^{3\pi/2} (1 - \frac{\pi}{4}) d\theta = 4\pi - \pi^2$
- $\int_0^{\ln 2} \int_0^{\sqrt{(\ln 2)^2 - y^2}} e^{\sqrt{x^2+y^2}} dx dy = \int_0^{\pi/2} \int_0^{\ln 2} re^r dr d\theta = \int_0^{\pi/2} (2 \ln 2 - 1) d\theta = \frac{\pi}{2} (2 \ln 2 - 1)$
- $\int_0^1 \int_0^{\sqrt{1-x^2}} e^{-(x^2+y^2)} dy dx = \int_0^{\pi/2} \int_0^1 re^{-r^2} dr d\theta = -\frac{1}{2} \int_0^{\pi/2} (\frac{1}{e} - 1) d\theta = \frac{\pi(e-1)}{4e}$
- $\int_0^2 \int_0^{\sqrt{1-(x-1)^2}} \frac{x+y}{x^2+y^2} dy dx = \int_0^{\pi/2} \int_0^{2 \cos \theta} \frac{r(\cos \theta + \sin \theta)}{r^2} r dr d\theta = \int_0^{\pi/2} (2 \cos^2 \theta + 2 \sin \theta \cos \theta) d\theta = [\theta + \frac{\sin 2\theta}{2} + \sin^2 \theta]_0^{\pi/2} = \frac{\pi+2}{2} = \frac{\pi}{2} + 1$

$$14. \int_0^2 \int_{-\sqrt{1-(y-1)^2}}^0 xy^2 \, dx \, dy = \int_{\pi/2}^{\pi} \int_0^{2 \sin \theta} \sin^2 \theta \cos \theta r^4 \, dr \, d\theta = \frac{32}{5} \int_{\pi/2}^{\pi} \sin^7 \theta \cos \theta \, d\theta = \frac{4}{5} [\sin^8 \theta]_{\pi/2}^{\pi} = -\frac{4}{5}$$

$$15. \int_{-1}^1 \int_{-\sqrt{1-y^2}}^{\sqrt{1-y^2}} \ln(x^2 + y^2 + 1) \, dx \, dy = 4 \int_0^{\pi/2} \int_0^1 \ln(r^2 + 1) r \, dr \, d\theta = 2 \int_0^{\pi/2} (\ln 4 - 1) \, d\theta = \pi(\ln 4 - 1)$$

$$16. \int_{-1}^1 \int_{-\sqrt{1-x^2}}^{\sqrt{1-x^2}} \frac{2}{(1+x^2+y^2)^2} \, dy \, dx = 4 \int_0^{\pi/2} \int_0^1 \frac{2r}{(1+r^2)^2} \, dr \, d\theta = 4 \int_0^{\pi/2} \left[-\frac{1}{1+r^2}\right]_0^1 \, d\theta = 2 \int_0^{\pi/2} \, d\theta = \pi$$

$$17. \int_0^{\pi/2} \int_0^{2\sqrt{2-\sin 2\theta}} r \, dr \, d\theta = 2 \int_0^{\pi/2} (2 - \sin 2\theta) \, d\theta = 2(\pi - 1)$$

$$18. A = 2 \int_0^{\pi/2} \int_1^{1+\cos \theta} r \, dr \, d\theta = \int_0^{\pi/2} (2 \cos \theta + \cos^2 \theta) \, d\theta = \frac{8+\pi}{4}$$

$$19. A = 2 \int_0^{\pi/6} \int_0^{12 \cos 3\theta} r \, dr \, d\theta = 144 \int_0^{\pi/6} \cos^2 3\theta \, d\theta = 12\pi$$

$$20. A = \int_0^{2\pi} \int_0^{4\theta/3} r \, dr \, d\theta = \frac{8}{9} \int_0^{2\pi} \theta^2 \, d\theta = \frac{64\pi^3}{27}$$

$$21. A = \int_0^{\pi/2} \int_0^{1+\sin \theta} r \, dr \, d\theta = \frac{1}{2} \int_0^{\pi/2} \left(\frac{3}{2} + 2 \sin \theta - \frac{\cos 2\theta}{2}\right) \, d\theta = \frac{3\pi}{8} + 1$$

$$22. A = 4 \int_0^{\pi/2} \int_0^{1-\cos \theta} r \, dr \, d\theta = 2 \int_0^{\pi/2} \left(\frac{3}{2} - 2 \cos \theta + \frac{\cos 2\theta}{2}\right) \, d\theta = \frac{3\pi}{2} - 4$$

$$23. M_x = \int_0^{\pi} \int_0^{1-\cos \theta} 3r^2 \sin \theta \, dr \, d\theta = \int_0^{\pi} (1 - \cos \theta)^3 \sin \theta \, d\theta = 4$$

$$24. I_x = \int_{-a}^a \int_{-\sqrt{a^2-x^2}}^{\sqrt{a^2-x^2}} y^2 [k(x^2 + y^2)] \, dy \, dx = k \int_0^{2\pi} \int_0^a r^5 \sin^2 \theta \, dr \, d\theta = \frac{ka^6}{6} \int_0^{2\pi} \frac{1-\cos 2\theta}{2} \, d\theta = \frac{ka^6\pi}{6};$$

$$I_o = \int_{-a}^a \int_{-\sqrt{a^2-x^2}}^{\sqrt{a^2-x^2}} k(x^2 + y^2)^2 \, dy \, dx = k \int_0^{2\pi} \int_0^a r^5 \, dr \, d\theta = \frac{ka^6}{6} \int_0^{2\pi} \, d\theta = \frac{ka^6\pi}{3}$$

$$25. M = 2 \int_{\pi/6}^{\pi/2} \int_3^{6 \sin \theta} dr \, d\theta = 2 \int_{\pi/6}^{\pi/2} (6 \sin \theta - 3) \, d\theta = 6[-2 \cos \theta - \theta]_{\pi/6}^{\pi/2} = 6\sqrt{3} - 2\pi$$

$$26. I_o = \int_{\pi/2}^{3\pi/2} \int_1^{1-\cos \theta} r \, dr \, d\theta = \frac{1}{2} \int_{\pi/2}^{3\pi/2} (\cos^2 \theta - 2 \cos \theta) \, d\theta = \frac{1}{2} \left[\frac{\sin 2\theta}{4} + \frac{\theta}{2} - 2 \sin \theta\right]_{\pi/2}^{3\pi/2} = 2 + \frac{\pi}{4}$$

$$27. M = 2 \int_0^{\pi} \int_0^{1+\cos \theta} r \, dr \, d\theta = \int_0^{\pi} (1 + \cos \theta)^2 \, d\theta = \frac{3\pi}{2}; M_y = 2 \int_0^{\pi} \int_0^{1+\cos \theta} r^2 \cos \theta \, dr \, d\theta \\ = 2 \int_0^{\pi} \left(\frac{4 \cos \theta}{3} + \frac{15}{24} + \cos 2\theta - \sin^2 \theta \cos \theta + \frac{\cos 4\theta}{4}\right) \, d\theta = \frac{5\pi}{4} \Rightarrow \bar{x} = \frac{5}{6} \text{ and } \bar{y} = 0, \text{ by symmetry}$$

$$28. I_o = \int_0^{2\pi} \int_0^{1+\cos \theta} r^3 \, dr \, d\theta = \frac{1}{4} \int_0^{2\pi} (1 + \cos \theta)^4 \, d\theta = \frac{35\pi}{16}$$

$$29. \text{average} = \frac{4}{\pi a^2} \int_0^{\pi/2} \int_0^a r \sqrt{a^2 - r^2} \, dr \, d\theta = \frac{4}{3\pi a^2} \int_0^{\pi/2} a^3 \, d\theta = \frac{2a}{3}$$

$$30. \text{average} = \frac{4}{\pi a^2} \int_0^{\pi/2} \int_0^a r^2 \, dr \, d\theta = \frac{4}{3\pi a^2} \int_0^{\pi/2} a^3 \, d\theta = \frac{2a}{3}$$

$$31. \text{average} = \frac{1}{\pi a^2} \int_{-a}^a \int_{-\sqrt{a^2-x^2}}^{\sqrt{a^2-x^2}} \sqrt{x^2 + y^2} \, dy \, dx = \frac{1}{\pi a^2} \int_0^{2\pi} \int_0^a r^2 \, dr \, d\theta = \frac{a}{3\pi} \int_0^{2\pi} \, d\theta = \frac{2a}{3}$$

32. average = $\frac{1}{\pi} \iint_{\mathbf{R}} [(1-x)^2 + y^2] dy dx = \frac{1}{\pi} \int_0^{2\pi} \int_0^1 [(1-r \cos \theta)^2 + r^2 \sin^2 \theta] r dr d\theta$
 $= \frac{1}{\pi} \int_0^{2\pi} \int_0^1 (r^3 - 2r^2 \cos \theta + r) dr d\theta = \frac{1}{\pi} \int_0^{2\pi} \left(\frac{3}{4} - \frac{2 \cos \theta}{3} \right) d\theta = \frac{1}{\pi} \left[\frac{3}{4} \theta - \frac{2 \sin \theta}{3} \right]_0^{2\pi} = \frac{3}{2}$
33. $\int_0^{2\pi} \int_1^{\sqrt{e}} \left(\frac{\ln r^2}{r} \right) r dr d\theta = \int_0^{2\pi} \int_1^{\sqrt{e}} 2 \ln r dr d\theta = 2 \int_0^{2\pi} [r \ln r - r]_1^{\sqrt{e}} d\theta = 2 \int_0^{2\pi} \sqrt{e} \left[\left(\frac{1}{2} - 1 \right) + 1 \right] d\theta = 2\pi(2 - \sqrt{e})$
34. $\int_0^{2\pi} \int_1^e \left(\frac{\ln r^2}{r} \right) dr d\theta = \int_0^{2\pi} \int_1^e \left(\frac{2 \ln r}{r} \right) dr d\theta = \int_0^{2\pi} [(\ln r)^2]_1^e d\theta = \int_0^{2\pi} d\theta = 2\pi$
35. $V = 2 \int_0^{\pi/2} \int_1^{1+\cos \theta} r^2 \cos \theta dr d\theta = \frac{2}{3} \int_0^{\pi/2} (3 \cos^2 \theta + 3 \cos^3 \theta + \cos^4 \theta) d\theta$
 $= \frac{2}{3} \left[\frac{15\theta}{8} + \sin 2\theta + 3 \sin \theta - \sin^3 \theta + \frac{\sin 4\theta}{32} \right]_0^{\pi/2} = \frac{4}{3} + \frac{5\pi}{8}$
36. $V = 4 \int_0^{\pi/4} \int_0^{\sqrt{2 \cos 2\theta}} r \sqrt{2-r^2} dr d\theta = -\frac{4}{3} \int_0^{\pi/4} [(2-2 \cos 2\theta)^{3/2} - 2^{3/2}] d\theta$
 $= \frac{2\pi\sqrt{2}}{3} - \frac{32}{3} \int_0^{\pi/4} (1 - \cos^2 \theta) \sin \theta d\theta = \frac{2\pi\sqrt{2}}{3} - \frac{32}{3} \left[\frac{\cos^3 \theta}{3} - \cos \theta \right]_0^{\pi/4} = \frac{6\pi\sqrt{2} + 40\sqrt{2} - 64}{9}$
37. (a) $I^2 = \int_0^{\infty} \int_0^{\infty} e^{-(x^2+y^2)} dx dy = \int_0^{\pi/2} \int_0^{\infty} (e^{-r^2}) r dr d\theta = \int_0^{\pi/2} \left[\lim_{b \rightarrow \infty} \int_0^b r e^{-r^2} dr \right] d\theta$
 $= -\frac{1}{2} \int_0^{\pi/2} \lim_{b \rightarrow \infty} (e^{-b^2} - 1) d\theta = \frac{1}{2} \int_0^{\pi/2} d\theta = \frac{\pi}{4} \Rightarrow I = \frac{\sqrt{\pi}}{2}$
 (b) $\lim_{x \rightarrow \infty} \int_0^x \frac{2e^{-t^2}}{\sqrt{\pi}} dt = \frac{2}{\sqrt{\pi}} \int_0^{\infty} e^{-t^2} dt = \left(\frac{2}{\sqrt{\pi}} \right) \left(\frac{\sqrt{\pi}}{2} \right) = 1$, from part (a)
38. $\int_0^{\infty} \int_0^{\infty} \frac{1}{(1+x^2+y^2)^2} dx dy = \int_0^{\pi/2} \int_0^{\infty} \frac{r}{(1+r^2)^2} dr d\theta = \frac{\pi}{2} \lim_{b \rightarrow \infty} \int_0^b \frac{r}{(1+r^2)^2} dr = \frac{\pi}{4} \lim_{b \rightarrow \infty} \left[-\frac{1}{1+r^2} \right]_0^b$
 $= \frac{\pi}{4} \lim_{b \rightarrow \infty} \left(1 - \frac{1}{1+b^2} \right) = \frac{\pi}{4}$
39. Over the disk $x^2 + y^2 \leq \frac{3}{4}$: $\iint_{\mathbf{R}} \frac{1}{1-x^2-y^2} dA = \int_0^{2\pi} \int_0^{\sqrt{3}/2} \frac{r}{1-r^2} dr d\theta = \int_0^{2\pi} \left[-\frac{1}{2} \ln(1-r^2) \right]_0^{\sqrt{3}/2} d\theta$
 $= \int_0^{2\pi} \left(-\frac{1}{2} \ln \frac{1}{4} \right) d\theta = (\ln 2) \int_0^{2\pi} d\theta = \pi \ln 4$
 Over the disk $x^2 + y^2 \leq 1$: $\iint_{\mathbf{R}} \frac{1}{1-x^2-y^2} dA = \int_0^{2\pi} \int_0^1 \frac{r}{1-r^2} dr d\theta = \int_0^{2\pi} \left[\lim_{a \rightarrow 1^-} \int_0^a \frac{r}{1-r^2} dr \right] d\theta$
 $= \int_0^{2\pi} \lim_{a \rightarrow 1^-} \left[-\frac{1}{2} \ln(1-a^2) \right] d\theta = 2\pi \cdot \lim_{a \rightarrow 1^-} \left[-\frac{1}{2} \ln(1-a^2) \right] = 2\pi \cdot \infty$, so the integral does not exist over $x^2 + y^2 \leq 1$
40. The area in polar coordinates is given by $A = \int_{\alpha}^{\beta} \int_0^{f(\theta)} r dr d\theta = \int_{\alpha}^{\beta} \left[\frac{r^2}{2} \right]_0^{f(\theta)} d\theta = \frac{1}{2} \int_{\alpha}^{\beta} f^2(\theta) d\theta = \int_{\alpha}^{\beta} \frac{1}{2} r^2 d\theta$,
 where $r = f(\theta)$
41. average = $\frac{1}{\pi a^2} \int_0^{2\pi} \int_0^a [(r \cos \theta - h)^2 + r^2 \sin^2 \theta] r dr d\theta = \frac{1}{\pi a^2} \int_0^{2\pi} \int_0^a (r^3 - 2r^2 h \cos \theta + rh^2) dr d\theta$
 $= \frac{1}{\pi a^2} \int_0^{2\pi} \left(\frac{a^4}{4} - \frac{2a^3 h \cos \theta}{3} + \frac{a^2 h^2}{2} \right) d\theta = \frac{1}{\pi} \int_0^{2\pi} \left(\frac{a^2}{4} - \frac{2ah \cos \theta}{3} + \frac{h^2}{2} \right) d\theta = \frac{1}{\pi} \left[\frac{a^2 \theta}{4} - \frac{2ah \sin \theta}{3} + \frac{h^2 \theta}{2} \right]_0^{2\pi}$
 $= \frac{1}{2} (a^2 + 2h^2)$

$$42. A = \int_{\pi/4}^{3\pi/4} \int_{\csc \theta}^{2 \sin \theta} r \, dr \, d\theta = \frac{1}{2} \int_{\pi/4}^{3\pi/4} (4 \sin^2 \theta - \csc^2 \theta) \, d\theta$$

$$= \frac{1}{2} [2\theta - \sin 2\theta + \cot \theta]_{\pi/4}^{3\pi/4} = \frac{\pi}{2}$$

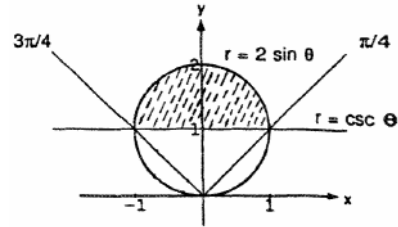

44-46. Example CAS commands:

Maple:

```
f := (x,y) -> y/(x^2+y^2);
a,b := 0,1;
f1 := x -> x;
f2 := x -> 1;
plot3d( f(x,y), y=f1(x)..f2(x), x=a..b, axes=boxed, style=patchngrid, shading=zhue, orientation=[0,180], title="#43(a)
      (Section 15.3)" ); # (a)
q1 := eval( x=a, [x=r*cos(theta),y=r*sin(theta)] ); # (b)
q2 := eval( x=b, [x=r*cos(theta),y=r*sin(theta)] );
q3 := eval( y=f1(x), [x=r*cos(theta),y=r*sin(theta)] );
q4 := eval( y=f2(x), [x=r*cos(theta),y=r*sin(theta)] );
theta1 := solve( q3, theta );
theta2 := solve( q1, theta );
r1 := 0;
r2 := solve( q4, r );
plot3d(0,r=r1..r2, theta=theta1..theta2, axes=boxed, style=patchngrid, shading=zhue, orientation=[-90,0],
      title="#43(c) (Section 15.3)" );
fP := simplify(eval( f(x,y), [x=r*cos(theta),y=r*sin(theta)] )); # (d)
q5 := Int( Int( fP*r, r=r1..r2 ), theta=theta1..theta2 );
value( q5 );
```

Mathematica: (functions and bounds will vary)

For 43 and 44, begin by drawing the region of integration with the **FilledPlot** command.

```
Clear[x, y, r, t]
<<Graphics`FilledPlot`
FilledPlot[{x, 1}, {x, 0, 1}, AspectRatio -> 1, AxesLabel -> {x,y}];
```

The picture demonstrates that r goes from 0 to the line $y=1$ or $r = 1/\sin[t]$, while t goes from $\pi/4$ to $\pi/2$.

```
f:= y / (x^2 + y^2)
topolar={x -> r Cos[t], y -> r Sin[t]};
fp= f/.topolar //Simplify
Integrate[r fp, {t, pi/4, pi/2}, {r, 0, 1/Sin[t]}]
```

For 45 and 46, drawing the region of integration with the **ImplicitPlot** command.

```
Clear[x, y]
<<Graphics`ImplicitPlot`
ImplicitPlot[{x==y, x==2 - y, y==0, y==1}, {x, 0, 2.1}, {y, 0, 1.1}];
```

The picture shows that as t goes from 0 to $\pi/4$, r goes from 0 to the line $x=2 - y$. **Solve** will find the bound for r .

```
bdr=Solve[r Cos[t]==2 - r Sin[t], r]//Simplify
f:=Sqrt[x + y]
topolar={x -> r Cos[t], y -> r Sin[t]};
fp= f/.topolar //Simplify
Integrate[r fp, {t, 0, pi/4}, {r, 0, bdr[[1, 1, 2]]}]
```

15.4 TRIPLE INTEGRALS IN RECTANGULAR COORDINATES

$$1. \int_0^1 \int_0^{1-x} \int_{x+z}^1 F(x, y, z) \, dy \, dz \, dx = \int_0^1 \int_0^{1-x} \int_{x+z}^1 dy \, dz \, dx = \int_0^1 \int_0^{1-x} (1 - x - z) \, dz \, dx$$

$$= \int_0^1 \left[(1-x) - x(1-x) - \frac{(1-x)^2}{2} \right] dx = \int_0^1 \frac{(1-x)^2}{2} dx = \left[-\frac{(1-x)^3}{6} \right]_0^1 = \frac{1}{6}$$

$$2. \int_0^1 \int_0^2 \int_0^3 dz \, dy \, dx = \int_0^1 \int_0^2 3 \, dy \, dx = \int_0^1 6 \, dx = 6, \int_0^2 \int_0^1 \int_0^3 dz \, dx \, dy, \int_0^3 \int_0^2 \int_0^1 dx \, dy \, dz, \int_0^2 \int_0^3 \int_0^1 dx \, dz \, dy,$$

$$\int_0^3 \int_0^1 \int_0^2 dy \, dx \, dz, \int_0^1 \int_0^3 \int_0^2 dy \, dz \, dx$$

$$3. \int_0^1 \int_0^{2-2x} \int_0^{3-3x-3y/2} dz \, dy \, dx$$

$$= \int_0^1 \int_0^{2-2x} (3 - 3x - \frac{3}{2}y) \, dy \, dx$$

$$= \int_0^1 \left[3(1-x) \cdot 2(1-x) - \frac{3}{4} \cdot 4(1-x)^2 \right] dx$$

$$= 3 \int_0^1 (1-x)^2 \, dx = \left[-(1-x)^3 \right]_0^1 = 1,$$

$$\int_0^2 \int_0^{1-y/2} \int_0^{3-3x-3y/2} dz \, dx \, dy, \int_0^1 \int_0^{3-3x} \int_0^{2-2x-2z/3} dy \, dz \, dx,$$

$$\int_0^3 \int_0^{1-z/3} \int_0^{2-2x-2z/3} dy \, dx \, dz, \int_0^2 \int_0^{3-3y/2} \int_0^{1-y/2-z/3} dx \, dz \, dy,$$

$$\int_0^3 \int_0^{2-2z/3} \int_0^{1-y/2-z/3} dx \, dy \, dz$$

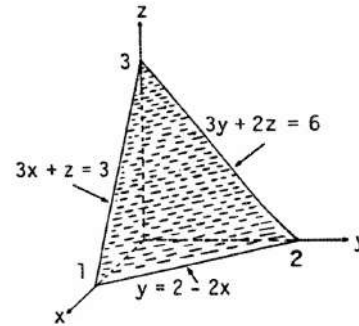

$$4. \int_0^2 \int_0^3 \int_0^{\sqrt{4-x^2}} dz \, dy \, dx = \int_0^2 \int_0^3 \sqrt{4-x^2} \, dy \, dx = \int_0^2 3\sqrt{4-x^2} \, dx = \frac{3}{2} \left[x\sqrt{4-x^2} + 4 \sin^{-1} \frac{x}{2} \right]_0^2 = 6 \sin^{-1} 1 = 3\pi,$$

$$\int_0^3 \int_0^2 \int_0^{\sqrt{4-x^2}} dz \, dx \, dy, \int_0^2 \int_0^{\sqrt{4-x^2}} \int_0^3 dy \, dz \, dx, \int_0^2 \int_0^{\sqrt{4-x^2}} \int_0^3 dy \, dx \, dz, \int_0^2 \int_0^3 \int_0^{\sqrt{4-x^2}} dx \, dy \, dz, \int_0^3 \int_0^2 \int_0^{\sqrt{4-x^2}} dx \, dz \, dy$$

$$5. \int_{-2}^2 \int_{-\sqrt{4-x^2}}^{\sqrt{4-x^2}} \int_{x^2+y^2}^{8-x^2-y^2} dz \, dy \, dx = 4 \int_0^2 \int_0^{\sqrt{4-x^2}} \int_{x^2+y^2}^{8-x^2-y^2} dz \, dy \, dx$$

$$= 4 \int_0^2 \int_0^{\sqrt{4-x^2}} [8 - 2(x^2 + y^2)] \, dy \, dx$$

$$= 8 \int_0^2 \int_0^{\sqrt{4-x^2}} (4 - x^2 - y^2) \, dy \, dx$$

$$= 8 \int_0^{\pi/2} \int_0^2 (4 - r^2) r \, dr \, d\theta = 8 \int_0^{\pi/2} \left[2r^2 - \frac{r^4}{4} \right]_0^2 d\theta$$

$$= 32 \int_0^{\pi/2} d\theta = 32 \left(\frac{\pi}{2} \right) = 16\pi,$$

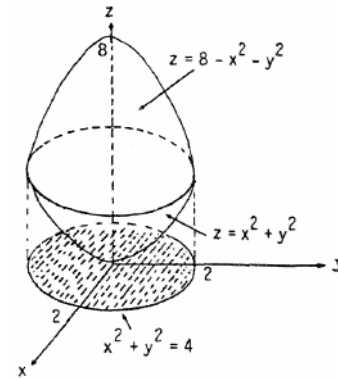

$$\int_{-2}^2 \int_{-\sqrt{4-y^2}}^{\sqrt{4-y^2}} \int_{x^2+y^2}^{8-x^2-y^2} dz \, dx \, dy,$$

$$\int_{-2}^2 \int_{y^2}^4 \int_{-\sqrt{z-y^2}}^{\sqrt{z-y^2}} dx \, dz \, dy + \int_{-2}^2 \int_4^{8-y^2} \int_{-\sqrt{8-z-y^2}}^{\sqrt{8-z-y^2}} dx \, dz \, dy,$$

$$\int_0^4 \int_{-\sqrt{z}}^{\sqrt{z}} \int_{-\sqrt{z-y^2}}^{\sqrt{z-y^2}} dx \, dy \, dz + \int_4^8 \int_{-\sqrt{8-z}}^{\sqrt{8-z}} \int_{-\sqrt{8-z-y^2}}^{\sqrt{8-z-y^2}} dx \, dy \, dz, \int_{-2}^2 \int_{x^2}^4 \int_{-\sqrt{z-x^2}}^{\sqrt{z-x^2}} dy \, dz \, dx + \int_{-2}^2 \int_4^{8-x^2} \int_{-\sqrt{8-z-x^2}}^{\sqrt{8-z-x^2}} dy \, dz \, dx,$$

$$\int_0^4 \int_{-\sqrt{z}}^{\sqrt{z}} \int_{-\sqrt{z-x^2}}^{\sqrt{z-x^2}} dy \, dx \, dz + \int_4^8 \int_{-\sqrt{8-z}}^{\sqrt{8-z}} \int_{-\sqrt{8-z-x^2}}^{\sqrt{8-z-x^2}} dy \, dx \, dz$$

6. The projection of D onto the xy -plane has the boundary $x^2 + y^2 = 2y \Rightarrow x^2 + (y - 1)^2 = 1$, which is a circle.

Therefore the two integrals are:

$$\int_0^2 \int_{-\sqrt{2y-y^2}}^{\sqrt{2y-y^2}} \int_{x^2+y^2}^{2y} dz dx dy \quad \text{and} \quad \int_{-1}^1 \int_{1-\sqrt{1-x^2}}^{1+\sqrt{1-x^2}} \int_{x^2+y^2}^{2y} dz dy dx$$

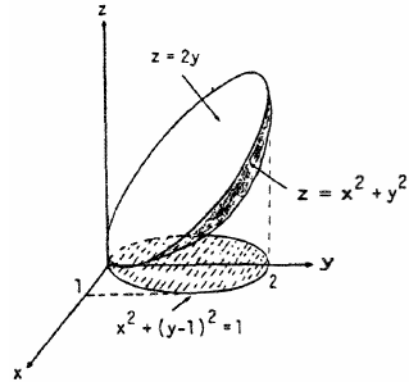

7. $\int_0^1 \int_0^1 \int_0^1 (x^2 + y^2 + z^2) dz dy dx = \int_0^1 \int_0^1 (x^2 + y^2 + \frac{1}{3}) dy dx = \int_0^1 (x^2 + \frac{2}{3}) dx = 1$
8. $\int_0^{\sqrt{2}} \int_0^{3y} \int_{x^2+3y^2}^{8-x^2-y^2} dz dx dy = \int_0^{\sqrt{2}} \int_0^{3y} (8 - 2x^2 - 4y^2) dx dy = \int_0^{\sqrt{2}} [8x - \frac{2}{3}x^3 - 4xy^2]_0^{3y} dy$
 $= \int_0^{\sqrt{2}} (24y - 18y^3 - 12y^3) dy = [12y^2 - \frac{15}{2}y^4]_0^{\sqrt{2}} = 24 - 30 = -6$
9. $\int_1^e \int_1^e \int_1^e \frac{1}{xyz} dx dy dz = \int_1^e \int_1^e [\frac{\ln x}{yz}]_1^e dy dz = \int_1^e \int_1^e \frac{1}{yz} dy dz = \int_1^e [\frac{\ln y}{z}]_1^e dz = \int_1^e \frac{1}{z} dz = 1$
10. $\int_0^1 \int_0^{3-3x} \int_0^{3-3x-y} dz dy dx = \int_0^1 \int_0^{3-3x} (3 - 3x - y) dy dx = \int_0^1 [(3 - 3x)y - \frac{1}{2}(3 - 3x)^2] dx = \frac{9}{2} \int_0^1 (1 - x)^2 dx$
 $= -\frac{3}{2} [(1 - x)^3]_0^1 = \frac{3}{2}$
11. $\int_0^1 \int_0^\pi \int_0^\pi y \sin z dx dy dz = \int_0^1 \int_0^\pi \pi y \sin z dy dz = \frac{\pi^3}{2} \int_0^1 \sin z dz = \frac{\pi^3}{2} (1 - \cos 1)$
12. $\int_{-1}^1 \int_{-1}^1 \int_{-1}^1 (x + y + z) dy dx dz = \int_{-1}^1 \int_{-1}^1 [xy + \frac{1}{2}y^2 + zy]_{-1}^1 dx dz = \int_{-1}^1 \int_{-1}^1 (2x + 2z) dx dz = \int_{-1}^1 [x^2 + 2zx]_{-1}^1 dz$
 $= \int_{-1}^1 4z dz = 0$
13. $\int_0^3 \int_0^{\sqrt{9-x^2}} \int_0^{\sqrt{9-x^2}} dz dy dx = \int_0^3 \int_0^{\sqrt{9-x^2}} \sqrt{9-x^2} dy dx = \int_0^3 (9 - x^2) dx = [9x - \frac{x^3}{3}]_0^3 = 18$
14. $\int_0^2 \int_{-\sqrt{4-y^2}}^{\sqrt{4-y^2}} \int_0^{2x+y} dz dx dy = \int_0^2 \int_{-\sqrt{4-y^2}}^{\sqrt{4-y^2}} (2x + y) dx dy = \int_0^2 [x^2 + xy]_{-\sqrt{4-y^2}}^{\sqrt{4-y^2}} dy = \int_0^2 (4 - y^2)^{1/2} (2y) dy$
 $= [-\frac{2}{3} (4 - y^2)^{3/2}]_0^2 = \frac{2}{3} (4)^{3/2} = \frac{16}{3}$
15. $\int_0^1 \int_0^{2-x} \int_0^{2-x-y} dz dy dx = \int_0^1 \int_0^{2-x} (2 - x - y) dy dx = \int_0^1 [(2 - x)y - \frac{1}{2}(2 - x)^2] dx = \frac{1}{2} \int_0^1 (2 - x)^2 dx$
 $= [-\frac{1}{6} (2 - x)^3]_0^1 = -\frac{1}{6} + \frac{8}{6} = \frac{7}{6}$
16. $\int_0^1 \int_0^{1-x^2} \int_3^{4-x^2-y} x dz dy dx = \int_0^1 \int_0^{1-x^2} x(1 - x^2 - y) dy dx = \int_0^1 x [(1 - x^2)^2 - \frac{1}{2}(1 - x^2)^2] dx = \int_0^1 \frac{1}{2} x (1 - x^2)^2 dx$
 $= [-\frac{1}{12} (1 - x^2)^3]_0^1 = \frac{1}{12}$
17. $\int_0^\pi \int_0^\pi \int_0^\pi \cos(u + v + w) du dv dw = \int_0^\pi \int_0^\pi [\sin(w + v + \pi) - \sin(w + v)] dv dw$
 $= \int_0^\pi [(-\cos(w + 2\pi) + \cos(w + \pi)) + (\cos(w + \pi) - \cos w)] dw$

$$= [-\sin(w + 2\pi) + \sin(w + \pi) - \sin w + \sin(w + \pi)]_0^\pi = 0$$

$$18. \int_1^e \int_1^e \int_1^e \ln r \ln s \ln t \, dt \, dr \, ds = \int_1^e \int_1^e (\ln r \ln s) [t \ln t - t]_1^e \, dr \, ds = \int_1^e (\ln s) [r \ln r - r]_1^e \, ds = [s \ln s - s]_1^e = 1$$

$$19. \int_0^{\pi/4} \int_0^{\ln \sec v} \int_{-\infty}^{2t} e^x \, dx \, dt \, dv = \int_0^{\pi/4} \int_0^{\ln \sec v} \lim_{b \rightarrow -\infty} (e^{2t} - e^b) \, dt \, dv = \int_0^{\pi/4} \int_0^{\ln \sec v} e^{2t} \, dt \, dv = \int_0^{\pi/4} \left(\frac{1}{2} e^{2 \ln \sec v} - \frac{1}{2} \right) \, dv \\ = \int_0^{\pi/4} \left(\frac{\sec^2 v}{2} - \frac{1}{2} \right) \, dv = \left[\frac{\tan v}{2} - \frac{v}{2} \right]_0^{\pi/4} = \frac{1}{2} - \frac{\pi}{8}$$

$$20. \int_0^7 \int_0^2 \int_0^{\sqrt{4-q^2}} \frac{q}{r+1} \, dp \, dq \, dr = \int_0^7 \int_0^2 \frac{q\sqrt{4-q^2}}{r+1} \, dq \, dr = \int_0^7 \frac{1}{3(r+1)} \left[-(4-q^2)^{3/2} \right]_0^2 \, dr = \frac{8}{3} \int_0^7 \frac{1}{r+1} \, dr \\ = \frac{8 \ln 8}{3} = 8 \ln 2$$

$$21. \text{(a)} \int_{-1}^1 \int_0^{1-x^2} \int_{x^2}^{1-z} dy \, dz \, dx \quad \text{(b)} \int_0^1 \int_{-\sqrt{1-z}}^{\sqrt{1-z}} \int_{x^2}^{1-z} dy \, dx \, dz \quad \text{(c)} \int_0^1 \int_0^{1-z} \int_{-\sqrt{y}}^{\sqrt{y}} dx \, dy \, dz$$

$$\text{(d)} \int_0^1 \int_0^{1-y} \int_{-\sqrt{y}}^{\sqrt{y}} dx \, dz \, dy \quad \text{(e)} \int_0^1 \int_{-\sqrt{y}}^{\sqrt{y}} \int_0^{1-y} dz \, dx \, dy$$

$$22. \text{(a)} \int_0^1 \int_0^1 \int_{-1}^{-\sqrt{z}} dy \, dz \, dx \quad \text{(b)} \int_0^1 \int_0^1 \int_{-1}^{-\sqrt{z}} dy \, dx \, dz \quad \text{(c)} \int_0^1 \int_{-1}^{-\sqrt{z}} \int_0^1 dx \, dy \, dz$$

$$\text{(d)} \int_{-1}^0 \int_0^{y^2} \int_0^1 dx \, dz \, dy \quad \text{(e)} \int_{-1}^0 \int_0^1 \int_0^{y^2} dz \, dx \, dy$$

$$23. V = \int_0^1 \int_{-1}^1 \int_0^{y^2} dz \, dy \, dx = \int_0^1 \int_{-1}^1 y^2 \, dy \, dx = \frac{2}{3} \int_0^1 dx = \frac{2}{3}$$

$$24. V = \int_0^1 \int_0^{1-x} \int_0^{2-2z} dy \, dz \, dx = \int_0^1 \int_0^{1-x} (2-2z) \, dz \, dx = \int_0^1 [2z - z^2]_0^{1-x} \, dx = \int_0^1 (1-x^2) \, dx = \left[x - \frac{x^3}{3} \right]_0^1 = \frac{2}{3}$$

$$25. V = \int_0^4 \int_0^{\sqrt{4-x}} \int_0^{2-y} dz \, dy \, dx = \int_0^4 \int_0^{\sqrt{4-x}} (2-y) \, dy \, dx = \int_0^4 \left[2\sqrt{4-x} - \left(\frac{4-x}{2} \right) \right] \, dx \\ = \left[-\frac{4}{3} (4-x)^{3/2} + \frac{1}{4} (4-x)^2 \right]_0^4 = \frac{4}{3} (4)^{3/2} - \frac{1}{4} (16) = \frac{32}{3} - 4 = \frac{20}{3}$$

$$26. V = 2 \int_0^1 \int_{-\sqrt{1-x^2}}^0 \int_0^{-y} dz \, dy \, dx = -2 \int_0^1 \int_{-\sqrt{1-x^2}}^0 y \, dy \, dx = \int_0^1 (1-x^2) \, dx = \frac{2}{3}$$

$$27. V = \int_0^1 \int_0^{2-2x} \int_0^{3-3x-3y/2} dz \, dy \, dx = \int_0^1 \int_0^{2-2x} (3-3x-\frac{3}{2}y) \, dy \, dx = \int_0^1 \left[6(1-x)^2 - \frac{3}{4} \cdot 4(1-x)^2 \right] \, dx \\ = \int_0^1 3(1-x)^2 \, dx = \left[-(1-x)^3 \right]_0^1 = 1$$

$$28. V = \int_0^1 \int_0^{1-x} \int_0^{\cos(\pi x/2)} dz \, dy \, dx = \int_0^1 \int_0^{1-x} \cos\left(\frac{\pi x}{2}\right) \, dy \, dx = \int_0^1 \cos\left(\frac{\pi x}{2}\right) (1-x) \, dx \\ = \int_0^1 \cos\left(\frac{\pi x}{2}\right) \, dx - \int_0^1 x \cos\left(\frac{\pi x}{2}\right) \, dx = \left[\frac{2}{\pi} \sin\left(\frac{\pi x}{2}\right) \right]_0^1 - \frac{4}{\pi^2} \int_0^{\pi/2} u \cos u \, du = \frac{2}{\pi} - \frac{4}{\pi^2} [\cos u + u \sin u]_0^{\pi/2} \\ = \frac{2}{\pi} - \frac{4}{\pi^2} \left(\frac{\pi}{2} - 1 \right) = \frac{4}{\pi^2}$$

$$29. V = 8 \int_0^1 \int_0^{\sqrt{1-x^2}} \int_0^{\sqrt{1-x^2}} dz \, dy \, dx = 8 \int_0^1 \int_0^{\sqrt{1-x^2}} \sqrt{1-x^2} \, dy \, dx = 8 \int_0^1 (1-x^2) \, dx = \frac{16}{3}$$

$$30. V = \int_0^2 \int_0^{4-x^2} \int_0^{4-x^2-y} dz \, dy \, dx = \int_0^2 \int_0^{4-x^2} (4-x^2-y) \, dy \, dx = \int_0^2 \left[(4-x^2)^2 - \frac{1}{2} (4-x^2)^2 \right] \, dx \\ = \frac{1}{2} \int_0^2 (4-x^2)^2 \, dx = \int_0^2 \left(8 - 4x^2 + \frac{x^4}{2} \right) \, dx = \frac{128}{15}$$

$$\begin{aligned}
 31. \quad V &= \int_0^4 \int_0^{(\sqrt{16-y^2})/2} \int_0^{4-y} dx \, dz \, dy = \int_0^4 \int_0^{(\sqrt{16-y^2})/2} (4-y) \, dz \, dy = \int_0^4 \frac{\sqrt{16-y^2}}{2} (4-y) \, dy \\
 &= \int_0^4 2\sqrt{16-y^2} \, dy - \frac{1}{2} \int_0^4 y\sqrt{16-y^2} \, dy = \left[y\sqrt{16-y^2} + 16 \sin^{-1} \frac{y}{4} \right]_0^4 + \left[\frac{1}{6} (16-y^2)^{3/2} \right]_0^4 \\
 &= 16 \left(\frac{\pi}{2} \right) - \frac{1}{6} (16)^{3/2} = 8\pi - \frac{32}{3}
 \end{aligned}$$

$$\begin{aligned}
 32. \quad V &= \int_{-2}^2 \int_{-\sqrt{4-x^2}}^{\sqrt{4-x^2}} \int_0^{3-x} dz \, dy \, dx = \int_{-2}^2 \int_{-\sqrt{4-x^2}}^{\sqrt{4-x^2}} (3-x) \, dy \, dx = 2 \int_{-2}^2 (3-x)\sqrt{4-x^2} \, dx \\
 &= 3 \int_{-2}^2 2\sqrt{4-x^2} \, dx - 2 \int_{-2}^2 x\sqrt{4-x^2} \, dx = 3 \left[x\sqrt{4-x^2} + 4 \sin^{-1} \frac{x}{2} \right]_{-2}^2 + \left[\frac{2}{3} (4-x^2)^{3/2} \right]_{-2}^2 \\
 &= 12 \sin^{-1} 1 - 12 \sin^{-1} (-1) = 12 \left(\frac{\pi}{2} \right) - 12 \left(-\frac{\pi}{2} \right) = 12\pi
 \end{aligned}$$

$$\begin{aligned}
 33. \quad \int_0^2 \int_0^{2-x} \int_{(2-x-y)/2}^{4-2x-2y} dz \, dy \, dx &= \int_0^2 \int_0^{2-x} \left(3 - \frac{3x}{2} - \frac{3y}{2} \right) dy \, dx \\
 &= \int_0^2 \left[3 \left(1 - \frac{x}{2} \right) (2-x) - \frac{3}{4} (2-x)^2 \right] dx \\
 &= \int_0^2 \left[6 - 6x + \frac{3x^2}{2} - \frac{3(2-x)^2}{4} \right] dx \\
 &= \left[6x - 3x^2 + \frac{x^3}{2} + \frac{(2-x)^3}{4} \right]_0^2 = (12 - 12 + 4 + 0) - \frac{2^3}{4} = 2
 \end{aligned}$$

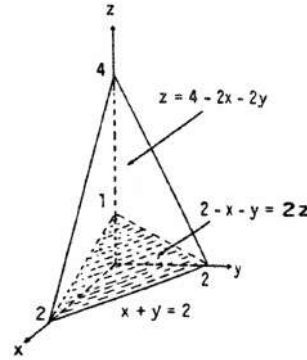

$$\begin{aligned}
 34. \quad V &= \int_0^4 \int_z^8 \int_z^{8-z} dx \, dy \, dz = \int_0^4 \int_z^8 (8-2z) \, dy \, dz = \int_0^4 (8-2z)(8-z) \, dz = \int_0^4 (64 - 24z + 2z^2) \, dz \\
 &= \left[64z - 12z^2 + \frac{2}{3} z^3 \right]_0^4 = \frac{320}{3}
 \end{aligned}$$

$$\begin{aligned}
 35. \quad V &= 2 \int_{-2}^2 \int_0^{\sqrt{4-x^2}/2} \int_0^{x+2} dz \, dy \, dx = 2 \int_{-2}^2 \int_0^{\sqrt{4-x^2}/2} (x+2) \, dy \, dx = \int_{-2}^2 (x+2)\sqrt{4-x^2} \, dx \\
 &= \int_{-2}^2 2\sqrt{4-x^2} \, dx + \int_{-2}^2 x\sqrt{4-x^2} \, dx = \left[x\sqrt{4-x^2} + 4 \sin^{-1} \frac{x}{2} \right]_{-2}^2 + \left[-\frac{1}{3} (4-x^2)^{3/2} \right]_{-2}^2 \\
 &= 4 \left(\frac{\pi}{2} \right) - 4 \left(-\frac{\pi}{2} \right) = 4\pi
 \end{aligned}$$

$$\begin{aligned}
 36. \quad V &= 2 \int_0^1 \int_0^{1-y^2} \int_0^{x^2+y^2} dz \, dx \, dy = 2 \int_0^1 \int_0^{1-y^2} (x^2+y^2) \, dx \, dy = 2 \int_0^1 \left[\frac{x^3}{3} + xy^2 \right]_0^{1-y^2} dy \\
 &= 2 \int_0^1 (1-y^2) \left[\frac{1}{3} (1-y^2)^2 + y^2 \right] dy = 2 \int_0^1 (1-y^2) \left(\frac{1}{3} + \frac{1}{3} y^2 + \frac{1}{3} y^4 \right) dy = \frac{2}{3} \int_0^1 (1-y^6) \, dy \\
 &= \frac{2}{3} \left[y - \frac{y^7}{7} \right]_0^1 = \left(\frac{2}{3} \right) \left(\frac{6}{7} \right) = \frac{4}{7}
 \end{aligned}$$

$$37. \quad \text{average} = \frac{1}{8} \int_0^2 \int_0^2 \int_0^2 (x^2+9) \, dz \, dy \, dx = \frac{1}{8} \int_0^2 \int_0^2 (2x^2+18) \, dy \, dx = \frac{1}{8} \int_0^2 (4x^2+36) \, dx = \frac{31}{3}$$

$$38. \quad \text{average} = \frac{1}{2} \int_0^1 \int_0^1 \int_0^2 (x+y-z) \, dz \, dy \, dx = \frac{1}{2} \int_0^1 \int_0^1 (2x+2y-2) \, dy \, dx = \frac{1}{2} \int_0^1 (2x-1) \, dx = 0$$

$$39. \quad \text{average} = \int_0^1 \int_0^1 \int_0^1 (x^2+y^2+z^2) \, dz \, dy \, dx = \int_0^1 \int_0^1 \left(x^2+y^2+\frac{1}{3} \right) dy \, dx = \int_0^1 \left(x^2+\frac{2}{3} \right) dx = 1$$

$$40. \quad \text{average} = \frac{1}{8} \int_0^2 \int_0^2 \int_0^2 xyz \, dz \, dy \, dx = \frac{1}{4} \int_0^2 \int_0^2 xy \, dy \, dx = \frac{1}{2} \int_0^2 x \, dx = 1$$

$$\begin{aligned}
 41. \quad \int_0^4 \int_0^1 \int_{2y}^2 \frac{4 \cos(x^2)}{2\sqrt{z}} \, dx \, dy \, dz &= \int_0^4 \int_0^2 \int_0^{x/2} \frac{4 \cos(x^2)}{2\sqrt{z}} \, dy \, dx \, dz = \int_0^4 \int_0^2 \frac{x \cos(x^2)}{\sqrt{z}} \, dx \, dz = \int_0^4 \left(\frac{\sin 4}{2} \right) z^{-1/2} \, dz \\
 &= \left[(\sin 4) z^{1/2} \right]_0^4 = 2 \sin 4
 \end{aligned}$$

$$42. \int_0^1 \int_0^1 \int_{x^2}^1 12xz e^{zy^2} dy dx dz = \int_0^1 \int_0^1 \int_0^{\sqrt{y}} 12xz e^{zy^2} dx dy dz = \int_0^1 \int_0^1 6yz e^{zy^2} dy dz = \int_0^1 [3e^{zy^2}]_0^1 dz \\ = 3 \int_0^1 (e^z - z) dz = 3 [e^z - 1]_0^1 = 3e - 6$$

$$43. \int_0^1 \int_{\sqrt[3]{z}}^1 \int_0^{\ln 3} \frac{\pi e^{2x} \sin(\pi y^2)}{y^2} dx dy dz = \int_0^1 \int_{\sqrt[3]{z}}^1 \frac{4\pi \sin(\pi y^2)}{y^2} dy dz = \int_0^1 \int_0^{y^3} \frac{4\pi \sin(\pi y^2)}{y^2} dz dy \\ = \int_0^1 4\pi y \sin(\pi y^2) dy = [-2 \cos(\pi y^2)]_0^1 = -2(-1) + 2(1) = 4$$

$$44. \int_0^2 \int_0^{4-x^2} \int_0^x \frac{\sin 2z}{4-z} dy dz dx = \int_0^2 \int_0^{4-x^2} \frac{x \sin 2z}{4-z} dz dx = \int_0^4 \int_0^{\sqrt{4-z}} \left(\frac{\sin 2z}{4-z}\right) x dx dz = \int_0^4 \left(\frac{\sin 2z}{4-z}\right) \frac{1}{2} (4-z) dz \\ = \left[-\frac{1}{4} \cos 2z\right]_0^4 = \left[-\frac{1}{4} + \frac{1}{2} \sin^2 z\right]_0^4 = \frac{\sin^2 4}{2}$$

$$45. \int_0^1 \int_0^{4-a-x^2} \int_a^{4-x^2-y} dz dy dx = \frac{4}{15} \Rightarrow \int_0^1 \int_0^{4-a-x^2} (4-x^2-y-a) dy dx = \frac{4}{15} \\ \Rightarrow \int_0^1 \left[(4-a-x^2)^2 - \frac{1}{2} (4-a-x^2)^2 \right] dx = \frac{4}{15} \Rightarrow \frac{1}{2} \int_0^1 (4-a-x^2)^2 dx = \frac{4}{15} \Rightarrow \int_0^1 [(4-a)^2 - 2x^2(4-a) + x^4] dx \\ = \frac{8}{15} \Rightarrow \left[(4-a)^2 x - \frac{2}{3} x^3(4-a) + \frac{x^5}{5} \right]_0^1 = \frac{8}{15} \Rightarrow (4-a)^2 - \frac{2}{3} (4-a) + \frac{1}{5} = \frac{8}{15} \Rightarrow 15(4-a)^2 - 10(4-a) - 5 = 0 \\ \Rightarrow 3(4-a)^2 - 2(4-a) - 1 = 0 \Rightarrow [3(4-a) + 1][(4-a) - 1] = 0 \Rightarrow 4-a = -\frac{1}{3} \text{ or } 4-a = 1 \Rightarrow a = \frac{13}{3} \text{ or } a = 3$$

46. The volume of the ellipsoid $\frac{x^2}{a^2} + \frac{y^2}{b^2} + \frac{z^2}{c^2} = 1$ is $\frac{4abc\pi}{3}$ so that $\frac{4(1)(2)(c)\pi}{3} = 8\pi \Rightarrow c = 3$.

47. To minimize the integral, we want the domain to include all points where the integrand is negative and to exclude all points where it is positive. These criteria are met by the points (x, y, z) such that $4x^2 + 4y^2 + z^2 - 4 \leq 0$ or $4x^2 + 4y^2 + z^2 \leq 4$, which is a solid ellipsoid centered at the origin.

48. To maximize the integral, we want the domain to include all points where the integrand is positive and to exclude all points where it is negative. These criteria are met by the points (x, y, z) such that $1 - x^2 - y^2 - z^2 \geq 0$ or $x^2 + y^2 + z^2 \leq 1$, which is a solid sphere of radius 1 centered at the origin.

49-52. Example CAS commands:

Maple:

```
F := (x,y,z) -> x^2*y^2*z;
q1 := Int( Int( Int( F(x,y,z), y=-sqrt(1-x^2)..sqrt(1-x^2) ), x=-1..1 ), z=0..1 );
value( q1 );
```

Mathematica: (functions and bounds will vary)

Due to the nature of the bounds, cylindrical coordinates are appropriate, although Mathematica can do it as is also.

```
Clear[f, x, y, z];
f:= x^2 y^2 z
Integrate[f, {x,-1,1}, {y,-Sqrt[1-x^2], Sqrt[1-x^2]}, {z, 0, 1}]
N[%]
topolar={x -> r Cos[t], y -> r Sin[t]};
fp= f/.topolar //Simplify
Integrate[r fp, {t, 0, 2π}, {r, 0, 1},{z, 0, 1}]
N[%]
```

15.5 MASSES AND MOMENTS IN THREE DIMENSIONS

$$\begin{aligned}
 1. \quad I_x &= \int_{-c/2}^{c/2} \int_{-b/2}^{b/2} \int_{-a/2}^{a/2} (y^2 + z^2) \, dx \, dy \, dz = a \int_{-c/2}^{c/2} \int_{-b/2}^{b/2} (y^2 + z^2) \, dy \, dz = a \int_{-c/2}^{c/2} \left[\frac{y^3}{3} + yz^2 \right]_{-b/2}^{b/2} dz \\
 &= a \int_{-c/2}^{c/2} \left(\frac{b^3}{12} + bz^2 \right) dz = ab \left[\frac{b^2}{12} z + \frac{z^3}{3} \right]_{-c/2}^{c/2} = ab \left(\frac{b^2 c}{12} + \frac{c^3}{12} \right) = \frac{abc}{12} (b^2 + c^2) = \frac{M}{12} (b^2 + c^2); \\
 R_x &= \sqrt{\frac{b^2 + c^2}{12}}; \text{ likewise } R_y = \sqrt{\frac{a^2 + c^2}{12}} \text{ and } R_z = \sqrt{\frac{a^2 + b^2}{12}}, \text{ by symmetry}
 \end{aligned}$$

$$\begin{aligned}
 2. \quad \text{The plane } z = \frac{4-2y}{3} \text{ is the top of the wedge } \Rightarrow I_x &= \int_{-3}^3 \int_{-2}^4 \int_{-4/3}^{(4-2y)/3} (y^2 + z^2) \, dz \, dy \, dx \\
 &= \int_{-3}^3 \int_{-2}^4 \left[\frac{8y^2}{3} - \frac{2y^3}{3} + \frac{8(2-y)^3}{81} + \frac{64}{81} \right] dy \, dx = \int_{-3}^3 \frac{104}{3} \, dx = 208; \quad I_y = \int_{-3}^3 \int_{-2}^4 \int_{-4/3}^{(4-2y)/3} (x^2 + z^2) \, dz \, dy \, dx \\
 &= \int_{-3}^3 \int_{-2}^4 \left[\frac{(4-2y)^3}{81} + \frac{x^2(4-2y)}{3} + \frac{4x^2}{3} + \frac{64}{81} \right] dy \, dx = \int_{-3}^3 (12x^2 + \frac{32}{3}) \, dx = 280; \\
 I_z &= \int_{-3}^3 \int_{-2}^4 \int_{-4/3}^{(4-2y)/3} (x^2 + y^2) \, dz \, dy \, dx = \int_{-3}^3 \int_{-2}^4 (x^2 + y^2) \left(\frac{8}{3} - \frac{2y}{3} \right) dy \, dx = 12 \int_{-3}^3 (x^2 + 2) \, dx = 360
 \end{aligned}$$

$$\begin{aligned}
 3. \quad I_x &= \int_0^a \int_0^b \int_0^c (y^2 + z^2) \, dz \, dy \, dx = \int_0^a \int_0^b \left(cy^2 + \frac{c^3}{3} \right) dy \, dx = \int_0^a \left(\frac{cb^3}{3} + \frac{c^3 b}{3} \right) dx = \frac{abc(b^2 + c^2)}{3} \\
 &= \frac{M}{3} (b^2 + c^2) \text{ where } M = abc; \quad I_y = \frac{M}{3} (a^2 + c^2) \text{ and } I_z = \frac{M}{3} (a^2 + b^2), \text{ by symmetry}
 \end{aligned}$$

$$\begin{aligned}
 4. \quad (a) \quad M &= \int_0^1 \int_0^{1-x} \int_0^{1-x-y} dz \, dy \, dx = \int_0^1 \int_0^{1-x} (1-x-y) \, dy \, dx = \int_0^1 \left(\frac{x^2}{2} - x + \frac{1}{2} \right) dx = \frac{1}{6}; \\
 M_{yz} &= \int_0^1 \int_0^{1-x} \int_0^{1-x-y} x \, dz \, dy \, dx = \int_0^1 \int_0^{1-x} x(1-x-y) \, dy \, dx = \frac{1}{2} \int_0^1 (x^3 - 2x^2 + x) \, dx = \frac{1}{24} \\
 \Rightarrow \bar{x} = \bar{y} = \bar{z} &= \frac{1}{4}, \text{ by symmetry; } I_x = \int_0^1 \int_0^{1-x} \int_0^{1-x-y} (y^2 + z^2) \, dz \, dy \, dx \\
 &= \int_0^1 \int_0^{1-x} \left[y^2 - xy^2 - y^3 + \frac{(1-x-y)^3}{3} \right] dy \, dx = \frac{1}{6} \int_0^1 (1-x)^4 \, dx = \frac{1}{30} \Rightarrow I_y = I_x = \frac{1}{30}, \text{ by symmetry}
 \end{aligned}$$

$$\begin{aligned}
 (b) \quad R_x &= \sqrt{\frac{I_x}{M}} = \sqrt{\frac{1}{5}} = \frac{\sqrt{5}}{5} \approx 0.4472; \text{ the distance from the centroid to the } x\text{-axis is } \sqrt{0^2 + \frac{1}{16} + \frac{1}{16}} = \sqrt{\frac{1}{8}} = \frac{\sqrt{2}}{4} \\
 &\approx 0.3536
 \end{aligned}$$

$$\begin{aligned}
 5. \quad M &= 4 \int_0^1 \int_0^1 \int_{4y^2}^4 dz \, dy \, dx = 4 \int_0^1 \int_0^1 (4 - 4y^2) \, dy \, dx = 16 \int_0^1 \frac{2}{3} \, dx = \frac{32}{3}; \quad M_{xy} = 4 \int_0^1 \int_0^1 \int_{4y^2}^4 z \, dz \, dy \, dx \\
 &= 2 \int_0^1 \int_0^1 (16 - 16y^4) \, dy \, dx = \frac{128}{5} \int_0^1 dx = \frac{128}{5} \Rightarrow \bar{z} = \frac{12}{5}, \text{ and } \bar{x} = \bar{y} = 0, \text{ by symmetry;} \\
 I_x &= 4 \int_0^1 \int_0^1 \int_{4y^2}^4 (y^2 + z^2) \, dz \, dy \, dx = 4 \int_0^1 \int_0^1 \left[(4y^2 + \frac{64}{3}) - (4y^4 + \frac{64y^6}{3}) \right] dy \, dx = 4 \int_0^1 \frac{1976}{105} \, dx = \frac{7904}{105}; \\
 I_y &= 4 \int_0^1 \int_0^1 \int_{4y^2}^4 (x^2 + z^2) \, dz \, dy \, dx = 4 \int_0^1 \int_0^1 \left[(4x^2 + \frac{64}{3}) - (4x^2 y^2 + \frac{64y^6}{3}) \right] dy \, dx = 4 \int_0^1 \left(\frac{8}{3} x^2 + \frac{128}{7} \right) dx \\
 &= \frac{4832}{63}; \quad I_z = 4 \int_0^1 \int_0^1 \int_{4y^2}^4 (x^2 + y^2) \, dz \, dy \, dx = 16 \int_0^1 \int_0^1 (x^2 - x^2 y^2 + y^2 - y^4) \, dy \, dx \\
 &= 16 \int_0^1 \left(\frac{2x^2}{3} + \frac{2}{15} \right) dx = \frac{256}{45}
 \end{aligned}$$

$$\begin{aligned}
 6. \quad (a) \quad M &= \int_{-2}^2 \int_{(-\sqrt{4-x^2})/2}^{(\sqrt{4-x^2})/2} \int_0^{2-x} dz \, dy \, dx = \int_{-2}^2 \int_{(-\sqrt{4-x^2})/2}^{(\sqrt{4-x^2})/2} (2-x) \, dy \, dx = \int_{-2}^2 (2-x) \left(\sqrt{4-x^2} \right) dx = 4\pi; \\
 M_{yz} &= \int_{-2}^2 \int_{(-\sqrt{4-x^2})/2}^{(\sqrt{4-x^2})/2} \int_0^{2-x} x \, dz \, dy \, dx = \int_{-2}^2 \int_{(-\sqrt{4-x^2})/2}^{(\sqrt{4-x^2})/2} x(2-x) \, dy \, dx = \int_{-2}^2 x(2-x) \left(\sqrt{4-x^2} \right) dx = -2\pi; \\
 M_{xz} &= \int_{-2}^2 \int_{(-\sqrt{4-x^2})/2}^{(\sqrt{4-x^2})/2} \int_0^{2-x} y \, dz \, dy \, dx = \int_{-2}^2 \int_{(-\sqrt{4-x^2})/2}^{(\sqrt{4-x^2})/2} y(2-x) \, dy \, dx \\
 &= \frac{1}{2} \int_{-2}^2 (2-x) \left[\frac{4-x^2}{4} - \frac{4-x^2}{4} \right] dx = 0 \Rightarrow \bar{x} = -\frac{1}{2} \text{ and } \bar{y} = 0
 \end{aligned}$$

$$(b) M_{xy} = \int_{-2}^2 \int_{(-\sqrt{4-x^2})/2}^{(\sqrt{4-x^2})/2} \int_0^{2-x} z \, dz \, dy \, dx = \frac{1}{2} \int_{-2}^2 \int_{(-\sqrt{4-x^2})/2}^{(\sqrt{4-x^2})/2} (2-x)^2 \, dy \, dx = \frac{1}{2} \int_{-2}^2 (2-x)^2 (\sqrt{4-x^2}) \, dx \\ = 5\pi \Rightarrow \bar{z} = \frac{5}{4}$$

$$7. (a) M = 4 \int_0^2 \int_0^{\sqrt{4-x^2}} \int_{x^2+y^2}^4 dz \, dy \, dx = 4 \int_0^{\pi/2} \int_0^2 \int_{r^2}^4 r \, dz \, dr \, d\theta = 4 \int_0^{\pi/2} \int_0^2 (4r - r^3) \, dr \, d\theta = 4 \int_0^{\pi/2} 4 \, d\theta = 8\pi; \\ M_{xy} = \int_0^{2\pi} \int_0^2 \int_{r^2}^4 zr \, dz \, dr \, d\theta = \int_0^{2\pi} \int_0^2 \frac{r}{2} (16 - r^4) \, dr \, d\theta = \frac{32}{3} \int_0^{2\pi} d\theta = \frac{64\pi}{3} \Rightarrow \bar{z} = \frac{8}{3}, \text{ and } \bar{x} = \bar{y} = 0, \\ \text{by symmetry}$$

$$(b) M = 8\pi \Rightarrow 4\pi = \int_0^{2\pi} \int_0^{\sqrt{c}} \int_{r^2}^c r \, dz \, dr \, d\theta = \int_0^{2\pi} \int_0^{\sqrt{c}} (cr - r^3) \, dr \, d\theta = \int_0^{2\pi} \frac{c^2}{4} \, d\theta = \frac{c^2\pi}{2} \Rightarrow c^2 = 8 \Rightarrow c = 2\sqrt{2}, \\ \text{since } c > 0$$

$$8. M = 8; M_{xy} = \int_{-1}^1 \int_3^5 \int_{-1}^1 z \, dz \, dy \, dx = \int_{-1}^1 \int_3^5 \left[\frac{z^2}{2}\right]_{-1}^1 \, dy \, dx = 0; M_{yz} = \int_{-1}^1 \int_3^5 \int_{-1}^1 x \, dz \, dy \, dx \\ = 2 \int_{-1}^1 \int_3^5 x \, dy \, dx = 4 \int_{-1}^1 x \, dx = 0; M_{xz} = \int_{-1}^1 \int_3^5 \int_{-1}^1 y \, dz \, dy \, dx = 2 \int_{-1}^1 \int_3^5 y \, dy \, dx = 16 \int_{-1}^1 dx = 32 \\ \Rightarrow \bar{x} = 0, \bar{y} = 4, \bar{z} = 0; I_x = \int_{-1}^1 \int_3^5 \int_{-1}^1 (y^2 + z^2) \, dz \, dy \, dx = \int_{-1}^1 \int_3^5 (2y^2 + \frac{2}{3}) \, dy \, dx = \frac{2}{3} \int_{-1}^1 100 \, dx = \frac{400}{3}; \\ I_y = \int_{-1}^1 \int_3^5 \int_{-1}^1 (x^2 + z^2) \, dz \, dy \, dx = \int_{-1}^1 \int_3^5 (2x^2 + \frac{2}{3}) \, dy \, dx = \frac{4}{3} \int_{-1}^1 (3x^2 + 1) \, dx = \frac{16}{3}; \\ I_z = \int_{-1}^1 \int_3^5 \int_{-1}^1 (x^2 + y^2) \, dz \, dy \, dx = 2 \int_{-1}^1 \int_3^5 (x^2 + y^2) \, dy \, dx = 2 \int_{-1}^1 (2x^2 + \frac{98}{3}) \, dx = \frac{400}{3} \Rightarrow R_x = R_z = \sqrt{\frac{50}{3}} \\ \text{and } R_y = \sqrt{\frac{2}{3}}$$

$$9. \text{The plane } y + 2z = 2 \text{ is the top of the wedge } \Rightarrow I_L = \int_{-2}^2 \int_{-2}^4 \int_{-1}^{(2-y)/2} [(y-6)^2 + z^2] \, dz \, dy \, dx \\ = \int_{-2}^2 \int_{-2}^4 \left[\frac{(y-6)^2(4-y)}{2} + \frac{(2-y)^3}{24} + \frac{1}{3} \right] \, dy \, dx; \text{ let } t = 2 - y \Rightarrow I_L = 4 \int_{-2}^4 \left(\frac{13t^3}{24} + 5t^2 + 16t + \frac{49}{3} \right) \, dt = 1386; \\ M = \frac{1}{2} (3)(6)(4) = 36 \Rightarrow R_L = \sqrt{\frac{I_L}{M}} = \sqrt{\frac{77}{2}}$$

$$10. \text{The plane } y + 2z = 2 \text{ is the top of the wedge } \Rightarrow I_L = \int_{-2}^2 \int_{-2}^4 \int_{-1}^{(2-y)/2} [(x-4)^2 + y^2] \, dz \, dy \, dx \\ = \frac{1}{2} \int_{-2}^2 \int_{-2}^4 (x^2 - 8x + 16 + y^2) (4-y) \, dy \, dx = \int_{-2}^2 (9x^2 - 72x + 162) \, dx = 696; M = \frac{1}{2} (3)(6)(4) = 36 \\ \Rightarrow R_L = \sqrt{\frac{I_L}{M}} = \sqrt{\frac{58}{3}}$$

$$11. M = 8; I_L = \int_0^4 \int_0^2 \int_0^1 [z^2 + (y-2)^2] \, dz \, dy \, dx = \int_0^4 \int_0^2 (y^2 - 4y + \frac{13}{3}) \, dy \, dx = \frac{10}{3} \int_0^4 dx = \frac{40}{3} \\ \Rightarrow R_L = \sqrt{\frac{I_L}{M}} = \sqrt{\frac{5}{3}}$$

$$12. M = 8; I_L = \int_0^4 \int_0^2 \int_0^1 [(x-4)^2 + y^2] \, dz \, dy \, dx = \int_0^4 \int_0^2 [(x-4)^2 + y^2] \, dy \, dx = \int_0^4 [2(x-4)^2 + \frac{8}{3}] \, dx = \frac{160}{3} \\ \Rightarrow R_L = \sqrt{\frac{I_L}{M}} = \sqrt{\frac{20}{3}}$$

$$13. (a) M = \int_0^2 \int_0^{2-x} \int_0^{2-x-y} 2x \, dz \, dy \, dx = \int_0^2 \int_0^{2-x} (4x - 2x^2 - 2xy) \, dy \, dx = \int_0^2 (x^3 - 4x^2 + 4x) \, dx = \frac{4}{3}$$

$$(b) M_{xy} = \int_0^2 \int_0^{2-x} \int_0^{2-x-y} 2xz \, dz \, dy \, dx = \int_0^2 \int_0^{2-x} x(2-x-y)^2 \, dy \, dx = \int_0^2 \frac{x(2-x)^3}{3} \, dx = \frac{8}{15}; M_{xz} = \frac{8}{15} \text{ by} \\ \text{symmetry}; M_{yz} = \int_0^2 \int_0^{2-x} \int_0^{2-x-y} 2x^2 \, dz \, dy \, dx = \int_0^2 \int_0^{2-x} 2x^2(2-x-y) \, dy \, dx = \int_0^2 (2x - x^2)^2 \, dx = \frac{16}{15} \\ \Rightarrow \bar{x} = \frac{4}{5}, \text{ and } \bar{y} = \bar{z} = \frac{2}{5}$$

14. (a) $M = \int_0^2 \int_0^{\sqrt{x}} \int_0^{4-x^2} kxy \, dz \, dy \, dx = k \int_0^2 \int_0^{\sqrt{x}} xy(4-x^2) \, dy \, dx = \frac{k}{2} \int_0^2 (4x^2 - x^4) \, dx = \frac{32k}{15}$
 (b) $M_{yz} = \int_0^2 \int_0^{\sqrt{x}} \int_0^{4-x^2} kx^2y \, dz \, dy \, dx = k \int_0^2 \int_0^{\sqrt{x}} x^2y(4-x^2) \, dy \, dx = \frac{k}{2} \int_0^2 (4x^3 - x^5) \, dx = \frac{8k}{3}$
 $\Rightarrow \bar{x} = \frac{5}{4}; M_{xz} = \int_0^2 \int_0^{\sqrt{x}} \int_0^{4-x^2} kxy^2 \, dz \, dy \, dx = k \int_0^2 \int_0^{\sqrt{x}} xy^2(4-x^2) \, dy \, dx = \frac{k}{3} \int_0^2 (4x^{5/2} - x^{9/2}) \, dx$
 $= \frac{256\sqrt{2}k}{231} \Rightarrow \bar{y} = \frac{40\sqrt{2}}{77}; M_{xy} = \int_0^2 \int_0^{\sqrt{x}} \int_0^{4-x^2} kxyz \, dz \, dy \, dx = \int_0^2 \int_0^{\sqrt{x}} xy(4-x^2)^2 \, dy \, dx$
 $= \frac{k}{4} \int_0^2 (16x^2 - 8x^4 + x^6) \, dx = \frac{256k}{105} \Rightarrow \bar{z} = \frac{8}{7}$

15. (a) $M = \int_0^1 \int_0^1 \int_0^1 (x+y+z+1) \, dz \, dy \, dx = \int_0^1 \int_0^1 (x+y+\frac{3}{2}) \, dy \, dx = \int_0^1 (x+2) \, dx = \frac{5}{2}$
 (b) $M_{xy} = \int_0^1 \int_0^1 \int_0^1 z(x+y+z+1) \, dz \, dy \, dx = \frac{1}{2} \int_0^1 \int_0^1 (x+y+\frac{5}{3}) \, dy \, dx = \frac{1}{2} \int_0^1 (x+\frac{13}{6}) \, dx = \frac{4}{3}$
 $\Rightarrow M_{xy} = M_{yz} = M_{xz} = \frac{4}{3}$, by symmetry $\Rightarrow \bar{x} = \bar{y} = \bar{z} = \frac{8}{15}$
 (c) $I_z = \int_0^1 \int_0^1 \int_0^1 (x^2+y^2)(x+y+z+1) \, dz \, dy \, dx = \int_0^1 \int_0^1 (x^2+y^2)(x+y+\frac{3}{2}) \, dy \, dx$
 $= \int_0^1 (x^3+2x^2+\frac{1}{3}x+\frac{3}{4}) \, dx = \frac{11}{6} \Rightarrow I_x = I_y = I_z = \frac{11}{6}$, by symmetry
 (d) $R_x = R_y = R_z = \sqrt{\frac{I_x}{M}} = \sqrt{\frac{11}{15}}$

16. The plane $y + 2z = 2$ is the top of the wedge.

(a) $M = \int_{-1}^1 \int_{-2}^4 \int_{-1}^{(2-y)/2} (x+1) \, dz \, dy \, dx = \int_{-1}^1 \int_{-2}^4 (x+1)(2-\frac{y}{2}) \, dy \, dx = 18$
 (b) $M_{yz} = \int_{-1}^1 \int_{-2}^4 \int_{-1}^{(2-y)/2} x(x+1) \, dz \, dy \, dx = \int_{-1}^1 \int_{-2}^4 x(x+1)(2-\frac{y}{2}) \, dy \, dx = 6;$
 $M_{xz} = \int_{-1}^1 \int_{-2}^4 \int_{-1}^{(2-y)/2} y(x+1) \, dz \, dy \, dx = \int_{-1}^1 \int_{-2}^4 y(x+1)(2-\frac{y}{2}) \, dy \, dx = 0;$
 $M_{xy} = \int_{-1}^1 \int_{-2}^4 \int_{-1}^{(2-y)/2} z(x+1) \, dz \, dy \, dx = \frac{1}{2} \int_{-1}^1 \int_{-2}^4 (x+1)(\frac{y^2}{4}-y) \, dy \, dx = 0 \Rightarrow \bar{x} = \frac{1}{3}$, and $\bar{y} = \bar{z} = 0$
 (c) $I_x = \int_{-1}^1 \int_{-2}^4 \int_{-1}^{(2-y)/2} (x+1)(y^2+z^2) \, dz \, dy \, dx = \int_{-1}^1 \int_{-2}^4 (x+1)[2y^2+\frac{1}{3}-\frac{y^3}{2}+\frac{1}{3}(1-\frac{y}{2})^3] \, dy \, dx = 45;$
 $I_y = \int_{-1}^1 \int_{-2}^4 \int_{-1}^{(2-y)/2} (x+1)(x^2+z^2) \, dz \, dy \, dx = \int_{-1}^1 \int_{-2}^4 (x+1)[2x^2+\frac{1}{3}-\frac{x^2y}{2}+\frac{1}{3}(1-\frac{y}{2})^3] \, dy \, dx = 15;$
 $I_z = \int_{-1}^1 \int_{-2}^4 \int_{-1}^{(2-y)/2} (x+1)(x^2+y^2) \, dz \, dy \, dx = \int_{-1}^1 \int_{-2}^4 (x+1)(2-\frac{y}{2})(x^2+y^2) \, dy \, dx = 42$
 (d) $R_x = \sqrt{\frac{I_x}{M}} = \sqrt{\frac{5}{2}}$, $R_y = \sqrt{\frac{I_y}{M}} = \sqrt{\frac{5}{6}}$, and $R_z = \sqrt{\frac{I_z}{M}} = \sqrt{\frac{7}{3}}$

17. $M = \int_0^1 \int_{z-1}^{1-z} \int_0^{\sqrt{z}} (2y+5) \, dy \, dx \, dz = \int_0^1 \int_{z-1}^{1-z} (z+5\sqrt{z}) \, dx \, dz = \int_0^1 2(z+5\sqrt{z})(1-z) \, dz$
 $= 2 \int_0^1 (5z^{1/2}+z-5z^{3/2}-z^2) \, dz = 2[\frac{10}{3}z^{3/2}+\frac{1}{2}z^2-2z^{5/2}-\frac{1}{3}z^3]_0^1 = 2(\frac{9}{3}-\frac{3}{2}) = 3$

18. $M = \int_{-2}^2 \int_{-\sqrt{4-x^2}}^{\sqrt{4-x^2}} \int_{2(x^2+y^2)}^{16-2(x^2+y^2)} \sqrt{x^2+y^2} \, dz \, dy \, dx = \int_{-2}^2 \int_{-\sqrt{4-x^2}}^{\sqrt{4-x^2}} \sqrt{x^2+y^2} [16-4(x^2+y^2)] \, dy \, dx$
 $= 4 \int_0^{2\pi} \int_0^2 r(4-r^2)r \, dr \, d\theta = 4 \int_0^{2\pi} [\frac{4r^3}{3}-\frac{r^5}{5}]_0^2 \, d\theta = 4 \int_0^{2\pi} \frac{64}{15} \, d\theta = \frac{512\pi}{15}$

19. (a) Let ΔV_i be the volume of the i th piece, and let (x_i, y_i, z_i) be a point in the i th piece. Then the work done by gravity in moving the i th piece to the xy -plane is approximately $W_i = m_i g z_i = (x_i + y_i + z_i + 1)g \Delta V_i$
 \Rightarrow the total work done is the triple integral $W = \int_0^1 \int_0^1 \int_0^1 (x+y+z+1)gz \, dz \, dy \, dx$
 $= g \int_0^1 \int_0^1 [\frac{1}{2}xz^2 + \frac{1}{2}yz^2 + \frac{1}{3}z^3 + \frac{1}{2}z^2]_0^1 \, dy \, dx = g \int_0^1 \int_0^1 (\frac{1}{2}x + \frac{1}{2}y + \frac{5}{6}) \, dy \, dx = g \int_0^1 [\frac{1}{2}xy + \frac{1}{4}y^2 + \frac{5}{6}y]_0^1 \, dx$
 $= g \int_0^1 (\frac{1}{2}x + \frac{13}{12}) \, dx = g[\frac{x^2}{4} + \frac{13}{12}x]_0^1 = g(\frac{16}{12}) = \frac{4}{3}g$

- (b) From Exercise 15 the center of mass is $(\frac{8}{15}, \frac{8}{15}, \frac{8}{15})$ and the mass of the liquid is $\frac{5}{2} \Rightarrow$ the work done by gravity in moving the center of mass to the xy -plane is $W = mgd = (\frac{5}{2})(g)(\frac{8}{15}) = \frac{4}{3}g$, which is the same as the work done in part (a).

20. (a) From Exercise 19(a) we see that the work done is $W = g \int_0^2 \int_0^{\sqrt{x}} \int_0^{4-x^2} kxyz \, dz \, dy \, dx$
 $= kg \int_0^2 \int_0^{\sqrt{x}} \frac{1}{2} xy (4 - x^2)^2 \, dy \, dx = \frac{kg}{4} \int_0^2 x^2 (4 - x^2)^2 \, dx = \frac{kg}{4} \int_0^2 (16x^2 - 8x^4 + x^6) \, dx$
 $= \frac{kg}{4} [\frac{16}{3}x^3 - \frac{8}{5}x^5 + \frac{1}{7}x^7]_0^2 = \frac{256kg}{105}$

- (b) From Exercise 14 the center of mass is $(\frac{5}{4}, \frac{40\sqrt{2}}{77}, \frac{8}{7})$ and the mass of the liquid is $\frac{32k}{15} \Rightarrow$ the work done by gravity in moving the center of mass to the xy -plane is $W = mgd = (\frac{32k}{15})(g)(\frac{8}{7}) = \frac{256kg}{105}$

21. (a) $\bar{x} = \frac{M_{yz}}{M} = 0 \Rightarrow \int \int \int_R x \delta(x, y, z) \, dx \, dy \, dz = 0 \Rightarrow M_{yz} = 0$

(b) $I_L = \int \int \int_D |\mathbf{v} - h\mathbf{i}|^2 \, dm = \int \int \int_D |(x - h)\mathbf{i} + y\mathbf{j}|^2 \, dm = \int \int \int_D (x^2 - 2xh + h^2 + y^2) \, dm$
 $= \int \int \int_D (x^2 + y^2) \, dm - 2h \int \int \int_D x \, dm + h^2 \int \int \int_D dm = I_x - 0 + h^2m = I_{c.m.} + h^2m$

22. $I_L = I_{c.m.} + mh^2 = \frac{2}{5}ma^2 + ma^2 = \frac{7}{5}ma^2$

23. (a) $(\bar{x}, \bar{y}, \bar{z}) = (\frac{a}{2}, \frac{b}{2}, \frac{c}{2}) \Rightarrow I_z = I_{c.m.} + abc \left(\sqrt{\frac{a^2}{4} + \frac{b^2}{4}} \right)^2 \Rightarrow I_{c.m.} = I_z - \frac{abc(a^2 + b^2)}{4}$
 $= \frac{abc(a^2 + b^2)}{3} - \frac{abc(a^2 + b^2)}{4} = \frac{abc(a^2 + b^2)}{12}; R_{c.m.} = \sqrt{\frac{I_{c.m.}}{M}} = \sqrt{\frac{a^2 + b^2}{12}}$

(b) $I_L = I_{c.m.} + abc \left(\sqrt{\frac{a^2}{4} + \left(\frac{b}{2} - 2b\right)^2} \right)^2 = \frac{abc(a^2 + b^2)}{12} + \frac{abc(a^2 + 9b^2)}{4} = \frac{abc(4a^2 + 28b^2)}{12}$
 $= \frac{abc(a^2 + 7b^2)}{3}; R_L = \sqrt{\frac{I_L}{M}} = \sqrt{\frac{a^2 + 7b^2}{3}}$

24. $M = \int_{-3}^3 \int_{-2}^4 \int_{-4/3}^{(4-2y)/3} dz \, dy \, dx = \int_{-3}^3 \int_{-2}^4 \frac{2}{3} (4 - y) \, dy \, dx = \int_{-3}^3 \frac{2}{3} \left[4y - \frac{y^2}{2} \right]_{-2}^4 \, dx = 12 \int_{-3}^3 dx = 72;$

$\bar{x} = \bar{y} = \bar{z} = 0$ from Exercise 2 $\Rightarrow I_x = I_{c.m.} + 72 \left(\sqrt{0^2 + 0^2} \right)^2 = I_{c.m.} \Rightarrow I_L = I_{c.m.} + 72 \left(\sqrt{16 + \frac{16}{9}} \right)^2$
 $= 208 + 72 \left(\frac{160}{9} \right) = 1488$

25. $M_{yz_{B_1 \cup B_2}} = \int \int \int_{B_1} x \, dV_1 + \int \int \int_{B_2} x \, dV_2 = M_{(yz)_1} + M_{(yz)_2} \Rightarrow \bar{x} = M_{(yz)_1} + M_{(yz)_2 m_1 + m_2}$; similarly,

$\bar{y} = M_{(xz)_1} + M_{(xz)_2 m_1 + m_2}$ and $\bar{z} = M_{(xy)_1} + M_{(xy)_2 m_1 + m_2} \Rightarrow \mathbf{c} = \bar{x}\mathbf{i} + \bar{y}\mathbf{j} + \bar{z}\mathbf{k}$
 $= \frac{1}{m_1 + m_2} [(M_{(yz)_1} + M_{(yz)_2})\mathbf{i} + (M_{(xz)_1} + M_{(xz)_2})\mathbf{j} + (M_{(xy)_1} + M_{(xy)_2})\mathbf{k}]$
 $= \frac{1}{m_1 + m_2} [(m_1\bar{x}_1 + m_2\bar{x}_2)\mathbf{i} + (m_1\bar{y}_1 + m_2\bar{y}_2)\mathbf{j} + (m_1\bar{z}_1 + m_2\bar{z}_2)\mathbf{k}]$
 $= \frac{1}{m_1 + m_2} [m_1(\bar{x}_1\mathbf{i} + \bar{y}_1\mathbf{j} + \bar{z}_1\mathbf{k}) + m_2(\bar{x}_2\mathbf{i} + \bar{y}_2\mathbf{j} + \bar{z}_2\mathbf{k})] = \frac{m_1\mathbf{c}_1 + m_2\mathbf{c}_2}{m_1 + m_2}$

26. (a) $\mathbf{c} = 12(\mathbf{i} + \frac{3}{2}\mathbf{j} + \mathbf{k}) + 2(\frac{1}{2}\mathbf{i} + 4\mathbf{j} + \frac{1}{2}\mathbf{k})12 + 2 = \frac{13}{2}\mathbf{i} + 13\mathbf{j} + \frac{13}{2}\mathbf{k} \Rightarrow \bar{x} = \frac{13}{14}, \bar{y} = \frac{13}{7}, \bar{z} = \frac{13}{14}$

(b) $\mathbf{c} = 12(\mathbf{i} + \frac{3}{2}\mathbf{j} + \mathbf{k}) + 12(\mathbf{i} + \frac{11}{2}\mathbf{j} - \frac{1}{2}\mathbf{k})12 + 12 = \frac{21}{2}\mathbf{i} + 7\mathbf{j} + \frac{1}{2}\mathbf{k} \Rightarrow \bar{x} = 1, \bar{y} = \frac{7}{2}, \bar{z} = \frac{1}{4}$

(c) $\mathbf{c} = 2(\frac{1}{2}\mathbf{i} + 4\mathbf{j} + \frac{1}{2}\mathbf{k}) + 12(\mathbf{i} + \frac{11}{2}\mathbf{j} - \frac{1}{2}\mathbf{k})2 + 12 = \frac{13\mathbf{i} + 74\mathbf{j} - 5\mathbf{k}}{14} \Rightarrow \bar{x} = \frac{13}{14}, \bar{y} = \frac{37}{7}, \bar{z} = -\frac{5}{14}$

(d) $\mathbf{c} = 12(\mathbf{i} + \frac{3}{2}\mathbf{j} + \mathbf{k}) + 2(\frac{1}{2}\mathbf{i} + 4\mathbf{j} + \frac{1}{2}\mathbf{k}) + 12(\mathbf{i} + \frac{11}{2}\mathbf{j} - \frac{1}{2}\mathbf{k})12 + 2 + 12 = \frac{25\mathbf{i} + 92\mathbf{j} + 7\mathbf{k}}{26} \Rightarrow \bar{x} = \frac{25}{26}, \bar{y} = \frac{46}{13}, \bar{z} = \frac{7}{26}$

27. (a) $\mathbf{c} = \frac{\left(\frac{\pi a^2 h}{3}\right)\left(\frac{h}{4}\mathbf{k}\right) + \left(\frac{2\pi a^3}{3}\right)\left(-\frac{3a}{8}\mathbf{k}\right)}{m_1 + m_2} = \frac{\left(\frac{a^2 \pi}{3}\right)\left(\frac{h^2 - 3a^2}{4}\mathbf{k}\right)}{m_1 + m_2}$, where $m_1 = \frac{\pi a^2 h}{3}$ and $m_2 = \frac{2\pi a^3}{3}$; if $\frac{h^2 - 3a^2}{4} = 0$, or $h = a\sqrt{3}$, then the centroid is on the common base

(b) See the solution to Exercise 55, Section 15.2, to see that $h = a\sqrt{2}$.

28. $\mathbf{c} = \frac{\left(\frac{s^2 h}{3}\right)\left(\frac{h}{4}\mathbf{k}\right) + s^3\left(-\frac{s}{2}\mathbf{k}\right)}{m_1 + m_2} = \frac{\left(\frac{s^2}{12}\right)\left[(h^2 - 6s^2)\mathbf{k}\right]}{m_1 + m_2}$, where $m_1 = \frac{s^2 h}{3}$ and $m_2 = s^3$; if $h^2 - 6s^2 = 0$,

or $h = \sqrt{6}s$, then the centroid is in the base of the pyramid. The corresponding result in 15.2, Exercise 56, is $h = \sqrt{3}s$.

15.6 TRIPLE INTEGRALS IN CYLINDRICAL AND SPHERICAL COORDINATES

1. $\int_0^{2\pi} \int_0^1 \int_r^{\sqrt{2-r^2}} dz \, r \, dr \, d\theta = \int_0^{2\pi} \int_0^1 [r(2-r^2)^{1/2} - r^2] \, dr \, d\theta = \int_0^{2\pi} \left[-\frac{1}{3}(2-r^2)^{3/2} - \frac{r^3}{3}\right]_0^1 d\theta$
 $= \int_0^{2\pi} \left(\frac{2^{3/2}}{3} - \frac{2}{3}\right) d\theta = \frac{4\pi(\sqrt{2}-1)}{3}$

2. $\int_0^{2\pi} \int_0^3 \int_{r^2/3}^{\sqrt{18-r^2}} dz \, r \, dr \, d\theta = \int_0^{2\pi} \int_0^3 [r(18-r^2)^{1/2} - \frac{r^3}{3}] \, dr \, d\theta = \int_0^{2\pi} \left[-\frac{1}{3}(18-r^2)^{3/2} - \frac{r^4}{12}\right]_0^3 d\theta$
 $= \frac{9\pi(8\sqrt{2}-7)}{2}$

3. $\int_0^{2\pi} \int_0^{\theta/2\pi} \int_0^{3+24r^2} dz \, r \, dr \, d\theta = \int_0^{2\pi} \int_0^{\theta/2\pi} (3r + 24r^3) \, dr \, d\theta = \int_0^{2\pi} \left[\frac{3}{2}r^2 + 6r^4\right]_0^{\theta/2\pi} d\theta = \frac{3}{2} \int_0^{2\pi} \left(\frac{\theta^2}{4\pi^2} + \frac{4\theta^4}{16\pi^4}\right) d\theta$
 $= \frac{3}{2} \left[\frac{\theta^3}{12\pi^2} + \frac{\theta^5}{20\pi^4}\right]_0^{2\pi} = \frac{17\pi}{5}$

4. $\int_0^\pi \int_0^{\theta/\pi} \int_{-\sqrt{4-r^2}}^{3\sqrt{4-r^2}} z \, dz \, r \, dr \, d\theta = \int_0^\pi \int_0^{\theta/\pi} \frac{1}{2} [9(4-r^2) - (4-r^2)] r \, dr \, d\theta = 4 \int_0^\pi \int_0^{\theta/\pi} (4r - r^3) \, dr \, d\theta$
 $= 4 \int_0^\pi \left[2r^2 - \frac{r^4}{4}\right]_0^{\theta/\pi} d\theta = 4 \int_0^\pi \left(\frac{2\theta^2}{\pi^2} - \frac{\theta^4}{4\pi^4}\right) d\theta = \frac{37\pi}{15}$

5. $\int_0^{2\pi} \int_0^1 \int_r^{(2-r^2)^{-1/2}} 3 \, dz \, r \, dr \, d\theta = 3 \int_0^{2\pi} \int_0^1 [r(2-r^2)^{-1/2} - r^2] \, dr \, d\theta = 3 \int_0^{2\pi} \left[-(2-r^2)^{1/2} - \frac{r^3}{3}\right]_0^1 d\theta$
 $= 3 \int_0^{2\pi} \left(\sqrt{2} - \frac{4}{3}\right) d\theta = \pi(6\sqrt{2} - 8)$

6. $\int_0^{2\pi} \int_0^1 \int_{-1/2}^{1/2} (r^2 \sin^2 \theta + z^2) \, dz \, r \, dr \, d\theta = \int_0^{2\pi} \int_0^1 \left(r^3 \sin^2 \theta + \frac{r}{12}\right) \, dr \, d\theta = \int_0^{2\pi} \left(\frac{\sin^2 \theta}{4} + \frac{1}{24}\right) d\theta = \frac{\pi}{3}$

7. $\int_0^{2\pi} \int_0^3 \int_0^{z/3} r^3 \, dr \, dz \, d\theta = \int_0^{2\pi} \int_0^3 \frac{z^4}{324} \, dz \, d\theta = \int_0^{2\pi} \frac{3}{20} \, d\theta = \frac{3\pi}{10}$

8. $\int_{-1}^1 \int_0^{2\pi} \int_0^{1+\cos \theta} 4r \, dr \, d\theta \, dz = \int_{-1}^1 \int_0^{2\pi} 2(1 + \cos \theta)^2 \, d\theta \, dz = \int_{-1}^1 6\pi \, dz = 12\pi$

9. $\int_0^1 \int_0^{\sqrt{z}} \int_0^{2\pi} (r^2 \cos^2 \theta + z^2) r \, d\theta \, dr \, dz = \int_0^1 \int_0^{\sqrt{z}} \left[\frac{r^3 \theta}{2} + \frac{r^2 \sin 2\theta}{4} + z^2 \theta\right]_0^{2\pi} r \, dr \, dz = \int_0^1 \int_0^{\sqrt{z}} (\pi r^3 + 2\pi r z^2) \, dr \, dz$
 $= \int_0^1 \left[\frac{\pi r^4}{4} + \pi r^2 z^2\right]_0^{\sqrt{z}} dz = \int_0^1 \left(\frac{\pi z^2}{4} + \pi z^3\right) dz = \left[\frac{\pi z^3}{12} + \frac{\pi z^4}{4}\right]_0^1 = \frac{\pi}{3}$

10. $\int_0^2 \int_{r-2}^{\sqrt{4-r^2}} \int_0^{2\pi} (r \sin \theta + 1) r \, d\theta \, dz \, dr = \int_0^2 \int_{r-2}^{\sqrt{4-r^2}} 2\pi r \, dz \, dr = 2\pi \int_0^2 [r(4-r^2)^{1/2} - r^2 + 2r] \, dr$
 $= 2\pi \left[-\frac{1}{3}(4-r^2)^{3/2} - \frac{r^3}{3} + r^2\right]_0^2 = 2\pi \left[-\frac{8}{3} + 4 + \frac{1}{3}(4)^{3/2}\right] = 8\pi$

11. (a) $\int_0^{2\pi} \int_0^1 \int_0^{\sqrt{4-r^2}} dz r dr d\theta$
 (b) $\int_0^{2\pi} \int_0^{\sqrt{3}} \int_0^1 r dr dz d\theta + \int_0^{2\pi} \int_{\sqrt{3}}^2 \int_0^{\sqrt{4-z^2}} r dr dz d\theta$
 (c) $\int_0^1 \int_0^{\sqrt{4-r^2}} \int_0^{2\pi} r d\theta dz dr$

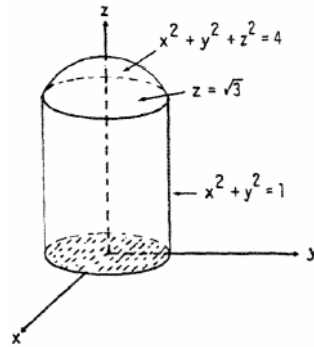

12. (a) $\int_0^{2\pi} \int_0^1 \int_r^{2-r^2} dz r dr d\theta$
 (b) $\int_0^{2\pi} \int_0^1 \int_0^z r dr dz d\theta + \int_0^{2\pi} \int_1^2 \int_0^{\sqrt{2-z}} r dr dz d\theta$
 (c) $\int_0^1 \int_r^{2-r^2} \int_0^{2\pi} r d\theta dz dr$

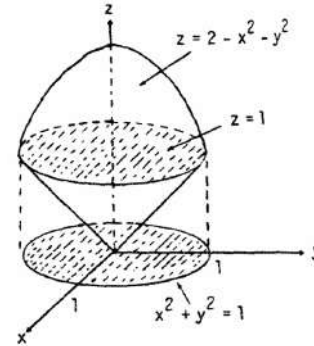

13. $\int_{-\pi/2}^{\pi/2} \int_0^{\cos \theta} \int_0^{3r^2} f(r, \theta, z) dz r dr d\theta$

14. $\int_{-\pi/2}^{\pi/2} \int_0^1 \int_0^{r \cos \theta} r^3 dz dr d\theta = \int_{-\pi/2}^{\pi/2} \int_0^1 r^4 \cos \theta dr d\theta = \frac{1}{5} \int_{-\pi/2}^{\pi/2} \cos \theta d\theta = \frac{2}{5}$

15. $\int_0^{\pi} \int_0^{2 \sin \theta} \int_0^{4-r \sin \theta} f(r, \theta, z) dz r dr d\theta$

16. $\int_{-\pi/2}^{\pi/2} \int_0^{3 \cos \theta} \int_0^{5-r \cos \theta} f(r, \theta, z) dz r dr d\theta$

17. $\int_{-\pi/2}^{\pi/2} \int_1^{1+\cos \theta} \int_0^4 f(r, \theta, z) dz r dr d\theta$

18. $\int_{-\pi/2}^{\pi/2} \int_{\cos \theta}^{2 \cos \theta} \int_0^{3-r \sin \theta} f(r, \theta, z) dz r dr d\theta$

19. $\int_0^{\pi/4} \int_0^{\sec \theta} \int_0^{2-r \sin \theta} f(r, \theta, z) dz r dr d\theta$

20. $\int_{\pi/4}^{\pi/2} \int_0^{\csc \theta} \int_0^{2-r \sin \theta} f(r, \theta, z) dz r dr d\theta$

21. $\int_0^{\pi} \int_0^{\pi} \int_0^{2 \sin \phi} \rho^2 \sin \phi d\rho d\phi d\theta = \frac{8}{3} \int_0^{\pi} \int_0^{\pi} \sin^4 \phi d\phi d\theta = \frac{8}{3} \int_0^{\pi} \left(\left[-\frac{\sin^3 \phi \cos \phi}{4} \right]_0^{\pi} + \frac{3}{4} \int_0^{\pi} \sin^2 \phi d\phi \right) d\theta$
 $= 2 \int_0^{\pi} \int_0^{\pi} \sin^2 \phi d\phi d\theta = \int_0^{\pi} \left[\theta - \frac{\sin 2\theta}{2} \right]_0^{\pi} d\theta = \int_0^{\pi} \pi d\theta = \pi^2$

22. $\int_0^{2\pi} \int_0^{\pi/4} \int_0^2 (\rho \cos \phi) \rho^2 \sin \phi d\rho d\phi d\theta = \int_0^{2\pi} \int_0^{\pi/4} 4 \cos \phi \sin \phi d\phi d\theta = \int_0^{2\pi} [2 \sin^2 \phi]_0^{\pi/4} d\theta = \int_0^{2\pi} d\theta = 2\pi$

23. $\int_0^{2\pi} \int_0^{\pi} \int_0^{(1-\cos \phi)/2} \rho^2 \sin \phi d\rho d\phi d\theta = \frac{1}{24} \int_0^{2\pi} \int_0^{\pi} (1-\cos \phi)^3 \sin \phi d\phi d\theta = \frac{1}{96} \int_0^{2\pi} [(1-\cos \phi)^4]_0^{\pi} d\theta$
 $= \frac{1}{96} \int_0^{2\pi} (2^4 - 0) d\theta = \frac{16}{96} \int_0^{2\pi} d\theta = \frac{1}{6} (2\pi) = \frac{\pi}{3}$

24. $\int_0^{3\pi/2} \int_0^{\pi} \int_0^1 5\rho^3 \sin^3 \phi d\rho d\phi d\theta = \frac{5}{4} \int_0^{3\pi/2} \int_0^{\pi} \sin^3 \phi d\phi d\theta = \frac{5}{4} \int_0^{3\pi/2} \left(\left[-\frac{\sin^2 \phi \cos \phi}{3} \right]_0^{\pi} + \frac{2}{3} \int_0^{\pi} \sin \phi d\phi \right) d\theta$
 $= \frac{5}{6} \int_0^{3\pi/2} [-\cos \phi]_0^{\pi} d\theta = \frac{5}{3} \int_0^{3\pi/2} d\theta = \frac{5\pi}{2}$

$$25. \int_0^{2\pi} \int_0^{\pi/3} \int_{\sec \phi}^2 3\rho^2 \sin \phi \, d\rho \, d\phi \, d\theta = \int_0^{2\pi} \int_0^{\pi/3} (8 - \sec^3 \phi) \sin \phi \, d\phi \, d\theta = \int_0^{2\pi} \left[-8 \cos \phi - \frac{1}{2} \sec^2 \phi \right]_0^{\pi/3} d\theta$$

$$= \int_0^{2\pi} \left[(-4 - 2) - (-8 - \frac{1}{2}) \right] d\theta = \frac{5}{2} \int_0^{2\pi} d\theta = 5\pi$$

$$26. \int_0^{2\pi} \int_0^{\pi/4} \int_0^{\sec \phi} \rho^3 \sin \phi \cos \phi \, d\rho \, d\phi \, d\theta = \frac{1}{4} \int_0^{2\pi} \int_0^{\pi/4} \tan \phi \sec^2 \phi \, d\phi \, d\theta = \frac{1}{4} \int_0^{2\pi} \left[\frac{1}{2} \tan^2 \phi \right]_0^{\pi/4} d\theta$$

$$= \frac{1}{8} \int_0^{2\pi} d\theta = \frac{\pi}{4}$$

$$27. \int_0^2 \int_{-\pi}^0 \int_{\pi/4}^{\pi/2} \rho^3 \sin 2\phi \, d\phi \, d\theta \, d\rho = \int_0^2 \int_{-\pi}^0 \rho^3 \left[-\frac{\cos 2\phi}{2} \right]_{\pi/4}^{\pi/2} d\theta \, d\rho = \int_0^2 \int_{-\pi}^0 \frac{\rho^3}{2} d\theta \, d\rho = \int_0^2 \frac{\rho^3 \pi}{2} d\rho$$

$$= \left[\frac{\pi \rho^4}{8} \right]_0^2 = 2\pi$$

$$28. \int_{\pi/6}^{\pi/3} \int_{\csc \phi}^{2 \csc \phi} \int_0^{2\pi} \rho^2 \sin \phi \, d\theta \, d\rho \, d\phi = 2\pi \int_{\pi/6}^{\pi/3} \int_{\csc \phi}^{2 \csc \phi} \rho^2 \sin \phi \, d\rho \, d\phi = \frac{2\pi}{3} \int_{\pi/6}^{\pi/3} [\rho^3 \sin \phi]_{\csc \phi}^{2 \csc \phi} d\phi$$

$$= \frac{14\pi}{3} \int_{\pi/6}^{\pi/3} \csc^2 \phi \, d\phi = \frac{28\pi}{3\sqrt{3}}$$

$$29. \int_0^1 \int_0^{\pi} \int_0^{\pi/4} 12\rho \sin^3 \phi \, d\phi \, d\theta \, d\rho = \int_0^1 \int_0^{\pi} \left(12\rho \left[\frac{-\sin^2 \phi \cos \phi}{3} \right]_0^{\pi/4} + 8\rho \int_0^{\pi/4} \sin \phi \, d\phi \right) d\theta \, d\rho$$

$$= \int_0^1 \int_0^{\pi} \left(-\frac{2\rho}{\sqrt{2}} - 8\rho [\cos \phi]_0^{\pi/4} \right) d\theta \, d\rho = \int_0^1 \int_0^{\pi} \left(8\rho - \frac{10\rho}{\sqrt{2}} \right) d\theta \, d\rho = \pi \int_0^1 \left(8\rho - \frac{10\rho}{\sqrt{2}} \right) d\rho = \pi \left[4\rho^2 - \frac{5\rho^2}{\sqrt{2}} \right]_0^1$$

$$= \frac{(4\sqrt{2}-5)\pi}{\sqrt{2}}$$

$$30. \int_{\pi/6}^{\pi/2} \int_{-\pi/2}^{\pi/2} \int_{\csc \phi}^2 5\rho^4 \sin^3 \phi \, d\rho \, d\theta \, d\phi = \int_{\pi/6}^{\pi/2} \int_{-\pi/2}^{\pi/2} (32 - \csc^5 \phi) \sin^3 \phi \, d\theta \, d\phi = \int_{\pi/6}^{\pi/2} \int_{-\pi/2}^{\pi/2} (32 \sin^3 \phi - \csc^2 \phi) \, d\theta \, d\phi$$

$$= \pi \int_{\pi/6}^{\pi/2} (32 \sin^3 \phi - \csc^2 \phi) \, d\phi = \pi \left[-\frac{32 \sin^2 \phi \cos \phi}{3} \right]_{\pi/6}^{\pi/2} + \frac{64\pi}{3} \int_{\pi/6}^{\pi/2} \sin \phi \, d\phi + \pi [\cot \phi]_{\pi/6}^{\pi/2}$$

$$= \pi \left(\frac{32\sqrt{3}}{24} \right) - \frac{64\pi}{3} [\cos \phi]_{\pi/6}^{\pi/2} - \pi (\sqrt{3}) = \frac{\sqrt{3}}{3} \pi + \left(\frac{64\pi}{3} \right) \left(\frac{\sqrt{3}}{2} \right) = \frac{33\pi\sqrt{3}}{3} = 11\pi\sqrt{3}$$

31. (a) $x^2 + y^2 = 1 \Rightarrow \rho^2 \sin^2 \phi = 1$, and $\rho \sin \phi = 1 \Rightarrow \rho = \csc \phi$; thus

$$\int_0^{2\pi} \int_0^{\pi/6} \int_0^2 \rho^2 \sin \phi \, d\rho \, d\phi \, d\theta + \int_0^{2\pi} \int_{\pi/6}^{\pi/2} \int_{\csc \phi}^{\csc \phi} \rho^2 \sin \phi \, d\rho \, d\phi \, d\theta$$

(b) $\int_0^{2\pi} \int_1^2 \int_{\pi/6}^{\sin^{-1}(1/\rho)} \rho^2 \sin \phi \, d\phi \, d\rho \, d\theta + \int_0^{2\pi} \int_0^2 \int_0^{\pi/6} \rho^2 \sin \phi \, d\phi \, d\rho \, d\theta$

32. (a) $\int_0^{2\pi} \int_0^{\pi/4} \int_0^{\sec \phi} \rho^2 \sin \phi \, d\rho \, d\phi \, d\theta$

(b) $\int_0^{2\pi} \int_0^1 \int_0^{\pi/4} \rho^2 \sin \phi \, d\phi \, d\rho \, d\theta$

$$+ \int_0^{2\pi} \int_1^{\sqrt{2}} \int_{\cos^{-1}(1/\rho)}^{\pi/4} \rho^2 \sin \phi \, d\phi \, d\rho \, d\theta$$

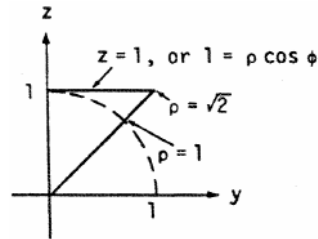

$$33. V = \int_0^{2\pi} \int_0^{\pi/2} \int_{\cos \phi}^2 \rho^2 \sin \phi \, d\rho \, d\phi \, d\theta = \frac{1}{3} \int_0^{2\pi} \int_0^{\pi/2} (8 - \cos^3 \phi) \sin \phi \, d\phi \, d\theta$$

$$= \frac{1}{3} \int_0^{2\pi} \left[-8 \cos \phi + \frac{\cos^4 \phi}{4} \right]_0^{\pi/2} d\theta = \frac{1}{3} \int_0^{2\pi} \left(8 - \frac{1}{4} \right) d\theta = \left(\frac{31}{12} \right) (2\pi) = \frac{31\pi}{6}$$

$$34. V = \int_0^{2\pi} \int_0^{\pi/2} \int_1^{1+\cos \phi} \rho^2 \sin \phi \, d\rho \, d\phi \, d\theta = \frac{1}{3} \int_0^{2\pi} \int_0^{\pi/2} (3 \cos \phi + 3 \cos^2 \phi + \cos^3 \phi) \sin \phi \, d\phi \, d\theta$$

$$= \frac{1}{3} \int_0^{2\pi} \left[-\frac{3}{2} \cos^2 \phi - \cos^3 \phi - \frac{1}{4} \cos^4 \phi \right]_0^{\pi/2} d\theta = \frac{1}{3} \int_0^{2\pi} \left(\frac{3}{2} + 1 + \frac{1}{4} \right) d\theta = \frac{11}{12} \int_0^{2\pi} d\theta = \left(\frac{11}{12} \right) (2\pi) = \frac{11\pi}{6}$$

$$\begin{aligned}
 35. \quad V &= \int_0^{2\pi} \int_0^\pi \int_0^{1-\cos\phi} \rho^2 \sin\phi \, d\rho \, d\phi \, d\theta = \frac{1}{3} \int_0^{2\pi} \int_0^\pi (1-\cos\phi)^3 \sin\phi \, d\phi \, d\theta = \frac{1}{3} \int_0^{2\pi} \left[\frac{(1-\cos\phi)^4}{4} \right]_0^\pi d\theta \\
 &= \frac{1}{12} (2)^4 \int_0^{2\pi} d\theta = \frac{4}{3} (2\pi) = \frac{8\pi}{3}
 \end{aligned}$$

$$\begin{aligned}
 36. \quad V &= \int_0^{2\pi} \int_0^{\pi/2} \int_0^{1-\cos\phi} \rho^2 \sin\phi \, d\rho \, d\phi \, d\theta = \frac{1}{3} \int_0^{2\pi} \int_0^{\pi/2} (1-\cos\phi)^3 \sin\phi \, d\phi \, d\theta = \frac{1}{3} \int_0^{2\pi} \left[\frac{(1-\cos\phi)^4}{4} \right]_0^{\pi/2} d\theta \\
 &= \frac{1}{12} \int_0^{2\pi} d\theta = \frac{1}{12} (2\pi) = \frac{\pi}{6}
 \end{aligned}$$

$$\begin{aligned}
 37. \quad V &= \int_0^{2\pi} \int_{\pi/4}^{\pi/2} \int_0^{2\cos\phi} \rho^2 \sin\phi \, d\rho \, d\phi \, d\theta = \frac{8}{3} \int_0^{2\pi} \int_{\pi/4}^{\pi/2} \cos^3\phi \sin\phi \, d\phi \, d\theta = \frac{8}{3} \int_0^{2\pi} \left[-\frac{\cos^4\phi}{4} \right]_{\pi/4}^{\pi/2} d\theta \\
 &= \left(\frac{8}{3}\right) \left(\frac{1}{16}\right) \int_0^{2\pi} d\theta = \frac{1}{6} (2\pi) = \frac{\pi}{3}
 \end{aligned}$$

$$38. \quad V = \int_0^{2\pi} \int_{\pi/3}^{\pi/2} \int_0^2 \rho^2 \sin\phi \, d\rho \, d\phi \, d\theta = \frac{8}{3} \int_0^{2\pi} \int_{\pi/3}^{\pi/2} \sin\phi \, d\phi \, d\theta = \frac{8}{3} \int_0^{2\pi} [-\cos\phi]_{\pi/3}^{\pi/2} d\theta = \frac{4}{3} \int_0^{2\pi} d\theta = \frac{8\pi}{3}$$

$$\begin{aligned}
 39. \quad (a) \quad & 8 \int_0^{\pi/2} \int_0^{\pi/2} \int_0^2 \rho^2 \sin\phi \, d\rho \, d\phi \, d\theta & (b) \quad & 8 \int_0^{\pi/2} \int_0^2 \int_0^{\sqrt{4-r^2}} dz \, r \, dr \, d\theta \\
 (c) \quad & 8 \int_0^2 \int_0^{\sqrt{4-x^2}} \int_0^{\sqrt{4-x^2-y^2}} dz \, dy \, dx
 \end{aligned}$$

$$\begin{aligned}
 40. \quad (a) \quad & \int_0^{\pi/2} \int_0^{3/\sqrt{2}} \int_r^{\sqrt{9-r^2}} dz \, r \, dr \, d\theta & (b) \quad & \int_0^{\pi/2} \int_0^{\pi/4} \int_0^3 \rho^2 \sin\phi \, d\rho \, d\phi \, d\theta \\
 (c) \quad & \int_0^{\pi/2} \int_0^{\pi/4} \int_0^3 \rho^2 \sin\phi \, d\rho \, d\phi \, d\theta = 9 \int_0^{\pi/2} \int_0^{\pi/4} \sin\phi \, d\phi \, d\theta = -9 \int_0^{\pi/2} \left(\frac{1}{\sqrt{2}} - 1 \right) d\theta = \frac{9\pi(2-\sqrt{2})}{4}
 \end{aligned}$$

$$\begin{aligned}
 41. \quad (a) \quad & V = \int_0^{2\pi} \int_0^{\pi/3} \int_{\sec\phi}^2 \rho^2 \sin\phi \, d\rho \, d\phi \, d\theta & (b) \quad & V = \int_0^{2\pi} \int_0^{\sqrt{3}} \int_1^{\sqrt{4-r^2}} dz \, r \, dr \, d\theta \\
 (c) \quad & V = \int_{-\sqrt{3}}^{\sqrt{3}} \int_{-\sqrt{3-x^2}}^{\sqrt{3-x^2}} \int_1^{\sqrt{4-x^2-y^2}} dz \, dy \, dx \\
 (d) \quad & V = \int_0^{2\pi} \int_0^{\sqrt{3}} \left[r(4-r^2)^{1/2} - r \right] dr \, d\theta = \int_0^{2\pi} \left[-\frac{(4-r^2)^{3/2}}{3} - \frac{r^2}{2} \right]_0^{\sqrt{3}} d\theta = \int_0^{2\pi} \left(-\frac{1}{3} - \frac{3}{2} + \frac{4^{3/2}}{3} \right) d\theta \\
 & = \frac{5}{6} \int_0^{2\pi} d\theta = \frac{5\pi}{3}
 \end{aligned}$$

$$\begin{aligned}
 42. \quad (a) \quad & I_z = \int_0^{2\pi} \int_0^1 \int_0^{\sqrt{1-r^2}} r^2 \, dz \, r \, dr \, d\theta \\
 (b) \quad & I_z = \int_0^{2\pi} \int_0^{\pi/2} \int_0^1 (\rho^2 \sin^2\phi) (\rho^2 \sin\phi) \, d\rho \, d\phi \, d\theta, \text{ since } r^2 = x^2 + y^2 = \rho^2 \sin^2\phi \cos^2\theta + \rho^2 \sin^2\phi \sin^2\theta \\
 & = \rho^2 \sin^2\phi \\
 (c) \quad & I_z = \int_0^{2\pi} \int_0^{\pi/2} \frac{1}{5} \sin^3\phi \, d\phi \, d\theta = \frac{1}{5} \int_0^{2\pi} \left(\left[-\frac{\sin^2\phi \cos\phi}{3} \right]_0^{\pi/2} + \frac{2}{3} \int_0^{\pi/2} \sin\phi \, d\phi \right) d\theta = \frac{2}{15} \int_0^{2\pi} [-\cos\phi]_0^{\pi/2} d\theta \\
 & = \frac{2}{15} (2\pi) = \frac{4\pi}{15}
 \end{aligned}$$

$$\begin{aligned}
 43. \quad V &= 4 \int_0^{\pi/2} \int_0^1 \int_{r^4-1}^{4-4r^2} dz \, r \, dr \, d\theta = 4 \int_0^{\pi/2} \int_0^1 (5r - 4r^3 - r^5) \, dr \, d\theta = 4 \int_0^{\pi/2} \left(\frac{5}{2} - 1 - \frac{1}{6} \right) d\theta \\
 &= 4 \int_0^{\pi/2} d\theta = \frac{8\pi}{3}
 \end{aligned}$$

$$\begin{aligned}
 44. \quad V &= 4 \int_0^{\pi/2} \int_0^1 \int_{-\sqrt{1-r^2}}^{1-r} dz \, r \, dr \, d\theta = 4 \int_0^{\pi/2} \int_0^1 \left(r - r^2 + r\sqrt{1-r^2} \right) dr \, d\theta = 4 \int_0^{\pi/2} \left[\frac{r^2}{2} - \frac{r^3}{3} - \frac{1}{3} (1-r^2)^{3/2} \right]_0^1 d\theta \\
 &= 4 \int_0^{\pi/2} \left(\frac{1}{2} - \frac{1}{3} + \frac{1}{3} \right) d\theta = 2 \int_0^{\pi/2} d\theta = 2 \left(\frac{\pi}{2} \right) = \pi
 \end{aligned}$$

$$45. V = \int_{3\pi/2}^{2\pi} \int_0^{3 \cos \theta} \int_0^{-r \sin \theta} dz r dr d\theta = \int_{3\pi/2}^{2\pi} \int_0^{3 \cos \theta} -r^2 \sin \theta dr d\theta = \int_{3\pi/2}^{2\pi} (-9 \cos^3 \theta) (\sin \theta) d\theta$$

$$= \left[\frac{9}{4} \cos^4 \theta \right]_{3\pi/2}^{2\pi} = \frac{9}{4} - 0 = \frac{9}{4}$$

$$46. V = 2 \int_{\pi/2}^{\pi} \int_0^{-3 \cos \theta} \int_0^r dz r dr d\theta = 2 \int_{\pi/2}^{\pi} \int_0^{-3 \cos \theta} r^2 dr d\theta = \frac{2}{3} \int_{\pi/2}^{\pi} -27 \cos^3 \theta d\theta$$

$$= -18 \left(\left[\frac{\cos^2 \theta \sin \theta}{3} \right]_{\pi/2}^{\pi} + \frac{2}{3} \int_{\pi/2}^{\pi} \cos \theta d\theta \right) = -12 [\sin \theta]_{\pi/2}^{\pi} = 12$$

$$47. V = \int_0^{\pi/2} \int_0^{\sin \theta} \int_0^{\sqrt{1-r^2}} dz r dr d\theta = \int_0^{\pi/2} \int_0^{\sin \theta} r \sqrt{1-r^2} dr d\theta = \int_0^{\pi/2} \left[-\frac{1}{3} (1-r^2)^{3/2} \right]_0^{\sin \theta} d\theta$$

$$= -\frac{1}{3} \int_0^{\pi/2} [(1-\sin^2 \theta)^{3/2} - 1] d\theta = -\frac{1}{3} \int_0^{\pi/2} (\cos^3 \theta - 1) d\theta = -\frac{1}{3} \left(\left[\frac{\cos^2 \theta \sin \theta}{3} \right]_0^{\pi/2} + \frac{2}{3} \int_0^{\pi/2} \cos \theta d\theta \right) + \left[\frac{\theta}{3} \right]_0^{\pi/2}$$

$$= -\frac{2}{9} [\sin \theta]_0^{\pi/2} + \frac{\pi}{6} = \frac{-4+3\pi}{18}$$

$$48. V = \int_0^{\pi/2} \int_0^{\cos \theta} \int_0^{3\sqrt{1-r^2}} dz r dr d\theta = \int_0^{\pi/2} \int_0^{\cos \theta} 3r \sqrt{1-r^2} dr d\theta = \int_0^{\pi/2} \left[-(1-r^2)^{3/2} \right]_0^{\cos \theta} d\theta$$

$$= \int_0^{\pi/2} [-(1-\cos^2 \theta)^{3/2} + 1] d\theta = \int_0^{\pi/2} (1-\sin^3 \theta) d\theta = \left[\theta + \frac{\sin^2 \theta \cos \theta}{3} \right]_0^{\pi/2} - \frac{2}{3} \int_0^{\pi/2} \sin \theta d\theta$$

$$= \frac{\pi}{2} + \frac{2}{3} [\cos \theta]_0^{\pi/2} = \frac{\pi}{2} - \frac{2}{3} = \frac{3\pi-4}{6}$$

$$49. V = \int_0^{2\pi} \int_{\pi/3}^{2\pi/3} \int_0^a \rho^2 \sin \phi d\rho d\phi d\theta = \int_0^{2\pi} \int_{\pi/3}^{2\pi/3} \frac{a^3}{3} \sin \phi d\phi d\theta = \frac{a^3}{3} \int_0^{2\pi} [-\cos \phi]_{\pi/3}^{2\pi/3} d\theta = \frac{a^3}{3} \int_0^{2\pi} \left(\frac{1}{2} + \frac{1}{2} \right) d\theta = \frac{2\pi a^3}{3}$$

$$50. V = \int_0^{\pi/6} \int_0^{\pi/2} \int_0^a \rho^2 \sin \phi d\rho d\phi d\theta = \frac{a^3}{3} \int_0^{\pi/6} \int_0^{\pi/2} \sin \phi d\phi d\theta = \frac{a^3}{3} \int_0^{\pi/6} d\theta = \frac{a^3 \pi}{18}$$

$$51. V = \int_0^{2\pi} \int_0^{\pi/3} \int_{\sec \phi}^2 \rho^2 \sin \phi d\rho d\phi d\theta$$

$$= \frac{1}{3} \int_0^{2\pi} \int_0^{\pi/3} (8 \sin \phi - \tan \phi \sec^2 \phi) d\phi d\theta$$

$$= \frac{1}{3} \int_0^{2\pi} \left[-8 \cos \phi - \frac{1}{2} \tan^2 \phi \right]_0^{\pi/3} d\theta$$

$$= \frac{1}{3} \int_0^{2\pi} \left[-4 - \frac{1}{2} (3) + 8 \right] d\theta = \frac{1}{3} \int_0^{2\pi} \frac{5}{2} d\theta = \frac{5}{6} (2\pi) = \frac{5\pi}{3}$$

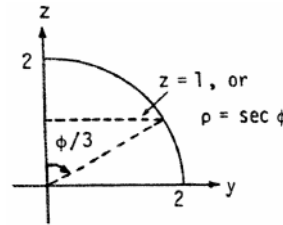

$$52. V = 4 \int_0^{\pi/2} \int_0^{\pi/4} \int_{\sec \phi}^{2 \sec \phi} \rho^2 \sin \phi d\rho d\phi d\theta = \frac{4}{3} \int_0^{\pi/2} \int_0^{\pi/4} (8 \sec^3 \phi - \sec^3 \phi) \sin \phi d\phi d\theta$$

$$= \frac{28}{3} \int_0^{\pi/2} \int_0^{\pi/4} \sec^3 \phi \sin \phi d\phi d\theta = \frac{28}{3} \int_0^{\pi/2} \int_0^{\pi/4} \tan \phi \sec^2 \phi d\phi d\theta = \frac{28}{3} \int_0^{\pi/2} \left[\frac{1}{2} \tan^2 \phi \right]_0^{\pi/4} d\theta$$

$$= \frac{14}{3} \int_0^{\pi/2} d\theta = \frac{7\pi}{3}$$

$$53. V = 4 \int_0^{\pi/2} \int_0^1 \int_0^{r^2} dz r dr d\theta = 4 \int_0^{\pi/2} \int_0^1 r^3 dr d\theta = \int_0^{\pi/2} d\theta = \frac{\pi}{2}$$

$$54. V = 4 \int_0^{\pi/2} \int_0^1 \int_{r^2}^{r^2+1} dz r dr d\theta = 4 \int_0^{\pi/2} \int_0^1 r dr d\theta = 2 \int_0^{\pi/2} d\theta = \pi$$

$$55. V = 8 \int_0^{\pi/2} \int_1^{\sqrt{2}} \int_0^r dz r dr d\theta = 8 \int_0^{\pi/2} \int_1^{\sqrt{2}} r^2 dr d\theta = 8 \left(\frac{2\sqrt{2}-1}{3} \right) \int_0^{\pi/2} d\theta = \frac{4\pi(2\sqrt{2}-1)}{3}$$

$$56. V = 8 \int_0^{\pi/2} \int_1^{\sqrt{2}} \int_0^{\sqrt{2-r^2}} dz r dr d\theta = 8 \int_0^{\pi/2} \int_1^{\sqrt{2}} r \sqrt{2-r^2} dr d\theta = 8 \int_0^{\pi/2} \left[-\frac{1}{3} (2-r^2)^{3/2} \right]_1^{\sqrt{2}} d\theta$$

$$= \frac{8}{3} \int_0^{\pi/2} d\theta = \frac{4\pi}{3}$$

$$57. V = \int_0^{2\pi} \int_0^2 \int_0^{4-r \sin \theta} dz r dr d\theta = \int_0^{2\pi} \int_0^2 (4r - r^2 \sin \theta) dr d\theta = 8 \int_0^{2\pi} \left(1 - \frac{\sin \theta}{3}\right) d\theta = 16\pi$$

$$58. V = \int_0^{2\pi} \int_0^2 \int_0^{4-r \cos \theta - r \sin \theta} dz r dr d\theta = \int_0^{2\pi} \int_0^2 [4r - r^2 (\cos \theta + \sin \theta)] dr d\theta = \frac{8}{3} \int_0^{2\pi} (3 - \cos \theta - \sin \theta) d\theta = 16\pi$$

59. The paraboloids intersect when $4x^2 + 4y^2 = 5 - x^2 - y^2 \Rightarrow x^2 + y^2 = 1$ and $z = 4$
 $\Rightarrow V = 4 \int_0^{\pi/2} \int_0^1 \int_{4r^2}^{5-r^2} dz r dr d\theta = 4 \int_0^{\pi/2} \int_0^1 (5r - 5r^3) dr d\theta = 20 \int_0^{\pi/2} \left[\frac{r^2}{2} - \frac{r^4}{4}\right]_0^1 d\theta = 5 \int_0^{\pi/2} d\theta = \frac{5\pi}{2}$

60. The paraboloid intersects the xy -plane when $9 - x^2 - y^2 = 0 \Rightarrow x^2 + y^2 = 9 \Rightarrow$
 $V = 4 \int_0^{\pi/2} \int_1^3 \int_0^{9-r^2} dz r dr d\theta = 4 \int_0^{\pi/2} \int_1^3 (9r - r^3) dr d\theta = 4 \int_0^{\pi/2} \left[\frac{9r^2}{2} - \frac{r^4}{4}\right]_1^3 d\theta = 4 \int_0^{\pi/2} \left(\frac{81}{4} - \frac{17}{4}\right) d\theta$
 $= 64 \int_0^{\pi/2} d\theta = 32\pi$

61. $V = 8 \int_0^{2\pi} \int_0^1 \int_0^{\sqrt{4-r^2}} dz r dr d\theta = 8 \int_0^{2\pi} \int_0^1 r(4-r^2)^{1/2} dr d\theta = 8 \int_0^{2\pi} \left[-\frac{1}{3}(4-r^2)^{3/2}\right]_0^1 d\theta$
 $= -\frac{8}{3} \int_0^{2\pi} (3^{3/2} - 8) d\theta = \frac{4\pi(8-3\sqrt{3})}{3}$

62. The sphere and paraboloid intersect when $x^2 + y^2 + z^2 = 2$ and $z = x^2 + y^2 \Rightarrow z^2 + z - 2 = 0$
 $\Rightarrow (z+2)(z-1) = 0 \Rightarrow z = 1$ or $z = -2 \Rightarrow z = 1$ since $z \geq 0$. Thus, $x^2 + y^2 = 1$ and the volume is
given by the triple integral $V = 4 \int_0^{\pi/2} \int_0^1 \int_{r^2}^{\sqrt{2-r^2}} dz r dr d\theta = 4 \int_0^{\pi/2} \int_0^1 [r(2-r^2)^{1/2} - r^3] dr d\theta$
 $= 4 \int_0^{\pi/2} \left[-\frac{1}{3}(2-r^2)^{3/2} - \frac{r^4}{4}\right]_0^1 d\theta = 4 \int_0^{\pi/2} \left(\frac{2\sqrt{2}}{3} - \frac{7}{12}\right) d\theta = \frac{\pi(8\sqrt{2}-7)}{6}$

63. average $= \frac{1}{2\pi} \int_0^{2\pi} \int_0^1 \int_{-1}^1 r^2 dz dr d\theta = \frac{1}{2\pi} \int_0^{2\pi} \int_0^1 2r^2 dr d\theta = \frac{1}{3\pi} \int_0^{2\pi} d\theta = \frac{2}{3}$

64. average $= \frac{1}{\left(\frac{4\pi}{3}\right)} \int_0^{2\pi} \int_0^1 \int_{-\sqrt{1-r^2}}^{\sqrt{1-r^2}} r^2 dz dr d\theta = \frac{3}{4\pi} \int_0^{2\pi} \int_0^1 2r^2 \sqrt{1-r^2} dr d\theta$
 $= \frac{3}{2\pi} \int_0^{2\pi} \left[\frac{1}{8} \sin^{-1} r - \frac{1}{8} r \sqrt{1-r^2} (1-2r^2)\right]_0^1 d\theta = \frac{3}{16\pi} \int_0^{2\pi} \left(\frac{\pi}{2} + 0\right) d\theta = \frac{3}{32} \int_0^{2\pi} d\theta = \left(\frac{3}{32}\right) (2\pi) = \frac{3\pi}{16}$

65. average $= \frac{1}{\left(\frac{4\pi}{3}\right)} \int_0^{2\pi} \int_0^{\pi} \int_0^1 \rho^3 \sin \phi d\rho d\phi d\theta = \frac{3}{16\pi} \int_0^{2\pi} \int_0^{\pi} \sin \phi d\phi d\theta = \frac{3}{8\pi} \int_0^{2\pi} d\theta = \frac{3}{4}$

66. average $= \frac{1}{\left(\frac{2\pi}{3}\right)} \int_0^{2\pi} \int_0^{\pi/2} \int_0^1 \rho^3 \cos \phi \sin \phi d\rho d\phi d\theta = \frac{3}{8\pi} \int_0^{2\pi} \int_0^{\pi/2} \cos \phi \sin \phi d\phi d\theta = \frac{3}{8\pi} \int_0^{2\pi} \left[\frac{\sin^2 \phi}{2}\right]_0^{\pi/2} d\theta$
 $= \frac{3}{16\pi} \int_0^{2\pi} d\theta = \left(\frac{3}{16\pi}\right) (2\pi) = \frac{3}{8}$

67. $M = 4 \int_0^{\pi/2} \int_0^1 \int_0^r dz r dr d\theta = 4 \int_0^{\pi/2} \int_0^1 r^2 dr d\theta = \frac{4}{3} \int_0^{\pi/2} d\theta = \frac{2\pi}{3}$; $M_{xy} = \int_0^{2\pi} \int_0^1 \int_0^r z dz r dr d\theta$
 $= \frac{1}{2} \int_0^{2\pi} \int_0^1 r^3 dr d\theta = \frac{1}{8} \int_0^{2\pi} d\theta = \frac{\pi}{4} \Rightarrow \bar{z} = \frac{M_{xy}}{M} = \left(\frac{\pi}{4}\right) \left(\frac{3}{2\pi}\right) = \frac{3}{8}$, and $\bar{x} = \bar{y} = 0$, by symmetry

68. $M = \int_0^{\pi/2} \int_0^2 \int_0^r dz r dr d\theta = \int_0^{\pi/2} \int_0^2 r^2 dr d\theta = \frac{8}{3} \int_0^{\pi/2} d\theta = \frac{4\pi}{3}$; $M_{yz} = \int_0^{\pi/2} \int_0^2 \int_0^r x dz r dr d\theta$
 $= \int_0^{\pi/2} \int_0^2 r^3 \cos \theta dr d\theta = 4 \int_0^{\pi/2} \cos \theta d\theta = 4$; $M_{xz} = \int_0^{\pi/2} \int_0^2 \int_0^r y dz r dr d\theta = \int_0^{\pi/2} \int_0^2 r^3 \sin \theta dr d\theta$
 $= 4 \int_0^{\pi/2} \sin \theta d\theta = 4$; $M_{xy} = \int_0^{\pi/2} \int_0^2 \int_0^r z dz r dr d\theta = \frac{1}{2} \int_0^{\pi/2} \int_0^2 r^3 dr d\theta = 2 \int_0^{\pi/2} d\theta = \pi \Rightarrow \bar{x} = \frac{M_{yz}}{M} = \frac{3}{\pi}$,
 $\bar{y} = \frac{M_{xz}}{M} = \frac{3}{\pi}$, and $\bar{z} = \frac{M_{xy}}{M} = \frac{3}{4}$

$$69. M = \frac{8\pi}{3}; M_{xy} = \int_0^{2\pi} \int_{\pi/3}^{\pi/2} \int_0^2 z\rho^2 \sin \phi \, d\rho \, d\phi \, d\theta = \int_0^{2\pi} \int_{\pi/3}^{\pi/2} \int_0^2 \rho^3 \cos \phi \sin \phi \, d\rho \, d\phi \, d\theta = 4 \int_0^{2\pi} \int_{\pi/3}^{\pi/2} \cos \phi \sin \phi \, d\phi \, d\theta$$

$$= 4 \int_0^{2\pi} \left[\frac{\sin^2 \phi}{2} \right]_{\pi/3}^{\pi/2} d\theta = 4 \int_0^{2\pi} \left(\frac{1}{2} - \frac{3}{8} \right) d\theta = \frac{1}{2} \int_0^{2\pi} d\theta = \pi \Rightarrow \bar{z} = \frac{M_{xy}}{M} = (\pi) \left(\frac{3}{8\pi} \right) = \frac{3}{8}, \text{ and } \bar{x} = \bar{y} = 0,$$

by symmetry

$$70. M = \int_0^{2\pi} \int_0^{\pi/4} \int_0^a \rho^2 \sin \phi \, d\rho \, d\phi \, d\theta = \frac{a^3}{3} \int_0^{2\pi} \int_0^{\pi/4} \sin \phi \, d\phi \, d\theta = \frac{a^3}{3} \int_0^{2\pi} \frac{2-\sqrt{2}}{2} d\theta = \frac{\pi a^3 (2-\sqrt{2})}{3};$$

$$M_{xy} = \int_0^{2\pi} \int_0^{\pi/4} \int_0^a \rho^3 \sin \phi \cos \phi \, d\rho \, d\phi \, d\theta = \frac{a^4}{4} \int_0^{2\pi} \int_0^{\pi/4} \sin \phi \cos \phi \, d\phi \, d\theta = \frac{a^4}{16} \int_0^{2\pi} d\theta = \frac{\pi a^4}{8}$$

$$\Rightarrow \bar{z} = \frac{M_{xy}}{M} = \left(\frac{\pi a^4}{8} \right) \left[\frac{3}{\pi a^3 (2-\sqrt{2})} \right] = \left(\frac{3a}{8} \right) \left(\frac{2+\sqrt{2}}{2} \right) = \frac{3(2+\sqrt{2})a}{16}, \text{ and } \bar{x} = \bar{y} = 0, \text{ by symmetry}$$

$$71. M = \int_0^{2\pi} \int_0^4 \int_0^{\sqrt{r}} dz \, r \, dr \, d\theta = \int_0^{2\pi} \int_0^4 r^{3/2} \, dr \, d\theta = \frac{64}{5} \int_0^{2\pi} d\theta = \frac{128\pi}{5}; M_{xy} = \int_0^{2\pi} \int_0^4 \int_0^{\sqrt{r}} z \, dz \, r \, dr \, d\theta$$

$$= \frac{1}{2} \int_0^{2\pi} \int_0^4 r^2 \, dr \, d\theta = \frac{32}{3} \int_0^{2\pi} d\theta = \frac{64\pi}{3} \Rightarrow \bar{z} = \frac{M_{xy}}{M} = \frac{5}{6}, \text{ and } \bar{x} = \bar{y} = 0, \text{ by symmetry}$$

$$72. M = \int_{-\pi/3}^{\pi/3} \int_0^1 \int_{-\sqrt{1-r^2}}^{\sqrt{1-r^2}} dz \, r \, dr \, d\theta = \int_{-\pi/3}^{\pi/3} \int_0^1 2r\sqrt{1-r^2} \, dr \, d\theta = \int_{-\pi/3}^{\pi/3} \left[-\frac{2}{3} (1-r^2)^{3/2} \right]_0^1 d\theta$$

$$= \frac{2}{3} \int_{-\pi/3}^{\pi/3} d\theta = \left(\frac{2}{3} \right) \left(\frac{2\pi}{3} \right) = \frac{4\pi}{9}; M_{yz} = \int_{-\pi/3}^{\pi/3} \int_0^1 \int_{-\sqrt{1-r^2}}^{\sqrt{1-r^2}} r^2 \cos \theta \, dz \, dr \, d\theta = 2 \int_{-\pi/3}^{\pi/3} \int_0^1 r^2 \sqrt{1-r^2} \cos \theta \, dr \, d\theta$$

$$= 2 \int_{-\pi/3}^{\pi/3} \left[\frac{1}{8} \sin^{-1} r - \frac{1}{8} r \sqrt{1-r^2} (1-2r^2) \right]_0^1 \cos \theta \, d\theta = \frac{\pi}{8} \int_{-\pi/3}^{\pi/3} \cos \theta \, d\theta = \frac{\pi}{8} [\sin \theta]_{-\pi/3}^{\pi/3} = \left(\frac{\pi}{8} \right) \left(2 \cdot \frac{\sqrt{3}}{2} \right) = \frac{\pi\sqrt{3}}{8}$$

$$\Rightarrow \bar{x} = \frac{M_{yz}}{M} = \frac{9\sqrt{3}}{32}, \text{ and } \bar{y} = \bar{z} = 0, \text{ by symmetry}$$

$$73. I_z = \int_0^{2\pi} \int_1^2 \int_0^4 (x^2 + y^2) \, dz \, r \, dr \, d\theta = 4 \int_0^{2\pi} \int_1^2 r^3 \, dr \, d\theta = \int_0^{2\pi} 15 \, d\theta = 30\pi; M = \int_0^{2\pi} \int_1^2 \int_0^4 dz \, r \, dr \, d\theta$$

$$= \int_0^{2\pi} \int_1^2 4r \, dr \, d\theta = \int_0^{2\pi} 6 \, d\theta = 12\pi \Rightarrow R_z = \sqrt{\frac{I_z}{M}} = \sqrt{\frac{5}{2}}$$

$$74. (a) I_z = \int_0^{2\pi} \int_0^1 \int_{-1}^1 r^3 \, dz \, dr \, d\theta = 2 \int_0^{2\pi} \int_0^1 r^3 \, dr \, d\theta = \frac{1}{2} \int_0^{2\pi} d\theta = \pi$$

$$(b) I_x = \int_0^{2\pi} \int_0^1 \int_{-1}^1 (r^2 \sin^2 \theta + z^2) \, dz \, r \, dr \, d\theta = 2 \int_0^{2\pi} \int_0^1 \left(2r^3 \sin^2 \theta + \frac{2r}{3} \right) dr \, d\theta = \int_0^{2\pi} \left(\frac{\sin^2 \theta}{2} + \frac{1}{3} \right) d\theta$$

$$= \left[\frac{\theta}{4} - \frac{\sin 2\theta}{8} + \frac{\theta}{3} \right]_0^{2\pi} = \frac{\pi}{2} + \frac{2\pi}{3} = \frac{7\pi}{6}$$

75. We orient the cone with its vertex at the origin and axis along the z-axis $\Rightarrow \phi = \frac{\pi}{4}$. We use the the x-axis which is through the vertex and parallel to the base of the cone $\Rightarrow I_x = \int_0^{2\pi} \int_0^1 \int_r^1 (r^2 \sin^2 \theta + z^2) \, dz \, r \, dr \, d\theta$

$$= \int_0^{2\pi} \int_0^1 \left(r^3 \sin^2 \theta - r^4 \sin^2 \theta + \frac{r}{3} - \frac{r^4}{3} \right) dr \, d\theta = \int_0^{2\pi} \left(\frac{\sin^2 \theta}{20} + \frac{1}{10} \right) d\theta = \left[\frac{\theta}{40} - \frac{\sin 2\theta}{80} + \frac{\theta}{10} \right]_0^{2\pi} = \frac{\pi}{20} + \frac{\pi}{5} = \frac{\pi}{4}$$

$$76. I_z = \int_0^{2\pi} \int_0^a \int_{-\sqrt{a^2-r^2}}^{\sqrt{a^2-r^2}} r^3 \, dz \, dr \, d\theta = \int_0^{2\pi} \int_0^a 2r^3 \sqrt{a^2-r^2} \, dr \, d\theta = 2 \int_0^{2\pi} \left[\left(-\frac{r^2}{5} - \frac{2a^2}{15} \right) (a^2-r^2)^{3/2} \right]_0^a d\theta$$

$$= 2 \int_0^{2\pi} \frac{2}{15} a^5 \, d\theta = \frac{8\pi a^5}{15}$$

$$77. I_z = \int_0^{2\pi} \int_0^a \int_{\frac{h}{a}r}^h (x^2 + y^2) \, dz \, r \, dr \, d\theta = \int_0^{2\pi} \int_0^a \int_{\frac{h}{a}r}^h r^3 \, dz \, dr \, d\theta = \int_0^{2\pi} \int_0^a \left(hr^3 - \frac{hr^4}{a} \right) dr \, d\theta$$

$$= \int_0^{2\pi} h \left[\frac{r^4}{4} - \frac{r^5}{5a} \right]_0^a d\theta = \int_0^{2\pi} h \left(\frac{a^4}{4} - \frac{a^5}{5a} \right) d\theta = \frac{ha^4}{20} \int_0^{2\pi} d\theta = \frac{\pi ha^4}{10}$$

78. (a) $M = \int_0^{2\pi} \int_0^1 \int_0^{r^2} z \, dz \, r \, dr \, d\theta = \int_0^{2\pi} \int_0^1 \frac{1}{2} r^5 \, dr \, d\theta = \frac{1}{12} \int_0^{2\pi} d\theta = \frac{\pi}{6}$; $M_{xy} = \int_0^{2\pi} \int_0^1 \int_0^{r^2} z^2 \, dz \, r \, dr \, d\theta$
 $= \frac{1}{3} \int_0^{2\pi} \int_0^1 r^7 \, dr \, d\theta = \frac{1}{24} \int_0^{2\pi} d\theta = \frac{\pi}{12} \Rightarrow \bar{z} = \frac{1}{2}$, and $\bar{x} = \bar{y} = 0$, by symmetry;
 $I_z = \int_0^{2\pi} \int_0^1 \int_0^{r^2} zr^3 \, dz \, r \, dr \, d\theta = \frac{1}{2} \int_0^{2\pi} \int_0^1 r^7 \, dr \, d\theta = \frac{1}{16} \int_0^{2\pi} d\theta = \frac{\pi}{8} \Rightarrow R_z = \sqrt{\frac{I_z}{M}} = \frac{\sqrt{3}}{2}$
- (b) $M = \int_0^{2\pi} \int_0^1 \int_0^{r^2} r^2 \, dz \, r \, dr \, d\theta = \int_0^{2\pi} \int_0^1 r^4 \, dr \, d\theta = \frac{1}{5} \int_0^{2\pi} d\theta = \frac{2\pi}{5}$; $M_{xy} = \int_0^{2\pi} \int_0^1 \int_0^{r^2} zr^2 \, dz \, r \, dr \, d\theta$
 $= \frac{1}{2} \int_0^{2\pi} \int_0^1 r^6 \, dr \, d\theta = \frac{1}{14} \int_0^{2\pi} d\theta = \frac{\pi}{7} \Rightarrow \bar{z} = \frac{5}{14}$, and $\bar{x} = \bar{y} = 0$, by symmetry; $I_z = \int_0^{2\pi} \int_0^1 \int_0^{r^2} r^4 \, dz \, r \, dr \, d\theta$
 $= \int_0^{2\pi} \int_0^1 r^6 \, dr \, d\theta = \frac{1}{7} \int_0^{2\pi} d\theta = \frac{2\pi}{7} \Rightarrow R_z = \sqrt{\frac{I_z}{M}} = \sqrt{\frac{5}{7}}$
79. (a) $M = \int_0^{2\pi} \int_0^1 \int_r^1 z \, dz \, r \, dr \, d\theta = \frac{1}{2} \int_0^{2\pi} \int_0^1 (r - r^3) \, dr \, d\theta = \frac{1}{8} \int_0^{2\pi} d\theta = \frac{\pi}{4}$; $M_{xy} = \int_0^{2\pi} \int_0^1 \int_r^1 z^2 \, dz \, r \, dr \, d\theta$
 $= \frac{1}{3} \int_0^{2\pi} \int_0^1 (r - r^4) \, dr \, d\theta = \frac{1}{10} \int_0^{2\pi} d\theta = \frac{\pi}{5} \Rightarrow \bar{z} = \frac{4}{5}$, and $\bar{x} = \bar{y} = 0$, by symmetry; $I_z = \int_0^{2\pi} \int_0^1 \int_r^1 zr^3 \, dz \, r \, dr \, d\theta$
 $= \frac{1}{2} \int_0^{2\pi} \int_0^1 (r^3 - r^5) \, dr \, d\theta = \frac{1}{24} \int_0^{2\pi} d\theta = \frac{\pi}{12} \Rightarrow R_z = \sqrt{\frac{I_z}{M}} = \sqrt{\frac{1}{3}}$
- (b) $M = \int_0^{2\pi} \int_0^1 \int_r^1 z^2 \, dz \, r \, dr \, d\theta = \frac{\pi}{5}$ from part (a); $M_{xy} = \int_0^{2\pi} \int_0^1 \int_r^1 z^3 \, dz \, r \, dr \, d\theta = \frac{1}{4} \int_0^{2\pi} \int_0^1 (r - r^5) \, dr \, d\theta$
 $= \frac{1}{12} \int_0^{2\pi} d\theta = \frac{\pi}{6} \Rightarrow \bar{z} = \frac{5}{6}$, and $\bar{x} = \bar{y} = 0$, by symmetry; $I_z = \int_0^{2\pi} \int_0^1 \int_r^1 z^2 r^3 \, dz \, r \, dr \, d\theta = \frac{1}{3} \int_0^{2\pi} \int_0^1 (r^3 - r^6) \, dr \, d\theta$
 $= \frac{1}{28} \int_0^{2\pi} d\theta = \frac{\pi}{14} \Rightarrow R_z = \sqrt{\frac{I_z}{M}} = \sqrt{\frac{5}{14}}$
80. (a) $M = \int_0^{2\pi} \int_0^\pi \int_0^a \rho^4 \sin \phi \, d\rho \, d\phi \, d\theta = \frac{a^5}{5} \int_0^{2\pi} \int_0^\pi \sin \phi \, d\phi \, d\theta = \frac{2a^5}{5} \int_0^{2\pi} d\theta = \frac{4\pi a^5}{5}$;
 $I_z = \int_0^{2\pi} \int_0^\pi \int_0^a \rho^6 \sin^3 \phi \, d\rho \, d\phi \, d\theta = \frac{a^7}{7} \int_0^{2\pi} \int_0^\pi (1 - \cos^2 \phi) \sin \phi \, d\phi \, d\theta = \frac{a^7}{7} \int_0^{2\pi} \left[-\cos \phi + \frac{\cos^3 \phi}{3} \right]_0^\pi d\theta$
 $= \frac{4a^7}{21} \int_0^{2\pi} d\theta = \frac{8a^7\pi}{21} \Rightarrow R_z = \sqrt{\frac{I_z}{M}} = \sqrt{\frac{10}{21}} a$
- (b) $M = \int_0^{2\pi} \int_0^\pi \int_0^a \rho^3 \sin^2 \phi \, d\rho \, d\phi \, d\theta = \frac{a^4}{4} \int_0^{2\pi} \int_0^\pi \frac{(1 - \cos 2\phi)}{2} \, d\phi \, d\theta = \frac{\pi a^4}{8} \int_0^{2\pi} d\theta = \frac{\pi^2 a^4}{4}$;
 $I_z = \int_0^{2\pi} \int_0^\pi \int_0^a \rho^5 \sin^4 \phi \, d\rho \, d\phi \, d\theta = \frac{a^6}{6} \int_0^{2\pi} \int_0^\pi \sin^4 \phi \, d\phi \, d\theta$
 $= \frac{a^6}{6} \int_0^{2\pi} \left(\left[\frac{-\sin^3 \phi \cos \phi}{4} \right]_0^\pi + \frac{3}{4} \int_0^\pi \sin^2 \phi \, d\phi \right) d\theta = \frac{a^6}{8} \int_0^{2\pi} \left[\frac{\phi}{2} - \frac{\sin 2\phi}{4} \right]_0^\pi d\theta = \frac{\pi a^6}{16} \int_0^{2\pi} d\theta$
 $= \frac{a^6 \pi^2}{8} \Rightarrow R_z = \sqrt{\frac{I_z}{M}} = \frac{a}{\sqrt{2}}$
81. $M = \int_0^{2\pi} \int_0^a \int_0^{\sqrt{a^2 - r^2}} dz \, r \, dr \, d\theta = \int_0^{2\pi} \int_0^a \frac{h}{a} r \sqrt{a^2 - r^2} \, dr \, d\theta = \frac{h}{a} \int_0^{2\pi} \left[-\frac{1}{3} (a^2 - r^2)^{3/2} \right]_0^a d\theta$
 $= \frac{h}{a} \int_0^{2\pi} \frac{a^3}{3} \, d\theta = \frac{2ha^2\pi}{3}$; $M_{xy} = \int_0^{2\pi} \int_0^a \int_0^{\sqrt{a^2 - r^2}} z \, dz \, r \, dr \, d\theta = \frac{h^2}{2a^2} \int_0^{2\pi} \int_0^a (a^2 r - r^3) \, dr \, d\theta$
 $= \frac{h^2}{2a^2} \int_0^{2\pi} \left(\frac{a^4}{2} - \frac{a^4}{4} \right) d\theta = \frac{a^2 h^2 \pi}{4} \Rightarrow \bar{z} = \left(\frac{\pi a^2 h^2}{4} \right) \left(\frac{3}{2ha^2\pi} \right) = \frac{3}{8} h$, and $\bar{x} = \bar{y} = 0$, by symmetry
82. Let the base radius of the cone be a and the height h , and place the cone's axis of symmetry along the z -axis with the vertex at the origin. Then $M = \frac{\pi a^2 h}{3}$ and $M_{xy} = \int_0^{2\pi} \int_0^a \int_{\frac{h}{a}r}^h z \, dz \, r \, dr \, d\theta = \frac{1}{2} \int_0^{2\pi} \int_0^a \left(h^2 r - \frac{h^2}{a^2} r^3 \right) \, dr \, d\theta$
 $= \frac{h^2}{2} \int_0^{2\pi} \left[\frac{r^2}{2} - \frac{r^4}{4a^2} \right]_0^a d\theta = \frac{h^2}{2} \int_0^{2\pi} \left(\frac{a^2}{2} - \frac{a^2}{4} \right) d\theta = \frac{h^2 a^2}{8} \int_0^{2\pi} d\theta = \frac{h^2 a^2 \pi}{4} \Rightarrow \bar{z} = \frac{M_{xy}}{M} = \left(\frac{h^2 a^2 \pi}{4} \right) \left(\frac{3}{\pi a^2 h} \right) = \frac{3}{4} h$, and $\bar{x} = \bar{y} = 0$, by symmetry \Rightarrow the centroid is one fourth of the way from the base to the vertex
83. $M = \int_0^{2\pi} \int_0^a \int_0^h (z + 1) \, dz \, r \, dr \, d\theta = \int_0^{2\pi} \int_0^a \left(\frac{h^2}{2} + h \right) r \, dr \, d\theta = \frac{a^2 (h^2 + 2h)}{4} \int_0^{2\pi} d\theta = \frac{\pi a^2 (h^2 + 2h)}{2}$;
 $M_{xy} = \int_0^{2\pi} \int_0^a \int_0^h (z^2 + z) \, dz \, r \, dr \, d\theta = \int_0^{2\pi} \int_0^a \left(\frac{h^3}{3} + \frac{h^2}{2} \right) r \, dr \, d\theta = \frac{a^2 (2h^3 + 3h^2)}{12} \int_0^{2\pi} d\theta = \frac{\pi a^2 (2h^3 + 3h^2)}{6}$
 $\Rightarrow \bar{z} = \left[\frac{\pi a^2 (2h^3 + 3h^2)}{6} \right] \left[\frac{2}{\pi a^2 (h^2 + 2h)} \right] = \frac{2h^2 + 3h}{3h + 6}$, and $\bar{x} = \bar{y} = 0$, by symmetry;

$$I_z = \int_0^{2\pi} \int_0^a \int_0^h (z+1)r^3 dz dr d\theta = \left(\frac{h^2+2h}{2}\right) \int_0^{2\pi} \int_0^a r^3 dr d\theta = \left(\frac{h^2+2h}{2}\right) \left(\frac{a^4}{4}\right) \int_0^{2\pi} d\theta = \frac{\pi a^4 (h^2+2h)}{4};$$

$$R_z = \sqrt{\frac{I_z}{M}} = \sqrt{\frac{\pi a^4 (h^2+2h)}{4} \cdot \frac{2}{\pi a^2 (h^2+2h)}} = \frac{a}{\sqrt{2}}$$

84. The mass of the planet's atmosphere to an altitude h above the surface of the planet is the triple integral

$$M(h) = \int_0^{2\pi} \int_0^\pi \int_R^h \mu_0 e^{-c(\rho-R)} \rho^2 \sin \phi d\rho d\phi d\theta = \int_R^h \int_0^{2\pi} \int_0^\pi \mu_0 e^{-c(\rho-R)} \rho^2 \sin \phi d\phi d\theta d\rho$$

$$= \int_R^h \int_0^{2\pi} [\mu_0 e^{-c(\rho-R)} \rho^2 (-\cos \phi)]_0^\pi d\theta d\rho = 2 \int_R^h \int_0^{2\pi} \mu_0 e^{cR} e^{-c\rho} \rho^2 d\theta d\rho = 4\pi \mu_0 e^{cR} \int_R^h e^{-c\rho} \rho^2 d\rho$$

$$= 4\pi \mu_0 e^{cR} \left[-\frac{\rho^2 e^{-c\rho}}{c} - \frac{2\rho e^{-c\rho}}{c^2} - \frac{2e^{-c\rho}}{c^3} \right]_R^h \quad (\text{by parts})$$

$$= 4\pi \mu_0 e^{cR} \left(-\frac{h^2 e^{-ch}}{c} - \frac{2he^{-ch}}{c^2} - \frac{2e^{-ch}}{c^3} + \frac{R^2 e^{-cR}}{c} + \frac{2Re^{-cR}}{c^2} + \frac{2e^{-cR}}{c^3} \right).$$

The mass of the planet's atmosphere is therefore $M = \lim_{h \rightarrow \infty} M(h) = 4\pi \mu_0 \left(\frac{R^2}{c} + \frac{2R}{c^2} + \frac{2}{c^3} \right)$.

85. The density distribution function is linear so it has the form $\delta(\rho) = k\rho + C$, where ρ is the distance from the center of the planet. Now, $\delta(R) = 0 \Rightarrow kR + C = 0$, and $\delta(\rho) = k\rho - kR$. It remains to determine the constant

$$k: M = \int_0^{2\pi} \int_0^\pi \int_0^R (k\rho - kR) \rho^2 \sin \phi d\rho d\phi d\theta = \int_0^{2\pi} \int_0^\pi \left[k \frac{\rho^4}{4} - kR \frac{\rho^3}{3} \right]_0^R \sin \phi d\phi d\theta$$

$$= \int_0^{2\pi} \int_0^\pi k \left(\frac{R^4}{4} - \frac{R^4}{3} \right) \sin \phi d\phi d\theta = \int_0^{2\pi} -\frac{k}{12} R^4 [-\cos \phi]_0^\pi d\theta = \int_0^{2\pi} -\frac{k}{6} R^4 d\theta = -\frac{k\pi R^4}{3} \Rightarrow k = -\frac{3M}{\pi R^4}$$

$$\Rightarrow \delta(\rho) = -\frac{3M}{\pi R^4} \rho + \frac{3M}{\pi R^4} R. \text{ At the center of the planet } \rho = 0 \Rightarrow \delta(0) = \left(\frac{3M}{\pi R^4}\right) R = \frac{3M}{\pi R^3}.$$

86. $x^2 + y^2 = a^2 \Rightarrow (\rho \sin \phi \cos \theta)^2 + (\rho \sin \phi \sin \theta)^2 = a^2 \Rightarrow (\rho^2 \sin^2 \phi)(\cos^2 \theta + \sin^2 \theta) = a^2 \Rightarrow \rho^2 \sin^2 \phi = a^2$
 $\Rightarrow \rho \sin \phi = a \text{ or } \rho \sin \phi = -a \Rightarrow \rho \sin \phi = a \text{ or } \rho = a \csc \phi, \text{ since } 0 \leq \phi \leq \pi \text{ and } \rho \geq 0.$

87. (a) A plane perpendicular to the x -axis has the form $x = a$ in rectangular coordinates $\Rightarrow r \cos \theta = a \Rightarrow r = \frac{a}{\cos \theta}$
 $\Rightarrow r = a \sec \theta$, in cylindrical coordinates.

(b) A plane perpendicular to the y -axis has the form $y = b$ in rectangular coordinates $\Rightarrow r \sin \theta = b \Rightarrow r = \frac{b}{\sin \theta}$
 $\Rightarrow r = b \csc \theta$, in cylindrical coordinates.

88. $ax + by = c \Rightarrow a(r \cos \theta) + b(r \sin \theta) = c \Rightarrow r(a \cos \theta + b \sin \theta) = c \Rightarrow r = \frac{c}{a \cos \theta + b \sin \theta}$.

89. The equation $r = f(z)$ implies that the point (r, θ, z)
 $= (f(z), \theta, z)$ will lie on the surface for all θ . In particular
 $(f(z), \theta + \pi, z)$ lies on the surface whenever $(f(z), \theta, z)$ does
 \Rightarrow the surface is symmetric with respect to the z -axis.

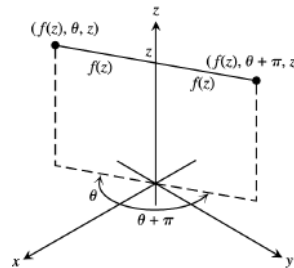

90. The equation $\rho = f(\phi)$ implies that the point $(\rho, \phi, \theta) = (f(\phi), \phi, \theta)$ lies on the surface for all θ . In particular, if
 $(f(\phi), \phi, \theta)$ lies on the surface, then $(f(\phi), \phi, \theta + \pi)$ lies on the surface, so the surface is symmetric with respect to the z -axis.

15.7 SUBSTITUTIONS IN MULTIPLE INTEGRALS

1. (a) $x - y = u$ and $2x + y = v \Rightarrow 3x = u + v$ and $y = x - u \Rightarrow x = \frac{1}{3}(u + v)$ and $y = \frac{1}{3}(-2u + v)$;

$$\frac{\partial(x,y)}{\partial(u,v)} = \begin{vmatrix} \frac{1}{3} & \frac{1}{3} \\ -\frac{2}{3} & \frac{1}{3} \end{vmatrix} = \frac{1}{9} + \frac{2}{9} = \frac{1}{3}$$

- (b) The line segment $y = x$ from $(0, 0)$ to $(1, 1)$ is $x - y = 0 \Rightarrow u = 0$; the line segment $y = -2x$ from $(0, 0)$ to $(1, -2)$ is $2x + y = 0 \Rightarrow v = 0$; the line segment $x = 1$ from $(1, 1)$ to $(1, -2)$ is $(x - y) + (2x + y) = 3 \Rightarrow u + v = 3$. The transformed region is sketched at the right.

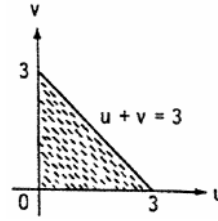

2. (a) $x + 2y = u$ and $x - y = v \Rightarrow 3y = u - v$ and $x = v + y \Rightarrow y = \frac{1}{3}(u - v)$ and $x = \frac{1}{3}(u + 2v)$;

$$\frac{\partial(x,y)}{\partial(u,v)} = \begin{vmatrix} \frac{1}{3} & \frac{2}{3} \\ \frac{1}{3} & -\frac{1}{3} \end{vmatrix} = -\frac{1}{9} - \frac{2}{9} = -\frac{1}{3}$$

- (b) The triangular region in the xy -plane has vertices $(0, 0)$, $(2, 0)$, and $(\frac{2}{3}, \frac{2}{3})$. The line segment $y = x$ from $(0, 0)$ to $(\frac{2}{3}, \frac{2}{3})$ is $x - y = 0 \Rightarrow v = 0$; the line segment $y = 0$ from $(0, 0)$ to $(2, 0) \Rightarrow u = v$; the line segment $x + 2y = 2$ from $(\frac{2}{3}, \frac{2}{3})$ to $(2, 0) \Rightarrow u = 2$. The transformed region is sketched at the right.

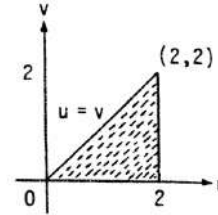

3. (a) $3x + 2y = u$ and $x + 4y = v \Rightarrow -5x = -2u + v$ and $y = \frac{1}{2}(u - 3x) \Rightarrow x = \frac{1}{5}(2u - v)$ and $y = \frac{1}{10}(3v - u)$;

$$\frac{\partial(x,y)}{\partial(u,v)} = \begin{vmatrix} \frac{2}{5} & -\frac{1}{5} \\ -\frac{1}{10} & \frac{3}{10} \end{vmatrix} = \frac{6}{50} - \frac{1}{50} = \frac{1}{10}$$

- (b) The x -axis $y = 0 \Rightarrow u = 3v$; the y -axis $x = 0 \Rightarrow v = 2u$; the line $x + y = 1 \Rightarrow \frac{1}{5}(2u - v) + \frac{1}{10}(3v - u) = 1 \Rightarrow 2(2u - v) + (3v - u) = 10 \Rightarrow 3u + v = 10$. The transformed region is sketched at the right.

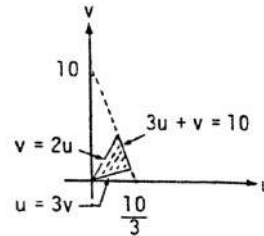

4. (a) $2x - 3y = u$ and $-x + y = v \Rightarrow -x = u + 3v$ and $y = v + x \Rightarrow x = -u - 3v$ and $y = -u - 2v$;

$$\frac{\partial(x,y)}{\partial(u,v)} = \begin{vmatrix} -1 & -3 \\ -1 & -2 \end{vmatrix} = 2 - 3 = -1$$

- (b) The line $x = -3 \Rightarrow -u - 3v = -3$ or $u + 3v = 3$; $x = 0 \Rightarrow u + 3v = 0$; $y = x \Rightarrow v = 0$; $y = x + 1 \Rightarrow v = 1$. The transformed region is the parallelogram sketched at the right.

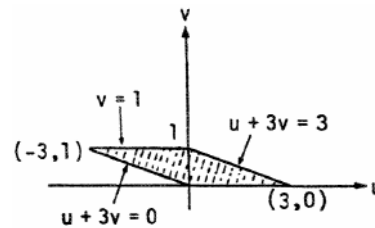

$$\begin{aligned} 5. \int_0^4 \int_{y/2}^{(y/2)+1} (x - \frac{y}{2}) dx dy &= \int_0^4 \left[\frac{x^2}{2} - \frac{xy}{2} \right]_{\frac{y}{2}}^{\frac{y}{2}+1} dy = \frac{1}{2} \int_0^4 \left[(\frac{y}{2} + 1)^2 - (\frac{y}{2})^2 - (\frac{y}{2} + 1)y + (\frac{y}{2})y \right] dy \\ &= \frac{1}{2} \int_0^4 (y + 1 - y) dy = \frac{1}{2} \int_0^4 dy = \frac{1}{2} (4) = 2 \end{aligned}$$

$$6. \iint_R (2x^2 - xy - y^2) dx dy = \iint_R (x - y)(2x + y) dx dy$$

$$= \iint_G uv \left| \frac{\partial(x,y)}{\partial(u,v)} \right| du dv = \frac{1}{3} \iint_G uv du dv;$$

We find the boundaries of G from the boundaries of R, shown in the accompanying figure:

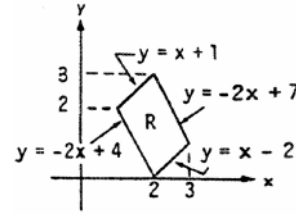

xy-equations for the boundary of R	Corresponding uv-equations for the boundary of G	Simplified uv-equations
$y = -2x + 4$	$\frac{1}{3}(-2u + v) = -\frac{2}{3}(u + v) + 4$	$v = 4$
$y = -2x + 7$	$\frac{1}{3}(-2u + v) = -\frac{2}{3}(u + v) + 7$	$v = 7$
$y = x - 2$	$\frac{1}{3}(-2u + v) = \frac{1}{3}(u + v) - 2$	$u = 2$
$y = x + 1$	$\frac{1}{3}(-2u + v) = \frac{1}{3}(u + v) + 1$	$u = -1$

$$\Rightarrow \frac{1}{3} \iint_G uv du dv = \frac{1}{3} \int_{-1}^2 \int_4^7 uv dv du = \frac{1}{3} \int_{-1}^2 u \left[\frac{v^2}{2} \right]_4^7 du = \frac{11}{2} \int_{-1}^2 u du = \left(\frac{11}{2} \right) \left[\frac{u^2}{2} \right]_{-1}^2 = \left(\frac{11}{4} \right) (4 - 1) = \frac{33}{4}$$

$$7. \iint_R (3x^2 + 14xy + 8y^2) dx dy$$

$$= \iint_R (3x + 2y)(x + 4y) dx dy$$

$$= \iint_G uv \left| \frac{\partial(x,y)}{\partial(u,v)} \right| du dv = \frac{1}{10} \iint_G uv du dv;$$

We find the boundaries of G from the boundaries of R, shown in the accompanying figure:

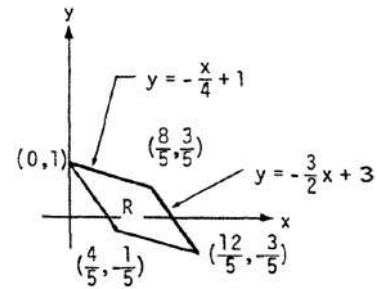

xy-equations for the boundary of R	Corresponding uv-equations for the boundary of G	Simplified uv-equations
$y = -\frac{3}{2}x + 1$	$\frac{1}{10}(3v - u) = -\frac{3}{10}(2u - v) + 1$	$u = 2$
$y = -\frac{3}{2}x + 3$	$\frac{1}{10}(3v - u) = -\frac{3}{10}(2u - v) + 3$	$u = 6$
$y = -\frac{1}{4}x$	$\frac{1}{10}(3v - u) = -\frac{1}{20}(2u - v)$	$v = 0$
$y = -\frac{1}{4}x + 1$	$\frac{1}{10}(3v - u) = -\frac{1}{20}(2u - v) + 1$	$v = 4$

$$\Rightarrow \frac{1}{10} \iint_G uv du dv = \frac{1}{10} \int_2^6 \int_0^4 uv dv du = \frac{1}{10} \int_2^6 u \left[\frac{v^2}{2} \right]_0^4 du = \frac{4}{5} \int_2^6 u du = \left(\frac{4}{5} \right) \left[\frac{u^2}{2} \right]_2^6 = \left(\frac{4}{5} \right) (18 - 2) = \frac{64}{5}$$

$$8. \iint_R 2(x - y) dx dy = \iint_G -2v \left| \frac{\partial(x,y)}{\partial(u,v)} \right| du dv = \iint_G -2v du dv;$$

the region G is sketched in Exercise 4

$$\Rightarrow \iint_G -2v du dv = \int_0^1 \int_{-3v}^{3-3v} -2v du dv = \int_0^1 -2v(3 - 3v + 3v) dv = \int_0^1 -6v dv = [-3v^2]_0^1 = -3$$

$$9. x = \frac{u}{v} \text{ and } y = uv \Rightarrow \frac{y}{x} = v^2 \text{ and } xy = u^2; \frac{\partial(x,y)}{\partial(u,v)} = \mathbf{J}(u,v) = \begin{vmatrix} v^{-1} & -uv^{-2} \\ v & u \end{vmatrix} = v^{-1}u + v^{-1}u = \frac{2u}{v};$$

$y = x \Rightarrow uv = \frac{u}{v} \Rightarrow v = 1$, and $y = 4x \Rightarrow v = 2$; $xy = 1 \Rightarrow u = 1$, and $xy = 9 \Rightarrow u = 3$; thus

$$\iint_R \left(\sqrt{\frac{y}{x}} + \sqrt{xy} \right) dx dy = \int_1^3 \int_1^2 (v + u) \left(\frac{2u}{v} \right) dv du = \int_1^3 \int_1^2 \left(2u + \frac{2u^2}{v} \right) dv du = \int_1^3 [2uv + 2u^2 \ln v]_1^2 du$$

$$= \int_1^3 (2u + 2u^2 \ln 2) du = [u^2 + \frac{2}{3}u^2 \ln 2]_1^3 = 8 + \frac{2}{3}(26)(\ln 2) = 8 + \frac{52}{3}(\ln 2)$$

10. (a) $\frac{\partial(x,y)}{\partial(u,v)} = J(u,v) = \begin{vmatrix} 1 & 0 \\ v & u \end{vmatrix} = u$, and
the region G is sketched at the right

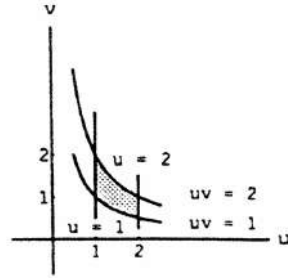

(b) $x = 1 \Rightarrow u = 1$, and $x = 2 \Rightarrow u = 2$; $y = 1 \Rightarrow uv = 1 \Rightarrow v = \frac{1}{u}$, and $y = 2 \Rightarrow uv = 2 \Rightarrow v = \frac{2}{u}$; thus,

$$\int_1^2 \int_1^2 \frac{y}{x} dy dx = \int_1^2 \int_{1/u}^{2/u} \left(\frac{uv}{u}\right) u dv du = \int_1^2 \int_{1/u}^{2/u} uv dv du = \int_1^2 u \left[\frac{v^2}{2}\right]_{1/u}^{2/u} du = \int_1^2 u \left(\frac{2}{u^2} - \frac{1}{2u^2}\right) du$$

$$= \frac{3}{2} \int_1^2 u \left(\frac{1}{u^2}\right) du = \frac{3}{2} [\ln u]_1^2 = \frac{3}{2} \ln 2; \int_1^2 \int_1^2 \frac{y}{x} dy dx = \int_1^2 \left[\frac{1}{x} \cdot \frac{y^2}{2}\right]_1^2 dx = \frac{3}{2} \int_1^2 \frac{dx}{x} = \frac{3}{2} [\ln x]_1^2 = \frac{3}{2} \ln 2$$

11. $x = ar \cos \theta$ and $y = ar \sin \theta \Rightarrow \frac{\partial(x,y)}{\partial(r,\theta)} = J(r,\theta) = \begin{vmatrix} a \cos \theta & -ar \sin \theta \\ b \sin \theta & br \cos \theta \end{vmatrix} = abr \cos^2 \theta + abr \sin^2 \theta = abr$;

$$I_0 = \iint_R (x^2 + y^2) dA = \int_0^{2\pi} \int_0^1 r^2 (a^2 \cos^2 \theta + b^2 \sin^2 \theta) |J(r,\theta)| dr d\theta = \int_0^{2\pi} \int_0^1 abr^3 (a^2 \cos^2 \theta + b^2 \sin^2 \theta) dr d\theta$$

$$= \frac{ab}{4} \int_0^{2\pi} (a^2 \cos^2 \theta + b^2 \sin^2 \theta) d\theta = \frac{ab}{4} \left[\frac{a^2 \theta}{2} + \frac{a^2 \sin 2\theta}{4} + \frac{b^2 \theta}{2} - \frac{b^2 \sin 2\theta}{4} \right]_0^{2\pi} = \frac{ab\pi(a^2 + b^2)}{4}$$

12. $\frac{\partial(x,y)}{\partial(u,v)} = J(u,v) = \begin{vmatrix} a & 0 \\ 0 & b \end{vmatrix} = ab$; $A = \iint_R dy dx = \iint_G ab du dv = \int_{-1}^1 \int_{-\sqrt{1-u^2}}^{\sqrt{1-u^2}} ab dv du$
- $$= 2ab \int_{-1}^1 \sqrt{1-u^2} du = 2ab \left[\frac{u}{2} \sqrt{1-u^2} + \frac{1}{2} \sin^{-1} u \right]_{-1}^1 = ab [\sin^{-1} 1 - \sin^{-1}(-1)] = ab \left[\frac{\pi}{2} - \left(-\frac{\pi}{2}\right) \right] = ab\pi$$

13. The region of integration R in the xy-plane is sketched in the figure at the right. The boundaries of the image G are obtained as follows, with G sketched at the right:

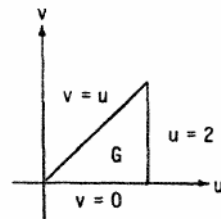
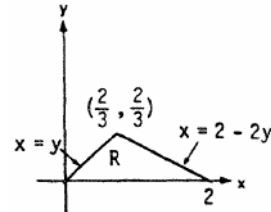

xy-equations for the boundary of R	Corresponding uv-equations for the boundary of G	Simplified uv-equations
$x = y$	$\frac{1}{3}(u + 2v) = \frac{1}{3}(u - v)$	$v = 0$
$x = 2 - 2y$	$\frac{1}{3}(u + 2v) = 2 - \frac{2}{3}(u - v)$	$u = 2$
$y = 0$	$0 = \frac{1}{3}(u - v)$	$v = u$

Also, from Exercise 2, $\frac{\partial(x,y)}{\partial(u,v)} = J(u,v) = -\frac{1}{3} \Rightarrow \int_0^{2/3} \int_y^{2-2y} (x+2y) e^{(y-x)} dx dy = \int_0^2 \int_0^u u e^{-v} \left| -\frac{1}{3} \right| dv du$

$$= \frac{1}{3} \int_0^2 u [-e^{-v}]_0^u du = \frac{1}{3} \int_0^2 u (1 - e^{-u}) du = \frac{1}{3} \left[u(u + e^{-u}) - \frac{u^2}{2} + e^{-u} \right]_0^2 = \frac{1}{3} [2(2 + e^{-2}) - 2 + e^{-2} - 1]$$

$$= \frac{1}{3} (3e^{-2} + 1) \approx 0.4687$$

14. $x = u + \frac{v}{2}$ and $y = v \Rightarrow 2x - y = (2u + v) - v = 2u$ and

$$\frac{\partial(x,y)}{\partial(u,v)} = J(u,v) = \begin{vmatrix} 1 & \frac{1}{2} \\ 0 & 1 \end{vmatrix} = 1; \text{ next, } u = x - \frac{v}{2}$$

$= x - \frac{v}{2}$ and $v = y$, so the boundaries of the region of integration R in the xy -plane are transformed to the boundaries of G :

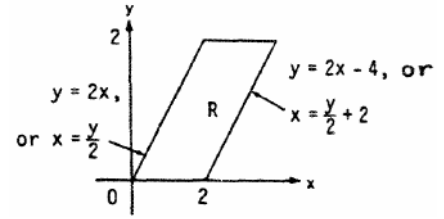

xy-equations for the boundary of R	Corresponding uv-equations for the boundary of G	Simplified uv-equations
$x = \frac{y}{2}$	$u + \frac{v}{2} = \frac{v}{2}$	$u = 0$
$x = \frac{y}{2} + 2$	$u + \frac{v}{2} = \frac{v}{2} + 2$	$u = 2$
$y = 0$	$v = 0$	$v = 0$
$y = 2$	$v = 2$	$v = 2$

$$\begin{aligned} \Rightarrow \int_0^2 \int_{y/2}^{(y/2)+2} y^3(2x - y) e^{(2x-y)^2} dx dy &= \int_0^2 \int_0^2 v^3(2u) e^{4u^2} du dv = \int_0^2 v^3 \left[\frac{1}{4} e^{4u^2} \right]_0^2 dv \\ &= \frac{1}{4} (e^{16} - 1) \left[\frac{v^4}{4} \right]_0^2 = e^{16} - 1 \end{aligned}$$

15. (a) $x = u \cos v$ and $y = u \sin v \Rightarrow \frac{\partial(x,y)}{\partial(u,v)} = \begin{vmatrix} \cos v & -u \sin v \\ \sin v & u \cos v \end{vmatrix} = u \cos^2 v + u \sin^2 v = u$

(b) $x = u \sin v$ and $y = u \cos v \Rightarrow \frac{\partial(x,y)}{\partial(u,v)} = \begin{vmatrix} \sin v & u \cos v \\ \cos v & -u \sin v \end{vmatrix} = -u \sin^2 v - u \cos^2 v = -u$

16. (a) $x = u \cos v, y = u \sin v, z = w \Rightarrow \frac{\partial(x,y,z)}{\partial(u,v,w)} = \begin{vmatrix} \cos v & -u \sin v & 0 \\ \sin v & u \cos v & 0 \\ 0 & 0 & 1 \end{vmatrix} = u \cos^2 v + u \sin^2 v = u$

(b) $x = 2u - 1, y = 3v - 4, z = \frac{1}{2}(w - 4) \Rightarrow \frac{\partial(x,y,z)}{\partial(u,v,w)} = \begin{vmatrix} 2 & 0 & 0 \\ 0 & 3 & 0 \\ 0 & 0 & \frac{1}{2} \end{vmatrix} = (2)(3)\left(\frac{1}{2}\right) = 3$

17.
$$\begin{vmatrix} \sin \phi \cos \theta & \rho \cos \phi \cos \theta & -\rho \sin \phi \sin \theta \\ \sin \phi \sin \theta & \rho \cos \phi \sin \theta & \rho \sin \phi \cos \theta \\ \cos \phi & -\rho \sin \phi & 0 \end{vmatrix}$$

$$= (\cos \phi) \begin{vmatrix} \rho \cos \phi \cos \theta & -\rho \sin \phi \sin \theta \\ \rho \cos \phi \sin \theta & \rho \sin \phi \cos \theta \end{vmatrix} + (\rho \sin \phi) \begin{vmatrix} \sin \phi \cos \theta & -\rho \sin \phi \sin \theta \\ \sin \phi \sin \theta & \rho \sin \phi \cos \theta \end{vmatrix}$$

$$= (\rho^2 \cos \phi) (\sin \phi \cos \phi \cos^2 \theta + \sin \phi \cos \phi \sin^2 \theta) + (\rho^2 \sin \phi) (\sin^2 \phi \cos^2 \theta + \sin^2 \phi \sin^2 \theta)$$

$$= \rho^2 \sin \phi \cos^2 \phi + \rho^2 \sin^3 \phi = (\rho^2 \sin \phi) (\cos^2 \phi + \sin^2 \phi) = \rho^2 \sin \phi$$

18. Let $u = g(x) \Rightarrow J(x) = \frac{du}{dx} = g'(x) \Rightarrow \int_a^b f(u) du = \int_{g(a)}^{g(b)} f(g(x))g'(x) dx$ in accordance with Theorem 6 in Section 5.6. Note that $g'(x)$ represents the Jacobian of the transformation $u = g(x)$ or $x = g^{-1}(u)$.

19.
$$\int_0^3 \int_0^4 \int_{y/2}^{1+(y/2)} \left(\frac{2x-y}{2} + \frac{z}{3} \right) dx dy dz = \int_0^3 \int_0^4 \left[\frac{x^2}{2} - \frac{xy}{2} + \frac{xz}{3} \right]_{y/2}^{1+(y/2)} dy dz = \int_0^3 \int_0^4 \left[\frac{1}{2}(y+1) - \frac{y}{2} + \frac{z}{3} \right] dy dz$$

$$= \int_0^3 \left[\frac{(y+1)^2}{4} - \frac{y^2}{4} + \frac{yz}{3} \right]_0^4 dz = \int_0^3 \left(\frac{9}{4} + \frac{4z}{3} - \frac{1}{4} \right) dz = \int_0^3 \left(2 + \frac{4z}{3} \right) dz = \left[2z + \frac{2z^2}{3} \right]_0^3 = 12$$

20. $J(u, v, w) = \begin{vmatrix} a & 0 & 0 \\ 0 & b & 0 \\ 0 & 0 & c \end{vmatrix} = abc$; the transformation takes the ellipsoid region $\frac{x^2}{a^2} + \frac{y^2}{b^2} + \frac{z^2}{c^2} \leq 1$ in xyz -space into the spherical region $u^2 + v^2 + w^2 \leq 1$ in uvw -space (which has volume $V = \frac{4}{3}\pi$)

$$\Rightarrow V = \int \int \int_R dx dy dz = \int \int \int_G abc du dv dw = \frac{4\pi abc}{3}$$

21. $J(u, v, w) = \begin{vmatrix} a & 0 & 0 \\ 0 & b & 0 \\ 0 & 0 & c \end{vmatrix} = abc$; for R and G as in Exercise 19, $\int \int \int_R |xyz| dx dy dz$

$$= \int \int \int_G a^2 b^2 c^2 uvw dw dv du = 8a^2 b^2 c^2 \int_0^{\pi/2} \int_0^{\pi/2} \int_0^1 (\rho \sin \phi \cos \theta)(\rho \sin \phi \sin \theta)(\rho \cos \phi) (\rho^2 \sin \phi) d\rho d\phi d\theta$$

$$= \frac{4a^2 b^2 c^2}{3} \int_0^{\pi/2} \int_0^{\pi/2} \sin \theta \cos \theta \sin^3 \phi \cos \phi d\phi d\theta = \frac{a^2 b^2 c^2}{3} \int_0^{\pi/2} \sin \theta \cos \theta d\theta = \frac{a^2 b^2 c^2}{6}$$

22. $u = x, v = xy, \text{ and } w = 3z \Rightarrow x = u, y = \frac{v}{u}, \text{ and } z = \frac{1}{3} w \Rightarrow J(u, v, w) = \begin{vmatrix} 1 & 0 & 0 \\ -\frac{v}{u^2} & \frac{1}{u} & 0 \\ 0 & 0 & \frac{1}{3} \end{vmatrix} = \frac{1}{3u}$;

$$\int \int \int_R (x^2 y + 3xyz) dx dy dz = \int \int \int_G [u^2 (\frac{v}{u}) + 3u (\frac{v}{u}) (\frac{w}{3})] |J(u, v, w)| du dv dw = \frac{1}{3} \int_0^3 \int_0^2 \int_1^2 (v + \frac{vw}{u}) du dv dw$$

$$= \frac{1}{3} \int_0^3 \int_0^2 (v + vw \ln 2) dv dw = \frac{1}{3} \int_0^3 (1 + w \ln 2) \left[\frac{v^2}{2} \right]_0^2 dw = \frac{2}{3} \int_0^3 (1 + w \ln 2) dw = \frac{2}{3} \left[w + \frac{w^2}{2} \ln 2 \right]_0^3$$

$$= \frac{2}{3} \left(3 + \frac{9}{2} \ln 2 \right) = 2 + 3 \ln 2 = 2 + \ln 8$$

23. The first moment about the xy -coordinate plane for the semi-ellipsoid, $\frac{x^2}{a^2} + \frac{y^2}{b^2} + \frac{z^2}{c^2} = 1$ using the transformation in Exercise 21 is, $M_{xy} = \int \int \int_D z dz dy dx = \int \int \int_G cw |J(u, v, w)| du dv dw$

$$= abc^2 \int \int \int_G w du dv dw = (abc^2) \cdot (M_{xy} \text{ of the hemisphere } x^2 + y^2 + z^2 = 1, z \geq 0) = \frac{abc^2 \pi}{4}$$

the mass of the semi-ellipsoid is $\frac{2abc\pi}{3} \Rightarrow \bar{z} = \left(\frac{abc^2 \pi}{4} \right) \left(\frac{3}{2abc\pi} \right) = \frac{3}{8} c$

24. A solid of revolutions is symmetric about the axis of revolution, therefore, the height of the solid is solely a function of r . That is, $y = f(x) = f(r)$. Using cylindrical coordinates with $x = r \cos \theta, y = y$ and $z = r \sin \theta$, we have

$$V = \int \int \int_G r dy d\theta dr = \int_a^b \int_0^{2\pi} \int_0^{f(r)} r dy d\theta dr = \int_a^b \int_0^{2\pi} [r y]_0^{f(r)} d\theta dr = \int_a^b \int_0^{2\pi} r f(r) d\theta dr = \int_a^b [r\theta f(r)]_0^{2\pi} dr$$

$\int_a^b 2\pi r f(r) dr$. In the last integral, r is a dummy or stand-in variable and as such it can be replaced by any variable name.

Choosing x instead of r we have $V = \int_a^b 2\pi x f(x) dx$, which is the same result obtained using the shell method.

CHAPTER 15 PRACTICE EXERCISES

1. $\int_1^{10} \int_0^{1/y} ye^{xy} dx dy = \int_1^{10} [e^{xy}]_0^{1/y} dy$
 $= \int_1^{10} (e - 1) dy = 9e - 9$

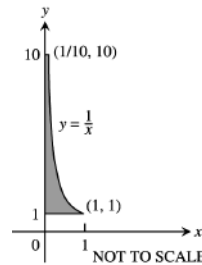

$$2. \int_0^1 \int_0^{x^3} e^{y/x} dy dx = \int_0^1 x [e^{y/x}]_0^{x^3} dx$$

$$= \int_0^1 (xe^{x^2} - x) dx = \left[\frac{1}{2} e^{x^2} - \frac{x^2}{2} \right]_0^1 = \frac{e-2}{2}$$

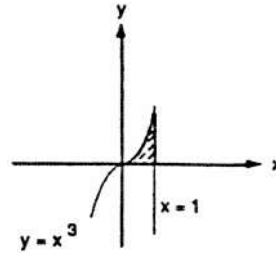

$$3. \int_0^{3/2} \int_{-\sqrt{9-4t^2}}^{\sqrt{9-4t^2}} t ds dt = \int_0^{3/2} [ts]_{-\sqrt{9-4t^2}}^{\sqrt{9-4t^2}} dt$$

$$= \int_0^{3/2} 2t\sqrt{9-4t^2} dt = \left[-\frac{1}{6} (9-4t^2)^{3/2} \right]_0^{3/2}$$

$$= -\frac{1}{6} (0^{3/2} - 9^{3/2}) = \frac{27}{6} = \frac{9}{2}$$

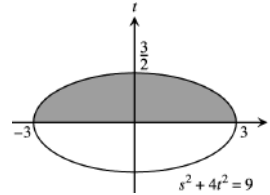

$$4. \int_0^1 \int_{\sqrt{y}}^{2-\sqrt{y}} xy dx dy = \int_0^1 y \left[\frac{x^2}{2} \right]_{\sqrt{y}}^{2-\sqrt{y}} dy$$

$$= \frac{1}{2} \int_0^1 y (4 - 4\sqrt{y} + y - y) dy$$

$$= \int_0^1 (2y - 2y^{3/2}) dy = \left[y^2 - \frac{4y^{5/2}}{5} \right]_0^1 = \frac{1}{5}$$

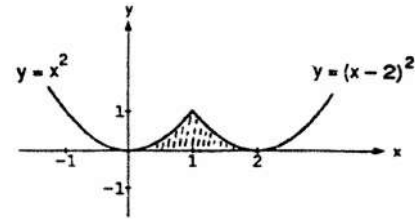

$$5. \int_{-2}^0 \int_{2x+4}^{4-x^2} dy dx = \int_{-2}^0 (-x^2 - 2x) dx$$

$$= \left[-\frac{x^3}{3} - x^2 \right]_{-2}^0 = -\left(\frac{8}{3} - 4 \right) = \frac{4}{3}$$

$$\int_0^4 \int_{-\sqrt{4-y}}^{(y-4)/2} dx dy = \int_0^4 \left(\frac{y-4}{2} + \sqrt{4-y} \right) dy$$

$$= \left[\frac{y^2}{2} - 2y - \frac{2}{3}(4-y)^{3/2} \right]_0^4 = 4 - 8 + \frac{2}{3} \cdot 4^{3/2}$$

$$= -4 + \frac{16}{3} = \frac{4}{3}$$

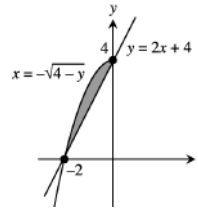

$$6. \int_0^1 \int_y^{\sqrt{y}} \sqrt{x} dx dy = \int_0^1 \left[\frac{2}{3} x^{3/2} \right]_y^{\sqrt{y}} dy$$

$$= \frac{2}{3} \int_0^1 (y^{3/4} - y^{3/2}) dy = \frac{2}{3} \left[\frac{4}{7} y^{7/4} - \frac{2}{5} y^{5/2} \right]_0^1$$

$$= \frac{2}{3} \left(\frac{4}{7} - \frac{2}{5} \right) = \frac{4}{35}$$

$$\int_0^1 \int_x^{\sqrt{x}} \sqrt{x} dy dx = \int_0^1 x^{1/2} (x - x^2) dx = \int_0^1 (x^{3/2} - x^{5/2}) dx$$

$$= \left[\frac{2}{5} x^{5/2} - \frac{2}{7} x^{7/2} \right]_0^1 = \frac{2}{5} - \frac{2}{7} = \frac{4}{35}$$

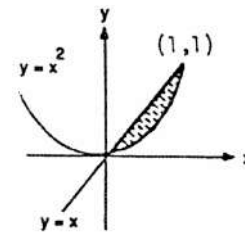

$$7. \int_{-3}^3 \int_0^{(1/2)\sqrt{9-x^2}} y dy dx = \int_{-3}^3 \left[\frac{y^2}{2} \right]_0^{(1/2)\sqrt{9-x^2}} dx$$

$$= \int_{-3}^3 \frac{1}{8} (9 - x^2) dx = \left[\frac{9x}{8} - \frac{x^3}{24} \right]_{-3}^3$$

$$= \left(\frac{27}{8} - \frac{27}{24} \right) - \left(-\frac{27}{8} + \frac{27}{24} \right) = \frac{27}{6} = \frac{9}{2}$$

$$\int_0^{3/2} \int_{-\sqrt{9-4y^2}}^{\sqrt{9-4y^2}} y dx dy = \int_0^{3/2} 2y\sqrt{9-4y^2} dy$$

$$= -\frac{1}{4} \cdot \frac{2}{3} (9-4y^2)^{3/2} \Big|_0^{3/2} = \frac{1}{6} \cdot 9^{3/2} = \frac{27}{6} = \frac{9}{2}$$

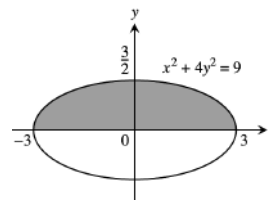

$$\begin{aligned}
 8. \int_0^2 \int_0^{4-x^2} 2x \, dy \, dx &= \int_0^2 [2xy]_0^{4-x^2} \, dx \\
 &= \int_0^2 (2x(4-x^2)) \, dx = \int_0^2 (8x-2x^3) \, dx \\
 &= \left[4x^2 - \frac{x^4}{2} \right]_0^2 = 16 - \frac{16}{2} = 8 \\
 \int_0^4 \int_0^{\sqrt{4-y}} 2x \, dx \, dy &= \int_0^4 [x^2]_0^{\sqrt{4-y}} \, dy \\
 &= \int_0^4 (4-y) \, dy = \left[4y - \frac{y^2}{2} \right]_0^4 = 16 - \frac{16}{2} = 8
 \end{aligned}$$

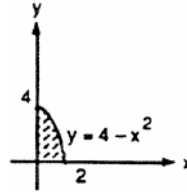

$$9. \int_0^1 \int_{2y}^2 4 \cos(x^2) \, dx \, dy = \int_0^2 \int_0^{x/2} 4 \cos(x^2) \, dy \, dx = \int_0^2 2x \cos(x^2) \, dx = [\sin(x^2)]_0^2 = \sin 4$$

$$10. \int_0^2 \int_{y/2}^1 e^{x^2} \, dx \, dy = \int_0^1 \int_0^{2x} e^{x^2} \, dy \, dx = \int_0^1 2xe^{x^2} \, dx = [e^{x^2}]_0^1 = e - 1$$

$$11. \int_0^8 \int_{\sqrt[3]{x}}^2 \frac{1}{y^4+1} \, dy \, dx = \int_0^2 \int_0^{y^3} \frac{1}{y^4+1} \, dx \, dy = \frac{1}{4} \int_0^2 \frac{4y^3}{y^4+1} \, dy = \frac{\ln 17}{4}$$

$$12. \int_0^1 \int_{\sqrt[3]{y}}^1 \frac{2\pi \sin(\pi x^2)}{x^2} \, dx \, dy = \int_0^1 \int_0^{x^3} \frac{2\pi \sin(\pi x^2)}{x^2} \, dy \, dx = \int_0^1 2\pi x \sin(\pi x^2) \, dx = [-\cos(\pi x^2)]_0^1 = -(-1) - (-1) = 2$$

$$13. A = \int_{-2}^0 \int_{2x+4}^{4-x^2} dy \, dx = \int_{-2}^0 (-x^2 - 2x) \, dx = \frac{4}{3} \qquad 14. A = \int_1^4 \int_{2-y}^{\sqrt{y}} dx \, dy = \int_1^4 (\sqrt{y} - 2 + y) \, dy = \frac{37}{6}$$

$$15. V = \int_0^1 \int_x^{2-x} (x^2 + y^2) \, dy \, dx = \int_0^1 \left[x^2 y + \frac{y^3}{3} \right]_x^{2-x} \, dx = \int_0^1 \left[2x^2 + \frac{(2-x)^3}{3} - \frac{7x^3}{3} \right] \, dx = \left[\frac{2x^3}{3} - \frac{(2-x)^4}{12} - \frac{7x^4}{12} \right]_0^1 = \left(\frac{2}{3} - \frac{1}{12} - \frac{7}{12} \right) + \frac{2^4}{12} = \frac{4}{3}$$

$$16. V = \int_{-3}^2 \int_x^{6-x^2} x^2 \, dy \, dx = \int_{-3}^2 [x^2 y]_x^{6-x^2} \, dx = \int_{-3}^2 (6x^2 - x^4 - x^3) \, dx = \frac{125}{4}$$

$$17. \text{average value} = \int_0^1 \int_0^1 xy \, dy \, dx = \int_0^1 \left[\frac{xy^2}{2} \right]_0^1 \, dx = \int_0^1 \frac{x}{2} \, dx = \frac{1}{4}$$

$$18. \text{average value} = \frac{1}{\frac{\pi}{4}} \int_0^1 \int_0^{\sqrt{1-x^2}} xy \, dy \, dx = \frac{4}{\pi} \int_0^1 \left[\frac{xy^2}{2} \right]_0^{\sqrt{1-x^2}} \, dx = \frac{2}{\pi} \int_0^1 (x - x^3) \, dx = \frac{1}{2\pi}$$

$$19. M = \int_1^2 \int_{2/x}^2 dy \, dx = \int_1^2 (2 - \frac{2}{x}) \, dx = 2 - \ln 4; M_y = \int_1^2 \int_{2/x}^2 x \, dy \, dx = \int_1^2 x (2 - \frac{2}{x}) \, dx = 1;$$

$$M_x = \int_1^2 \int_{2/x}^2 y \, dy \, dx = \int_1^2 (2 - \frac{2}{x^2}) \, dx = 1 \Rightarrow \bar{x} = \bar{y} = \frac{1}{2 - \ln 4}$$

$$20. M = \int_0^4 \int_{-2y}^{2y-y^2} dx \, dy = \int_0^4 (4y - y^2) \, dy = \frac{32}{3}; M_x = \int_0^4 \int_{-2y}^{2y-y^2} y \, dx \, dy = \int_0^4 (4y^2 - y^3) \, dy = \left[\frac{4y^3}{3} - \frac{y^4}{4} \right]_0^4 = \frac{64}{3};$$

$$M_y = \int_0^4 \int_{-2y}^{2y-y^2} x \, dx \, dy = \int_0^4 \left[\frac{(2y-y^2)^2}{2} - 2y^2 \right] \, dy = \left[\frac{y^5}{10} - \frac{y^4}{2} \right]_0^4 = -\frac{128}{5} \Rightarrow \bar{x} = \frac{M_x}{M} = -\frac{12}{5} \text{ and } \bar{y} = \frac{M_y}{M} = 2$$

$$21. I_0 = \int_0^2 \int_{2x}^4 (x^2 + y^2) (3) \, dy \, dx = 3 \int_0^2 \left(4x^2 + \frac{64}{3} - \frac{14x^3}{3} \right) \, dx = 104$$

$$22. (a) I_0 = \int_{-2}^2 \int_{-1}^1 (x^2 + y^2) \, dy \, dx = \int_{-2}^2 (2x^2 + \frac{2}{3}) \, dx = \frac{40}{3}$$

$$(b) I_x = \int_{-a}^a \int_{-b}^b y^2 \, dy \, dx = \int_{-a}^a \frac{2b^3}{3} \, dx = \frac{4ab^3}{3}; I_y = \int_{-b}^b \int_{-a}^a x^2 \, dx \, dy = \int_{-b}^b \frac{2a^3}{3} \, dy = \frac{4a^3b}{3} \Rightarrow I_0 = I_x + I_y = \frac{4ab^3}{3} + \frac{4a^3b}{3} = \frac{4ab(b^2+a^2)}{3}$$

23. $M = \delta \int_0^3 \int_0^{2x/3} dy dx = \delta \int_0^3 \frac{2x}{3} dx = 3\delta$; $I_x = \delta \int_0^3 \int_0^{2x/3} y^2 dy dx = \frac{8\delta}{81} \int_0^3 x^3 dx = \left(\frac{8\delta}{81}\right) \left(\frac{3^4}{4}\right) = 2\delta \Rightarrow R_x = \sqrt{\frac{2}{3}}$

24. $M = \int_0^1 \int_{x^2}^x (x+1) dy dx = \int_0^1 (x-x^3) dx = \frac{1}{4}$; $M_x = \int_0^1 \int_{x^2}^x y(x+1) dy dx = \frac{1}{2} \int_0^1 (x^3-x^5+x^2-x^4) dx = \frac{13}{120}$;
 $M_y = \int_0^1 \int_{x^2}^x x(x+1) dy dx = \int_0^1 (x^2-x^4) dx = \frac{2}{15} \Rightarrow \bar{x} = \frac{8}{15}$ and $\bar{y} = \frac{13}{30}$; $I_x = \int_0^1 \int_{x^2}^x y^2(x+1) dy dx$
 $= \frac{1}{3} \int_0^1 (x^4-x^7+x^3-x^6) dx = \frac{17}{280} \Rightarrow R_x = \sqrt{\frac{I_x}{M}} = \sqrt{\frac{17}{70}}$; $I_y = \int_0^1 \int_{x^2}^x x^2(x+1) dy dx = \int_0^1 (x^3-x^5) dx$
 $= \frac{1}{12} \Rightarrow R_y = \sqrt{\frac{I_y}{M}} = \sqrt{\frac{1}{3}}$

25. $M = \int_{-1}^1 \int_{-1}^1 (x^2+y^2+\frac{1}{3}) dy dx = \int_{-1}^1 (2x^2+\frac{4}{3}) dx = 4$; $M_x = \int_{-1}^1 \int_{-1}^1 y(x^2+y^2+\frac{1}{3}) dy dx = \int_{-1}^1 0 dx = 0$;
 $M_y = \int_{-1}^1 \int_{-1}^1 x(x^2+y^2+\frac{1}{3}) dy dx = \int_{-1}^1 (2x^3+\frac{4}{3}x) dx = 0$

26. Place the $\triangle ABC$ with its vertices at $A(0, 0)$, $B(b, 0)$ and $C(a, h)$. The line through the points A and C is $y = \frac{h}{a}x$; the line through the points C and B is $y = \frac{h}{a-b}(x-b)$. Thus, $M = \int_0^h \int_{ay/h}^{(a-b)y/h+b} \delta dx dy$
 $= b\delta \int_0^h (1-\frac{y}{h}) dy = \frac{\delta bh^2}{2}$; $I_x = \int_0^h \int_{ay/h}^{(a-b)y/h+b} y^2 \delta dx dy = b\delta \int_0^h (y^2-\frac{y^3}{h}) dy = \frac{\delta bh^3}{12}$; $R_x = \sqrt{\frac{I_x}{M}} = \frac{h}{\sqrt{6}}$

27. $\int_{-1}^1 \int_{-\sqrt{1-x^2}}^{\sqrt{1-x^2}} \frac{2}{(1+x^2+y^2)} dy dx = \int_0^{2\pi} \int_0^1 \frac{2r}{(1+r^2)^2} dr d\theta = \int_0^{2\pi} [-\frac{1}{1+r^2}]_0^1 d\theta = \frac{1}{2} \int_0^{2\pi} d\theta = \pi$

28. $\int_{-1}^1 \int_{-\sqrt{1-y^2}}^{\sqrt{1-y^2}} \ln(x^2+y^2+1) dx dy = \int_0^{2\pi} \int_1^2 r \ln(r^2+1) dr d\theta = \int_0^{2\pi} \int_1^2 \frac{1}{2} \ln u du d\theta = \frac{1}{2} \int_0^{2\pi} [u \ln u - u]_1^2 d\theta$
 $= \frac{1}{2} \int_0^{2\pi} (2 \ln 2 - 1) d\theta = [\ln(4) - 1] \pi$

29. $M = \int_{-\pi/3}^{\pi/3} \int_0^3 r dr d\theta = \frac{9}{2} \int_{-\pi/3}^{\pi/3} d\theta = 3\pi$; $M_y = \int_{-\pi/3}^{\pi/3} \int_0^3 r^2 \cos \theta dr d\theta = 9 \int_{-\pi/3}^{\pi/3} \cos \theta d\theta = 9\sqrt{3} \Rightarrow \bar{x} = \frac{3\sqrt{3}}{\pi}$,
 and $\bar{y} = 0$ by symmetry

30. $M = \int_0^{\pi/2} \int_1^3 r dr d\theta = 4 \int_0^{\pi/2} d\theta = 2\pi$; $M_y = \int_0^{\pi/2} \int_1^3 r^2 \cos \theta dr d\theta = \frac{26}{3} \int_0^{\pi/2} \cos \theta d\theta = \frac{26}{3} \Rightarrow \bar{x} = \frac{13}{3\pi}$, and
 $\bar{y} = \frac{13}{3\pi}$ by symmetry

31. (a) $M = 2 \int_0^{\pi/2} \int_1^{1+\cos \theta} r dr d\theta$
 $= \int_0^{\pi/2} (2 \cos \theta + \frac{1+\cos 2\theta}{2}) d\theta = \frac{8+\pi}{4}$;
 $M_y = \int_{-\pi/2}^{\pi/2} \int_1^{1+\cos \theta} (r \cos \theta) r dr d\theta$
 $= \int_{-\pi/2}^{\pi/2} (\cos^2 \theta + \cos^3 \theta + \frac{\cos^4 \theta}{3}) d\theta$
 $= \frac{32+15\pi}{24} \Rightarrow \bar{x} = \frac{15\pi+32}{6\pi+48}$, and
 $\bar{y} = 0$ by symmetry

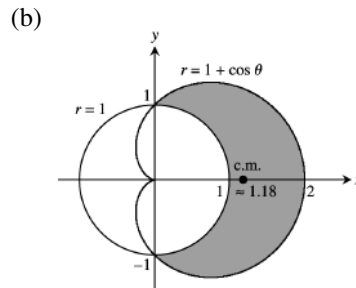

32. (a) $M = \int_{-\alpha}^{\alpha} \int_0^a r dr d\theta = \int_{-\alpha}^{\alpha} \frac{a^2}{2} d\theta = a^2\alpha$; $M_y = \int_{-\alpha}^{\alpha} \int_0^a (r \cos \theta) r dr d\theta = \int_{-\alpha}^{\alpha} \frac{a^3 \cos \theta}{3} d\theta = \frac{2a^3 \sin \alpha}{3}$
 $\Rightarrow \bar{x} = \frac{2a \sin \alpha}{3\alpha}$, and $\bar{y} = 0$ by symmetry; $\lim_{\alpha \rightarrow \pi^-} \bar{x} = \lim_{\alpha \rightarrow \pi^-} \frac{2a \sin \alpha}{3\alpha} = 0$

(b) $\bar{x} = \frac{2a}{5\pi}$ and $\bar{y} = 0$

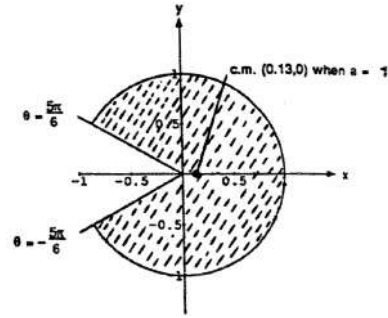

33. $(x^2 + y^2)^2 - (x^2 - y^2) = 0 \Rightarrow r^4 - r^2 \cos 2\theta = 0 \Rightarrow r^2 = \cos 2\theta$ so the integral is $\int_{-\pi/4}^{\pi/4} \int_0^{\sqrt{\cos 2\theta}} \frac{r}{(1+r^2)^2} dr d\theta$
 $= \int_{-\pi/4}^{\pi/4} \left[-\frac{1}{2(1+r^2)} \right]_0^{\sqrt{\cos 2\theta}} d\theta = \frac{1}{2} \int_{-\pi/4}^{\pi/4} \left(1 - \frac{1}{1+\cos 2\theta} \right) d\theta = \frac{1}{2} \int_{-\pi/4}^{\pi/4} \left(1 - \frac{1}{2\cos^2 \theta} \right) d\theta$
 $= \frac{1}{2} \int_{-\pi/4}^{\pi/4} \left(1 - \frac{\sec^2 \theta}{2} \right) d\theta = \frac{1}{2} \left[\theta - \frac{\tan \theta}{2} \right]_{-\pi/4}^{\pi/4} = \frac{\pi-2}{4}$

34. (a) $\iint_R \frac{1}{(1+x^2+y^2)^2} dx dy = \int_0^{\pi/3} \int_0^{\sec \theta} \frac{r}{(1+r^2)^2} dr d\theta = \int_0^{\pi/3} \left[-\frac{1}{2(1+r^2)} \right]_0^{\sec \theta} d\theta$
 $= \int_0^{\pi/3} \left[\frac{1}{2} - \frac{1}{2(1+\sec^2 \theta)} \right] d\theta = \frac{1}{2} \int_0^{\pi/3} \frac{\sec^2 \theta}{1+\sec^2 \theta} d\theta; \left[\begin{array}{l} u = \tan \theta \\ du = \sec^2 \theta d\theta \end{array} \right] \rightarrow \frac{1}{2} \int_0^{\sqrt{3}} \frac{du}{2+u^2}$
 $= \frac{1}{2} \left[\frac{1}{\sqrt{2}} \tan^{-1} \frac{u}{\sqrt{2}} \right]_0^{\sqrt{3}} = \frac{\sqrt{2}}{4} \tan^{-1} \sqrt{\frac{3}{2}}$

(b) $\iint_R \frac{1}{(1+x^2+y^2)^2} dx dy = \int_0^{\pi/2} \int_0^{\infty} \frac{r}{(1+r^2)^2} dr d\theta = \int_0^{\pi/2} \lim_{b \rightarrow \infty} \left[-\frac{1}{2(1+r^2)} \right]_0^b d\theta$
 $= \int_0^{\pi/2} \lim_{b \rightarrow \infty} \left[\frac{1}{2} - \frac{1}{2(1+b^2)} \right] d\theta = \frac{1}{2} \int_0^{\pi/2} d\theta = \frac{\pi}{4}$

35. $\int_0^{\pi} \int_0^{\pi} \int_0^{\pi} \cos(x+y+z) dx dy dz = \int_0^{\pi} \int_0^{\pi} [\sin(z+y+\pi) - \sin(z+y)] dy dz$
 $= \int_0^{\pi} [-\cos(z+2\pi) + \cos(z+\pi) - \cos z + \cos(z+\pi)] dz = 0$

36. $\int_{\ln 6}^{\ln 7} \int_0^{\ln 2} \int_{\ln 4}^{\ln 5} e^{(x+y+z)} dz dy dx = \int_{\ln 6}^{\ln 7} \int_0^{\ln 2} e^{(x+y)} dy dx = \int_{\ln 6}^{\ln 7} e^x dx = 1$

37. $\int_0^1 \int_0^{x^2} \int_0^{x+y} (2x - y - z) dz dy dx = \int_0^1 \int_0^{x^2} \left(\frac{3x^2}{2} - \frac{3y^2}{2} \right) dy dx = \int_0^1 \left(\frac{3x^4}{2} - \frac{x^6}{2} \right) dx = \frac{8}{35}$

38. $\int_1^e \int_1^x \int_0^{\frac{2y}{z^3}} dy dz dx = \int_1^e \int_1^x \frac{1}{z} dz dx = \int_1^e \ln x dx = [x \ln x - x]_1^e = 1$

39. $V = 2 \int_0^{\pi/2} \int_{-\cos y}^0 \int_0^{-2x} dz dx dy = 2 \int_0^{\pi/2} \int_{-\cos y}^0 -2x dx dy = 2 \int_0^{\pi/2} \cos^2 y dy = 2 \left[\frac{y}{2} + \frac{\sin 2y}{4} \right]_0^{\pi/2} = \frac{\pi}{2}$

40. $V = 4 \int_0^2 \int_0^{\sqrt{4-x^2}} \int_0^{4-x^2} dz dy dx = 4 \int_0^2 \int_0^{\sqrt{4-x^2}} (4-x^2) dy dx = 4 \int_0^2 (4-x^2)^{3/2} dx$
 $= \left[x(4-x^2)^{3/2} + 6x\sqrt{4-x^2} + 24 \sin^{-1} \frac{x}{2} \right]_0^2 = 24 \sin^{-1} 1 = 12\pi$

41. average $= \frac{1}{3} \int_0^1 \int_0^3 \int_0^1 30xz\sqrt{x^2+y} dz dy dx = \frac{1}{3} \int_0^1 \int_0^3 15x\sqrt{x^2+y} dy dx = \frac{1}{3} \int_0^3 \int_0^1 15x\sqrt{x^2+y} dx dy$
 $= \frac{1}{3} \int_0^3 \left[5(x^2+y)^{3/2} \right]_0^1 dy = \frac{1}{3} \int_0^3 [5(1+y)^{3/2} - 5y^{3/2}] dy = \frac{1}{3} [2(1+y)^{5/2} - 2y^{5/2}]_0^3 = \frac{1}{3} [2(4)^{5/2} - 2(3)^{5/2} - 2]$
 $= \frac{1}{3} [2(31 - 3^{5/2})]$

$$42. \text{ average} = \frac{3}{4\pi a^3} \int_0^{2\pi} \int_0^\pi \int_0^a \rho^3 \sin \phi \, d\rho \, d\phi \, d\theta = \frac{3a}{16\pi} \int_0^{2\pi} \int_0^\pi \sin \phi \, d\phi \, d\theta = \frac{3a}{8\pi} \int_0^{2\pi} d\theta = \frac{3a}{4}$$

$$43. (a) \int_{-\sqrt{2}}^{\sqrt{2}} \int_{-\sqrt{2-y^2}}^{\sqrt{2-y^2}} \int_{\sqrt{x^2+y^2}}^{\sqrt{4-x^2-y^2}} 3 \, dz \, dx \, dy$$

$$(b) \int_0^{2\pi} \int_0^{\pi/4} \int_0^2 3\rho^2 \sin \phi \, d\rho \, d\phi \, d\theta$$

$$(c) \int_0^{2\pi} \int_0^{\sqrt{2}} \int_r^{\sqrt{4-r^2}} 3 \, dz \, r \, dr \, d\theta = 3 \int_0^{2\pi} \int_0^{\sqrt{2}} [r(4-r^2)^{1/2} - r^2] \, dr \, d\theta = 3 \int_0^{2\pi} \left[-\frac{1}{3}(4-r^2)^{3/2} - \frac{r^3}{3} \right]_0^{\sqrt{2}} d\theta \\ = \int_0^{2\pi} (-2^{3/2} - 2^{3/2} + 4^{3/2}) \, d\theta = (8 - 4\sqrt{2}) \int_0^{2\pi} d\theta = 2\pi(8 - 4\sqrt{2})$$

$$44. (a) \int_{-\pi/2}^{\pi/2} \int_0^1 \int_{-r^2}^{r^2} 21(r \cos \theta)(r \sin \theta)^2 \, dz \, r \, dr \, d\theta = \int_{-\pi/2}^{\pi/2} \int_0^1 \int_{-r^2}^{r^2} 21r^3 \cos \theta \sin^2 \theta \, dz \, r \, dr \, d\theta$$

$$(b) \int_{-\pi/2}^{\pi/2} \int_0^1 \int_{-r^2}^{r^2} 21r^3 \cos \theta \sin^2 \theta \, dz \, r \, dr \, d\theta = 84 \int_0^{\pi/2} \int_0^1 r^6 \sin^2 \theta \cos \theta \, dr \, d\theta = 12 \int_0^{\pi/2} \sin^2 \theta \cos \theta \, d\theta = 4$$

$$45. (a) \int_0^{2\pi} \int_0^{\pi/4} \int_0^{\sec \phi} \rho^2 \sin \phi \, d\rho \, d\phi \, d\theta$$

$$(b) \int_0^{2\pi} \int_0^{\pi/4} \int_0^{\sec \phi} \rho^2 \sin \phi \, d\rho \, d\phi \, d\theta = \frac{1}{3} \int_0^{2\pi} \int_0^{\pi/4} (\sec \phi)(\sec \phi \tan \phi) \, d\phi \, d\theta = \frac{1}{3} \int_0^{2\pi} \left[\frac{1}{2} \tan^2 \phi \right]_0^{\pi/4} d\theta = \frac{1}{6} \int_0^{2\pi} d\theta = \frac{\pi}{3}$$

$$46. (a) \int_0^1 \int_0^{\sqrt{1-x^2}} \int_0^{\sqrt{x^2+y^2}} (6+4y) \, dz \, dy \, dx \quad (b) \int_0^{\pi/2} \int_0^1 \int_0^r (6+4r \sin \theta) \, dz \, r \, dr \, d\theta$$

$$(c) \int_0^{\pi/2} \int_{\pi/4}^{\pi/2} \int_0^{\csc \phi} (6+4\rho \sin \phi \sin \theta) (\rho^2 \sin \phi) \, d\rho \, d\phi \, d\theta$$

$$(d) \int_0^{\pi/2} \int_0^1 \int_0^r (6+4r \sin \theta) \, dz \, r \, dr \, d\theta = \int_0^{\pi/2} \int_0^1 (6r^2 + 4r^3 \sin \theta) \, dr \, d\theta = \int_0^{\pi/2} [2r^3 + r^4 \sin \theta]_0^1 d\theta \\ = \int_0^{\pi/2} (2 + \sin \theta) \, d\theta = [2\theta - \cos \theta]_0^{\pi/2} = \pi + 1$$

$$47. \int_0^1 \int_{\sqrt{1-x^2}}^{\sqrt{3-x^2}} \int_1^{\sqrt{4-x^2-y^2}} z^2 y x \, dz \, dy \, dx + \int_1^{\sqrt{3}} \int_0^{\sqrt{3-x^2}} \int_1^{\sqrt{4-x^2-y^2}} z^2 y x \, dz \, dy \, dx$$

48. (a) Bounded on the top and bottom by the sphere $x^2 + y^2 + z^2 = 4$, on the right by the right circular cylinder $(x-1)^2 + y^2 = 1$, on the left by the plane $y = 0$

$$(b) \int_0^{\pi/2} \int_0^{2 \cos \theta} \int_{-\sqrt{4-r^2}}^{\sqrt{4-r^2}} dz \, r \, dr \, d\theta$$

$$49. (a) V = \int_0^{2\pi} \int_0^2 \int_2^{\sqrt{8-r^2}} dz \, r \, dr \, d\theta = \int_0^{2\pi} \int_0^2 (r\sqrt{8-r^2} - 2r) \, dr \, d\theta = \int_0^{2\pi} \left[-\frac{1}{3}(8-r^2)^{3/2} - r^2 \right]_0^2 d\theta \\ = \int_0^{2\pi} \left[-\frac{1}{3}(4)^{3/2} - 4 + \frac{1}{3}(8)^{3/2} \right] d\theta = \int_0^{2\pi} \frac{4}{3} (-2 - 3 + 2\sqrt{8}) \, d\theta = \frac{4}{3} (4\sqrt{2} - 5) \int_0^{2\pi} d\theta = \frac{8\pi(4\sqrt{2}-5)}{3}$$

$$(b) V = \int_0^{2\pi} \int_0^{\pi/4} \int_{2 \sec \phi}^{\sqrt{8}} \rho^2 \sin \phi \, d\rho \, d\phi \, d\theta = \frac{8}{3} \int_0^{2\pi} \int_0^{\pi/4} (2\sqrt{2} \sin \phi - \sec^3 \phi \sin \phi) \, d\phi \, d\theta \\ = \frac{8}{3} \int_0^{2\pi} \int_0^{\pi/4} (2\sqrt{2} \sin \phi - \tan \phi \sec^2 \phi) \, d\phi \, d\theta = \frac{8}{3} \int_0^{2\pi} \left[-2\sqrt{2} \cos \phi - \frac{1}{2} \tan^2 \phi \right]_0^{\pi/4} d\theta \\ = \frac{8}{3} \int_0^{2\pi} \left(-2 - \frac{1}{2} + 2\sqrt{2} \right) d\theta = \frac{8}{3} \int_0^{2\pi} \left(\frac{-5+4\sqrt{2}}{2} \right) d\theta = \frac{8\pi(4\sqrt{2}-5)}{3}$$

$$50. I_z = \int_0^{2\pi} \int_0^{\pi/3} \int_0^2 (\rho \sin \phi)^2 (\rho^2 \sin \phi) \, d\rho \, d\phi \, d\theta = \int_0^{2\pi} \int_0^{\pi/3} \int_0^2 \rho^4 \sin^3 \phi \, d\rho \, d\phi \, d\theta$$

$$= \frac{32}{5} \int_0^{2\pi} \int_0^{\pi/3} (\sin \phi - \cos^2 \phi \sin \phi) \, d\phi \, d\theta = \frac{32}{5} \int_0^{2\pi} \left[-\cos \phi + \frac{\cos^3 \phi}{3} \right]_0^{\pi/3} d\theta = \frac{8\pi}{3}$$

51. With the centers of the spheres at the origin, $I_z = \int_0^{2\pi} \int_0^\pi \int_a^b \delta(\rho \sin \phi)^2 (\rho^2 \sin \phi) d\rho d\phi d\theta$
 $= \frac{\delta(b^5 - a^5)}{5} \int_0^{2\pi} \int_0^\pi \sin^3 \phi d\phi d\theta = \frac{\delta(b^5 - a^5)}{5} \int_0^{2\pi} (\sin \phi - \cos^2 \phi \sin \phi) d\phi d\theta$
 $= \frac{\delta(b^5 - a^5)}{5} \int_0^{2\pi} \left[-\cos \phi + \frac{\cos^3 \phi}{3} \right]_0^\pi d\theta = \frac{4\delta(b^5 - a^5)}{15} \int_0^{2\pi} d\theta = \frac{8\pi\delta(b^5 - a^5)}{15}$

52. $I_z = \int_0^{2\pi} \int_0^\pi \int_0^{1-\cos \theta} (\rho \sin \phi)^2 (\rho^2 \sin \phi) d\rho d\phi d\theta = \int_0^{2\pi} \int_0^\pi \int_0^{1-\cos \theta} \rho^4 \sin^3 \phi d\rho d\phi d\theta$
 $= \frac{1}{5} \int_0^{2\pi} \int_0^\pi (1 - \cos \phi)^5 \sin^3 \phi d\phi d\theta = \int_0^{2\pi} \int_0^\pi (1 - \cos \phi)^6 (1 + \cos \phi) \sin \phi d\phi d\theta;$
 $\left[\begin{matrix} u = 1 - \cos \phi \\ du = \sin \phi d\phi \end{matrix} \right] \rightarrow \frac{1}{5} \int_0^{2\pi} \int_0^2 u^6 (2 - u) du d\theta = \frac{1}{5} \int_0^{2\pi} \left[\frac{2u^7}{7} - \frac{u^8}{8} \right]_0^2 d\theta = \frac{1}{5} \int_0^{2\pi} \left(\frac{1}{7} - \frac{1}{8} \right) 2^8 d\theta$
 $= \frac{1}{5} \int_0^{2\pi} \frac{2^3 \cdot 2^5}{56} d\theta = \frac{32}{35} \int_0^{2\pi} d\theta = \frac{64\pi}{35}$

53. $x = u + y$ and $y = v \Rightarrow x = u + v$ and $y = v$

$\Rightarrow J(u, v) = \begin{vmatrix} 1 & 1 \\ 0 & 1 \end{vmatrix} = 1$; the boundary of the

image G is obtained from the boundary of R as follows:

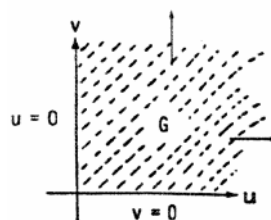
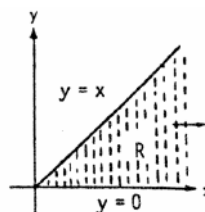

xy-equations for the boundary of R	Corresponding uv-equations for the boundary of G	Simplified uv-equations
$y = x$	$v = u + v$	$u = 0$
$y = 0$	$v = 0$	$v = 0$

$\Rightarrow \int_0^\infty \int_0^x e^{-sx} f(x - y, y) dy dx = \int_0^\infty \int_0^\infty e^{-s(u+v)} f(u, v) du dv$

54. If $s = \alpha x + \beta y$ and $t = \gamma x + \delta y$ where $(\alpha\delta - \beta\gamma)^2 = ac - b^2$, then $x = \frac{\delta s - \beta t}{\alpha\delta - \beta\gamma}$, $y = \frac{-\gamma s + \alpha t}{\alpha\delta - \beta\gamma}$,

and $J(s, t) = \frac{1}{(\alpha\delta - \beta\gamma)^2} \begin{vmatrix} \delta & -\beta \\ -\gamma & \alpha \end{vmatrix} = \frac{1}{\alpha\delta - \beta\gamma} \Rightarrow \int_{-\infty}^\infty \int_{-\infty}^\infty e^{-(s^2+t^2)} \frac{1}{\sqrt{ac-b^2}} ds dt$

$= \frac{1}{\sqrt{ac-b^2}} \int_0^{2\pi} \int_0^\infty r e^{-r^2} dr d\theta = \frac{1}{2\sqrt{ac-b^2}} \int_0^{2\pi} d\theta = \frac{\pi}{\sqrt{ac-b^2}}$. Therefore, $\frac{\pi}{\sqrt{ac-b^2}} = 1 \Rightarrow ac - b^2 = \pi^2$.

CHAPTER 15 ADDITIONAL AND ADVANCED EXERCISES

1. (a) $V = \int_{-3}^2 \int_x^{6-x^2} x^2 dy dx$ (b) $V = \int_{-3}^2 \int_x^{6-x^2} \int_0^{x^2} dz dy dx$

(c) $V = \int_{-3}^2 \int_x^{6-x^2} x^2 dy dx = \int_{-3}^2 \int_x^{6-x^2} (6x^2 - x^4 - x^3) dx = \left[2x^3 - \frac{x^5}{5} - \frac{x^4}{4} \right]_{-3}^2 = \frac{125}{4}$

2. Place the sphere's center at the origin with the surface of the water at $z = -3$. Then

$9 = 25 - x^2 - y^2 \Rightarrow x^2 + y^2 = 16$ is the projection of the volume of water onto the xy-plane

$$\begin{aligned} \Rightarrow V &= \int_0^{2\pi} \int_0^4 \int_{-\sqrt{25-r^2}}^{-3} dz r dr d\theta = \int_0^{2\pi} \int_0^4 (r\sqrt{25-r^2} - 3r) dr d\theta = \int_0^{2\pi} \left[-\frac{1}{3}(25-r^2)^{3/2} - \frac{3}{2}r^2 \right]_0^4 d\theta \\ &= \int_0^{2\pi} \left[-\frac{1}{3}(9)^{3/2} - 24 + \frac{1}{3}(25)^{3/2} \right] d\theta = \int_0^{2\pi} \frac{26}{3} d\theta = \frac{52\pi}{3} \end{aligned}$$

3. Using cylindrical coordinates, $V = \int_0^{2\pi} \int_0^1 \int_0^{2-r(\cos\theta+\sin\theta)} dz r dr d\theta = \int_0^{2\pi} \int_0^1 (2r - r^2 \cos\theta - r^2 \sin\theta) dr d\theta$
 $= \int_0^{2\pi} \left(1 - \frac{1}{3} \cos\theta - \frac{1}{3} \sin\theta\right) d\theta = \left[\theta - \frac{1}{3} \sin\theta + \frac{1}{3} \cos\theta\right]_0^{2\pi} = 2\pi$

4. $V = 4 \int_0^{\pi/2} \int_0^1 \int_{r^2}^{\sqrt{2-r^2}} dz r dr d\theta = 4 \int_0^{\pi/2} \int_0^1 (r\sqrt{2-r^2} - r^3) dr d\theta = 4 \int_0^{\pi/2} \left[-\frac{1}{3}(2-r^2)^{3/2} - \frac{r^4}{4} \right]_0^1 d\theta$
 $= 4 \int_0^{\pi/2} \left(-\frac{1}{3} - \frac{1}{4} + \frac{2\sqrt{2}}{3} \right) d\theta = \left(\frac{8\sqrt{2}-7}{3} \right) \int_0^{\pi/2} d\theta = \frac{\pi(8\sqrt{2}-7)}{6}$

5. The surfaces intersect when $3 - x^2 - y^2 = 2x^2 + 2y^2 \Rightarrow x^2 + y^2 = 1$. Thus the volume is

$$V = 4 \int_0^1 \int_0^{\sqrt{1-x^2}} \int_{2x^2+2y^2}^{3-x^2-y^2} dz dy dx = 4 \int_0^{\pi/2} \int_0^1 \int_{2r^2}^{3-r^2} dz r dr d\theta = 4 \int_0^{\pi/2} \int_0^1 (3r - 3r^3) dr d\theta = 3 \int_0^{\pi/2} d\theta = \frac{3\pi}{2}$$

6. $V = 8 \int_0^{\pi/2} \int_0^{\pi/2} \int_0^{2\sin\phi} \rho^2 \sin\phi d\rho d\phi d\theta = \frac{64}{3} \int_0^{\pi/2} \int_0^{\pi/2} \sin^4\phi d\phi d\theta$
 $= \frac{64}{3} \int_0^{\pi/2} \left[-\frac{\sin^3\phi \cos\phi}{4} \Big|_0^{\pi/2} + \frac{3}{4} \int_0^{\pi/2} \sin^2\phi d\phi \right] d\theta = 16 \int_0^{\pi/2} \left[\frac{\phi}{2} - \frac{\sin 2\phi}{4} \right]_0^{\pi/2} d\theta = 4\pi \int_0^{\pi/2} d\theta = 2\pi^2$

7. (a) The radius of the hole is 1, and the radius of the sphere is 2.

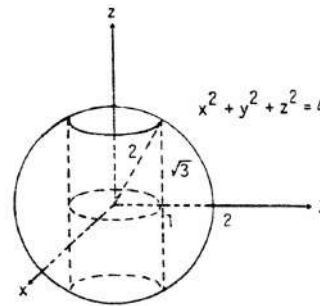

(b) $V = 2 \int_0^{2\pi} \int_0^{\sqrt{3}} \int_1^{\sqrt{4-z^2}} r dr dz d\theta = \int_0^{2\pi} \int_0^{\sqrt{3}} (3 - z^2) dz d\theta = 2\sqrt{3} \int_0^{2\pi} d\theta = 4\sqrt{3}\pi$

8. $V = \int_0^{\pi} \int_0^{3\sin\theta} \int_0^{\sqrt{9-r^2}} dz r dr d\theta = \int_0^{\pi} \int_0^{3\sin\theta} r\sqrt{9-r^2} dr d\theta = \int_0^{\pi} \left[-\frac{1}{3}(9-r^2)^{3/2} \right]_0^{3\sin\theta} d\theta$
 $= \int_0^{\pi} \left[-\frac{1}{3}(9-9\sin^2\theta)^{3/2} + \frac{1}{3}(9)^{3/2} \right] d\theta = 9 \int_0^{\pi} \left[1 - (1-\sin^2\theta)^{3/2} \right] d\theta = 9 \int_0^{\pi} (1 - \cos^3\theta) d\theta$
 $= \int_0^{\pi} (1 - \cos\theta + \sin^2\theta \cos\theta) d\theta = 9 \left[\theta - \sin\theta + \frac{\sin^3\theta}{3} \right]_0^{\pi} = 9\pi$

9. The surfaces intersect when $x^2 + y^2 = \frac{x^2+y^2+1}{2} \Rightarrow x^2 + y^2 = 1$. Thus the volume in cylindrical coordinates is

$$V = 4 \int_0^{\pi/2} \int_0^1 \int_{r^2}^{(r^2+1)/2} dz r dr d\theta = 4 \int_0^{\pi/2} \int_0^1 \left(\frac{r}{2} - \frac{r^3}{2} \right) dr d\theta = 4 \int_0^{\pi/2} \left[\frac{r^2}{4} - \frac{r^4}{8} \right]_0^1 d\theta$$

 $= \frac{1}{2} \int_0^{\pi/2} d\theta = \frac{\pi}{4}$

10. $V = \int_0^{\pi/2} \int_1^2 \int_0^{\sin\theta \cos\theta} dz r dr d\theta = \int_0^{\pi/2} \int_1^2 r^3 \sin\theta \cos\theta dr d\theta = \int_0^{\pi/2} \left[\frac{r^4}{4} \right]_1^2 \sin\theta \cos\theta d\theta$
 $= \frac{15}{4} \int_0^{\pi/2} \sin\theta \cos\theta d\theta = \frac{15}{4} \left[\frac{\sin^2\theta}{2} \right]_0^{\pi/2} = \frac{15}{8}$

$$\begin{aligned}
 11. \int_0^\infty \frac{e^{-ax} - e^{-bx}}{x} dx &= \int_0^\infty \int_a^b e^{-xy} dy dx = \int_a^b \int_0^\infty e^{-xy} dx dy = \int_a^b \left(\lim_{t \rightarrow \infty} \int_0^t e^{-xy} dx \right) dy \\
 &= \int_a^b \lim_{t \rightarrow \infty} \left[-\frac{e^{-xy}}{y} \right]_0^t dy = \int_a^b \lim_{t \rightarrow \infty} \left(\frac{1}{y} - \frac{e^{-yt}}{y} \right) dy = \int_a^b \frac{1}{y} dy = [\ln y]_a^b = \ln \left(\frac{b}{a} \right)
 \end{aligned}$$

12. (a) The region of integration is sketched at the right

$$\Rightarrow \int_0^{a \sin \beta} \int_{y \cot \beta}^{\sqrt{a^2 - y^2}} \ln(x^2 + y^2) dx dy$$

$$= \int_0^\beta \int_0^a r \ln(r^2) dr d\theta;$$

$$\left[\begin{array}{l} u = r^2 \\ du = 2r dr \end{array} \right] \rightarrow \frac{1}{2} \int_0^\beta \int_0^{a^2} \ln u du d\theta$$

$$= \frac{1}{2} \int_0^\beta [u \ln u - u]_0^{a^2} d\theta$$

$$= \frac{1}{2} \int_0^\beta [2a^2 \ln a - a^2 - \lim_{t \rightarrow 0} t \ln t] d\theta = \frac{a^2}{2} \int_0^\beta (2 \ln a - 1) d\theta = a^2 \beta \left(\ln a - \frac{1}{2} \right)$$

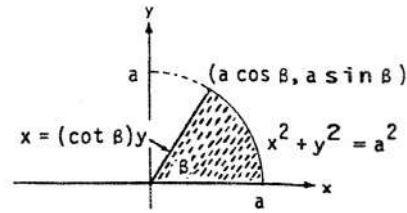

(b) $\int_0^{a \cos \beta} \int_0^{(\tan \beta)x} \ln(x^2 + y^2) dy dx + \int_{a \cos \beta}^a \int_0^{\sqrt{a^2 - x^2}} \ln(x^2 + y^2) dy dx$

$$\begin{aligned}
 13. \int_0^x \int_0^u e^{m(x-t)} f(t) dt du &= \int_0^x \int_t^x e^{m(x-t)} f(t) du dt = \int_0^x (x-t) e^{m(x-t)} f(t) dt; \text{ also} \\
 \int_0^x \int_0^v \int_0^u e^{m(x-t)} f(t) dt du dv &= \int_0^x \int_t^x \int_t^v e^{m(x-t)} f(t) du dv dt = \int_0^x \int_t^x (v-t) e^{m(x-t)} f(t) dv dt \\
 &= \int_0^x \left[\frac{1}{2} (v-t)^2 e^{m(x-t)} f(t) \right]_t^x dt = \int_0^x \frac{(x-t)^2}{2} e^{m(x-t)} f(t) dt
 \end{aligned}$$

$$\begin{aligned}
 14. \int_0^1 f(x) \left(\int_0^x g(x-y) f(y) dy \right) dx &= \int_0^1 \int_0^x g(x-y) f(x) f(y) dy dx \\
 &= \int_0^1 \int_y^1 g(x-y) f(x) f(y) dx dy = \int_0^1 f(y) \left(\int_y^1 g(x-y) f(x) dx \right) dy; \\
 \int_0^1 \int_0^1 g(|x-y|) f(x) f(y) dx dy &= \int_0^1 \int_0^x g(x-y) f(x) f(y) dy dx + \int_0^1 \int_x^1 g(y-x) f(x) f(y) dy dx \\
 &= \int_0^1 \int_y^1 g(x-y) f(x) f(y) dx dy + \int_0^1 \int_x^1 g(y-x) f(x) f(y) dy dx \\
 &= \int_0^1 \int_y^1 g(x-y) f(x) f(y) dx dy + \underbrace{\int_0^1 \int_y^1 g(x-y) f(y) f(x) dx dy}_{\text{simply interchange x and y variable names}} \\
 &= 2 \int_0^1 \int_y^1 g(x-y) f(x) f(y) dx dy, \text{ and the statement now follows.}
 \end{aligned}$$

$$\begin{aligned}
 15. I_0(a) &= \int_0^a \int_0^{x/a^2} (x^2 + y^2) dy dx = \int_0^a \left[x^2 y + \frac{y^3}{3} \right]_0^{x/a^2} dx = \int_0^a \left(\frac{x^3}{a^2} + \frac{x^3}{3a^6} \right) dx = \left[\frac{x^4}{4a^2} + \frac{x^4}{12a^6} \right]_0^a \\
 &= \frac{a^4}{4} + \frac{1}{12} a^{-2}; I_0'(a) = \frac{1}{2} a - \frac{1}{6} a^{-3} = 0 \Rightarrow a^4 = \frac{1}{3} \Rightarrow a = \sqrt[4]{\frac{1}{3}} = \frac{1}{\sqrt[4]{3}}. \text{ Since } I_0''(a) = \frac{1}{2} + \frac{1}{2} a^{-4} > 0, \text{ the} \\
 &\text{value of } a \text{ does provide a } \underline{\text{minimum}} \text{ for the polar moment of inertia } I_0(a).
 \end{aligned}$$

$$16. I_0 = \int_0^2 \int_{2x}^4 (x^2 + y^2) (3) dy dx = 3 \int_0^2 \left(4x^2 - \frac{14x^3}{3} + \frac{64}{3} \right) dx = 104$$

$$\begin{aligned}
 17. M &= \int_{-\theta}^{\theta} \int_{b \sec \theta}^a r \, dr \, d\theta = \int_{-\theta}^{\theta} \left(\frac{a^2}{2} - \frac{b^2}{2} \sec^2 \theta \right) d\theta \\
 &= a^2 \theta - b^2 \tan \theta = a^2 \cos^{-1} \left(\frac{b}{a} \right) - b^2 \left(\frac{\sqrt{a^2 - b^2}}{b} \right) \\
 &= a^2 \cos^{-1} \left(\frac{b}{a} \right) - b \sqrt{a^2 - b^2}; I_0 = \int_{-\theta}^{\theta} \int_{b \sec \theta}^a r^3 \, dr \, d\theta \\
 &= \frac{1}{4} \int_{-\theta}^{\theta} (a^4 + b^4 \sec^4 \theta) d\theta \\
 &= \frac{1}{4} \int_{-\theta}^{\theta} [a^4 + b^4 (1 + \tan^2 \theta) (\sec^2 \theta)] d\theta \\
 &= \frac{1}{4} \left[a^4 \theta - b^4 \tan \theta - \frac{b^4 \tan^3 \theta}{3} \right]_{-\theta}^{\theta} \\
 &= \frac{a^4 \theta}{2} - \frac{b^4 \tan \theta}{2} - \frac{b^4 \tan^3 \theta}{6} \\
 &= \frac{1}{2} a^4 \cos^{-1} \left(\frac{b}{a} \right) - \frac{1}{2} b^3 \sqrt{a^2 - b^2} - \frac{1}{6} b^3 (a^2 - b^2)^{3/2}
 \end{aligned}$$

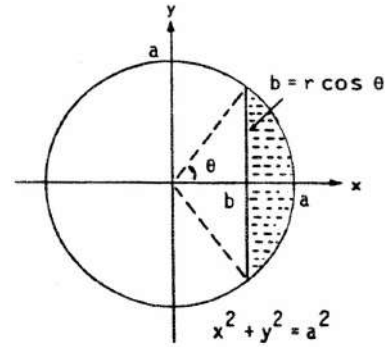

$$\begin{aligned}
 18. M &= \int_{-2}^2 \int_{1-(y^2/4)}^{2-(y^2/2)} dx \, dy = \int_{-2}^2 \left(1 - \frac{y^2}{4} \right) dy = \left[y - \frac{y^3}{12} \right]_{-2}^2 = \frac{8}{3}; M_y = \int_{-2}^2 \int_{1-(y^2/4)}^{2-(y^2/2)} x \, dx \, dy \\
 &= \int_{-2}^2 \left[\frac{x^2}{2} \right]_{1-(y^2/4)}^{2-(y^2/2)} dy = \int_{-2}^2 \frac{3}{32} (4 - y^2) dy = \frac{3}{32} \int_{-2}^2 (16 - 8y^2 + y^4) dy = \frac{3}{16} \left[16y - \frac{8y^3}{3} + \frac{y^5}{5} \right]_0^2 \\
 &= \frac{3}{16} \left(32 - \frac{64}{3} + \frac{32}{5} \right) = \left(\frac{3}{16} \right) \left(\frac{32 \cdot 8}{15} \right) = \frac{48}{15} \Rightarrow \bar{x} = \frac{M_y}{M} = \left(\frac{48}{15} \right) \left(\frac{3}{8} \right) = \frac{6}{5}, \text{ and } \bar{y} = 0 \text{ by symmetry}
 \end{aligned}$$

$$\begin{aligned}
 19. \int_0^a \int_0^b e^{\max(b^2x^2, a^2y^2)} \, dy \, dx &= \int_0^a \int_0^{bx/a} e^{b^2x^2} \, dy \, dx + \int_0^b \int_0^{ay/b} e^{a^2y^2} \, dx \, dy \\
 &= \int_0^a \left(\frac{b}{a} x \right) e^{b^2x^2} \, dx + \int_0^b \left(\frac{a}{b} y \right) e^{a^2y^2} \, dy = \left[\frac{1}{2ab} e^{b^2x^2} \right]_0^a + \left[\frac{1}{2ba} e^{a^2y^2} \right]_0^b = \frac{1}{2ab} (e^{b^2a^2} - 1) + \frac{1}{2ab} (e^{a^2b^2} - 1) \\
 &= \frac{1}{ab} (e^{a^2b^2} - 1)
 \end{aligned}$$

$$\begin{aligned}
 20. \int_{y_0}^{y_1} \int_{x_0}^{x_1} \frac{\partial^2 F(x,y)}{\partial x \partial y} \, dx \, dy &= \int_{y_0}^{y_1} \left[\frac{\partial F(x,y)}{\partial y} \right]_{x_0}^{x_1} dy = \int_{y_0}^{y_1} \left[\frac{\partial F(x_1,y)}{\partial y} - \frac{\partial F(x_0,y)}{\partial y} \right] dx = [F(x_1, y) - F(x_0, y)]_{y_0}^{y_1} \\
 &= F(x_1, y_1) - F(x_0, y_1) - F(x_1, y_0) + F(x_0, y_0)
 \end{aligned}$$

21. (a) (i) Fubini's Theorem
 (ii) Treating $G(y)$ as a constant
 (iii) Algebraic rearrangement
 (iv) The definite integral is a constant number

$$(b) \int_0^{\ln 2} \int_0^{\pi/2} e^x \cos y \, dy \, dx = \left(\int_0^{\ln 2} e^x \, dx \right) \left(\int_0^{\pi/2} \cos y \, dy \right) = (e^{\ln 2} - e^0) (\sin \frac{\pi}{2} - \sin 0) = (1)(1) = 1$$

$$(c) \int_1^2 \int_{-1}^1 \frac{x}{y^2} \, dx \, dy = \left(\int_1^2 \frac{1}{y^2} \, dy \right) \left(\int_{-1}^1 x \, dx \right) = \left[-\frac{1}{y} \right]_1^2 \left[\frac{x^2}{2} \right]_{-1}^1 = \left(-\frac{1}{2} + 1 \right) \left(\frac{1}{2} - \frac{1}{2} \right) = 0$$

22. (a) $\nabla f = x\mathbf{i} + y\mathbf{j} \Rightarrow D_u f = u_1 x + u_2 y$; the area of the region of integration is $\frac{1}{2}$

$$\begin{aligned}
 \Rightarrow \text{average} &= 2 \int_0^1 \int_0^{1-x} (u_1 x + u_2 y) \, dy \, dx = 2 \int_0^1 \left[u_1 x(1-x) + \frac{1}{2} u_2 (1-x)^2 \right] dx \\
 &= 2 \left[u_1 \left(\frac{x^2}{2} - \frac{x^3}{3} \right) - \left(\frac{1}{2} u_2 \right) \left(\frac{1-x^3}{3} \right) \right]_0^1 = 2 \left(\frac{1}{6} u_1 + \frac{1}{6} u_2 \right) = \frac{1}{3} (u_1 + u_2)
 \end{aligned}$$

$$(b) \text{average} = \frac{1}{\text{area}} \iint_R (u_1 x + u_2 y) \, dA = \frac{u_1}{\text{area}} \iint_R x \, dA + \frac{u_2}{\text{area}} \iint_R y \, dA = u_1 \left(\frac{M_y}{M} \right) + u_2 \left(\frac{M_x}{M} \right) = u_1 \bar{x} + u_2 \bar{y}$$

$$\begin{aligned}
 23. (a) I^2 &= \int_0^\infty \int_0^\infty e^{-(x^2+y^2)} \, dx \, dy = \int_0^{\pi/2} \int_0^\infty (e^{-r^2}) r \, dr \, d\theta = \int_0^{\pi/2} \left[\lim_{b \rightarrow \infty} \int_0^b r e^{-r^2} \, dr \right] d\theta \\
 &= -\frac{1}{2} \int_0^{\pi/2} \lim_{b \rightarrow \infty} (e^{-b^2} - 1) \, d\theta = \frac{1}{2} \int_0^{\pi/2} d\theta = \frac{\pi}{4} \Rightarrow I = \frac{\sqrt{\pi}}{2}
 \end{aligned}$$

$$(b) \Gamma \left(\frac{1}{2} \right) = \int_0^\infty t^{-1/2} e^{-t} \, dt = \int_0^\infty (y^2)^{-1/2} e^{-y^2} (2y) \, dy = 2 \int_0^\infty e^{-y^2} \, dy = 2 \left(\frac{\sqrt{\pi}}{2} \right) = \sqrt{\pi}, \text{ where } y = \sqrt{t}$$

24. $Q = \int_0^{2\pi} \int_0^R kr^2(1 - \sin \theta) dr d\theta = \frac{kR^3}{3} \int_0^{2\pi} (1 - \sin \theta) d\theta = \frac{kR^3}{3} [\theta + \cos \theta]_0^{2\pi} = \frac{2\pi kR^3}{3}$

25. For a height h in the bowl the volume of water is $V = \int_{-\sqrt{h}}^{\sqrt{h}} \int_{-\sqrt{h-x^2}}^{\sqrt{h-x^2}} \int_{x^2+y^2}^h dz dy dx$
 $= \int_{-\sqrt{h}}^{\sqrt{h}} \int_{-\sqrt{h-x^2}}^{\sqrt{h-x^2}} (h - x^2 - y^2) dy dx = \int_0^{2\pi} \int_0^{\sqrt{h}} (h - r^2) r dr d\theta = \int_0^{2\pi} \left[\frac{hr^2}{2} - \frac{r^4}{4} \right]_0^{\sqrt{h}} d\theta = \int_0^{2\pi} \frac{h^2}{4} d\theta = \frac{h^2\pi}{2}$.

Since the top of the bowl has area 10π , then we calibrate the bowl by comparing it to a right circular cylinder whose cross sectional area is 10π from $z = 0$ to $z = 10$. If such a cylinder contains $\frac{h^2\pi}{2}$ cubic inches of water to a depth w then we have $10\pi w = \frac{h^2\pi}{2} \Rightarrow w = \frac{h^2}{20}$. So for 1 inch of rain, $w = 1$ and $h = \sqrt{20}$; for 3 inches of rain, $w = 3$ and $h = \sqrt{60}$.

26. (a) An equation for the satellite dish in standard position is $z = \frac{1}{2}x^2 + \frac{1}{2}y^2$. Since the axis is tilted 30° , a unit vector $\mathbf{v} = 0\mathbf{i} + a\mathbf{j} + b\mathbf{k}$ normal to the plane of the

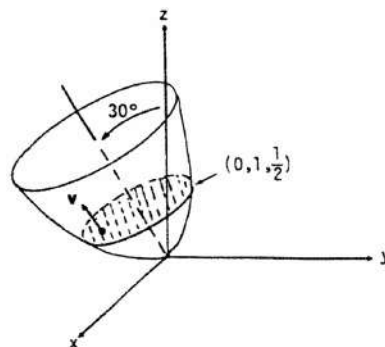

water level satisfies $b = \mathbf{v} \cdot \mathbf{k} = \cos\left(\frac{\pi}{6}\right) = \frac{\sqrt{3}}{2}$
 $\Rightarrow a = -\sqrt{1 - b^2} = -\frac{1}{2} \Rightarrow \mathbf{v} = -\frac{1}{2}\mathbf{j} + \frac{\sqrt{3}}{2}\mathbf{k}$
 $\Rightarrow -\frac{1}{2}(y - 1) + \frac{\sqrt{3}}{2}(z - \frac{1}{2}) = 0$
 $\Rightarrow z = \frac{1}{\sqrt{3}}y + \left(\frac{1}{2} - \frac{1}{\sqrt{3}}\right)$

is an equation of the plane of the water level. Therefore

the volume of water is $V = \iint_R \int_{\frac{1}{2}x^2 + \frac{1}{2}y^2}^{\frac{1}{\sqrt{3}}y + \frac{1}{2} - \frac{1}{\sqrt{3}}} dz dy dx$, where R is the interior of the ellipse

$x^2 + y^2 - \frac{2}{3}y - 1 + \frac{2}{\sqrt{3}} = 0$. When $x = 0$, then $y = \alpha$ or $y = \beta$, where $\alpha = \frac{\frac{2}{3} + \sqrt{\frac{4}{9} - 4\left(\frac{2}{\sqrt{3}} - 1\right)}}{2}$

and $\beta = \frac{\frac{2}{3} - \sqrt{\frac{4}{9} - 4\left(\frac{2}{\sqrt{3}} - 1\right)}}{2} \Rightarrow V = \int_{\alpha}^{\beta} \int_{-\left(\frac{2}{3}y + 1 - \frac{2}{\sqrt{3}} - y^2\right)^{1/2}}^{\left(\frac{2}{3}y + 1 - \frac{2}{\sqrt{3}} - y^2\right)^{1/2}} \int_{\frac{1}{2}x^2 + \frac{1}{2}y^2}^{\frac{1}{\sqrt{3}}y + \frac{1}{2} - \frac{1}{\sqrt{3}}} 1 dz dx dy$

(b) $x = 0 \Rightarrow z = \frac{1}{2}y^2$ and $\frac{dz}{dy} = y$; $y = 1 \Rightarrow \frac{dz}{dy} = 1 \Rightarrow$ the tangent line has slope 1 or a 45° slant
 \Rightarrow at 45° and thereafter, the dish will not hold water.

27. The cylinder is given by $x^2 + y^2 = 1$ from $z = 1$ to $\infty \Rightarrow \iiint_D z(r^2 + z^2)^{-5/2} dV$

$= \int_0^{2\pi} \int_0^1 \int_1^{\infty} \frac{z}{(r^2 + z^2)^{5/2}} dz r dr d\theta = a \lim_{a \rightarrow \infty} \int_0^{2\pi} \int_0^1 \int_1^a \frac{rz}{(r^2 + z^2)^{5/2}} dz dr d\theta$
 $= a \lim_{a \rightarrow \infty} \int_0^{2\pi} \int_0^1 \left[\left(-\frac{1}{3}\right) \frac{r}{(r^2 + z^2)^{3/2}} \right]_1^a dr d\theta = a \lim_{a \rightarrow \infty} \int_0^{2\pi} \int_0^1 \left[\left(-\frac{1}{3}\right) \frac{r}{(r^2 + a^2)^{3/2}} + \left(\frac{1}{3}\right) \frac{r}{(r^2 + 1)^{3/2}} \right] dr d\theta$
 $= a \lim_{a \rightarrow \infty} \int_0^{2\pi} \left[\frac{1}{3} (r^2 + a^2)^{-1/2} - \frac{1}{3} (r^2 + 1)^{-1/2} \right]_0^1 d\theta = a \lim_{a \rightarrow \infty} \int_0^{2\pi} \left[\frac{1}{3} (1 + a^2)^{-1/2} - \frac{1}{3} (2^{-1/2}) - \frac{1}{3} (a^2)^{-1/2} + \frac{1}{3} \right] d\theta$
 $= a \lim_{a \rightarrow \infty} 2\pi \left[\frac{1}{3} (1 + a^2)^{-1/2} - \frac{1}{3} \left(\frac{\sqrt{2}}{2}\right) - \frac{1}{3} \left(\frac{1}{a}\right) + \frac{1}{3} \right] = 2\pi \left[\frac{1}{3} - \left(\frac{1}{3}\right) \frac{\sqrt{2}}{2} \right]$.

28. Let's see?

The length of the "unit" line segment is: $L = 2 \int_0^1 dx = 2$.

The area of the unit circle is: $A = 4 \int_0^1 \int_0^{\sqrt{1-x^2}} dy dx = \pi$.

The volume of the unit sphere is: $V = 8 \int_0^1 \int_0^{\sqrt{1-x^2}} \int_0^{\sqrt{1-x^2-y^2}} dz dy dx = \frac{4}{3}\pi$.

Therefore, the hypervolume of the unit 4-sphere should be:

$$V_{\text{hyper}} = 16 \int_0^1 \int_0^{\sqrt{1-x^2}} \int_0^{\sqrt{1-x^2-y^2}} \int_0^{\sqrt{1-x^2-y^2-z^2}} dw dz dy dx.$$

Mathematica is able to handle this integral, but we'll use the brute force approach.

$$\begin{aligned}
V_{\text{hyper}} &= 16 \int_0^1 \int_0^{\sqrt{1-x^2}} \int_0^{\sqrt{1-x^2-y^2}} \int_0^{\sqrt{1-x^2-y^2-z^2}} dw \, dz \, dy \, dx = 16 \int_0^1 \int_0^{\sqrt{1-x^2}} \int_0^{\sqrt{1-x^2-y^2}} \sqrt{1-x^2-y^2-z^2} \, dz \, dy \, dx \\
&= 16 \int_0^1 \int_0^{\sqrt{1-x^2}} \int_0^{\sqrt{1-x^2-y^2}} \sqrt{1-x^2-y^2} \sqrt{1-\frac{z^2}{1-x^2-y^2}} \, dz \, dy \, dx = \left[\begin{array}{l} \frac{z}{\sqrt{1-x^2-y^2}} = \cos \theta \\ dz = -\sqrt{1-x^2-y^2} \sin \theta \, d\theta \end{array} \right] \\
&= 16 \int_0^1 \int_0^{\sqrt{1-x^2}} (1-x^2-y^2) \int_{\pi/2}^0 -\sqrt{1-\cos^2 \theta} \sin \theta \, d\theta \, dy \, dx = 16 \int_0^1 \int_0^{\sqrt{1-x^2}} (1-x^2-y^2) \int_{\pi/2}^0 -\sin^2 \theta \, d\theta \, dy \, dx \\
&= 16 \int_0^1 \int_0^{\sqrt{1-x^2}} \frac{\pi}{4} (1-x^2-y^2) \, dy \, dx = 4\pi \int_0^1 \left(\sqrt{1-x^2} - x^2 \sqrt{1-x^2} - \frac{1}{3} (1-x^2)^{3/2} \right) dx \\
&= 4\pi \int_0^1 \sqrt{1-x^2} \left[(1-x^2) - \frac{1-x^3}{3} \right] dx = \frac{8}{3}\pi \int_0^1 (1-x^2)^{3/2} dx = \left[\begin{array}{l} x = \cos \theta \\ dx = -\sin \theta \, d\theta \end{array} \right] = -\frac{8}{3}\pi \int_{\pi/2}^0 \sin^4 \theta \, d\theta \\
&= -\frac{8}{3}\pi \int_{\pi/2}^0 \left(\frac{1-\cos 2\theta}{2} \right)^2 d\theta = -\frac{2}{3}\pi \int_{\pi/2}^0 (1-2\cos 2\theta + \cos^2 2\theta) d\theta = -\frac{2}{3}\pi \int_{\pi/2}^0 \left(\frac{3}{2} - 2\cos 2\theta + \frac{\cos 4\theta}{2} \right) d\theta = \frac{\pi^2}{2}
\end{aligned}$$

CHAPTER 16 INTEGRATION IN VECTOR FIELDS

16.1 LINE INTEGRALS

- $\mathbf{r} = t\mathbf{i} + (1-t)\mathbf{j} \Rightarrow x = t$ and $y = 1-t \Rightarrow y = 1-x \Rightarrow$ (c)
- $\mathbf{r} = \mathbf{i} + \mathbf{j} + t\mathbf{k} \Rightarrow x = 1, y = 1,$ and $z = t \Rightarrow$ (e)
- $\mathbf{r} = (2 \cos t)\mathbf{i} + (2 \sin t)\mathbf{j} \Rightarrow x = 2 \cos t$ and $y = 2 \sin t \Rightarrow x^2 + y^2 = 4 \Rightarrow$ (g)
- $\mathbf{r} = t\mathbf{i} \Rightarrow x = t, y = 0,$ and $z = 0 \Rightarrow$ (a)
- $\mathbf{r} = t\mathbf{i} + t\mathbf{j} + t\mathbf{k} \Rightarrow x = t, y = t,$ and $z = t \Rightarrow$ (d)
- $\mathbf{r} = t\mathbf{j} + (2-2t)\mathbf{k} \Rightarrow y = t$ and $z = 2-2t \Rightarrow z = 2-2y \Rightarrow$ (b)
- $\mathbf{r} = (t^2-1)\mathbf{j} + 2t\mathbf{k} \Rightarrow y = t^2-1$ and $z = 2t \Rightarrow y = \frac{z^2}{4}-1 \Rightarrow$ (f)
- $\mathbf{r} = (2 \cos t)\mathbf{i} + (2 \sin t)\mathbf{k} \Rightarrow x = 2 \cos t$ and $z = 2 \sin t \Rightarrow x^2 + z^2 = 4 \Rightarrow$ (h)
- $\mathbf{r}(t) = t\mathbf{i} + (1-t)\mathbf{j}, 0 \leq t \leq 1 \Rightarrow \frac{d\mathbf{r}}{dt} = \mathbf{i} - \mathbf{j} \Rightarrow \left| \frac{d\mathbf{r}}{dt} \right| = \sqrt{2}\mathbf{j}; x = t$ and $y = 1-t \Rightarrow x + y = t + (1-t) = 1$
 $\Rightarrow \int_C f(x, y, z) ds = \int_0^1 f(t, 1-t, 0) \left| \frac{d\mathbf{r}}{dt} \right| dt = \int_0^1 (1) (\sqrt{2}) dt = \left[\sqrt{2}t \right]_0^1 = \sqrt{2}$
- $\mathbf{r}(t) = t\mathbf{i} + (1-t)\mathbf{j} + \mathbf{k}, 0 \leq t \leq 1 \Rightarrow \frac{d\mathbf{r}}{dt} = \mathbf{i} - \mathbf{j} \Rightarrow \left| \frac{d\mathbf{r}}{dt} \right| = \sqrt{2}; x = t, y = 1-t,$ and $z = 1 \Rightarrow x - y + z - 2$
 $= t - (1-t) + 1 - 2 = 2t - 2 \Rightarrow \int_C f(x, y, z) ds = \int_0^1 (2t-2) \sqrt{2} dt = \sqrt{2} [t^2 - 2t]_0^1 = -\sqrt{2}$
- $\mathbf{r}(t) = 2t\mathbf{i} + t\mathbf{j} + (2-2t)\mathbf{k}, 0 \leq t \leq 1 \Rightarrow \frac{d\mathbf{r}}{dt} = 2\mathbf{i} + \mathbf{j} - 2\mathbf{k} \Rightarrow \left| \frac{d\mathbf{r}}{dt} \right| = \sqrt{4+1+4} = 3; xy + y + z$
 $= (2t)t + t + (2-2t) \Rightarrow \int_C f(x, y, z) ds = \int_0^1 (2t^2 - t + 2) 3 dt = 3 \left[\frac{2}{3}t^3 - \frac{1}{2}t^2 + 2t \right]_0^1 = 3 \left(\frac{2}{3} - \frac{1}{2} + 2 \right) = \frac{13}{2}$
- $\mathbf{r}(t) = (4 \cos t)\mathbf{i} + (4 \sin t)\mathbf{j} + 3t\mathbf{k}, -2\pi \leq t \leq 2\pi \Rightarrow \frac{d\mathbf{r}}{dt} = (-4 \sin t)\mathbf{i} + (4 \cos t)\mathbf{j} + 3\mathbf{k}$
 $\Rightarrow \left| \frac{d\mathbf{r}}{dt} \right| = \sqrt{16 \sin^2 t + 16 \cos^2 t + 9} = 5; \sqrt{x^2 + y^2} = \sqrt{16 \cos^2 t + 16 \sin^2 t} = 4 \Rightarrow \int_C f(x, y, z) ds = \int_{-2\pi}^{2\pi} (4)(5) dt$
 $= [20t]_{-2\pi}^{2\pi} = 80\pi$
- $\mathbf{r}(t) = (\mathbf{i} + 2\mathbf{j} + 3\mathbf{k}) + t(-\mathbf{i} - 3\mathbf{j} - 2\mathbf{k}) = (1-t)\mathbf{i} + (2-3t)\mathbf{j} + (3-2t)\mathbf{k}, 0 \leq t \leq 1 \Rightarrow \frac{d\mathbf{r}}{dt} = -\mathbf{i} - 3\mathbf{j} - 2\mathbf{k}$
 $\Rightarrow \left| \frac{d\mathbf{r}}{dt} \right| = \sqrt{1+9+4} = \sqrt{14}; x + y + z = (1-t) + (2-3t) + (3-2t) = 6-6t \Rightarrow \int_C f(x, y, z) ds$
 $= \int_0^1 (6-6t) \sqrt{14} dt = 6\sqrt{14} \left[t - \frac{t^2}{2} \right]_0^1 = \left(6\sqrt{14} \right) \left(\frac{1}{2} \right) = 3\sqrt{14}$
- $\mathbf{r}(t) = t\mathbf{i} + t\mathbf{j} + t\mathbf{k}, 1 \leq t \leq \infty \Rightarrow \frac{d\mathbf{r}}{dt} = \mathbf{i} + \mathbf{j} + \mathbf{k} \Rightarrow \left| \frac{d\mathbf{r}}{dt} \right| = \sqrt{3}; \frac{\sqrt{3}}{x^2+y^2+z^2} = \frac{\sqrt{3}}{t^2+t^2+t^2} = \frac{\sqrt{3}}{3t^2}$
 $\Rightarrow \int_C f(x, y, z) ds = \int_1^\infty \left(\frac{\sqrt{3}}{3t^2} \right) \sqrt{3} dt = \left[-\frac{1}{t} \right]_1^\infty = \lim_{b \rightarrow \infty} \left(-\frac{1}{b} + 1 \right) = 1$

$$15. \mathbf{C}_1: \mathbf{r}(t) = t\mathbf{i} + t^2\mathbf{j}, 0 \leq t \leq 1 \Rightarrow \frac{d\mathbf{r}}{dt} = \mathbf{i} + 2t\mathbf{j} \Rightarrow \left| \frac{d\mathbf{r}}{dt} \right| = \sqrt{1 + 4t^2}; x + \sqrt{y} - z^2 = t + \sqrt{t^2} - 0 = t + |t| = 2t$$

$$\text{since } t \geq 0 \Rightarrow \int_{\mathbf{C}_1} f(x, y, z) \, ds = \int_0^1 2t\sqrt{1 + 4t^2} \, dt = \left[\frac{1}{6} (1 + 4t^2)^{3/2} \right]_0^1 = \frac{1}{6} (5)^{3/2} - \frac{1}{6} = \frac{1}{6} (5\sqrt{5} - 1);$$

$$\mathbf{C}_2: \mathbf{r}(t) = \mathbf{i} + \mathbf{j} + t\mathbf{k}, 0 \leq t \leq 1 \Rightarrow \frac{d\mathbf{r}}{dt} = \mathbf{k} \Rightarrow \left| \frac{d\mathbf{r}}{dt} \right| = 1; x + \sqrt{y} - z^2 = 1 + \sqrt{1} - t^2 = 2 - t^2$$

$$\Rightarrow \int_{\mathbf{C}_2} f(x, y, z) \, ds = \int_0^1 (2 - t^2)(1) \, dt = \left[2t - \frac{1}{3}t^3 \right]_0^1 = 2 - \frac{1}{3} = \frac{5}{3}; \text{ therefore } \int_{\mathbf{C}} f(x, y, z) \, ds$$

$$= \int_{\mathbf{C}_1} f(x, y, z) \, ds + \int_{\mathbf{C}_2} f(x, y, z) \, ds = \frac{5}{6}\sqrt{5} + \frac{5}{3}$$

$$16. \mathbf{C}_1: \mathbf{r}(t) = t\mathbf{k}, 0 \leq t \leq 1 \Rightarrow \frac{d\mathbf{r}}{dt} = \mathbf{k} \Rightarrow \left| \frac{d\mathbf{r}}{dt} \right| = 1; x + \sqrt{y} - z^2 = 0 + \sqrt{0} - t^2 = -t^2$$

$$\Rightarrow \int_{\mathbf{C}_1} f(x, y, z) \, ds = \int_0^1 (-t^2)(1) \, dt = \left[-\frac{t^3}{3} \right]_0^1 = -\frac{1}{3};$$

$$\mathbf{C}_2: \mathbf{r}(t) = t\mathbf{j} + \mathbf{k}, 0 \leq t \leq 1 \Rightarrow \frac{d\mathbf{r}}{dt} = \mathbf{j} \Rightarrow \left| \frac{d\mathbf{r}}{dt} \right| = 1; x + \sqrt{y} - z^2 = 0 + \sqrt{t} - 1 = \sqrt{t} - 1$$

$$\Rightarrow \int_{\mathbf{C}_2} f(x, y, z) \, ds = \int_0^1 (\sqrt{t} - 1)(1) \, dt = \left[\frac{2}{3}t^{3/2} - t \right]_0^1 = \frac{2}{3} - 1 = -\frac{1}{3};$$

$$\mathbf{C}_3: \mathbf{r}(t) = t\mathbf{i} + \mathbf{j} + \mathbf{k}, 0 \leq t \leq 1 \Rightarrow \frac{d\mathbf{r}}{dt} = \mathbf{i} \Rightarrow \left| \frac{d\mathbf{r}}{dt} \right| = 1; x + \sqrt{y} - z^2 = t + \sqrt{1} - 1 = t$$

$$\Rightarrow \int_{\mathbf{C}_3} f(x, y, z) \, ds = \int_0^1 (t)(1) \, dt = \left[\frac{t^2}{2} \right]_0^1 = \frac{1}{2} \Rightarrow \int_{\mathbf{C}} f(x, y, z) \, ds = \int_{\mathbf{C}_1} f \, ds + \int_{\mathbf{C}_2} f \, ds + \int_{\mathbf{C}_3} f \, ds = -\frac{1}{3} + \left(-\frac{1}{3}\right) + \frac{1}{2} = -\frac{1}{6}$$

$$17. \mathbf{r}(t) = t\mathbf{i} + t\mathbf{j} + t\mathbf{k}, 0 < a \leq t \leq b \Rightarrow \frac{d\mathbf{r}}{dt} = \mathbf{i} + \mathbf{j} + \mathbf{k} \Rightarrow \left| \frac{d\mathbf{r}}{dt} \right| = \sqrt{3}; \frac{x+y+z}{x^2+y^2+z^2} = \frac{t+t+t}{t^2+t^2+t^2} = \frac{1}{t}$$

$$\Rightarrow \int_{\mathbf{C}} f(x, y, z) \, ds = \int_a^b \left(\frac{1}{t}\right) \sqrt{3} \, dt = \left[\sqrt{3} \ln |t| \right]_a^b = \sqrt{3} \ln \left(\frac{b}{a}\right), \text{ since } 0 < a \leq b$$

$$18. \mathbf{r}(t) = (a \cos t)\mathbf{j} + (a \sin t)\mathbf{k}, 0 \leq t \leq 2\pi \Rightarrow \frac{d\mathbf{r}}{dt} = (-a \sin t)\mathbf{j} + (a \cos t)\mathbf{k} \Rightarrow \left| \frac{d\mathbf{r}}{dt} \right| = \sqrt{a^2 \sin^2 t + a^2 \cos^2 t} = |a|;$$

$$-\sqrt{x^2 + z^2} = -\sqrt{0 + a^2 \sin^2 t} = \begin{cases} -|a| \sin t, & 0 \leq t \leq \pi \\ |a| \sin t, & \pi \leq t \leq 2\pi \end{cases} \Rightarrow \int_{\mathbf{C}} f(x, y, z) \, ds = \int_0^\pi -|a|^2 \sin t \, dt + \int_\pi^{2\pi} |a|^2 \sin t \, dt$$

$$= [a^2 \cos t]_0^\pi - [a^2 \cos t]_\pi^{2\pi} = [a^2(-1) - a^2] - [a^2 - a^2(-1)] = -4a^2$$

$$19. \mathbf{r}(x) = x\mathbf{i} + y\mathbf{j} = x\mathbf{i} + \frac{x^2}{2}\mathbf{j}, 0 \leq x \leq 2 \Rightarrow \frac{d\mathbf{r}}{dx} = \mathbf{i} + x\mathbf{j} \Rightarrow \left| \frac{d\mathbf{r}}{dx} \right| = \sqrt{1 + x^2}; f(x, y) = f\left(x, \frac{x^2}{2}\right) = \frac{x^3}{\left(\frac{x^2}{2}\right)} = 2x \Rightarrow \int_{\mathbf{C}} f \, ds$$

$$= \int_0^2 (2x)\sqrt{1 + x^2} \, dx = \left[\frac{2}{3} (1 + x^2)^{3/2} \right]_0^2 = \frac{2}{3} (5^{3/2} - 1) = \frac{10\sqrt{5} - 2}{3}$$

$$20. \mathbf{r}(t) = (1 - t)\mathbf{i} + \frac{1}{2}(1 - t)^2\mathbf{j}, 0 \leq t \leq 1 \Rightarrow \left| \frac{d\mathbf{r}}{dt} \right| = \sqrt{1 + (1 - t)^2}; f(x, y) = f\left((1 - t), \frac{1}{2}(1 - t)^2\right) = \frac{(1 - t) + \frac{1}{4}(1 - t)^4}{\sqrt{1 + (1 - t)^2}}$$

$$\Rightarrow \int_{\mathbf{C}} f \, ds = \int_0^1 \frac{(1 - t) + \frac{1}{4}(1 - t)^4}{\sqrt{1 + (1 - t)^2}} \sqrt{1 + (1 - t)^2} \, dt = \int_0^1 \left((1 - t) + \frac{1}{4}(1 - t)^4 \right) \, dt = \left[-\frac{1}{2}(1 - t)^2 - \frac{1}{20}(1 - t)^5 \right]_0^1$$

$$= 0 - \left(-\frac{1}{2} - \frac{1}{20}\right) = \frac{11}{20}$$

$$21. \mathbf{r}(t) = (2 \cos t)\mathbf{i} + (2 \sin t)\mathbf{j}, 0 \leq t \leq \frac{\pi}{2} \Rightarrow \frac{d\mathbf{r}}{dt} = (-2 \sin t)\mathbf{i} + (2 \cos t)\mathbf{j} \Rightarrow \left| \frac{d\mathbf{r}}{dt} \right| = 2; f(x, y) = f(2 \cos t, 2 \sin t)$$

$$= 2 \cos t + 2 \sin t \Rightarrow \int_{\mathbf{C}} f \, ds = \int_0^{\pi/2} (2 \cos t + 2 \sin t)(2) \, dt = [4 \sin t - 4 \cos t]_0^{\pi/2} = 4 - (-4) = 8$$

$$22. \mathbf{r}(t) = (2 \sin t)\mathbf{i} + (2 \cos t)\mathbf{j}, 0 \leq t \leq \frac{\pi}{4} \Rightarrow \frac{d\mathbf{r}}{dt} = (2 \cos t)\mathbf{i} + (-2 \sin t)\mathbf{j} \Rightarrow \left| \frac{d\mathbf{r}}{dt} \right| = 2; f(x, y) = f(2 \sin t, 2 \cos t)$$

$$= 4 \sin^2 t - 2 \cos t \Rightarrow \int_{\mathbf{C}} f \, ds = \int_0^{\pi/4} (4 \sin^2 t - 2 \cos t)(2) \, dt = [4t - 2 \sin 2t - 4 \sin t]_0^{\pi/4}$$

$$= \pi - 2(1 + \sqrt{2})$$

$$23. \mathbf{r}(t) = (t^2 - 1)\mathbf{j} + 2t\mathbf{k}, 0 \leq t \leq 1 \Rightarrow \frac{d\mathbf{r}}{dt} = 2t\mathbf{j} + 2\mathbf{k} \Rightarrow \left| \frac{d\mathbf{r}}{dt} \right| = 2\sqrt{t^2 + 1}; M = \int_C \delta(x, y, z) ds = \int_0^1 \delta(t) (2\sqrt{t^2 + 1}) dt \\ = \int_0^1 \left(\frac{3}{2}t\right) (2\sqrt{t^2 + 1}) dt = \left[(t^2 + 1)^{3/2} \right]_0^1 = 2^{3/2} - 1 = 2\sqrt{2} - 1$$

$$24. \mathbf{r}(t) = (t^2 - 1)\mathbf{j} + 2t\mathbf{k}, -1 \leq t \leq 1 \Rightarrow \frac{d\mathbf{r}}{dt} = 2t\mathbf{j} + 2\mathbf{k} \\ \Rightarrow \left| \frac{d\mathbf{r}}{dt} \right| = 2\sqrt{t^2 + 1}; M = \int_C \delta(x, y, z) ds \\ = \int_{-1}^1 (15\sqrt{t^2 - 1} + 2) (2\sqrt{t^2 + 1}) dt \\ = \int_{-1}^1 30(t^2 + 1) dt = \left[30 \left(\frac{t^3}{3} + t \right) \right]_{-1}^1 = 60 \left(\frac{1}{3} + 1 \right) = 80; \\ M_{xz} = \int_C y \delta(x, y, z) ds = \int_{-1}^1 (t^2 - 1) [30(t^2 + 1)] dt \\ = \int_{-1}^1 30(t^4 - 1) dt = \left[30 \left(\frac{t^5}{5} - t \right) \right]_{-1}^1 = 60 \left(\frac{1}{5} - 1 \right) \\ = -48 \Rightarrow \bar{y} = \frac{M_{yz}}{M} = -\frac{48}{80} = -\frac{3}{5}; M_{yz} = \int_C x \delta(x, y, z) ds = \int_C 0 \delta ds = 0 \Rightarrow \bar{x} = 0; \bar{z} = 0 \text{ by symmetry (since } \delta \text{ is independent of } z) \Rightarrow (\bar{x}, \bar{y}, \bar{z}) = (0, -\frac{3}{5}, 0)$$

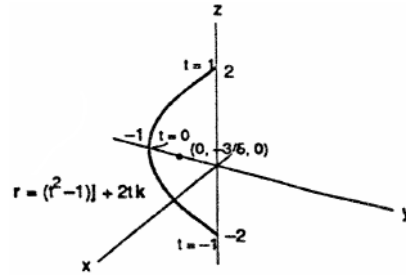

$$25. \mathbf{r}(t) = \sqrt{2}t\mathbf{i} + \sqrt{2}t\mathbf{j} + (4 - t^2)\mathbf{k}, 0 \leq t \leq 1 \Rightarrow \frac{d\mathbf{r}}{dt} = \sqrt{2}\mathbf{i} + \sqrt{2}\mathbf{j} - 2t\mathbf{k} \Rightarrow \left| \frac{d\mathbf{r}}{dt} \right| = \sqrt{2 + 2 + 4t^2} = 2\sqrt{1 + t^2};$$

$$(a) M = \int_C \delta ds = \int_0^1 (3t) (2\sqrt{1 + t^2}) dt = \left[2(1 + t^2)^{3/2} \right]_0^1 = 2(2^{3/2} - 1) = 4\sqrt{2} - 2$$

$$(b) M = \int_C \delta ds = \int_0^1 (1) (2\sqrt{1 + t^2}) dt = \left[t\sqrt{1 + t^2} + \ln(t + \sqrt{1 + t^2}) \right]_0^1 = \left[\sqrt{2} + \ln(1 + \sqrt{2}) \right] - (0 + \ln 1) \\ = \sqrt{2} + \ln(1 + \sqrt{2})$$

$$26. \mathbf{r}(t) = t\mathbf{i} + 2t\mathbf{j} + \frac{2}{3}t^{3/2}\mathbf{k}, 0 \leq t \leq 2 \Rightarrow \frac{d\mathbf{r}}{dt} = \mathbf{i} + 2\mathbf{j} + t^{1/2}\mathbf{k} \Rightarrow \left| \frac{d\mathbf{r}}{dt} \right| = \sqrt{1 + 4 + t} = \sqrt{5 + t};$$

$$M = \int_C \delta ds = \int_0^2 (3\sqrt{5 + t}) (\sqrt{5 + t}) dt = \int_0^2 3(5 + t) dt = \left[\frac{3}{2}(5 + t)^2 \right]_0^2 = \frac{3}{2}(7^2 - 5^2) = \frac{3}{2}(24) = 36;$$

$$M_{yz} = \int_C x \delta ds = \int_0^2 t[3(5 + t)] dt = \int_0^2 (15t + 3t^2) dt = \left[\frac{15}{2}t^2 + t^3 \right]_0^2 = 30 + 8 = 38;$$

$$M_{xz} = \int_C y \delta ds = \int_0^2 2t[3(5 + t)] dt = 2 \int_0^2 (15t + 3t^2) dt = 76; M_{xy} = \int_C z \delta ds = \int_0^2 \frac{2}{3}t^{3/2}[3(5 + t)] dt \\ = \int_0^2 (10t^{3/2} + 2t^{5/2}) dt = \left[4t^{5/2} + \frac{4}{7}t^{7/2} \right]_0^2 = 4(2)^{5/2} + \frac{4}{7}(2)^{7/2} = 16\sqrt{2} + \frac{32}{7}\sqrt{2} = \frac{144}{7}\sqrt{2} \Rightarrow \bar{x} = \frac{M_{xz}}{M} \\ = \frac{38}{36} = \frac{19}{18}, \bar{y} = \frac{M_{yz}}{M} = \frac{76}{36} = \frac{19}{9}, \text{ and } \bar{z} = \frac{M_{xy}}{M} = \frac{144\sqrt{2}}{7 \cdot 36} = \frac{4}{7}\sqrt{2}$$

$$27. \text{ Let } x = a \cos t \text{ and } y = a \sin t, 0 \leq t \leq 2\pi. \text{ Then } \frac{dx}{dt} = -a \sin t, \frac{dy}{dt} = a \cos t, \frac{dz}{dt} = 0$$

$$\Rightarrow \sqrt{\left(\frac{dx}{dt}\right)^2 + \left(\frac{dy}{dt}\right)^2 + \left(\frac{dz}{dt}\right)^2} dt = a dt; I_z = \int_C (x^2 + y^2) \delta ds = \int_0^{2\pi} (a^2 \sin^2 t + a^2 \cos^2 t) a \delta dt$$

$$= \int_0^{2\pi} a^3 \delta dt = 2\pi a^3; M = \int_C \delta(x, y, z) ds = \int_0^{2\pi} \delta a dt = 2\pi \delta a \Rightarrow R_z = \sqrt{\frac{I_z}{M}} = \sqrt{\frac{2\pi a^3 \delta}{2\pi a \delta}} = a.$$

$$28. \mathbf{r}(t) = t\mathbf{j} + (2 - 2t)\mathbf{k}, 0 \leq t \leq 1 \Rightarrow \frac{d\mathbf{r}}{dt} = \mathbf{j} - 2\mathbf{k} \Rightarrow \left| \frac{d\mathbf{r}}{dt} \right| = \sqrt{5}; M = \int_C \delta ds = \int_0^1 \delta \sqrt{5} dt = \delta \sqrt{5};$$

$$I_x = \int_C (y^2 + z^2) \delta ds = \int_0^1 [t^2 + (2 - 2t)^2] \delta \sqrt{5} dt = \int_0^1 (5t^2 - 8t + 4) \delta \sqrt{5} dt = \delta \sqrt{5} \left[\frac{5}{3}t^3 - 4t^2 + 4t \right]_0^1 = \frac{5}{3} \delta \sqrt{5};$$

$$I_y = \int_C (x^2 + z^2) \delta ds = \int_0^1 [0^2 + (2 - 2t)^2] \delta \sqrt{5} dt = \int_0^1 (4t^2 - 8t + 4) \delta \sqrt{5} dt = \delta \sqrt{5} \left[\frac{4}{3}t^3 - 4t^2 + 4t \right]_0^1 = \frac{4}{3} \delta \sqrt{5};$$

$$I_z = \int_C (x^2 + y^2) \delta ds = \int_0^1 (0^2 + t^2) \delta \sqrt{5} dt = \delta \sqrt{5} \left[\frac{t^3}{3} \right]_0^1 = \frac{1}{3} \delta \sqrt{5} \Rightarrow R_x = \sqrt{\frac{I_x}{M}} = \sqrt{\frac{5}{3}}, R_y = \sqrt{\frac{I_y}{M}} = \sqrt{\frac{4}{3}} = \frac{2}{\sqrt{3}},$$

$$\text{and } R_z = \sqrt{\frac{I_z}{M}} = \frac{1}{\sqrt{3}}$$

1000 Chapter 16 Integration in Vector Fields

29. $\mathbf{r}(t) = (\cos t)\mathbf{i} + (\sin t)\mathbf{j} + t\mathbf{k}$, $0 \leq t \leq 2\pi \Rightarrow \frac{d\mathbf{r}}{dt} = (-\sin t)\mathbf{i} + (\cos t)\mathbf{j} + \mathbf{k} \Rightarrow \left| \frac{d\mathbf{r}}{dt} \right| = \sqrt{\sin^2 t + \cos^2 t + 1} = \sqrt{2}$;

(a) $M = \int_C \delta \, ds = \int_0^{2\pi} \delta \sqrt{2} \, dt = 2\pi\delta\sqrt{2}$; $I_z = \int_C (x^2 + y^2) \delta \, ds = \int_0^{2\pi} (\cos^2 t + \sin^2 t) \delta \sqrt{2} \, dt = 2\pi\delta\sqrt{2}$
 $\Rightarrow R_z = \sqrt{\frac{I_z}{M}} = 1$

(b) $M = \int_C \delta(x, y, z) \, ds = \int_0^{4\pi} \delta \sqrt{2} \, dt = 4\pi\delta\sqrt{2}$ and $I_z = \int_C (x^2 + y^2) \delta \, ds = \int_0^{4\pi} \delta \sqrt{2} \, dt = 4\pi\delta\sqrt{2}$
 $\Rightarrow R_z = \sqrt{\frac{I_z}{M}} = 1$

30. $\mathbf{r}(t) = (t \cos t)\mathbf{i} + (t \sin t)\mathbf{j} + \frac{2\sqrt{2}}{3} t^{3/2} \mathbf{k}$, $0 \leq t \leq 1 \Rightarrow \frac{d\mathbf{r}}{dt} = (\cos t - t \sin t)\mathbf{i} + (\sin t + t \cos t)\mathbf{j} + \sqrt{2} t \mathbf{k}$

$\Rightarrow \left| \frac{d\mathbf{r}}{dt} \right| = \sqrt{(t+1)^2} = t+1$ for $0 \leq t \leq 1$; $M = \int_C \delta \, ds = \int_0^1 (t+1) \, dt = \left[\frac{1}{2}(t+1)^2 \right]_0^1 = \frac{1}{2}(2^2 - 1^2) = \frac{3}{2}$;

$M_{xy} = \int_C z \delta \, ds = \int_0^1 \left(\frac{2\sqrt{2}}{3} t^{3/2} \right) (t+1) \, dt = \frac{2\sqrt{2}}{3} \int_0^1 (t^{5/2} + t^{3/2}) \, dt = \frac{2\sqrt{2}}{3} \left[\frac{2}{7} t^{7/2} + \frac{2}{5} t^{5/2} \right]_0^1$

$= \frac{2\sqrt{2}}{3} \left(\frac{2}{7} + \frac{2}{5} \right) = \frac{2\sqrt{2}}{3} \left(\frac{24}{35} \right) = \frac{16\sqrt{2}}{35} \Rightarrow \bar{z} = \frac{M_{xy}}{M} = \left(\frac{16\sqrt{2}}{35} \right) \left(\frac{2}{3} \right) = \frac{32\sqrt{2}}{105}$; $I_z = \int_C (x^2 + y^2) \delta \, ds$

$= \int_0^1 (t^2 \cos^2 t + t^2 \sin^2 t) (t+1) \, dt = \int_0^1 (t^3 + t^2) \, dt = \left[\frac{t^4}{4} + \frac{t^3}{3} \right]_0^1 = \frac{1}{4} + \frac{1}{3} = \frac{7}{12} \Rightarrow R_z = \sqrt{\frac{I_z}{M}} = \sqrt{\frac{7}{12}}$

31. $\delta(x, y, z) = 2 - z$ and $\mathbf{r}(t) = (\cos t)\mathbf{j} + (\sin t)\mathbf{k}$, $0 \leq t \leq \pi \Rightarrow M = 2\pi - 2$ as found in Example 4 of the text;

also $\left| \frac{d\mathbf{r}}{dt} \right| = 1$; $I_x = \int_C (y^2 + z^2) \delta \, ds = \int_0^\pi (\cos^2 t + \sin^2 t) (2 - \sin t) \, dt = \int_0^\pi (2 - \sin t) \, dt = 2\pi - 2 \Rightarrow R_x = \sqrt{\frac{I_x}{M}} = 1$

32. $\mathbf{r}(t) = t\mathbf{i} + \frac{2\sqrt{2}}{3} t^{3/2} \mathbf{j} + \frac{t^2}{2} \mathbf{k}$, $0 \leq t \leq 2 \Rightarrow \frac{d\mathbf{r}}{dt} = \mathbf{i} + \sqrt{2} t^{1/2} \mathbf{j} + t\mathbf{k} \Rightarrow \left| \frac{d\mathbf{r}}{dt} \right| = \sqrt{1 + 2t + t^2} = \sqrt{(1+t)^2} = 1+t$ for

$0 \leq t \leq 2$; $M = \int_C \delta \, ds = \int_0^2 \left(\frac{1}{t+1} \right) (1+t) \, dt = \int_0^2 dt = 2$; $M_{yz} = \int_C x \delta \, ds = \int_0^2 t \left(\frac{1}{t+1} \right) (1+t) \, dt = \left[\frac{t^2}{2} \right]_0^2 = 2$;

$M_{xz} = \int_C y \delta \, ds = \int_0^2 \frac{2\sqrt{2}}{3} t^{3/2} \, dt = \left[\frac{4\sqrt{2}}{15} t^{5/2} \right]_0^2 = \frac{32}{15}$; $M_{xy} = \int_C z \delta \, ds = \int_0^2 \frac{t^2}{2} \, dt = \left[\frac{t^3}{6} \right]_0^2 = \frac{4}{3} \Rightarrow \bar{x} = \frac{M_{yz}}{M} = 1$,

$\bar{y} = \frac{M_{xz}}{M} = \frac{16}{15}$, and $\bar{z} = \frac{M_{xy}}{M} = \frac{2}{3}$; $I_x = \int_C (y^2 + z^2) \delta \, ds = \int_0^2 \left(\frac{8}{9} t^3 + \frac{1}{4} t^4 \right) \, dt = \left[\frac{2}{9} t^4 + \frac{t^5}{20} \right]_0^2 = \frac{32}{9} + \frac{32}{20} = \frac{232}{45}$;

$I_y = \int_C (x^2 + z^2) \delta \, ds = \int_0^2 \left(t^2 + \frac{1}{4} t^4 \right) \, dt = \left[\frac{t^3}{3} + \frac{t^5}{20} \right]_0^2 = \frac{8}{3} + \frac{32}{20} = \frac{64}{15}$; $I_z = \int_C (x^2 + y^2) \delta \, ds$

$= \int_0^2 \left(t^2 + \frac{8}{9} t^3 \right) \, dt = \left[\frac{t^3}{3} + \frac{2}{9} t^4 \right]_0^2 = \frac{8}{3} + \frac{32}{9} = \frac{56}{9} \Rightarrow R_x = \sqrt{\frac{I_x}{M}} = \frac{2}{3} \sqrt{\frac{29}{5}}$, $R_y = \sqrt{\frac{I_y}{M}} = \sqrt{\frac{32}{15}}$, and

$R_z = \sqrt{\frac{I_z}{M}} = \frac{2}{3} \sqrt{7}$

33-36. Example CAS commands:

Maple:

```
f := (x,y,z) -> sqrt(1+30*x^2+10*y);
g := t -> t;
h := t -> t^2;
k := t -> 3*t^2;
a,b := 0,2;
ds := ( D(g)^2 + D(h)^2 + D(k)^2 )^(1/2);           # (a)
'ds' = ds(t)*dt';
F := f(g,h,k);                                     # (b)
'F(t)' = F(t);
Int( f, s=C..NULL ) = Int( simplify(F(t)*ds(t)), t=a..b ); # (c)
`` = value(rhs(%));
```

Mathematica: (functions and domains may vary)

```
Clear[x, y, z, r, t, f]
f[x_,y_,z_] := Sqrt[1 + 30x^2 + 10y]
```



```

{a,b}={0,2};
x[t_]:=t
y[t_]:=t^2
z[t_]:=3t^2
r[t_]:= {x[t], y[t], z[t]}
v[t_]:=D[r[t], t]
mag[vector_]:=Sqrt[vector.vector]
Integrate[f[x[t],y[t],z[t]] mag[v[t]], {t, a, b}]
N[%]

```

16.2 VECTOR FIELDS, WORK, CIRCULATION, AND FLUX

- $f(x, y, z) = (x^2 + y^2 + z^2)^{-1/2} \Rightarrow \frac{\partial f}{\partial x} = -\frac{1}{2}(x^2 + y^2 + z^2)^{-3/2}(2x) = -x(x^2 + y^2 + z^2)^{-3/2}$; similarly,
 $\frac{\partial f}{\partial y} = -y(x^2 + y^2 + z^2)^{-3/2}$ and $\frac{\partial f}{\partial z} = -z(x^2 + y^2 + z^2)^{-3/2} \Rightarrow \nabla f = \frac{-xi - yj - zk}{(x^2 + y^2 + z^2)^{3/2}}$
- $f(x, y, z) = \ln \sqrt{x^2 + y^2 + z^2} = \frac{1}{2} \ln(x^2 + y^2 + z^2) \Rightarrow \frac{\partial f}{\partial x} = \frac{1}{2} \left(\frac{1}{x^2 + y^2 + z^2} \right) (2x) = \frac{x}{x^2 + y^2 + z^2}$;
similarly, $\frac{\partial f}{\partial y} = \frac{y}{x^2 + y^2 + z^2}$ and $\frac{\partial f}{\partial z} = \frac{z}{x^2 + y^2 + z^2} \Rightarrow \nabla f = \frac{xi + yj + zk}{x^2 + y^2 + z^2}$
- $g(x, y, z) = e^z - \ln(x^2 + y^2) \Rightarrow \frac{\partial g}{\partial x} = -\frac{2x}{x^2 + y^2}$, $\frac{\partial g}{\partial y} = -\frac{2y}{x^2 + y^2}$ and $\frac{\partial g}{\partial z} = e^z$
 $\Rightarrow \nabla g = \left(\frac{-2x}{x^2 + y^2} \right) \mathbf{i} - \left(\frac{2y}{x^2 + y^2} \right) \mathbf{j} + e^z \mathbf{k}$
- $g(x, y, z) = xy + yz + xz \Rightarrow \frac{\partial g}{\partial x} = y + z$, $\frac{\partial g}{\partial y} = x + z$, and $\frac{\partial g}{\partial z} = y + x \Rightarrow \nabla g = (y + z)\mathbf{i} + (x + z)\mathbf{j} + (x + y)\mathbf{k}$
- $|\mathbf{F}|$ inversely proportional to the square of the distance from (x, y) to the origin $\Rightarrow \sqrt{(M(x, y))^2 + (N(x, y))^2} = \frac{k}{x^2 + y^2}$, $k > 0$; \mathbf{F} points toward the origin $\Rightarrow \mathbf{F}$ is in the direction of $\mathbf{n} = \frac{-x}{\sqrt{x^2 + y^2}} \mathbf{i} - \frac{y}{\sqrt{x^2 + y^2}} \mathbf{j}$
 $\Rightarrow \mathbf{F} = a\mathbf{n}$, for some constant $a > 0$. Then $M(x, y) = \frac{-ax}{\sqrt{x^2 + y^2}}$ and $N(x, y) = \frac{-ay}{\sqrt{x^2 + y^2}}$
 $\Rightarrow \sqrt{(M(x, y))^2 + (N(x, y))^2} = a \Rightarrow a = \frac{k}{x^2 + y^2} \Rightarrow \mathbf{F} = \frac{-kx}{(x^2 + y^2)^{3/2}} \mathbf{i} - \frac{ky}{(x^2 + y^2)^{3/2}} \mathbf{j}$, for any constant $k > 0$
- Given $x^2 + y^2 = a^2 + b^2$, let $x = \sqrt{a^2 + b^2} \cos t$ and $y = -\sqrt{a^2 + b^2} \sin t$. Then
 $\mathbf{r} = \left(\sqrt{a^2 + b^2} \cos t \right) \mathbf{i} - \left(\sqrt{a^2 + b^2} \sin t \right) \mathbf{j}$ traces the circle in a clockwise direction as t goes from 0 to 2π
 $\Rightarrow \mathbf{v} = \left(-\sqrt{a^2 + b^2} \sin t \right) \mathbf{i} - \left(\sqrt{a^2 + b^2} \cos t \right) \mathbf{j}$ is tangent to the circle in a clockwise direction. Thus, let
 $\mathbf{F} = \mathbf{v} \Rightarrow \mathbf{F} = y\mathbf{i} - x\mathbf{j}$ and $\mathbf{F}(0, 0) = \mathbf{0}$.
- Substitute the parametric representations for $\mathbf{r}(t) = x(t)\mathbf{i} + y(t)\mathbf{j} + z(t)\mathbf{k}$ representing each path into the vector field \mathbf{F} , and calculate the work $W = \int_C \mathbf{F} \cdot \frac{d\mathbf{r}}{dt}$.
 - $\mathbf{F} = 3t\mathbf{i} + 2t\mathbf{j} + 4t\mathbf{k}$ and $\frac{d\mathbf{r}}{dt} = \mathbf{i} + \mathbf{j} + \mathbf{k} \Rightarrow \mathbf{F} \cdot \frac{d\mathbf{r}}{dt} = 9t \Rightarrow W = \int_0^1 9t \, dt = \frac{9}{2}$
 - $\mathbf{F} = 3t^2\mathbf{i} + 2t\mathbf{j} + 4t^4\mathbf{k}$ and $\frac{d\mathbf{r}}{dt} = \mathbf{i} + 2t\mathbf{j} + 4t^3\mathbf{k} \Rightarrow \mathbf{F} \cdot \frac{d\mathbf{r}}{dt} = 7t^2 + 16t^7 \Rightarrow W = \int_0^1 (7t^2 + 16t^7) \, dt = \left[\frac{7}{3}t^3 + 2t^8 \right]_0^1 = \frac{7}{3} + 2 = \frac{13}{3}$
 - $\mathbf{r}_1 = t\mathbf{i} + t\mathbf{j}$ and $\mathbf{r}_2 = \mathbf{i} + \mathbf{j} + t\mathbf{k}$; $\mathbf{F}_1 = 3t\mathbf{i} + 2t\mathbf{j}$ and $\frac{d\mathbf{r}_1}{dt} = \mathbf{i} + \mathbf{j} \Rightarrow \mathbf{F}_1 \cdot \frac{d\mathbf{r}_1}{dt} = 5t \Rightarrow W_1 = \int_0^1 5t \, dt = \frac{5}{2}$;
 $\mathbf{F}_2 = 3\mathbf{i} + 2\mathbf{j} + 4t\mathbf{k}$ and $\frac{d\mathbf{r}_2}{dt} = \mathbf{k} \Rightarrow \mathbf{F}_2 \cdot \frac{d\mathbf{r}_2}{dt} = 4t \Rightarrow W_2 = \int_0^1 4t \, dt = 2 \Rightarrow W = W_1 + W_2 = \frac{9}{2}$

8. Substitute the parametric representation for $\mathbf{r}(t) = x(t)\mathbf{i} + y(t)\mathbf{j} + z(t)\mathbf{k}$ representing each path into the vector field \mathbf{F} , and calculate the work $W = \int_C \mathbf{F} \cdot \frac{d\mathbf{r}}{dt}$.

$$(a) \mathbf{F} = \left(\frac{1}{t^2+1}\right)\mathbf{j} \text{ and } \frac{d\mathbf{r}}{dt} = \mathbf{i} + \mathbf{j} + \mathbf{k} \Rightarrow \mathbf{F} \cdot \frac{d\mathbf{r}}{dt} = \frac{1}{t^2+1} \Rightarrow W = \int_0^1 \frac{1}{t^2+1} dt = [\tan^{-1} t]_0^1 = \frac{\pi}{4}$$

$$(b) \mathbf{F} = \left(\frac{1}{t^2+1}\right)\mathbf{j} \text{ and } \frac{d\mathbf{r}}{dt} = \mathbf{i} + 2t\mathbf{j} + 4t^3\mathbf{k} \Rightarrow \mathbf{F} \cdot \frac{d\mathbf{r}}{dt} = \frac{2t}{t^2+1} \Rightarrow W = \int_0^1 \frac{2t}{t^2+1} dt = [\ln(t^2+1)]_0^1 = \ln 2$$

$$(c) \mathbf{r}_1 = t\mathbf{i} + t\mathbf{j} \text{ and } \mathbf{r}_2 = \mathbf{i} + \mathbf{j} + t\mathbf{k}; \mathbf{F}_1 = \left(\frac{1}{t^2+1}\right)\mathbf{j} \text{ and } \frac{d\mathbf{r}_1}{dt} = \mathbf{i} + \mathbf{j} \Rightarrow \mathbf{F}_1 \cdot \frac{d\mathbf{r}_1}{dt} = \frac{1}{t^2+1}; \mathbf{F}_2 = \frac{1}{2}\mathbf{j} \text{ and } \frac{d\mathbf{r}_2}{dt} = \mathbf{k} \\ \Rightarrow \mathbf{F}_2 \cdot \frac{d\mathbf{r}_2}{dt} = 0 \Rightarrow W = \int_0^1 \frac{1}{t^2+1} dt = \frac{\pi}{4}$$

9. Substitute the parametric representation for $\mathbf{r}(t) = x(t)\mathbf{i} + y(t)\mathbf{j} + z(t)\mathbf{k}$ representing each path into the vector field \mathbf{F} , and calculate the work $W = \int_C \mathbf{F} \cdot \frac{d\mathbf{r}}{dt}$.

$$(a) \mathbf{F} = \sqrt{t}\mathbf{i} - 2t\mathbf{j} + \sqrt{t}\mathbf{k} \text{ and } \frac{d\mathbf{r}}{dt} = \mathbf{i} + \mathbf{j} + \mathbf{k} \Rightarrow \mathbf{F} \cdot \frac{d\mathbf{r}}{dt} = 2\sqrt{t} - 2t \Rightarrow W = \int_0^1 (2\sqrt{t} - 2t) dt = \left[\frac{4}{3}t^{3/2} - t^2\right]_0^1 = \frac{1}{3}$$

$$(b) \mathbf{F} = t^2\mathbf{i} - 2t\mathbf{j} + t\mathbf{k} \text{ and } \frac{d\mathbf{r}}{dt} = \mathbf{i} + 2t\mathbf{j} + 4t^3\mathbf{k} \Rightarrow \mathbf{F} \cdot \frac{d\mathbf{r}}{dt} = 4t^4 - 3t^2 \Rightarrow W = \int_0^1 (4t^4 - 3t^2) dt = \left[\frac{4}{5}t^5 - t^3\right]_0^1 = -\frac{1}{5}$$

$$(c) \mathbf{r}_1 = t\mathbf{i} + t\mathbf{j} \text{ and } \mathbf{r}_2 = \mathbf{i} + \mathbf{j} + t\mathbf{k}; \mathbf{F}_1 = -2t\mathbf{j} + \sqrt{t}\mathbf{k} \text{ and } \frac{d\mathbf{r}_1}{dt} = \mathbf{i} + \mathbf{j} \Rightarrow \mathbf{F}_1 \cdot \frac{d\mathbf{r}_1}{dt} = -2t \Rightarrow W_1 = \int_0^1 -2t dt \\ = -1; \mathbf{F}_2 = \sqrt{t}\mathbf{i} - 2t\mathbf{j} + \mathbf{k} \text{ and } \frac{d\mathbf{r}_2}{dt} = \mathbf{k} \Rightarrow \mathbf{F}_2 \cdot \frac{d\mathbf{r}_2}{dt} = 1 \Rightarrow W_2 = \int_0^1 dt = 1 \Rightarrow W = W_1 + W_2 = 0$$

10. Substitute the parametric representation for $\mathbf{r}(t) = x(t)\mathbf{i} + y(t)\mathbf{j} + z(t)\mathbf{k}$ representing each path into the vector field \mathbf{F} , and calculate the work $W = \int_C \mathbf{F} \cdot \frac{d\mathbf{r}}{dt}$.

$$(a) \mathbf{F} = t^2\mathbf{i} + t^2\mathbf{j} + t^2\mathbf{k} \text{ and } \frac{d\mathbf{r}}{dt} = \mathbf{i} + \mathbf{j} + \mathbf{k} \Rightarrow \mathbf{F} \cdot \frac{d\mathbf{r}}{dt} = 3t^2 \Rightarrow W = \int_0^1 3t^2 dt = 1$$

$$(b) \mathbf{F} = t^3\mathbf{i} - t^6\mathbf{j} + t^5\mathbf{k} \text{ and } \frac{d\mathbf{r}}{dt} = \mathbf{i} + 2t\mathbf{j} + 4t^3\mathbf{k} \Rightarrow \mathbf{F} \cdot \frac{d\mathbf{r}}{dt} = t^3 + 2t^7 + 4t^8 \Rightarrow W = \int_0^1 (t^3 + 2t^7 + 4t^8) dt \\ = \left[\frac{t^4}{4} + \frac{t^8}{4} + \frac{4}{9}t^9\right]_0^1 = \frac{17}{18}$$

$$(c) \mathbf{r}_1 = t\mathbf{i} + t\mathbf{j} \text{ and } \mathbf{r}_2 = \mathbf{i} + \mathbf{j} + t\mathbf{k}; \mathbf{F}_1 = t^2\mathbf{i} \text{ and } \frac{d\mathbf{r}_1}{dt} = \mathbf{i} + \mathbf{j} \Rightarrow \mathbf{F}_1 \cdot \frac{d\mathbf{r}_1}{dt} = t^2 \Rightarrow W_1 = \int_0^1 t^2 dt = \frac{1}{3}; \\ \mathbf{F}_2 = \mathbf{i} + t\mathbf{j} + t\mathbf{k} \text{ and } \frac{d\mathbf{r}_2}{dt} = \mathbf{k} \Rightarrow \mathbf{F}_2 \cdot \frac{d\mathbf{r}_2}{dt} = t \Rightarrow W_2 = \int_0^1 t dt = \frac{1}{2} \Rightarrow W = W_1 + W_2 = \frac{5}{6}$$

11. Substitute the parametric representation for $\mathbf{r}(t) = x(t)\mathbf{i} + y(t)\mathbf{j} + z(t)\mathbf{k}$ representing each path into the vector field \mathbf{F} , and calculate the work $W = \int_C \mathbf{F} \cdot \frac{d\mathbf{r}}{dt}$.

$$(a) \mathbf{F} = (3t^2 - 3t)\mathbf{i} + 3t\mathbf{j} + \mathbf{k} \text{ and } \frac{d\mathbf{r}}{dt} = \mathbf{i} + \mathbf{j} + \mathbf{k} \Rightarrow \mathbf{F} \cdot \frac{d\mathbf{r}}{dt} = 3t^2 + 1 \Rightarrow W = \int_0^1 (3t^2 + 1) dt = [t^3 + t]_0^1 = 2$$

$$(b) \mathbf{F} = (3t^2 - 3t)\mathbf{i} + 3t^4\mathbf{j} + \mathbf{k} \text{ and } \frac{d\mathbf{r}}{dt} = \mathbf{i} + 2t\mathbf{j} + 4t^3\mathbf{k} \Rightarrow \mathbf{F} \cdot \frac{d\mathbf{r}}{dt} = 6t^5 + 4t^3 + 3t^2 - 3t \\ \Rightarrow W = \int_0^1 (6t^5 + 4t^3 + 3t^2 - 3t) dt = \left[t^6 + t^4 + t^3 - \frac{3}{2}t^2\right]_0^1 = \frac{3}{2}$$

$$(c) \mathbf{r}_1 = t\mathbf{i} + t\mathbf{j} \text{ and } \mathbf{r}_2 = \mathbf{i} + \mathbf{j} + t\mathbf{k}; \mathbf{F}_1 = (3t^2 - 3t)\mathbf{i} + \mathbf{k} \text{ and } \frac{d\mathbf{r}_1}{dt} = \mathbf{i} + \mathbf{j} \Rightarrow \mathbf{F}_1 \cdot \frac{d\mathbf{r}_1}{dt} = 3t^2 - 3t \\ \Rightarrow W_1 = \int_0^1 (3t^2 - 3t) dt = \left[t^3 - \frac{3}{2}t^2\right]_0^1 = -\frac{1}{2}; \mathbf{F}_2 = 3t\mathbf{j} + \mathbf{k} \text{ and } \frac{d\mathbf{r}_2}{dt} = \mathbf{k} \Rightarrow \mathbf{F}_2 \cdot \frac{d\mathbf{r}_2}{dt} = 1 \Rightarrow W_2 = \int_0^1 dt = 1 \\ \Rightarrow W = W_1 + W_2 = \frac{1}{2}$$

12. Substitute the parametric representation for $\mathbf{r}(t) = x(t)\mathbf{i} + y(t)\mathbf{j} + z(t)\mathbf{k}$ representing each path into the vector field \mathbf{F} , and calculate the work $W = \int_C \mathbf{F} \cdot \frac{d\mathbf{r}}{dt}$.

$$(a) \mathbf{F} = 2t\mathbf{i} + 2t\mathbf{j} + 2t\mathbf{k} \text{ and } \frac{d\mathbf{r}}{dt} = \mathbf{i} + \mathbf{j} + \mathbf{k} \Rightarrow \mathbf{F} \cdot \frac{d\mathbf{r}}{dt} = 6t \Rightarrow W = \int_0^1 6t dt = [3t^2]_0^1 = 3$$

$$(b) \mathbf{F} = (t^2 + t^4)\mathbf{i} + (t^4 + t)\mathbf{j} + (t + t^2)\mathbf{k} \text{ and } \frac{d\mathbf{r}}{dt} = \mathbf{i} + 2t\mathbf{j} + 4t^3\mathbf{k} \Rightarrow \mathbf{F} \cdot \frac{d\mathbf{r}}{dt} = 6t^5 + 5t^4 + 3t^2 \\ \Rightarrow W = \int_0^1 (6t^5 + 5t^4 + 3t^2) dt = [t^6 + t^5 + t^3]_0^1 = 3$$

$$(c) \mathbf{r}_1 = t\mathbf{i} + t\mathbf{j} \text{ and } \mathbf{r}_2 = \mathbf{i} + \mathbf{j} + t\mathbf{k}; \mathbf{F}_1 = t\mathbf{i} + t\mathbf{j} + 2t\mathbf{k} \text{ and } \frac{d\mathbf{r}_1}{dt} = \mathbf{i} + \mathbf{j} \Rightarrow \mathbf{F}_1 \cdot \frac{d\mathbf{r}_1}{dt} = 2t \Rightarrow W_1 = \int_0^1 2t \, dt = 1;$$

$$\mathbf{F}_2 = (1+t)\mathbf{i} + (t+1)\mathbf{j} + 2\mathbf{k} \text{ and } \frac{d\mathbf{r}_2}{dt} = \mathbf{k} \Rightarrow \mathbf{F}_2 \cdot \frac{d\mathbf{r}_2}{dt} = 2 \Rightarrow W_2 = \int_0^1 2 \, dt = 2 \Rightarrow W = W_1 + W_2 = 3$$

$$13. \mathbf{r} = t\mathbf{i} + t^2\mathbf{j} + t\mathbf{k}, 0 \leq t \leq 1, \text{ and } \mathbf{F} = xy\mathbf{i} + y\mathbf{j} - yz\mathbf{k} \Rightarrow \mathbf{F} = t^3\mathbf{i} + t^2\mathbf{j} - t^3\mathbf{k} \text{ and } \frac{d\mathbf{r}}{dt} = \mathbf{i} + 2t\mathbf{j} + \mathbf{k}$$

$$\Rightarrow \mathbf{F} \cdot \frac{d\mathbf{r}}{dt} = 2t^3 \Rightarrow \text{work} = \int_0^1 2t^3 \, dt = \frac{1}{2}$$

$$14. \mathbf{r} = (\cos t)\mathbf{i} + (\sin t)\mathbf{j} + \frac{1}{6}\mathbf{k}, 0 \leq t \leq 2\pi, \text{ and } \mathbf{F} = 2y\mathbf{i} + 3x\mathbf{j} + (x+y)\mathbf{k}$$

$$\Rightarrow \mathbf{F} = (2\sin t)\mathbf{i} + (3\cos t)\mathbf{j} + (\cos t + \sin t)\mathbf{k} \text{ and } \frac{d\mathbf{r}}{dt} = (-\sin t)\mathbf{i} + (\cos t)\mathbf{j} + \frac{1}{6}\mathbf{k} \Rightarrow \mathbf{F} \cdot \frac{d\mathbf{r}}{dt}$$

$$= 3\cos^2 t - 2\sin^2 t + \frac{1}{6}\cos t + \frac{1}{6}\sin t \Rightarrow \text{work} = \int_0^{2\pi} (3\cos^2 t - 2\sin^2 t + \frac{1}{6}\cos t + \frac{1}{6}\sin t) \, dt$$

$$= \left[\frac{3}{2}t + \frac{3}{4}\sin 2t - t + \frac{\sin 2t}{2} + \frac{1}{6}\sin t - \frac{1}{6}\cos t \right]_0^{2\pi} = \pi$$

$$15. \mathbf{r} = (\sin t)\mathbf{i} + (\cos t)\mathbf{j} + t\mathbf{k}, 0 \leq t \leq 2\pi, \text{ and } \mathbf{F} = z\mathbf{i} + x\mathbf{j} + y\mathbf{k} \Rightarrow \mathbf{F} = t\mathbf{i} + (\sin t)\mathbf{j} + (\cos t)\mathbf{k} \text{ and}$$

$$\frac{d\mathbf{r}}{dt} = (\cos t)\mathbf{i} - (\sin t)\mathbf{j} + \mathbf{k} \Rightarrow \mathbf{F} \cdot \frac{d\mathbf{r}}{dt} = t\cos t - \sin^2 t + \cos t \Rightarrow \text{work} = \int_0^{2\pi} (t\cos t - \sin^2 t + \cos t) \, dt$$

$$= \left[\cos t + t\sin t - \frac{1}{2} + \frac{\sin 2t}{4} + \sin t \right]_0^{2\pi} = -\pi$$

$$16. \mathbf{r} = (\sin t)\mathbf{i} + (\cos t)\mathbf{j} + \frac{1}{6}\mathbf{k}, 0 \leq t \leq 2\pi, \text{ and } \mathbf{F} = 6z\mathbf{i} + y^2\mathbf{j} + 12x\mathbf{k} \Rightarrow \mathbf{F} = t\mathbf{i} + (\cos^2 t)\mathbf{j} + (12\sin t)\mathbf{k} \text{ and}$$

$$\frac{d\mathbf{r}}{dt} = (\cos t)\mathbf{i} - (\sin t)\mathbf{j} + \frac{1}{6}\mathbf{k} \Rightarrow \mathbf{F} \cdot \frac{d\mathbf{r}}{dt} = t\cos t - \sin t\cos^2 t + 2\sin t$$

$$\Rightarrow \text{work} = \int_0^{2\pi} (t\cos t - \sin t\cos^2 t + 2\sin t) \, dt = \left[\cos t + t\sin t + \frac{1}{3}\cos^3 t - 2\cos t \right]_0^{2\pi} = 0$$

$$17. x = t \text{ and } y = x^2 = t^2 \Rightarrow \mathbf{r} = t\mathbf{i} + t^2\mathbf{j}, -1 \leq t \leq 2, \text{ and } \mathbf{F} = xy\mathbf{i} + (x+y)\mathbf{j} \Rightarrow \mathbf{F} = t^3\mathbf{i} + (t+t^2)\mathbf{j} \text{ and}$$

$$\frac{d\mathbf{r}}{dt} = \mathbf{i} + 2t\mathbf{j} \Rightarrow \mathbf{F} \cdot \frac{d\mathbf{r}}{dt} = t^3 + (2t^2 + 2t^3) = 3t^3 + 2t^2 \Rightarrow \int_C \mathbf{F} \cdot \frac{d\mathbf{r}}{dt} \, dt = \int_{-1}^2 (3t^3 + 2t^2) \, dt$$

$$= \left[\frac{3}{4}t^4 + \frac{2}{3}t^3 \right]_{-1}^2 = \left(12 + \frac{16}{3} \right) - \left(\frac{3}{4} - \frac{2}{3} \right) = \frac{45}{4} + \frac{18}{3} = \frac{69}{4}$$

$$18. \text{Along } (0, 0) \text{ to } (1, 0): \mathbf{r} = t\mathbf{i}, 0 \leq t \leq 1, \text{ and } \mathbf{F} = (x-y)\mathbf{i} + (x+y)\mathbf{j} \Rightarrow \mathbf{F} = t\mathbf{i} + t\mathbf{j} \text{ and } \frac{d\mathbf{r}}{dt} = \mathbf{i} \Rightarrow \mathbf{F} \cdot \frac{d\mathbf{r}}{dt} = t;$$

$$\text{Along } (1, 0) \text{ to } (0, 1): \mathbf{r} = (1-t)\mathbf{i} + t\mathbf{j}, 0 \leq t \leq 1, \text{ and } \mathbf{F} = (x-y)\mathbf{i} + (x+y)\mathbf{j} \Rightarrow \mathbf{F} = (1-2t)\mathbf{i} + \mathbf{j} \text{ and}$$

$$\frac{d\mathbf{r}}{dt} = -\mathbf{i} + \mathbf{j} \Rightarrow \mathbf{F} \cdot \frac{d\mathbf{r}}{dt} = 2t;$$

$$\text{Along } (0, 1) \text{ to } (0, 0): \mathbf{r} = (1-t)\mathbf{j}, 0 \leq t \leq 1, \text{ and } \mathbf{F} = (x-y)\mathbf{i} + (x+y)\mathbf{j} \Rightarrow \mathbf{F} = (t-1)\mathbf{i} + (1-t)\mathbf{j} \text{ and}$$

$$\frac{d\mathbf{r}}{dt} = -\mathbf{j} \Rightarrow \mathbf{F} \cdot \frac{d\mathbf{r}}{dt} = t-1 \Rightarrow \int_C (x-y) \, dx + (x+y) \, dy = \int_0^1 t \, dt + \int_0^1 2t \, dt + \int_0^1 (t-1) \, dt = \int_0^1 (4t-1) \, dt$$

$$= [2t^2 - t]_0^1 = 2 - 1 = 1$$

$$19. \mathbf{r} = x\mathbf{i} + y\mathbf{j} = y^2\mathbf{i} + y\mathbf{j}, 2 \geq y \geq -1, \text{ and } \mathbf{F} = x^2\mathbf{i} - y\mathbf{j} = y^4\mathbf{i} - y\mathbf{j} \Rightarrow \frac{d\mathbf{r}}{dy} = 2y\mathbf{i} + \mathbf{j} \text{ and } \mathbf{F} \cdot \frac{d\mathbf{r}}{dy} = 2y^5 - y$$

$$\Rightarrow \int_C \mathbf{F} \cdot \mathbf{T} \, ds = \int_2^{-1} \mathbf{F} \cdot \frac{d\mathbf{r}}{dy} \, dy = \int_2^{-1} (2y^5 - y) \, dy = \left[\frac{1}{3}y^6 - \frac{1}{2}y^2 \right]_2^{-1} = \left(\frac{1}{3} - \frac{1}{2} \right) - \left(\frac{64}{3} - \frac{4}{2} \right) = \frac{3}{2} - \frac{63}{3} = -\frac{39}{2}$$

$$20. \mathbf{r} = (\cos t)\mathbf{i} + (\sin t)\mathbf{j}, 0 \leq t \leq \frac{\pi}{2}, \text{ and } \mathbf{F} = y\mathbf{i} - x\mathbf{j} \Rightarrow \mathbf{F} = (\sin t)\mathbf{i} - (\cos t)\mathbf{j} \text{ and } \frac{d\mathbf{r}}{dt} = (-\sin t)\mathbf{i} + (\cos t)\mathbf{j}$$

$$\Rightarrow \mathbf{F} \cdot \frac{d\mathbf{r}}{dt} = -\sin^2 t - \cos^2 t = -1 \Rightarrow \int_C \mathbf{F} \cdot d\mathbf{r} = \int_0^{\pi/2} (-1) \, dt = -\frac{\pi}{2}$$

$$21. \mathbf{r} = (\mathbf{i} + \mathbf{j}) + t(\mathbf{i} + 2\mathbf{j}) = (1+t)\mathbf{i} + (1+2t)\mathbf{j}, 0 \leq t \leq 1, \text{ and } \mathbf{F} = xy\mathbf{i} + (y-x)\mathbf{j} \Rightarrow \mathbf{F} = (1+3t+2t^2)\mathbf{i} + t\mathbf{j} \text{ and}$$

$$\frac{d\mathbf{r}}{dt} = \mathbf{i} + 2\mathbf{j} \Rightarrow \mathbf{F} \cdot \frac{d\mathbf{r}}{dt} = 1 + 5t + 2t^2 \Rightarrow \text{work} = \int_C \mathbf{F} \cdot \frac{d\mathbf{r}}{dt} \, dt = \int_0^1 (1 + 5t + 2t^2) \, dt = \left[t + \frac{5}{2}t^2 + \frac{2}{3}t^3 \right]_0^1 = \frac{25}{6}$$

$$22. \mathbf{r} = (2\cos t)\mathbf{i} + (2\sin t)\mathbf{j}, 0 \leq t \leq 2\pi, \text{ and } \mathbf{F} = \nabla f = 2(x+y)\mathbf{i} + 2(x+y)\mathbf{j}$$

$$\Rightarrow \mathbf{F} = 4(\cos t + \sin t)\mathbf{i} + 4(\cos t + \sin t)\mathbf{j} \text{ and } \frac{d\mathbf{r}}{dt} = (-2\sin t)\mathbf{i} + (2\cos t)\mathbf{j} \Rightarrow \mathbf{F} \cdot \frac{d\mathbf{r}}{dt}$$

$$= -8(\sin t \cos t + \sin^2 t) + 8(\cos^2 t + \cos t \sin t) = 8(\cos^2 t - \sin^2 t) = 8 \cos 2t \Rightarrow \text{work} = \int_C \nabla f \cdot d\mathbf{r}$$

$$= \int_C \mathbf{F} \cdot \frac{d\mathbf{r}}{dt} dt = \int_0^{2\pi} 8 \cos 2t dt = [4 \sin 2t]_0^{2\pi} = 0$$

23. (a) $\mathbf{r} = (\cos t)\mathbf{i} + (\sin t)\mathbf{j}$, $0 \leq t \leq 2\pi$, $\mathbf{F}_1 = x\mathbf{i} + y\mathbf{j}$, and $\mathbf{F}_2 = -y\mathbf{i} + x\mathbf{j} \Rightarrow \frac{d\mathbf{r}}{dt} = (-\sin t)\mathbf{i} + (\cos t)\mathbf{j}$,
 $\mathbf{F}_1 = (\cos t)\mathbf{i} + (\sin t)\mathbf{j}$, and $\mathbf{F}_2 = (-\sin t)\mathbf{i} + (\cos t)\mathbf{j} \Rightarrow \mathbf{F}_1 \cdot \frac{d\mathbf{r}}{dt} = 0$ and $\mathbf{F}_2 \cdot \frac{d\mathbf{r}}{dt} = \sin^2 t + \cos^2 t = 1$
 $\Rightarrow \text{Circ}_1 = \int_0^{2\pi} 0 dt = 0$ and $\text{Circ}_2 = \int_0^{2\pi} 1 dt = 2\pi$; $\mathbf{n} = (\cos t)\mathbf{i} + (\sin t)\mathbf{j} \Rightarrow \mathbf{F}_1 \cdot \mathbf{n} = \cos^2 t + \sin^2 t = 1$ and
 $\mathbf{F}_2 \cdot \mathbf{n} = 0 \Rightarrow \text{Flux}_1 = \int_0^{2\pi} 1 dt = 2\pi$ and $\text{Flux}_2 = \int_0^{2\pi} 0 dt = 0$

(b) $\mathbf{r} = (\cos t)\mathbf{i} + (4 \sin t)\mathbf{j}$, $0 \leq t \leq 2\pi \Rightarrow \frac{d\mathbf{r}}{dt} = (-\sin t)\mathbf{i} + (4 \cos t)\mathbf{j}$, $\mathbf{F}_1 = (\cos t)\mathbf{i} + (4 \sin t)\mathbf{j}$, and
 $\mathbf{F}_2 = (-4 \sin t)\mathbf{i} + (\cos t)\mathbf{j} \Rightarrow \mathbf{F}_1 \cdot \frac{d\mathbf{r}}{dt} = 15 \sin t \cos t$ and $\mathbf{F}_2 \cdot \frac{d\mathbf{r}}{dt} = 4 \Rightarrow \text{Circ}_1 = \int_0^{2\pi} 15 \sin t \cos t dt$
 $= [\frac{15}{2} \sin^2 t]_0^{2\pi} = 0$ and $\text{Circ}_2 = \int_0^{2\pi} 4 dt = 8\pi$; $\mathbf{n} = (\frac{4}{\sqrt{17}} \cos t)\mathbf{i} + (\frac{1}{\sqrt{17}} \sin t)\mathbf{j} \Rightarrow \mathbf{F}_1 \cdot \mathbf{n}$
 $= \frac{4}{\sqrt{17}} \cos^2 t + \frac{4}{\sqrt{17}} \sin^2 t$ and $\mathbf{F}_2 \cdot \mathbf{n} = -\frac{15}{\sqrt{17}} \sin t \cos t \Rightarrow \text{Flux}_1 = \int_0^{2\pi} (\mathbf{F}_1 \cdot \mathbf{n}) |\mathbf{v}| dt = \int_0^{2\pi} (\frac{4}{\sqrt{17}}) \sqrt{17} dt$
 $= 8\pi$ and $\text{Flux}_2 = \int_0^{2\pi} (\mathbf{F}_2 \cdot \mathbf{n}) |\mathbf{v}| dt = \int_0^{2\pi} (-\frac{15}{\sqrt{17}} \sin t \cos t) \sqrt{17} dt = [-\frac{15}{2} \sin^2 t]_0^{2\pi} = 0$

24. $\mathbf{r} = (a \cos t)\mathbf{i} + (a \sin t)\mathbf{j}$, $0 \leq t \leq 2\pi$, $\mathbf{F}_1 = 2x\mathbf{i} - 3y\mathbf{j}$, and $\mathbf{F}_2 = 2x\mathbf{i} + (x - y)\mathbf{j} \Rightarrow \frac{d\mathbf{r}}{dt} = (-a \sin t)\mathbf{i} + (a \cos t)\mathbf{j}$,
 $\mathbf{F}_1 = (2a \cos t)\mathbf{i} - (3a \sin t)\mathbf{j}$, and $\mathbf{F}_2 = (2a \cos t)\mathbf{i} + (a \cos t - a \sin t)\mathbf{j} \Rightarrow \mathbf{n} |\mathbf{v}| = (a \cos t)\mathbf{i} + (a \sin t)\mathbf{j}$,
 $\mathbf{F}_1 \cdot \mathbf{n} |\mathbf{v}| = 2a^2 \cos^2 t - 3a^2 \sin^2 t$, and $\mathbf{F}_2 \cdot \mathbf{n} |\mathbf{v}| = 2a^2 \cos^2 t + a^2 \sin t \cos t - a^2 \sin^2 t$
 $\Rightarrow \text{Flux}_1 = \int_0^{2\pi} (2a^2 \cos^2 t - 3a^2 \sin^2 t) dt = 2a^2 [\frac{1}{2} + \frac{\sin 2t}{4}]_0^{2\pi} - 3a^2 [\frac{1}{2} - \frac{\sin 2t}{4}]_0^{2\pi} = -\pi a^2$, and
 $\text{Flux}_2 = \int_0^{2\pi} (2a^2 \cos^2 t - a^2 \sin t \cos t - a^2 \sin^2 t) dt = 2a^2 [\frac{1}{2} + \frac{\sin 2t}{4}]_0^{2\pi} + \frac{a^2}{2} [\sin^2 t]_0^{2\pi} - a^2 [\frac{1}{2} - \frac{\sin 2t}{4}]_0^{2\pi} = \pi a^2$

25. $\mathbf{F}_1 = (a \cos t)\mathbf{i} + (a \sin t)\mathbf{j}$, $\frac{d\mathbf{r}_1}{dt} = (-a \sin t)\mathbf{i} + (a \cos t)\mathbf{j} \Rightarrow \mathbf{F}_1 \cdot \frac{d\mathbf{r}_1}{dt} = 0 \Rightarrow \text{Circ}_1 = 0$; $M_1 = a \cos t$,
 $N_1 = a \sin t$, $dx = -a \sin t dt$, $dy = a \cos t dt \Rightarrow \text{Flux}_1 = \int_C M_1 dy - N_1 dx = \int_0^\pi (a^2 \cos^2 t + a^2 \sin^2 t) dt$
 $= \int_0^\pi a^2 dt = a^2 \pi$;
 $\mathbf{F}_2 = t\mathbf{i}$, $\frac{d\mathbf{r}_2}{dt} = \mathbf{i} \Rightarrow \mathbf{F}_2 \cdot \frac{d\mathbf{r}_2}{dt} = t \Rightarrow \text{Circ}_2 = \int_{-a}^a t dt = 0$; $M_2 = t$, $N_2 = 0$, $dx = dt$, $dy = 0 \Rightarrow \text{Flux}_2$
 $= \int_C M_2 dy - N_2 dx = \int_{-a}^a 0 dt = 0$; therefore, $\text{Circ} = \text{Circ}_1 + \text{Circ}_2 = 0$ and $\text{Flux} = \text{Flux}_1 + \text{Flux}_2 = a^2 \pi$

26. $\mathbf{F}_1 = (a^2 \cos^2 t)\mathbf{i} + (a^2 \sin^2 t)\mathbf{j}$, $\frac{d\mathbf{r}_1}{dt} = (-a \sin t)\mathbf{i} + (a \cos t)\mathbf{j} \Rightarrow \mathbf{F}_1 \cdot \frac{d\mathbf{r}_1}{dt} = -a^3 \sin t \cos^2 t + a^3 \cos t \sin^2 t$
 $\Rightarrow \text{Circ}_1 = \int_0^\pi (-a^3 \sin t \cos^2 t + a^3 \cos t \sin^2 t) dt = -\frac{2a^3}{3}$; $M_1 = a^2 \cos^2 t$, $N_1 = a^2 \sin^2 t$, $dy = a \cos t dt$,
 $dx = -a \sin t dt \Rightarrow \text{Flux}_1 = \int_C M_1 dy - N_1 dx = \int_0^\pi (a^3 \cos^3 t + a^3 \sin^3 t) dt = \frac{4}{3} a^3$;
 $\mathbf{F}_2 = t^2 \mathbf{i}$, $\frac{d\mathbf{r}_2}{dt} = \mathbf{i} \Rightarrow \mathbf{F}_2 \cdot \frac{d\mathbf{r}_2}{dt} = t^2 \Rightarrow \text{Circ}_2 = \int_{-a}^a t^2 dt = \frac{2a^3}{3}$; $M_2 = t^2$, $N_2 = 0$, $dy = 0$, $dx = dt$
 $\Rightarrow \text{Flux}_2 = \int_C M_2 dy - N_2 dx = 0$; therefore, $\text{Circ} = \text{Circ}_1 + \text{Circ}_2 = 0$ and $\text{Flux} = \text{Flux}_1 + \text{Flux}_2 = \frac{4}{3} a^3$

27. $\mathbf{F}_1 = (-a \sin t)\mathbf{i} + (a \cos t)\mathbf{j}$, $\frac{d\mathbf{r}_1}{dt} = (-a \sin t)\mathbf{i} + (a \cos t)\mathbf{j} \Rightarrow \mathbf{F}_1 \cdot \frac{d\mathbf{r}_1}{dt} = a^2 \sin^2 t + a^2 \cos^2 t = a^2$
 $\Rightarrow \text{Circ}_1 = \int_0^\pi a^2 dt = a^2 \pi$; $M_1 = -a \sin t$, $N_1 = a \cos t$, $dx = -a \sin t dt$, $dy = a \cos t dt$
 $\Rightarrow \text{Flux}_1 = \int_C M_1 dy - N_1 dx = \int_0^\pi (-a^2 \sin t \cos t + a^2 \sin t \cos t) dt = 0$; $\mathbf{F}_2 = t\mathbf{j}$, $\frac{d\mathbf{r}_2}{dt} = \mathbf{i} \Rightarrow \mathbf{F}_2 \cdot \frac{d\mathbf{r}_2}{dt} = 0$
 $\Rightarrow \text{Circ}_2 = 0$; $M_2 = 0$, $N_2 = t$, $dx = dt$, $dy = 0 \Rightarrow \text{Flux}_2 = \int_C M_2 dy - N_2 dx = \int_{-a}^a -t dt = 0$; therefore,
 $\text{Circ} = \text{Circ}_1 + \text{Circ}_2 = a^2 \pi$ and $\text{Flux} = \text{Flux}_1 + \text{Flux}_2 = 0$

28. $\mathbf{F}_1 = (-a^2 \sin^2 t)\mathbf{i} + (a^2 \cos^2 t)\mathbf{j}$, $\frac{d\mathbf{r}_1}{dt} = (-a \sin t)\mathbf{i} + (a \cos t)\mathbf{j} \Rightarrow \mathbf{F}_1 \cdot \frac{d\mathbf{r}_1}{dt} = a^3 \sin^3 t + a^3 \cos^3 t$
 $\Rightarrow \text{Circ}_1 = \int_0^\pi (a^3 \sin^3 t + a^3 \cos^3 t) dt = \frac{4}{3} a^3$; $M_1 = -a^2 \sin^2 t$, $N_1 = a^2 \cos^2 t$, $dy = a \cos t dt$, $dx = -a \sin t dt$
 $\Rightarrow \text{Flux}_1 = \int_C M_1 dy - N_1 dx = \int_0^\pi (-a^3 \cos t \sin^2 t + a^3 \sin t \cos^2 t) dt = \frac{2}{3} a^3$; $\mathbf{F}_2 = t^2 \mathbf{j}$, $\frac{d\mathbf{r}_2}{dt} = \mathbf{i} \Rightarrow \mathbf{F}_2 \cdot \frac{d\mathbf{r}_2}{dt} = 0$
 $\Rightarrow \text{Circ}_2 = 0$; $M_2 = 0$, $N_2 = t^2$, $dy = 0$, $dx = dt \Rightarrow \text{Flux}_2 = \int_C M_2 dy - N_2 dx = \int_{-a}^a -t^2 dt = -\frac{2}{3} a^3$; therefore,
 $\text{Circ} = \text{Circ}_1 + \text{Circ}_2 = \frac{4}{3} a^3$ and $\text{Flux} = \text{Flux}_1 + \text{Flux}_2 = 0$
29. (a) $\mathbf{r} = (\cos t)\mathbf{i} + (\sin t)\mathbf{j}$, $0 \leq t \leq \pi$, and $\mathbf{F} = (x + y)\mathbf{i} - (x^2 + y^2)\mathbf{j} \Rightarrow \frac{d\mathbf{r}}{dt} = (-\sin t)\mathbf{i} + (\cos t)\mathbf{j}$ and
 $\mathbf{F} = (\cos t + \sin t)\mathbf{i} - (\cos^2 t + \sin^2 t)\mathbf{j} \Rightarrow \mathbf{F} \cdot \frac{d\mathbf{r}}{dt} = -\sin t \cos t - \sin^2 t - \cos t \Rightarrow \int_C \mathbf{F} \cdot \mathbf{T} ds$
 $= \int_0^\pi (-\sin t \cos t - \sin^2 t - \cos t) dt = [-\frac{1}{2} \sin^2 t - \frac{1}{2} + \frac{\sin 2t}{4} - \sin t]_0^\pi = -\frac{\pi}{2}$
- (b) $\mathbf{r} = (1 - 2t)\mathbf{i}$, $0 \leq t \leq 1$, and $\mathbf{F} = (x + y)\mathbf{i} - (x^2 + y^2)\mathbf{j} \Rightarrow \frac{d\mathbf{r}}{dt} = -2\mathbf{i}$ and $\mathbf{F} = (1 - 2t)\mathbf{i} - (1 - 2t)^2 \mathbf{j} \Rightarrow$
 $\mathbf{F} \cdot \frac{d\mathbf{r}}{dt} = 4t - 2 \Rightarrow \int_C \mathbf{F} \cdot \mathbf{T} ds = \int_0^1 (4t - 2) dt = [2t^2 - 2t]_0^1 = 0$
- (c) $\mathbf{r}_1 = (1 - t)\mathbf{i} - t\mathbf{j}$, $0 \leq t \leq 1$, and $\mathbf{F} = (x + y)\mathbf{i} - (x^2 + y^2)\mathbf{j} \Rightarrow \frac{d\mathbf{r}_1}{dt} = -\mathbf{i} - \mathbf{j}$ and $\mathbf{F} = (1 - 2t)\mathbf{i} - (1 - 2t + 2t^2)\mathbf{j}$
 $\Rightarrow \mathbf{F} \cdot \frac{d\mathbf{r}_1}{dt} = (2t - 1) + (1 - 2t + 2t^2) = 2t^2 \Rightarrow \text{Flow}_1 = \int_{C_1} \mathbf{F} \cdot \frac{d\mathbf{r}_1}{dt} = \int_0^1 2t^2 dt = \frac{2}{3}$; $\mathbf{r}_2 = -t\mathbf{i} + (t - 1)\mathbf{j}$,
 $0 \leq t \leq 1$, and $\mathbf{F} = (x + y)\mathbf{i} - (x^2 + y^2)\mathbf{j} \Rightarrow \frac{d\mathbf{r}_2}{dt} = -\mathbf{i} + \mathbf{j}$ and $\mathbf{F} = -\mathbf{i} - (t^2 + t^2 - 2t + 1)\mathbf{j}$
 $= -\mathbf{i} - (2t^2 - 2t + 1)\mathbf{j} \Rightarrow \mathbf{F} \cdot \frac{d\mathbf{r}_2}{dt} = 1 - (2t^2 - 2t + 1) = 2t - 2t^2 \Rightarrow \text{Flow}_2 = \int_{C_2} \mathbf{F} \cdot \frac{d\mathbf{r}_2}{dt} = \int_0^1 (2t - 2t^2) dt$
 $= [t^2 - \frac{2}{3} t^3]_0^1 = \frac{1}{3} \Rightarrow \text{Flow} = \text{Flow}_1 + \text{Flow}_2 = \frac{2}{3} + \frac{1}{3} = 1$
30. From $(1, 0)$ to $(0, 1)$: $\mathbf{r}_1 = (1 - t)\mathbf{i} + t\mathbf{j}$, $0 \leq t \leq 1$, and $\mathbf{F} = (x + y)\mathbf{i} - (x^2 + y^2)\mathbf{j} \Rightarrow \frac{d\mathbf{r}_1}{dt} = -\mathbf{i} + \mathbf{j}$,
 $\mathbf{F} = \mathbf{i} - (1 - 2t + 2t^2)\mathbf{j}$, and $\mathbf{n}_1 |\mathbf{v}_1| = \mathbf{i} + \mathbf{j} \Rightarrow \mathbf{F} \cdot \mathbf{n}_1 |\mathbf{v}_1| = 2t - 2t^2 \Rightarrow \text{Flux}_1 = \int_0^1 (2t - 2t^2) dt$
 $= [t^2 - \frac{2}{3} t^3]_0^1 = \frac{1}{3}$;
 From $(0, 1)$ to $(-1, 0)$: $\mathbf{r}_2 = -t\mathbf{i} + (1 - t)\mathbf{j}$, $0 \leq t \leq 1$, and $\mathbf{F} = (x + y)\mathbf{i} - (x^2 + y^2)\mathbf{j} \Rightarrow \frac{d\mathbf{r}_2}{dt} = -\mathbf{i} - \mathbf{j}$,
 $\mathbf{F} = (1 - 2t)\mathbf{i} - (1 - 2t + 2t^2)\mathbf{j}$, and $\mathbf{n}_2 |\mathbf{v}_2| = -\mathbf{i} + \mathbf{j} \Rightarrow \mathbf{F} \cdot \mathbf{n}_2 |\mathbf{v}_2| = (2t - 1) + (-1 + 2t - 2t^2) = -2 + 4t - 2t^2$
 $\Rightarrow \text{Flux}_2 = \int_0^1 (-2 + 4t - 2t^2) dt = [-2t + 2t^2 - \frac{2}{3} t^3]_0^1 = -\frac{2}{3}$;
 From $(-1, 0)$ to $(1, 0)$: $\mathbf{r}_3 = (-1 + 2t)\mathbf{i}$, $0 \leq t \leq 1$, and $\mathbf{F} = (x + y)\mathbf{i} - (x^2 + y^2)\mathbf{j} \Rightarrow \frac{d\mathbf{r}_3}{dt} = 2\mathbf{i}$,
 $\mathbf{F} = (-1 + 2t)\mathbf{i} - (1 - 4t + 4t^2)\mathbf{j}$, and $\mathbf{n}_3 |\mathbf{v}_3| = -2\mathbf{j} \Rightarrow \mathbf{F} \cdot \mathbf{n}_3 |\mathbf{v}_3| = 2(1 - 4t + 4t^2)$
 $\Rightarrow \text{Flux}_3 = 2 \int_0^1 (1 - 4t + 4t^2) dt = 2 [t - 2t^2 + \frac{4}{3} t^3]_0^1 = \frac{2}{3} \Rightarrow \text{Flux} = \text{Flux}_1 + \text{Flux}_2 + \text{Flux}_3 = \frac{1}{3} - \frac{2}{3} + \frac{2}{3} = \frac{1}{3}$

31. $\mathbf{F} = -\frac{y}{\sqrt{x^2 + y^2}}\mathbf{i} + \frac{x}{\sqrt{x^2 + y^2}}\mathbf{j}$ on $x^2 + y^2 = 4$;
 at $(2, 0)$, $\mathbf{F} = \mathbf{j}$; at $(0, 2)$, $\mathbf{F} = -\mathbf{i}$; at $(-2, 0)$,
 $\mathbf{F} = -\mathbf{j}$; at $(0, -2)$, $\mathbf{F} = \mathbf{i}$; at $(\sqrt{2}, \sqrt{2})$, $\mathbf{F} = -\frac{\sqrt{3}}{2}\mathbf{i} + \frac{1}{2}\mathbf{j}$;
 at $(\sqrt{2}, -\sqrt{2})$, $\mathbf{F} = \frac{\sqrt{3}}{2}\mathbf{i} + \frac{1}{2}\mathbf{j}$; at $(-\sqrt{2}, \sqrt{2})$,
 $\mathbf{F} = -\frac{\sqrt{3}}{2}\mathbf{i} - \frac{1}{2}\mathbf{j}$; at $(-\sqrt{2}, -\sqrt{2})$, $\mathbf{F} = \frac{\sqrt{3}}{2}\mathbf{i} - \frac{1}{2}\mathbf{j}$

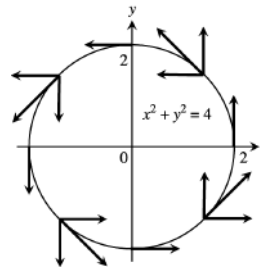

32. $\mathbf{F} = x\mathbf{i} + y\mathbf{j}$ on $x^2 + y^2 = 1$; at $(1, 0)$, $\mathbf{F} = \mathbf{i}$;
 at $(-1, 0)$, $\mathbf{F} = -\mathbf{i}$; at $(0, 1)$, $\mathbf{F} = \mathbf{j}$; at $(0, -1)$,
 $\mathbf{F} = -\mathbf{j}$; at $(\frac{1}{2}, \frac{\sqrt{3}}{2})$, $\mathbf{F} = \frac{1}{2}\mathbf{i} + \frac{\sqrt{3}}{2}\mathbf{j}$;
 at $(-\frac{1}{2}, \frac{\sqrt{3}}{2})$, $\mathbf{F} = -\frac{1}{2}\mathbf{i} + \frac{\sqrt{3}}{2}\mathbf{j}$;
 at $(\frac{1}{2}, -\frac{\sqrt{3}}{2})$, $\mathbf{F} = \frac{1}{2}\mathbf{i} - \frac{\sqrt{3}}{2}\mathbf{j}$;
 at $(-\frac{1}{2}, -\frac{\sqrt{3}}{2})$, $\mathbf{F} = -\frac{1}{2}\mathbf{i} - \frac{\sqrt{3}}{2}\mathbf{j}$.

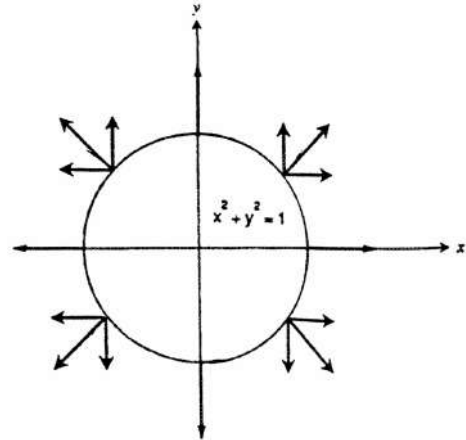

33. (a) $\mathbf{G} = P(x, y)\mathbf{i} + Q(x, y)\mathbf{j}$ is to have a magnitude $\sqrt{a^2 + b^2}$ and to be tangent to $x^2 + y^2 = a^2 + b^2$ in a counterclockwise direction. Thus $x^2 + y^2 = a^2 + b^2 \Rightarrow 2x + 2yy' = 0 \Rightarrow y' = -\frac{x}{y}$ is the slope of the tangent line at any point on the circle $\Rightarrow y' = -\frac{a}{b}$ at (a, b) . Let $\mathbf{v} = -b\mathbf{i} + a\mathbf{j} \Rightarrow |\mathbf{v}| = \sqrt{a^2 + b^2}$, with \mathbf{v} in a counterclockwise direction and tangent to the circle. Then let $P(x, y) = -y$ and $Q(x, y) = x$
 $\Rightarrow \mathbf{G} = -y\mathbf{i} + x\mathbf{j} \Rightarrow$ for (a, b) on $x^2 + y^2 = a^2 + b^2$ we have $\mathbf{G} = -b\mathbf{i} + a\mathbf{j}$ and $|\mathbf{G}| = \sqrt{a^2 + b^2}$.
- (b) $\mathbf{G} = (\sqrt{x^2 + y^2})\mathbf{F} = (\sqrt{a^2 + b^2})\mathbf{F}$.
34. (a) From Exercise 33, part a, $-y\mathbf{i} + x\mathbf{j}$ is a vector tangent to the circle and pointing in a counterclockwise direction $\Rightarrow y\mathbf{i} - x\mathbf{j}$ is a vector tangent to the circle pointing in a clockwise direction $\Rightarrow \mathbf{G} = \frac{y\mathbf{i} - x\mathbf{j}}{\sqrt{x^2 + y^2}}$ is a unit vector tangent to the circle and pointing in a clockwise direction.
- (b) $\mathbf{G} = -\mathbf{F}$
35. The slope of the line through (x, y) and the origin is $\frac{y}{x} \Rightarrow \mathbf{v} = x\mathbf{i} + y\mathbf{j}$ is a vector parallel to that line and pointing away from the origin $\Rightarrow \mathbf{F} = -\frac{x\mathbf{i} + y\mathbf{j}}{\sqrt{x^2 + y^2}}$ is the unit vector pointing toward the origin.
36. (a) From Exercise 35, $-\frac{x\mathbf{i} + y\mathbf{j}}{\sqrt{x^2 + y^2}}$ is a unit vector through (x, y) pointing toward the origin and we want $|\mathbf{F}|$ to have magnitude $\sqrt{x^2 + y^2} \Rightarrow \mathbf{F} = \sqrt{x^2 + y^2} \left(-\frac{x\mathbf{i} + y\mathbf{j}}{\sqrt{x^2 + y^2}} \right) = -x\mathbf{i} - y\mathbf{j}$.
- (b) We want $|\mathbf{F}| = \frac{C}{\sqrt{x^2 + y^2}}$ where $C \neq 0$ is a constant $\Rightarrow \mathbf{F} = \frac{C}{\sqrt{x^2 + y^2}} \left(-\frac{x\mathbf{i} + y\mathbf{j}}{\sqrt{x^2 + y^2}} \right) = -C \left(\frac{x\mathbf{i} + y\mathbf{j}}{x^2 + y^2} \right)$.
37. $\mathbf{F} = -4t^3\mathbf{i} + 8t^2\mathbf{j} + 2\mathbf{k}$ and $\frac{d\mathbf{r}}{dt} = \mathbf{i} + 2t\mathbf{j} \Rightarrow \mathbf{F} \cdot \frac{d\mathbf{r}}{dt} = 12t^3 \Rightarrow \text{Flow} = \int_0^2 12t^3 dt = [3t^4]_0^2 = 48$
38. $\mathbf{F} = 12t^2\mathbf{j} + 9t^2\mathbf{k}$ and $\frac{d\mathbf{r}}{dt} = 3\mathbf{j} + 4\mathbf{k} \Rightarrow \mathbf{F} \cdot \frac{d\mathbf{r}}{dt} = 72t^2 \Rightarrow \text{Flow} = \int_0^1 72t^2 dt = [24t^3]_0^1 = 24$
39. $\mathbf{F} = (\cos t - \sin t)\mathbf{i} + (\cos t)\mathbf{k}$ and $\frac{d\mathbf{r}}{dt} = (-\sin t)\mathbf{i} + (\cos t)\mathbf{k} \Rightarrow \mathbf{F} \cdot \frac{d\mathbf{r}}{dt} = -\sin t \cos t + 1$
 $\Rightarrow \text{Flow} = \int_0^\pi (-\sin t \cos t + 1) dt = [\frac{1}{2} \cos^2 t + t]_0^\pi = (\frac{1}{2} + \pi) - (\frac{1}{2} + 0) = \pi$
40. $\mathbf{F} = (-2 \sin t)\mathbf{i} - (2 \cos t)\mathbf{j} + 2\mathbf{k}$ and $\frac{d\mathbf{r}}{dt} = (2 \sin t)\mathbf{i} + (2 \cos t)\mathbf{j} + 2\mathbf{k} \Rightarrow \mathbf{F} \cdot \frac{d\mathbf{r}}{dt} = -4 \sin^2 t - 4 \cos^2 t + 4 = 0$
 $\Rightarrow \text{Flow} = 0$
41. $C_1: \mathbf{r} = (\cos t)\mathbf{i} + (\sin t)\mathbf{j} + t\mathbf{k}$, $0 \leq t \leq \frac{\pi}{2} \Rightarrow \mathbf{F} = (2 \cos t)\mathbf{i} + 2t\mathbf{j} + (2 \sin t)\mathbf{k}$ and $\frac{d\mathbf{r}}{dt} = (-\sin t)\mathbf{i} + (\cos t)\mathbf{j} + \mathbf{k}$
 $\Rightarrow \mathbf{F} \cdot \frac{d\mathbf{r}}{dt} = -2 \cos t \sin t + 2t \cos t + 2 \sin t = -\sin 2t + 2t \cos t + 2 \sin t$

$$\Rightarrow \text{Flow}_1 = \int_0^{\pi/2} (-\sin 2t + 2t \cos t + 2 \sin t) dt = \left[\frac{1}{2} \cos 2t + 2t \sin t + 2 \cos t - 2 \cos t \right]_0^{\pi/2} = -1 + \pi;$$

$$C_2: \mathbf{r} = \mathbf{j} + \frac{\pi}{2}(1-t)\mathbf{k}, 0 \leq t \leq 1 \Rightarrow \mathbf{F} = \pi(1-t)\mathbf{j} + 2\mathbf{k} \text{ and } \frac{d\mathbf{r}}{dt} = -\frac{\pi}{2}\mathbf{k} \Rightarrow \mathbf{F} \cdot \frac{d\mathbf{r}}{dt} = -\pi$$

$$\Rightarrow \text{Flow}_2 = \int_0^1 -\pi dt = [-\pi t]_0^1 = -\pi;$$

$$C_3: \mathbf{r} = t\mathbf{i} + (1-t)\mathbf{j}, 0 \leq t \leq 1 \Rightarrow \mathbf{F} = 2t\mathbf{i} + 2(1-t)\mathbf{k} \text{ and } \frac{d\mathbf{r}}{dt} = \mathbf{i} - \mathbf{j} \Rightarrow \mathbf{F} \cdot \frac{d\mathbf{r}}{dt} = 2t$$

$$\Rightarrow \text{Flow}_3 = \int_0^1 2t dt = [t^2]_0^1 = 1 \Rightarrow \text{Circulation} = (-1 + \pi) - \pi + 1 = 0$$

42. $\mathbf{F} \cdot \frac{d\mathbf{r}}{dt} = x \frac{dx}{dt} + y \frac{dy}{dt} + z \frac{dz}{dt} = \frac{\partial f}{\partial x} \frac{dx}{dt} + \frac{\partial f}{\partial y} \frac{dy}{dt} + \frac{\partial f}{\partial z} \frac{dz}{dt}$, where $f(x, y, z) = \frac{1}{2}(x^2 + y^2 + z^2) \Rightarrow \mathbf{F} \cdot \frac{d\mathbf{r}}{dt} = \frac{d}{dt}(f(\mathbf{r}(t)))$
by the chain rule $\Rightarrow \text{Circulation} = \int_C \mathbf{F} \cdot \frac{d\mathbf{r}}{dt} dt = \int_a^b \frac{d}{dt}(f(\mathbf{r}(t))) dt = f(\mathbf{r}(b)) - f(\mathbf{r}(a))$. Since C is an entire ellipse, $\mathbf{r}(b) = \mathbf{r}(a)$, thus the Circulation = 0.

43. Let $x = t$ be the parameter $\Rightarrow y = x^2 = t^2$ and $z = x = t \Rightarrow \mathbf{r} = t\mathbf{i} + t^2\mathbf{j} + t\mathbf{k}, 0 \leq t \leq 1$ from $(0, 0, 0)$ to $(1, 1, 1)$
 $\Rightarrow \frac{d\mathbf{r}}{dt} = \mathbf{i} + 2t\mathbf{j} + \mathbf{k}$ and $\mathbf{F} = xy\mathbf{i} + y\mathbf{j} - yz\mathbf{k} = t^3\mathbf{i} + t^2\mathbf{j} - t^3\mathbf{k} \Rightarrow \mathbf{F} \cdot \frac{d\mathbf{r}}{dt} = t^3 + 2t^3 - t^3 = 2t^3 \Rightarrow \text{Flow} = \int_0^1 2t^3 dt = \frac{1}{2}$

44. (a) $\mathbf{F} = \nabla(xy^2z^3) \Rightarrow \mathbf{F} \cdot \frac{d\mathbf{r}}{dt} = \frac{\partial f}{\partial x} \frac{dx}{dt} + \frac{\partial f}{\partial y} \frac{dy}{dt} + \frac{\partial f}{\partial z} \frac{dz}{dt} = \frac{df}{dt}$, where $f(x, y, z) = xy^2z^3 \Rightarrow \oint_C \mathbf{F} \cdot \frac{d\mathbf{r}}{dt} dt = \int_a^b \frac{d}{dt}(f(\mathbf{r}(t))) dt = f(\mathbf{r}(b)) - f(\mathbf{r}(a)) = 0$ since C is an entire ellipse.

(b) $\int_C \mathbf{F} \cdot \frac{d\mathbf{r}}{dt} dt = \int_{(1,1,1)}^{(2,1,-1)} \frac{d}{dt}(xy^2z^3) dt = [xy^2z^3]_{(1,1,1)}^{(2,1,-1)} = (2)(1)^2(-1)^3 - (1)(1)^2(1)^3 = -2 - 1 = -3$

45. Yes. The work and area have the same numerical value because work = $\int_C \mathbf{F} \cdot d\mathbf{r} = \int_C y\mathbf{i} \cdot d\mathbf{r}$
 $= \int_b^a [f(t)\mathbf{i}] \cdot [\mathbf{i} + \frac{df}{dt}\mathbf{j}] dt$ [On the path, y equals $f(t)$]
 $= \int_a^b f(t) dt = \text{Area under the curve}$ [because $f(t) > 0$]

46. $\mathbf{r} = x\mathbf{i} + y\mathbf{j} = x\mathbf{i} + f(x)\mathbf{j} \Rightarrow \frac{d\mathbf{r}}{dx} = \mathbf{i} + f'(x)\mathbf{j}; \mathbf{F} = \frac{k}{\sqrt{x^2 + y^2}}(x\mathbf{i} + y\mathbf{j})$ has constant magnitude k and points away from the origin $\Rightarrow \mathbf{F} \cdot \frac{d\mathbf{r}}{dx} = \frac{kx}{\sqrt{x^2 + y^2}} + \frac{ky \cdot f'(x)}{\sqrt{x^2 + y^2}} = \frac{kx + k \cdot f(x) \cdot f'(x)}{\sqrt{x^2 + [f(x)]^2}} = k \frac{d}{dx} \sqrt{x^2 + [f(x)]^2}$, by the chain rule
 $\Rightarrow \int_C \mathbf{F} \cdot d\mathbf{r} = \int_C \mathbf{F} \cdot \frac{d\mathbf{r}}{dx} dx = \int_a^b k \frac{d}{dx} \sqrt{x^2 + [f(x)]^2} dx = k [\sqrt{x^2 + [f(x)]^2}]_a^b = k(\sqrt{b^2 + [f(b)]^2} - \sqrt{a^2 + [f(a)]^2})$, as claimed.

47-52. Example CAS commands:

Maple:

```
with( LinearAlgebra );#47
F := r -> < r[1]*r[2]^6 | 3*r[1]*(r[1]*r[2]^5+2) >;
r := t -> < 2*cos(t) | sin(t) >;
a,b := 0,2*Pi;
dr := map(diff,r(t),t); # (a)
F(r(t)); # (b)
q1 := simplify( F(r(t)) . dr ) assuming t::real; # (c)
q2 := Int( q1, t=a..b );
value( q2 );
```

Mathematica: (functions and bounds will vary):

Exercises 47 and 48 use vectors in 2 dimensions

```
Clear[x, y, t, f, r, v]
f[x_, y_]:= {x y^6, 3x (x y^5 + 2)}
```

```

{a, b}={0, 2π};
x[t_]:=2 Cos[t]
y[t_]:=Sin[t]
r[t_]:= {x[t], y[t]}
v[t_]:= r'[t]
integrand= f[x[t], y[t]] . v[t] //Simplify
Integrate[integrand,{t, a, b}]
N[%]

```

If the integration takes too long or cannot be done, use NIntegrate to integrate numerically. This is suggested for exercises 49 - 52 that use vectors in 3 dimensions. Be certain to leave spaces between variables to be multiplied.

```

Clear[x, y, z, t, f, r, v]
f[x_, y_, z_]:= {y + y z Cos[x y z], x^2 + x z Cos[x y z], z + x y Cos[x y z]}
{a, b}={0, 2π};
x[t_]:=2 Cos[t]
y[t_]:=3 Sin[t]
z[t_]:=1
r[t_]:= {x[t], y[t], z[t]}
v[t_]:= r'[t]
integrand= f[x[t], y[t], z[t]] . v[t] //Simplify
NIntegrate[integrand,{t, a, b}]

```

16.3 PATH INDEPENDENCE, POTENTIAL FUNCTIONS, AND CONSERVATIVE FIELDS

- $\frac{\partial P}{\partial y} = x = \frac{\partial N}{\partial z}, \frac{\partial M}{\partial z} = y = \frac{\partial P}{\partial x}, \frac{\partial N}{\partial x} = z = \frac{\partial M}{\partial y} \Rightarrow$ Conservative
- $\frac{\partial P}{\partial y} = x \cos z = \frac{\partial N}{\partial z}, \frac{\partial M}{\partial z} = y \cos z = \frac{\partial P}{\partial x}, \frac{\partial N}{\partial x} = \sin z = \frac{\partial M}{\partial y} \Rightarrow$ Conservative
- $\frac{\partial P}{\partial y} = -1 \neq 1 = \frac{\partial N}{\partial z} \Rightarrow$ Not Conservative
- $\frac{\partial N}{\partial x} = 1 \neq -1 = \frac{\partial M}{\partial y} \Rightarrow$ Not Conservative
- $\frac{\partial N}{\partial x} = 0 \neq 1 = \frac{\partial M}{\partial y} \Rightarrow$ Not Conservative
- $\frac{\partial P}{\partial y} = 0 = \frac{\partial N}{\partial z}, \frac{\partial M}{\partial z} = 0 = \frac{\partial P}{\partial x}, \frac{\partial N}{\partial x} = -e^x \sin y = \frac{\partial M}{\partial y} \Rightarrow$ Conservative
- $\frac{\partial f}{\partial x} = 2x \Rightarrow f(x, y, z) = x^2 + g(y, z) \Rightarrow \frac{\partial f}{\partial y} = \frac{\partial g}{\partial y} = 3y \Rightarrow g(y, z) = \frac{3y^2}{2} + h(z) \Rightarrow f(x, y, z) = x^2 + \frac{3y^2}{2} + h(z)$
 $\Rightarrow \frac{\partial f}{\partial z} = h'(z) = 4z \Rightarrow h(z) = 2z^2 + C \Rightarrow f(x, y, z) = x^2 + \frac{3y^2}{2} + 2z^2 + C$
- $\frac{\partial f}{\partial x} = y + z \Rightarrow f(x, y, z) = (y + z)x + g(y, z) \Rightarrow \frac{\partial f}{\partial y} = x + \frac{\partial g}{\partial y} = x + z \Rightarrow \frac{\partial g}{\partial y} = z \Rightarrow g(y, z) = zy + h(z)$
 $\Rightarrow f(x, y, z) = (y + z)x + zy + h(z) \Rightarrow \frac{\partial f}{\partial z} = x + y + h'(z) = x + y \Rightarrow h'(z) = 0 \Rightarrow h(z) = C \Rightarrow f(x, y, z) = (y + z)x + zy + C$
- $\frac{\partial f}{\partial x} = e^{y+2z} \Rightarrow f(x, y, z) = xe^{y+2z} + g(y, z) \Rightarrow \frac{\partial f}{\partial y} = xe^{y+2z} + \frac{\partial g}{\partial y} = xe^{y+2z} \Rightarrow \frac{\partial g}{\partial y} = 0 \Rightarrow f(x, y, z) = xe^{y+2z} + h(z)$
 $\Rightarrow \frac{\partial f}{\partial z} = 2xe^{y+2z} + h'(z) = 2xe^{y+2z} \Rightarrow h'(z) = 0 \Rightarrow h(z) = C \Rightarrow f(x, y, z) = xe^{y+2z} + C$
- $\frac{\partial f}{\partial x} = y \sin z \Rightarrow f(x, y, z) = xy \sin z + g(y, z) \Rightarrow \frac{\partial f}{\partial y} = x \sin z + \frac{\partial g}{\partial y} = x \sin z \Rightarrow \frac{\partial g}{\partial y} = 0 \Rightarrow g(y, z) = h(z)$
 $\Rightarrow f(x, y, z) = xy \sin z + h(z) \Rightarrow \frac{\partial f}{\partial z} = xy \cos z + h'(z) = xy \cos z \Rightarrow h'(z) = 0 \Rightarrow h(z) = C \Rightarrow f(x, y, z) = xy \sin z + C$

11. $\frac{\partial f}{\partial z} = \frac{z}{y^2+z^2} \Rightarrow f(x, y, z) = \frac{1}{2} \ln(y^2 + z^2) + g(x, y) \Rightarrow \frac{\partial f}{\partial x} = \frac{\partial g}{\partial x} = \ln x + \sec^2(x+y) \Rightarrow g(x, y)$
 $= (x \ln x - x) + \tan(x+y) + h(y) \Rightarrow f(x, y, z) = \frac{1}{2} \ln(y^2 + z^2) + (x \ln x - x) + \tan(x+y) + h(y)$
 $\Rightarrow \frac{\partial f}{\partial y} = \frac{y}{y^2+z^2} + \sec^2(x+y) + h'(y) = \sec^2(x+y) + \frac{y}{y^2+z^2} \Rightarrow h'(y) = 0 \Rightarrow h(y) = C \Rightarrow f(x, y, z)$
 $= \frac{1}{2} \ln(y^2 + z^2) + (x \ln x - x) + \tan(x+y) + C$
12. $\frac{\partial f}{\partial x} = \frac{y}{1+x^2y^2} \Rightarrow f(x, y, z) = \tan^{-1}(xy) + g(y, z) \Rightarrow \frac{\partial f}{\partial y} = \frac{x}{1+x^2y^2} + \frac{\partial g}{\partial y} = \frac{x}{1+x^2y^2} + \frac{z}{\sqrt{1-y^2z^2}}$
 $\Rightarrow \frac{\partial g}{\partial y} = \frac{z}{\sqrt{1-y^2z^2}} \Rightarrow g(y, z) = \sin^{-1}(yz) + h(z) \Rightarrow f(x, y, z) = \tan^{-1}(xy) + \sin^{-1}(yz) + h(z)$
 $\Rightarrow \frac{\partial f}{\partial z} = \frac{y}{\sqrt{1-y^2z^2}} + h'(z) = \frac{y}{\sqrt{1-y^2z^2}} + \frac{1}{z} \Rightarrow h'(z) = \frac{1}{z} \Rightarrow h(z) = \ln|z| + C$
 $\Rightarrow f(x, y, z) = \tan^{-1}(xy) + \sin^{-1}(yz) + \ln|z| + C$
13. Let $\mathbf{F}(x, y, z) = 2x\mathbf{i} + 2y\mathbf{j} + 2z\mathbf{k} \Rightarrow \frac{\partial P}{\partial y} = 0 = \frac{\partial N}{\partial z}, \frac{\partial M}{\partial z} = 0 = \frac{\partial P}{\partial x}, \frac{\partial N}{\partial x} = 0 = \frac{\partial M}{\partial y} \Rightarrow M dx + N dy + P dz$ is exact; $\frac{\partial f}{\partial x} = 2x \Rightarrow f(x, y, z) = x^2 + g(y, z) \Rightarrow \frac{\partial f}{\partial y} = \frac{\partial g}{\partial y} = 2y \Rightarrow g(y, z) = y^2 + h(z) \Rightarrow f(x, y, z) = x^2 + y^2 + h(z)$
 $\Rightarrow \frac{\partial f}{\partial z} = h'(z) = 2z \Rightarrow h(z) = z^2 + C \Rightarrow f(x, y, z) = x^2 + y^2 + z^2 + C \Rightarrow \int_{(0,0,0)}^{(2,3,-6)} 2x dx + 2y dy + 2z dz$
 $= f(2, 3, -6) - f(0, 0, 0) = 2^2 + 3^2 + (-6)^2 = 49$
14. Let $\mathbf{F}(x, y, z) = yz\mathbf{i} + xz\mathbf{j} + xy\mathbf{k} \Rightarrow \frac{\partial P}{\partial y} = x = \frac{\partial N}{\partial z}, \frac{\partial M}{\partial z} = y = \frac{\partial P}{\partial x}, \frac{\partial N}{\partial x} = z = \frac{\partial M}{\partial y} \Rightarrow M dx + N dy + P dz$ is exact; $\frac{\partial f}{\partial x} = yz \Rightarrow f(x, y, z) = xyz + g(y, z) \Rightarrow \frac{\partial f}{\partial y} = xz + \frac{\partial g}{\partial y} = xz \Rightarrow \frac{\partial g}{\partial y} = 0 \Rightarrow g(y, z) = h(z) \Rightarrow f(x, y, z) = xyz + h(z)$
 $= xyz + h(z) \Rightarrow \frac{\partial f}{\partial z} = xy + h'(z) = xy \Rightarrow h'(z) = 0 \Rightarrow h(z) = C \Rightarrow f(x, y, z) = xyz + C$
 $\Rightarrow \int_{(1,1,2)}^{(3,5,0)} yz dx + xz dy + xy dz = f(3, 5, 0) - f(1, 1, 2) = 0 - 2 = -2$
15. Let $\mathbf{F}(x, y, z) = 2xy\mathbf{i} + (x^2 - z^2)\mathbf{j} - 2yz\mathbf{k} \Rightarrow \frac{\partial P}{\partial y} = -2z = \frac{\partial N}{\partial z}, \frac{\partial M}{\partial z} = 0 = \frac{\partial P}{\partial x}, \frac{\partial N}{\partial x} = 2x = \frac{\partial M}{\partial y}$
 $\Rightarrow M dx + N dy + P dz$ is exact; $\frac{\partial f}{\partial x} = 2xy \Rightarrow f(x, y, z) = x^2y + g(y, z) \Rightarrow \frac{\partial f}{\partial y} = x^2 + \frac{\partial g}{\partial y} = x^2 - z^2 \Rightarrow \frac{\partial g}{\partial y} = -z^2$
 $\Rightarrow g(y, z) = -yz^2 + h(z) \Rightarrow f(x, y, z) = x^2y - yz^2 + h(z) \Rightarrow \frac{\partial f}{\partial z} = -2yz + h'(z) = -2yz \Rightarrow h'(z) = 0 \Rightarrow h(z) = C$
 $\Rightarrow f(x, y, z) = x^2y - yz^2 + C \Rightarrow \int_{(0,0,0)}^{(1,2,3)} 2xy dx + (x^2 - z^2) dy - 2yz dz = f(1, 2, 3) - f(0, 0, 0) = 2 - 2(3)^2 = -16$
16. Let $\mathbf{F}(x, y, z) = 2x\mathbf{i} - y^2\mathbf{j} - \left(\frac{4}{1+z^2}\right)\mathbf{k} \Rightarrow \frac{\partial P}{\partial y} = 0 = \frac{\partial N}{\partial z}, \frac{\partial M}{\partial z} = 0 = \frac{\partial P}{\partial x}, \frac{\partial N}{\partial x} = 0 = \frac{\partial M}{\partial y}$
 $\Rightarrow M dx + N dy + P dz$ is exact; $\frac{\partial f}{\partial x} = 2x \Rightarrow f(x, y, z) = x^2 + g(y, z) \Rightarrow \frac{\partial f}{\partial y} = \frac{\partial g}{\partial y} = -y^2 \Rightarrow g(y, z) = -\frac{y^3}{3} + h(z)$
 $\Rightarrow f(x, y, z) = x^2 - \frac{y^3}{3} + h(z) \Rightarrow \frac{\partial f}{\partial z} = h'(z) = -\frac{4}{1+z^2} \Rightarrow h(z) = -4 \tan^{-1} z + C \Rightarrow f(x, y, z)$
 $= x^2 - \frac{y^3}{3} - 4 \tan^{-1} z + C \Rightarrow \int_{(0,0,0)}^{(3,3,1)} 2x dx - y^2 dy - \frac{4}{1+z^2} dz = f(3, 3, 1) - f(0, 0, 0)$
 $= \left(9 - \frac{27}{3} - 4 \cdot \frac{\pi}{4}\right) - (0 - 0 - 0) = -\pi$
17. Let $\mathbf{F}(x, y, z) = (\sin y \cos x)\mathbf{i} + (\cos y \sin x)\mathbf{j} + \mathbf{k} \Rightarrow \frac{\partial P}{\partial y} = 0 = \frac{\partial N}{\partial z}, \frac{\partial M}{\partial z} = 0 = \frac{\partial P}{\partial x}, \frac{\partial N}{\partial x} = \cos y \cos x = \frac{\partial M}{\partial y}$
 $\Rightarrow M dx + N dy + P dz$ is exact; $\frac{\partial f}{\partial x} = \sin y \cos x \Rightarrow f(x, y, z) = \sin y \sin x + g(y, z) \Rightarrow \frac{\partial f}{\partial y} = \cos y \sin x + \frac{\partial g}{\partial y}$
 $= \cos y \sin x \Rightarrow \frac{\partial g}{\partial y} = 0 \Rightarrow g(y, z) = h(z) \Rightarrow f(x, y, z) = \sin y \sin x + h(z) \Rightarrow \frac{\partial f}{\partial z} = h'(z) = 1 \Rightarrow h(z) = z + C$
 $\Rightarrow f(x, y, z) = \sin y \sin x + z + C \Rightarrow \int_{(1,0,0)}^{(0,1,1)} \sin y \cos x dx + \cos y \sin x dy + dz = f(0, 1, 1) - f(1, 0, 0)$
 $= (0 + 1) - (0 + 0) = 1$
18. Let $\mathbf{F}(x, y, z) = (2 \cos y)\mathbf{i} + \left(\frac{1}{y} - 2x \sin y\right)\mathbf{j} + \left(\frac{1}{z}\right)\mathbf{k} \Rightarrow \frac{\partial P}{\partial y} = 0 = \frac{\partial N}{\partial z}, \frac{\partial M}{\partial z} = 0 = \frac{\partial P}{\partial x}, \frac{\partial N}{\partial x} = -2 \sin y = \frac{\partial M}{\partial y}$
 $\Rightarrow M dx + N dy + P dz$ is exact; $\frac{\partial f}{\partial x} = 2 \cos y \Rightarrow f(x, y, z) = 2x \cos y + g(y, z) \Rightarrow \frac{\partial f}{\partial y} = -2x \sin y + \frac{\partial g}{\partial y}$
 $= \frac{1}{y} - 2x \sin y \Rightarrow \frac{\partial g}{\partial y} = \frac{1}{y} \Rightarrow g(y, z) = \ln|y| + h(z) \Rightarrow f(x, y, z) = 2x \cos y + \ln|y| + h(z) \Rightarrow \frac{\partial f}{\partial z} = h'(z) = \frac{1}{z}$

1010 Chapter 16 Integration in Vector Fields

$$\begin{aligned} \Rightarrow h(z) &= \ln |z| + C \Rightarrow f(x, y, z) = 2x \cos y + \ln |y| + \ln |z| + C \\ \Rightarrow \int_{(0,2,1)}^{(1,\pi/2,2)} 2 \cos y \, dx + \left(\frac{1}{y} - 2x \sin y\right) dy + \frac{1}{z} dz &= f\left(1, \frac{\pi}{2}, 2\right) - f(0, 2, 1) \\ &= (2 \cdot 0 + \ln \frac{\pi}{2} + \ln 2) - (0 \cdot \cos 2 + \ln 2 + \ln 1) = \ln \frac{\pi}{2} \end{aligned}$$

19. Let $\mathbf{F}(x, y, z) = 3x^2\mathbf{i} + \left(\frac{z^2}{y}\right)\mathbf{j} + (2z \ln y)\mathbf{k} \Rightarrow \frac{\partial P}{\partial y} = \frac{2z}{y} = \frac{\partial N}{\partial z}, \frac{\partial M}{\partial z} = 0 = \frac{\partial P}{\partial x}, \frac{\partial N}{\partial x} = 0 = \frac{\partial M}{\partial y}$
 $\Rightarrow M \, dx + N \, dy + P \, dz$ is exact; $\frac{\partial f}{\partial x} = 3x^2 \Rightarrow f(x, y, z) = x^3 + g(y, z) \Rightarrow \frac{\partial f}{\partial y} = \frac{\partial g}{\partial y} = \frac{z^2}{y} \Rightarrow g(y, z) = z^2 \ln y + h(z)$
 $\Rightarrow f(x, y, z) = x^3 + z^2 \ln y + h(z) \Rightarrow \frac{\partial f}{\partial z} = 2z \ln y + h'(z) = 2z \ln y \Rightarrow h'(z) = 0 \Rightarrow h(z) = C \Rightarrow f(x, y, z)$
 $= x^3 + z^2 \ln y + C \Rightarrow \int_{(1,1,1)}^{(1,2,3)} 3x^2 \, dx + \frac{z^2}{y} \, dy + 2z \ln y \, dz = f(1, 2, 3) - f(1, 1, 1)$
 $= (1 + 9 \ln 2 + C) - (1 + 0 + C) = 9 \ln 2$

20. Let $\mathbf{F}(x, y, z) = (2x \ln y - yz)\mathbf{i} + \left(\frac{x^2}{y} - xz\right)\mathbf{j} - (xy)\mathbf{k} \Rightarrow \frac{\partial P}{\partial y} = -x = \frac{\partial N}{\partial z}, \frac{\partial M}{\partial z} = -y = \frac{\partial P}{\partial x}, \frac{\partial N}{\partial x} = \frac{2x}{y} - z = \frac{\partial M}{\partial y}$
 $\Rightarrow M \, dx + N \, dy + P \, dz$ is exact; $\frac{\partial f}{\partial x} = 2x \ln y - yz \Rightarrow f(x, y, z) = x^2 \ln y - xyz + g(y, z) \Rightarrow \frac{\partial f}{\partial y} = \frac{x^2}{y} - xz + \frac{\partial g}{\partial y}$
 $= \frac{x^2}{y} - xz \Rightarrow \frac{\partial g}{\partial y} = 0 \Rightarrow g(y, z) = h(z) \Rightarrow f(x, y, z) = x^2 \ln y - xyz + h(z) \Rightarrow \frac{\partial f}{\partial z} = -xy + h'(z) = -xy \Rightarrow h'(z) = 0$
 $\Rightarrow h(z) = C \Rightarrow f(x, y, z) = x^2 \ln y - xyz + C \Rightarrow \int_{(1,2,1)}^{(2,1,1)} (2x \ln y - yz) \, dx + \left(\frac{x^2}{y} - xz\right) \, dy - xy \, dz$
 $= f(2, 1, 1) - f(1, 2, 1) = (4 \ln 1 - 2 + C) - (\ln 2 - 2 + C) = -\ln 2$

21. Let $\mathbf{F}(x, y, z) = \left(\frac{1}{y}\right)\mathbf{i} + \left(\frac{1}{z} - \frac{x}{y^2}\right)\mathbf{j} - \left(\frac{y}{z^2}\right)\mathbf{k} \Rightarrow \frac{\partial P}{\partial y} = -\frac{1}{y^2} = \frac{\partial N}{\partial z}, \frac{\partial M}{\partial z} = 0 = \frac{\partial P}{\partial x}, \frac{\partial N}{\partial x} = -\frac{1}{y^2} = \frac{\partial M}{\partial y}$
 $\Rightarrow M \, dx + N \, dy + P \, dz$ is exact; $\frac{\partial f}{\partial x} = \frac{1}{y} \Rightarrow f(x, y, z) = \frac{x}{y} + g(y, z) \Rightarrow \frac{\partial f}{\partial y} = -\frac{x}{y^2} + \frac{\partial g}{\partial y} = \frac{1}{z} - \frac{x}{y^2}$
 $\Rightarrow \frac{\partial g}{\partial y} = \frac{1}{z} \Rightarrow g(y, z) = \frac{y}{z} + h(z) \Rightarrow f(x, y, z) = \frac{x}{y} + \frac{y}{z} + h(z) \Rightarrow \frac{\partial f}{\partial z} = -\frac{y}{z^2} + h'(z) = -\frac{y}{z^2} \Rightarrow h'(z) = 0 \Rightarrow h(z) = C$
 $\Rightarrow f(x, y, z) = \frac{x}{y} + \frac{y}{z} + C \Rightarrow \int_{(1,1,1)}^{(2,2,2)} \frac{1}{y} \, dx + \left(\frac{1}{z} - \frac{x}{y^2}\right) \, dy - \frac{y}{z^2} \, dz = f(2, 2, 2) - f(1, 1, 1) = \left(\frac{2}{2} + \frac{2}{2} + C\right) - \left(\frac{1}{1} + \frac{1}{1} + C\right)$
 $= 0$

22. Let $\mathbf{F}(x, y, z) = \frac{2x\mathbf{i} + 2y\mathbf{j} + 2z\mathbf{k}}{x^2 + y^2 + z^2}$ (and let $\rho^2 = x^2 + y^2 + z^2 \Rightarrow \frac{\partial \rho}{\partial x} = \frac{x}{\rho}, \frac{\partial \rho}{\partial y} = \frac{y}{\rho}, \frac{\partial \rho}{\partial z} = \frac{z}{\rho}$)
 $\Rightarrow \frac{\partial P}{\partial y} = -\frac{4yz}{\rho^4} = \frac{\partial N}{\partial z}, \frac{\partial M}{\partial z} = -\frac{4xz}{\rho^4} = \frac{\partial P}{\partial x}, \frac{\partial N}{\partial x} = -\frac{4xy}{\rho^4} = \frac{\partial M}{\partial y} \Rightarrow M \, dx + N \, dy + P \, dz$ is exact;
 $\frac{\partial f}{\partial x} = \frac{2x}{x^2 + y^2 + z^2} \Rightarrow f(x, y, z) = \ln(x^2 + y^2 + z^2) + g(y, z) \Rightarrow \frac{\partial f}{\partial y} = \frac{2y}{x^2 + y^2 + z^2} + \frac{\partial g}{\partial y} = \frac{2y}{x^2 + y^2 + z^2}$
 $\Rightarrow \frac{\partial g}{\partial y} = 0 \Rightarrow g(y, z) = h(z) \Rightarrow f(x, y, z) = \ln(x^2 + y^2 + z^2) + h(z) \Rightarrow \frac{\partial f}{\partial z} = \frac{2z}{x^2 + y^2 + z^2} + h'(z)$
 $= \frac{2z}{x^2 + y^2 + z^2} \Rightarrow h'(z) = 0 \Rightarrow h(z) = C \Rightarrow f(x, y, z) = \ln(x^2 + y^2 + z^2) + C$
 $\Rightarrow \int_{(-1,-1,-1)}^{(2,2,2)} \frac{2x \, dx + 2y \, dy + 2z \, dz}{x^2 + y^2 + z^2} = f(2, 2, 2) - f(-1, -1, -1) = \ln 12 - \ln 3 = \ln 4$

23. $\mathbf{r} = (t\mathbf{i} + 2t\mathbf{j} + t\mathbf{k}) + (t\mathbf{i} + 2\mathbf{j} - 2t\mathbf{k}) = (1+t)\mathbf{i} + (1+2t)\mathbf{j} + (1-2t)\mathbf{k}, 0 \leq t \leq 1 \Rightarrow dx = dt, dy = 2 \, dt, dz = -2 \, dt$
 $\Rightarrow \int_{(1,1,1)}^{(2,3,-1)} y \, dx + x \, dy + 4 \, dz = \int_0^1 (2t+1) \, dt + (t+1)(2 \, dt) + 4(-2) \, dt = \int_0^1 (4t-5) \, dt = [2t^2 - 5t]_0^1 = -3$

24. $\mathbf{r} = t(3\mathbf{j} + 4\mathbf{k}), 0 \leq t \leq 1 \Rightarrow dx = 0, dy = 3 \, dt, dz = 4 \, dt \Rightarrow \int_{(0,0,0)}^{(0,3,4)} x^2 \, dx + yz \, dy + \left(\frac{y^2}{2}\right) \, dz$
 $= \int_0^1 (12t^2)(3 \, dt) + \left(\frac{9t^2}{2}\right)(4 \, dt) = \int_0^1 54t^2 \, dt = [18t^3]_0^1 = 18$

25. $\frac{\partial P}{\partial y} = 0 = \frac{\partial N}{\partial z}, \frac{\partial M}{\partial z} = 2z = \frac{\partial P}{\partial x}, \frac{\partial N}{\partial x} = 0 = \frac{\partial M}{\partial y} \Rightarrow M \, dx + N \, dy + P \, dz$ is exact $\Rightarrow \mathbf{F}$ is conservative
 \Rightarrow path independence

26. $\frac{\partial P}{\partial y} = -\frac{yz}{(\sqrt{x^2 + y^2 + z^2})^3} = \frac{\partial N}{\partial z}, \frac{\partial M}{\partial z} = -\frac{xz}{(\sqrt{x^2 + y^2 + z^2})^3} = \frac{\partial P}{\partial x}, \frac{\partial N}{\partial x} = -\frac{xy}{(\sqrt{x^2 + y^2 + z^2})^3} = \frac{\partial M}{\partial y}$

$\Rightarrow M dx + N dy + P dz$ is exact $\Rightarrow \mathbf{F}$ is conservative \Rightarrow path independence

$$27. \frac{\partial P}{\partial y} = 0 = \frac{\partial N}{\partial z}, \frac{\partial M}{\partial z} = 0 = \frac{\partial P}{\partial x}, \frac{\partial N}{\partial x} = -\frac{2x}{y^2} = \frac{\partial M}{\partial y} \Rightarrow \mathbf{F} \text{ is conservative} \Rightarrow \text{there exists an } f \text{ so that } \mathbf{F} = \nabla f;$$

$$\frac{\partial f}{\partial x} = \frac{2x}{y} \Rightarrow f(x, y) = \frac{x^2}{y} + g(y) \Rightarrow \frac{\partial f}{\partial y} = -\frac{x^2}{y^2} + g'(y) = \frac{1-x^2}{y^2} \Rightarrow g'(y) = \frac{1}{y^2} \Rightarrow g(y) = -\frac{1}{y} + C$$

$$\Rightarrow f(x, y) = \frac{x^2}{y} - \frac{1}{y} + C \Rightarrow \mathbf{F} = \nabla \left(\frac{x^2-1}{y} \right)$$

$$28. \frac{\partial P}{\partial y} = \cos z = \frac{\partial N}{\partial z}, \frac{\partial M}{\partial z} = 0 = \frac{\partial P}{\partial x}, \frac{\partial N}{\partial x} = e^x = \frac{\partial M}{\partial y} \Rightarrow \mathbf{F} \text{ is conservative} \Rightarrow \text{there exists an } f \text{ so that } \mathbf{F} = \nabla f;$$

$$\frac{\partial f}{\partial x} = e^x \ln y \Rightarrow f(x, y, z) = e^x \ln y + g(y, z) \Rightarrow \frac{\partial f}{\partial y} = \frac{e^x}{y} + \frac{\partial g}{\partial y} = \frac{e^x}{y} + \sin z \Rightarrow \frac{\partial g}{\partial y} = \sin z \Rightarrow g(y, z) = y \sin z + h(z)$$

$$\Rightarrow f(x, y, z) = e^x \ln y + y \sin z + h(z) \Rightarrow \frac{\partial f}{\partial z} = y \cos z + h'(z) = y \cos z \Rightarrow h'(z) = 0$$

$$\Rightarrow h(z) = C \Rightarrow f(x, y, z) = e^x \ln y + y \sin z + C \Rightarrow \mathbf{F} = \nabla (e^x \ln y + y \sin z)$$

$$29. \frac{\partial P}{\partial y} = 0 = \frac{\partial N}{\partial z}, \frac{\partial M}{\partial z} = 0 = \frac{\partial P}{\partial x}, \frac{\partial N}{\partial x} = 1 = \frac{\partial M}{\partial y} \Rightarrow \mathbf{F} \text{ is conservative} \Rightarrow \text{there exists an } f \text{ so that } \mathbf{F} = \nabla f;$$

$$\frac{\partial f}{\partial x} = x^2 + y \Rightarrow f(x, y, z) = \frac{1}{3} x^3 + xy + g(y, z) \Rightarrow \frac{\partial f}{\partial y} = x + \frac{\partial g}{\partial y} = y^2 + x \Rightarrow \frac{\partial g}{\partial y} = y^2 \Rightarrow g(y, z) = \frac{1}{3} y^3 + h(z)$$

$$\Rightarrow f(x, y, z) = \frac{1}{3} x^3 + xy + \frac{1}{3} y^3 + h(z) \Rightarrow \frac{\partial f}{\partial z} = h'(z) = ze^z \Rightarrow h(z) = ze^z - e^z + C \Rightarrow f(x, y, z) = \frac{1}{3} x^3 + xy + \frac{1}{3} y^3 + ze^z - e^z + C$$

$$\Rightarrow \mathbf{F} = \nabla \left(\frac{1}{3} x^3 + xy + \frac{1}{3} y^3 + ze^z - e^z \right)$$

(a) work $= \int_A^B \mathbf{F} \cdot \frac{d\mathbf{r}}{dt} dt = \int_A^B \mathbf{F} \cdot d\mathbf{r} = \left[\frac{1}{3} x^3 + xy + \frac{1}{3} y^3 + ze^z - e^z \right]_{(1,0,0)}^{(1,0,1)} = \left(\frac{1}{3} + 0 + 0 + e - e \right) - \left(\frac{1}{3} + 0 + 0 - 1 \right) = 1$

(b) work $= \int_A^B \mathbf{F} \cdot d\mathbf{r} = \left[\frac{1}{3} x^3 + xy + \frac{1}{3} y^3 + ze^z - e^z \right]_{(1,0,0)}^{(1,0,1)} = 1$

(c) work $= \int_A^B \mathbf{F} \cdot d\mathbf{r} = \left[\frac{1}{3} x^3 + xy + \frac{1}{3} y^3 + ze^z - e^z \right]_{(1,0,0)}^{(1,0,1)} = 1$

Note: Since \mathbf{F} is conservative, $\int_A^B \mathbf{F} \cdot d\mathbf{r}$ is independent of the path from $(1, 0, 0)$ to $(1, 0, 1)$.

$$30. \frac{\partial P}{\partial y} = xe^{yz} + xyze^{yz} + \cos y = \frac{\partial N}{\partial z}, \frac{\partial M}{\partial z} = ye^{yz} = \frac{\partial P}{\partial x}, \frac{\partial N}{\partial x} = ze^{yz} = \frac{\partial M}{\partial y} \Rightarrow \mathbf{F} \text{ is conservative} \Rightarrow \text{there exists an } f \text{ so that } \mathbf{F} = \nabla f;$$

$$\frac{\partial f}{\partial x} = e^{yz} \Rightarrow f(x, y, z) = xe^{yz} + g(y, z) \Rightarrow \frac{\partial f}{\partial y} = xze^{yz} + \frac{\partial g}{\partial y} = xze^{yz} + z \cos y \Rightarrow \frac{\partial g}{\partial y} = z \cos y$$

$$\Rightarrow g(y, z) = z \sin y + h(z) \Rightarrow f(x, y, z) = xe^{yz} + z \sin y + h(z) \Rightarrow \frac{\partial f}{\partial z} = xye^{yz} + \sin y + h'(z) = xye^{yz} + \sin y$$

$$\Rightarrow h'(z) = 0 \Rightarrow h(z) = C \Rightarrow f(x, y, z) = xe^{yz} + z \sin y + C \Rightarrow \mathbf{F} = \nabla (xe^{yz} + z \sin y)$$

(a) work $= \int_A^B \mathbf{F} \cdot d\mathbf{r} = [xe^{yz} + z \sin y]_{(1,0,1)}^{(1,\pi/2,0)} = (1 + 0) - (1 + 0) = 0$

(b) work $= \int_A^B \mathbf{F} \cdot d\mathbf{r} = [xe^{yz} + z \sin y]_{(1,0,1)}^{(1,\pi/2,0)} = 0$

(c) work $= \int_A^B \mathbf{F} \cdot d\mathbf{r} = [xe^{yz} + z \sin y]_{(1,0,1)}^{(1,\pi/2,0)} = 0$

Note: Since \mathbf{F} is conservative, $\int_A^B \mathbf{F} \cdot d\mathbf{r}$ is independent of the path from $(1, 0, 1)$ to $(1, \frac{\pi}{2}, 0)$.

31. (a) $\mathbf{F} = \nabla (x^3y^2) \Rightarrow \mathbf{F} = 3x^2y^2\mathbf{i} + 2x^3y\mathbf{j}$; let C_1 be the path from $(-1, 1)$ to $(0, 0) \Rightarrow x = t - 1$ and $y = -t + 1, 0 \leq t \leq 1 \Rightarrow \mathbf{F} = 3(t-1)^2(-t+1)^2\mathbf{i} + 2(t-1)^3(-t+1)\mathbf{j} = 3(t-1)^4\mathbf{i} - 2(t-1)^4\mathbf{j}$ and $\mathbf{r}_1 = (t-1)\mathbf{i} + (-t+1)\mathbf{j} \Rightarrow d\mathbf{r}_1 = dt\mathbf{i} - dt\mathbf{j} \Rightarrow \int_{C_1} \mathbf{F} \cdot d\mathbf{r}_1 = \int_0^1 [3(t-1)^4 + 2(t-1)^4] dt = \int_0^1 5(t-1)^4 dt = [(t-1)^5]_0^1 = 1$; let C_2 be the path from $(0, 0)$ to $(1, 1) \Rightarrow x = t$ and $y = t, 0 \leq t \leq 1 \Rightarrow \mathbf{F} = 3t^4\mathbf{i} + 2t^4\mathbf{j}$ and $\mathbf{r}_2 = t\mathbf{i} + t\mathbf{j} \Rightarrow d\mathbf{r}_2 = dt\mathbf{i} + dt\mathbf{j} \Rightarrow \int_{C_2} \mathbf{F} \cdot d\mathbf{r}_2 = \int_0^1 (3t^4 + 2t^4) dt = \int_0^1 5t^4 dt = 1 \Rightarrow \int_C \mathbf{F} \cdot d\mathbf{r} = \int_{C_1} \mathbf{F} \cdot d\mathbf{r}_1 + \int_{C_2} \mathbf{F} \cdot d\mathbf{r}_2 = 2$

(b) Since $f(x, y) = x^3y^2$ is a potential function for \mathbf{F} , $\int_{(-1,1)}^{(1,1)} \mathbf{F} \cdot d\mathbf{r} = f(1, 1) - f(-1, 1) = 2$

1012 Chapter 16 Integration in Vector Fields

32. $\frac{\partial P}{\partial y} = 0 = \frac{\partial N}{\partial z}$, $\frac{\partial M}{\partial z} = 0 = \frac{\partial P}{\partial x}$, $\frac{\partial N}{\partial x} = -2x \sin y = \frac{\partial M}{\partial y} \Rightarrow \mathbf{F}$ is conservative \Rightarrow there exists an f so that $\mathbf{F} = \nabla f$;
 $\frac{\partial f}{\partial x} = 2x \cos y \Rightarrow f(x, y, z) = x^2 \cos y + g(y, z) \Rightarrow \frac{\partial f}{\partial y} = -x^2 \sin y + \frac{\partial g}{\partial y} = -x^2 \sin y \Rightarrow \frac{\partial g}{\partial y} = 0 \Rightarrow g(y, z) = h(z)$
 $\Rightarrow f(x, y, z) = x^2 \cos y + h(z) \Rightarrow \frac{\partial f}{\partial z} = h'(z) = 0 \Rightarrow h(z) = C \Rightarrow f(x, y, z) = x^2 \cos y + C \Rightarrow \mathbf{F} = \nabla (x^2 \cos y)$
- (a) $\int_C 2x \cos y \, dx - x^2 \sin y \, dy = [x^2 \cos y]_{(1,0)}^{(0,1)} = 0 - 1 = -1$
 (b) $\int_C 2x \cos y \, dx - x^2 \sin y \, dy = [x^2 \cos y]_{(-1,\pi)}^{(1,0)} = 1 - (-1) = 2$
 (c) $\int_C 2x \cos y \, dx - x^2 \sin y \, dy = [x^2 \cos y]_{(-1,0)}^{(1,0)} = 1 - 1 = 0$
 (d) $\int_C 2x \cos y \, dx - x^2 \sin y \, dy = [x^2 \cos y]_{(1,0)}^{(1,0)} = 1 - 1 = 0$
33. (a) If the differential form is exact, then $\frac{\partial P}{\partial y} = \frac{\partial N}{\partial z} \Rightarrow 2ay = cy$ for all $y \Rightarrow 2a = c$, $\frac{\partial M}{\partial z} = \frac{\partial P}{\partial x} \Rightarrow 2cx = 2cx$ for all x , and $\frac{\partial N}{\partial x} = \frac{\partial M}{\partial y} \Rightarrow by = 2ay$ for all $y \Rightarrow b = 2a$ and $c = 2a$
 (b) $\mathbf{F} = \nabla f \Rightarrow$ the differential form with $a = 1$ in part (a) is exact $\Rightarrow b = 2$ and $c = 2$
34. $\mathbf{F} = \nabla f \Rightarrow \mathbf{g}(x, y, z) = \int_{(0,0,0)}^{(x,y,z)} \mathbf{F} \cdot d\mathbf{r} = \int_{(0,0,0)}^{(x,y,z)} \nabla f \cdot d\mathbf{r} = f(x, y, z) - f(0, 0, 0) \Rightarrow \frac{\partial g}{\partial x} = \frac{\partial f}{\partial x} - 0$, $\frac{\partial g}{\partial y} = \frac{\partial f}{\partial y} - 0$, and $\frac{\partial g}{\partial z} = \frac{\partial f}{\partial z} - 0 \Rightarrow \nabla g = \nabla f = \mathbf{F}$, as claimed
35. The path will not matter; the work along any path will be the same because the field is conservative.
36. The field is not conservative, for otherwise the work would be the same along C_1 and C_2 .
37. Let the coordinates of points A and B be (x_A, y_A, z_A) and (x_B, y_B, z_B) , respectively. The force $\mathbf{F} = a\mathbf{i} + b\mathbf{j} + c\mathbf{k}$ is conservative because all the partial derivatives of M, N, and P are zero. Therefore, the potential function is $f(x, y, z) = ax + by + cz + C$, and the work done by the force in moving a particle along any path from A to B is $f(\mathbf{B}) - f(\mathbf{A}) = f(x_B, y_B, z_B) - f(x_A, y_A, z_A) = (ax_B + by_B + cz_B + C) - (ax_A + by_A + cz_A + C) = a(x_B - x_A) + b(y_B - y_A) + c(z_B - z_A) = \mathbf{F} \cdot \vec{BA}$
38. (a) Let $-GmM = C \Rightarrow \mathbf{F} = C \left[\frac{x}{(x^2 + y^2 + z^2)^{3/2}} \mathbf{i} + \frac{y}{(x^2 + y^2 + z^2)^{3/2}} \mathbf{j} + \frac{z}{(x^2 + y^2 + z^2)^{3/2}} \mathbf{k} \right]$
 $\Rightarrow \frac{\partial P}{\partial y} = \frac{-3yzC}{(x^2 + y^2 + z^2)^{5/2}} = \frac{\partial N}{\partial z}$, $\frac{\partial M}{\partial z} = \frac{-3xzC}{(x^2 + y^2 + z^2)^{5/2}} = \frac{\partial P}{\partial x}$, $\frac{\partial N}{\partial x} = \frac{-3xyC}{(x^2 + y^2 + z^2)^{5/2}} = \frac{\partial M}{\partial y} \Rightarrow \mathbf{F} = \nabla f$ for some f ;
 $\frac{\partial f}{\partial x} = \frac{xC}{(x^2 + y^2 + z^2)^{3/2}} \Rightarrow f(x, y, z) = -\frac{C}{(x^2 + y^2 + z^2)^{1/2}} + g(y, z) \Rightarrow \frac{\partial f}{\partial y} = \frac{yC}{(x^2 + y^2 + z^2)^{3/2}} + \frac{\partial g}{\partial y} = \frac{yC}{(x^2 + y^2 + z^2)^{3/2}} \Rightarrow \frac{\partial g}{\partial y} = 0 \Rightarrow g(y, z) = h(z) \Rightarrow \frac{\partial f}{\partial z} = \frac{zC}{(x^2 + y^2 + z^2)^{3/2}} + h'(z) = \frac{zC}{(x^2 + y^2 + z^2)^{3/2}} \Rightarrow h'(z) = 0 \Rightarrow h(z) = C_1 \Rightarrow f(x, y, z) = -\frac{C}{(x^2 + y^2 + z^2)^{1/2}} + C_1$. Let $C_1 = 0 \Rightarrow f(x, y, z) = \frac{GmM}{(x^2 + y^2 + z^2)^{1/2}}$ is a potential function for \mathbf{F} .
 (b) If s is the distance of (x, y, z) from the origin, then $s = \sqrt{x^2 + y^2 + z^2}$. The work done by the gravitational field \mathbf{F} is work $= \int_{P_1}^{P_2} \mathbf{F} \cdot d\mathbf{r} = \left[\frac{GmM}{\sqrt{x^2 + y^2 + z^2}} \right]_{P_1}^{P_2} = \frac{GmM}{s_2} - \frac{GmM}{s_1} = GmM \left(\frac{1}{s_2} - \frac{1}{s_1} \right)$, as claimed.

16.4 GREEN'S THEOREM IN THE PLANE

1. $M = -y = -a \sin t$, $N = x = a \cos t$, $dx = -a \sin t \, dt$, $dy = a \cos t \, dt \Rightarrow \frac{\partial M}{\partial x} = 0$, $\frac{\partial M}{\partial y} = -1$, $\frac{\partial N}{\partial x} = 1$, and $\frac{\partial N}{\partial y} = 0$;
 Equation (11): $\oint_C M \, dy - N \, dx = \int_0^{2\pi} [(-a \sin t)(a \cos t) - (a \cos t)(-a \sin t)] \, dt = \int_0^{2\pi} 0 \, dt = 0$;
 $\iint_R \left(\frac{\partial M}{\partial x} + \frac{\partial N}{\partial y} \right) dx \, dy = \iint_R 0 \, dx \, dy = 0$, Flux

$$\text{Equation (12): } \oint_C \mathbf{M} \, dx + \mathbf{N} \, dy = \int_0^{2\pi} [(-a \sin t)(-a \sin t) - (a \cos t)(a \cos t)] \, dt = \int_0^{2\pi} a^2 \, dt = 2\pi a^2;$$

$$\begin{aligned} \iint_R \left(\frac{\partial \mathbf{N}}{\partial x} - \frac{\partial \mathbf{M}}{\partial y} \right) dx \, dy &= \int_{-a}^a \int_{-c}^{\sqrt{a^2-x^2}} 2 \, dy \, dx = \int_{-a}^a 4\sqrt{a^2-x^2} \, dx = 4 \left[\frac{x}{2} \sqrt{a^2-x^2} + \frac{a^2}{2} \sin^{-1} \frac{x}{a} \right]_{-a}^a \\ &= 2a^2 \left(\frac{\pi}{2} + \frac{\pi}{2} \right) = 2a^2\pi, \text{ Circulation} \end{aligned}$$

$$2. \quad \mathbf{M} = y = a \sin t, \mathbf{N} = 0, dx = -a \sin t \, dt, dy = a \cos t \, dt \Rightarrow \frac{\partial \mathbf{M}}{\partial x} = 0, \frac{\partial \mathbf{M}}{\partial y} = 1, \frac{\partial \mathbf{N}}{\partial x} = 0, \text{ and } \frac{\partial \mathbf{N}}{\partial y} = 0;$$

$$\text{Equation (11): } \oint_C \mathbf{M} \, dy - \mathbf{N} \, dx = \int_0^{2\pi} a^2 \sin t \cos t \, dt = a^2 \left[\frac{1}{2} \sin^2 t \right]_0^{2\pi} = 0; \iint_R 0 \, dx \, dy = 0, \text{ Flux}$$

$$\begin{aligned} \text{Equation (12): } \oint_C \mathbf{M} \, dx + \mathbf{N} \, dy &= \int_0^{2\pi} (-a^2 \sin^2 t) \, dt = -a^2 \left[\frac{t}{2} - \frac{\sin 2t}{4} \right]_0^{2\pi} = -\pi a^2; \iint_R \left(\frac{\partial \mathbf{N}}{\partial x} - \frac{\partial \mathbf{M}}{\partial y} \right) dx \, dy \\ &= \iint_R -1 \, dx \, dy = \int_0^{2\pi} \int_0^a -r \, dr \, d\theta = \int_0^{2\pi} -\frac{a^2}{2} \, d\theta = -\pi a^2, \text{ Circulation} \end{aligned}$$

$$3. \quad \mathbf{M} = 2x = 2a \cos t, \mathbf{N} = -3y = -3a \sin t, dx = -a \sin t \, dt, dy = a \cos t \, dt \Rightarrow \frac{\partial \mathbf{M}}{\partial x} = 2, \frac{\partial \mathbf{M}}{\partial y} = 0, \frac{\partial \mathbf{N}}{\partial x} = 0, \text{ and } \frac{\partial \mathbf{N}}{\partial y} = -3;$$

$$\begin{aligned} \text{Equation (11): } \oint_C \mathbf{M} \, dy - \mathbf{N} \, dx &= \int_0^{2\pi} [(2a \cos t)(a \cos t) + (3a \sin t)(-a \sin t)] \, dt \\ &= \int_0^{2\pi} (2a^2 \cos^2 t - 3a^2 \sin^2 t) \, dt = 2a^2 \left[\frac{t}{2} + \frac{\sin 2t}{4} \right]_0^{2\pi} - 3a^2 \left[\frac{t}{2} - \frac{\sin 2t}{4} \right]_0^{2\pi} = 2\pi a^2 - 3\pi a^2 = -\pi a^2; \end{aligned}$$

$$\iint_R \left(\frac{\partial \mathbf{M}}{\partial x} + \frac{\partial \mathbf{N}}{\partial y} \right) dx \, dy = \iint_R -1 \, dx \, dy = \int_0^{2\pi} \int_0^a -r \, dr \, d\theta = \int_0^{2\pi} -\frac{a^2}{2} \, d\theta = -\pi a^2, \text{ Flux}$$

$$\begin{aligned} \text{Equation (12): } \oint_C \mathbf{M} \, dx + \mathbf{N} \, dy &= \int_0^{2\pi} [(2a \cos t)(-a \sin t) + (-3a \sin t)(a \cos t)] \, dt \\ &= \int_0^{2\pi} (-2a^2 \sin t \cos t - 3a^2 \sin t \cos t) \, dt = -5a^2 \left[\frac{1}{2} \sin^2 t \right]_0^{2\pi} = 0; \iint_R 0 \, dx \, dy = 0, \text{ Circulation} \end{aligned}$$

$$4. \quad \mathbf{M} = -x^2 y = -a^3 \cos^2 t, \mathbf{N} = xy^2 = a^3 \cos t \sin^2 t, dx = -a \sin t \, dt, dy = a \cos t \, dt \\ \Rightarrow \frac{\partial \mathbf{M}}{\partial x} = -2xy, \frac{\partial \mathbf{M}}{\partial y} = -x^2, \frac{\partial \mathbf{N}}{\partial x} = y^2, \text{ and } \frac{\partial \mathbf{N}}{\partial y} = 2xy;$$

$$\text{Equation (11): } \oint_C \mathbf{M} \, dy - \mathbf{N} \, dx = \int_0^{2\pi} (-a^4 \cos^3 t \sin t + a^4 \cos t \sin^3 t) = \left[\frac{a^4}{4} \cos^4 t + \frac{a^4}{4} \sin^4 t \right]_0^{2\pi} = 0;$$

$$\iint_R \left(\frac{\partial \mathbf{M}}{\partial x} + \frac{\partial \mathbf{N}}{\partial y} \right) dx \, dy = \iint_R (-2xy + 2xy) \, dx \, dy = 0, \text{ Flux}$$

$$\begin{aligned} \text{Equation (12): } \oint_C \mathbf{M} \, dx + \mathbf{N} \, dy &= \int_0^{2\pi} (a^4 \cos^2 t \sin^2 t + a^4 \cos^2 t \sin^2 t) \, dt = \int_0^{2\pi} (2a^4 \cos^2 t \sin^2 t) \, dt \\ &= \int_0^{2\pi} \frac{1}{2} a^4 \sin^2 2t \, dt = \frac{a^4}{4} \int_0^{4\pi} \sin^2 u \, du = \frac{a^4}{4} \left[\frac{u}{2} - \frac{\sin 2u}{4} \right]_0^{4\pi} = \frac{\pi a^4}{2}; \iint_R \left(\frac{\partial \mathbf{N}}{\partial x} - \frac{\partial \mathbf{M}}{\partial y} \right) dx \, dy = \iint_R (y^2 + x^2) \, dx \, dy \\ &= \int_0^{2\pi} \int_0^a r^2 \cdot r \, dr \, d\theta = \int_0^{2\pi} \frac{a^4}{4} \, d\theta = \frac{\pi a^4}{2}, \text{ Circulation} \end{aligned}$$

$$5. \quad \mathbf{M} = x - y, \mathbf{N} = y - x \Rightarrow \frac{\partial \mathbf{M}}{\partial x} = 1, \frac{\partial \mathbf{M}}{\partial y} = -1, \frac{\partial \mathbf{N}}{\partial x} = -1, \frac{\partial \mathbf{N}}{\partial y} = 1 \Rightarrow \text{Flux} = \iint_R 2 \, dx \, dy = \int_0^1 \int_0^1 2 \, dx \, dy = 2;$$

$$\text{Circ} = \iint_R [-1 - (-1)] \, dx \, dy = 0$$

$$6. \quad \mathbf{M} = x^2 + 4y, \mathbf{N} = x + y^2 \Rightarrow \frac{\partial \mathbf{M}}{\partial x} = 2x, \frac{\partial \mathbf{M}}{\partial y} = 4, \frac{\partial \mathbf{N}}{\partial x} = 1, \frac{\partial \mathbf{N}}{\partial y} = 2y \Rightarrow \text{Flux} = \iint_R (2x + 2y) \, dx \, dy$$

$$= \int_0^1 \int_0^1 (2x + 2y) \, dx \, dy = \int_0^1 [x^2 + 2xy]_0^1 \, dy = \int_0^1 (1 + 2y) \, dy = [y + y^2]_0^1 = 2; \text{Circ} = \iint_R (1 - 4) \, dx \, dy$$

$$= \int_0^1 \int_0^1 -3 \, dx \, dy = -3$$

1014 Chapter 16 Integration in Vector Fields

7. $M = y^2 - x^2, N = x^2 + y^2 \Rightarrow \frac{\partial M}{\partial x} = -2x, \frac{\partial M}{\partial y} = 2y, \frac{\partial N}{\partial x} = 2x, \frac{\partial N}{\partial y} = 2y \Rightarrow \text{Flux} = \iint_{\mathbf{R}} (-2x + 2y) \, dx \, dy$
 $= \int_0^3 \int_0^x (-2x + 2y) \, dy \, dx = \int_0^3 (-2x^2 + x^2) \, dx = \left[-\frac{1}{3}x^3\right]_0^3 = -9; \text{Circ} = \iint_{\mathbf{R}} (2x - 2y) \, dx \, dy$
 $= \int_0^3 \int_0^x (2x - 2y) \, dy \, dx = \int_0^3 x^2 \, dx = 9$
8. $M = x + y, N = -(x^2 + y^2) \Rightarrow \frac{\partial M}{\partial x} = 1, \frac{\partial M}{\partial y} = 1, \frac{\partial N}{\partial x} = -2x, \frac{\partial N}{\partial y} = -2y \Rightarrow \text{Flux} = \iint_{\mathbf{R}} (1 - 2y) \, dx \, dy$
 $= \int_0^1 \int_0^x (1 - 2y) \, dy \, dx = \int_0^1 (x - x^2) \, dx = \frac{1}{6}; \text{Circ} = \iint_{\mathbf{R}} (-2x - 1) \, dx \, dy = \int_0^1 \int_0^x (-2x - 1) \, dy \, dx$
 $= \int_0^1 (-2x^2 - x) \, dx = -\frac{7}{6}$
9. $M = x + e^x \sin y, N = x + e^x \cos y \Rightarrow \frac{\partial M}{\partial x} = 1 + e^x \sin y, \frac{\partial M}{\partial y} = e^x \cos y, \frac{\partial N}{\partial x} = 1 + e^x \cos y, \frac{\partial N}{\partial y} = -e^x \sin y$
 $\Rightarrow \text{Flux} = \iint_{\mathbf{R}} dx \, dy = \int_{-\pi/4}^{\pi/4} \int_0^{\sqrt{\cos 2\theta}} r \, dr \, d\theta = \int_{-\pi/4}^{\pi/4} \left(\frac{1}{2} \cos 2\theta\right) d\theta = \left[\frac{1}{4} \sin 2\theta\right]_{-\pi/4}^{\pi/4} = \frac{1}{2};$
 $\text{Circ} = \iint_{\mathbf{R}} (1 + e^x \cos y - e^x \cos y) \, dx \, dy = \iint_{\mathbf{R}} dx \, dy = \int_{-\pi/4}^{\pi/4} \int_0^{\sqrt{\cos 2\theta}} r \, dr \, d\theta = \int_{-\pi/4}^{\pi/4} \left(\frac{1}{2} \cos 2\theta\right) d\theta = \frac{1}{2}$
10. $M = \tan^{-1} \frac{y}{x}, N = \ln(x^2 + y^2) \Rightarrow \frac{\partial M}{\partial x} = \frac{-y}{x^2 + y^2}, \frac{\partial M}{\partial y} = \frac{x}{x^2 + y^2}, \frac{\partial N}{\partial x} = \frac{2x}{x^2 + y^2}, \frac{\partial N}{\partial y} = \frac{2y}{x^2 + y^2}$
 $\Rightarrow \text{Flux} = \iint_{\mathbf{R}} \left(\frac{-y}{x^2 + y^2} + \frac{2y}{x^2 + y^2}\right) dx \, dy = \int_0^{\pi} \int_1^2 \left(\frac{r \sin \theta}{r^2}\right) r \, dr \, d\theta = \int_0^{\pi} \sin \theta \, d\theta = 2;$
 $\text{Circ} = \iint_{\mathbf{R}} \left(\frac{2x}{x^2 + y^2} - \frac{x}{x^2 + y^2}\right) dx \, dy = \int_0^{\pi} \int_1^2 \left(\frac{r \cos \theta}{r^2}\right) r \, dr \, d\theta = \int_0^{\pi} \cos \theta \, d\theta = 0$
11. $M = xy, N = y^2 \Rightarrow \frac{\partial M}{\partial x} = y, \frac{\partial M}{\partial y} = x, \frac{\partial N}{\partial x} = 0, \frac{\partial N}{\partial y} = 2y \Rightarrow \text{Flux} = \iint_{\mathbf{R}} (y + 2y) \, dy \, dx = \int_0^1 \int_x^x 3y \, dy \, dx$
 $= \int_0^1 \left(\frac{3x^2}{2} - \frac{3x^4}{2}\right) dx = \frac{1}{5}; \text{Circ} = \iint_{\mathbf{R}} -x \, dy \, dx = \int_0^1 \int_x^x -x \, dy \, dx = \int_0^1 (-x^2 + x^3) \, dx = -\frac{1}{12}$
12. $M = -\sin y, N = x \cos y \Rightarrow \frac{\partial M}{\partial x} = 0, \frac{\partial M}{\partial y} = -\cos y, \frac{\partial N}{\partial x} = \cos y, \frac{\partial N}{\partial y} = -x \sin y$
 $\Rightarrow \text{Flux} = \iint_{\mathbf{R}} (-x \sin y) \, dx \, dy = \int_0^{\pi/2} \int_0^{\pi/2} (-x \sin y) \, dx \, dy = \int_0^{\pi/2} \left(-\frac{\pi^2}{8} \sin y\right) dy = -\frac{\pi^2}{8};$
 $\text{Circ} = \iint_{\mathbf{R}} [\cos y - (-\cos y)] \, dx \, dy = \int_0^{\pi/2} \int_0^{\pi/2} 2 \cos y \, dx \, dy = \int_0^{\pi/2} \pi \cos y \, dy = [\pi \sin y]_0^{\pi/2} = \pi$
13. $M = 3xy - \frac{x}{1+y^2}, N = e^x + \tan^{-1} y \Rightarrow \frac{\partial M}{\partial x} = 3y - \frac{1}{1+y^2}, \frac{\partial M}{\partial y} = \frac{1}{1+y^2}$
 $\Rightarrow \text{Flux} = \iint_{\mathbf{R}} \left(3y - \frac{1}{1+y^2} + \frac{1}{1+y^2}\right) dx \, dy = \iint_{\mathbf{R}} 3y \, dx \, dy = \int_0^{2\pi} \int_0^{a(1+\cos \theta)} (3r \sin \theta) r \, dr \, d\theta$
 $= \int_0^{2\pi} a^3 (1 + \cos \theta)^3 (\sin \theta) \, d\theta = \left[-\frac{a^3}{4} (1 + \cos \theta)^4\right]_0^{2\pi} = -4a^3 - (-4a^3) = 0$
14. $M = y + e^x \ln y, N = \frac{e^x}{y} \Rightarrow \frac{\partial M}{\partial y} = 1 + \frac{e^x}{y}, \frac{\partial N}{\partial x} = \frac{e^x}{y} \Rightarrow \text{Circ} = \iint_{\mathbf{R}} \left[\frac{e^x}{y} - \left(1 + \frac{e^x}{y}\right)\right] dx \, dy = \iint_{\mathbf{R}} (-1) \, dx \, dy$
 $= \int_{-1}^1 \int_{x^2+1}^{3-x^2} -1 \, dy \, dx = -\int_{-1}^1 [(3-x^2) - (x^2+1)] \, dx = \int_{-1}^1 (x^4 + x^2 - 2) \, dx = -\frac{44}{15}$
15. $M = 2xy^3, N = 4x^2y^2 \Rightarrow \frac{\partial M}{\partial y} = 6xy^2, \frac{\partial N}{\partial x} = 8xy^2 \Rightarrow \text{work} = \oint_{\mathbf{C}} 2xy^3 \, dx + 4x^2y^2 \, dy = \iint_{\mathbf{R}} (8xy^2 - 6xy^2) \, dx \, dy$
 $= \int_0^1 \int_0^{x^3} 2xy^2 \, dy \, dx = \int_0^1 \frac{2}{3} x^{10} \, dx = \frac{2}{33}$

$$16. M = 4x - 2y, N = 2x - 4y \Rightarrow \frac{\partial M}{\partial y} = -2, \frac{\partial N}{\partial x} = 2 \Rightarrow \text{work} = \oint_C (4x - 2y) dx + (2x - 4y) dy \\ = \iint_R [2 - (-2)] dx dy = 4 \iint_R dx dy = 4(\text{Area of the circle}) = 4(\pi \cdot 4) = 16\pi$$

$$17. M = y^2, N = x^2 \Rightarrow \frac{\partial M}{\partial y} = 2y, \frac{\partial N}{\partial x} = 2x \Rightarrow \oint_C y^2 dx + x^2 dy = \iint_R (2x - 2y) dy dx \\ = \int_0^1 \int_0^{1-x} (2x - 2y) dy dx = \int_0^1 (-3x^2 + 4x - 1) dx = [-x^3 + 2x^2 - x]_0^1 = -1 + 2 - 1 = 0$$

$$18. M = 3y, N = 2x \Rightarrow \frac{\partial M}{\partial y} = 3, \frac{\partial N}{\partial x} = 2 \Rightarrow \oint_C 3y dx + 2x dy = \iint_R (2 - 3) dx dy = \int_0^\pi \int_0^{\sin x} -1 dy dx \\ = -\int_0^\pi \sin x dx = -2$$

$$19. M = 6y + x, N = y + 2x \Rightarrow \frac{\partial M}{\partial y} = 6, \frac{\partial N}{\partial x} = 2 \Rightarrow \oint_C (6y + x) dx + (y + 2x) dy = \iint_R (2 - 6) dy dx \\ = -4(\text{Area of the circle}) = -16\pi$$

$$20. M = 2x + y^2, N = 2xy + 3y \Rightarrow \frac{\partial M}{\partial y} = 2y, \frac{\partial N}{\partial x} = 2y \Rightarrow \oint_C (2x + y^2) dx + (2xy + 3y) dy = \iint_R (2y - 2y) dx dy = 0$$

$$21. M = x = a \cos t, N = y = a \sin t \Rightarrow dx = -a \sin t dt, dy = a \cos t dt \Rightarrow \text{Area} = \frac{1}{2} \oint_C x dy - y dx \\ = \frac{1}{2} \int_0^{2\pi} (a^2 \cos^2 t + a^2 \sin^2 t) dt = \frac{1}{2} \int_0^{2\pi} a^2 dt = \pi a^2$$

$$22. M = x = a \cos t, N = y = b \sin t \Rightarrow dx = -a \sin t dt, dy = b \cos t dt \Rightarrow \text{Area} = \frac{1}{2} \oint_C x dy - y dx \\ = \frac{1}{2} \int_0^{2\pi} (ab \cos^2 t + ab \sin^2 t) dt = \frac{1}{2} \int_0^{2\pi} ab dt = \pi ab$$

$$23. M = x = a \cos^3 t, N = y = \sin^3 t \Rightarrow dx = -3 \cos^2 t \sin t dt, dy = 3 \sin^2 t \cos t dt \Rightarrow \text{Area} = \frac{1}{2} \oint_C x dy - y dx \\ = \frac{1}{2} \int_0^{2\pi} (3 \sin^2 t \cos^2 t) (\cos^2 t + \sin^2 t) dt = \frac{1}{2} \int_0^{2\pi} (3 \sin^2 t \cos^2 t) dt = \frac{3}{8} \int_0^{2\pi} \sin^2 2t dt = \frac{3}{16} \int_0^{4\pi} \sin^2 u du \\ = \frac{3}{16} \left[\frac{u}{2} - \frac{\sin 2u}{4} \right]_0^{4\pi} = \frac{3}{8} \pi$$

$$24. M = x = t^2, N = y = \frac{t^3}{3} - t \Rightarrow dx = 2t dt, dy = (t^2 - 1) dt \Rightarrow \text{Area} = \frac{1}{2} \oint_C x dy - y dx \\ = \frac{1}{2} \int_{-\sqrt{3}}^{\sqrt{3}} \left[t^2 (t^2 - 1) - \left(\frac{t^3}{3} - t \right) (2t) \right] dt = \frac{1}{2} \int_{-\sqrt{3}}^{\sqrt{3}} \left(\frac{1}{3} t^4 + t^2 \right) dt = \frac{1}{2} \left[\frac{1}{15} t^5 + -\frac{1}{3} t^3 \right]_{-\sqrt{3}}^{\sqrt{3}} = \frac{1}{15} (9\sqrt{3} + 15\sqrt{3}) \\ = \frac{8}{5} \sqrt{3}$$

$$25. (a) M = f(x), N = g(y) \Rightarrow \frac{\partial M}{\partial y} = 0, \frac{\partial N}{\partial x} = 0 \Rightarrow \oint_C f(x) dx + g(y) dy = \iint_R \left(\frac{\partial N}{\partial x} - \frac{\partial M}{\partial y} \right) dx dy \\ = \iint_R 0 dx dy = 0$$

$$(b) M = ky, N = hx \Rightarrow \frac{\partial M}{\partial y} = k, \frac{\partial N}{\partial x} = h \Rightarrow \oint_C ky dx + hx dy = \iint_R \left(\frac{\partial N}{\partial x} - \frac{\partial M}{\partial y} \right) dx dy \\ = \iint_R (h - k) dx dy = (h - k)(\text{Area of the region})$$

$$26. M = xy^2, N = x^2y + 2x \Rightarrow \frac{\partial M}{\partial y} = 2xy, \frac{\partial N}{\partial x} = 2xy + 2 \Rightarrow \oint_C xy^2 dx + (x^2y + 2x) dy = \iint_R \left(\frac{\partial N}{\partial x} - \frac{\partial M}{\partial y} \right) dx dy \\ = \iint_R (2xy + 2 - 2xy) dx dy = 2 \iint_R dx dy = 2 \text{ times the area of the square}$$

27. The integral is 0 for any simple closed plane curve C . The reasoning: By the tangential form of Green's

$$\begin{aligned} \text{Theorem, with } M &= 4x^3y \text{ and } N = x^4, \oint_C 4x^3y \, dx + x^4 \, dy = \iint_R \left[\frac{\partial}{\partial x}(x^4) - \frac{\partial}{\partial y}(4x^3y) \right] dx \, dy \\ &= \iint_R \underbrace{(4x^3 - 4x^3)}_0 dx \, dy = 0. \end{aligned}$$

28. The integral is 0 for any simple closed curve C . The reasoning: By the normal form of Green's theorem, with

$$M = x^3 \text{ and } N = -y^3, \oint_C -y^3 \, dy + x^3 \, dx = \iint_R \left[\underbrace{\frac{\partial}{\partial x}(-y^3)}_0 - \underbrace{\frac{\partial}{\partial y}(x^3)}_0 \right] dx \, dy = 0.$$

$$\begin{aligned} 29. \text{ Let } M = x \text{ and } N = 0 &\Rightarrow \frac{\partial M}{\partial x} = 1 \text{ and } \frac{\partial N}{\partial y} = 0 \Rightarrow \oint_C M \, dy - N \, dx = \iint_R \left(\frac{\partial M}{\partial x} + \frac{\partial N}{\partial y} \right) dx \, dy \Rightarrow \oint_C x \, dy \\ &= \iint_R (1 + 0) dx \, dy \Rightarrow \text{Area of } R = \iint_R dx \, dy = \oint_C x \, dy; \text{ similarly, } M = y \text{ and } N = 0 \Rightarrow \frac{\partial M}{\partial y} = 1 \text{ and} \\ \frac{\partial N}{\partial x} &= 0 \Rightarrow \oint_C M \, dx + N \, dy = \iint_R \left(\frac{\partial N}{\partial x} + \frac{\partial M}{\partial y} \right) dy \, dx \Rightarrow \oint_C y \, dx = \iint_R (0 + 1) dy \, dx \Rightarrow - \oint_C y \, dx \\ &= \iint_R dx \, dy = \text{Area of } R \end{aligned}$$

$$30. \int_a^b f(x) \, dx = \text{Area of } R = - \oint_C y \, dx, \text{ from Exercise 29}$$

$$\begin{aligned} 31. \text{ Let } \delta(x, y) = 1 &\Rightarrow \bar{x} = \frac{M_x}{M} = \frac{\iint_R x \delta(x, y) \, dA}{\iint_R \delta(x, y) \, dA} = \frac{\iint_R x \, dA}{\iint_R dA} = \frac{\iint_R x \, dA}{A} \Rightarrow A\bar{x} = \iint_R x \, dA = \iint_R (x + 0) dx \, dy \\ &= \oint_C \frac{x^2}{2} \, dy, A\bar{x} = \iint_R x \, dA = \iint_R (0 + x) dx \, dy = - \oint_C xy \, dx, \text{ and } A\bar{x} = \iint_R x \, dA = \iint_R \left(\frac{2}{3}x + \frac{1}{3}x \right) dx \, dy \\ &= \oint_C \frac{1}{3}x^2 \, dy - \frac{1}{3}xy \, dx \Rightarrow \frac{1}{2} \oint_C x^2 \, dy = - \oint_C xy \, dx = \frac{1}{3} \oint_C x^2 \, dy - xy \, dx = A\bar{x} \end{aligned}$$

$$\begin{aligned} 32. \text{ If } \delta(x, y) = 1, \text{ then } I_y &= \iint_R x^2 \delta(x, y) \, dA = \iint_R x^2 \, dA = \iint_R (x^2 + 0) dy \, dx = \frac{1}{3} \oint_C x^3 \, dy, \\ \iint_R x^2 \, dA &= \iint_R (0 + x^2) dy \, dx = - \oint_C x^2y \, dx, \text{ and } \iint_R x^2 \, dA = \iint_R \left(\frac{3}{4}x^2 + \frac{1}{4}x^2 \right) dy \, dx \\ &= \oint_C \frac{1}{4}x^3 \, dy - \frac{1}{4}x^2y \, dx = \frac{1}{4} \oint_C x^3 \, dy - x^2y \, dx \Rightarrow \frac{1}{3} \oint_C x^3 \, dy = - \oint_C x^2y \, dx = \frac{1}{4} \oint_C x^3 \, dy - x^2y \, dx = I_y \end{aligned}$$

$$33. M = \frac{\partial f}{\partial y}, N = -\frac{\partial f}{\partial x} \Rightarrow \frac{\partial M}{\partial y} = \frac{\partial^2 f}{\partial y^2}, \frac{\partial N}{\partial x} = -\frac{\partial^2 f}{\partial x^2} \Rightarrow \oint_C \frac{\partial f}{\partial y} \, dx - \frac{\partial f}{\partial x} \, dy = \iint_R \left(-\frac{\partial^2 f}{\partial x^2} - \frac{\partial^2 f}{\partial y^2} \right) dx \, dy = 0 \text{ for such curves } C$$

$$\begin{aligned} 34. M = \frac{1}{4}x^2y + \frac{1}{3}y^3, N = x &\Rightarrow \frac{\partial M}{\partial y} = \frac{1}{4}x^2 + y^2, \frac{\partial N}{\partial x} = 1 \Rightarrow \text{Curl} = \frac{\partial N}{\partial x} - \frac{\partial M}{\partial y} = 1 - \left(\frac{1}{4}x^2 + y^2 \right) > 0 \text{ in the interior of} \\ \text{the ellipse } \frac{1}{4}x^2 + y^2 &= 1 \Rightarrow \text{work} = \int_C \mathbf{F} \cdot d\mathbf{r} = \iint_R \left(1 - \frac{1}{4}x^2 - y^2 \right) dx \, dy \text{ will be maximized on the region} \\ R = \{(x, y) \mid \text{curl } \mathbf{F} \geq 0\} &\geq 0 \text{ or over the region enclosed by } 1 = \frac{1}{4}x^2 + y^2 \end{aligned}$$

$$\begin{aligned} 35. (a) \nabla f &= \left(\frac{2x}{x^2+y^2} \right) \mathbf{i} + \left(\frac{2y}{x^2+y^2} \right) \mathbf{j} \Rightarrow M = \frac{2x}{x^2+y^2}, N = \frac{2y}{x^2+y^2}; \text{ since } M, N \text{ are discontinuous at } (0, 0), \text{ we} \\ \text{compute } \int_C \nabla f \cdot \mathbf{n} \, ds &\text{ directly since Green's Theorem does not apply. Let } x = a \cos t, y = a \sin t \Rightarrow dx = -a \sin t \, dt, \\ dy &= a \cos t \, dt, M = \frac{2}{a} \cos t, N = \frac{2}{a} \sin t, 0 \leq t \leq 2\pi, \text{ so } \int_C \nabla f \cdot \mathbf{n} \, ds = \int_C M \, dy - N \, dx \\ &= \int_0^{2\pi} \left[\left(\frac{2}{a} \cos t \right) (a \cos t) - \left(\frac{2}{a} \sin t \right) (-a \sin t) \right] dt = \int_0^{2\pi} 2(\cos^2 t + \sin^2 t) dt = 4\pi. \text{ Note that this holds for any} \end{aligned}$$

$a > 0$, so $\int_C \nabla f \cdot \mathbf{n} \, ds = 4\pi$ for any circle C centered at $(0, 0)$ traversed counterclockwise and $\int_C \nabla f \cdot \mathbf{n} \, ds = -4\pi$ if C is traversed clockwise.

- (b) If K does not enclose the point $(0, 0)$ we may apply Green's Theorem: $\int_C \nabla f \cdot \mathbf{n} \, ds = \int_C M \, dy - N \, dx$
 $= \iint_R \left(\frac{\partial M}{\partial x} + \frac{\partial N}{\partial y} \right) dx \, dy = \iint_R \left(\frac{2(y^2 - x^2)}{(x^2 + y^2)^2} + \frac{2(x^2 - y^2)}{(x^2 + y^2)^2} \right) dx \, dy = \iint_R 0 \, dx \, dy = 0$. If K does enclose the point

$(0, 0)$ we proceed as in Example 6:

Choose a small enough so that the circle C centered at $(0, 0)$ of radius a lies entirely within K . Green's Theorem

applies to the region R that lies between K and C . Thus, as before, $0 = \iint_R \left(\frac{\partial M}{\partial x} + \frac{\partial N}{\partial y} \right) dx \, dy$

$$= \int_K M \, dy - N \, dx + \int_C M \, dy - N \, dx \text{ where } K \text{ is traversed counterclockwise and } C \text{ is traversed clockwise.}$$

Hence by part (a) $0 = \left[\int_K M \, dy - N \, dx \right] - 4\pi \Rightarrow 4\pi = \int_K M \, dy - N \, dx = \int_K \nabla f \cdot \mathbf{n} \, ds$. We have shown:

$$\int_K \nabla f \cdot \mathbf{n} \, ds = \begin{cases} 0 & \text{if } (0, 0) \text{ lies inside } K \\ 4\pi & \text{if } (0, 0) \text{ lies outside } K \end{cases}$$

36. Assume a particle has a closed trajectory in R and let C_1 be the path $\Rightarrow C_1$ encloses a simply connected region $R_1 \Rightarrow C_1$ is a simple closed curve. Then the flux over R_1 is $\oint_{C_1} \mathbf{F} \cdot \mathbf{n} \, ds = 0$, since the velocity vectors \mathbf{F} are tangent to C_1 . But $0 = \oint_{C_1} \mathbf{F} \cdot \mathbf{n} \, ds = \oint_{C_1} M \, dy - N \, dx = \iint_{R_1} \left(\frac{\partial M}{\partial x} + \frac{\partial N}{\partial y} \right) dx \, dy \Rightarrow M_x + N_y = 0$, which is a contradiction. Therefore, C_1 cannot be a closed trajectory.

$$\begin{aligned} 37. \int_{g_1(y)}^{g_2(y)} \frac{\partial N}{\partial x} dx \, dy &= N(g_2(y), y) - N(g_1(y), y) \Rightarrow \int_c^d \int_{g_1(y)}^{g_2(y)} \left(\frac{\partial N}{\partial x} \right) dx \, dy = \int_c^d [N(g_2(y), y) - N(g_1(y), y)] dy \\ &= \int_c^d N(g_2(y), y) dy - \int_c^d N(g_1(y), y) dy = \int_c^d N(g_2(y), y) dy + \int_d^c N(g_1(y), y) dy = \int_{C_2} N \, dy + \int_{C_1} N \, dy \\ &= \oint_C N \, dy \Rightarrow \oint_C N \, dy = \iint_R \frac{\partial N}{\partial x} dx \, dy \end{aligned}$$

$$\begin{aligned} 38. \int_a^b \int_c^d \frac{\partial M}{\partial y} dy \, dx &= \int_a^b [M(x, d) - M(x, c)] dx = \int_a^b M(x, d) dx + \int_a^b M(x, c) dx = -\int_{C_3} M \, dx - \int_{C_1} M \, dx. \\ \text{Because } x \text{ is constant along } C_2 \text{ and } C_4, \int_{C_2} M \, dx &= \int_{C_4} M \, dx = 0 \\ \Rightarrow -\left(\int_{C_1} M \, dx + \int_{C_2} M \, dx + \int_{C_3} M \, dx + \int_{C_4} M \, dx \right) &= -\oint_C M \, dx \Rightarrow \int_a^b \int_c^d \frac{\partial M}{\partial y} dy \, dx = -\oint_C M \, dx. \end{aligned}$$

39. The curl of a conservative two-dimensional field is zero. The reasoning: A two-dimensional field $\mathbf{F} = M\mathbf{i} + N\mathbf{j}$ can be considered to be the restriction to the xy -plane of a three-dimensional field whose k component is zero, and whose \mathbf{i} and \mathbf{j} components are independent of z . For such a field to be conservative, we must have $\frac{\partial N}{\partial x} = \frac{\partial M}{\partial y}$ by the component test in Section 16.3 $\Rightarrow \text{curl } \mathbf{F} = \frac{\partial N}{\partial x} - \frac{\partial M}{\partial y} = 0$.

40. Green's theorem tells us that the circulation of a conservative two-dimensional field around any simple closed curve in the xy -plane is zero. The reasoning: For a conservative field $\mathbf{F} = M\mathbf{i} + N\mathbf{j}$, we have $\frac{\partial N}{\partial x} = \frac{\partial M}{\partial y}$ (component test for conservative fields, Section 16.3, Eq. (2)), so $\text{curl } \mathbf{F} = \frac{\partial N}{\partial x} - \frac{\partial M}{\partial y} = 0$. By Green's theorem, the counterclockwise circulation around a simple closed plane curve C must equal the integral of $\text{curl } \mathbf{F}$ over the region R enclosed by C . Since $\text{curl } \mathbf{F} = 0$, the latter integral is zero and, therefore, so is the circulation. The circulation $\oint_C \mathbf{F} \cdot \mathbf{T} \, ds$ is the same as the work $\oint_C \mathbf{F} \cdot d\mathbf{r}$ done by \mathbf{F} around C , so our observation that circulation of a conservative two-dimensional field is zero agrees with the fact that the work done by a conservative field around a closed curve is always 0.

1018 Chapter 16 Integration in Vector Fields

41-44. Example CAS commands:

Maple:

```
with( plots );#41
M := (x,y) -> 2*x-y;
N := (x,y) -> x+3*y;
C := x^2 + 4*y^2 = 4;
implicitplot( C, x=-2..2, y=-2..2, scaling=constrained, title="#41(a) (Section 16.4)" );
curlF_k := D[1](N) - D[2](M): # (b)
'curlF_k' = curlF_k(x,y);
top,bot := solve( C, y ); # (c)
left,right := -2, 2;
q1 := Int( Int( curlF_k(x,y), y=bot..top ), x=left..right );
value( q1 );
```

Mathematica: (functions and bounds will vary)

The **ImplicitPlot** command will be useful for 41 and 42, but is not needed for 43 and 44. In 44, the equation of the line from (0, 4) to (2, 0) must be determined first.

```
Clear[x, y, f]
<<Graphics`ImplicitPlot`
f[x_, y_]:= {2x - y, x + 3y}
curve= x^2 + 4y^2 ==4
ImplicitPlot[curve, {x, -3, 3},{y, -2, 2}, AspectRatio -> Automatic, AxesLabel -> {x, y}];
ybounds= Solve[curve, y]
{y1, y2}=y/.ybounds;
integrand:=D[f[x,y][[2]], x] - D[f[x,y][[1]], y]//Simplify
Integrate[integrand, {x, -2, 2}, {y, y1, y2}]
N[%]
```

Bounds for y are determined differently in 43 and 44. In 44, note equation of the line from (0, 4) to (2, 0).

```
Clear[x, y, f]
f[x_, y_]:= {x Exp[y], 4x^2 Log[y]}
ybound = 4 - 2x
Plot[{0, ybound}, {x, 0, 2}, AspectRatio -> Automatic, AxesLabel -> {x, y}];
integrand:=D[f[x, y][[2]], x] - D[f[x, y][[1]], y]//Simplify
Integrate[integrand, {x, 0, 2}, {y, 0, ybound}]
N[%]
```

16.5 SURFACE AREA AND SURFACE INTEGRALS

1. $\mathbf{p} = \mathbf{k}$, $\nabla f = 2x\mathbf{i} + 2y\mathbf{j} - \mathbf{k} \Rightarrow |\nabla f| = \sqrt{(2x)^2 + (2y)^2 + (-1)^2} = \sqrt{4x^2 + 4y^2 + 1}$ and $|\nabla f \cdot \mathbf{p}| = 1$;

$$z = 2 \Rightarrow x^2 + y^2 = 2; \text{ thus } S = \iint_R \frac{|\nabla f|}{|\nabla f \cdot \mathbf{p}|} dA = \iint_R \sqrt{4x^2 + 4y^2 + 1} dx dy$$

$$= \iint_R \sqrt{4r^2 \cos^2 \theta + 4r^2 \sin^2 \theta + 1} r dr d\theta = \int_0^{2\pi} \int_0^{\sqrt{2}} \sqrt{4r^2 + 1} r dr d\theta = \int_0^{2\pi} \left[\frac{1}{12} (4r^2 + 1)^{3/2} \right]_0^{\sqrt{2}} d\theta$$

$$= \int_0^{2\pi} \frac{13}{6} d\theta = \frac{13}{3} \pi$$

2. $\mathbf{p} = \mathbf{k}$, $\nabla f = 2x\mathbf{i} + 2y\mathbf{j} - \mathbf{k} \Rightarrow |\nabla f| = \sqrt{4x^2 + 4y^2 + 1}$ and $|\nabla f \cdot \mathbf{p}| = 1$; $2 \leq x^2 + y^2 \leq 6$

$$\Rightarrow S = \iint_R \frac{|\nabla f|}{|\nabla f \cdot \mathbf{p}|} dA = \iint_R \sqrt{4x^2 + 4y^2 + 1} dx dy = \iint_R \sqrt{4r^2 + 1} r dr d\theta = \int_0^{2\pi} \int_{\sqrt{2}}^{\sqrt{6}} \sqrt{4r^2 + 1} r dr d\theta$$

$$= \int_0^{2\pi} \left[\frac{1}{12} (4r^2 + 1)^{3/2} \right]_{\sqrt{2}}^{\sqrt{6}} d\theta = \int_0^{2\pi} \frac{49}{6} d\theta = \frac{49}{3} \pi$$

3. $\mathbf{p} = \mathbf{k}$, $\nabla f = \mathbf{i} + 2\mathbf{j} + 2\mathbf{k} \Rightarrow |\nabla f| = 3$ and $|\nabla f \cdot \mathbf{p}| = 2$; $x = y^2$ and $x = 2 - y^2$ intersect at $(1, 1)$ and $(1, -1)$
 $\Rightarrow S = \iint_{\mathbf{R}} \frac{|\nabla f|}{|\nabla f \cdot \mathbf{p}|} dA = \iint_{\mathbf{R}} \frac{3}{2} dx dy = \int_{-1}^1 \int_{y^2}^{2-y^2} \frac{3}{2} dx dy = \int_{-1}^1 (3 - 3y^2) dy = 4$
4. $\mathbf{p} = \mathbf{k}$, $\nabla f = 2x\mathbf{i} - 2\mathbf{k} \Rightarrow |\nabla f| = \sqrt{4x^2 + 4} = 2\sqrt{x^2 + 1}$ and $|\nabla f \cdot \mathbf{p}| = 2 \Rightarrow S = \iint_{\mathbf{R}} \frac{|\nabla f|}{|\nabla f \cdot \mathbf{p}|} dA$
 $= \iint_{\mathbf{R}} \frac{2\sqrt{x^2+1}}{2} dx dy = \int_0^{\sqrt{3}} \int_0^x \sqrt{x^2+1} dy dx = \int_0^{\sqrt{3}} x\sqrt{x^2+1} dx = \left[\frac{1}{3} (x^2+1)^{3/2} \right]_0^{\sqrt{3}} = \frac{1}{3} (4)^{3/2} - \frac{1}{3} = \frac{7}{3}$
5. $\mathbf{p} = \mathbf{k}$, $\nabla f = 2x\mathbf{i} - 2\mathbf{j} - 2\mathbf{k} \Rightarrow |\nabla f| = \sqrt{(2x)^2 + (-2)^2 + (-2)^2} = \sqrt{4x^2 + 8} = 2\sqrt{x^2 + 2}$ and $|\nabla f \cdot \mathbf{p}| = 2$
 $\Rightarrow S = \iint_{\mathbf{R}} \frac{|\nabla f|}{|\nabla f \cdot \mathbf{p}|} dA = \iint_{\mathbf{R}} \frac{2\sqrt{x^2+2}}{2} dx dy = \int_0^2 \int_0^{3x} \sqrt{x^2+2} dy dx = \int_0^2 3x\sqrt{x^2+2} dx = \left[(x^2+2)^{3/2} \right]_0^2$
 $= 6\sqrt{6} - 2\sqrt{2}$
6. $\mathbf{p} = \mathbf{k}$, $\nabla f = 2x\mathbf{i} + 2y\mathbf{j} + 2z\mathbf{k} \Rightarrow |\nabla f| = \sqrt{4x^2 + 4y^2 + 4z^2} = \sqrt{8} = 2\sqrt{2}$ and $|\nabla f \cdot \mathbf{p}| = 2z$; $x^2 + y^2 + z^2 = 2$ and $z = \sqrt{x^2 + y^2} \Rightarrow x^2 + y^2 = 1$; thus, $S = \iint_{\mathbf{R}} \frac{|\nabla f|}{|\nabla f \cdot \mathbf{p}|} dA = \iint_{\mathbf{R}} \frac{2\sqrt{2}}{2z} dA = \sqrt{2} \iint_{\mathbf{R}} \frac{1}{z} dA$
 $= \sqrt{2} \iint_{\mathbf{R}} \frac{1}{\sqrt{2-(x^2+y^2)}} dA = \sqrt{2} \int_0^{2\pi} \int_0^1 \frac{r dr d\theta}{\sqrt{2-r^2}} = \sqrt{2} \int_0^{2\pi} (-1 + \sqrt{2}) d\theta = 2\pi(2 - \sqrt{2})$
7. $\mathbf{p} = \mathbf{k}$, $\nabla f = c\mathbf{i} - \mathbf{k} \Rightarrow |\nabla f| = \sqrt{c^2 + 1}$ and $|\nabla f \cdot \mathbf{p}| = 1 \Rightarrow S = \iint_{\mathbf{R}} \frac{|\nabla f|}{|\nabla f \cdot \mathbf{p}|} dA = \iint_{\mathbf{R}} \sqrt{c^2 + 1} dx dy$
 $= \int_0^{2\pi} \int_0^1 \sqrt{c^2 + 1} r dr d\theta = \int_0^{2\pi} \frac{\sqrt{c^2+1}}{2} d\theta = \pi\sqrt{c^2 + 1}$
8. $\mathbf{p} = \mathbf{k}$, $\nabla f = 2x\mathbf{i} + 2z\mathbf{j} \Rightarrow |\nabla f| = \sqrt{(2x)^2 + (2z)^2} = 2$ and $|\nabla f \cdot \mathbf{p}| = 2z$ for the upper surface, $z \geq 0$
 $\Rightarrow S = \iint_{\mathbf{R}} \frac{|\nabla f|}{|\nabla f \cdot \mathbf{p}|} dA = \iint_{\mathbf{R}} \frac{2}{2z} dA = \iint_{\mathbf{R}} \frac{1}{\sqrt{1-x^2}} dy dx = 2 \int_{-1/2}^{1/2} \int_0^{1/2} \frac{1}{\sqrt{1-x^2}} dy dx = \int_{-1/2}^{1/2} \frac{1}{\sqrt{1-x^2}} dx$
 $= [\sin^{-1} x]_{-1/2}^{1/2} = \frac{\pi}{6} - \left(-\frac{\pi}{6}\right) = \frac{\pi}{3}$
9. $\mathbf{p} = \mathbf{i}$, $\nabla f = \mathbf{i} + 2y\mathbf{j} + 2z\mathbf{k} \Rightarrow |\nabla f| = \sqrt{1^2 + (2y)^2 + (2z)^2} = \sqrt{1 + 4y^2 + 4z^2}$ and $|\nabla f \cdot \mathbf{p}| = 1$; $1 \leq y^2 + z^2 \leq 4$
 $\Rightarrow S = \iint_{\mathbf{R}} \frac{|\nabla f|}{|\nabla f \cdot \mathbf{p}|} dA = \iint_{\mathbf{R}} \sqrt{1 + 4y^2 + 4z^2} dy dz = \int_0^{2\pi} \int_1^2 \sqrt{1 + 4r^2 \cos^2 \theta + 4r^2 \sin^2 \theta} r dr d\theta$
 $= \int_0^{2\pi} \int_1^2 \sqrt{1 + 4r^2} r dr d\theta = \int_0^{2\pi} \left[\frac{1}{12} (1 + 4r^2)^{3/2} \right]_1^2 d\theta = \int_0^{2\pi} \frac{1}{12} (17\sqrt{17} - 5\sqrt{5}) d\theta = \frac{\pi}{6} (17\sqrt{17} - 5\sqrt{5})$
10. $\mathbf{p} = \mathbf{j}$, $\nabla f = 2x\mathbf{i} + \mathbf{j} + 2z\mathbf{k} \Rightarrow |\nabla f| = \sqrt{4x^2 + 4z^2 + 1}$ and $|\nabla f \cdot \mathbf{p}| = 1$; $y = 0$ and $x^2 + y + z^2 = 2 \Rightarrow x^2 + z^2 = 2$;
thus, $S = \iint_{\mathbf{R}} \frac{|\nabla f|}{|\nabla f \cdot \mathbf{p}|} dA = \iint_{\mathbf{R}} \sqrt{4x^2 + 4z^2 + 1} dx dz = \int_0^{2\pi} \int_0^{\sqrt{2}} \sqrt{4r^2 + 1} r dr d\theta = \int_0^{2\pi} \frac{13}{6} d\theta = \frac{13}{3} \pi$
11. $\mathbf{p} = \mathbf{k}$, $\nabla f = (2x - \frac{2}{x})\mathbf{i} + \sqrt{15}\mathbf{j} - \mathbf{k} \Rightarrow |\nabla f| = \sqrt{(2x - \frac{2}{x})^2 + (\sqrt{15})^2 + (-1)^2} = \sqrt{4x^2 + 8 + \frac{4}{x^2}} = \sqrt{(2x + \frac{2}{x})^2}$
 $= 2x + \frac{2}{x}$, on $1 \leq x \leq 2$ and $|\nabla f \cdot \mathbf{p}| = 1 \Rightarrow S = \iint_{\mathbf{R}} \frac{|\nabla f|}{|\nabla f \cdot \mathbf{p}|} dA = \iint_{\mathbf{R}} (2x + 2x^{-1}) dx dy$
 $= \int_0^1 \int_1^2 (2x + 2x^{-1}) dx dy = \int_0^1 [x^2 + 2 \ln x]_1^2 dy = \int_0^1 (3 + 2 \ln 2) dy = 3 + 2 \ln 2$
12. $\mathbf{p} = \mathbf{k}$, $\nabla f = 3\sqrt{x}\mathbf{i} + 3\sqrt{y}\mathbf{j} - 3\mathbf{k} \Rightarrow |\nabla f| = \sqrt{9x + 9y + 9} = 3\sqrt{x + y + 1}$ and $|\nabla f \cdot \mathbf{p}| = 3$
 $\Rightarrow S = \iint_{\mathbf{R}} \frac{|\nabla f|}{|\nabla f \cdot \mathbf{p}|} dA = \iint_{\mathbf{R}} \sqrt{x + y + 1} dx dy = \int_0^1 \int_0^1 \sqrt{x + y + 1} dx dy = \int_0^1 \left[\frac{2}{3} (x + y + 1)^{3/2} \right]_0^1 dy$
 $= \int_0^1 \left[\frac{2}{3} (y + 2)^{3/2} - \frac{2}{3} (y + 1)^{3/2} \right] dy = \left[\frac{4}{15} (y + 2)^{5/2} - \frac{4}{15} (y + 1)^{5/2} \right]_0^1 = \frac{4}{15} [(3)^{5/2} - (2)^{5/2} - (2)^{5/2} + 1]$

$$= \frac{4}{15} (9\sqrt{3} - 8\sqrt{2} + 1)$$

13. The bottom face S of the cube is in the xy -plane $\Rightarrow z = 0 \Rightarrow g(x, y, 0) = x + y$ and $f(x, y, z) = z = 0 \Rightarrow \mathbf{p} = \mathbf{k}$

$$\text{and } \nabla f = \mathbf{k} \Rightarrow |\nabla f| = 1 \text{ and } |\nabla f \cdot \mathbf{p}| = 1 \Rightarrow d\sigma = dx dy \Rightarrow \int_S g d\sigma = \int_R \int (x + y) dx dy$$

$$= \int_0^a \int_0^a (x + y) dx dy = \int_0^a \left(\frac{a^2}{2} + ay \right) dy = a^3. \text{ Because of symmetry, we also get } a^3 \text{ over the face of the cube}$$

in the xz -plane and a^3 over the face of the cube in the yz -plane. Next, on the top of the cube, $g(x, y, z)$

$$= g(x, y, a) = x + y + a \text{ and } f(x, y, z) = z = a \Rightarrow \mathbf{p} = \mathbf{k} \text{ and } \nabla f = \mathbf{k} \Rightarrow |\nabla f| = 1 \text{ and } |\nabla f \cdot \mathbf{p}| = 1 \Rightarrow d\sigma = dx dy$$

$$\int_S g d\sigma = \int_R \int (x + y + a) dx dy = \int_0^a \int_0^a (x + y + a) dx dy = \int_0^a \int_0^a (x + y) dx dy + \int_0^a \int_0^a a dx dy = 2a^3.$$

Because of symmetry, the integral is also $2a^3$ over each of the other two faces. Therefore,

$$\int_{\text{cube}} (x + y + z) d\sigma = 3(a^3 + 2a^3) = 9a^3.$$

14. On the face S in the xz -plane, we have $y = 0 \Rightarrow f(x, y, z) = y = 0$ and $g(x, y, z) = g(x, 0, z) = z \Rightarrow \mathbf{p} = \mathbf{j}$ and

$$\nabla f = \mathbf{j} \Rightarrow |\nabla f| = 1 \text{ and } |\nabla f \cdot \mathbf{p}| = 1 \Rightarrow d\sigma = dx dz \Rightarrow \int_S g d\sigma = \int_S \int (y + z) d\sigma = \int_0^1 \int_0^2 z dx dz = \int_0^1 2z dz$$

$$= 1.$$

On the face in the xy -plane, we have $z = 0 \Rightarrow f(x, y, z) = z = 0$ and $g(x, y, z) = g(x, y, 0) = y \Rightarrow \mathbf{p} = \mathbf{k}$ and

$$\nabla f = \mathbf{k} \Rightarrow |\nabla f| = 1 \text{ and } |\nabla f \cdot \mathbf{p}| = 1 \Rightarrow d\sigma = dx dy \Rightarrow \int_S g d\sigma = \int_S \int y d\sigma = \int_0^1 \int_0^2 y dx dy = 1.$$

On the triangular face in the plane $x = 2$ we have $f(x, y, z) = x = 2$ and $g(x, y, z) = g(2, y, z) = y + z \Rightarrow \mathbf{p} = \mathbf{i}$ and

$$\nabla f = \mathbf{i} \Rightarrow |\nabla f| = 1 \text{ and } |\nabla f \cdot \mathbf{p}| = 1 \Rightarrow d\sigma = dz dy \Rightarrow \int_S g d\sigma = \int_S \int (y + z) d\sigma = \int_0^1 \int_0^{1-y} (y + z) dz dy$$

$$= \int_0^1 \frac{1}{2} (1 - y^2) dy = \frac{1}{3}.$$

On the triangular face in the yz -plane, we have $x = 0 \Rightarrow f(x, y, z) = x = 0$ and $g(x, y, z) = g(0, y, z) = y + z$

$$\Rightarrow \mathbf{p} = \mathbf{i} \text{ and } \nabla f = \mathbf{i} \Rightarrow |\nabla f| = 1 \text{ and } |\nabla f \cdot \mathbf{p}| = 1 \Rightarrow d\sigma = dz dy \Rightarrow \int_S g d\sigma = \int_S \int (y + z) d\sigma$$

$$= \int_0^1 \int_0^{1-y} (y + z) dz dy = \frac{1}{3}.$$

Finally, on the sloped face, we have $y + z = 1 \Rightarrow f(x, y, z) = y + z = 1$ and $g(x, y, z) = y + z = 1 \Rightarrow \mathbf{p} = \mathbf{k}$ and

$$\nabla f = \mathbf{j} + \mathbf{k} \Rightarrow |\nabla f| = \sqrt{2} \text{ and } |\nabla f \cdot \mathbf{p}| = 1 \Rightarrow d\sigma = \sqrt{2} dx dy \Rightarrow \int_S g d\sigma = \int_S \int (y + z) d\sigma$$

$$= \int_0^1 \int_0^2 \sqrt{2} dx dy = 2\sqrt{2}. \text{ Therefore, } \int_{\text{wedge}} g(x, y, z) d\sigma = 1 + 1 + \frac{1}{3} + \frac{1}{3} + 2\sqrt{2} = \frac{8}{3} + 2\sqrt{2}$$

15. On the faces in the coordinate planes, $g(x, y, z) = 0 \Rightarrow$ the integral over these faces is 0.

On the face $x = a$, we have $f(x, y, z) = x = a$ and $g(x, y, z) = g(a, y, z) = ayz \Rightarrow \mathbf{p} = \mathbf{i}$ and $\nabla f = \mathbf{i} \Rightarrow |\nabla f| = 1$

$$\text{and } |\nabla f \cdot \mathbf{p}| = 1 \Rightarrow d\sigma = dy dz \Rightarrow \int_S g d\sigma = \int_S \int ayz d\sigma = \int_0^c \int_0^b ayz dy dz = \frac{ab^2c^2}{4}.$$

On the face $y = b$, we have $f(x, y, z) = y = b$ and $g(x, y, z) = g(x, b, z) = bxz \Rightarrow \mathbf{p} = \mathbf{j}$ and $\nabla f = \mathbf{j} \Rightarrow |\nabla f| = 1$

$$\text{and } |\nabla f \cdot \mathbf{p}| = 1 \Rightarrow d\sigma = dx dz \Rightarrow \int_S g d\sigma = \int_S \int bxz d\sigma = \int_0^c \int_0^a bxz dx dz = \frac{a^2b^2c}{4}.$$

On the face $z = c$, we have $f(x, y, z) = z = c$ and $g(x, y, z) = g(x, y, c) = cxy \Rightarrow \mathbf{p} = \mathbf{k}$ and $\nabla f = \mathbf{k} \Rightarrow |\nabla f| = 1$

$$\text{and } |\nabla f \cdot \mathbf{p}| = 1 \Rightarrow d\sigma = dy dx \Rightarrow \int_S g d\sigma = \int_S \int cxy d\sigma = \int_0^b \int_0^a cxy dx dy = \frac{a^2b^2c}{4}. \text{ Therefore,}$$

$$\int_S g(x, y, z) d\sigma = \frac{abc(ab+ac+bc)}{4}.$$

16. On the face $x = a$, we have $f(x, y, z) = x = a$ and $g(x, y, z) = g(a, y, z) = ayz \Rightarrow \mathbf{p} = \mathbf{i}$ and $\nabla f = \mathbf{i} \Rightarrow |\nabla f| = 1$ and $|\nabla f \cdot \mathbf{p}| = 1 \Rightarrow d\sigma = dz dy \Rightarrow \iint_S g d\sigma = \iint_S ayz d\sigma = \int_{-b}^b \int_{-c}^c ayz dz dy = 0$. Because of the symmetry of g on all the other faces, all the integrals are 0, and $\iint_S g(x, y, z) d\sigma = 0$.
17. $f(x, y, z) = 2x + 2y + z = 2 \Rightarrow \nabla f = 2\mathbf{i} + 2\mathbf{j} + \mathbf{k}$ and $g(x, y, z) = x + y + (2 - 2x - 2y) = 2 - x - y \Rightarrow \mathbf{p} = \mathbf{k}$, $|\nabla f| = 3$ and $|\nabla f \cdot \mathbf{p}| = 1 \Rightarrow d\sigma = 3 dy dx$; $z = 0 \Rightarrow 2x + 2y = 2 \Rightarrow y = 1 - x \Rightarrow \iint_S g d\sigma = \iint_S (2 - x - y) d\sigma = 3 \int_0^1 \int_0^{1-x} (2 - x - y) dy dx = 3 \int_0^1 [(2 - x)(1 - x) - \frac{1}{2}(1 - x)^2] dx = 3 \int_0^1 (\frac{3}{2} - 2x + \frac{x^2}{2}) dx = 2$
18. $f(x, y, z) = y^2 + 4z = 16 \Rightarrow \nabla f = 2y\mathbf{j} + 4\mathbf{k} \Rightarrow |\nabla f| = \sqrt{4y^2 + 16} = 2\sqrt{y^2 + 4}$ and $\mathbf{p} = \mathbf{k} \Rightarrow |\nabla f \cdot \mathbf{p}| = 4 \Rightarrow d\sigma = \frac{2\sqrt{y^2 + 4}}{4} dx dy \Rightarrow \iint_S g d\sigma = \int_{-4}^4 \int_0^1 (x\sqrt{y^2 + 4}) \left(\frac{\sqrt{y^2 + 4}}{2}\right) dx dy = \int_{-4}^4 \int_0^1 \frac{x(y^2 + 4)}{2} dx dy = \int_{-4}^4 \frac{1}{4} (y^2 + 4) dy = \frac{1}{2} \left[\frac{y^3}{3} + 4y\right]_0^4 = \frac{1}{2} \left(\frac{64}{3} + 16\right) = \frac{56}{3}$
19. $g(x, y, z) = z, \mathbf{p} = \mathbf{k} \Rightarrow \nabla g = \mathbf{k} \Rightarrow |\nabla g| = 1$ and $|\nabla g \cdot \mathbf{p}| = 1 \Rightarrow \text{Flux} = \iint_S \mathbf{F} \cdot \mathbf{n} d\sigma = \iint_R (\mathbf{F} \cdot \mathbf{k}) dA = \int_0^2 \int_0^3 3 dy dx = 18$
20. $g(x, y, z) = y, \mathbf{p} = -\mathbf{j} \Rightarrow \nabla g = \mathbf{j} \Rightarrow |\nabla g| = 1$ and $|\nabla g \cdot \mathbf{p}| = 1 \Rightarrow \text{Flux} = \iint_S \mathbf{F} \cdot \mathbf{n} d\sigma = \iint_R (\mathbf{F} \cdot -\mathbf{j}) dA = \int_{-1}^2 \int_2^7 2 dz dx = \int_{-1}^2 2(7 - 2) dx = 10(2 + 1) = 30$
21. $\nabla g = 2x\mathbf{i} + 2y\mathbf{j} + 2z\mathbf{k} \Rightarrow |\nabla g| = \sqrt{4x^2 + 4y^2 + 4z^2} = 2a; \mathbf{n} = \frac{2x\mathbf{i} + 2y\mathbf{j} + 2z\mathbf{k}}{2\sqrt{x^2 + y^2 + z^2}} = \frac{x\mathbf{i} + y\mathbf{j} + z\mathbf{k}}{a} \Rightarrow \mathbf{F} \cdot \mathbf{n} = \frac{z^2}{a}; |\nabla g \cdot \mathbf{k}| = 2z \Rightarrow d\sigma = \frac{2a}{2z} dA \Rightarrow \text{Flux} = \iint_R \left(\frac{z^2}{a}\right) \left(\frac{a}{z}\right) dA = \iint_R z dA = \iint_R \sqrt{a^2 - (x^2 + y^2)} dx dy = \int_0^{\pi/2} \int_0^a \sqrt{a^2 - r^2} r dr d\theta = \frac{\pi a^3}{6}$
22. $\nabla g = 2x\mathbf{i} + 2y\mathbf{j} + 2z\mathbf{k} \Rightarrow |\nabla g| = \sqrt{4x^2 + 4y^2 + 4z^2} = 2a; \mathbf{n} = \frac{2x\mathbf{i} + 2y\mathbf{j} + 2z\mathbf{k}}{2\sqrt{x^2 + y^2 + z^2}} = \frac{x\mathbf{i} + y\mathbf{j} + z\mathbf{k}}{a} \Rightarrow \mathbf{F} \cdot \mathbf{n} = \frac{-xy}{a} + \frac{xy}{a} = 0; |\nabla g \cdot \mathbf{k}| = 2z \Rightarrow d\sigma = \frac{2a}{2z} dA \Rightarrow \text{Flux} = \iint_S \mathbf{F} \cdot \mathbf{n} d\sigma = \iint_S 0 d\sigma = 0$
23. From Exercise 21, $\mathbf{n} = \frac{x\mathbf{i} + y\mathbf{j} + z\mathbf{k}}{a}$ and $d\sigma = \frac{a}{z} dA \Rightarrow \mathbf{F} \cdot \mathbf{n} = \frac{xy}{a} - \frac{xy}{a} + \frac{z}{a} = \frac{z}{a} \Rightarrow \text{Flux} = \iint_R \left(\frac{z}{a}\right) \left(\frac{a}{z}\right) dA = \iint_R 1 dA = \frac{\pi a^2}{4}$
24. From Exercise 21, $\mathbf{n} = \frac{x\mathbf{i} + y\mathbf{j} + z\mathbf{k}}{a}$ and $d\sigma = \frac{a}{z} dA \Rightarrow \mathbf{F} \cdot \mathbf{n} = \frac{zx^2}{a} + \frac{zy^2}{a} + \frac{z^3}{a} = z \left(\frac{x^2 + y^2 + z^2}{a}\right) = az \Rightarrow \text{Flux} = \iint_R (za) \left(\frac{a}{z}\right) dx dy = \iint_R a^2 dx dy = a^2(\text{Area of } R) = \frac{1}{4} \pi a^4$
25. From Exercise 21, $\mathbf{n} = \frac{x\mathbf{i} + y\mathbf{j} + z\mathbf{k}}{a}$ and $d\sigma = \frac{a}{z} dA \Rightarrow \mathbf{F} \cdot \mathbf{n} = \frac{x^2}{a} + \frac{y^2}{a} + \frac{z^2}{a} = a \Rightarrow \text{Flux} = \iint_R a \left(\frac{a}{z}\right) dA = \iint_R \frac{a^2}{z} dA = \iint_R \frac{a^2}{\sqrt{a^2 - (x^2 + y^2)}} dA = \int_0^{\pi/2} \int_0^a \frac{a^2}{\sqrt{a^2 - r^2}} r dr d\theta = \int_0^{\pi/2} a^2 \left[-\sqrt{a^2 - r^2}\right]_0^a d\theta = \frac{\pi a^3}{2}$

$$26. \text{ From Exercise 21, } \mathbf{n} = \frac{x\mathbf{i} + y\mathbf{j} + z\mathbf{k}}{a} \text{ and } d\sigma = \frac{a}{z} dA \Rightarrow \mathbf{F} \cdot \mathbf{n} = \frac{\left(\frac{x^2}{a}\right) + \left(\frac{y^2}{a}\right) + \left(\frac{z^2}{a}\right)}{\sqrt{x^2 + y^2 + z^2}} = \frac{\left(\frac{a^2}{a}\right)}{a} = 1$$

$$\Rightarrow \text{Flux} = \iint_R \frac{a}{z} dx dy = \iint_R \frac{a}{\sqrt{a^2 - (x^2 + y^2)}} dx dy = \int_0^{\pi/2} \int_0^a \frac{a}{\sqrt{a^2 - r^2}} r dr d\theta = \frac{\pi a^2}{2}$$

$$27. g(x, y, z) = y^2 + z = 4 \Rightarrow \nabla g = 2y\mathbf{j} + \mathbf{k} \Rightarrow |\nabla g| = \sqrt{4y^2 + 1} \Rightarrow \mathbf{n} = \frac{2y\mathbf{j} + \mathbf{k}}{\sqrt{4y^2 + 1}}$$

$$\Rightarrow \mathbf{F} \cdot \mathbf{n} = \frac{2xy - 3z}{\sqrt{4y^2 + 1}}; \mathbf{p} = \mathbf{k} \Rightarrow |\nabla g \cdot \mathbf{p}| = 1 \Rightarrow d\sigma = \sqrt{4y^2 + 1} dA \Rightarrow \text{Flux}$$

$$= \iint_R \left(\frac{2xy - 3z}{\sqrt{4y^2 + 1}} \right) \sqrt{4y^2 + 1} dA = \iint_R (2xy - 3z) dA; z = 0 \text{ and } z = 4 - y^2 \Rightarrow y^2 = 4$$

$$\Rightarrow \text{Flux} = \iint_R [2xy - 3(4 - y^2)] dA = \int_0^1 \int_{-2}^2 (2xy - 12 + 3y^2) dy dx = \int_0^1 [xy^2 - 12y + y^3]_{-2}^2 dx$$

$$= \int_0^1 -32 dx = -32$$

$$28. g(x, y, z) = x^2 + y^2 - z = 0 \Rightarrow \nabla g = 2x\mathbf{i} + 2y\mathbf{j} - \mathbf{k} \Rightarrow |\nabla g| = \sqrt{4x^2 + 4y^2 + 1} = \sqrt{4(x^2 + y^2) + 1}$$

$$\Rightarrow \mathbf{n} = \frac{2x\mathbf{i} + 2y\mathbf{j} - \mathbf{k}}{\sqrt{4(x^2 + y^2) + 1}} \Rightarrow \mathbf{F} \cdot \mathbf{n} = \frac{8x^2 + 8y^2 - 2}{\sqrt{4(x^2 + y^2) + 1}}; \mathbf{p} = \mathbf{k} \Rightarrow |\nabla g \cdot \mathbf{p}| = 1 \Rightarrow d\sigma = \sqrt{4(x^2 + y^2) + 1} dA$$

$$\Rightarrow \text{Flux} = \iint_R \left(\frac{8x^2 + 8y^2 - 2}{\sqrt{4(x^2 + y^2) + 1}} \right) \sqrt{4(x^2 + y^2) + 1} dA = \iint_R (8x^2 + 8y^2 - 2) dA; z = 1 \text{ and } x^2 + y^2 = z$$

$$\Rightarrow x^2 + y^2 = 1 \Rightarrow \text{Flux} = \int_0^{2\pi} \int_0^1 (8r^2 - 2) r dr d\theta = 2\pi$$

$$29. g(x, y, z) = y - e^x = 0 \Rightarrow \nabla g = -e^x\mathbf{i} + \mathbf{j} \Rightarrow |\nabla g| = \sqrt{e^{2x} + 1} \Rightarrow \mathbf{n} = \frac{e^x\mathbf{i} - \mathbf{j}}{\sqrt{e^{2x} + 1}} \Rightarrow \mathbf{F} \cdot \mathbf{n} = \frac{-2e^x - 2y}{\sqrt{e^{2x} + 1}}; \mathbf{p} = \mathbf{i}$$

$$\Rightarrow |\nabla g \cdot \mathbf{p}| = e^x \Rightarrow d\sigma = \frac{\sqrt{e^{2x} + 1}}{e^x} dA \Rightarrow \text{Flux} = \iint_R \left(\frac{-2e^x - 2y}{\sqrt{e^{2x} + 1}} \right) \left(\frac{\sqrt{e^{2x} + 1}}{e^x} \right) dA = \iint_R \frac{-2e^x - 2e^x}{e^x} dA$$

$$= \iint_R -4 dA = \int_0^1 \int_1^2 -4 dy dz = -4$$

$$30. g(x, y, z) = y - \ln x = 0 \Rightarrow \nabla g = -\frac{1}{x}\mathbf{i} + \mathbf{j} \Rightarrow |\nabla g| = \sqrt{\frac{1}{x^2} + 1} = \frac{\sqrt{1 + x^2}}{x} \text{ since } 1 \leq x \leq e$$

$$\Rightarrow \mathbf{n} = \frac{\left(-\frac{1}{x}\mathbf{i} + \mathbf{j}\right)}{\left(\frac{\sqrt{1 + x^2}}{x}\right)} = \frac{-\mathbf{i} + x\mathbf{j}}{\sqrt{1 + x^2}} \Rightarrow \mathbf{F} \cdot \mathbf{n} = \frac{2xy}{\sqrt{1 + x^2}}; \mathbf{p} = \mathbf{j} \Rightarrow |\nabla g \cdot \mathbf{p}| = 1 \Rightarrow d\sigma = \frac{\sqrt{1 + x^2}}{x} dA$$

$$\Rightarrow \text{Flux} = \iint_R \left(\frac{2xy}{\sqrt{1 + x^2}} \right) \left(\frac{\sqrt{1 + x^2}}{x} \right) dA = \int_0^1 \int_1^e 2y dx dz = \int_1^e \int_0^1 2 \ln x dz dx = \int_1^e 2 \ln x dx$$

$$= 2[x \ln x - x]_1^e = 2(e - e) - 2(0 - 1) = 2$$

$$31. \text{ On the face } z = a: g(x, y, z) = z \Rightarrow \nabla g = \mathbf{k} \Rightarrow |\nabla g| = 1; \mathbf{n} = \mathbf{k} \Rightarrow \mathbf{F} \cdot \mathbf{n} = 2xz = 2ax \text{ since } z = a;$$

$$d\sigma = dx dy \Rightarrow \text{Flux} = \iint_R 2ax dx dy = \int_0^a \int_0^a 2ax dx dy = a^4.$$

$$\text{On the face } z = 0: g(x, y, z) = z \Rightarrow \nabla g = \mathbf{k} \Rightarrow |\nabla g| = 1; \mathbf{n} = -\mathbf{k} \Rightarrow \mathbf{F} \cdot \mathbf{n} = -2xz = 0 \text{ since } z = 0;$$

$$d\sigma = dx dy \Rightarrow \text{Flux} = \iint_R 0 dx dy = 0.$$

$$\text{On the face } x = a: g(x, y, z) = x \Rightarrow \nabla g = \mathbf{i} \Rightarrow |\nabla g| = 1; \mathbf{n} = \mathbf{i} \Rightarrow \mathbf{F} \cdot \mathbf{n} = 2xy = 2ay \text{ since } x = a;$$

$$d\sigma = dy dz \Rightarrow \text{Flux} = \int_0^a \int_0^a 2ay dy dz = a^4.$$

$$\text{On the face } x = 0: g(x, y, z) = x \Rightarrow \nabla g = \mathbf{i} \Rightarrow |\nabla g| = 1; \mathbf{n} = -\mathbf{i} \Rightarrow \mathbf{F} \cdot \mathbf{n} = -2xy = 0 \text{ since } x = 0$$

$$\Rightarrow \text{Flux} = 0.$$

$$\text{On the face } y = a: g(x, y, z) = y \Rightarrow \nabla g = \mathbf{j} \Rightarrow |\nabla g| = 1; \mathbf{n} = \mathbf{j} \Rightarrow \mathbf{F} \cdot \mathbf{n} = 2yz = 2az \text{ since } y = a;$$

$$d\sigma = dz dx \Rightarrow \text{Flux} = \int_0^a \int_0^a 2az dz dx = a^4.$$

$$\text{On the face } y = 0: g(x, y, z) = y \Rightarrow \nabla g = \mathbf{j} \Rightarrow |\nabla g| = 1; \mathbf{n} = -\mathbf{j} \Rightarrow \mathbf{F} \cdot \mathbf{n} = -2yz = 0 \text{ since } y = 0$$

$$\Rightarrow \text{Flux} = 0. \text{ Therefore, Total Flux} = 3a^4.$$

$$\begin{aligned}
32. \text{ Across the cap: } g(x, y, z) &= x^2 + y^2 + z^2 = 25 \Rightarrow \nabla g = 2x\mathbf{i} + 2y\mathbf{j} + 2z\mathbf{k} \Rightarrow |\nabla g| = \sqrt{4x^2 + 4y^2 + 4z^2} = 10 \\
&\Rightarrow \mathbf{n} = \frac{\nabla g}{|\nabla g|} = \frac{x\mathbf{i} + y\mathbf{j} + z\mathbf{k}}{5} \Rightarrow \mathbf{F} \cdot \mathbf{n} = \frac{x^2z}{5} + \frac{y^2z}{5} + \frac{z}{5}; \mathbf{p} = \mathbf{k} \Rightarrow |\nabla g \cdot \mathbf{p}| = 2z \text{ since } z \geq 0 \Rightarrow d\sigma = \frac{10}{2z} dA \\
&\Rightarrow \text{Flux}_{\text{cap}} = \iint_{\text{cap}} \mathbf{F} \cdot \mathbf{n} d\sigma = \iint_{\text{R}} \left(\frac{x^2z}{5} + \frac{y^2z}{5} + \frac{z}{5} \right) \left(\frac{5}{z} \right) dA = \iint_{\text{R}} (x^2 + y^2 + 1) dx dy = \int_0^{2\pi} \int_0^4 (r^2 + 1) r dr d\theta \\
&= \int_0^{2\pi} 72 d\theta = 144\pi.
\end{aligned}$$

$$\begin{aligned}
\text{Across the bottom: } g(x, y, z) &= z = 3 \Rightarrow \nabla g = \mathbf{k} \Rightarrow |\nabla g| = 1 \Rightarrow \mathbf{n} = -\mathbf{k} \Rightarrow \mathbf{F} \cdot \mathbf{n} = -1; \mathbf{p} = \mathbf{k} \Rightarrow |\nabla g \cdot \mathbf{p}| = 1 \\
&\Rightarrow d\sigma = dA \Rightarrow \text{Flux}_{\text{bottom}} = \iint_{\text{bottom}} \mathbf{F} \cdot \mathbf{n} d\sigma = \iint_{\text{R}} -1 dA = -1(\text{Area of the circular region}) = -16\pi. \text{ Therefore,} \\
\text{Flux} &= \text{Flux}_{\text{cap}} + \text{Flux}_{\text{bottom}} = 128\pi
\end{aligned}$$

$$\begin{aligned}
33. \nabla f &= 2x\mathbf{i} + 2y\mathbf{j} + 2z\mathbf{k} \Rightarrow |\nabla f| = \sqrt{4x^2 + 4y^2 + 4z^2} = 2a; \mathbf{p} = \mathbf{k} \Rightarrow |\nabla f \cdot \mathbf{p}| = 2z \text{ since } z \geq 0 \Rightarrow d\sigma = \frac{2a}{2z} dA \\
&= \frac{a}{z} dA; \mathbf{M} = \iint_{\text{S}} \delta d\sigma = \frac{\delta}{8} (\text{surface area of sphere}) = \frac{\delta\pi a^2}{2}; \mathbf{M}_{xy} = \iint_{\text{S}} z\delta d\sigma = \delta \iint_{\text{R}} z \left(\frac{a}{z} \right) dA \\
&= a\delta \iint_{\text{R}} dA = a\delta \int_0^{\pi/2} \int_0^a r dr d\theta = \frac{\delta\pi a^3}{4} \Rightarrow \bar{z} = \frac{\mathbf{M}_{xy}}{\mathbf{M}} = \left(\frac{\delta\pi a^3}{4} \right) \left(\frac{2}{\delta\pi a^2} \right) = \frac{a}{2}. \text{ Because of symmetry, } \bar{x} = \bar{y} \\
&= \frac{a}{2} \Rightarrow \text{the centroid is } \left(\frac{a}{2}, \frac{a}{2}, \frac{a}{2} \right).
\end{aligned}$$

$$\begin{aligned}
34. \nabla f &= 2y\mathbf{j} + 2z\mathbf{k} \Rightarrow |\nabla f| = \sqrt{4y^2 + 4z^2} = \sqrt{4(y^2 + z^2)} = 6; \mathbf{p} = \mathbf{k} \Rightarrow |\nabla f \cdot \mathbf{k}| = 2z \text{ since } z \geq 0 \Rightarrow d\sigma = \frac{6}{2z} dA \\
&= \frac{3}{z} dA; \mathbf{M} = \iint_{\text{S}} 1 d\sigma = \int_{-3}^3 \int_0^3 \frac{3}{z} dx dy = \int_{-3}^3 \int_0^3 \frac{3}{\sqrt{9-y^2}} dx dy = 9\pi; \mathbf{M}_{xy} = \iint_{\text{S}} z d\sigma \\
&= \int_{-3}^3 \int_0^3 z \left(\frac{3}{z} \right) dx dy = 54; \mathbf{M}_{xz} = \iint_{\text{S}} y d\sigma = \int_{-3}^3 \int_0^3 y \left(\frac{3}{z} \right) dx dy = \int_{-3}^3 \int_0^3 \frac{3y}{\sqrt{9-y^2}} dx dy = 0; \\
\mathbf{M}_{yz} &= \iint_{\text{S}} x d\sigma = \int_{-3}^3 \int_0^3 \frac{3x}{\sqrt{9-y^2}} dx dy = \frac{27}{2} \pi. \text{ Therefore, } \bar{x} = \frac{\left(\frac{27}{2} \pi \right)}{9\pi} = \frac{3}{2}, \bar{y} = 0, \text{ and } \bar{z} = \frac{54}{9\pi} = \frac{6}{\pi}
\end{aligned}$$

$$\begin{aligned}
35. \text{ Because of symmetry, } \bar{x} &= \bar{y} = 0; \mathbf{M} = \iint_{\text{S}} \delta d\sigma = \delta \iint_{\text{S}} d\sigma = (\text{Area of S})\delta = 3\pi\sqrt{2}\delta; \nabla f = 2x\mathbf{i} + 2y\mathbf{j} - 2z\mathbf{k} \\
&\Rightarrow |\nabla f| = \sqrt{4x^2 + 4y^2 + 4z^2} = 2\sqrt{x^2 + y^2 + z^2}; \mathbf{p} = \mathbf{k} \Rightarrow |\nabla f \cdot \mathbf{p}| = 2z \Rightarrow d\sigma = \frac{2\sqrt{x^2 + y^2 + z^2}}{2z} dA \\
&= \frac{\sqrt{x^2 + y^2 + (x^2 + y^2)}}{z} dA = \frac{\sqrt{2}\sqrt{x^2 + y^2}}{z} dA \Rightarrow \mathbf{M}_{xy} = \delta \iint_{\text{R}} z \left(\frac{\sqrt{2}\sqrt{x^2 + y^2}}{z} \right) dA \\
&= \delta \iint_{\text{R}} \sqrt{2}\sqrt{x^2 + y^2} dA = \delta \int_0^{2\pi} \int_1^2 \sqrt{2} r^2 dr d\theta = \frac{14\pi\sqrt{2}}{3} \delta \Rightarrow \bar{z} = \frac{\left(\frac{14\pi\sqrt{2}}{3} \delta \right)}{3\pi\sqrt{2}\delta} = \frac{14}{9} \\
&\Rightarrow (\bar{x}, \bar{y}, \bar{z}) = \left(0, 0, \frac{14}{9} \right). \text{ Next, } \mathbf{I}_z = \iint_{\text{S}} (x^2 + y^2) \delta d\sigma = \iint_{\text{R}} (x^2 + y^2) \left(\frac{\sqrt{2}\sqrt{x^2 + y^2}}{z} \right) \delta dA \\
&= \delta\sqrt{2} \iint_{\text{R}} (x^2 + y^2) dA = \delta\sqrt{2} \int_0^{2\pi} \int_1^2 r^3 dr d\theta = \frac{15\pi\sqrt{2}}{2} \delta \Rightarrow \mathbf{R}_z = \sqrt{\frac{\mathbf{I}_z}{\mathbf{M}}} = \frac{\sqrt{10}}{2}
\end{aligned}$$

$$\begin{aligned}
36. f(x, y, z) &= 4x^2 + 4y^2 - z^2 = 0 \Rightarrow \nabla f = 8x\mathbf{i} + 8y\mathbf{j} - 2z\mathbf{k} \Rightarrow |\nabla f| = \sqrt{64x^2 + 64y^2 + 4z^2} \\
&= 2\sqrt{16x^2 + 16y^2 + z^2} = 2\sqrt{4z^2 + z^2} = 2\sqrt{5}z \text{ since } z \geq 0; \mathbf{p} = \mathbf{k} \Rightarrow |\nabla f \cdot \mathbf{p}| = 2z \Rightarrow d\sigma = \frac{2\sqrt{5}z}{2z} dA = \sqrt{5} dA \\
&\Rightarrow \mathbf{I}_z = \iint_{\text{S}} (x^2 + y^2) \delta d\sigma = \delta\sqrt{5} \iint_{\text{R}} (x^2 + y^2) dx dy = \delta\sqrt{5} \int_{-\pi/2}^{\pi/2} \int_0^{\cos\theta} r^3 dr d\theta = \frac{3\sqrt{5}\pi\delta}{2}
\end{aligned}$$

$$\begin{aligned}
37. \text{ (a) Let the diameter lie on the } z\text{-axis and let } f(x, y, z) &= x^2 + y^2 + z^2 = a^2, z \geq 0 \text{ be the upper hemisphere} \\
&\Rightarrow \nabla f = 2x\mathbf{i} + 2y\mathbf{j} + 2z\mathbf{k} \Rightarrow |\nabla f| = \sqrt{4x^2 + 4y^2 + 4z^2} = 2a, a > 0; \mathbf{p} = \mathbf{k} \Rightarrow |\nabla f \cdot \mathbf{p}| = 2z \text{ since } z \geq 0 \\
&\Rightarrow d\sigma = \frac{a}{z} dA \Rightarrow \mathbf{I}_z = \iint_{\text{S}} \delta (x^2 + y^2) \left(\frac{a}{z} \right) d\sigma = a\delta \iint_{\text{R}} \frac{x^2 + y^2}{\sqrt{a^2 - (x^2 + y^2)}} dA = a\delta \int_0^{2\pi} \int_0^a \frac{r^2}{\sqrt{a^2 - r^2}} r dr d\theta \\
&= a\delta \int_0^{2\pi} \left[-r^2\sqrt{a^2 - r^2} - \frac{2}{3}(a^2 - r^2)^{3/2} \right]_0^a d\theta = a\delta \int_0^{2\pi} \frac{2}{3} a^3 d\theta = \frac{4\pi}{3} a^4 \delta \Rightarrow \text{the moment of inertia is } \frac{8\pi}{3} a^4 \delta \text{ for}
\end{aligned}$$

the whole sphere

$$\begin{aligned}
 \text{(b) } I_L &= I_{c.m.} + mh^2, \text{ where } m \text{ is the mass of the body and } h \text{ is the distance between the parallel lines; now,} \\
 I_{c.m.} &= \frac{8\pi}{3} a^4 \delta \text{ (from part a) and } \frac{m}{2} = \iint_S \delta \, d\sigma = \delta \iint_R \left(\frac{a}{z}\right) dA = a\delta \iint_R \frac{1}{\sqrt{a^2 - (x^2 + y^2)}} dy dx \\
 &= a\delta \int_0^{2\pi} \int_0^a \frac{1}{\sqrt{a^2 - r^2}} r \, dr \, d\theta = a\delta \int_0^{2\pi} \left[-\sqrt{a^2 - r^2}\right]_0^a d\theta = a\delta \int_0^{2\pi} a \, d\theta = 2\pi a^2 \delta \text{ and } h = a \\
 &\Rightarrow I_L = \frac{8\pi}{3} a^4 \delta + 4\pi a^2 \delta a^2 = \frac{20\pi}{3} a^4 \delta
 \end{aligned}$$

$$\text{38. (a) Let } z = \frac{h}{a} \sqrt{x^2 + y^2} \text{ be the cone from } z = 0 \text{ to } z = h, h > 0. \text{ Because of symmetry, } \bar{x} = 0 \text{ and } \bar{y} = 0;$$

$$\begin{aligned}
 z = \frac{h}{a} \sqrt{x^2 + y^2} &\Rightarrow f(x, y, z) = \frac{h^2}{a^2} (x^2 + y^2) - z^2 = 0 \Rightarrow \nabla f = \frac{2xh^2}{a^2} \mathbf{i} + \frac{2yh^2}{a^2} \mathbf{j} - 2z\mathbf{k} \\
 &\Rightarrow |\nabla f| = \sqrt{\frac{4x^2h^4}{a^4} + \frac{4y^2h^4}{a^4} + 4z^2} = 2\sqrt{\frac{h^4}{a^4} (x^2 + y^2) + \frac{h^2}{a^2} (x^2 + y^2)} = 2\sqrt{\left(\frac{h^2}{a^2}\right) (x^2 + y^2) \left(\frac{h^2}{a^2} + 1\right)} \\
 &= 2\sqrt{z^2 \left(\frac{h^2 + a^2}{a^2}\right)} = \left(\frac{2z}{a}\right) \sqrt{h^2 + a^2} \text{ since } z \geq 0; \mathbf{p} = \mathbf{k} \Rightarrow |\nabla f \cdot \mathbf{p}| = 2z \Rightarrow d\sigma = \frac{\left(\frac{2z}{a}\right) \sqrt{h^2 + a^2}}{2z} dA \\
 &= \frac{\sqrt{h^2 + a^2}}{a} dA; \mathbf{M} = \iint_S d\sigma = \iint_R \frac{\sqrt{h^2 + a^2}}{a} dA = \frac{\sqrt{h^2 + a^2}}{a} (\pi a^2) = \pi a \sqrt{h^2 + a^2};
 \end{aligned}$$

$$\begin{aligned}
 M_{xy} &= \iint_S z \, d\sigma = \iint_R z \left(\frac{\sqrt{h^2 + a^2}}{a}\right) dA = \frac{\sqrt{h^2 + a^2}}{a} \iint_R \frac{h}{a} \sqrt{x^2 + y^2} \, dx \, dy = \frac{h\sqrt{h^2 + a^2}}{a^2} \int_0^{2\pi} \int_0^a r^2 \, dr \, d\theta \\
 &= \frac{2\pi ah\sqrt{h^2 + a^2}}{3} \Rightarrow \bar{z} = \frac{M_{xy}}{M} = \frac{2h}{3} \Rightarrow \text{the centroid is } \left(0, 0, \frac{2h}{3}\right)
 \end{aligned}$$

$$\text{(b) The base is a circle of radius } a \text{ and center at } (0, 0, h) \Rightarrow (0, 0, h) \text{ is the centroid of the base and the mass is } M = \iint_S d\sigma = \pi a^2. \text{ In Pappus' formula, let } \mathbf{c}_1 = \frac{2h}{3} \mathbf{k}, \mathbf{c}_2 = h\mathbf{k}, m_1 = \pi a \sqrt{h^2 + a^2}, \text{ and } m_2 = \pi a^2$$

$$\Rightarrow \mathbf{c} = \frac{\pi a \sqrt{h^2 + a^2} \left(\frac{2h}{3}\right) \mathbf{k} + \pi a^2 h \mathbf{k}}{\pi a \sqrt{h^2 + a^2} + \pi a^2} = \frac{2h\sqrt{h^2 + a^2} + 3ah}{3(\sqrt{h^2 + a^2} + a)} \mathbf{k} \Rightarrow \text{the centroid is } \left(0, 0, \frac{2h\sqrt{h^2 + a^2} + 3ah}{3(\sqrt{h^2 + a^2} + a)}\right)$$

$$\text{(c) If the hemisphere is sitting so its base is in the plane } z = h, \text{ then its centroid is } \left(0, 0, h + \frac{a}{2}\right) \text{ and its mass is } 2\pi a^2. \text{ In Pappus' formula, let } \mathbf{c}_1 = \frac{2h}{3} \mathbf{k}, \mathbf{c}_2 = \left(h + \frac{a}{2}\right) \mathbf{k}, m_1 = \pi a \sqrt{h^2 + a^2}, \text{ and } m_2 = 2\pi a^2$$

$$\Rightarrow \mathbf{c} = \frac{\pi a \sqrt{h^2 + a^2} \left(\frac{2h}{3}\right) \mathbf{k} + 2\pi a^2 \left(h + \frac{a}{2}\right) \mathbf{k}}{\pi a \sqrt{h^2 + a^2} + 2\pi a^2} = \frac{2h\sqrt{h^2 + a^2} + 6ah + 3a^2}{3(\sqrt{h^2 + a^2} + 2a)} \mathbf{k} \Rightarrow \text{the centroid is}$$

$$\left(0, 0, \frac{2h\sqrt{h^2 + a^2} + 6ah + 3a^2}{3(\sqrt{h^2 + a^2} + 2a)}\right). \text{ Thus, for the centroid to be in the plane of the bases we must have } z = h$$

$$\Rightarrow \frac{2h\sqrt{h^2 + a^2} + 6ah + 3a^2}{3(\sqrt{h^2 + a^2} + 2a)} = h \Rightarrow 2h\sqrt{h^2 + a^2} + 6ah + 3a^2 = 3h\sqrt{h^2 + a^2} + 6ah \Rightarrow 3a^2 = h\sqrt{h^2 + a^2}$$

$$\Rightarrow 9a^4 = h^2 (h^2 + a^2) \Rightarrow h^4 + a^2 h^2 - 9a^4 = 0 \Rightarrow h^2 = \frac{(\sqrt{37} - 1)a^2}{2} \text{ (the positive root)} \Rightarrow h = \frac{\sqrt{2\sqrt{37} - 2}}{2} a$$

$$\begin{aligned}
 \text{39. } f_x(x, y) &= 2x, f_y(x, y) = 2y \Rightarrow \sqrt{f_x^2 + f_y^2 + 1} = \sqrt{4x^2 + 4y^2 + 1} \Rightarrow \text{Area} = \iint_R \sqrt{4x^2 + 4y^2 + 1} \, dx \, dy \\
 &= \int_0^{2\pi} \int_0^{\sqrt{3}} \sqrt{4r^2 + 1} \, r \, dr \, d\theta = \frac{\pi}{6} (13\sqrt{13} - 1)
 \end{aligned}$$

$$\begin{aligned}
 \text{40. } f_y(y, z) &= -2y, f_z(y, z) = -2z \Rightarrow \sqrt{f_y^2 + f_z^2 + 1} = \sqrt{4y^2 + 4z^2 + 1} \Rightarrow \text{Area} = \iint_R \sqrt{4y^2 + 4z^2 + 1} \, dy \, dz \\
 &= \int_0^{2\pi} \int_0^1 \sqrt{4r^2 + 1} \, r \, dr \, d\theta = \frac{\pi}{6} (5\sqrt{5} - 1)
 \end{aligned}$$

$$\begin{aligned}
 \text{41. } f_x(x, y) &= \frac{x}{\sqrt{x^2 + y^2}}, f_y(x, y) = \frac{y}{\sqrt{x^2 + y^2}} \Rightarrow \sqrt{f_x^2 + f_y^2 + 1} = \sqrt{\frac{x^2}{x^2 + y^2} + \frac{y^2}{x^2 + y^2} + 1} = \sqrt{2} \\
 &\Rightarrow \text{Area} = \iint_{R_{xy}} \sqrt{2} \, dx \, dy = \sqrt{2} (\text{Area between the ellipse and the circle}) = \sqrt{2} (6\pi - \pi) = 5\pi\sqrt{2}
 \end{aligned}$$

42. Over R_{xy} : $z = 2 - \frac{2}{3}x - 2y \Rightarrow f_x(x, y) = -\frac{2}{3}, f_y(x, y) = -2 \Rightarrow \sqrt{f_x^2 + f_y^2 + 1} = \sqrt{\frac{4}{9} + 4 + 1} = \frac{7}{3}$
 $\Rightarrow \text{Area} = \iint_{R_{xy}} \frac{7}{3} dA = \frac{7}{3} (\text{Area of the shadow triangle in the } xy\text{-plane}) = \left(\frac{7}{3}\right) \left(\frac{3}{2}\right) = \frac{7}{2}.$

Over R_{xz} : $y = 1 - \frac{1}{3}x - \frac{1}{2}z \Rightarrow f_x(x, z) = -\frac{1}{3}, f_z(x, z) = -\frac{1}{2} \Rightarrow \sqrt{f_x^2 + f_z^2 + 1} = \sqrt{\frac{1}{9} + \frac{1}{4} + 1} = \frac{7}{6}$
 $\Rightarrow \text{Area} = \iint_{R_{xz}} \frac{7}{6} dA = \frac{7}{6} (\text{Area of the shadow triangle in the } xz\text{-plane}) = \left(\frac{7}{6}\right) (3) = \frac{7}{2}.$

Over R_{yz} : $x = 3 - 3y - \frac{3}{2}z \Rightarrow f_y(y, z) = -3, f_z(y, z) = -\frac{3}{2} \Rightarrow \sqrt{f_y^2 + f_z^2 + 1} = \sqrt{9 + \frac{9}{4} + 1} = \frac{7}{2}$
 $\Rightarrow \text{Area} = \iint_{R_{yz}} \frac{7}{2} dA = \frac{7}{2} (\text{Area of the shadow triangle in the } yz\text{-plane}) = \left(\frac{7}{2}\right) (1) = \frac{7}{2}.$

43. $y = \frac{2}{3}z^{3/2} \Rightarrow f_x(x, z) = 0, f_z(x, z) = z^{1/2} \Rightarrow \sqrt{f_x^2 + f_z^2 + 1} = \sqrt{z + 1}; y = \frac{16}{3} \Rightarrow \frac{16}{3} = \frac{2}{3}z^{3/2} \Rightarrow z = 4$
 $\Rightarrow \text{Area} = \int_0^4 \int_0^1 \sqrt{z + 1} dx dz = \int_0^4 \sqrt{z + 1} dz = \frac{2}{3} (5\sqrt{5} - 1)$

44. $y = 4 - z \Rightarrow f_x(x, z) = 0, f_z(x, z) = -1 \Rightarrow \sqrt{f_x^2 + f_z^2 + 1} = \sqrt{2} \Rightarrow \text{Area} = \iint_{R_{xz}} \sqrt{2} dA = \int_0^2 \int_0^{4-z} \sqrt{2} dx dz$
 $= \sqrt{2} \int_0^2 (4 - z^2) dz = \frac{16\sqrt{2}}{3}$

16.6 PARAMETRIZED SURFACES

- In cylindrical coordinates, let $x = r \cos \theta, y = r \sin \theta, z = (\sqrt{x^2 + y^2})^2 = r^2$. Then $\mathbf{r}(r, \theta) = (r \cos \theta)\mathbf{i} + (r \sin \theta)\mathbf{j} + r^2\mathbf{k}, 0 \leq r \leq 2, 0 \leq \theta \leq 2\pi$.
- In cylindrical coordinates, let $x = r \cos \theta, y = r \sin \theta, z = 9 - x^2 - y^2 = 9 - r^2$. Then $\mathbf{r}(r, \theta) = (r \cos \theta)\mathbf{i} + (r \sin \theta)\mathbf{j} + (9 - r^2)\mathbf{k}; z \geq 0 \Rightarrow 9 - r^2 \geq 0 \Rightarrow r^2 \leq 9 \Rightarrow -3 \leq r \leq 3, 0 \leq \theta \leq 2\pi$. But $-3 \leq r \leq 0$ gives the same points as $0 \leq r \leq 3$, so let $0 \leq r \leq 3$.
- In cylindrical coordinates, let $x = r \cos \theta, y = r \sin \theta, z = \frac{\sqrt{x^2 + y^2}}{2} \Rightarrow z = \frac{r}{2}$. Then $\mathbf{r}(r, \theta) = (r \cos \theta)\mathbf{i} + (r \sin \theta)\mathbf{j} + \left(\frac{r}{2}\right)\mathbf{k}$. For $0 \leq z \leq 3, 0 \leq \frac{r}{2} \leq 3 \Rightarrow 0 \leq r \leq 6$; to get only the first octant, let $0 \leq \theta \leq \frac{\pi}{2}$.
- In cylindrical coordinates, let $x = r \cos \theta, y = r \sin \theta, z = 2\sqrt{x^2 + y^2} \Rightarrow z = 2r$. Then $\mathbf{r}(r, \theta) = (r \cos \theta)\mathbf{i} + (r \sin \theta)\mathbf{j} + 2r\mathbf{k}$. For $2 \leq z \leq 4, 2 \leq 2r \leq 4 \Rightarrow 1 \leq r \leq 2$, and let $0 \leq \theta \leq 2\pi$.
- In cylindrical coordinates, let $x = r \cos \theta, y = r \sin \theta$ since $x^2 + y^2 = r^2 \Rightarrow z^2 = 9 - (x^2 + y^2) = 9 - r^2$
 $\Rightarrow z = \sqrt{9 - r^2}, z \geq 0$. Then $\mathbf{r}(r, \theta) = (r \cos \theta)\mathbf{i} + (r \sin \theta)\mathbf{j} + \sqrt{9 - r^2}\mathbf{k}$. Let $0 \leq \theta \leq 2\pi$. For the domain of r : $z = \sqrt{x^2 + y^2}$ and $x^2 + y^2 + z^2 = 9 \Rightarrow x^2 + y^2 + (\sqrt{x^2 + y^2})^2 = 9 \Rightarrow 2(x^2 + y^2) = 9 \Rightarrow 2r^2 = 9$
 $\Rightarrow r = \frac{3}{\sqrt{2}} \Rightarrow 0 \leq r \leq \frac{3}{\sqrt{2}}$.
- In cylindrical coordinates, $\mathbf{r}(r, \theta) = (r \cos \theta)\mathbf{i} + (r \sin \theta)\mathbf{j} + \sqrt{4 - r^2}\mathbf{k}$ (see Exercise 5 above with $x^2 + y^2 + z^2 = 4$, instead of $x^2 + y^2 + z^2 = 9$). For the first octant, let $0 \leq \theta \leq \frac{\pi}{2}$. For the domain of r : $z = \sqrt{x^2 + y^2}$ and $x^2 + y^2 + z^2 = 4 \Rightarrow x^2 + y^2 + (\sqrt{x^2 + y^2})^2 = 4 \Rightarrow 2(x^2 + y^2) = 4 \Rightarrow 2r^2 = 4 \Rightarrow r = \sqrt{2}$. Thus, let $\sqrt{2} \leq r \leq 2$ (to get the portion of the sphere between the cone and the xy -plane).

7. In spherical coordinates, $x = \rho \sin \phi \cos \theta$, $y = \rho \sin \phi \sin \theta$, $\rho = \sqrt{x^2 + y^2 + z^2} \Rightarrow \rho^2 = 3 \Rightarrow \rho = \sqrt{3}$
 $\Rightarrow z = \sqrt{3} \cos \phi$ for the sphere; $z = \frac{\sqrt{3}}{2} = \sqrt{3} \cos \phi \Rightarrow \cos \phi = \frac{1}{2} \Rightarrow \phi = \frac{\pi}{3}$; $z = -\frac{\sqrt{3}}{2} \Rightarrow -\frac{\sqrt{3}}{2} = \sqrt{3} \cos \phi$
 $\Rightarrow \cos \phi = -\frac{1}{2} \Rightarrow \phi = \frac{2\pi}{3}$. Then $\mathbf{r}(\phi, \theta) = (\sqrt{3} \sin \phi \cos \theta) \mathbf{i} + (\sqrt{3} \sin \phi \sin \theta) \mathbf{j} + (\sqrt{3} \cos \phi) \mathbf{k}$,
 $\frac{\pi}{3} \leq \phi \leq \frac{2\pi}{3}$ and $0 \leq \theta \leq 2\pi$.
8. In spherical coordinates, $x = \rho \sin \phi \cos \theta$, $y = \rho \sin \phi \sin \theta$, $\rho = \sqrt{x^2 + y^2 + z^2} \Rightarrow \rho^2 = 8 \Rightarrow \rho = \sqrt{8} = 2\sqrt{2}$
 $\Rightarrow x = 2\sqrt{2} \sin \phi \cos \theta$, $y = 2\sqrt{2} \sin \phi \sin \theta$, and $z = 2\sqrt{2} \cos \phi$. Thus let
 $\mathbf{r}(\phi, \theta) = (2\sqrt{2} \sin \phi \cos \theta) \mathbf{i} + (2\sqrt{2} \sin \phi \sin \theta) \mathbf{j} + (2\sqrt{2} \cos \phi) \mathbf{k}$; $z = -2 \Rightarrow -2 = 2\sqrt{2} \cos \phi$
 $\Rightarrow \cos \phi = -\frac{1}{\sqrt{2}} \Rightarrow \phi = \frac{3\pi}{4}$; $z = 2\sqrt{2} \Rightarrow 2\sqrt{2} = 2\sqrt{2} \cos \phi \Rightarrow \cos \phi = 1 \Rightarrow \phi = 0$. Thus $0 \leq \phi \leq \frac{3\pi}{4}$ and
 $0 \leq \theta \leq 2\pi$.
9. Since $z = 4 - y^2$, we can let \mathbf{r} be a function of x and $y \Rightarrow \mathbf{r}(x, y) = x\mathbf{i} + y\mathbf{j} + (4 - y^2)\mathbf{k}$. Then $z = 0$
 $\Rightarrow 0 = 4 - y^2 \Rightarrow y = \pm 2$. Thus, let $-2 \leq y \leq 2$ and $0 \leq x \leq 2$.
10. Since $y = x^2$, we can let \mathbf{r} be a function of x and $z \Rightarrow \mathbf{r}(x, z) = x\mathbf{i} + x^2\mathbf{j} + z\mathbf{k}$. Then $y = 2$
 $\Rightarrow x^2 = 2 \Rightarrow x = \pm\sqrt{2}$. Thus, let $-\sqrt{2} \leq x \leq \sqrt{2}$ and $0 \leq z \leq 3$.
11. When $x = 0$, let $y^2 + z^2 = 9$ be the circular section in the yz -plane. Use polar coordinates in the yz -plane
 $\Rightarrow y = 3 \cos \theta$ and $z = 3 \sin \theta$. Thus let $x = u$ and $\theta = v \Rightarrow \mathbf{r}(u, v) = u\mathbf{i} + (3 \cos v)\mathbf{j} + (3 \sin v)\mathbf{k}$ where
 $0 \leq u \leq 3$, and $0 \leq v \leq 2\pi$.
12. When $y = 0$, let $x^2 + z^2 = 4$ be the circular section in the xz -plane. Use polar coordinates in the xz -plane
 $\Rightarrow x = 2 \cos \theta$ and $z = 2 \sin \theta$. Thus let $y = u$ and $\theta = v \Rightarrow \mathbf{r}(u, v) = (2 \cos v)\mathbf{i} + u\mathbf{j} + (2 \sin v)\mathbf{k}$ where
 $-2 \leq u \leq 2$, and $0 \leq v \leq \pi$ (since we want the portion above the xy -plane).
13. (a) $x + y + z = 1 \Rightarrow z = 1 - x - y$. In cylindrical coordinates, let $x = r \cos \theta$ and $y = r \sin \theta$
 $\Rightarrow z = 1 - r \cos \theta - r \sin \theta \Rightarrow \mathbf{r}(r, \theta) = (r \cos \theta)\mathbf{i} + (r \sin \theta)\mathbf{j} + (1 - r \cos \theta - r \sin \theta)\mathbf{k}$, $0 \leq \theta \leq 2\pi$ and
 $0 \leq r \leq 3$.
- (b) In a fashion similar to cylindrical coordinates, but working in the yz -plane instead of the xy -plane, let
 $y = u \cos v$, $z = u \sin v$ where $u = \sqrt{y^2 + z^2}$ and v is the angle formed by (x, y, z) , $(x, 0, 0)$, and $(x, y, 0)$
with $(x, 0, 0)$ as vertex. Since $x + y + z = 1 \Rightarrow x = 1 - y - z \Rightarrow x = 1 - u \cos v - u \sin v$, then \mathbf{r} is a
function of u and $v \Rightarrow \mathbf{r}(u, v) = (1 - u \cos v - u \sin v)\mathbf{i} + (u \cos v)\mathbf{j} + (u \sin v)\mathbf{k}$, $0 \leq u \leq 3$ and $0 \leq v \leq 2\pi$.
14. (a) In a fashion similar to cylindrical coordinates, but working in the xz -plane instead of the xy -plane, let
 $x = u \cos v$, $z = u \sin v$ where $u = \sqrt{x^2 + z^2}$ and v is the angle formed by (x, y, z) , $(y, 0, 0)$, and $(x, y, 0)$
with vertex $(y, 0, 0)$. Since $x - y + 2z = 2 \Rightarrow y = x + 2z - 2$, then $\mathbf{r}(u, v)$
 $= (u \cos v)\mathbf{i} + (u \cos v + 2u \sin v - 2)\mathbf{j} + (u \sin v)\mathbf{k}$, $0 \leq u \leq \sqrt{3}$ and $0 \leq v \leq 2\pi$.
- (b) In a fashion similar to cylindrical coordinates, but working in the yz -plane instead of the xy -plane, let
 $y = u \cos v$, $z = u \sin v$ where $u = \sqrt{y^2 + z^2}$ and v is the angle formed by (x, y, z) , $(x, 0, 0)$, and $(x, y, 0)$
with vertex $(x, 0, 0)$. Since $x - y + 2z = 2 \Rightarrow x = y - 2z + 2$, then $\mathbf{r}(u, v)$
 $= (u \cos v - 2u \sin v + 2)\mathbf{i} + (u \cos v)\mathbf{j} + (u \sin v)\mathbf{k}$, $0 \leq u \leq \sqrt{2}$ and $0 \leq v \leq 2\pi$.
15. Let $x = w \cos v$ and $z = w \sin v$. Then $(x - 2)^2 + z^2 = 4 \Rightarrow x^2 - 4x + z^2 = 0 \Rightarrow w^2 \cos^2 v - 4w \cos v + w^2 \sin^2 v$
 $= 0 \Rightarrow w^2 - 4w \cos v = 0 \Rightarrow w = 0$ or $w - 4 \cos v = 0 \Rightarrow w = 0$ or $w = 4 \cos v$. Now $w = 0 \Rightarrow x = 0$ and $y = 0$,
which is a line not a cylinder. Therefore, let $w = 4 \cos v \Rightarrow x = (4 \cos v)(\cos v) = 4 \cos^2 v$ and $z = 4 \cos v \sin v$.
Finally, let $y = u$. Then $\mathbf{r}(u, v) = (4 \cos^2 v)\mathbf{i} + u\mathbf{j} + (4 \cos v \sin v)\mathbf{k}$, $-\frac{\pi}{2} \leq v \leq \frac{\pi}{2}$ and $0 \leq u \leq 3$.

16. Let $y = w \cos v$ and $z = w \sin v$. Then $y^2 + (z - 5)^2 = 25 \Rightarrow y^2 + z^2 - 10z = 0$
 $\Rightarrow w^2 \cos^2 v + w^2 \sin^2 v - 10w \sin v = 0 \Rightarrow w^2 - 10w \sin v = 0 \Rightarrow w(w - 10 \sin v) = 0 \Rightarrow w = 0$ or
 $w = 10 \sin v$. Now $w = 0 \Rightarrow y = 0$ and $z = 0$, which is a line not a cylinder. Therefore, let $w = 10 \sin v$
 $\Rightarrow y = 10 \sin v \cos v$ and $z = 10 \sin^2 v$. Finally, let $x = u$. Then $\mathbf{r}(u, v) = u\mathbf{i} + (10 \sin v \cos v)\mathbf{j} + (10 \sin^2 v)\mathbf{k}$,
 $0 \leq u \leq 10$ and $0 \leq v \leq \pi$.

17. Let $x = r \cos \theta$ and $y = r \sin \theta$. Then $\mathbf{r}(r, \theta) = (r \cos \theta)\mathbf{i} + (r \sin \theta)\mathbf{j} + \left(\frac{2-r \sin \theta}{2}\right)\mathbf{k}$, $0 \leq r \leq 1$ and $0 \leq \theta \leq 2\pi$
 $\Rightarrow \mathbf{r}_r = (\cos \theta)\mathbf{i} + (\sin \theta)\mathbf{j} - \left(\frac{\sin \theta}{2}\right)\mathbf{k}$ and $\mathbf{r}_\theta = (-r \sin \theta)\mathbf{i} + (r \cos \theta)\mathbf{j} - \left(\frac{r \cos \theta}{2}\right)\mathbf{k}$

$$\Rightarrow \mathbf{r}_r \times \mathbf{r}_\theta = \begin{vmatrix} \mathbf{i} & \mathbf{j} & \mathbf{k} \\ \cos \theta & \sin \theta & -\frac{\sin \theta}{2} \\ -r \sin \theta & r \cos \theta & -\frac{r \cos \theta}{2} \end{vmatrix}$$

$$= \left(\frac{-r \sin \theta \cos \theta}{2} + \frac{(\sin \theta)(r \cos \theta)}{2}\right)\mathbf{i} + \left(\frac{r \sin^2 \theta}{2} + \frac{r \cos^2 \theta}{2}\right)\mathbf{j} + (r \cos^2 \theta + r \sin^2 \theta)\mathbf{k} = \frac{r}{2}\mathbf{j} + r\mathbf{k}$$

$$\Rightarrow |\mathbf{r}_r \times \mathbf{r}_\theta| = \sqrt{\frac{r^2}{4} + r^2} = \frac{\sqrt{5}r}{2} \Rightarrow A = \int_0^{2\pi} \int_0^1 \frac{\sqrt{5}r}{2} dr d\theta = \int_0^{2\pi} \left[\frac{\sqrt{5}r^2}{4}\right]_0^1 d\theta = \int_0^{2\pi} d\theta = \frac{\pi\sqrt{5}}{2}$$

18. Let $x = r \cos \theta$ and $y = r \sin \theta \Rightarrow z = -x = -r \cos \theta$, $0 \leq r \leq 2$ and $0 \leq \theta \leq 2\pi$. Then

$$\mathbf{r}(r, \theta) = (r \cos \theta)\mathbf{i} + (r \sin \theta)\mathbf{j} - (r \cos \theta)\mathbf{k} \Rightarrow \mathbf{r}_r = (\cos \theta)\mathbf{i} + (\sin \theta)\mathbf{j} - (\cos \theta)\mathbf{k} \text{ and}$$

$$\mathbf{r}_\theta = (-r \sin \theta)\mathbf{i} + (r \cos \theta)\mathbf{j} + (r \sin \theta)\mathbf{k}$$

$$\Rightarrow \mathbf{r}_r \times \mathbf{r}_\theta = \begin{vmatrix} \mathbf{i} & \mathbf{j} & \mathbf{k} \\ \cos \theta & \sin \theta & -\cos \theta \\ -r \sin \theta & r \cos \theta & r \sin \theta \end{vmatrix}$$

$$= (r \sin^2 \theta + r \cos^2 \theta)\mathbf{i} + (r \sin \theta \cos \theta - r \sin \theta \cos \theta)\mathbf{j} + (r \cos^2 \theta + r \sin^2 \theta)\mathbf{k} = r\mathbf{i} + r\mathbf{k}$$

$$\Rightarrow |\mathbf{r}_r \times \mathbf{r}_\theta| = \sqrt{r^2 + r^2} = r\sqrt{2} \Rightarrow A = \int_0^{2\pi} \int_0^2 r\sqrt{2} dr d\theta = \int_0^{2\pi} \left[\frac{r^2\sqrt{2}}{2}\right]_0^2 d\theta = \int_0^{2\pi} 2\sqrt{2} d\theta = 4\pi\sqrt{2}$$

19. Let $x = r \cos \theta$ and $y = r \sin \theta \Rightarrow z = 2\sqrt{x^2 + y^2} = 2r$, $1 \leq r \leq 3$ and $0 \leq \theta \leq 2\pi$. Then

$$\mathbf{r}(r, \theta) = (r \cos \theta)\mathbf{i} + (r \sin \theta)\mathbf{j} + 2r\mathbf{k} \Rightarrow \mathbf{r}_r = (\cos \theta)\mathbf{i} + (\sin \theta)\mathbf{j} + 2\mathbf{k} \text{ and } \mathbf{r}_\theta = (-r \sin \theta)\mathbf{i} + (r \cos \theta)\mathbf{j}$$

$$\Rightarrow \mathbf{r}_r \times \mathbf{r}_\theta = \begin{vmatrix} \mathbf{i} & \mathbf{j} & \mathbf{k} \\ \cos \theta & \sin \theta & 2 \\ -r \sin \theta & r \cos \theta & 0 \end{vmatrix} = (-2r \cos \theta)\mathbf{i} - (2r \sin \theta)\mathbf{j} + (r \cos^2 \theta + r \sin^2 \theta)\mathbf{k}$$

$$= (-2r \cos \theta)\mathbf{i} - (2r \sin \theta)\mathbf{j} + r\mathbf{k} \Rightarrow |\mathbf{r}_r \times \mathbf{r}_\theta| = \sqrt{4r^2 \cos^2 \theta + 4r^2 \sin^2 \theta + r^2} = \sqrt{5r^2} = r\sqrt{5}$$

$$\Rightarrow A = \int_0^{2\pi} \int_1^3 r\sqrt{5} dr d\theta = \int_0^{2\pi} \left[\frac{r^2\sqrt{5}}{2}\right]_1^3 d\theta = \int_0^{2\pi} 4\sqrt{5} d\theta = 8\pi\sqrt{5}$$

20. Let $x = r \cos \theta$ and $y = r \sin \theta \Rightarrow z = \frac{\sqrt{x^2 + y^2}}{3} = \frac{r}{3}$, $3 \leq r \leq 4$ and $0 \leq \theta \leq 2\pi$. Then

$$\mathbf{r}(r, \theta) = (r \cos \theta)\mathbf{i} + (r \sin \theta)\mathbf{j} + \left(\frac{r}{3}\right)\mathbf{k} \Rightarrow \mathbf{r}_r = (\cos \theta)\mathbf{i} + (\sin \theta)\mathbf{j} + \left(\frac{1}{3}\right)\mathbf{k} \text{ and } \mathbf{r}_\theta = (-r \sin \theta)\mathbf{i} + (r \cos \theta)\mathbf{j}$$

$$\Rightarrow \mathbf{r}_r \times \mathbf{r}_\theta = \begin{vmatrix} \mathbf{i} & \mathbf{j} & \mathbf{k} \\ \cos \theta & \sin \theta & \frac{1}{3} \\ -r \sin \theta & r \cos \theta & 0 \end{vmatrix} = \left(-\frac{1}{3}r \cos \theta\right)\mathbf{i} - \left(\frac{1}{3}r \sin \theta\right)\mathbf{j} + (r \cos^2 \theta + r \sin^2 \theta)\mathbf{k}$$

$$= \left(-\frac{1}{3}r \cos \theta\right)\mathbf{i} - \left(\frac{1}{3}r \sin \theta\right)\mathbf{j} + r\mathbf{k} \Rightarrow |\mathbf{r}_r \times \mathbf{r}_\theta| = \sqrt{\frac{1}{9}r^2 \cos^2 \theta + \frac{1}{9}r^2 \sin^2 \theta + r^2} = \sqrt{\frac{10r^2}{9}} = \frac{r\sqrt{10}}{3}$$

$$\Rightarrow A = \int_0^{2\pi} \int_3^4 \frac{r\sqrt{10}}{3} dr d\theta = \int_0^{2\pi} \left[\frac{r^2\sqrt{10}}{6}\right]_3^4 d\theta = \int_0^{2\pi} \frac{7\sqrt{10}}{6} d\theta = \frac{7\pi\sqrt{10}}{3}$$

21. Let $x = r \cos \theta$ and $y = r \sin \theta \Rightarrow r^2 = x^2 + y^2 = 1$, $1 \leq z \leq 4$ and $0 \leq \theta \leq 2\pi$. Then

$$\mathbf{r}(z, \theta) = (\cos \theta)\mathbf{i} + (\sin \theta)\mathbf{j} + z\mathbf{k} \Rightarrow \mathbf{r}_z = \mathbf{k} \text{ and } \mathbf{r}_\theta = (-\sin \theta)\mathbf{i} + (\cos \theta)\mathbf{j}$$

$$\Rightarrow \mathbf{r}_\theta \times \mathbf{r}_z = \begin{vmatrix} \mathbf{i} & \mathbf{j} & \mathbf{k} \\ -\sin \theta & \cos \theta & 0 \\ 0 & 0 & 1 \end{vmatrix} = (\cos \theta)\mathbf{i} + (\sin \theta)\mathbf{j} \Rightarrow |\mathbf{r}_\theta \times \mathbf{r}_z| = \sqrt{\cos^2 \theta + \sin^2 \theta} = 1$$

$$\Rightarrow A = \int_0^{2\pi} \int_1^4 1 \, dr \, d\theta = \int_0^{2\pi} 3 \, d\theta = 6\pi$$

22. Let $x = u \cos v$ and $z = u \sin v \Rightarrow u^2 = x^2 + z^2 = 10, -1 \leq y \leq 1, 0 \leq v \leq 2\pi$. Then

$$\mathbf{r}(y, v) = (u \cos v)\mathbf{i} + y\mathbf{j} + (u \sin v)\mathbf{k} = (\sqrt{10} \cos v)\mathbf{i} + y\mathbf{j} + (\sqrt{10} \sin v)\mathbf{k}$$

$$\begin{aligned} \Rightarrow \mathbf{r}_v &= (-\sqrt{10} \sin v)\mathbf{i} + (\sqrt{10} \cos v)\mathbf{k} \text{ and } \mathbf{r}_y = \mathbf{j} \Rightarrow \mathbf{r}_v \times \mathbf{r}_y = \begin{vmatrix} \mathbf{i} & \mathbf{j} & \mathbf{k} \\ -\sqrt{10} \sin v & 0 & \sqrt{10} \cos v \\ 0 & 1 & 0 \end{vmatrix} \\ &= (-\sqrt{10} \cos v)\mathbf{i} - (\sqrt{10} \sin v)\mathbf{k} \Rightarrow |\mathbf{r}_v \times \mathbf{r}_y| = \sqrt{10} \Rightarrow A = \int_0^{2\pi} \int_{-1}^1 \sqrt{10} \, du \, dv = \int_0^{2\pi} [\sqrt{10}u]_{-1}^1 \, dv \\ &= \int_0^{2\pi} 2\sqrt{10} \, dv = 4\pi\sqrt{10} \end{aligned}$$

23. $z = 2 - x^2 - y^2$ and $z = \sqrt{x^2 + y^2} \Rightarrow z = 2 - z^2 \Rightarrow z^2 + z - 2 = 0 \Rightarrow z = -2$ or $z = 1$. Since $z = \sqrt{x^2 + y^2} \geq 0$, we get $z = 1$ where the cone intersects the paraboloid. When $x = 0$ and $y = 0, z = 2 \Rightarrow$ the vertex of the paraboloid is $(0, 0, 2)$. Therefore, z ranges from 1 to 2 on the "cap" $\Rightarrow r$ ranges from 1 (when $x^2 + y^2 = 1$) to 0 (when $x = 0$ and $y = 0$ at the vertex). Let $x = r \cos \theta, y = r \sin \theta$, and $z = 2 - r^2$. Then

$$\mathbf{r}(r, \theta) = (r \cos \theta)\mathbf{i} + (r \sin \theta)\mathbf{j} + (2 - r^2)\mathbf{k}, 0 \leq r \leq 1, 0 \leq \theta \leq 2\pi \Rightarrow \mathbf{r}_r = (\cos \theta)\mathbf{i} + (\sin \theta)\mathbf{j} - 2r\mathbf{k} \text{ and}$$

$$\begin{aligned} \mathbf{r}_\theta &= (-r \sin \theta)\mathbf{i} + (r \cos \theta)\mathbf{j} \Rightarrow \mathbf{r}_r \times \mathbf{r}_\theta = \begin{vmatrix} \mathbf{i} & \mathbf{j} & \mathbf{k} \\ \cos \theta & \sin \theta & -2r \\ -r \sin \theta & r \cos \theta & 0 \end{vmatrix} \\ &= (2r^2 \cos \theta)\mathbf{i} + (2r^2 \sin \theta)\mathbf{j} + r\mathbf{k} \Rightarrow |\mathbf{r}_r \times \mathbf{r}_\theta| = \sqrt{4r^4 \cos^2 \theta + 4r^4 \sin^2 \theta + r^2} = r\sqrt{4r^2 + 1} \\ \Rightarrow A &= \int_0^{2\pi} \int_0^1 r\sqrt{4r^2 + 1} \, dr \, d\theta = \int_0^{2\pi} \left[\frac{1}{12} (4r^2 + 1)^{3/2} \right]_0^1 \, d\theta = \int_0^{2\pi} \left(\frac{5\sqrt{5}-1}{12} \right) \, d\theta = \frac{\pi}{6} (5\sqrt{5} - 1) \end{aligned}$$

24. Let $x = r \cos \theta, y = r \sin \theta$ and $z = x^2 + y^2 = r^2$. Then $\mathbf{r}(r, \theta) = (r \cos \theta)\mathbf{i} + (r \sin \theta)\mathbf{j} + r^2\mathbf{k}, 1 \leq r \leq 2, 0 \leq \theta \leq 2\pi \Rightarrow \mathbf{r}_r = (\cos \theta)\mathbf{i} + (\sin \theta)\mathbf{j} + 2r\mathbf{k}$ and $\mathbf{r}_\theta = (-r \sin \theta)\mathbf{i} + (r \cos \theta)\mathbf{j}$

$$\begin{aligned} \Rightarrow \mathbf{r}_r \times \mathbf{r}_\theta &= \begin{vmatrix} \mathbf{i} & \mathbf{j} & \mathbf{k} \\ \cos \theta & \sin \theta & 2r \\ -r \sin \theta & r \cos \theta & 0 \end{vmatrix} = (-2r^2 \cos \theta)\mathbf{i} - (2r^2 \sin \theta)\mathbf{j} + r\mathbf{k} \Rightarrow |\mathbf{r}_r \times \mathbf{r}_\theta| \\ &= \sqrt{4r^4 \cos^2 \theta + 4r^4 \sin^2 \theta + r^2} = r\sqrt{4r^2 + 1} \Rightarrow A = \int_0^{2\pi} \int_1^2 r\sqrt{4r^2 + 1} \, dr \, d\theta = \int_0^{2\pi} \left[\frac{1}{12} (4r^2 + 1)^{3/2} \right]_1^2 \, d\theta \\ &= \int_0^{2\pi} \left(\frac{17\sqrt{17} - 5\sqrt{5}}{12} \right) \, d\theta = \frac{\pi}{6} (17\sqrt{17} - 5\sqrt{5}) \end{aligned}$$

25. Let $x = \rho \sin \phi \cos \theta, y = \rho \sin \phi \sin \theta$, and $z = \rho \cos \phi \Rightarrow \rho = \sqrt{x^2 + y^2 + z^2} = \sqrt{2}$ on the sphere. Next, $x^2 + y^2 + z^2 = 2$ and $z = \sqrt{x^2 + y^2} \Rightarrow z^2 + z^2 = 2 \Rightarrow z^2 = 1 \Rightarrow z = 1$ since $z \geq 0 \Rightarrow \phi = \frac{\pi}{4}$. For the lower portion of the sphere cut by the cone, we get $\phi = \pi$. Then

$$\mathbf{r}(\phi, \theta) = (\sqrt{2} \sin \phi \cos \theta)\mathbf{i} + (\sqrt{2} \sin \phi \sin \theta)\mathbf{j} + (\sqrt{2} \cos \phi)\mathbf{k}, \frac{\pi}{4} \leq \phi \leq \pi, 0 \leq \theta \leq 2\pi$$

$$\Rightarrow \mathbf{r}_\phi = (\sqrt{2} \cos \phi \cos \theta)\mathbf{i} + (\sqrt{2} \cos \phi \sin \theta)\mathbf{j} - (\sqrt{2} \sin \phi)\mathbf{k} \text{ and } \mathbf{r}_\theta = (-\sqrt{2} \sin \phi \sin \theta)\mathbf{i} + (\sqrt{2} \sin \phi \cos \theta)\mathbf{j}$$

$$\begin{aligned} \Rightarrow \mathbf{r}_\phi \times \mathbf{r}_\theta &= \begin{vmatrix} \mathbf{i} & \mathbf{j} & \mathbf{k} \\ \sqrt{2} \cos \phi \cos \theta & \sqrt{2} \cos \phi \sin \theta & -\sqrt{2} \sin \phi \\ -\sqrt{2} \sin \phi \sin \theta & \sqrt{2} \sin \phi \cos \theta & 0 \end{vmatrix} \\ &= (2 \sin^2 \phi \cos \theta)\mathbf{i} + (2 \sin^2 \phi \sin \theta)\mathbf{j} + (2 \sin \phi \cos \phi)\mathbf{k} \\ \Rightarrow |\mathbf{r}_\phi \times \mathbf{r}_\theta| &= \sqrt{4 \sin^4 \phi \cos^2 \theta + 4 \sin^4 \phi \sin^2 \theta + 4 \sin^2 \phi \cos^2 \phi} = \sqrt{4 \sin^2 \phi} = 2 |\sin \phi| = 2 \sin \phi \\ \Rightarrow A &= \int_0^{2\pi} \int_{\pi/4}^{\pi} 2 \sin \phi \, d\phi \, d\theta = \int_0^{2\pi} (2 + \sqrt{2}) \, d\theta = (4 + 2\sqrt{2})\pi \end{aligned}$$

26. Let $x = \rho \sin \phi \cos \theta, y = \rho \sin \phi \sin \theta$, and $z = \rho \cos \phi \Rightarrow \rho = \sqrt{x^2 + y^2 + z^2} = 2$ on the sphere. Next,

$$z = -1 \Rightarrow -1 = 2 \cos \phi \Rightarrow \cos \phi = -\frac{1}{2} \Rightarrow \phi = \frac{2\pi}{3}; z = \sqrt{3} \Rightarrow \sqrt{3} = 2 \cos \phi \Rightarrow \cos \phi = \frac{\sqrt{3}}{2} \Rightarrow \phi = \frac{\pi}{6}. \text{ Then}$$

$$\mathbf{r}(\phi, \theta) = (2 \sin \phi \cos \theta)\mathbf{i} + (2 \sin \phi \sin \theta)\mathbf{j} + (2 \cos \phi)\mathbf{k}, \frac{\pi}{6} \leq \phi \leq \frac{2\pi}{3}, 0 \leq \theta \leq 2\pi$$

$$\Rightarrow \mathbf{r}_\phi = (2 \cos \phi \cos \theta)\mathbf{i} + (2 \cos \phi \sin \theta)\mathbf{j} - (2 \sin \phi)\mathbf{k} \text{ and}$$

$$\mathbf{r}_\theta = (-2 \sin \phi \sin \theta)\mathbf{i} + (2 \sin \phi \cos \theta)\mathbf{j}$$

$$\Rightarrow \mathbf{r}_\phi \times \mathbf{r}_\theta = \begin{vmatrix} \mathbf{i} & \mathbf{j} & \mathbf{k} \\ 2 \cos \phi \cos \theta & 2 \cos \phi \sin \theta & -2 \sin \phi \\ -2 \sin \phi \sin \theta & 2 \sin \phi \cos \theta & 0 \end{vmatrix}$$

$$= (4 \sin^2 \phi \cos \theta)\mathbf{i} + (4 \sin^2 \phi \sin \theta)\mathbf{j} + (4 \sin \phi \cos \phi)\mathbf{k}$$

$$\Rightarrow |\mathbf{r}_\phi \times \mathbf{r}_\theta| = \sqrt{16 \sin^4 \phi \cos^2 \theta + 16 \sin^4 \phi \sin^2 \theta + 16 \sin^2 \phi \cos^2 \phi} = \sqrt{16 \sin^2 \phi} = 4 |\sin \phi| = 4 \sin \phi$$

$$\Rightarrow A = \int_0^{2\pi} \int_{\pi/6}^{2\pi/3} 4 \sin \phi \, d\phi \, d\theta = \int_0^{2\pi} (2 + 2\sqrt{3}) \, d\theta = (4 + 4\sqrt{3})\pi$$

27. Let the parametrization be $\mathbf{r}(x, z) = x\mathbf{i} + x^2\mathbf{j} + z\mathbf{k} \Rightarrow \mathbf{r}_x = \mathbf{i} + 2x\mathbf{j}$ and $\mathbf{r}_z = \mathbf{k} \Rightarrow \mathbf{r}_x \times \mathbf{r}_z = \begin{vmatrix} \mathbf{i} & \mathbf{j} & \mathbf{k} \\ 1 & 2x & 0 \\ 0 & 0 & 1 \end{vmatrix}$

$$= 2x\mathbf{i} + \mathbf{j} \Rightarrow |\mathbf{r}_x \times \mathbf{r}_z| = \sqrt{4x^2 + 1} \Rightarrow \iint_S G(x, y, z) \, d\sigma = \int_0^3 \int_0^2 x\sqrt{4x^2 + 1} \, dx \, dz = \int_0^3 \left[\frac{1}{12} (4x^2 + 1)^{3/2} \right]_0^2 dz$$

$$= \int_0^3 \frac{1}{12} (17\sqrt{17} - 1) \, dz = \frac{17\sqrt{17} - 1}{4}$$

28. Let the parametrization be $\mathbf{r}(x, y) = x\mathbf{i} + y\mathbf{j} + \sqrt{4 - y^2}\mathbf{k}, -2 \leq y \leq 2 \Rightarrow \mathbf{r}_x = \mathbf{i}$ and $\mathbf{r}_y = \mathbf{j} - \frac{y}{\sqrt{4 - y^2}}\mathbf{k}$

$$\Rightarrow \mathbf{r}_x \times \mathbf{r}_y = \begin{vmatrix} \mathbf{i} & \mathbf{j} & \mathbf{k} \\ 1 & 0 & 0 \\ 0 & 1 & -\frac{y}{\sqrt{4 - y^2}} \end{vmatrix} = \frac{y}{\sqrt{4 - y^2}}\mathbf{j} + \mathbf{k} \Rightarrow |\mathbf{r}_x \times \mathbf{r}_y| = \sqrt{\frac{y^2}{4 - y^2} + 1} = \frac{2}{\sqrt{4 - y^2}}$$

$$\Rightarrow \iint_S G(x, y, z) \, d\sigma = \int_1^4 \int_{-2}^2 \sqrt{4 - y^2} \left(\frac{2}{\sqrt{4 - y^2}} \right) \, dy \, dx = 24$$

29. Let the parametrization be $\mathbf{r}(\phi, \theta) = (\sin \phi \cos \theta)\mathbf{i} + (\sin \phi \sin \theta)\mathbf{j} + (\cos \phi)\mathbf{k}$ (spherical coordinates with $\rho = 1$ on the sphere), $0 \leq \phi \leq \pi, 0 \leq \theta \leq 2\pi \Rightarrow \mathbf{r}_\phi = (\cos \phi \cos \theta)\mathbf{i} + (\cos \phi \sin \theta)\mathbf{j} - (\sin \phi)\mathbf{k}$ and

$$\mathbf{r}_\theta = (-\sin \phi \sin \theta)\mathbf{i} + (\sin \phi \cos \theta)\mathbf{j} \Rightarrow \mathbf{r}_\phi \times \mathbf{r}_\theta = \begin{vmatrix} \mathbf{i} & \mathbf{j} & \mathbf{k} \\ \cos \phi \cos \theta & \cos \phi \sin \theta & -\sin \phi \\ -\sin \phi \sin \theta & \sin \phi \cos \theta & 0 \end{vmatrix}$$

$$= (\sin^2 \phi \cos \theta)\mathbf{i} + (\sin^2 \phi \sin \theta)\mathbf{j} + (\sin \phi \cos \phi)\mathbf{k} \Rightarrow |\mathbf{r}_\phi \times \mathbf{r}_\theta| = \sqrt{\sin^4 \phi \cos^2 \theta + \sin^4 \phi \sin^2 \theta + \sin^2 \phi \cos^2 \phi}$$

$$= \sin \phi; x = \sin \phi \cos \theta \Rightarrow G(x, y, z) = \cos^2 \theta \sin^2 \phi \Rightarrow \iint_S G(x, y, z) \, d\sigma = \int_0^{2\pi} \int_0^\pi (\cos^2 \theta \sin^2 \phi) (\sin \phi) \, d\phi \, d\theta$$

$$= \int_0^{2\pi} \int_0^\pi (\cos^2 \theta) (1 - \cos^2 \phi) (\sin \phi) \, d\phi \, d\theta; \left[\begin{array}{l} u = \cos \phi \\ du = -\sin \phi \, d\phi \end{array} \right] \rightarrow \int_0^{2\pi} \int_1^{-1} (\cos^2 \theta) (u^2 - 1) \, du \, d\theta$$

$$= \int_0^{2\pi} (\cos^2 \theta) \left[\frac{u^3}{3} - u \right]_1^{-1} \, d\theta = \frac{4}{3} \int_0^{2\pi} \cos^2 \theta \, d\theta = \frac{4}{3} \left[\frac{\theta}{2} + \frac{\sin 2\theta}{4} \right]_0^{2\pi} = \frac{4\pi}{3}$$

30. Let the parametrization be $\mathbf{r}(\phi, \theta) = (a \sin \phi \cos \theta)\mathbf{i} + (a \sin \phi \sin \theta)\mathbf{j} + (a \cos \phi)\mathbf{k}$ (spherical coordinates with $\rho = a, a \geq 0$, on the sphere), $0 \leq \phi \leq \frac{\pi}{2}$ (since $z \geq 0$), $0 \leq \theta \leq 2\pi$

$$\Rightarrow \mathbf{r}_\phi = (a \cos \phi \cos \theta)\mathbf{i} + (a \cos \phi \sin \theta)\mathbf{j} - (a \sin \phi)\mathbf{k} \text{ and}$$

$$\mathbf{r}_\theta = (-a \sin \phi \sin \theta)\mathbf{i} + (a \sin \phi \cos \theta)\mathbf{j} \Rightarrow \mathbf{r}_\phi \times \mathbf{r}_\theta = \begin{vmatrix} \mathbf{i} & \mathbf{j} & \mathbf{k} \\ a \cos \phi \cos \theta & a \cos \phi \sin \theta & -a \sin \phi \\ -a \sin \phi \sin \theta & a \sin \phi \cos \theta & 0 \end{vmatrix}$$

$$= (a^2 \sin^2 \phi \cos \theta)\mathbf{i} + (a^2 \sin^2 \phi \sin \theta)\mathbf{j} + (a^2 \sin \phi \cos \phi)\mathbf{k}$$

$$\Rightarrow |\mathbf{r}_\phi \times \mathbf{r}_\theta| = \sqrt{a^4 \sin^4 \phi \cos^2 \theta + a^4 \sin^4 \phi \sin^2 \theta + a^4 \sin^2 \phi \cos^2 \phi} = a^2 \sin \phi; z = a \cos \phi$$

$$\Rightarrow G(x, y, z) = a^2 \cos^2 \phi \Rightarrow \iint_S G(x, y, z) \, d\sigma = \int_0^{2\pi} \int_0^{\pi/2} (a^2 \cos^2 \phi) (a^2 \sin \phi) \, d\phi \, d\theta = \frac{2}{3} \pi a^4$$

31. Let the parametrization be $\mathbf{r}(x, y) = x\mathbf{i} + y\mathbf{j} + (4 - x - y)\mathbf{k} \Rightarrow \mathbf{r}_x = \mathbf{i} - \mathbf{k}$ and $\mathbf{r}_y = \mathbf{j} - \mathbf{k}$

$$\begin{aligned} \Rightarrow \mathbf{r}_x \times \mathbf{r}_y &= \begin{vmatrix} \mathbf{i} & \mathbf{j} & \mathbf{k} \\ 1 & 0 & -1 \\ 0 & 1 & -1 \end{vmatrix} = \mathbf{i} + \mathbf{j} + \mathbf{k} \Rightarrow |\mathbf{r}_x \times \mathbf{r}_y| = \sqrt{3} \Rightarrow \iint_S F(x, y, z) \, d\sigma = \int_0^1 \int_0^1 (4 - x - y) \sqrt{3} \, dy \, dx \\ &= \int_0^1 \sqrt{3} \left[4y - xy - \frac{y^2}{2} \right]_0^1 dx = \int_0^1 \sqrt{3} \left(\frac{7}{2} - x \right) dx = \sqrt{3} \left[\frac{7}{2}x - \frac{x^2}{2} \right]_0^1 = 3\sqrt{3} \end{aligned}$$

32. Let the parametrization be $\mathbf{r}(r, \theta) = (r \cos \theta)\mathbf{i} + (r \sin \theta)\mathbf{j} + r\mathbf{k}$, $0 \leq r \leq 1$ (since $0 \leq z \leq 1$) and $0 \leq \theta \leq 2\pi$

$$\begin{aligned} \Rightarrow \mathbf{r}_r &= (\cos \theta)\mathbf{i} + (\sin \theta)\mathbf{j} + \mathbf{k} \text{ and } \mathbf{r}_\theta = (-r \sin \theta)\mathbf{i} + (r \cos \theta)\mathbf{j} \Rightarrow \mathbf{r}_r \times \mathbf{r}_\theta = \begin{vmatrix} \mathbf{i} & \mathbf{j} & \mathbf{k} \\ \cos \theta & \sin \theta & 1 \\ -r \sin \theta & r \cos \theta & 0 \end{vmatrix} \\ &= (-r \cos \theta)\mathbf{i} - (r \sin \theta)\mathbf{j} + r\mathbf{k} \Rightarrow |\mathbf{r}_r \times \mathbf{r}_\theta| = \sqrt{(-r \cos \theta)^2 + (-r \sin \theta)^2 + r^2} = r\sqrt{2}; z = r \text{ and } x = r \cos \theta \\ \Rightarrow F(x, y, z) &= r - r \cos \theta \Rightarrow \iint_S F(x, y, z) \, d\sigma = \int_0^{2\pi} \int_0^1 (r - r \cos \theta) (r\sqrt{2}) \, dr \, d\theta = \sqrt{2} \int_0^{2\pi} \int_0^1 (1 - \cos \theta) r^2 \, dr \, d\theta \\ &= \frac{2\pi\sqrt{2}}{3} \end{aligned}$$

33. Let the parametrization be $\mathbf{r}(r, \theta) = (r \cos \theta)\mathbf{i} + (r \sin \theta)\mathbf{j} + (1 - r^2)\mathbf{k}$, $0 \leq r \leq 1$ (since $0 \leq z \leq 1$) and $0 \leq \theta \leq 2\pi$

$$\begin{aligned} \Rightarrow \mathbf{r}_r &= (\cos \theta)\mathbf{i} + (\sin \theta)\mathbf{j} - 2r\mathbf{k} \text{ and } \mathbf{r}_\theta = (-r \sin \theta)\mathbf{i} + (r \cos \theta)\mathbf{j} \Rightarrow \mathbf{r}_r \times \mathbf{r}_\theta = \begin{vmatrix} \mathbf{i} & \mathbf{j} & \mathbf{k} \\ \cos \theta & \sin \theta & -2r \\ -r \sin \theta & r \cos \theta & 0 \end{vmatrix} \\ &= (2r^2 \cos \theta)\mathbf{i} + (2r^2 \sin \theta)\mathbf{j} + r\mathbf{k} \Rightarrow |\mathbf{r}_r \times \mathbf{r}_\theta| = \sqrt{(2r^2 \cos \theta)^2 + (2r^2 \sin \theta)^2 + r^2} = r\sqrt{1 + 4r^2}; z = 1 - r^2 \text{ and } \\ x = r \cos \theta &\Rightarrow H(x, y, z) = (r^2 \cos^2 \theta) \sqrt{1 + 4r^2} \Rightarrow \iint_S H(x, y, z) \, d\sigma \\ &= \int_0^{2\pi} \int_0^1 (r^2 \cos^2 \theta) (\sqrt{1 + 4r^2}) (r\sqrt{1 + 4r^2}) \, dr \, d\theta = \int_0^{2\pi} \int_0^1 r^3 (1 + 4r^2) \cos^2 \theta \, dr \, d\theta = \frac{11\pi}{12} \end{aligned}$$

34. Let the parametrization be $\mathbf{r}(\phi, \theta) = (2 \sin \phi \cos \theta)\mathbf{i} + (2 \sin \phi \sin \theta)\mathbf{j} + (2 \cos \phi)\mathbf{k}$ (spherical coordinates with $\rho = 2$ on the sphere), $0 \leq \phi \leq \frac{\pi}{4}$; $x^2 + y^2 + z^2 = 4$ and $z = \sqrt{x^2 + y^2} \Rightarrow z^2 + z^2 = 4 \Rightarrow z^2 = 2 \Rightarrow z = \sqrt{2}$ (since $z \geq 0$) $\Rightarrow 2 \cos \phi = \sqrt{2} \Rightarrow \cos \phi = \frac{\sqrt{2}}{2} \Rightarrow \phi = \frac{\pi}{4}$, $0 \leq \theta \leq 2\pi$; $\mathbf{r}_\phi = (2 \cos \phi \cos \theta)\mathbf{i} + (2 \cos \phi \sin \theta)\mathbf{j} - (2 \sin \phi)\mathbf{k}$

$$\begin{aligned} \text{and } \mathbf{r}_\theta &= (-2 \sin \phi \sin \theta)\mathbf{i} + (2 \sin \phi \cos \theta)\mathbf{j} \Rightarrow \mathbf{r}_\phi \times \mathbf{r}_\theta = \begin{vmatrix} \mathbf{i} & \mathbf{j} & \mathbf{k} \\ 2 \cos \phi \cos \theta & 2 \cos \phi \sin \theta & -2 \sin \phi \\ -2 \sin \phi \sin \theta & 2 \sin \phi \cos \theta & 0 \end{vmatrix} \\ &= (4 \sin^2 \phi \cos \theta)\mathbf{i} + (4 \sin^2 \phi \sin \theta)\mathbf{j} + (4 \sin \phi \cos \phi)\mathbf{k} \\ \Rightarrow |\mathbf{r}_\phi \times \mathbf{r}_\theta| &= \sqrt{16 \sin^4 \phi \cos^2 \theta + 16 \sin^4 \phi \sin^2 \theta + 16 \sin^2 \phi \cos^2 \phi} = 4 \sin \phi; y = 2 \sin \phi \sin \theta \text{ and } \\ z = 2 \cos \phi &\Rightarrow H(x, y, z) = 4 \cos \phi \sin \phi \sin \theta \Rightarrow \iint_S H(x, y, z) \, d\sigma = \int_0^{2\pi} \int_0^{\pi/4} (4 \cos \phi \sin \phi \sin \theta)(4 \sin \phi) \, d\phi \, d\theta \\ &= \int_0^{2\pi} \int_0^{\pi/4} 16 \sin^2 \phi \cos \phi \sin \theta \, d\phi \, d\theta = 0 \end{aligned}$$

35. Let the parametrization be $\mathbf{r}(x, y) = x\mathbf{i} + y\mathbf{j} + (4 - y^2)\mathbf{k}$, $0 \leq x \leq 1$, $-2 \leq y \leq 2$; $z = 0 \Rightarrow 0 = 4 - y^2$

$$\begin{aligned} \Rightarrow y &= \pm 2; \mathbf{r}_x = \mathbf{i} \text{ and } \mathbf{r}_y = \mathbf{j} - 2y\mathbf{k} \Rightarrow \mathbf{r}_x \times \mathbf{r}_y = \begin{vmatrix} \mathbf{i} & \mathbf{j} & \mathbf{k} \\ 1 & 0 & 0 \\ 0 & 1 & -2y \end{vmatrix} = 2y\mathbf{j} + \mathbf{k} \Rightarrow \mathbf{F} \cdot \mathbf{n} \, d\sigma \\ &= \mathbf{F} \cdot \frac{\mathbf{r}_x \times \mathbf{r}_y}{|\mathbf{r}_x \times \mathbf{r}_y|} |\mathbf{r}_x \times \mathbf{r}_y| \, dy \, dx = (2xy - 3z) \, dy \, dx = [2xy - 3(4 - y^2)] \, dy \, dx \Rightarrow \iint_S \mathbf{F} \cdot \mathbf{n} \, d\sigma \\ &= \int_0^1 \int_{-2}^2 (2xy + 3y^2 - 12) \, dy \, dx = \int_0^1 [xy^2 + y^3 - 12y]_{-2}^2 \, dx = \int_0^1 -32 \, dx = -32 \end{aligned}$$

36. Let the parametrization be $\mathbf{r}(x, y) = x\mathbf{i} + x^2\mathbf{j} + z\mathbf{k}$, $-1 \leq x \leq 1$, $0 \leq z \leq 2 \Rightarrow \mathbf{r}_x = \mathbf{i} + 2x\mathbf{j}$ and $\mathbf{r}_z = \mathbf{k}$

$$\Rightarrow \mathbf{r}_x \times \mathbf{r}_z = \begin{vmatrix} \mathbf{i} & \mathbf{j} & \mathbf{k} \\ 1 & 2x & 0 \\ 0 & 0 & 1 \end{vmatrix} = 2x\mathbf{i} - \mathbf{j} \Rightarrow \mathbf{F} \cdot \mathbf{n} \, d\sigma = \mathbf{F} \cdot \frac{\mathbf{r}_x \times \mathbf{r}_z}{|\mathbf{r}_x \times \mathbf{r}_z|} |\mathbf{r}_x \times \mathbf{r}_z| \, dz \, dx = -x^2 \, dz \, dx$$

$$\Rightarrow \iint_S \mathbf{F} \cdot \mathbf{n} \, d\sigma = \int_{-1}^1 \int_0^2 -x^2 \, dz \, dx = -\frac{4}{3}$$

37. Let the parametrization be $\mathbf{r}(\phi, \theta) = (a \sin \phi \cos \theta)\mathbf{i} + (a \sin \phi \sin \theta)\mathbf{j} + (a \cos \phi)\mathbf{k}$ (spherical coordinates with $\rho = a$, $a \geq 0$, on the sphere), $0 \leq \phi \leq \frac{\pi}{2}$ (for the first octant), $0 \leq \theta \leq \frac{\pi}{2}$ (for the first octant)

$$\Rightarrow \mathbf{r}_\phi = (a \cos \phi \cos \theta)\mathbf{i} + (a \cos \phi \sin \theta)\mathbf{j} - (a \sin \phi)\mathbf{k} \text{ and } \mathbf{r}_\theta = (-a \sin \phi \sin \theta)\mathbf{i} + (a \sin \phi \cos \theta)\mathbf{j}$$

$$\Rightarrow \mathbf{r}_\phi \times \mathbf{r}_\theta = \begin{vmatrix} \mathbf{i} & \mathbf{j} & \mathbf{k} \\ a \cos \phi \cos \theta & a \cos \phi \sin \theta & -a \sin \phi \\ -a \sin \phi \sin \theta & a \sin \phi \cos \theta & 0 \end{vmatrix}$$

$$= (a^2 \sin^2 \phi \cos \theta)\mathbf{i} + (a^2 \sin^2 \phi \sin \theta)\mathbf{j} + (a^2 \sin \phi \cos \phi)\mathbf{k} \Rightarrow \mathbf{F} \cdot \mathbf{n} \, d\sigma = \mathbf{F} \cdot \frac{\mathbf{r}_\phi \times \mathbf{r}_\theta}{|\mathbf{r}_\phi \times \mathbf{r}_\theta|} |\mathbf{r}_\phi \times \mathbf{r}_\theta| \, d\theta \, d\phi$$

$$= a^3 \cos^2 \phi \sin \phi \, d\theta \, d\phi \text{ since } \mathbf{F} = z\mathbf{k} = (a \cos \phi)\mathbf{k} \Rightarrow \iint_S \mathbf{F} \cdot \mathbf{n} \, d\sigma = \int_0^{\pi/2} \int_0^{\pi/2} a^3 \cos^2 \phi \sin \phi \, d\phi \, d\theta = \frac{\pi a^3}{6}$$

38. Let the parametrization be $\mathbf{r}(\phi, \theta) = (a \sin \phi \cos \theta)\mathbf{i} + (a \sin \phi \sin \theta)\mathbf{j} + (a \cos \phi)\mathbf{k}$ (spherical coordinates with $\rho = a$, $a \geq 0$, on the sphere), $0 \leq \phi \leq \pi$, $0 \leq \theta \leq 2\pi$

$$\Rightarrow \mathbf{r}_\phi = (a \cos \phi \cos \theta)\mathbf{i} + (a \cos \phi \sin \theta)\mathbf{j} - (a \sin \phi)\mathbf{k} \text{ and } \mathbf{r}_\theta = (-a \sin \phi \sin \theta)\mathbf{i} + (a \sin \phi \cos \theta)\mathbf{j}$$

$$\Rightarrow \mathbf{r}_\phi \times \mathbf{r}_\theta = \begin{vmatrix} \mathbf{i} & \mathbf{j} & \mathbf{k} \\ a \cos \phi \cos \theta & a \cos \phi \sin \theta & -a \sin \phi \\ -a \sin \phi \sin \theta & a \sin \phi \cos \theta & 0 \end{vmatrix}$$

$$= (a^2 \sin^2 \phi \cos \theta)\mathbf{i} + (a^2 \sin^2 \phi \sin \theta)\mathbf{j} + (a^2 \sin \phi \cos \phi)\mathbf{k} \Rightarrow \mathbf{F} \cdot \mathbf{n} \, d\sigma = \mathbf{F} \cdot \frac{\mathbf{r}_\phi \times \mathbf{r}_\theta}{|\mathbf{r}_\phi \times \mathbf{r}_\theta|} |\mathbf{r}_\phi \times \mathbf{r}_\theta| \, d\theta \, d\phi$$

$$= (a^3 \sin^3 \phi \cos^2 \phi + a^3 \sin^3 \phi \sin^2 \theta + a^3 \sin \phi \cos^2 \phi) \, d\theta \, d\phi = a^3 \sin \phi \, d\theta \, d\phi \text{ since } \mathbf{F} = x\mathbf{i} + y\mathbf{j} + z\mathbf{k}$$

$$= (a \sin \phi \cos \theta)\mathbf{i} + (a \sin \phi \sin \theta)\mathbf{j} + (a \cos \phi)\mathbf{k} \Rightarrow \iint_S \mathbf{F} \cdot \mathbf{n} \, d\sigma = \int_0^{2\pi} \int_0^\pi a^3 \sin \phi \, d\phi \, d\theta = 4\pi a^3$$

39. Let the parametrization be $\mathbf{r}(x, y) = x\mathbf{i} + y\mathbf{j} + (2a - x - y)\mathbf{k}$, $0 \leq x \leq a$, $0 \leq y \leq a \Rightarrow \mathbf{r}_x = \mathbf{i} - \mathbf{k}$ and $\mathbf{r}_y = \mathbf{j} - \mathbf{k}$

$$\Rightarrow \mathbf{r}_x \times \mathbf{r}_y = \begin{vmatrix} \mathbf{i} & \mathbf{j} & \mathbf{k} \\ 1 & 0 & -1 \\ 0 & 1 & -1 \end{vmatrix} = \mathbf{i} + \mathbf{j} + \mathbf{k} \Rightarrow \mathbf{F} \cdot \mathbf{n} \, d\sigma = \mathbf{F} \cdot \frac{\mathbf{r}_x \times \mathbf{r}_y}{|\mathbf{r}_x \times \mathbf{r}_y|} |\mathbf{r}_x \times \mathbf{r}_y| \, dy \, dx$$

$$= [2xy + 2y(2a - x - y) + 2x(2a - x - y)] \, dy \, dx \text{ since } \mathbf{F} = 2xy\mathbf{i} + 2yz\mathbf{j} + 2xz\mathbf{k}$$

$$= 2xy\mathbf{i} + 2y(2a - x - y)\mathbf{j} + 2x(2a - x - y)\mathbf{k} \Rightarrow \iint_S \mathbf{F} \cdot \mathbf{n} \, d\sigma$$

$$= \int_0^a \int_0^a [2xy + 2y(2a - x - y) + 2x(2a - x - y)] \, dy \, dx = \int_0^a \int_0^a (4ay - 2y^2 + 4ax - 2x^2 - 2xy) \, dy \, dx$$

$$= \int_0^a \left(\frac{4}{3} a^3 + 3a^2 x - 2ax^2 \right) \, dx = \left(\frac{4}{3} + \frac{3}{2} - \frac{2}{3} \right) a^4 = \frac{13a^4}{6}$$

40. Let the parametrization be $\mathbf{r}(\theta, z) = (\cos \theta)\mathbf{i} + (\sin \theta)\mathbf{j} + z\mathbf{k}$, $0 \leq z \leq a$, $0 \leq \theta \leq 2\pi$ (where $r = \sqrt{x^2 + y^2} = 1$ on

the cylinder) $\Rightarrow \mathbf{r}_\theta = (-\sin \theta)\mathbf{i} + (\cos \theta)\mathbf{j}$ and $\mathbf{r}_z = \mathbf{k} \Rightarrow \mathbf{r}_\theta \times \mathbf{r}_z = \begin{vmatrix} \mathbf{i} & \mathbf{j} & \mathbf{k} \\ -\sin \theta & \cos \theta & 0 \\ 0 & 0 & 1 \end{vmatrix} = (\cos \theta)\mathbf{i} + (\sin \theta)\mathbf{j}$

$$\Rightarrow \mathbf{F} \cdot \mathbf{n} \, d\sigma = \mathbf{F} \cdot \frac{\mathbf{r}_\theta \times \mathbf{r}_z}{|\mathbf{r}_\theta \times \mathbf{r}_z|} |\mathbf{r}_\theta \times \mathbf{r}_z| \, dz \, d\theta = (\cos^2 \theta + \sin^2 \theta) \, dz \, d\theta = dz \, d\theta, \text{ since } \mathbf{F} = (\cos \theta)\mathbf{i} + (\sin \theta)\mathbf{j} + z\mathbf{k}$$

$$\Rightarrow \iint_S \mathbf{F} \cdot \mathbf{n} \, d\sigma = \int_0^{2\pi} \int_0^a 1 \, dz \, d\theta = 2\pi a$$

41. Let the parametrization be $\mathbf{r}(r, \theta) = (r \cos \theta)\mathbf{i} + (r \sin \theta)\mathbf{j} + r\mathbf{k}$, $0 \leq r \leq 1$ (since $0 \leq z \leq 1$) and $0 \leq \theta \leq 2\pi$

$$\Rightarrow \mathbf{r}_r = (\cos \theta)\mathbf{i} + (\sin \theta)\mathbf{j} + \mathbf{k} \text{ and } \mathbf{r}_\theta = (-r \sin \theta)\mathbf{i} + (r \cos \theta)\mathbf{j} \Rightarrow \mathbf{r}_\theta \times \mathbf{r}_r = \begin{vmatrix} \mathbf{i} & \mathbf{j} & \mathbf{k} \\ -r \sin \theta & r \cos \theta & 0 \\ \cos \theta & \sin \theta & 1 \end{vmatrix}$$

$$= (r \cos \theta)\mathbf{i} + (r \sin \theta)\mathbf{j} - r\mathbf{k} \Rightarrow \mathbf{F} \cdot \mathbf{n} \, d\sigma = \mathbf{F} \cdot \frac{\mathbf{r}_\theta \times \mathbf{r}_r}{|\mathbf{r}_\theta \times \mathbf{r}_r|} |\mathbf{r}_\theta \times \mathbf{r}_r| \, d\theta \, dr = (r^3 \sin \theta \cos^2 \theta + r^2) \, d\theta \, dr \text{ since}$$

$$\mathbf{F} = (r^2 \sin \theta \cos \theta)\mathbf{i} - r\mathbf{k} \Rightarrow \iint_S \mathbf{F} \cdot \mathbf{n} \, d\sigma = \int_0^{2\pi} \int_0^1 (r^3 \sin \theta \cos^2 \theta + r^2) \, dr \, d\theta = \int_0^{2\pi} \left(\frac{1}{4} \sin \theta \cos^2 \theta + \frac{1}{3}\right) \, d\theta$$

$$= \left[-\frac{1}{12} \cos^3 \theta + \frac{\theta}{3}\right]_0^{2\pi} = \frac{2\pi}{3}$$

42. Let the parametrization be $\mathbf{r}(r, \theta) = (r \cos \theta)\mathbf{i} + (r \sin \theta)\mathbf{j} + 2r\mathbf{k}$, $0 \leq r \leq 1$ (since $0 \leq z \leq 2$) and $0 \leq \theta \leq 2\pi$

$$\Rightarrow \mathbf{r}_r = (\cos \theta)\mathbf{i} + (\sin \theta)\mathbf{j} + 2\mathbf{k} \text{ and } \mathbf{r}_\theta = (-r \sin \theta)\mathbf{i} + (r \cos \theta)\mathbf{j} \Rightarrow \mathbf{r}_\theta \times \mathbf{r}_r = \begin{vmatrix} \mathbf{i} & \mathbf{j} & \mathbf{k} \\ -r \sin \theta & r \cos \theta & 0 \\ \cos \theta & \sin \theta & 2 \end{vmatrix}$$

$$= (2r \cos \theta)\mathbf{i} + (2r \sin \theta)\mathbf{j} - r\mathbf{k} \Rightarrow \mathbf{F} \cdot \mathbf{n} \, d\sigma = \mathbf{F} \cdot \frac{\mathbf{r}_\theta \times \mathbf{r}_r}{|\mathbf{r}_\theta \times \mathbf{r}_r|} |\mathbf{r}_\theta \times \mathbf{r}_r| \, d\theta \, dr$$

$$= (2r^3 \sin^2 \theta \cos \theta + 4r^3 \cos \theta \sin \theta + r) \, d\theta \, dr \text{ since}$$

$$\mathbf{F} = (r^2 \sin^2 \theta)\mathbf{i} + (2r^2 \cos \theta)\mathbf{j} - \mathbf{k} \Rightarrow \iint_S \mathbf{F} \cdot \mathbf{n} \, d\sigma = \int_0^{2\pi} \int_0^1 (2r^3 \sin^2 \theta \cos \theta + 4r^3 \cos \theta \sin \theta + r) \, dr \, d\theta$$

$$= \int_0^{2\pi} \left(\frac{1}{2} \sin^2 \theta \cos \theta + \cos \theta \sin \theta + \frac{1}{2}\right) \, d\theta = \left[\frac{1}{6} \sin^3 \theta + \frac{1}{2} \sin^2 \theta + \frac{1}{2} \theta\right]_0^{2\pi} = \pi$$

43. Let the parametrization be $\mathbf{r}(r, \theta) = (r \cos \theta)\mathbf{i} + (r \sin \theta)\mathbf{j} + r\mathbf{k}$, $1 \leq r \leq 2$ (since $1 \leq z \leq 2$) and $0 \leq \theta \leq 2\pi$

$$\Rightarrow \mathbf{r}_r = (\cos \theta)\mathbf{i} + (\sin \theta)\mathbf{j} + \mathbf{k} \text{ and } \mathbf{r}_\theta = (-r \sin \theta)\mathbf{i} + (r \cos \theta)\mathbf{j} \Rightarrow \mathbf{r}_\theta \times \mathbf{r}_r = \begin{vmatrix} \mathbf{i} & \mathbf{j} & \mathbf{k} \\ -r \sin \theta & r \cos \theta & 0 \\ \cos \theta & \sin \theta & 1 \end{vmatrix}$$

$$= (r \cos \theta)\mathbf{i} + (r \sin \theta)\mathbf{j} - r\mathbf{k} \Rightarrow \mathbf{F} \cdot \mathbf{n} \, d\sigma = \mathbf{F} \cdot \frac{\mathbf{r}_\theta \times \mathbf{r}_r}{|\mathbf{r}_\theta \times \mathbf{r}_r|} |\mathbf{r}_\theta \times \mathbf{r}_r| \, d\theta \, dr = (-r^2 \cos^2 \theta - r^2 \sin^2 \theta - r^3) \, d\theta \, dr$$

$$= (-r^2 - r^3) \, d\theta \, dr \text{ since } \mathbf{F} = (-r \cos \theta)\mathbf{i} - (r \sin \theta)\mathbf{j} + r^2\mathbf{k} \Rightarrow \iint_S \mathbf{F} \cdot \mathbf{n} \, d\sigma = \int_0^{2\pi} \int_1^2 (-r^2 - r^3) \, dr \, d\theta = -\frac{73\pi}{6}$$

44. Let the parametrization be $\mathbf{r}(r, \theta) = (r \cos \theta)\mathbf{i} + (r \sin \theta)\mathbf{j} + r^2\mathbf{k}$, $0 \leq r \leq 1$ (since $0 \leq z \leq 1$) and $0 \leq \theta \leq 2\pi$

$$\Rightarrow \mathbf{r}_r = (\cos \theta)\mathbf{i} + (\sin \theta)\mathbf{j} + 2r\mathbf{k} \text{ and } \mathbf{r}_\theta = (-r \sin \theta)\mathbf{i} + (r \cos \theta)\mathbf{j} \Rightarrow \mathbf{r}_\theta \times \mathbf{r}_r = \begin{vmatrix} \mathbf{i} & \mathbf{j} & \mathbf{k} \\ -r \sin \theta & r \cos \theta & 0 \\ \cos \theta & \sin \theta & 2r \end{vmatrix}$$

$$= (2r^2 \cos \theta)\mathbf{i} + (2r^2 \sin \theta)\mathbf{j} - r\mathbf{k} \Rightarrow \mathbf{F} \cdot \mathbf{n} \, d\sigma = \mathbf{F} \cdot \frac{\mathbf{r}_\theta \times \mathbf{r}_r}{|\mathbf{r}_\theta \times \mathbf{r}_r|} |\mathbf{r}_\theta \times \mathbf{r}_r| \, d\theta \, dr = (8r^3 \cos^2 \theta + 8r^3 \sin^2 \theta - 2r) \, d\theta \, dr$$

$$= (8r^3 - 2r) \, d\theta \, dr \text{ since } \mathbf{F} = (4r \cos \theta)\mathbf{i} + (4r \sin \theta)\mathbf{j} + 2\mathbf{k} \Rightarrow \iint_S \mathbf{F} \cdot \mathbf{n} \, d\sigma = \int_0^{2\pi} \int_0^1 (8r^3 - 2r) \, dr \, d\theta = 2\pi$$

45. Let the parametrization be $\mathbf{r}(\phi, \theta) = (a \sin \phi \cos \theta)\mathbf{i} + (a \sin \phi \sin \theta)\mathbf{j} + (a \cos \phi)\mathbf{k}$, $0 \leq \phi \leq \frac{\pi}{2}$, $0 \leq \theta \leq \frac{\pi}{2}$

$$\Rightarrow \mathbf{r}_\phi = (a \cos \phi \cos \theta)\mathbf{i} + (a \cos \phi \sin \theta)\mathbf{j} - (a \sin \phi)\mathbf{k} \text{ and } \mathbf{r}_\theta = (-a \sin \phi \sin \theta)\mathbf{i} + (a \sin \phi \cos \theta)\mathbf{j}$$

$$\Rightarrow \mathbf{r}_\phi \times \mathbf{r}_\theta = \begin{vmatrix} \mathbf{i} & \mathbf{j} & \mathbf{k} \\ a \cos \phi \cos \theta & a \cos \phi \sin \theta & -a \sin \phi \\ -a \sin \phi \sin \theta & a \sin \phi \cos \theta & 0 \end{vmatrix}$$

$$= (a^2 \sin^2 \phi \cos \theta)\mathbf{i} + (a^2 \sin^2 \phi \sin \theta)\mathbf{j} + (a^2 \sin \phi \cos \phi)\mathbf{k}$$

$$\Rightarrow |\mathbf{r}_\phi \times \mathbf{r}_\theta| = \sqrt{a^4 \sin^4 \phi \cos^2 \theta + a^4 \sin^4 \phi \sin^2 \theta + a^4 \sin^2 \phi \cos^2 \phi} = \sqrt{a^4 \sin^2 \phi} = a^2 \sin \phi. \text{ The mass is}$$

$$M = \iint_S d\sigma = \int_0^{\pi/2} \int_0^{\pi/2} (a^2 \sin \phi) \, d\phi \, d\theta = \frac{a^2\pi}{2}; \text{ the first moment is } M_{yz} = \iint_S x \, d\sigma$$

$$= \int_0^{\pi/2} \int_0^{\pi/2} (a \sin \phi \cos \theta) (a^2 \sin \phi) \, d\phi \, d\theta = \frac{a^3\pi}{4} \Rightarrow \bar{x} = \frac{\left(\frac{a^3\pi}{4}\right)}{\left(\frac{a^2\pi}{2}\right)} = \frac{a}{2} \Rightarrow \text{the centroid is located at } \left(\frac{a}{2}, \frac{a}{2}, \frac{a}{2}\right) \text{ by}$$

symmetry

46. Let the parametrization be $\mathbf{r}(r, \theta) = (r \cos \theta)\mathbf{i} + (r \sin \theta)\mathbf{j} + r\mathbf{k}$, $1 \leq r \leq 2$ (since $1 \leq z \leq 2$) and $0 \leq \theta \leq 2\pi$

$$\Rightarrow \mathbf{r}_r = (\cos \theta)\mathbf{i} + (\sin \theta)\mathbf{j} + \mathbf{k} \text{ and } \mathbf{r}_\theta = (-r \sin \theta)\mathbf{i} + (r \cos \theta)\mathbf{j} \Rightarrow \mathbf{r}_\theta \times \mathbf{r}_r = \begin{vmatrix} \mathbf{i} & \mathbf{j} & \mathbf{k} \\ -r \sin \theta & r \cos \theta & 0 \\ \cos \theta & \sin \theta & 1 \end{vmatrix}$$

$$= (r \cos \theta)\mathbf{i} + (r \sin \theta)\mathbf{j} - r\mathbf{k} \Rightarrow |\mathbf{r}_\theta \times \mathbf{r}_r| = \sqrt{r^2 \cos^2 \theta + r^2 \sin^2 \theta + r^2} = r\sqrt{2}. \text{ The mass is}$$

$$M = \iint_S \delta \, d\sigma = \int_0^{2\pi} \int_1^2 \delta r\sqrt{2} \, dr \, d\theta = (3\sqrt{2})\pi\delta; \text{ the first moment is } M_{xy} = \iint_S \delta z \, d\sigma = \int_0^{2\pi} \int_1^2 \delta r(r\sqrt{2}) \, dr \, d\theta$$

$$= \frac{(14\sqrt{2})\pi\delta}{3} \Rightarrow \bar{z} = \frac{\left(\frac{(14\sqrt{2})\pi\delta}{3}\right)}{(3\sqrt{2})\pi\delta} = \frac{14}{9} \Rightarrow \text{the center of mass is located at } (0, 0, \frac{14}{9}) \text{ by symmetry. The}$$

$$\text{moment of inertia is } I_z = \iint_S \delta (x^2 + y^2) \, d\sigma = \int_0^{2\pi} \int_1^2 \delta r^2 (r\sqrt{2}) \, dr \, d\theta = \frac{(15\sqrt{2})\pi\delta}{2} \Rightarrow \text{the radius of gyration is}$$

$$R_z = \sqrt{\frac{I_z}{M}} = \sqrt{\frac{5}{2}}$$

47. Let the parametrization be $\mathbf{r}(\phi, \theta) = (a \sin \phi \cos \theta)\mathbf{i} + (a \sin \phi \sin \theta)\mathbf{j} + (a \cos \phi)\mathbf{k}$, $0 \leq \phi \leq \pi$, $0 \leq \theta \leq 2\pi$

$$\Rightarrow \mathbf{r}_\phi = (a \cos \phi \cos \theta)\mathbf{i} + (a \cos \phi \sin \theta)\mathbf{j} - (a \sin \phi)\mathbf{k} \text{ and } \mathbf{r}_\theta = (-a \sin \phi \sin \theta)\mathbf{i} + (a \sin \phi \cos \theta)\mathbf{j}$$

$$\Rightarrow \mathbf{r}_\phi \times \mathbf{r}_\theta = \begin{vmatrix} \mathbf{i} & \mathbf{j} & \mathbf{k} \\ a \cos \phi \cos \theta & a \cos \phi \sin \theta & -a \sin \phi \\ -a \sin \phi \sin \theta & a \sin \phi \cos \theta & 0 \end{vmatrix}$$

$$= (a^2 \sin^2 \phi \cos \theta)\mathbf{i} + (a^2 \sin^2 \phi \sin \theta)\mathbf{j} + (a^2 \sin \phi \cos \phi)\mathbf{k}$$

$$\Rightarrow |\mathbf{r}_\phi \times \mathbf{r}_\theta| = \sqrt{a^4 \sin^4 \phi \cos^2 \theta + a^4 \sin^4 \phi \sin^2 \theta + a^4 \sin^2 \phi \cos^2 \phi} = \sqrt{a^4 \sin^2 \phi} = a^2 \sin \phi. \text{ The moment of}$$

$$\text{inertia is } I_z = \iint_S \delta (x^2 + y^2) \, d\sigma = \int_0^{2\pi} \int_0^\pi \delta [(a \sin \phi \cos \theta)^2 + (a \sin \phi \sin \theta)^2] (a^2 \sin \phi) \, d\phi \, d\theta$$

$$= \int_0^{2\pi} \int_0^\pi \delta (a^2 \sin^2 \phi) (a^2 \sin \phi) \, d\phi \, d\theta = \int_0^{2\pi} \int_0^\pi \delta a^4 \sin^3 \phi \, d\phi \, d\theta = \int_0^{2\pi} \delta a^4 \left[-\frac{1}{3} \cos \phi (\sin^2 \phi + 2) \right]_0^\pi \, d\theta = \frac{8\delta\pi a^4}{3}$$

48. Let the parametrization be $\mathbf{r}(r, \theta) = (r \cos \theta)\mathbf{i} + (r \sin \theta)\mathbf{j} + r\mathbf{k}$, $0 \leq r \leq 1$ (since $0 \leq z \leq 1$) and $0 \leq \theta \leq 2\pi$

$$\Rightarrow \mathbf{r}_r = (\cos \theta)\mathbf{i} + (\sin \theta)\mathbf{j} + \mathbf{k} \text{ and } \mathbf{r}_\theta = (-r \sin \theta)\mathbf{i} + (r \cos \theta)\mathbf{j} \Rightarrow \mathbf{r}_\theta \times \mathbf{r}_r = \begin{vmatrix} \mathbf{i} & \mathbf{j} & \mathbf{k} \\ -r \sin \theta & r \cos \theta & 0 \\ \cos \theta & \sin \theta & 1 \end{vmatrix}$$

$$= (r \cos \theta)\mathbf{i} + (r \sin \theta)\mathbf{j} - r\mathbf{k} \Rightarrow |\mathbf{r}_\theta \times \mathbf{r}_r| = \sqrt{r^2 \cos^2 \theta + r^2 \sin^2 \theta + r^2} = r\sqrt{2}. \text{ The moment of inertia is}$$

$$I_z = \iint_S \delta (x^2 + y^2) \, d\sigma = \int_0^{2\pi} \int_0^1 \delta r^2 (r\sqrt{2}) \, dr \, d\theta = \frac{\pi\delta\sqrt{2}}{2}$$

49. The parametrization $\mathbf{r}(r, \theta) = (r \cos \theta)\mathbf{i} + (r \sin \theta)\mathbf{j} + r\mathbf{k}$

$$\text{at } P_0 = (\sqrt{2}, \sqrt{2}, 2) \Rightarrow \theta = \frac{\pi}{4}, r = 2,$$

$$\mathbf{r}_r = (\cos \theta)\mathbf{i} + (\sin \theta)\mathbf{j} + \mathbf{k} = \frac{\sqrt{2}}{2}\mathbf{i} + \frac{\sqrt{2}}{2}\mathbf{j} + \mathbf{k} \text{ and}$$

$$\mathbf{r}_\theta = (-r \sin \theta)\mathbf{i} + (r \cos \theta)\mathbf{j} = -\sqrt{2}\mathbf{i} + \sqrt{2}\mathbf{j}$$

$$\Rightarrow \mathbf{r}_r \times \mathbf{r}_\theta = \begin{vmatrix} \mathbf{i} & \mathbf{j} & \mathbf{k} \\ \sqrt{2}/2 & \sqrt{2}/2 & 1 \\ -\sqrt{2} & \sqrt{2} & 0 \end{vmatrix}$$

$$= -\sqrt{2}\mathbf{i} - \sqrt{2}\mathbf{j} + 2\mathbf{k} \Rightarrow \text{the tangent plane is}$$

$$0 = (-\sqrt{2}\mathbf{i} - \sqrt{2}\mathbf{j} + 2\mathbf{k}) \cdot [(x - \sqrt{2})\mathbf{i} + (y - \sqrt{2})\mathbf{j} + (z - 2)\mathbf{k}] \Rightarrow \sqrt{2}x + \sqrt{2}y - 2z = 0, \text{ or } x + y - \sqrt{2}z = 0.$$

$$\text{The parametrization } \mathbf{r}(r, \theta) \Rightarrow x = r \cos \theta, y = r \sin \theta \text{ and } z = r \Rightarrow x^2 + y^2 = r^2 = z^2 \Rightarrow \text{the surface is } z = \sqrt{x^2 + y^2}.$$

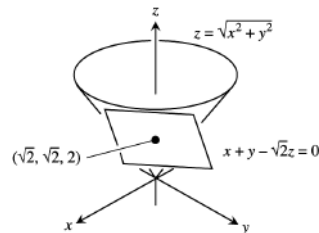

50. The parametrization $\mathbf{r}(\phi, \theta)$

$$= (4 \sin \phi \cos \theta)\mathbf{i} + (4 \sin \phi \sin \theta)\mathbf{j} + (4 \cos \phi)\mathbf{k}$$

$$\text{at } P_0 = (\sqrt{2}, \sqrt{2}, 2\sqrt{3}) \Rightarrow \rho = 4 \text{ and } z = 2\sqrt{3}$$

$$= 4 \cos \phi \Rightarrow \phi = \frac{\pi}{6}; \text{ also } x = \sqrt{2} \text{ and } y = \sqrt{2}$$

$$\Rightarrow \theta = \frac{\pi}{4}. \text{ Then } \mathbf{r}_\phi$$

$$= (4 \cos \phi \cos \theta)\mathbf{i} + (4 \cos \phi \sin \theta)\mathbf{j} - (4 \sin \phi)\mathbf{k}$$

$$= \sqrt{6}\mathbf{i} + \sqrt{6}\mathbf{j} - 2\mathbf{k} \text{ and}$$

$$\mathbf{r}_\theta = (-4 \sin \phi \sin \theta)\mathbf{i} + (4 \sin \phi \cos \theta)\mathbf{j}$$

$$= -\sqrt{2}\mathbf{i} + \sqrt{2}\mathbf{j} \text{ at } P_0 \Rightarrow \mathbf{r}_\phi \times \mathbf{r}_\theta = \begin{vmatrix} \mathbf{i} & \mathbf{j} & \mathbf{k} \\ \sqrt{6} & \sqrt{6} & -2 \\ -\sqrt{2} & \sqrt{2} & 0 \end{vmatrix}$$

$$= 2\sqrt{2}\mathbf{i} + 2\sqrt{2}\mathbf{j} + 4\sqrt{3}\mathbf{k} \Rightarrow \text{the tangent plane is}$$

$$(2\sqrt{2}\mathbf{i} + 2\sqrt{2}\mathbf{j} + 4\sqrt{3}\mathbf{k}) \cdot [(x - \sqrt{2})\mathbf{i} + (y - \sqrt{2})\mathbf{j} + (z - 2\sqrt{3})\mathbf{k}] = 0 \Rightarrow \sqrt{2}x + \sqrt{2}y + 2\sqrt{3}z = 16,$$

$$\text{or } x + y + \sqrt{6}z = 8\sqrt{2}. \text{ The parametrization } \Rightarrow x = 4 \sin \phi \cos \theta, y = 4 \sin \phi \sin \theta, z = 4 \cos \phi$$

$$\Rightarrow \text{the surface is } x^2 + y^2 + z^2 = 16, z \geq 0.$$

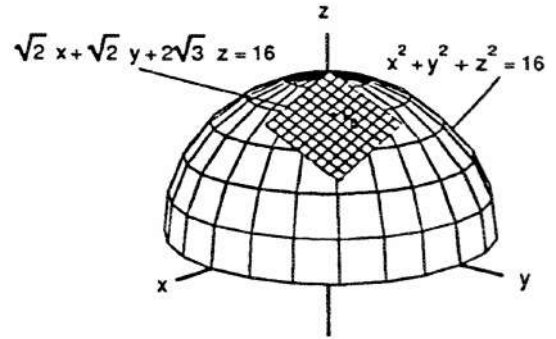
 51. The parametrization $\mathbf{r}(\theta, z) = (3 \sin 2\theta)\mathbf{i} + (6 \sin^2 \theta)\mathbf{j} + z\mathbf{k}$

$$\text{at } P_0 = \left(\frac{3\sqrt{3}}{2}, \frac{9}{2}, 0\right) \Rightarrow \theta = \frac{\pi}{3} \text{ and } z = 0. \text{ Then}$$

$$\mathbf{r}_\theta = (6 \cos 2\theta)\mathbf{i} + (12 \sin \theta \cos \theta)\mathbf{j}$$

$$= -3\mathbf{i} + 3\sqrt{3}\mathbf{j} \text{ and } \mathbf{r}_z = \mathbf{k} \text{ at } P_0$$

$$\Rightarrow \mathbf{r}_\theta \times \mathbf{r}_z = \begin{vmatrix} \mathbf{i} & \mathbf{j} & \mathbf{k} \\ -3 & 3\sqrt{3} & 0 \\ 0 & 0 & 1 \end{vmatrix} = 3\sqrt{3}\mathbf{i} + 3\mathbf{j}$$

$$\Rightarrow \text{the tangent plane is}$$

$$(3\sqrt{3}\mathbf{i} + 3\mathbf{j}) \cdot \left[\left(x - \frac{3\sqrt{3}}{2}\right)\mathbf{i} + \left(y - \frac{9}{2}\right)\mathbf{j} + (z - 0)\mathbf{k}\right] = 0$$

$$\Rightarrow \sqrt{3}x + y = 9. \text{ The parametrization } \Rightarrow x = 3 \sin 2\theta$$

$$\text{and } y = 6 \sin^2 \theta \Rightarrow x^2 + y^2 = 9 \sin^2 2\theta + (6 \sin^2 \theta)^2$$

$$= 9(4 \sin^2 \theta \cos^2 \theta) + 36 \sin^4 \theta = 6(6 \sin^2 \theta) = 6y \Rightarrow x^2 + y^2 - 6y + 9 = 9 \Rightarrow x^2 + (y - 3)^2 = 9$$

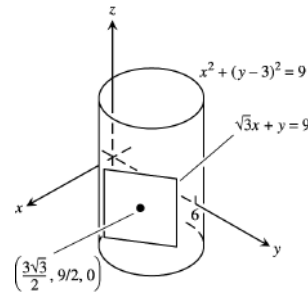
 52. The parametrization $\mathbf{r}(x, y) = x\mathbf{i} + y\mathbf{j} - x^2\mathbf{k}$

$$P_0 = (1, 2, -1) \Rightarrow \mathbf{r}_x = \mathbf{i} - 2x\mathbf{k} = \mathbf{i} - 2\mathbf{k} \text{ and } \mathbf{r}_y = \mathbf{j} \text{ at } P_0$$

$$\Rightarrow \mathbf{r}_x \times \mathbf{r}_y = \begin{vmatrix} \mathbf{i} & \mathbf{j} & \mathbf{k} \\ 1 & 0 & -2 \\ 0 & 1 & 0 \end{vmatrix} = 2\mathbf{i} + \mathbf{k} \Rightarrow \text{the tangent plane}$$

$$\text{is } (2\mathbf{i} + \mathbf{k}) \cdot [(x - 1)\mathbf{i} + (y - 2)\mathbf{j} + (z + 1)\mathbf{k}] = 0$$

$$\Rightarrow 2x + z = 1. \text{ The parametrization } \Rightarrow x = x, y = y \text{ and}$$

$$z = -x^2 \Rightarrow \text{the surface is } z = -x^2$$

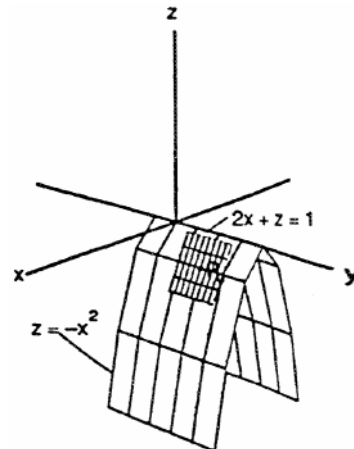
 53. (a) An arbitrary point on the circle C is $(R + r \cos u, r \sin u) \Rightarrow (x, y, z)$ is on the torus with $x = (R + r \cos u) \cos v$, $y = (R + r \cos u) \sin v$, and $z = r \sin u$, $0 \leq u \leq 2\pi$, $0 \leq v \leq 2\pi$

$$\begin{aligned}
\text{(b) } \mathbf{r}_u &= (-r \sin u \cos v)\mathbf{i} - (r \sin u \sin v)\mathbf{j} + (r \cos u)\mathbf{k} \text{ and } \mathbf{r}_v = (-(R + r \cos u) \sin v)\mathbf{i} + ((R + r \cos u) \cos v)\mathbf{j} \\
\Rightarrow \mathbf{r}_u \times \mathbf{r}_v &= \begin{vmatrix} \mathbf{i} & \mathbf{j} & \mathbf{k} \\ -r \sin u \cos v & -r \sin u \sin v & r \cos u \\ -(R + r \cos u) \sin v & (R + r \cos u) \cos v & 0 \end{vmatrix} \\
&= -(R + r \cos u)(r \cos v \cos u)\mathbf{i} - (R + r \cos u)(r \sin v \cos u)\mathbf{j} + (-r \sin u)(R + r \cos u)\mathbf{k} \\
\Rightarrow |\mathbf{r}_u \times \mathbf{r}_v|^2 &= (R + r \cos u)^2 (r^2 \cos^2 v \cos^2 u + r^2 \sin^2 v \cos^2 u + r^2 \sin^2 u) \Rightarrow |\mathbf{r}_u \times \mathbf{r}_v| = r(R + r \cos u) \\
\Rightarrow A &= \int_0^{2\pi} \int_0^{2\pi} (rR + r^2 \cos u) \, du \, dv = \int_0^{2\pi} 2\pi r R \, dv = 4\pi^2 r R
\end{aligned}$$

54. (a) The point (x, y, z) is on the surface for fixed $x = f(u)$ when $y = g(u) \sin(\frac{\pi}{2} - v)$ and $z = g(u) \cos(\frac{\pi}{2} - v)$
 $\Rightarrow x = f(u)$, $y = g(u) \cos v$, and $z = g(u) \sin v \Rightarrow \mathbf{r}(u, v) = f(u)\mathbf{i} + (g(u) \cos v)\mathbf{j} + (g(u) \sin v)\mathbf{k}$, $0 \leq v \leq 2\pi$,
 $a \leq u \leq b$
- (b) Let $u = y$ and $x = u^2 \Rightarrow f(u) = u^2$ and $g(u) = u \Rightarrow \mathbf{r}(u, v) = u^2\mathbf{i} + (u \cos v)\mathbf{j} + (u \sin v)\mathbf{k}$, $0 \leq v \leq 2\pi$, $0 \leq u$

55. (a) Let $w^2 + \frac{z^2}{c^2} = 1$ where $w = \cos \phi$ and $\frac{z}{c} = \sin \phi \Rightarrow \frac{x^2}{a^2} + \frac{y^2}{b^2} = \cos^2 \phi \Rightarrow \frac{x}{a} = \cos \phi \cos \theta$ and $\frac{y}{b} = \cos \phi \sin \theta$
 $\Rightarrow x = a \cos \theta \cos \phi$, $y = b \sin \theta \cos \phi$, and $z = c \sin \phi$
 $\Rightarrow \mathbf{r}(\theta, \phi) = (a \cos \theta \cos \phi)\mathbf{i} + (b \sin \theta \cos \phi)\mathbf{j} + (c \sin \phi)\mathbf{k}$

$$\text{(b) } \mathbf{r}_\theta = (-a \sin \theta \cos \phi)\mathbf{i} + (b \cos \theta \cos \phi)\mathbf{j} \text{ and } \mathbf{r}_\phi = (-a \cos \theta \sin \phi)\mathbf{i} - (b \sin \theta \sin \phi)\mathbf{j} + (c \cos \phi)\mathbf{k}$$

$$\begin{aligned}
\Rightarrow \mathbf{r}_\theta \times \mathbf{r}_\phi &= \begin{vmatrix} \mathbf{i} & \mathbf{j} & \mathbf{k} \\ -a \sin \theta \cos \phi & b \cos \theta \cos \phi & 0 \\ -a \cos \theta \sin \phi & -b \sin \theta \sin \phi & c \cos \phi \end{vmatrix} \\
&= (bc \cos \theta \cos^2 \phi)\mathbf{i} + (ac \sin \theta \cos^2 \phi)\mathbf{j} + (ab \sin \phi \cos \phi)\mathbf{k} \\
\Rightarrow |\mathbf{r}_\theta \times \mathbf{r}_\phi|^2 &= b^2 c^2 \cos^2 \theta \cos^4 \phi + a^2 c^2 \sin^2 \theta \cos^4 \phi + a^2 b^2 \sin^2 \phi \cos^2 \phi, \text{ and the result follows.} \\
A &\Rightarrow \int_0^{2\pi} \int_0^\pi |\mathbf{r}_\theta \times \mathbf{r}_\phi| \, d\phi \, d\theta = \int_0^{2\pi} \int_0^\pi [a^2 b^2 \sin^2 \phi \cos^2 \phi + b^2 c^2 \cos^2 \theta \cos^4 \phi + a^2 c^2 \sin^2 \theta \cos^4 \phi]^{1/2} \, d\phi \, d\theta
\end{aligned}$$

$$56. \text{(a) } \mathbf{r}(\theta, u) = (\cosh u \cos \theta)\mathbf{i} + (\cosh u \sin \theta)\mathbf{j} + (\sinh u)\mathbf{k}$$

$$\text{(b) } \mathbf{r}(\theta, u) = (a \cosh u \cos \theta)\mathbf{i} + (b \cosh u \sin \theta)\mathbf{j} + (c \sinh u)\mathbf{k}$$

$$57. \mathbf{r}(\theta, u) = (5 \cosh u \cos \theta)\mathbf{i} + (5 \cosh u \sin \theta)\mathbf{j} + (5 \sinh u)\mathbf{k} \Rightarrow \mathbf{r}_\theta = (-5 \cosh u \sin \theta)\mathbf{i} + (5 \cosh u \cos \theta)\mathbf{j} \text{ and } \mathbf{r}_u = (5 \sinh u \cos \theta)\mathbf{i} + (5 \sinh u \sin \theta)\mathbf{j} + (5 \cosh u)\mathbf{k}$$

$$\begin{aligned}
\Rightarrow \mathbf{r}_\theta \times \mathbf{r}_u &= \begin{vmatrix} \mathbf{i} & \mathbf{j} & \mathbf{k} \\ -5 \cosh u \sin \theta & 5 \cosh u \cos \theta & 0 \\ 5 \sinh u \cos \theta & 5 \sinh u \sin \theta & 5 \cosh u \end{vmatrix} \\
&= (25 \cosh^2 u \cos \theta)\mathbf{i} + (25 \cosh^2 u \sin \theta)\mathbf{j} - (25 \cosh u \sinh u)\mathbf{k}. \text{ At the point } (x_0, y_0, 0), \text{ where } x_0^2 + y_0^2 = 25 \\
\text{we have } 5 \sinh u = 0 &\Rightarrow u = 0 \text{ and } x_0 = 25 \cos \theta, y_0 = 25 \sin \theta \Rightarrow \text{the tangent plane is} \\
5(x_0\mathbf{i} + y_0\mathbf{j}) \cdot [(x - x_0)\mathbf{i} + (y - y_0)\mathbf{j} + z\mathbf{k}] &= 0 \Rightarrow x_0 x - x_0^2 + y_0 y - y_0^2 = 0 \Rightarrow x_0 x + y_0 y = 25
\end{aligned}$$

$$58. \text{Let } \frac{z^2}{c^2} - w^2 = 1 \text{ where } \frac{z}{c} = \cosh u \text{ and } w = \sinh u \Rightarrow w^2 = \frac{x^2}{a^2} + \frac{y^2}{b^2} \Rightarrow \frac{x}{a} = w \cos \theta \text{ and } \frac{y}{b} = w \sin \theta$$

$$\Rightarrow x = a \sinh u \cos \theta, y = b \sinh u \sin \theta, \text{ and } z = c \cosh u$$

$$\Rightarrow \mathbf{r}(\theta, u) = (a \sinh u \cos \theta)\mathbf{i} + (b \sinh u \sin \theta)\mathbf{j} + (c \cosh u)\mathbf{k}, 0 \leq \theta \leq 2\pi, -\infty < u < \infty$$

16.7 STOKES' THEOREM

$$\begin{aligned}
1. \operatorname{curl} \mathbf{F} &= \nabla \times \mathbf{F} = \begin{vmatrix} \mathbf{i} & \mathbf{j} & \mathbf{k} \\ \frac{\partial}{\partial x} & \frac{\partial}{\partial y} & \frac{\partial}{\partial z} \\ x^2 & 2x & z^2 \end{vmatrix} = 0\mathbf{i} + 0\mathbf{j} + (2 - 0)\mathbf{k} = 2\mathbf{k} \text{ and } \mathbf{n} = \mathbf{k} \Rightarrow \operatorname{curl} \mathbf{F} \cdot \mathbf{n} = 2 \Rightarrow d\sigma = dx \, dy \\
\Rightarrow \oint_C \mathbf{F} \cdot d\mathbf{r} &= \iint_R 2 \, dA = 2(\text{Area of the ellipse}) = 4\pi
\end{aligned}$$

$$2. \operatorname{curl} \mathbf{F} = \nabla \times \mathbf{F} = \begin{vmatrix} \mathbf{i} & \mathbf{j} & \mathbf{k} \\ \frac{\partial}{\partial x} & \frac{\partial}{\partial y} & \frac{\partial}{\partial z} \\ 2y & 3x & -z^2 \end{vmatrix} = 0\mathbf{i} + 0\mathbf{j} + (3 - 2)\mathbf{k} = \mathbf{k} \text{ and } \mathbf{n} = \mathbf{k} \Rightarrow \operatorname{curl} \mathbf{F} \cdot \mathbf{n} = 1 \Rightarrow d\sigma = dx dy$$

$$\Rightarrow \oint_C \mathbf{F} \cdot d\mathbf{r} = \iint_R dx dy = \text{Area of circle} = 9\pi$$

$$3. \operatorname{curl} \mathbf{F} = \nabla \times \mathbf{F} = \begin{vmatrix} \mathbf{i} & \mathbf{j} & \mathbf{k} \\ \frac{\partial}{\partial x} & \frac{\partial}{\partial y} & \frac{\partial}{\partial z} \\ y & xz & x^2 \end{vmatrix} = -x\mathbf{i} - 2x\mathbf{j} + (z - 1)\mathbf{k} \text{ and } \mathbf{n} = \frac{\mathbf{i} + \mathbf{j} + \mathbf{k}}{\sqrt{3}} \Rightarrow \operatorname{curl} \mathbf{F} \cdot \mathbf{n}$$

$$= \frac{1}{\sqrt{3}}(-x - 2x + z - 1) \Rightarrow d\sigma = \frac{\sqrt{3}}{1} dA \Rightarrow \oint_C \mathbf{F} \cdot d\mathbf{r} = \iint_R \frac{1}{\sqrt{3}}(-3x + z - 1)\sqrt{3} dA$$

$$= \int_0^1 \int_0^{1-x} [-3x + (1 - x - y) - 1] dy dx = \int_0^1 \int_0^{1-x} (-4x - y) dy dx = \int_0^1 -[4x(1 - x) + \frac{1}{2}(1 - x)^2] dx$$

$$= -\int_0^1 (\frac{1}{2} + 3x - \frac{7}{2}x^2) dx = -\frac{5}{6}$$

$$4. \operatorname{curl} \mathbf{F} = \nabla \times \mathbf{F} = \begin{vmatrix} \mathbf{i} & \mathbf{j} & \mathbf{k} \\ \frac{\partial}{\partial x} & \frac{\partial}{\partial y} & \frac{\partial}{\partial z} \\ y^2 + z^2 & x^2 + z^2 & x^2 + y^2 \end{vmatrix} = (2y - 2z)\mathbf{i} + (2z - 2x)\mathbf{j} + (2x - 2y)\mathbf{k} \text{ and } \mathbf{n} = \frac{\mathbf{i} + \mathbf{j} + \mathbf{k}}{\sqrt{3}}$$

$$\Rightarrow \operatorname{curl} \mathbf{F} \cdot \mathbf{n} = \frac{1}{\sqrt{3}}(2y - 2z + 2z - 2x + 2x - 2y) = 0 \Rightarrow \oint_C \mathbf{F} \cdot d\mathbf{r} = \iint_S 0 d\sigma = 0$$

$$5. \operatorname{curl} \mathbf{F} = \nabla \times \mathbf{F} = \begin{vmatrix} \mathbf{i} & \mathbf{j} & \mathbf{k} \\ \frac{\partial}{\partial x} & \frac{\partial}{\partial y} & \frac{\partial}{\partial z} \\ y^2 + z^2 & x^2 + y^2 & x^2 + y^2 \end{vmatrix} = 2y\mathbf{i} + (2z - 2x)\mathbf{j} + (2x - 2y)\mathbf{k} \text{ and } \mathbf{n} = \mathbf{k}$$

$$\Rightarrow \operatorname{curl} \mathbf{F} \cdot \mathbf{n} = 2x - 2y \Rightarrow d\sigma = dx dy \Rightarrow \oint_C \mathbf{F} \cdot d\mathbf{r} = \int_{-1}^1 \int_{-1}^1 (2x - 2y) dx dy = \int_{-1}^1 [x^2 - 2xy]_{-1}^1 dy$$

$$= \int_{-1}^1 -4y dy = 0$$

$$6. \operatorname{curl} \mathbf{F} = \nabla \times \mathbf{F} = \begin{vmatrix} \mathbf{i} & \mathbf{j} & \mathbf{k} \\ \frac{\partial}{\partial x} & \frac{\partial}{\partial y} & \frac{\partial}{\partial z} \\ x^2 y^3 & 1 & z \end{vmatrix} = 0\mathbf{i} + 0\mathbf{j} - 3x^2 y^2 \mathbf{k} \text{ and } \mathbf{n} = \frac{2x\mathbf{i} + 2y\mathbf{j} + 2z\mathbf{k}}{2\sqrt{x^2 + y^2 + z^2}} = \frac{x\mathbf{i} + y\mathbf{j} + z\mathbf{k}}{4}$$

$$\Rightarrow \operatorname{curl} \mathbf{F} \cdot \mathbf{n} = -\frac{3}{4}x^2 y^2 z; d\sigma = \frac{4}{z} dA \text{ (Section 16.5, Example 5, with } a = 4) \Rightarrow \oint_C \mathbf{F} \cdot d\mathbf{r}$$

$$= \iint_R (-\frac{3}{4}x^2 y^2 z) (\frac{4}{z}) dA = -3 \int_0^{2\pi} \int_0^2 (r^2 \cos^2 \theta) (r^2 \sin^2 \theta) r dr d\theta = -3 \int_0^{2\pi} \left[\frac{r^6}{6}\right]_0^2 (\cos \theta \sin \theta)^2 d\theta$$

$$= -32 \int_0^{2\pi} \frac{1}{4} \sin^2 2\theta d\theta = -4 \int_0^{4\pi} \sin^2 u du = -4 \left[\frac{u}{2} - \frac{\sin 2u}{4}\right]_0^{4\pi} = -8\pi$$

$$7. x = 3 \cos t \text{ and } y = 2 \sin t \Rightarrow \mathbf{F} = (2 \sin t)\mathbf{i} + (9 \cos^2 t)\mathbf{j} + (9 \cos^2 t + 16 \sin^4 t) \sin e^{\sqrt{(6 \sin t \cos t)^2}} \mathbf{k} \text{ at the}$$

$$\text{base of the shell; } \mathbf{r} = (3 \cos t)\mathbf{i} + (2 \sin t)\mathbf{j} \Rightarrow d\mathbf{r} = (-3 \sin t)\mathbf{i} + (2 \cos t)\mathbf{j} \Rightarrow \mathbf{F} \cdot \frac{d\mathbf{r}}{dt} = -6 \sin^2 t + 18 \cos^3 t$$

$$\Rightarrow \iint_S \nabla \times \mathbf{F} \cdot \mathbf{n} d\sigma = \int_0^{2\pi} (-6 \sin^2 t + 18 \cos^3 t) dt = \left[-3t + \frac{3}{2} \sin 2t + 6(\sin t)(\cos^2 t + 2)\right]_0^{2\pi} = -6\pi$$

$$8. \operatorname{curl} \mathbf{F} = \nabla \times \mathbf{F} = \begin{vmatrix} \mathbf{i} & \mathbf{j} & \mathbf{k} \\ \frac{\partial}{\partial x} & \frac{\partial}{\partial y} & \frac{\partial}{\partial z} \\ -z + \frac{1}{2+x} & \tan^{-1} y & x + \frac{1}{4+z} \end{vmatrix} = -2\mathbf{j}; f(x, y, z) = 4x^2 + y + z^2 \Rightarrow \nabla f = 8x\mathbf{i} + \mathbf{j} + 2z\mathbf{k}$$

$$\Rightarrow \mathbf{n} = \frac{\nabla f}{|\nabla f|} \text{ and } \mathbf{p} = \mathbf{j} \Rightarrow |\nabla f \cdot \mathbf{p}| = 1 \Rightarrow d\sigma = \frac{|\nabla f|}{|\nabla f \cdot \mathbf{p}|} dA = |\nabla f| dA; \nabla \times \mathbf{F} \cdot \mathbf{n} = \frac{1}{|\nabla f|} (-2\mathbf{j} \cdot \nabla f) = \frac{-2}{|\nabla f|}$$

$$\Rightarrow \nabla \times \mathbf{F} \cdot \mathbf{n} d\sigma = -2 dA \Rightarrow \iint_S \nabla \times \mathbf{F} \cdot \mathbf{n} d\sigma = \iint_R -2 dA = -2(\text{Area of } R) = -2(\pi \cdot 1 \cdot 2) = -4\pi, \text{ where } R$$

is the elliptic region in the xz -plane enclosed by $4x^2 + z^2 = 4$.

9. Flux of $\nabla \times \mathbf{F} = \iint_S \nabla \times \mathbf{F} \cdot \mathbf{n} \, d\sigma = \oint_C \mathbf{F} \cdot d\mathbf{r}$, so let C be parametrized by $\mathbf{r} = (a \cos t)\mathbf{i} + (a \sin t)\mathbf{j}$,
 $0 \leq t \leq 2\pi \Rightarrow \frac{d\mathbf{r}}{dt} = (-a \sin t)\mathbf{i} + (a \cos t)\mathbf{j} \Rightarrow \mathbf{F} \cdot \frac{d\mathbf{r}}{dt} = ay \sin t + ax \cos t = a^2 \sin^2 t + a^2 \cos^2 t = a^2$
 \Rightarrow Flux of $\nabla \times \mathbf{F} = \oint_C \mathbf{F} \cdot d\mathbf{r} = \int_0^{2\pi} a^2 \, dt = 2\pi a^2$

10. $\nabla \times (y\mathbf{i}) = \begin{vmatrix} \mathbf{i} & \mathbf{j} & \mathbf{k} \\ \frac{\partial}{\partial x} & \frac{\partial}{\partial y} & \frac{\partial}{\partial z} \\ y & 0 & 0 \end{vmatrix} = -\mathbf{k}$; $\mathbf{n} = \frac{\nabla f}{|\nabla f|} = \frac{2x\mathbf{i} + 2y\mathbf{j} + 2z\mathbf{k}}{2\sqrt{x^2 + y^2 + z^2}} = x\mathbf{i} + y\mathbf{j} + z\mathbf{k}$
 $\Rightarrow \nabla \times (y\mathbf{i}) \cdot \mathbf{n} = -z$; $d\sigma = \frac{1}{z} \, dA$ (Section 16.5, Example 5, with $a = 1$) $\Rightarrow \iint_S \nabla \times (y\mathbf{i}) \cdot \mathbf{n} \, d\sigma$
 $= \iint_R (-z) \left(\frac{1}{z} \, dA\right) = -\iint_R dA = -\pi$, where R is the disk $x^2 + y^2 \leq 1$ in the xy -plane.

11. Let S_1 and S_2 be oriented surfaces that span C and that induce the same positive direction on C . Then

$$\iint_{S_1} \nabla \times \mathbf{F} \cdot \mathbf{n}_1 \, d\sigma_1 = \oint_C \mathbf{F} \cdot d\mathbf{r} = \iint_{S_2} \nabla \times \mathbf{F} \cdot \mathbf{n}_2 \, d\sigma_2$$

12. $\iint_S \nabla \times \mathbf{F} \cdot \mathbf{n} \, d\sigma = \iint_{S_1} \nabla \times \mathbf{F} \cdot \mathbf{n} \, d\sigma + \iint_{S_2} \nabla \times \mathbf{F} \cdot \mathbf{n} \, d\sigma$, and since S_1 and S_2 are joined by the simple closed curve C , each of the above integrals will be equal to a circulation integral on C . But for one surface the circulation will be counterclockwise, and for the other surface the circulation will be clockwise. Since the integrands are the same, the sum will be 0 $\Rightarrow \iint_S \nabla \times \mathbf{F} \cdot \mathbf{n} \, d\sigma = 0$.

13. $\nabla \times \mathbf{F} = \begin{vmatrix} \mathbf{i} & \mathbf{j} & \mathbf{k} \\ \frac{\partial}{\partial x} & \frac{\partial}{\partial y} & \frac{\partial}{\partial z} \\ 2z & 3x & 5y \end{vmatrix} = 5\mathbf{i} + 2\mathbf{j} + 3\mathbf{k}$; $\mathbf{r}_r = (\cos \theta)\mathbf{i} + (\sin \theta)\mathbf{j} - 2r\mathbf{k}$ and $\mathbf{r}_\theta = (-r \sin \theta)\mathbf{i} + (r \cos \theta)\mathbf{j}$
 $\Rightarrow \mathbf{r}_r \times \mathbf{r}_\theta = \begin{vmatrix} \mathbf{i} & \mathbf{j} & \mathbf{k} \\ \cos \theta & \sin \theta & -2r \\ -r \sin \theta & r \cos \theta & 0 \end{vmatrix} = (2r^2 \cos \theta)\mathbf{i} + (2r^2 \sin \theta)\mathbf{j} + r\mathbf{k}$; $\mathbf{n} = \frac{\mathbf{r}_r \times \mathbf{r}_\theta}{|\mathbf{r}_r \times \mathbf{r}_\theta|}$ and $d\sigma = |\mathbf{r}_r \times \mathbf{r}_\theta| \, dr \, d\theta$
 $\Rightarrow \nabla \times \mathbf{F} \cdot \mathbf{n} \, d\sigma = (\nabla \times \mathbf{F}) \cdot (\mathbf{r}_r \times \mathbf{r}_\theta) \, dr \, d\theta = (10r^2 \cos \theta + 4r^2 \sin \theta + 3r) \, dr \, d\theta \Rightarrow \iint_S \nabla \times \mathbf{F} \cdot \mathbf{n} \, d\sigma$
 $= \int_0^{2\pi} \int_0^2 (10r^2 \cos \theta + 4r^2 \sin \theta + 3r) \, dr \, d\theta = \int_0^{2\pi} \left[\frac{10}{3} r^3 \cos \theta + \frac{4}{3} r^3 \sin \theta + \frac{3}{2} r^2 \right]_0^2 \, d\theta$
 $= \int_0^{2\pi} \left(\frac{80}{3} \cos \theta + \frac{32}{3} \sin \theta + 6 \right) \, d\theta = 6(2\pi) = 12\pi$

14. $\nabla \times \mathbf{F} = \begin{vmatrix} \mathbf{i} & \mathbf{j} & \mathbf{k} \\ \frac{\partial}{\partial x} & \frac{\partial}{\partial y} & \frac{\partial}{\partial z} \\ y-z & z-x & x+z \end{vmatrix} = \mathbf{i} - 2\mathbf{j} - 2\mathbf{k}$; $\mathbf{r}_r \times \mathbf{r}_\theta = (2r^2 \cos \theta)\mathbf{i} + (2r^2 \sin \theta)\mathbf{j} + r\mathbf{k}$ and
 $\nabla \times \mathbf{F} \cdot \mathbf{n} \, d\sigma = (\nabla \times \mathbf{F}) \cdot (\mathbf{r}_r \times \mathbf{r}_\theta) \, dr \, d\theta$ (see Exercise 13 above) $\Rightarrow \iint_S \nabla \times \mathbf{F} \cdot \mathbf{n} \, d\sigma$
 $= \int_0^{2\pi} \int_0^3 (-2r^2 \cos \theta - 4r^2 \sin \theta - 2r) \, dr \, d\theta = \int_0^{2\pi} \left[-\frac{2}{3} r^3 \cos \theta - \frac{4}{3} r^3 \sin \theta - r^2 \right]_0^3 \, d\theta$
 $= \int_0^{2\pi} (-18 \cos \theta - 36 \sin \theta - 9) \, d\theta = -9(2\pi) = -18\pi$

15. $\nabla \times \mathbf{F} = \begin{vmatrix} \mathbf{i} & \mathbf{j} & \mathbf{k} \\ \frac{\partial}{\partial x} & \frac{\partial}{\partial y} & \frac{\partial}{\partial z} \\ x^2y & 2y^3z & 3z \end{vmatrix} = -2y^3\mathbf{i} + 0\mathbf{j} - x^2\mathbf{k}$; $\mathbf{r}_r \times \mathbf{r}_\theta = \begin{vmatrix} \mathbf{i} & \mathbf{j} & \mathbf{k} \\ \cos \theta & \sin \theta & 1 \\ -r \sin \theta & r \cos \theta & 0 \end{vmatrix}$
 $= (-r \cos \theta)\mathbf{i} - (r \sin \theta)\mathbf{j} + r\mathbf{k}$ and $\nabla \times \mathbf{F} \cdot \mathbf{n} \, d\sigma = (\nabla \times \mathbf{F}) \cdot (\mathbf{r}_r \times \mathbf{r}_\theta) \, dr \, d\theta$ (see Exercise 13 above)
 $\Rightarrow \iint_S \nabla \times \mathbf{F} \cdot \mathbf{n} \, d\sigma = \iint_R (2ry^3 \cos \theta - rx^2) \, dr \, d\theta = \int_0^{2\pi} \int_0^1 (2r^4 \sin^3 \theta \cos \theta - r^3 \cos^2 \theta) \, dr \, d\theta$

$$= \int_0^{2\pi} \left(\frac{2}{5} \sin^3 \theta \cos \theta - \frac{1}{4} \cos^2 \theta \right) d\theta = \left[\frac{1}{10} \sin^4 \theta - \frac{1}{4} \left(\frac{\theta}{2} + \frac{\sin 2\theta}{4} \right) \right]_0^{2\pi} = -\frac{\pi}{4}$$

$$16. \quad \nabla \times \mathbf{F} = \begin{vmatrix} \mathbf{i} & \mathbf{j} & \mathbf{k} \\ \frac{\partial}{\partial x} & \frac{\partial}{\partial y} & \frac{\partial}{\partial z} \\ x-y & y-z & z-x \end{vmatrix} = \mathbf{i} + \mathbf{j} + \mathbf{k}; \quad \mathbf{r}_r \times \mathbf{r}_\theta = \begin{vmatrix} \mathbf{i} & \mathbf{j} & \mathbf{k} \\ \cos \theta & \sin \theta & -1 \\ -r \sin \theta & r \cos \theta & 0 \end{vmatrix}$$

$$= (r \cos \theta)\mathbf{i} + (r \sin \theta)\mathbf{j} + r\mathbf{k} \text{ and } \nabla \times \mathbf{F} \cdot \mathbf{n} \, d\sigma = (\nabla \times \mathbf{F}) \cdot (\mathbf{r}_r \times \mathbf{r}_\theta) \, dr \, d\theta \text{ (see Exercise 13 above)}$$

$$\Rightarrow \iint_S \nabla \times \mathbf{F} \cdot \mathbf{n} \, d\sigma = \int_0^{2\pi} \int_0^5 (r \cos \theta + r \sin \theta + r) \, dr \, d\theta = \int_0^{2\pi} \left[(\cos \theta + \sin \theta + 1) \frac{r^2}{2} \right]_0^5 d\theta = \left(\frac{25}{2} \right) (2\pi) = 25\pi$$

$$17. \quad \nabla \times \mathbf{F} = \begin{vmatrix} \mathbf{i} & \mathbf{j} & \mathbf{k} \\ \frac{\partial}{\partial x} & \frac{\partial}{\partial y} & \frac{\partial}{\partial z} \\ 3y & 5-2x & z^2-2 \end{vmatrix} = 0\mathbf{i} + 0\mathbf{j} - 5\mathbf{k};$$

$$\mathbf{r}_\phi \times \mathbf{r}_\theta = \begin{vmatrix} \mathbf{i} & \mathbf{j} & \mathbf{k} \\ \sqrt{3} \cos \phi \cos \theta & \sqrt{3} \cos \phi \sin \theta & -\sqrt{3} \sin \phi \\ -\sqrt{3} \sin \phi \sin \theta & \sqrt{3} \sin \phi \cos \theta & 0 \end{vmatrix}$$

$$= (3 \sin^2 \phi \cos \theta)\mathbf{i} + (3 \sin^2 \phi \sin \theta)\mathbf{j} + (3 \sin \phi \cos \phi)\mathbf{k}; \quad \nabla \times \mathbf{F} \cdot \mathbf{n} \, d\sigma = (\nabla \times \mathbf{F}) \cdot (\mathbf{r}_\phi \times \mathbf{r}_\theta) \, d\phi \, d\theta \text{ (see Exercise 13 above)}$$

$$\Rightarrow \iint_S \nabla \times \mathbf{F} \cdot \mathbf{n} \, d\sigma = \int_0^{2\pi} \int_0^{\pi/2} -15 \cos \phi \sin \phi \, d\phi \, d\theta = \int_0^{2\pi} \left[\frac{15}{2} \cos^2 \phi \right]_0^{\pi/2} d\theta = \int_0^{2\pi} -\frac{15}{2} \, d\theta = -15\pi$$

$$18. \quad \nabla \times \mathbf{F} = \begin{vmatrix} \mathbf{i} & \mathbf{j} & \mathbf{k} \\ \frac{\partial}{\partial x} & \frac{\partial}{\partial y} & \frac{\partial}{\partial z} \\ y^2 & z^2 & x \end{vmatrix} = -2z\mathbf{i} - \mathbf{j} - 2y\mathbf{k};$$

$$\mathbf{r}_\phi \times \mathbf{r}_\theta = \begin{vmatrix} \mathbf{i} & \mathbf{j} & \mathbf{k} \\ 2 \cos \phi \cos \theta & 2 \cos \phi \sin \theta & -2 \sin \phi \\ -2 \sin \phi \sin \theta & 2 \sin \phi \cos \theta & 0 \end{vmatrix}$$

$$= (4 \sin^2 \phi \cos \theta)\mathbf{i} + (4 \sin^2 \phi \sin \theta)\mathbf{j} + (4 \sin \phi \cos \phi)\mathbf{k}; \quad \nabla \times \mathbf{F} \cdot \mathbf{n} \, d\sigma = (\nabla \times \mathbf{F}) \cdot (\mathbf{r}_\phi \times \mathbf{r}_\theta) \, d\phi \, d\theta \text{ (see Exercise 13 above)}$$

$$\Rightarrow \iint_S \nabla \times \mathbf{F} \cdot \mathbf{n} \, d\sigma = \iint_R (-8z \sin^2 \phi \cos \theta - 4 \sin^2 \phi \sin \theta - 8y \sin \phi \cos \theta) \, d\phi \, d\theta$$

$$= \int_0^{2\pi} \int_0^{\pi/2} (-16 \sin^2 \phi \cos \phi \cos \theta - 4 \sin^2 \phi \sin \theta - 16 \sin^2 \phi \sin \theta \cos \theta) \, d\phi \, d\theta$$

$$= \int_0^{2\pi} \left[-\frac{16}{3} \sin^3 \phi \cos \theta - 4 \left(\frac{\phi}{2} - \frac{\sin 2\phi}{4} \right) (\sin \theta) - 16 \left(\frac{\phi}{2} - \frac{\sin 2\phi}{4} \right) (\sin \theta \cos \theta) \right]_0^{\pi/2} d\theta$$

$$= \int_0^{2\pi} \left(-\frac{16}{3} \cos \theta - \pi \sin \theta - 4\pi \sin \theta \cos \theta \right) d\theta = \left[-\frac{16}{3} \sin \theta + \pi \cos \theta - 2\pi \sin^2 \theta \right]_0^{2\pi} = 0$$

$$19. \quad (a) \quad \mathbf{F} = 2x\mathbf{i} + 2y\mathbf{j} + 2z\mathbf{k} \Rightarrow \text{curl } \mathbf{F} = \mathbf{0} \Rightarrow \oint_C \mathbf{F} \cdot d\mathbf{r} = \iint_S \nabla \times \mathbf{F} \cdot \mathbf{n} \, d\sigma = \iint_S 0 \, d\sigma = 0$$

$$(b) \quad \text{Let } f(x, y, z) = x^2 y^2 z^3 \Rightarrow \nabla \times \mathbf{F} = \nabla \times \nabla f = \mathbf{0} \Rightarrow \text{curl } \mathbf{F} = \mathbf{0} \Rightarrow \oint_C \mathbf{F} \cdot d\mathbf{r} = \iint_S \nabla \times \mathbf{F} \cdot \mathbf{n} \, d\sigma = \iint_S 0 \, d\sigma = 0$$

$$(c) \quad \mathbf{F} = \nabla \times (x\mathbf{i} + y\mathbf{j} + z\mathbf{k}) = \mathbf{0} \Rightarrow \nabla \times \mathbf{F} = \mathbf{0} \Rightarrow \oint_C \mathbf{F} \cdot d\mathbf{r} = \iint_S \nabla \times \mathbf{F} \cdot \mathbf{n} \, d\sigma = \iint_S 0 \, d\sigma = 0$$

$$(d) \quad \mathbf{F} = \nabla f \Rightarrow \nabla \times \mathbf{F} = \nabla \times \nabla f = \mathbf{0} \Rightarrow \oint_C \mathbf{F} \cdot d\mathbf{r} = \iint_S \nabla \times \mathbf{F} \cdot \mathbf{n} \, d\sigma = \iint_S 0 \, d\sigma = 0$$

$$20. \quad \mathbf{F} = \nabla f = -\frac{1}{2}(x^2 + y^2 + z^2)^{-3/2}(2x)\mathbf{i} - \frac{1}{2}(x^2 + y^2 + z^2)^{-3/2}(2y)\mathbf{j} - \frac{1}{2}(x^2 + y^2 + z^2)^{-3/2}(2z)\mathbf{k}$$

$$= -x(x^2 + y^2 + z^2)^{-3/2}\mathbf{i} - y(x^2 + y^2 + z^2)^{-3/2}\mathbf{j} - z(x^2 + y^2 + z^2)^{-3/2}\mathbf{k}$$

$$(a) \quad \mathbf{r} = (a \cos t)\mathbf{i} + (a \sin t)\mathbf{j}, \quad 0 \leq t \leq 2\pi \Rightarrow \frac{d\mathbf{r}}{dt} = (-a \sin t)\mathbf{i} + (a \cos t)\mathbf{j}$$

$$\Rightarrow \mathbf{F} \cdot \frac{d\mathbf{r}}{dt} = -x(x^2 + y^2 + z^2)^{-3/2}(-a \sin t) - y(x^2 + y^2 + z^2)^{-3/2}(a \cos t)$$

$$= \left(-\frac{a \cos t}{a^3} \right) (-a \sin t) - \left(\frac{a \sin t}{a^3} \right) (a \cos t) = 0 \Rightarrow \oint_C \mathbf{F} \cdot d\mathbf{r} = 0$$

$$(b) \oint_C \mathbf{F} \cdot d\mathbf{r} = \iint_S \nabla \times \mathbf{F} \cdot \mathbf{n} \, d\sigma = \iint_S \nabla \times \nabla f \cdot \mathbf{n} \, d\sigma = \iint_S \mathbf{0} \cdot \mathbf{n} \, d\sigma = \iint_S 0 \, d\sigma = 0$$

$$21. \text{ Let } \mathbf{F} = 2y\mathbf{i} + 3z\mathbf{j} - x\mathbf{k} \Rightarrow \nabla \times \mathbf{F} = \begin{vmatrix} \mathbf{i} & \mathbf{j} & \mathbf{k} \\ \frac{\partial}{\partial x} & \frac{\partial}{\partial y} & \frac{\partial}{\partial z} \\ 2y & 3z & -x \end{vmatrix} = -3\mathbf{i} + \mathbf{j} - 2\mathbf{k}; \mathbf{n} = \frac{2\mathbf{i} + 2\mathbf{j} + \mathbf{k}}{3}$$

$$\Rightarrow \nabla \times \mathbf{F} \cdot \mathbf{n} = -2 \Rightarrow \oint_C \mathbf{F} \cdot d\mathbf{r} = \iint_S \nabla \times \mathbf{F} \cdot \mathbf{n} \, d\sigma = \iint_S -2 \, d\sigma$$

$$= -2 \iint_S d\sigma, \text{ where } \iint_S d\sigma \text{ is the area of the region enclosed by } C \text{ on the plane } S: 2x + 2y + z = 2$$

$$22. \nabla \times \mathbf{F} = \begin{vmatrix} \mathbf{i} & \mathbf{j} & \mathbf{k} \\ \frac{\partial}{\partial x} & \frac{\partial}{\partial y} & \frac{\partial}{\partial z} \\ x & y & z \end{vmatrix} = 0$$

$$23. \text{ Suppose } \mathbf{F} = M\mathbf{i} + N\mathbf{j} + P\mathbf{k} \text{ exists such that } \nabla \times \mathbf{F} = \left(\frac{\partial P}{\partial y} - \frac{\partial N}{\partial z} \right) \mathbf{i} + \left(\frac{\partial M}{\partial z} - \frac{\partial P}{\partial x} \right) \mathbf{j} + \left(\frac{\partial N}{\partial x} - \frac{\partial M}{\partial y} \right) \mathbf{k}$$

$$= x\mathbf{i} + y\mathbf{j} + z\mathbf{k}. \text{ Then } \frac{\partial}{\partial x} \left(\frac{\partial P}{\partial y} - \frac{\partial N}{\partial z} \right) = \frac{\partial}{\partial x} (x) \Rightarrow \frac{\partial^2 P}{\partial x \partial y} - \frac{\partial^2 N}{\partial x \partial z} = 1. \text{ Likewise, } \frac{\partial}{\partial y} \left(\frac{\partial M}{\partial z} - \frac{\partial P}{\partial x} \right) = \frac{\partial}{\partial y} (y)$$

$$\Rightarrow \frac{\partial^2 M}{\partial y \partial z} - \frac{\partial^2 P}{\partial y \partial x} = 1 \text{ and } \frac{\partial}{\partial z} \left(\frac{\partial N}{\partial x} - \frac{\partial M}{\partial y} \right) = \frac{\partial}{\partial z} (z) \Rightarrow \frac{\partial^2 N}{\partial z \partial x} - \frac{\partial^2 M}{\partial z \partial y} = 1. \text{ Summing the calculated equations}$$

$$\Rightarrow \left(\frac{\partial^2 P}{\partial x \partial y} - \frac{\partial^2 P}{\partial y \partial x} \right) + \left(\frac{\partial^2 N}{\partial z \partial x} - \frac{\partial^2 N}{\partial x \partial z} \right) + \left(\frac{\partial^2 M}{\partial y \partial z} - \frac{\partial^2 M}{\partial z \partial y} \right) = 3 \text{ or } 0 = 3 \text{ (assuming the second mixed partials are equal). This result is a contradiction, so there is no field } \mathbf{F} \text{ such that } \text{curl } \mathbf{F} = x\mathbf{i} + y\mathbf{j} + z\mathbf{k}.$$

$$24. \text{ Yes: If } \nabla \times \mathbf{F} = \mathbf{0}, \text{ then the circulation of } \mathbf{F} \text{ around the boundary } C \text{ of any oriented surface } S \text{ in the domain of } \mathbf{F} \text{ is zero. The reason is this: By Stokes's theorem, circulation} = \oint_C \mathbf{F} \cdot d\mathbf{r} = \iint_S \nabla \times \mathbf{F} \cdot \mathbf{n} \, d\sigma = \iint_S \mathbf{0} \cdot \mathbf{n} \, d\sigma = 0.$$

$$25. \mathbf{r} = \sqrt{x^2 + y^2} \Rightarrow \mathbf{r}^4 = (x^2 + y^2)^2 \Rightarrow \mathbf{F} = \nabla (\mathbf{r}^4) = 4x(x^2 + y^2)\mathbf{i} + 4y(x^2 + y^2)\mathbf{j} = M\mathbf{i} + N\mathbf{j}$$

$$\Rightarrow \oint_C \nabla (\mathbf{r}^4) \cdot \mathbf{n} \, ds = \oint_C \mathbf{F} \cdot \mathbf{n} \, ds = \oint_C M \, dy - N \, dx = \iint_R \left(\frac{\partial M}{\partial x} + \frac{\partial N}{\partial y} \right) dx \, dy$$

$$= \iint_R [4(x^2 + y^2) + 8x^2 + 4(x^2 + y^2) + 8y^2] \, dA = \iint_R 16(x^2 + y^2) \, dA = 16 \iint_R x^2 \, dA + 16 \iint_R y^2 \, dA$$

$$= 16I_y + 16I_x.$$

$$26. \frac{\partial P}{\partial y} = 0, \frac{\partial N}{\partial z} = 0, \frac{\partial M}{\partial z} = 0, \frac{\partial P}{\partial x} = 0, \frac{\partial N}{\partial x} = \frac{y^2 - x^2}{(x^2 + y^2)^2}, \frac{\partial M}{\partial y} = \frac{y^2 - x^2}{(x^2 + y^2)^2} \Rightarrow \text{curl } \mathbf{F} = \left[\frac{y^2 - x^2}{(x^2 + y^2)^2} - \frac{y^2 - x^2}{(x^2 + y^2)^2} \right] \mathbf{k} = \mathbf{0}.$$

However, $x^2 + y^2 = 1 \Rightarrow \mathbf{r} = (\cos t)\mathbf{i} + (\sin t)\mathbf{j} \Rightarrow \frac{d\mathbf{r}}{dt} = (-\sin t)\mathbf{i} + (\cos t)\mathbf{j}$

$$\Rightarrow \mathbf{F} = (-\sin t)\mathbf{i} + (\cos t)\mathbf{j} \Rightarrow \mathbf{F} \cdot \frac{d\mathbf{r}}{dt} = \sin^2 t + \cos^2 t = 1 \Rightarrow \oint_C \mathbf{F} \cdot d\mathbf{r} = \int_0^{2\pi} 1 \, dt = 2\pi \text{ which is not zero.}$$

16.8 THE DIVERGENCE THEOREM AND A UNIFIED THEORY

$$1. \mathbf{F} = \frac{-y\mathbf{i} + x\mathbf{j}}{\sqrt{x^2 + y^2}} \Rightarrow \text{div } \mathbf{F} = \frac{xy - xy}{(x^2 + y^2)^{3/2}} = 0 \qquad 2. \mathbf{F} = x\mathbf{i} + y\mathbf{j} \Rightarrow \text{div } \mathbf{F} = 1 + 1 = 2$$

$$3. \mathbf{F} = -\frac{GM(x\mathbf{i} + y\mathbf{j} + z\mathbf{k})}{(x^2 + y^2 + z^2)^{3/2}} \Rightarrow \text{div } \mathbf{F} = -GM \left[\frac{(x^2 + y^2 + z^2)^{3/2} - 3x^2(x^2 + y^2 + z^2)^{1/2}}{(x^2 + y^2 + z^2)^3} \right]$$

$$- GM \left[\frac{(x^2 + y^2 + z^2)^{3/2} - 3y^2(x^2 + y^2 + z^2)^{1/2}}{(x^2 + y^2 + z^2)^3} \right] - GM \left[\frac{(x^2 + y^2 + z^2)^{3/2} - 3z^2(x^2 + y^2 + z^2)^{1/2}}{(x^2 + y^2 + z^2)^3} \right]$$

$$= -GM \left[\frac{3(x^2+y^2+z^2)^2 - 3(x^2+y^2+z^2)(x^2+y^2+z^2)}{(x^2+y^2+z^2)^{7/2}} \right] = 0$$

4. $z = a^2 - r^2$ in cylindrical coordinates $\Rightarrow z = a^2 - (x^2 + y^2) \Rightarrow \mathbf{v} = (a^2 - x^2 - y^2) \mathbf{k} \Rightarrow \operatorname{div} \mathbf{v} = 0$

5. $\frac{\partial}{\partial x}(y-x) = -1, \frac{\partial}{\partial y}(z-y) = -1, \frac{\partial}{\partial z}(y-x) = 0 \Rightarrow \nabla \cdot \mathbf{F} = -2 \Rightarrow \text{Flux} = \int_{-1}^1 \int_{-1}^1 \int_{-1}^1 -2 \, dx \, dy \, dz = -2(2^3) = -16$

6. $\frac{\partial}{\partial x}(x^2) = 2x, \frac{\partial}{\partial y}(y^2) = 2y, \frac{\partial}{\partial z}(z^2) = 2z \Rightarrow \nabla \cdot \mathbf{F} = 2x + 2y + 2z$

(a) $\text{Flux} = \int_0^1 \int_0^1 \int_0^1 (2x + 2y + 2z) \, dx \, dy \, dz = \int_0^1 \int_0^1 [x^2 + 2x(y+z)]_0^1 \, dy \, dz = \int_0^1 \int_0^1 (1 + 2y + 2z) \, dy \, dz$
 $= \int_0^1 [y(1+2z) + y^2]_0^1 \, dz = \int_0^1 (2 + 2z) \, dz = [2z + z^2]_0^1 = 3$

(b) $\text{Flux} = \int_{-1}^1 \int_{-1}^1 \int_{-1}^1 (2x + 2y + 2z) \, dx \, dy \, dz = \int_{-1}^1 \int_{-1}^1 [x^2 + 2x(y+z)]_{-1}^1 \, dy \, dz = \int_{-1}^1 \int_{-1}^1 (4y + 4z) \, dy \, dz$
 $= \int_{-1}^1 [2y^2 + 4yz]_{-1}^1 \, dz = \int_{-1}^1 8z \, dz = [4z^2]_{-1}^1 = 0$

(c) In cylindrical coordinates, $\text{Flux} = \int \int \int_D (2x + 2y + 2z) \, dx \, dy \, dz$

$$= \int_0^1 \int_0^{2\pi} \int_0^2 (2r \cos \theta + 2r \sin \theta + 2z) r \, dr \, d\theta \, dz = \int_0^1 \int_0^{2\pi} \left[\frac{2}{3} r^3 \cos \theta + \frac{2}{3} r^3 \sin \theta + zr^2 \right]_0^2 \, d\theta \, dz$$

$$= \int_0^1 \int_0^{2\pi} \left(\frac{16}{3} \cos \theta + \frac{16}{3} \sin \theta + 4z \right) \, d\theta \, dz = \int_0^1 \left[\frac{16}{3} \sin \theta - \frac{16}{3} \cos \theta + 4z\theta \right]_0^{2\pi} \, dz = \int_0^1 8\pi z \, dz = [4\pi z^2]_0^1 = 4\pi$$

7. $\frac{\partial}{\partial x}(y) = 0, \frac{\partial}{\partial y}(xy) = x, \frac{\partial}{\partial z}(-z) = -1 \Rightarrow \nabla \cdot \mathbf{F} = x - 1; z = x^2 + y^2 \Rightarrow z = r^2$ in cylindrical coordinates

$$\Rightarrow \text{Flux} = \int \int \int_D (x - 1) \, dz \, dy \, dx = \int_0^{2\pi} \int_0^2 \int_0^{r^2} (r \cos \theta - 1) \, dz \, r \, dr \, d\theta = \int_0^{2\pi} \int_0^2 (r^3 \cos \theta - r^2) \, r \, dr \, d\theta$$

$$= \int_0^{2\pi} \left[\frac{r^5}{5} \cos \theta - \frac{r^4}{4} \right]_0^2 \, d\theta = \int_0^{2\pi} \left(\frac{32}{5} \cos \theta - 4 \right) \, d\theta = \left[\frac{32}{5} \sin \theta - 4\theta \right]_0^{2\pi} = -8\pi$$

8. $\frac{\partial}{\partial x}(x^2) = 2x, \frac{\partial}{\partial y}(xz) = 0, \frac{\partial}{\partial z}(3z) = 3 \Rightarrow \nabla \cdot \mathbf{F} = 2x + 3 \Rightarrow \text{Flux} = \int \int \int_D (2x + 3) \, dV$

$$= \int_0^{2\pi} \int_0^\pi \int_0^2 (2\rho \sin \phi \cos \theta + 3)(\rho^2 \sin \phi) \, d\rho \, d\phi \, d\theta = \int_0^{2\pi} \int_0^\pi \left[\frac{\rho^4}{2} \sin \phi \cos \theta + \rho^3 \right]_0^2 \, \sin \phi \, d\phi \, d\theta$$

$$= \int_0^{2\pi} \int_0^\pi (8 \sin \phi \cos \theta + 8) \sin \phi \, d\phi \, d\theta = \int_0^{2\pi} \left[8 \left(\frac{\phi}{2} - \frac{\sin 2\phi}{4} \right) \cos \theta - 8 \cos \phi \right]_0^\pi \, d\theta = \int_0^{2\pi} (4\pi \cos \theta + 16) \, d\theta = 32\pi$$

9. $\frac{\partial}{\partial x}(x^2) = 2x, \frac{\partial}{\partial y}(-2xy) = -2x, \frac{\partial}{\partial z}(3xz) = 3x \Rightarrow \text{Flux} = \int \int \int_D 3x \, dx \, dy \, dz$

$$= \int_0^{\pi/2} \int_0^{\pi/2} \int_0^2 (3\rho \sin \phi \cos \theta)(\rho^2 \sin \phi) \, d\rho \, d\phi \, d\theta = \int_0^{\pi/2} \int_0^{\pi/2} 12 \sin^2 \phi \cos \theta \, d\phi \, d\theta = \int_0^{\pi/2} 3\pi \cos \theta \, d\theta = 3\pi$$

10. $\frac{\partial}{\partial x}(6x^2 + 2xy) = 12x + 2y, \frac{\partial}{\partial y}(2y + x^2z) = 2, \frac{\partial}{\partial z}(4x^2y^3) = 0 \Rightarrow \nabla \cdot \mathbf{F} = 12x + 2y + 2$

$$\Rightarrow \text{Flux} = \int \int \int_D (12x + 2y + 2) \, dV = \int_0^3 \int_0^{\pi/2} \int_0^2 (12r \cos \theta + 2r \sin \theta + 2) r \, dr \, d\theta \, dz$$

$$= \int_0^3 \int_0^{\pi/2} \left(32 \cos \theta + \frac{16}{3} \sin \theta + 4 \right) \, d\theta \, dz = \int_0^3 \left(32 + 2\pi + \frac{16}{3} \right) \, dz = 112 + 6\pi$$

11. $\frac{\partial}{\partial x}(2xz) = 2z, \frac{\partial}{\partial y}(-xy) = -x, \frac{\partial}{\partial z}(-z^2) = -2z \Rightarrow \nabla \cdot \mathbf{F} = -x \Rightarrow \text{Flux} = \int \int \int_D -x \, dV$

$$= \int_0^2 \int_0^{\sqrt{16-4x^2}} \int_0^{4-y} -x \, dz \, dy \, dx = \int_0^2 \int_0^{\sqrt{16-4x^2}} (xy - 4x) \, dy \, dx = \int_0^2 \left[\frac{1}{2} x(16 - 4x^2) - 4x\sqrt{16 - 4x^2} \right] \, dx$$

$$= \left[4x^2 - \frac{1}{2} x^4 + \frac{1}{3} (16 - 4x^2)^{3/2} \right]_0^2 = -\frac{40}{3}$$

$$12. \frac{\partial}{\partial x}(x^3) = 3x^2, \frac{\partial}{\partial y}(y^3) = 3y^2, \frac{\partial}{\partial z}(z^3) = 3z^2 \Rightarrow \nabla \cdot \mathbf{F} = 3x^2 + 3y^2 + 3z^2 \Rightarrow \text{Flux} = \iiint_D 3(x^2 + y^2 + z^2) \, dV$$

$$= 3 \int_0^{2\pi} \int_0^\pi \int_0^a \rho^2 (\rho^2 \sin \phi) \, d\rho \, d\phi \, d\theta = 3 \int_0^{2\pi} \int_0^\pi \frac{a^5}{5} \sin \phi \, d\phi \, d\theta = 3 \int_0^{2\pi} \frac{2a^5}{5} \, d\theta = \frac{12\pi a^5}{5}$$

$$13. \text{ Let } \rho = \sqrt{x^2 + y^2 + z^2}. \text{ Then } \frac{\partial \rho}{\partial x} = \frac{x}{\rho}, \frac{\partial \rho}{\partial y} = \frac{y}{\rho}, \frac{\partial \rho}{\partial z} = \frac{z}{\rho} \Rightarrow \frac{\partial}{\partial x}(\rho x) = \left(\frac{\partial \rho}{\partial x}\right)x + \rho = \frac{x^2}{\rho} + \rho, \frac{\partial}{\partial y}(\rho y) = \left(\frac{\partial \rho}{\partial y}\right)y + \rho$$

$$= \frac{y^2}{\rho} + \rho, \frac{\partial}{\partial z}(\rho z) = \left(\frac{\partial \rho}{\partial z}\right)z + \rho = \frac{z^2}{\rho} + \rho \Rightarrow \nabla \cdot \mathbf{F} = \frac{x^2 + y^2 + z^2}{\rho} + 3\rho = 4\rho, \text{ since } \rho = \sqrt{x^2 + y^2 + z^2}$$

$$\Rightarrow \text{Flux} = \iiint_D 4\rho \, dV = \int_0^{2\pi} \int_0^\pi \int_1^{\sqrt{2}} (4\rho) (\rho^2 \sin \phi) \, d\rho \, d\phi \, d\theta = \int_0^{2\pi} \int_0^\pi 3 \sin \phi \, d\phi \, d\theta = \int_0^{2\pi} 6 \, d\theta = 12\pi$$

$$14. \text{ Let } \rho = \sqrt{x^2 + y^2 + z^2}. \text{ Then } \frac{\partial \rho}{\partial x} = \frac{x}{\rho}, \frac{\partial \rho}{\partial y} = \frac{y}{\rho}, \frac{\partial \rho}{\partial z} = \frac{z}{\rho} \Rightarrow \frac{\partial}{\partial x}\left(\frac{x}{\rho}\right) = \frac{1}{\rho} - \left(\frac{x}{\rho^2}\right)\frac{\partial \rho}{\partial x} = \frac{1}{\rho} - \frac{x^2}{\rho^3}. \text{ Similarly,}$$

$$\frac{\partial}{\partial y}\left(\frac{y}{\rho}\right) = \frac{1}{\rho} - \frac{y^2}{\rho^3} \text{ and } \frac{\partial}{\partial z}\left(\frac{z}{\rho}\right) = \frac{1}{\rho} - \frac{z^2}{\rho^3} \Rightarrow \nabla \cdot \mathbf{F} = \frac{3}{\rho} - \frac{x^2 + y^2 + z^2}{\rho^3} = \frac{2}{\rho}$$

$$\Rightarrow \text{Flux} = \iiint_D \frac{2}{\rho} \, dV = \int_0^{2\pi} \int_0^\pi \int_1^2 \left(\frac{2}{\rho}\right) (\rho^2 \sin \phi) \, d\rho \, d\phi \, d\theta = \int_0^{2\pi} \int_0^\pi 3 \sin \phi \, d\phi \, d\theta = \int_0^{2\pi} 6 \, d\theta = 12\pi$$

$$15. \frac{\partial}{\partial x}(5x^3 + 12xy^2) = 15x^2 + 12y^2, \frac{\partial}{\partial y}(y^3 + e^y \sin z) = 3y^2 + e^y \sin z, \frac{\partial}{\partial z}(5z^3 + e^y \cos z) = 15z^2 - e^y \sin z$$

$$\Rightarrow \nabla \cdot \mathbf{F} = 15x^2 + 15y^2 + 15z^2 = 15\rho^2 \Rightarrow \text{Flux} = \iiint_D 15\rho^2 \, dV = \int_0^{2\pi} \int_0^\pi \int_1^{\sqrt{2}} (15\rho^2) (\rho^2 \sin \phi) \, d\rho \, d\phi \, d\theta$$

$$= \int_0^{2\pi} \int_0^\pi (12\sqrt{2} - 3) \sin \phi \, d\phi \, d\theta = \int_0^{2\pi} (24\sqrt{2} - 6) \, d\theta = (48\sqrt{2} - 12)\pi$$

$$16. \frac{\partial}{\partial x}[\ln(x^2 + y^2)] = \frac{2x}{x^2 + y^2}, \frac{\partial}{\partial y}\left(-\frac{2z}{x} \tan^{-1} \frac{y}{x}\right) = \left(-\frac{2z}{x}\right) \left[\frac{\left(\frac{1}{x}\right)}{1 + \left(\frac{y}{x}\right)^2}\right] = -\frac{2z}{x^2 + y^2}, \frac{\partial}{\partial z}(z\sqrt{x^2 + y^2}) = \sqrt{x^2 + y^2}$$

$$\Rightarrow \nabla \cdot \mathbf{F} = \frac{2x}{x^2 + y^2} - \frac{2z}{x^2 + y^2} + \sqrt{x^2 + y^2} \Rightarrow \text{Flux} = \iiint_D \left(\frac{2x}{x^2 + y^2} - \frac{2z}{x^2 + y^2} + \sqrt{x^2 + y^2}\right) \, dz \, dy \, dx$$

$$= \int_0^{2\pi} \int_1^{\sqrt{2}} \int_{-1}^2 \left(\frac{2r \cos \theta}{r^2} - \frac{2z}{r^2} + r\right) \, dz \, r \, dr \, d\theta = \int_0^{2\pi} \int_1^{\sqrt{2}} \left(6 \cos \theta - \frac{3}{r} + 3r^2\right) \, dr \, d\theta$$

$$= \int_0^{2\pi} \left[6(\sqrt{2} - 1) \cos \theta - 3 \ln \sqrt{2} + 2\sqrt{2} - 1\right] \, d\theta = 2\pi \left(-\frac{3}{2} \ln 2 + 2\sqrt{2} - 1\right)$$

$$17. \text{ (a) } \mathbf{G} = M\mathbf{i} + N\mathbf{j} + P\mathbf{k} \Rightarrow \nabla \times \mathbf{G} = \text{curl } \mathbf{G} = \left(\frac{\partial P}{\partial y} - \frac{\partial N}{\partial z}\right)\mathbf{i} + \left(\frac{\partial M}{\partial z} - \frac{\partial P}{\partial x}\right)\mathbf{j} + \left(\frac{\partial N}{\partial x} - \frac{\partial M}{\partial y}\right)\mathbf{k} \Rightarrow \nabla \cdot \nabla \times \mathbf{G}$$

$$= \text{div}(\text{curl } \mathbf{G}) = \frac{\partial}{\partial x}\left(\frac{\partial P}{\partial y} - \frac{\partial N}{\partial z}\right) + \frac{\partial}{\partial y}\left(\frac{\partial M}{\partial z} - \frac{\partial P}{\partial x}\right) + \frac{\partial}{\partial z}\left(\frac{\partial N}{\partial x} - \frac{\partial M}{\partial y}\right)$$

$$= \frac{\partial^2 P}{\partial x \partial y} - \frac{\partial^2 N}{\partial x \partial z} + \frac{\partial^2 M}{\partial y \partial z} - \frac{\partial^2 P}{\partial y \partial x} + \frac{\partial^2 N}{\partial z \partial x} - \frac{\partial^2 M}{\partial z \partial y} = 0 \text{ if all first and second partial derivatives are continuous}$$

(b) By the Divergence Theorem, the outward flux of $\nabla \times \mathbf{G}$ across a closed surface is zero because

$$\text{outward flux of } \nabla \times \mathbf{G} = \iint_S (\nabla \times \mathbf{G}) \cdot \mathbf{n} \, d\sigma$$

$$= \iiint_D \nabla \cdot \nabla \times \mathbf{G} \, dV \quad [\text{Divergence Theorem with } \mathbf{F} = \nabla \times \mathbf{G}]$$

$$= \iiint_D (0) \, dV = 0 \quad [\text{by part (a)}]$$

$$18. \text{ (a) Let } \mathbf{F}_1 = M_1\mathbf{i} + N_1\mathbf{j} + P_1\mathbf{k} \text{ and } \mathbf{F}_2 = M_2\mathbf{i} + N_2\mathbf{j} + P_2\mathbf{k} \Rightarrow a\mathbf{F}_1 + b\mathbf{F}_2$$

$$= (aM_1 + bM_2)\mathbf{i} + (aN_1 + bN_2)\mathbf{j} + (aP_1 + bP_2)\mathbf{k} \Rightarrow \nabla \cdot (a\mathbf{F}_1 + b\mathbf{F}_2)$$

$$= \left(a \frac{\partial M_1}{\partial x} + b \frac{\partial M_2}{\partial x}\right) + \left(a \frac{\partial N_1}{\partial y} + b \frac{\partial N_2}{\partial y}\right) + \left(a \frac{\partial P_1}{\partial z} + b \frac{\partial P_2}{\partial z}\right)$$

$$= a \left(\frac{\partial M_1}{\partial x} + \frac{\partial N_1}{\partial y} + \frac{\partial P_1}{\partial z}\right) + b \left(\frac{\partial M_2}{\partial x} + \frac{\partial N_2}{\partial y} + \frac{\partial P_2}{\partial z}\right) = a(\nabla \cdot \mathbf{F}_1) + b(\nabla \cdot \mathbf{F}_2)$$

(b) Define \mathbf{F}_1 and \mathbf{F}_2 as in part a $\Rightarrow \nabla \times (a\mathbf{F}_1 + b\mathbf{F}_2)$

$$= \left[\left(a \frac{\partial P_1}{\partial y} + b \frac{\partial P_2}{\partial y}\right) - \left(a \frac{\partial N_1}{\partial z} + b \frac{\partial N_2}{\partial z}\right)\right]\mathbf{i} + \left[\left(a \frac{\partial M_1}{\partial z} + b \frac{\partial M_2}{\partial z}\right) - \left(a \frac{\partial P_1}{\partial x} + b \frac{\partial P_2}{\partial x}\right)\right]\mathbf{j}$$

$$+ \left[\left(a \frac{\partial N_1}{\partial x} + b \frac{\partial N_2}{\partial x} \right) - \left(a \frac{\partial M_1}{\partial y} + b \frac{\partial M_2}{\partial y} \right) \right] \mathbf{k} = a \left[\left(\frac{\partial P_1}{\partial y} - \frac{\partial N_1}{\partial z} \right) \mathbf{i} + \left(\frac{\partial M_1}{\partial z} - \frac{\partial P_1}{\partial x} \right) \mathbf{j} + \left(\frac{\partial N_1}{\partial x} - \frac{\partial M_1}{\partial y} \right) \mathbf{k} \right]$$

$$+ b \left[\left(\frac{\partial P_2}{\partial y} - \frac{\partial N_2}{\partial z} \right) \mathbf{i} + \left(\frac{\partial M_2}{\partial z} - \frac{\partial P_2}{\partial x} \right) \mathbf{j} + \left(\frac{\partial N_2}{\partial x} - \frac{\partial M_2}{\partial y} \right) \mathbf{k} \right] = a \nabla \times \mathbf{F}_1 + b \nabla \times \mathbf{F}_2$$

$$(c) \mathbf{F}_1 \times \mathbf{F}_2 = \begin{vmatrix} \mathbf{i} & \mathbf{j} & \mathbf{k} \\ M_1 & N_1 & P_1 \\ M_2 & N_2 & P_2 \end{vmatrix} = (N_1 P_2 - P_1 N_2) \mathbf{i} - (M_1 P_2 - P_1 M_2) \mathbf{j} + (M_1 N_2 - N_1 M_2) \mathbf{k} \Rightarrow \nabla \cdot (\mathbf{F}_1 \times \mathbf{F}_2)$$

$$= \nabla \cdot [(N_1 P_2 - P_1 N_2) \mathbf{i} - (M_1 P_2 - P_1 M_2) \mathbf{j} + (M_1 N_2 - N_1 M_2) \mathbf{k}]$$

$$= \frac{\partial}{\partial x} (N_1 P_2 - P_1 N_2) - \frac{\partial}{\partial y} (M_1 P_2 - P_1 M_2) + \frac{\partial}{\partial z} (M_1 N_2 - N_1 M_2) = \left(P_2 \frac{\partial N_1}{\partial x} + N_1 \frac{\partial P_2}{\partial x} - N_2 \frac{\partial P_1}{\partial x} - P_1 \frac{\partial N_2}{\partial x} \right)$$

$$- \left(M_1 \frac{\partial P_2}{\partial y} + P_2 \frac{\partial M_1}{\partial y} - P_1 \frac{\partial M_2}{\partial y} - M_2 \frac{\partial P_1}{\partial y} \right) + \left(M_1 \frac{\partial N_2}{\partial z} + N_2 \frac{\partial M_1}{\partial z} - N_1 \frac{\partial M_2}{\partial z} - M_2 \frac{\partial N_1}{\partial z} \right)$$

$$= M_2 \left(\frac{\partial P_1}{\partial y} - \frac{\partial N_1}{\partial z} \right) + N_2 \left(\frac{\partial M_1}{\partial z} - \frac{\partial P_1}{\partial x} \right) + P_2 \left(\frac{\partial N_1}{\partial x} - \frac{\partial M_1}{\partial y} \right) + M_1 \left(\frac{\partial N_2}{\partial z} - \frac{\partial P_2}{\partial x} \right) + N_1 \left(\frac{\partial P_2}{\partial x} - \frac{\partial M_2}{\partial y} \right)$$

$$+ P_1 \left(\frac{\partial M_2}{\partial y} - \frac{\partial N_2}{\partial z} \right) = \mathbf{F}_2 \cdot \nabla \times \mathbf{F}_1 - \mathbf{F}_1 \cdot \nabla \times \mathbf{F}_2$$

$$19. (a) \operatorname{div}(\mathbf{gF}) = \nabla \cdot \mathbf{gF} = \frac{\partial}{\partial x} (\mathbf{gM}) + \frac{\partial}{\partial y} (\mathbf{gN}) + \frac{\partial}{\partial z} (\mathbf{gP}) = \left(\mathbf{g} \frac{\partial M}{\partial x} + M \frac{\partial \mathbf{g}}{\partial x} \right) + \left(\mathbf{g} \frac{\partial N}{\partial y} + N \frac{\partial \mathbf{g}}{\partial y} \right) + \left(\mathbf{g} \frac{\partial P}{\partial z} + P \frac{\partial \mathbf{g}}{\partial z} \right)$$

$$= \left(M \frac{\partial \mathbf{g}}{\partial x} + N \frac{\partial \mathbf{g}}{\partial y} + P \frac{\partial \mathbf{g}}{\partial z} \right) + \mathbf{g} \left(\frac{\partial M}{\partial x} + \frac{\partial N}{\partial y} + \frac{\partial P}{\partial z} \right) = \mathbf{g} \nabla \cdot \mathbf{F} + \nabla \mathbf{g} \cdot \mathbf{F}$$

$$(b) \nabla \times (\mathbf{gF}) = \left[\frac{\partial}{\partial y} (\mathbf{gP}) - \frac{\partial}{\partial z} (\mathbf{gN}) \right] \mathbf{i} + \left[\frac{\partial}{\partial z} (\mathbf{gM}) - \frac{\partial}{\partial x} (\mathbf{gP}) \right] \mathbf{j} + \left[\frac{\partial}{\partial x} (\mathbf{gN}) - \frac{\partial}{\partial y} (\mathbf{gM}) \right] \mathbf{k}$$

$$= \left(P \frac{\partial \mathbf{g}}{\partial y} + \mathbf{g} \frac{\partial P}{\partial y} - N \frac{\partial \mathbf{g}}{\partial z} - \mathbf{g} \frac{\partial N}{\partial z} \right) \mathbf{i} + \left(M \frac{\partial \mathbf{g}}{\partial z} + \mathbf{g} \frac{\partial M}{\partial z} - P \frac{\partial \mathbf{g}}{\partial x} - \mathbf{g} \frac{\partial P}{\partial x} \right) \mathbf{j} + \left(N \frac{\partial \mathbf{g}}{\partial x} + \mathbf{g} \frac{\partial N}{\partial x} - M \frac{\partial \mathbf{g}}{\partial y} - \mathbf{g} \frac{\partial M}{\partial y} \right) \mathbf{k}$$

$$= \left(P \frac{\partial \mathbf{g}}{\partial y} - N \frac{\partial \mathbf{g}}{\partial z} \right) \mathbf{i} + \left(\mathbf{g} \frac{\partial P}{\partial y} - \mathbf{g} \frac{\partial N}{\partial z} \right) \mathbf{i} + \left(M \frac{\partial \mathbf{g}}{\partial z} - P \frac{\partial \mathbf{g}}{\partial x} \right) \mathbf{j} + \left(\mathbf{g} \frac{\partial M}{\partial z} - \mathbf{g} \frac{\partial P}{\partial x} \right) \mathbf{j} + \left(N \frac{\partial \mathbf{g}}{\partial x} - M \frac{\partial \mathbf{g}}{\partial y} \right) \mathbf{k}$$

$$+ \left(\mathbf{g} \frac{\partial N}{\partial x} - \mathbf{g} \frac{\partial M}{\partial y} \right) \mathbf{k} = \mathbf{g} \nabla \times \mathbf{F} + \nabla \mathbf{g} \times \mathbf{F}$$

20. Let $\mathbf{F}_1 = M_1 \mathbf{i} + N_1 \mathbf{j} + P_1 \mathbf{k}$ and $\mathbf{F}_2 = M_2 \mathbf{i} + N_2 \mathbf{j} + P_2 \mathbf{k}$.

$$(a) \mathbf{F}_1 \times \mathbf{F}_2 = (N_1 P_2 - P_1 N_2) \mathbf{i} + (P_1 M_2 - M_1 P_2) \mathbf{j} + (M_1 N_2 - N_1 M_2) \mathbf{k} \Rightarrow \nabla \times (\mathbf{F}_1 \times \mathbf{F}_2)$$

$$= \left[\frac{\partial}{\partial y} (M_1 N_2 - N_1 M_2) - \frac{\partial}{\partial z} (P_1 M_2 - M_1 P_2) \right] \mathbf{i} + \left[\frac{\partial}{\partial z} (N_1 P_2 - P_1 N_2) - \frac{\partial}{\partial x} (M_1 N_2 - N_1 M_2) \right] \mathbf{j}$$

$$+ \left[\frac{\partial}{\partial x} (P_1 M_2 - M_1 P_2) - \frac{\partial}{\partial y} (N_1 P_2 - P_1 N_2) \right] \mathbf{k}$$

and consider the \mathbf{i} -component only: $\frac{\partial}{\partial y} (M_1 N_2 - N_1 M_2) - \frac{\partial}{\partial z} (P_1 M_2 - M_1 P_2)$

$$= N_2 \frac{\partial M_1}{\partial y} + M_1 \frac{\partial N_2}{\partial y} - M_2 \frac{\partial N_1}{\partial y} - N_1 \frac{\partial M_2}{\partial y} - M_2 \frac{\partial P_1}{\partial z} - P_1 \frac{\partial M_2}{\partial z} + P_2 \frac{\partial M_1}{\partial z} + M_1 \frac{\partial P_2}{\partial z}$$

$$= \left(N_2 \frac{\partial M_1}{\partial y} + P_2 \frac{\partial M_1}{\partial z} \right) - \left(N_1 \frac{\partial M_2}{\partial y} + P_1 \frac{\partial M_2}{\partial z} \right) + \left(\frac{\partial N_2}{\partial y} + \frac{\partial P_2}{\partial z} \right) M_1 - \left(\frac{\partial N_1}{\partial y} + \frac{\partial P_1}{\partial z} \right) M_2$$

$$= \left(M_2 \frac{\partial M_1}{\partial x} + N_2 \frac{\partial M_1}{\partial y} + P_2 \frac{\partial M_1}{\partial z} \right) - \left(M_1 \frac{\partial M_2}{\partial x} + N_1 \frac{\partial M_2}{\partial y} + P_1 \frac{\partial M_2}{\partial z} \right) + \left(\frac{\partial M_2}{\partial x} + \frac{\partial N_2}{\partial y} + \frac{\partial P_2}{\partial z} \right) M_1$$

$$- \left(\frac{\partial M_1}{\partial x} + \frac{\partial N_1}{\partial y} + \frac{\partial P_1}{\partial z} \right) M_2. \text{ Now, } \mathbf{i}\text{-comp of } (\mathbf{F}_2 \cdot \nabla) \mathbf{F}_1 = \left(M_2 \frac{\partial}{\partial x} + N_2 \frac{\partial}{\partial y} + P_2 \frac{\partial}{\partial z} \right) M_1$$

$$= \left(M_2 \frac{\partial M_1}{\partial x} + N_2 \frac{\partial M_1}{\partial y} + P_2 \frac{\partial M_1}{\partial z} \right); \text{ likewise, } \mathbf{i}\text{-comp of } (\mathbf{F}_1 \cdot \nabla) \mathbf{F}_2 = \left(M_1 \frac{\partial M_2}{\partial x} + N_1 \frac{\partial M_2}{\partial y} + P_1 \frac{\partial M_2}{\partial z} \right);$$

\mathbf{i} -comp of $(\nabla \cdot \mathbf{F}_2) \mathbf{F}_1 = \left(\frac{\partial M_2}{\partial x} + \frac{\partial N_2}{\partial y} + \frac{\partial P_2}{\partial z} \right) M_1$ and \mathbf{i} -comp of $(\nabla \cdot \mathbf{F}_1) \mathbf{F}_2 = \left(\frac{\partial M_1}{\partial x} + \frac{\partial N_1}{\partial y} + \frac{\partial P_1}{\partial z} \right) M_2$.

Similar results hold for the \mathbf{j} and \mathbf{k} components of $\nabla \times (\mathbf{F}_1 \times \mathbf{F}_2)$. In summary, since the corresponding components are equal, we have the result

$$\nabla \times (\mathbf{F}_1 \times \mathbf{F}_2) = (\mathbf{F}_2 \cdot \nabla) \mathbf{F}_1 - (\mathbf{F}_1 \cdot \nabla) \mathbf{F}_2 + (\nabla \cdot \mathbf{F}_2) \mathbf{F}_1 - (\nabla \cdot \mathbf{F}_1) \mathbf{F}_2$$

(b) Here again we consider only the \mathbf{i} -component of each expression. Thus, the \mathbf{i} -comp of $\nabla (\mathbf{F}_1 \cdot \mathbf{F}_2)$

$$= \frac{\partial}{\partial x} (M_1 M_2 + N_1 N_2 + P_1 P_2) = \left(M_1 \frac{\partial M_2}{\partial x} + M_2 \frac{\partial M_1}{\partial x} + N_1 \frac{\partial N_2}{\partial x} + N_2 \frac{\partial N_1}{\partial x} + P_1 \frac{\partial P_2}{\partial x} + P_2 \frac{\partial P_1}{\partial x} \right)$$

$$\mathbf{i}\text{-comp of } (\mathbf{F}_1 \cdot \nabla) \mathbf{F}_2 = \left(M_1 \frac{\partial M_2}{\partial x} + N_1 \frac{\partial M_2}{\partial y} + P_1 \frac{\partial M_2}{\partial z} \right),$$

$$\mathbf{i}\text{-comp of } (\mathbf{F}_2 \cdot \nabla) \mathbf{F}_1 = \left(M_2 \frac{\partial M_1}{\partial x} + N_2 \frac{\partial M_1}{\partial y} + P_2 \frac{\partial M_1}{\partial z} \right),$$

$$\mathbf{i}\text{-comp of } \mathbf{F}_1 \times (\nabla \times \mathbf{F}_2) = N_1 \left(\frac{\partial N_2}{\partial x} - \frac{\partial M_2}{\partial y} \right) - P_1 \left(\frac{\partial M_2}{\partial z} - \frac{\partial P_2}{\partial x} \right), \text{ and}$$

$$\mathbf{i}\text{-comp of } \mathbf{F}_2 \times (\nabla \times \mathbf{F}_1) = N_2 \left(\frac{\partial N_1}{\partial x} - \frac{\partial M_1}{\partial y} \right) - P_2 \left(\frac{\partial M_1}{\partial z} - \frac{\partial P_1}{\partial x} \right).$$

Since corresponding components are equal, we see that

$$\nabla (\mathbf{F}_1 \cdot \mathbf{F}_2) = (\mathbf{F}_1 \cdot \nabla) \mathbf{F}_2 + (\mathbf{F}_2 \cdot \nabla) \mathbf{F}_1 + \mathbf{F}_1 \times (\nabla \times \mathbf{F}_2) + \mathbf{F}_2 \times (\nabla \times \mathbf{F}_1), \text{ as claimed.}$$

21. The integral's value never exceeds the surface area of S . Since $|\mathbf{F}| \leq 1$, we have $|\mathbf{F} \cdot \mathbf{n}| = |\mathbf{F}| |\mathbf{n}| \leq (1)(1) = 1$ and

$$\begin{aligned} \iint_D \nabla \cdot \mathbf{F} \, d\sigma &= \iint_S \mathbf{F} \cdot \mathbf{n} \, d\sigma && \text{[Divergence Theorem]} \\ &\leq \iint_S |\mathbf{F} \cdot \mathbf{n}| \, d\sigma && \text{[A property of integrals]} \\ &\leq \iint_S (1) \, d\sigma && \text{[}|\mathbf{F} \cdot \mathbf{n}| \leq 1\text{]} \\ &= \text{Area of } S. \end{aligned}$$

22. Yes, the outward flux through the top is 5. The reason is this: Since $\nabla \cdot \mathbf{F} = \nabla \cdot (x\mathbf{i} - 2y\mathbf{j} + (z + 3)\mathbf{k}) = 1 - 2 + 1 = 0$, the outward flux across the closed cubelike surface is 0 by the Divergence Theorem. The flux across the top is therefore the negative of the flux across the sides and base. Routine calculations show that the sum of these latter fluxes is -5 . (The flux across the sides that lie in the xz -plane and the yz -plane are 0, while the flux across the xy -plane is -3 .) Therefore the flux across the top is 5.

23. (a) $\frac{\partial}{\partial x}(x) = 1, \frac{\partial}{\partial y}(y) = 1, \frac{\partial}{\partial z}(z) = 1 \Rightarrow \nabla \cdot \mathbf{F} = 3 \Rightarrow \text{Flux} = \iiint_D 3 \, dV = 3 \iiint_D dV = 3(\text{Volume of the solid})$

(b) If \mathbf{F} is orthogonal to \mathbf{n} at every point of S , then $\mathbf{F} \cdot \mathbf{n} = 0$ everywhere $\Rightarrow \text{Flux} = \iint_S \mathbf{F} \cdot \mathbf{n} \, d\sigma = 0$.

But the flux is $3(\text{Volume of the solid}) \neq 0$, so \mathbf{F} is not orthogonal to \mathbf{n} at every point.

24. $\nabla \cdot \mathbf{F} = -2x - 4y - 6z + 12 \Rightarrow \text{Flux} = \int_0^a \int_0^b \int_0^1 (-2x - 4y - 6z + 12) \, dz \, dy \, dx$
 $= \int_0^a \int_0^b (-2x - 4y + 9) \, dy \, dx = \int_0^a (-2xb - 2b^2 + 9b) \, dx = -a^2b - 2ab^2 + 9ab = ab(-a - 2b + 9) = f(a, b);$
 $\frac{\partial f}{\partial a} = -2ab - 2b^2 + 9b$ and $\frac{\partial f}{\partial b} = -a^2 - 4ab + 9a$ so that $\frac{\partial f}{\partial a} = 0$ and $\frac{\partial f}{\partial b} = 0 \Rightarrow b(-2a - 2b + 9) = 0$ and $a(-a - 4b + 9) = 0 \Rightarrow b = 0$ or $-2a - 2b + 9 = 0$, and $a = 0$ or $-a - 4b + 9 = 0$. Now $b = 0$ or $a = 0 \Rightarrow \text{Flux} = 0$; $-2a - 2b + 9 = 0$ and $-a - 4b + 9 = 0 \Rightarrow 3a - 9 = 0 \Rightarrow a = 3 \Rightarrow b = \frac{3}{2}$ so that $f(3, \frac{3}{2}) = \frac{27}{2}$ is the maximum flux.

25. $\iint_S \mathbf{F} \cdot \mathbf{n} \, d\sigma = \iiint_D \nabla \cdot \mathbf{F} \, dV = \iiint_D 3 \, dV \Rightarrow \frac{1}{3} \iint_S \mathbf{F} \cdot \mathbf{n} \, d\sigma = \iiint_D dV = \text{Volume of } D$

26. $\mathbf{F} = \mathbf{C} \Rightarrow \nabla \cdot \mathbf{F} = 0 \Rightarrow \text{Flux} = \iint_S \mathbf{F} \cdot \mathbf{n} \, d\sigma = \iiint_D \nabla \cdot \mathbf{F} \, dV = \iiint_D 0 \, dV = 0$

27. (a) From the Divergence Theorem, $\iint_S \nabla f \cdot \mathbf{n} \, d\sigma = \iiint_D \nabla \cdot \nabla f \, dV = \iiint_D \nabla^2 f \, dV = \iiint_D 0 \, dV = 0$

(b) From the Divergence Theorem, $\iint_S f \nabla f \cdot \mathbf{n} \, d\sigma = \iiint_D \nabla \cdot (f \nabla f) \, dV$. Now,

$$\begin{aligned} f \nabla f &= \left(f \frac{\partial f}{\partial x} \right) \mathbf{i} + \left(f \frac{\partial f}{\partial y} \right) \mathbf{j} + \left(f \frac{\partial f}{\partial z} \right) \mathbf{k} \Rightarrow \nabla \cdot (f \nabla f) = \left[f \frac{\partial^2 f}{\partial x^2} + \left(\frac{\partial f}{\partial x} \right)^2 \right] + \left[f \frac{\partial^2 f}{\partial y^2} + \left(\frac{\partial f}{\partial y} \right)^2 \right] + \left[f \frac{\partial^2 f}{\partial z^2} + \left(\frac{\partial f}{\partial z} \right)^2 \right] \\ &= f \nabla^2 f + |\nabla f|^2 = 0 + |\nabla f|^2 \text{ since } f \text{ is harmonic} \Rightarrow \iint_S f \nabla f \cdot \mathbf{n} \, d\sigma = \iiint_D |\nabla f|^2 \, dV, \text{ as claimed.} \end{aligned}$$

28. From the Divergence Theorem, $\iint_S \nabla f \cdot \mathbf{n} \, d\sigma = \iiint_D \nabla \cdot \nabla f \, dV = \iiint_D \left(\frac{\partial^2 f}{\partial x^2} + \frac{\partial^2 f}{\partial y^2} + \frac{\partial^2 f}{\partial z^2} \right) \, dV$. Now,

$$f(x, y, z) = \ln \sqrt{x^2 + y^2 + z^2} = \frac{1}{2} \ln(x^2 + y^2 + z^2) \Rightarrow \frac{\partial f}{\partial x} = \frac{x}{x^2 + y^2 + z^2}, \frac{\partial f}{\partial y} = \frac{y}{x^2 + y^2 + z^2}, \frac{\partial f}{\partial z} = \frac{z}{x^2 + y^2 + z^2}$$

$$\begin{aligned} \Rightarrow \frac{\partial^2 f}{\partial x^2} &= \frac{-x^2+y^2+z^2}{(x^2+y^2+z^2)^2}, \frac{\partial^2 f}{\partial y^2} = \frac{x^2-y^2+z^2}{(x^2+y^2+z^2)^2}, \frac{\partial^2 f}{\partial z^2} = \frac{x^2+y^2-z^2}{(x^2+y^2+z^2)^2}, \Rightarrow \frac{\partial^2 f}{\partial x^2} + \frac{\partial^2 f}{\partial y^2} + \frac{\partial^2 f}{\partial z^2} \\ &= \frac{x^2+y^2+z^2}{(x^2+y^2+z^2)^2} = \frac{1}{x^2+y^2+z^2} \Rightarrow \int_S \nabla f \cdot \mathbf{n} \, d\sigma = \int_D \int \frac{dV}{x^2+y^2+z^2} = \int_0^{\pi/2} \int_0^{\pi/2} \int_0^a \frac{\rho^2 \sin \phi}{\rho^2} \, d\rho \, d\phi \, d\theta \\ &= \int_0^{\pi/2} \int_0^{\pi/2} a \sin \phi \, d\phi \, d\theta = \int_0^{\pi/2} [-a \cos \phi]_0^{\pi/2} \, d\theta = \int_0^{\pi/2} a \, d\theta = \frac{\pi a}{2} \end{aligned}$$

$$\begin{aligned} 29. \int_S \mathbf{f} \cdot \nabla \mathbf{g} \cdot \mathbf{n} \, d\sigma &= \int_D \int \nabla \cdot (\mathbf{f} \nabla \mathbf{g}) \, dV = \int_D \int \nabla \cdot \left(f \frac{\partial \mathbf{g}}{\partial x} \mathbf{i} + f \frac{\partial \mathbf{g}}{\partial y} \mathbf{j} + f \frac{\partial \mathbf{g}}{\partial z} \mathbf{k} \right) \, dV \\ &= \int_D \int \left(f \frac{\partial^2 \mathbf{g}}{\partial x^2} + \frac{\partial f}{\partial x} \frac{\partial \mathbf{g}}{\partial x} + f \frac{\partial^2 \mathbf{g}}{\partial y^2} + \frac{\partial f}{\partial y} \frac{\partial \mathbf{g}}{\partial y} + f \frac{\partial^2 \mathbf{g}}{\partial z^2} + \frac{\partial f}{\partial z} \frac{\partial \mathbf{g}}{\partial z} \right) \, dV \\ &= \int_D \int \left[f \left(\frac{\partial^2 \mathbf{g}}{\partial x^2} + \frac{\partial^2 \mathbf{g}}{\partial y^2} + \frac{\partial^2 \mathbf{g}}{\partial z^2} \right) + \left(\frac{\partial f}{\partial x} \frac{\partial \mathbf{g}}{\partial x} + \frac{\partial f}{\partial y} \frac{\partial \mathbf{g}}{\partial y} + \frac{\partial f}{\partial z} \frac{\partial \mathbf{g}}{\partial z} \right) \right] \, dV = \int_D \int (f \nabla^2 \mathbf{g} + \nabla f \cdot \nabla \mathbf{g}) \, dV \end{aligned}$$

$$\begin{aligned} 30. \text{ By Exercise 29, } \int_S \mathbf{f} \cdot \nabla \mathbf{g} \cdot \mathbf{n} \, d\sigma &= \int_D \int (f \nabla^2 \mathbf{g} + \nabla f \cdot \nabla \mathbf{g}) \, dV \text{ and by interchanging the roles of } f \text{ and } g, \\ \int_S \mathbf{g} \cdot \nabla \mathbf{f} \cdot \mathbf{n} \, d\sigma &= \int_D \int (\mathbf{g} \nabla^2 \mathbf{f} + \nabla \mathbf{g} \cdot \nabla \mathbf{f}) \, dV. \text{ Subtracting the second equation from the first yields:} \\ \int_S (\mathbf{f} \cdot \nabla \mathbf{g} - \mathbf{g} \cdot \nabla \mathbf{f}) \cdot \mathbf{n} \, d\sigma &= \int_D \int (\mathbf{f} \nabla^2 \mathbf{g} - \mathbf{g} \nabla^2 \mathbf{f}) \, dV \text{ since } \nabla \mathbf{f} \cdot \nabla \mathbf{g} = \nabla \mathbf{g} \cdot \nabla \mathbf{f}. \end{aligned}$$

31. (a) The integral $\int_D \int \int p(t, x, y, z) \, dV$ represents the mass of the fluid at any time t . The equation says that the instantaneous rate of change of mass is flux of the fluid through the surface S enclosing the region D : the mass decreases if the flux is outward (so the fluid flows out of D), and increases if the flow is inward (interpreting \mathbf{n} as the outward pointing unit normal to the surface).

$$\begin{aligned} \text{(b) } \int_D \int \int \frac{\partial p}{\partial t} \, dV &= \frac{d}{dt} \int_D \int \int p \, dV = - \int_S \int \mathbf{p} \mathbf{v} \cdot \mathbf{n} \, d\sigma = - \int_D \int \nabla \cdot \mathbf{p} \mathbf{v} \, dV \Rightarrow \frac{\partial p}{\partial t} = - \nabla \cdot \mathbf{p} \mathbf{v} \\ \text{Since the law is to hold for all regions } D, \nabla \cdot \mathbf{p} \mathbf{v} + \frac{\partial p}{\partial t} &= 0, \text{ as claimed} \end{aligned}$$

32. (a) ∇T points in the direction of maximum change of the temperature, so if the solid is heating up at the point the temperature is greater in a region surrounding the point $\Rightarrow \nabla T$ points away from the point $\Rightarrow -\nabla T$ points toward the point $\Rightarrow -\nabla T$ points in the direction the heat flows.

(b) Assuming the Law of Conservation of Mass (Exercise 31) with $-k \nabla T = \mathbf{p} \mathbf{v}$ and $c\rho T = p$, we have $\frac{d}{dt} \int_D \int \int c\rho T \, dV = - \int_S \int -k \nabla T \cdot \mathbf{n} \, d\sigma \Rightarrow$ the continuity equation, $\nabla \cdot (-k \nabla T) + \frac{\partial}{\partial t} (c\rho T) = 0$
 $\Rightarrow c\rho \frac{\partial T}{\partial t} = - \nabla \cdot (-k \nabla T) = k \nabla^2 T \Rightarrow \frac{\partial T}{\partial t} = \frac{k}{c\rho} \nabla^2 T = K \nabla^2 T$, as claimed

CHAPTER 16 PRACTICE EXERCISES

1. Path 1: $\mathbf{r} = t\mathbf{i} + t\mathbf{j} + t\mathbf{k} \Rightarrow x = t, y = t, z = t, 0 \leq t \leq 1 \Rightarrow f(g(t), h(t), k(t)) = 3 - 3t^2$ and $\frac{dx}{dt} = 1, \frac{dy}{dt} = 1, \frac{dz}{dt} = 1 \Rightarrow \sqrt{\left(\frac{dx}{dt}\right)^2 + \left(\frac{dy}{dt}\right)^2 + \left(\frac{dz}{dt}\right)^2} dt = \sqrt{3} dt \Rightarrow \int_C f(x, y, z) \, ds = \int_0^1 \sqrt{3} (3 - 3t^2) \, dt = 2\sqrt{3}$
- Path 2: $\mathbf{r}_1 = t\mathbf{i} + t\mathbf{j}, 0 \leq t \leq 1 \Rightarrow x = t, y = t, z = 0 \Rightarrow f(g(t), h(t), k(t)) = 2t - 3t^2 + 3$ and $\frac{dx}{dt} = 1, \frac{dy}{dt} = 1, \frac{dz}{dt} = 0 \Rightarrow \sqrt{\left(\frac{dx}{dt}\right)^2 + \left(\frac{dy}{dt}\right)^2 + \left(\frac{dz}{dt}\right)^2} dt = \sqrt{2} dt \Rightarrow \int_{C_1} f(x, y, z) \, ds = \int_0^1 \sqrt{2} (2t - 3t^2 + 3) \, dt = 3\sqrt{2}$;
- $\mathbf{r}_2 = \mathbf{i} + \mathbf{j} + t\mathbf{k} \Rightarrow x = 1, y = 1, z = t \Rightarrow f(g(t), h(t), k(t)) = 2 - 2t$ and $\frac{dx}{dt} = 0, \frac{dy}{dt} = 0, \frac{dz}{dt} = 1$
 $\Rightarrow \sqrt{\left(\frac{dx}{dt}\right)^2 + \left(\frac{dy}{dt}\right)^2 + \left(\frac{dz}{dt}\right)^2} dt = dt \Rightarrow \int_{C_2} f(x, y, z) \, ds = \int_0^1 (2 - 2t) \, dt = 1$
 $\Rightarrow \int_C f(x, y, z) \, ds = \int_{C_1} f(x, y, z) \, ds + \int_{C_2} f(x, y, z) \, ds = 3\sqrt{2} + 1$

2. Path 1: $\mathbf{r}_1 = t\mathbf{i} \Rightarrow x = t, y = 0, z = 0 \Rightarrow f(g(t), h(t), k(t)) = t^2$ and $\frac{dx}{dt} = 1, \frac{dy}{dt} = 0, \frac{dz}{dt} = 0$
 $\Rightarrow \sqrt{\left(\frac{dx}{dt}\right)^2 + \left(\frac{dy}{dt}\right)^2 + \left(\frac{dz}{dt}\right)^2} dt = dt \Rightarrow \int_{C_1} f(x, y, z) ds = \int_0^1 t^2 dt = \frac{1}{3};$
 Path 2: $\mathbf{r}_2 = \mathbf{i} + t\mathbf{j} \Rightarrow x = 1, y = t, z = 0 \Rightarrow f(g(t), h(t), k(t)) = 1 + t$ and $\frac{dx}{dt} = 0, \frac{dy}{dt} = 1, \frac{dz}{dt} = 0$
 $\Rightarrow \sqrt{\left(\frac{dx}{dt}\right)^2 + \left(\frac{dy}{dt}\right)^2 + \left(\frac{dz}{dt}\right)^2} dt = dt \Rightarrow \int_{C_2} f(x, y, z) ds = \int_0^1 (1 + t) dt = \frac{3}{2};$
 Path 3: $\mathbf{r}_3 = \mathbf{i} + \mathbf{j} + t\mathbf{k} \Rightarrow x = 1, y = 1, z = t \Rightarrow f(g(t), h(t), k(t)) = 2 - t$ and $\frac{dx}{dt} = 0, \frac{dy}{dt} = 0, \frac{dz}{dt} = 1$
 $\Rightarrow \sqrt{\left(\frac{dx}{dt}\right)^2 + \left(\frac{dy}{dt}\right)^2 + \left(\frac{dz}{dt}\right)^2} dt = dt \Rightarrow \int_{C_3} f(x, y, z) ds = \int_0^1 (2 - t) dt = \frac{3}{2}$
 $\Rightarrow \int_{\text{Path 1}} f(x, y, z) ds = \int_{C_1} f(x, y, z) ds + \int_{C_2} f(x, y, z) ds + \int_{C_3} f(x, y, z) ds = \frac{10}{3}$
 Path 2: $\mathbf{r}_4 = t\mathbf{i} + t\mathbf{j} \Rightarrow x = t, y = t, z = 0 \Rightarrow f(g(t), h(t), k(t)) = t^2 + t$ and $\frac{dx}{dt} = 1, \frac{dy}{dt} = 1, \frac{dz}{dt} = 0$
 $\Rightarrow \sqrt{\left(\frac{dx}{dt}\right)^2 + \left(\frac{dy}{dt}\right)^2 + \left(\frac{dz}{dt}\right)^2} dt = \sqrt{2} dt \Rightarrow \int_{C_4} f(x, y, z) ds = \int_0^1 \sqrt{2}(t^2 + t) dt = \frac{5}{6}\sqrt{2};$
 Path 3: $\mathbf{r}_5 = \mathbf{i} + \mathbf{j} + t\mathbf{k}$ (see above) $\Rightarrow \int_{C_5} f(x, y, z) ds = \frac{3}{2}$
 $\Rightarrow \int_{\text{Path 2}} f(x, y, z) ds = \int_{C_4} f(x, y, z) ds + \int_{C_5} f(x, y, z) ds = \frac{5}{6}\sqrt{2} + \frac{3}{2} = \frac{5\sqrt{2}+9}{6}$
 Path 3: $\mathbf{r}_6 = t\mathbf{k} \Rightarrow x = 0, y = 0, z = t, 0 \leq t \leq 1 \Rightarrow f(g(t), h(t), k(t)) = -t$ and $\frac{dx}{dt} = 0, \frac{dy}{dt} = 0, \frac{dz}{dt} = 1$
 $\Rightarrow \sqrt{\left(\frac{dx}{dt}\right)^2 + \left(\frac{dy}{dt}\right)^2 + \left(\frac{dz}{dt}\right)^2} dt = dt \Rightarrow \int_{C_6} f(x, y, z) ds = \int_0^1 -t dt = -\frac{1}{2};$
 Path 4: $\mathbf{r}_7 = t\mathbf{j} + \mathbf{k} \Rightarrow x = 0, y = t, z = 1, 0 \leq t \leq 1 \Rightarrow f(g(t), h(t), k(t)) = t - 1$ and $\frac{dx}{dt} = 0, \frac{dy}{dt} = 1, \frac{dz}{dt} = 0$
 $\Rightarrow \sqrt{\left(\frac{dx}{dt}\right)^2 + \left(\frac{dy}{dt}\right)^2 + \left(\frac{dz}{dt}\right)^2} dt = dt \Rightarrow \int_{C_7} f(x, y, z) ds = \int_0^1 (t - 1) dt = -\frac{1}{2};$
 Path 5: $\mathbf{r}_8 = t\mathbf{i} + \mathbf{j} + \mathbf{k} \Rightarrow x = t, y = 1, z = 1, 0 \leq t \leq 1 \Rightarrow f(g(t), h(t), k(t)) = t^2$ and $\frac{dx}{dt} = 1, \frac{dy}{dt} = 0, \frac{dz}{dt} = 0$
 $\Rightarrow \sqrt{\left(\frac{dx}{dt}\right)^2 + \left(\frac{dy}{dt}\right)^2 + \left(\frac{dz}{dt}\right)^2} dt = dt \Rightarrow \int_{C_8} f(x, y, z) ds = \int_0^1 t^2 dt = \frac{1}{3}$
 $\Rightarrow \int_{\text{Path 3}} f(x, y, z) ds = \int_{C_6} f(x, y, z) ds + \int_{C_7} f(x, y, z) ds + \int_{C_8} f(x, y, z) ds = -\frac{1}{2} - \frac{1}{2} + \frac{1}{3} = -\frac{2}{3}$
3. $\mathbf{r} = (a \cos t)\mathbf{j} + (a \sin t)\mathbf{k} \Rightarrow x = 0, y = a \cos t, z = a \sin t \Rightarrow f(g(t), h(t), k(t)) = \sqrt{a^2 \sin^2 t} = a |\sin t|$ and
 $\frac{dx}{dt} = 0, \frac{dy}{dt} = -a \sin t, \frac{dz}{dt} = a \cos t \Rightarrow \sqrt{\left(\frac{dx}{dt}\right)^2 + \left(\frac{dy}{dt}\right)^2 + \left(\frac{dz}{dt}\right)^2} dt = a dt$
 $\Rightarrow \int_C f(x, y, z) ds = \int_0^{2\pi} a^2 |\sin t| dt = \int_0^\pi a^2 \sin t dt + \int_\pi^{2\pi} -a^2 \sin t dt = 4a^2$
4. $\mathbf{r} = (\cos t + t \sin t)\mathbf{i} + (\sin t - t \cos t)\mathbf{j} \Rightarrow x = \cos t + t \sin t, y = \sin t - t \cos t, z = 0$
 $\Rightarrow f(g(t), h(t), k(t)) = \sqrt{(\cos t + t \sin t)^2 + (\sin t - t \cos t)^2} = \sqrt{1 + t^2}$ and $\frac{dx}{dt} = -\sin t + \sin t + t \cos t$
 $= t \cos t, \frac{dy}{dt} = \cos t - \cos t + t \sin t = t \sin t, \frac{dz}{dt} = 0 \Rightarrow \sqrt{\left(\frac{dx}{dt}\right)^2 + \left(\frac{dy}{dt}\right)^2 + \left(\frac{dz}{dt}\right)^2} dt$
 $= \sqrt{t^2 \cos^2 t + t^2 \sin^2 t} dt = |t| dt = t dt$ since $0 \leq t \leq \sqrt{3} \Rightarrow \int_C f(x, y, z) ds = \int_0^{\sqrt{3}} t \sqrt{1 + t^2} dt = \frac{7}{3}$
5. $\frac{\partial P}{\partial y} = -\frac{1}{2}(x + y + z)^{-3/2} = \frac{\partial N}{\partial z}, \frac{\partial M}{\partial z} = -\frac{1}{2}(x + y + z)^{-3/2} = \frac{\partial P}{\partial x}, \frac{\partial N}{\partial x} = -\frac{1}{2}(x + y + z)^{-3/2} = \frac{\partial M}{\partial y}$
 $\Rightarrow M dx + N dy + P dz$ is exact; $\frac{\partial f}{\partial x} = \frac{1}{\sqrt{x+y+z}} \Rightarrow f(x, y, z) = 2\sqrt{x+y+z} + g(y, z) \Rightarrow \frac{\partial f}{\partial y} = \frac{1}{\sqrt{x+y+z}} + \frac{\partial g}{\partial y}$
 $= \frac{1}{\sqrt{x+y+z}} \Rightarrow \frac{\partial g}{\partial y} = 0 \Rightarrow g(y, z) = h(z) \Rightarrow f(x, y, z) = 2\sqrt{x+y+z} + h(z) \Rightarrow \frac{\partial f}{\partial z} = \frac{1}{\sqrt{x+y+z}} + h'(z)$
 $= \frac{1}{\sqrt{x+y+z}} \Rightarrow h'(z) = 0 \Rightarrow h(z) = C \Rightarrow f(x, y, z) = 2\sqrt{x+y+z} + C \Rightarrow \int_{(-1,1,1)}^{(4,-3,0)} \frac{dx+dy+dz}{\sqrt{x+y+z}}$
 $= f(4, -3, 0) - f(-1, 1, 1) = 2\sqrt{1} - 2\sqrt{1} = 0$

1046 Chapter 16 Integration in Vector Fields

6. $\frac{\partial P}{\partial y} = -\frac{1}{2\sqrt{yz}} = \frac{\partial N}{\partial z}$, $\frac{\partial M}{\partial z} = 0 = \frac{\partial P}{\partial x}$, $\frac{\partial N}{\partial x} = 0 = \frac{\partial M}{\partial y} \Rightarrow M dx + N dy + P dz$ is exact; $\frac{\partial f}{\partial x} = 1 \Rightarrow f(x, y, z) = x + g(y, z) \Rightarrow \frac{\partial f}{\partial y} = \frac{\partial g}{\partial y} = -\sqrt{\frac{z}{y}} \Rightarrow g(y, z) = -2\sqrt{yz} + h(z) \Rightarrow f(x, y, z) = x - 2\sqrt{yz} + h(z) \Rightarrow \frac{\partial f}{\partial z} = -\sqrt{\frac{y}{z}} + h'(z) = -\sqrt{\frac{y}{z}} \Rightarrow h'(z) = 0 \Rightarrow h(z) = C \Rightarrow f(x, y, z) = x - 2\sqrt{yz} + C \Rightarrow \int_{(1,1,1)}^{(10,3,3)} dx - \sqrt{\frac{z}{y}} dy - \sqrt{\frac{y}{z}} dz = f(10, 3, 3) - f(1, 1, 1) = (10 - 2 \cdot 3) - (1 - 2 \cdot 1) = 4 + 1 = 5$
7. $\frac{\partial M}{\partial z} = -y \cos z \neq y \cos z = \frac{\partial P}{\partial x} \Rightarrow \mathbf{F}$ is not conservative; $\mathbf{r} = (2 \cos t)\mathbf{i} + (2 \sin t)\mathbf{j} - \mathbf{k}$, $0 \leq t \leq 2\pi \Rightarrow d\mathbf{r} = (-2 \sin t)\mathbf{i} - (2 \cos t)\mathbf{j} \Rightarrow \int_C \mathbf{F} \cdot d\mathbf{r} = \int_0^{2\pi} [-(-2 \sin t)(\sin(-1))(-2 \sin t) + (2 \cos t)(\sin(-1))(-2 \cos t)] dt = 4 \sin(1) \int_0^{2\pi} (\sin^2 t + \cos^2 t) dt = 8\pi \sin(1)$
8. $\frac{\partial P}{\partial y} = 0 = \frac{\partial N}{\partial z}$, $\frac{\partial M}{\partial z} = 0 = \frac{\partial P}{\partial x}$, $\frac{\partial N}{\partial x} = 3x^2 = \frac{\partial M}{\partial y} \Rightarrow \mathbf{F}$ is conservative $\Rightarrow \int_C \mathbf{F} \cdot d\mathbf{r} = 0$
9. Let $M = 8x \sin y$ and $N = -8y \cos x \Rightarrow \frac{\partial M}{\partial y} = 8x \cos y$ and $\frac{\partial N}{\partial x} = 8y \sin x \Rightarrow \int_C 8x \sin y dx - 8y \cos x dy = \iint_R (8y \sin x - 8x \cos y) dy dx = \int_0^{\pi/2} \int_0^{\pi/2} (8y \sin x - 8x \cos y) dy dx = \int_0^{\pi/2} (\pi^2 \sin x - 8x) dx = -\pi^2 + \pi^2 = 0$
10. Let $M = y^2$ and $N = x^2 \Rightarrow \frac{\partial M}{\partial y} = 2y$ and $\frac{\partial N}{\partial x} = 2x \Rightarrow \int_C y^2 dx + x^2 dy = \iint_R (2x - 2y) dx dy = \int_0^{2\pi} \int_0^2 (2r \cos \theta - 2r \sin \theta) r dr d\theta = \int_0^{2\pi} \frac{16}{3} (\cos \theta - \sin \theta) d\theta = 0$
11. Let $z = 1 - x - y \Rightarrow f_x(x, y) = -1$ and $f_y(x, y) = -1 \Rightarrow \sqrt{f_x^2 + f_y^2 + 1} = \sqrt{3} \Rightarrow \text{Surface Area} = \iint_R \sqrt{3} dx dy = \sqrt{3}(\text{Area of the circular region in the } xy\text{-plane}) = \pi\sqrt{3}$
12. $\nabla f = -3\mathbf{i} + 2y\mathbf{j} + 2z\mathbf{k}$, $\mathbf{p} = \mathbf{i} \Rightarrow |\nabla f| = \sqrt{9 + 4y^2 + 4z^2}$ and $|\nabla f \cdot \mathbf{p}| = 3 \Rightarrow \text{Surface Area} = \iint_R \frac{\sqrt{9 + 4y^2 + 4z^2}}{3} dy dz = \int_0^{2\pi} \int_0^{\sqrt{3}} \frac{\sqrt{9 + 4r^2}}{3} r dr d\theta = \frac{1}{3} \int_0^{2\pi} \left(\frac{7}{4} \sqrt{21} - \frac{9}{4} \right) d\theta = \frac{\pi}{6} (7\sqrt{21} - 9)$
13. $\nabla f = 2x\mathbf{i} + 2y\mathbf{j} + 2z\mathbf{k}$, $\mathbf{p} = \mathbf{k} \Rightarrow |\nabla f| = \sqrt{4x^2 + 4y^2 + 4z^2} = 2\sqrt{x^2 + y^2 + z^2} = 2$ and $|\nabla f \cdot \mathbf{p}| = |2z| = 2z$ since $z \geq 0 \Rightarrow \text{Surface Area} = \iint_R \frac{2}{2z} dA = \iint_R \frac{1}{z} dA = \iint_R \frac{1}{\sqrt{1-x^2-y^2}} dx dy = \int_0^{2\pi} \int_0^{1/\sqrt{2}} \frac{1}{\sqrt{1-r^2}} r dr d\theta = \int_0^{2\pi} \left[-\sqrt{1-r^2} \right]_0^{1/\sqrt{2}} d\theta = \int_0^{2\pi} \left(1 - \frac{1}{\sqrt{2}} \right) d\theta = 2\pi \left(1 - \frac{1}{\sqrt{2}} \right)$
14. (a) $\nabla f = 2x\mathbf{i} + 2y\mathbf{j} + 2z\mathbf{k}$, $\mathbf{p} = \mathbf{k} \Rightarrow |\nabla f| = \sqrt{4x^2 + 4y^2 + 4z^2} = 2\sqrt{x^2 + y^2 + z^2} = 4$ and $|\nabla f \cdot \mathbf{p}| = 2z$ since $z \geq 0 \Rightarrow \text{Surface Area} = \iint_R \frac{4}{2z} dA = \iint_R \frac{2}{z} dA = 2 \int_0^{\pi/2} \int_0^{2 \cos \theta} \frac{2}{\sqrt{4-r^2}} r dr d\theta = 4\pi - 8$
- (b) $\mathbf{r} = 2 \cos \theta \Rightarrow d\mathbf{r} = -2 \sin \theta d\theta$; $ds^2 = r^2 d\theta^2 + dr^2$ (Arc length in polar coordinates) $\Rightarrow ds^2 = (2 \cos \theta)^2 d\theta^2 + dr^2 = 4 \cos^2 \theta d\theta^2 + 4 \sin^2 \theta d\theta^2 = 4 d\theta^2 \Rightarrow ds = 2 d\theta$; the height of the cylinder is $z = \sqrt{4 - r^2} = \sqrt{4 - 4 \cos^2 \theta} = 2 |\sin \theta| = 2 \sin \theta$ if $0 \leq \theta \leq \frac{\pi}{2} \Rightarrow \text{Surface Area} = \int_{-\pi/2}^{\pi/2} h ds = 2 \int_0^{\pi/2} (2 \sin \theta)(2 d\theta) = 8$

15. $f(x, y, z) = \frac{x}{a} + \frac{y}{b} + \frac{z}{c} = 1 \Rightarrow \nabla f = \left(\frac{1}{a}\right)\mathbf{i} + \left(\frac{1}{b}\right)\mathbf{j} + \left(\frac{1}{c}\right)\mathbf{k} \Rightarrow |\nabla f| = \sqrt{\frac{1}{a^2} + \frac{1}{b^2} + \frac{1}{c^2}}$ and $\mathbf{p} = \mathbf{k} \Rightarrow |\nabla f \cdot \mathbf{p}| = \frac{1}{c}$
 since $c > 0 \Rightarrow$ Surface Area $= \iint_R \frac{\sqrt{\frac{1}{a^2} + \frac{1}{b^2} + \frac{1}{c^2}}}{\left(\frac{1}{c}\right)} dA = c\sqrt{\frac{1}{a^2} + \frac{1}{b^2} + \frac{1}{c^2}} \iint_R dA = \frac{1}{2}abc\sqrt{\frac{1}{a^2} + \frac{1}{b^2} + \frac{1}{c^2}}$,

since the area of the triangular region R is $\frac{1}{2}ab$. To check this result, let $\mathbf{v} = a\mathbf{i} + c\mathbf{k}$ and $\mathbf{w} = -a\mathbf{i} + b\mathbf{j}$; the area can be found by computing $\frac{1}{2}|\mathbf{v} \times \mathbf{w}|$.

16. (a) $\nabla f = 2y\mathbf{j} - \mathbf{k}$, $\mathbf{p} = \mathbf{k} \Rightarrow |\nabla f| = \sqrt{4y^2 + 1}$ and $|\nabla f \cdot \mathbf{p}| = 1 \Rightarrow d\sigma = \sqrt{4y^2 + 1} dx dy$
 $\Rightarrow \iint_S g(x, y, z) d\sigma = \iint_R \frac{yz}{\sqrt{4y^2 + 1}} \sqrt{4y^2 + 1} dx dy = \iint_R y(y^2 - 1) dx dy = \int_{-1}^1 \int_0^3 (y^3 - y) dx dy$
 $= \int_{-1}^1 3(y^3 - y) dy = 3 \left[\frac{y^4}{4} - \frac{y^2}{2} \right]_{-1}^1 = 0$

(b) $\iint_S g(x, y, z) d\sigma = \iint_R \frac{z}{\sqrt{4y^2 + 1}} \sqrt{4y^2 + 1} dx dy = \int_{-1}^1 \int_0^3 (y^2 - 1) dx dy = \int_{-1}^1 3(y^2 - 1) dy$
 $= 3 \left[\frac{y^3}{3} - y \right]_{-1}^1 = -4$

17. $\nabla f = 2y\mathbf{j} + 2z\mathbf{k}$, $\mathbf{p} = \mathbf{k} \Rightarrow |\nabla f| = \sqrt{4y^2 + 4z^2} = 2\sqrt{y^2 + z^2} = 10$ and $|\nabla f \cdot \mathbf{p}| = 2z$ since $z \geq 0$
 $\Rightarrow d\sigma = \frac{10}{2z} dx dy = \frac{5}{z} dx dy = \iint_S g(x, y, z) d\sigma = \iint_R (x^4 y) (y^2 + z^2) \left(\frac{5}{z}\right) dx dy$
 $= \iint_R (x^4 y) (25) \left(\frac{5}{\sqrt{25 - y^2}}\right) dx dy = \int_0^4 \int_0^1 \frac{125y}{\sqrt{25 - y^2}} x^4 dx dy = \int_0^4 \frac{25y}{\sqrt{25 - y^2}} dy = 50$

18. Define the coordinate system so that the origin is at the center of the earth, the z -axis is the earth's axis (north is the positive z direction), and the xz -plane contains the earth's prime meridian. Let S denote the surface which is Wyoming so then S is part of the surface $z = (R^2 - x^2 - y^2)^{1/2}$. Let R_{xy} be the projection of S onto the xy -plane. The surface area of Wyoming is $\iint_S 1 d\sigma = \iint_{R_{xy}} \sqrt{1 + \left(\frac{\partial z}{\partial x}\right)^2 + \left(\frac{\partial z}{\partial y}\right)^2} dA$

$$\iint_{R_{xy}} \sqrt{\frac{x^2}{R^2 - x^2 - y^2} + \frac{y^2}{R^2 - x^2 - y^2} + 1} dA = \iint_{R_{xy}} \frac{R}{(R^2 - x^2 - y^2)^{1/2}} dA = \int_{\theta_1}^{\theta_2} \int_{R \sin 45^\circ}^{R \sin 49^\circ} R (R^2 - r^2)^{-1/2} r dr d\theta$$

(where θ_1 and θ_2 are the radian equivalent to $104^\circ 3'$ and $111^\circ 3'$, respectively)

$$= \int_{\theta_1}^{\theta_2} -R (R^2 - r^2)^{1/2} \Big|_{R \sin 45^\circ}^{R \sin 49^\circ} = \int_{\theta_1}^{\theta_2} R (R^2 - R^2 \sin^2 45^\circ)^{1/2} - R (R^2 - R^2 \sin^2 49^\circ)^{1/2} d\theta$$

$$= (\theta_2 - \theta_1) R^2 (\cos 45^\circ - \cos 49^\circ) = \frac{7\pi}{180} R^2 (\cos 45^\circ - \cos 49^\circ) = \frac{7\pi}{180} (3959)^2 (\cos 45^\circ - \cos 49^\circ)$$

$$\approx 97,751 \text{ sq. mi.}$$

19. A possible parametrization is $\mathbf{r}(\phi, \theta) = (6 \sin \phi \cos \theta)\mathbf{i} + (6 \sin \phi \sin \theta)\mathbf{j} + (6 \cos \phi)\mathbf{k}$ (spherical coordinates);
 now $\rho = 6$ and $z = -3 \Rightarrow -3 = 6 \cos \phi \Rightarrow \cos \phi = -\frac{1}{2} \Rightarrow \phi = \frac{2\pi}{3}$ and $z = 3\sqrt{3} \Rightarrow 3\sqrt{3} = 6 \cos \phi$
 $\Rightarrow \cos \phi = \frac{\sqrt{3}}{2} \Rightarrow \phi = \frac{\pi}{6} \Rightarrow \frac{\pi}{6} \leq \phi \leq \frac{2\pi}{3}$; also $0 \leq \theta \leq 2\pi$

20. A possible parametrization is $\mathbf{r}(r, \theta) = (r \cos \theta)\mathbf{i} + (r \sin \theta)\mathbf{j} - \left(\frac{r^2}{2}\right)\mathbf{k}$ (cylindrical coordinates);
 now $r = \sqrt{x^2 + y^2} \Rightarrow z = -\frac{r^2}{2}$ and $-2 \leq z \leq 0 \Rightarrow -2 \leq -\frac{r^2}{2} \leq 0 \Rightarrow 4 \geq r^2 \geq 0 \Rightarrow 0 \leq r \leq 2$ since $r \geq 0$;
 also $0 \leq \theta \leq 2\pi$

21. A possible parametrization is $\mathbf{r}(r, \theta) = (r \cos \theta)\mathbf{i} + (r \sin \theta)\mathbf{j} + (1 + r)\mathbf{k}$ (cylindrical coordinates);
 now $r = \sqrt{x^2 + y^2} \Rightarrow z = 1 + r$ and $1 \leq z \leq 3 \Rightarrow 1 \leq 1 + r \leq 3 \Rightarrow 0 \leq r \leq 2$; also $0 \leq \theta \leq 2\pi$

22. A possible parametrization is $\mathbf{r}(x, y) = x\mathbf{i} + y\mathbf{j} + \left(3 - x - \frac{y}{2}\right)\mathbf{k}$ for $0 \leq x \leq 2$ and $0 \leq y \leq 2$

23. Let $x = u \cos v$ and $z = u \sin v$, where $u = \sqrt{x^2 + z^2}$ and v is the angle in the xz -plane with the x -axis
 $\Rightarrow \mathbf{r}(u, v) = (u \cos v)\mathbf{i} + 2u^2\mathbf{j} + (u \sin v)\mathbf{k}$ is a possible parametrization; $0 \leq y \leq 2 \Rightarrow 2u^2 \leq 2 \Rightarrow u^2 \leq 1$
 $\Rightarrow 0 \leq u \leq 1$ since $u \geq 0$; also, for just the upper half of the paraboloid, $0 \leq v \leq \pi$

24. A possible parametrization is $(\sqrt{10} \sin \phi \cos \theta)\mathbf{i} + (\sqrt{10} \sin \phi \sin \theta)\mathbf{j} + (\sqrt{10} \cos \phi)\mathbf{k}$, $0 \leq \phi \leq \frac{\pi}{2}$ and $0 \leq \theta \leq \frac{\pi}{2}$

25. $\mathbf{r}_u = \mathbf{i} + \mathbf{j}$, $\mathbf{r}_v = \mathbf{i} - \mathbf{j} + \mathbf{k} \Rightarrow \mathbf{r}_u \times \mathbf{r}_v = \begin{vmatrix} \mathbf{i} & \mathbf{j} & \mathbf{k} \\ 1 & 1 & 0 \\ 1 & -1 & 1 \end{vmatrix} = \mathbf{i} - \mathbf{j} - 2\mathbf{k} \Rightarrow |\mathbf{r}_u \times \mathbf{r}_v| = \sqrt{6}$
 $\Rightarrow \text{Surface Area} = \iint_{R_{uv}} |\mathbf{r}_u \times \mathbf{r}_v| \, du \, dv = \int_0^1 \int_0^1 \sqrt{6} \, du \, dv = \sqrt{6}$

26. $\iint_S (xy - z^2) \, d\sigma = \int_0^1 \int_0^1 [(u+v)(u-v) - v^2] \sqrt{6} \, du \, dv = \sqrt{6} \int_0^1 \int_0^1 (u^2 - 2v^2) \, du \, dv$
 $= \sqrt{6} \int_0^1 \left[\frac{u^3}{3} - 2uv^2 \right]_0^1 \, dv = \sqrt{6} \int_0^1 \left(\frac{1}{3} - 2v^2 \right) \, dv = \sqrt{6} \left[\frac{1}{3}v - \frac{2}{3}v^3 \right]_0^1 = -\frac{\sqrt{6}}{3} = -\sqrt{\frac{2}{3}}$

27. $\mathbf{r}_r = (\cos \theta)\mathbf{i} + (\sin \theta)\mathbf{j}$, $\mathbf{r}_\theta = (-r \sin \theta)\mathbf{i} + (r \cos \theta)\mathbf{j} + \mathbf{k} \Rightarrow \mathbf{r}_r \times \mathbf{r}_\theta = \begin{vmatrix} \mathbf{i} & \mathbf{j} & \mathbf{k} \\ \cos \theta & \sin \theta & 0 \\ -r \sin \theta & r \cos \theta & 1 \end{vmatrix}$
 $= (\sin \theta)\mathbf{i} - (\cos \theta)\mathbf{j} + r\mathbf{k} \Rightarrow |\mathbf{r}_r \times \mathbf{r}_\theta| = \sqrt{\sin^2 \theta + \cos^2 \theta + r^2} = \sqrt{1 + r^2} \Rightarrow \text{Surface Area} = \iint_{R_{r\theta}} |\mathbf{r}_r \times \mathbf{r}_\theta| \, dr \, d\theta$
 $= \int_0^{2\pi} \int_0^1 \sqrt{1 + r^2} \, dr \, d\theta = \int_0^{2\pi} \left[\frac{r}{2} \sqrt{1 + r^2} + \frac{1}{2} \ln \left(r + \sqrt{1 + r^2} \right) \right]_0^1 \, d\theta = \int_0^{2\pi} \left[\frac{1}{2} \sqrt{2} + \frac{1}{2} \ln \left(1 + \sqrt{2} \right) \right] \, d\theta$
 $= \pi \left[\sqrt{2} + \ln \left(1 + \sqrt{2} \right) \right]$

28. $\iint_S \sqrt{x^2 + y^2 + 1} \, d\sigma = \int_0^{2\pi} \int_0^1 \sqrt{r^2 \cos^2 \theta + r^2 \sin^2 \theta + 1} \sqrt{1 + r^2} \, dr \, d\theta = \int_0^{2\pi} \int_0^1 (1 + r^2) \, dr \, d\theta$
 $= \int_0^{2\pi} \left[r + \frac{r^3}{3} \right]_0^1 \, d\theta = \int_0^{2\pi} \frac{4}{3} \, d\theta = \frac{8}{3} \pi$

29. $\frac{\partial P}{\partial y} = 0 = \frac{\partial N}{\partial z}$, $\frac{\partial M}{\partial z} = 0 = \frac{\partial P}{\partial x}$, $\frac{\partial N}{\partial x} = 0 = \frac{\partial M}{\partial y} \Rightarrow \text{Conservative}$

30. $\frac{\partial P}{\partial y} = \frac{-3zy}{(x^2 + y^2 + z^2)^{-5/2}} = \frac{\partial N}{\partial z}$, $\frac{\partial M}{\partial z} = \frac{-3xz}{(x^2 + y^2 + z^2)^{-5/2}} = \frac{\partial P}{\partial x}$, $\frac{\partial N}{\partial x} = \frac{-3xy}{(x^2 + y^2 + z^2)^{-5/2}} = \frac{\partial M}{\partial y} \Rightarrow \text{Conservative}$

31. $\frac{\partial P}{\partial y} = 0 \neq ye^z = \frac{\partial N}{\partial z} \Rightarrow \text{Not Conservative}$

32. $\frac{\partial P}{\partial y} = \frac{x}{(x+yz)^2} = \frac{\partial N}{\partial z}$, $\frac{\partial M}{\partial z} = \frac{-y}{(x+yz)^2} = \frac{\partial P}{\partial x}$, $\frac{\partial N}{\partial x} = \frac{-z}{(x+yz)^2} = \frac{\partial M}{\partial y} \Rightarrow \text{Conservative}$

33. $\frac{\partial f}{\partial x} = 2 \Rightarrow f(x, y, z) = 2x + g(y, z) \Rightarrow \frac{\partial f}{\partial y} = \frac{\partial g}{\partial y} = 2y + z \Rightarrow g(y, z) = y^2 + zy + h(z)$
 $\Rightarrow f(x, y, z) = 2x + y^2 + zy + h(z) \Rightarrow \frac{\partial f}{\partial z} = y + h'(z) = y + 1 \Rightarrow h'(z) = 1 \Rightarrow h(z) = z + C$
 $\Rightarrow f(x, y, z) = 2x + y^2 + zy + z + C$

34. $\frac{\partial f}{\partial x} = z \cos xz \Rightarrow f(x, y, z) = \sin xz + g(y, z) \Rightarrow \frac{\partial f}{\partial y} = \frac{\partial g}{\partial y} = e^y \Rightarrow g(y, z) = e^y + h(z)$
 $\Rightarrow f(x, y, z) = \sin xz + e^y + h(z) \Rightarrow \frac{\partial f}{\partial z} = x \cos xz + h'(z) = x \cos xz \Rightarrow h'(z) = 0 \Rightarrow h(z) = C$
 $\Rightarrow f(x, y, z) = \sin xz + e^y + C$

35. Over Path 1: $\mathbf{r} = t\mathbf{i} + t\mathbf{j} + t\mathbf{k}$, $0 \leq t \leq 1 \Rightarrow x = t, y = t, z = t$ and $d\mathbf{r} = (\mathbf{i} + \mathbf{j} + \mathbf{k}) dt \Rightarrow \mathbf{F} = 2t^2\mathbf{i} + \mathbf{j} + t^2\mathbf{k}$
 $\Rightarrow \mathbf{F} \cdot d\mathbf{r} = (3t^2 + 1) dt \Rightarrow \text{Work} = \int_0^1 (3t^2 + 1) dt = 2;$

Over Path 2: $\mathbf{r}_1 = t\mathbf{i} + t\mathbf{j}$, $0 \leq t \leq 1 \Rightarrow x = t, y = t, z = 0$ and $d\mathbf{r}_1 = (\mathbf{i} + \mathbf{j}) dt \Rightarrow \mathbf{F}_1 = 2t^2\mathbf{i} + \mathbf{j} + t^2\mathbf{k}$

$\Rightarrow \mathbf{F}_1 \cdot d\mathbf{r}_1 = (2t^2 + 1) dt \Rightarrow \text{Work}_1 = \int_0^1 (2t^2 + 1) dt = \frac{5}{3}; \mathbf{r}_2 = \mathbf{i} + \mathbf{j} + t\mathbf{k}$, $0 \leq t \leq 1 \Rightarrow x = 1, y = 1, z = t$ and
 $d\mathbf{r}_2 = \mathbf{k} dt \Rightarrow \mathbf{F}_2 = 2\mathbf{i} + \mathbf{j} + \mathbf{k} \Rightarrow \mathbf{F}_2 \cdot d\mathbf{r}_2 = dt \Rightarrow \text{Work}_2 = \int_0^1 dt = 1 \Rightarrow \text{Work} = \text{Work}_1 + \text{Work}_2 = \frac{5}{3} + 1 = \frac{8}{3}$

36. Over Path 1: $\mathbf{r} = t\mathbf{i} + t\mathbf{j} + t\mathbf{k}$, $0 \leq t \leq 1 \Rightarrow x = t, y = t, z = t$ and $d\mathbf{r} = (\mathbf{i} + \mathbf{j} + \mathbf{k}) dt \Rightarrow \mathbf{F} = 2t^2\mathbf{i} + t^2\mathbf{j} + \mathbf{k}$
 $\Rightarrow \mathbf{F} \cdot d\mathbf{r} = (3t^2 + 1) dt \Rightarrow \text{Work} = \int_0^1 (3t^2 + 1) dt = 2;$

Over Path 2: Since f is conservative, $\oint_C \mathbf{F} \cdot d\mathbf{r} = 0$ around any simple closed curve C . Thus consider

$\int_{\text{curve}} \mathbf{F} \cdot d\mathbf{r} = \int_{C_1} \mathbf{F} \cdot d\mathbf{r} + \int_{C_2} \mathbf{F} \cdot d\mathbf{r}$, where C_1 is the path from $(0, 0, 0)$ to $(1, 1, 0)$ to $(1, 1, 1)$ and C_2 is the path from $(1, 1, 1)$ to $(0, 0, 0)$. Now, from Path 1 above, $\int_{C_2} \mathbf{F} \cdot d\mathbf{r} = -2 \Rightarrow 0 = \int_{\text{curve}} \mathbf{F} \cdot d\mathbf{r} = \int_{C_1} \mathbf{F} \cdot d\mathbf{r} + (-2)$
 $\Rightarrow \int_{C_1} \mathbf{F} \cdot d\mathbf{r} = 2$

37. (a) $\mathbf{r} = (e^t \cos t)\mathbf{i} + (e^t \sin t)\mathbf{j} \Rightarrow x = e^t \cos t, y = e^t \sin t$ from $(1, 0)$ to $(e^{2\pi}, 0) \Rightarrow 0 \leq t \leq 2\pi$
 $\Rightarrow \frac{d\mathbf{r}}{dt} = (e^t \cos t - e^t \sin t)\mathbf{i} + (e^t \sin t + e^t \cos t)\mathbf{j}$ and $\mathbf{F} = \frac{x\mathbf{i} + y\mathbf{j}}{(x^2 + y^2)^{3/2}} = \frac{(e^t \cos t)\mathbf{i} + (e^t \sin t)\mathbf{j}}{(e^{2t} \cos^2 t + e^{2t} \sin^2 t)^{3/2}}$

$= \left(\frac{\cos t}{e^{2t}}\right)\mathbf{i} + \left(\frac{\sin t}{e^{2t}}\right)\mathbf{j} \Rightarrow \mathbf{F} \cdot \frac{d\mathbf{r}}{dt} = \left(\frac{\cos^2 t}{e^t} - \frac{\sin t \cos t}{e^t} + \frac{\sin^2 t}{e^t} + \frac{\sin t \cos t}{e^t}\right) = e^{-t}$

$\Rightarrow \text{Work} = \int_0^{2\pi} e^{-t} dt = 1 - e^{-2\pi}$

(b) $\mathbf{F} = \frac{x\mathbf{i} + y\mathbf{j}}{(x^2 + y^2)^{3/2}} \Rightarrow \frac{\partial f}{\partial x} = \frac{x}{(x^2 + y^2)^{3/2}} \Rightarrow f(x, y, z) = -(x^2 + y^2)^{-1/2} + g(y, z) \Rightarrow \frac{\partial f}{\partial y} = \frac{y}{(x^2 + y^2)^{3/2}} + \frac{\partial g}{\partial y}$
 $= \frac{y}{(x^2 + y^2)^{3/2}} \Rightarrow g(y, z) = C \Rightarrow f(x, y, z) = -(x^2 + y^2)^{-1/2}$ is a potential function for $\mathbf{F} \Rightarrow \int_C \mathbf{F} \cdot d\mathbf{r} = f(e^{2\pi}, 0) - f(1, 0) = 1 - e^{-2\pi}$

38. (a) $\mathbf{F} = \nabla(x^2ze^y) \Rightarrow \mathbf{F}$ is conservative $\Rightarrow \oint_C \mathbf{F} \cdot d\mathbf{r} = 0$ for any closed path C

(b) $\int_C \mathbf{F} \cdot d\mathbf{r} = \int_{(1,0,0)}^{(1,0,2\pi)} \nabla(x^2ze^y) \cdot d\mathbf{r} = (x^2ze^y)|_{(1,0,2\pi)} - (x^2ze^y)|_{(1,0,0)} = 2\pi - 0 = 2\pi$

39. $\nabla \times \mathbf{F} = \begin{vmatrix} \mathbf{i} & \mathbf{j} & \mathbf{k} \\ \frac{\partial}{\partial x} & \frac{\partial}{\partial y} & \frac{\partial}{\partial z} \\ y^2 & -y & 3z^2 \end{vmatrix} = -2y\mathbf{k}$; unit normal to the plane is $\mathbf{n} = \frac{2\mathbf{i} + 6\mathbf{j} - 3\mathbf{k}}{\sqrt{4 + 36 + 9}} = \frac{2}{7}\mathbf{i} + \frac{6}{7}\mathbf{j} - \frac{3}{7}\mathbf{k}$

$\Rightarrow \nabla \times \mathbf{F} \cdot \mathbf{n} = \frac{6}{7}y$; $\mathbf{p} = \mathbf{k}$ and $f(x, y, z) = 2x + 6y - 3z \Rightarrow |\nabla f \cdot \mathbf{p}| = 3 \Rightarrow d\sigma = \frac{|\nabla f|}{|\nabla f \cdot \mathbf{p}|} dA = \frac{7}{3} dA$

$\Rightarrow \oint_C \mathbf{F} \cdot d\mathbf{r} = \iint_R \frac{6}{7}y d\sigma = \iint_R \left(\frac{6}{7}y\right) \left(\frac{7}{3} dA\right) = \iint_R 2y dA = \int_0^{2\pi} \int_0^1 2r \sin \theta r dr d\theta = \int_0^{2\pi} \frac{2}{3} \sin \theta d\theta = 0$

40. $\nabla \times \mathbf{F} = \begin{vmatrix} \mathbf{i} & \mathbf{j} & \mathbf{k} \\ \frac{\partial}{\partial x} & \frac{\partial}{\partial y} & \frac{\partial}{\partial z} \\ x^2 + y & x + y & 4y^2 - z \end{vmatrix} = 8y\mathbf{i}$; the circle lies in the plane $f(x, y, z) = y + z = 0$ with unit normal

$\mathbf{n} = \frac{1}{\sqrt{2}}\mathbf{j} + \frac{1}{\sqrt{2}}\mathbf{k} \Rightarrow \nabla \times \mathbf{F} \cdot \mathbf{n} = 0 \Rightarrow \oint_C \mathbf{F} \cdot d\mathbf{r} = \iint_R \nabla \times \mathbf{F} \cdot \mathbf{n} d\sigma = \iint_R 0 d\sigma = 0$

41. (a) $\mathbf{r} = \sqrt{2}t\mathbf{i} + \sqrt{2}t\mathbf{j} + (4 - t^2)\mathbf{k}$, $0 \leq t \leq 1 \Rightarrow x = \sqrt{2}t, y = \sqrt{2}t, z = 4 - t^2 \Rightarrow \frac{dx}{dt} = \sqrt{2}, \frac{dy}{dt} = \sqrt{2}, \frac{dz}{dt} = -2t$
 $\Rightarrow \sqrt{\left(\frac{dx}{dt}\right)^2 + \left(\frac{dy}{dt}\right)^2 + \left(\frac{dz}{dt}\right)^2} dt = \sqrt{4 + 4t^2} dt \Rightarrow M = \int_C \delta(x, y, z) ds = \int_0^1 3t\sqrt{4 + 4t^2} dt = \left[\frac{1}{4}(4 + 4t)^{3/2}\right]_0^1$
 $= 4\sqrt{2} - 2$

$$(b) M = \int_C \delta(x, y, z) ds = \int_0^1 \sqrt{4 + 4t^2} dt = \left[t\sqrt{1 + t^2} + \ln(t + \sqrt{1 + t^2}) \right]_0^1 = \sqrt{2} + \ln(1 + \sqrt{2})$$

$$42. \mathbf{r} = t\mathbf{i} + 2t\mathbf{j} + \frac{2}{3}t^{3/2}\mathbf{k}, 0 \leq t \leq 2 \Rightarrow x = t, y = 2t, z = \frac{2}{3}t^{3/2} \Rightarrow \frac{dx}{dt} = 1, \frac{dy}{dt} = 2, \frac{dz}{dt} = t^{1/2}$$

$$\Rightarrow \sqrt{\left(\frac{dx}{dt}\right)^2 + \left(\frac{dy}{dt}\right)^2 + \left(\frac{dz}{dt}\right)^2} dt = \sqrt{t+5} dt \Rightarrow M = \int_C \delta(x, y, z) ds = \int_0^2 3\sqrt{5+t} \sqrt{t+5} dt$$

$$= \int_0^2 3(t+5) dt = 36; M_{yz} = \int_C x\delta ds = \int_0^2 3t(t+5) dt = 38; M_{xz} = \int_C y\delta ds = \int_0^2 6t(t+5) dt = 76;$$

$$M_{xy} = \int_C z\delta ds = \int_0^2 2t^{3/2}(t+5) dt = \frac{144}{7}\sqrt{2} \Rightarrow \bar{x} = \frac{M_{yz}}{M} = \frac{38}{36} = \frac{19}{18}, \bar{y} = \frac{M_{xz}}{M} = \frac{76}{36} = \frac{19}{9}, \bar{z} = \frac{M_{xy}}{M} = \frac{\left(\frac{144}{7}\sqrt{2}\right)}{36}$$

$$= \frac{4}{7}\sqrt{2}$$

$$43. \mathbf{r} = t\mathbf{i} + \left(\frac{2\sqrt{2}}{3}t^{3/2}\right)\mathbf{j} + \left(\frac{t^2}{2}\right)\mathbf{k}, 0 \leq t \leq 2 \Rightarrow x = t, y = \frac{2\sqrt{2}}{3}t^{3/2}, z = \frac{t^2}{2} \Rightarrow \frac{dx}{dt} = 1, \frac{dy}{dt} = \sqrt{2}t^{1/2}, \frac{dz}{dt} = t$$

$$\Rightarrow \sqrt{\left(\frac{dx}{dt}\right)^2 + \left(\frac{dy}{dt}\right)^2 + \left(\frac{dz}{dt}\right)^2} dt = \sqrt{1 + 2t + t^2} dt = \sqrt{(t+1)^2} dt = |t+1| dt = (t+1) dt \text{ on the domain given.}$$

Then $M = \int_C \delta ds = \int_0^2 \left(\frac{1}{t+1}\right)(t+1) dt = \int_0^2 dt = 2; M_{yz} = \int_C x\delta ds = \int_0^2 t\left(\frac{1}{t+1}\right)(t+1) dt = \int_0^2 t dt = 2;$

$$M_{xz} = \int_C y\delta ds = \int_0^2 \left(\frac{2\sqrt{2}}{3}t^{3/2}\right)\left(\frac{1}{t+1}\right)(t+1) dt = \int_0^2 \frac{2\sqrt{2}}{3}t^{3/2} dt = \frac{32}{15}; M_{xy} = \int_C z\delta ds$$

$$= \int_0^2 \left(\frac{t^2}{2}\right)\left(\frac{1}{t+1}\right)(t+1) dt = \int_0^2 \frac{t^2}{2} dt = \frac{4}{3} \Rightarrow \bar{x} = \frac{M_{yz}}{M} = \frac{2}{2} = 1; \bar{y} = \frac{M_{xz}}{M} = \frac{\left(\frac{32}{15}\right)}{2} = \frac{16}{15}; \bar{z} = \frac{M_{xy}}{M}$$

$$= \frac{\left(\frac{4}{3}\right)}{2} = \frac{2}{3}; I_x = \int_C (y^2 + z^2)\delta ds = \int_0^2 \left(\frac{8}{9}t^3 + \frac{t^4}{4}\right) dt = \frac{232}{45}; I_y = \int_C (x^2 + z^2)\delta ds = \int_0^2 \left(t^2 + \frac{t^4}{4}\right) dt = \frac{64}{15};$$

$$I_z = \int_C (y^2 + x^2)\delta ds = \int_0^2 \left(t^2 + \frac{8}{9}t^3\right) dt = \frac{56}{9}; R_x = \sqrt{\frac{I_x}{M}} = \sqrt{\frac{\left(\frac{232}{45}\right)}{2}} = \frac{2\sqrt{29}}{3\sqrt{5}}; R_y = \sqrt{\frac{I_y}{M}} = \sqrt{\frac{\left(\frac{64}{15}\right)}{2}} = \frac{4\sqrt{2}}{\sqrt{15}};$$

$$R_z = \sqrt{\frac{I_z}{M}} = \sqrt{\frac{\left(\frac{56}{9}\right)}{2}} = \frac{2\sqrt{7}}{3}$$

44. $\bar{z} = 0$ because the arch is in the xy -plane, and $\bar{x} = 0$ because the mass is distributed symmetrically with respect

to the y -axis; $\mathbf{r}(t) = (a \cos t)\mathbf{i} + (a \sin t)\mathbf{j}, 0 \leq t \leq \pi \Rightarrow ds = \sqrt{\left(\frac{dx}{dt}\right)^2 + \left(\frac{dy}{dt}\right)^2 + \left(\frac{dz}{dt}\right)^2} dt$

$$= \sqrt{(-a \sin t)^2 + (a \cos t)^2} dt = a dt, \text{ since } a \geq 0; M = \int_C \delta ds = \int_C (2a - y) ds = \int_0^\pi (2a - a \sin t) a dt$$

$$= 2a^2\pi - 2a^2; M_{xz} = \int_C y\delta dt = \int_C y(2a - y) ds = \int_0^\pi (a \sin t)(2a - a \sin t) dt = \int_0^\pi (2a^2 \sin t - a^2 \sin^2 t) dt$$

$$= \left[-2a^2 \cos t - a^2 \left(\frac{t}{2} - \frac{\sin 2t}{4}\right)\right]_0^\pi = 4a^2 - \frac{a^2\pi}{2} \Rightarrow \bar{y} = \frac{\left(4a^2 - \frac{a^2\pi}{2}\right)}{2a^2\pi - 2a^2} = \frac{8 - \pi}{4\pi - 4} \Rightarrow (\bar{x}, \bar{y}, \bar{z}) = \left(0, \frac{8 - \pi}{4\pi - 4}, 0\right)$$

$$45. \mathbf{r}(t) = (e^t \cos t)\mathbf{i} + (e^t \sin t)\mathbf{j} + e^t\mathbf{k}, 0 \leq t \leq \ln 2 \Rightarrow x = e^t \cos t, y = e^t \sin t, z = e^t \Rightarrow \frac{dx}{dt} = (e^t \cos t - e^t \sin t),$$

$$\frac{dy}{dt} = (e^t \sin t + e^t \cos t), \frac{dz}{dt} = e^t \Rightarrow \sqrt{\left(\frac{dx}{dt}\right)^2 + \left(\frac{dy}{dt}\right)^2 + \left(\frac{dz}{dt}\right)^2} dt$$

$$= \sqrt{(e^t \cos t - e^t \sin t)^2 + (e^t \sin t + e^t \cos t)^2 + (e^t)^2} dt = \sqrt{3e^{2t}} dt = \sqrt{3} e^t dt; M = \int_C \delta ds = \int_0^{\ln 2} \sqrt{3} e^t dt$$

$$= \sqrt{3}; M_{xy} = \int_C z\delta ds = \int_0^{\ln 2} (\sqrt{3} e^t)(e^t) dt = \int_0^{\ln 2} \sqrt{3} e^{2t} dt = \frac{3\sqrt{3}}{2} \Rightarrow \bar{z} = \frac{M_{xy}}{M} = \frac{\left(\frac{3\sqrt{3}}{2}\right)}{\sqrt{3}} = \frac{3}{2};$$

$$I_z = \int_C (x^2 + y^2)\delta ds = \int_0^{\ln 2} (e^{2t} \cos^2 t + e^{2t} \sin^2 t)(\sqrt{3} e^t) dt = \int_0^{\ln 2} \sqrt{3} e^{3t} dt = \frac{7\sqrt{3}}{3} \Rightarrow R_z = \sqrt{\frac{I_z}{M}}$$

$$= \sqrt{\frac{7\sqrt{3}}{3\sqrt{3}}} = \sqrt{\frac{7}{3}}$$

$$46. \mathbf{r}(t) = (2 \sin t)\mathbf{i} + (2 \cos t)\mathbf{j} + 3t\mathbf{k}, 0 \leq t \leq 2\pi \Rightarrow x = 2 \sin t, y = 2 \cos t, z = 3t \Rightarrow \frac{dx}{dt} = 2 \cos t, \frac{dy}{dt} = -2 \sin t,$$

$$\frac{dz}{dt} = 3 \Rightarrow \sqrt{\left(\frac{dx}{dt}\right)^2 + \left(\frac{dy}{dt}\right)^2 + \left(\frac{dz}{dt}\right)^2} dt = \sqrt{4 + 9} dt = \sqrt{13} dt; M = \int_C \delta ds = \int_0^{2\pi} \delta \sqrt{13} dt = 2\pi\delta\sqrt{13};$$

$$M_{xy} = \int_C z \delta \, ds = \int_0^{2\pi} (3t) (\delta \sqrt{13}) \, dt = 6\delta\pi^2 \sqrt{13}; M_{yz} = \int_C x \delta \, ds = \int_0^{2\pi} (2 \sin t) (\delta \sqrt{13}) \, dt = 0;$$

$$M_{xz} = \int_C y \delta \, ds = \int_0^{2\pi} (2 \cos t) (\delta \sqrt{13}) \, dt = 0 \Rightarrow \bar{x} = \bar{y} = 0 \text{ and } \bar{z} = \frac{M_{xy}}{M} = \frac{6\delta\pi^2 \sqrt{13}}{2\delta\pi \sqrt{13}} = 3\pi \Rightarrow (0, 0, 3\pi) \text{ is the center of mass}$$

47. Because of symmetry $\bar{x} = \bar{y} = 0$. Let $f(x, y, z) = x^2 + y^2 + z^2 = 25 \Rightarrow \nabla f = 2x\mathbf{i} + 2y\mathbf{j} + 2z\mathbf{k}$
 $\Rightarrow |\nabla f| = \sqrt{4x^2 + 4y^2 + 4z^2} = 10$ and $\mathbf{p} = \mathbf{k} \Rightarrow |\nabla f \cdot \mathbf{p}| = 2z$, since $z \geq 0 \Rightarrow M = \iint_R \delta(x, y, z) \, d\sigma$
 $= \iint_R z \left(\frac{10}{2z}\right) \, dA = \iint_R 5 \, dA = 5(\text{Area of the circular region}) = 80\pi; M_{xy} = \iint_R z \delta \, d\sigma = \iint_R 5z \, dA$
 $= \iint_R 5\sqrt{25 - x^2 - y^2} \, dx \, dy = \int_0^{2\pi} \int_0^4 (5\sqrt{25 - r^2}) \, r \, dr \, d\theta = \int_0^{2\pi} \frac{490}{3} \, d\theta = \frac{980}{3} \pi \Rightarrow \bar{z} = \frac{\left(\frac{980}{3}\pi\right)}{80\pi} = \frac{49}{12}$
 $\Rightarrow (\bar{x}, \bar{y}, \bar{z}) = (0, 0, \frac{49}{12}); I_z = \iint_R (x^2 + y^2) \delta \, d\sigma = \iint_R 5(x^2 + y^2) \, dx \, dy = \int_0^{2\pi} \int_0^4 5r^3 \, dr \, d\theta = \int_0^{2\pi} 320 \, d\theta = 640\pi;$
 $R_z = \sqrt{\frac{I_z}{M}} = \sqrt{\frac{640\pi}{80\pi}} = 2\sqrt{2}$

48. On the face $z = 1$: $g(x, y, z) = z = 1$ and $\mathbf{p} = \mathbf{k} \Rightarrow \nabla g = \mathbf{k} \Rightarrow |\nabla g| = 1$ and $|\nabla g \cdot \mathbf{p}| = 1 \Rightarrow d\sigma = dA$
 $\Rightarrow I = \iint_R (x^2 + y^2) \, dA = 2 \int_0^{\pi/4} \int_0^{\sec \theta} r^3 \, dr \, d\theta = \frac{2}{3};$ On the face $z = 0$: $g(x, y, z) = z = 0 \Rightarrow \nabla g = \mathbf{k}$ and $\mathbf{p} = \mathbf{k}$
 $\Rightarrow |\nabla g| = 1 \Rightarrow |\nabla g \cdot \mathbf{p}| = 1 \Rightarrow d\sigma = dA \Rightarrow I = \iint_R (x^2 + y^2) \, dA = \frac{2}{3};$ On the face $y = 0$: $g(x, y, z) = y = 0$
 $\Rightarrow \nabla g = \mathbf{j}$ and $\mathbf{p} = \mathbf{j} \Rightarrow |\nabla g| = 1 \Rightarrow |\nabla g \cdot \mathbf{p}| = 1 \Rightarrow d\sigma = dA \Rightarrow I = \iint_R (x^2 + 0) \, dA = \int_0^1 \int_0^1 x^2 \, dx \, dz = \frac{1}{3};$
On the face $y = 1$: $g(x, y, z) = y = 1 \Rightarrow \nabla g = \mathbf{j}$ and $\mathbf{p} = \mathbf{j} \Rightarrow |\nabla g| = 1 \Rightarrow |\nabla g \cdot \mathbf{p}| = 1 \Rightarrow d\sigma = dA$
 $\Rightarrow I = \iint_R (x^2 + 1^2) \, dA = \int_0^1 \int_0^1 (x^2 + 1) \, dx \, dz = \frac{4}{3};$ On the face $x = 1$: $g(x, y, z) = x = 1 \Rightarrow \nabla g = \mathbf{i}$ and $\mathbf{p} = \mathbf{i}$
 $\Rightarrow |\nabla g| = 1 \Rightarrow |\nabla g \cdot \mathbf{p}| = 1 \Rightarrow d\sigma = dA \Rightarrow I = \iint_R (1^2 + y^2) \, dA = \int_0^1 \int_0^1 (1 + y^2) \, dy \, dz = \frac{4}{3};$ On the face
 $x = 0$: $g(x, y, z) = x = 0 \Rightarrow \nabla g = \mathbf{i}$ and $\mathbf{p} = \mathbf{i} \Rightarrow |\nabla g| = 1 \Rightarrow |\nabla g \cdot \mathbf{p}| = 1 \Rightarrow d\sigma = dA$
 $\Rightarrow I = \iint_R (0^2 + y^2) \, dA = \int_0^1 \int_0^1 y^2 \, dy \, dz = \frac{1}{3} \Rightarrow I_z = \frac{2}{3} + \frac{2}{3} + \frac{1}{3} + \frac{4}{3} + \frac{4}{3} + \frac{1}{3} = \frac{14}{3}$

49. $M = 2xy + x$ and $N = xy - y \Rightarrow \frac{\partial M}{\partial x} = 2y + 1, \frac{\partial M}{\partial y} = 2x, \frac{\partial N}{\partial x} = y, \frac{\partial N}{\partial y} = x - 1 \Rightarrow \text{Flux} = \iint_R \left(\frac{\partial M}{\partial x} + \frac{\partial N}{\partial y}\right) \, dx \, dy$
 $= \iint_R (2y + 1 + x - 1) \, dy \, dx = \int_0^1 \int_0^1 (2y + x) \, dy \, dx = \frac{3}{2}; \text{Circ} = \iint_R \left(\frac{\partial N}{\partial x} - \frac{\partial M}{\partial y}\right) \, dx \, dy$
 $= \iint_R (y - 2x) \, dy \, dx = \int_0^1 \int_0^1 (y - 2x) \, dy \, dx = -\frac{1}{2}$

50. $M = y - 6x^2$ and $N = x + y^2 \Rightarrow \frac{\partial M}{\partial x} = -12x, \frac{\partial M}{\partial y} = 1, \frac{\partial N}{\partial x} = 1, \frac{\partial N}{\partial y} = 2y \Rightarrow \text{Flux} = \iint_R \left(\frac{\partial M}{\partial x} + \frac{\partial N}{\partial y}\right) \, dx \, dy$
 $= \iint_R (-12x + 2y) \, dx \, dy = \int_0^1 \int_y^1 (-12x + 2y) \, dx \, dy = \int_0^1 (4y^2 + 2y - 6) \, dy = -\frac{11}{3};$
 $\text{Circ} = \iint_R \left(\frac{\partial N}{\partial x} - \frac{\partial M}{\partial y}\right) \, dx \, dy = \iint_R (1 - 1) \, dx \, dy = 0$

51. $M = -\frac{\cos y}{x}$ and $N = \ln x \sin y \Rightarrow \frac{\partial M}{\partial y} = \frac{\sin y}{x}$ and $\frac{\partial N}{\partial x} = \frac{\sin y}{x} \Rightarrow \oint_C \ln x \sin y \, dy - \frac{\cos y}{x} \, dx$
 $= \iint_R \left(\frac{\partial N}{\partial x} - \frac{\partial M}{\partial y}\right) \, dx \, dy = \iint_R \left(\frac{\sin y}{x} - \frac{\sin y}{x}\right) \, dx \, dy = 0$

52. (a) Let $M = x$ and $N = y \Rightarrow \frac{\partial M}{\partial x} = 1, \frac{\partial M}{\partial y} = 0, \frac{\partial N}{\partial x} = 0, \frac{\partial N}{\partial y} = 1 \Rightarrow \text{Flux} = \iint_{\mathbf{R}} \left(\frac{\partial M}{\partial x} + \frac{\partial N}{\partial y} \right) dx dy$
 $= \iint_{\mathbf{R}} (1 + 1) dx dy = 2 \iint_{\mathbf{R}} dx dy = 2(\text{Area of the region})$
- (b) Let C be a closed curve to which Green's Theorem applies and let \mathbf{n} be the unit normal vector to C . Let $\mathbf{F} = x\mathbf{i} + y\mathbf{j}$ and assume \mathbf{F} is orthogonal to \mathbf{n} at every point of C . Then the flux density of \mathbf{F} at every point of C is 0 since $\mathbf{F} \cdot \mathbf{n} = 0$ at every point of $C \Rightarrow \frac{\partial M}{\partial x} + \frac{\partial N}{\partial y} = 0$ at every point of C
 $\Rightarrow \text{Flux} = \iint_{\mathbf{R}} \left(\frac{\partial M}{\partial x} + \frac{\partial N}{\partial y} \right) dx dy = \iint_{\mathbf{R}} 0 dx dy = 0$. But part (a) above states that the flux is $2(\text{Area of the region}) \Rightarrow$ the area of the region would be 0 \Rightarrow contradiction. Therefore, \mathbf{F} cannot be orthogonal to \mathbf{n} at every point of C .
53. $\frac{\partial}{\partial x}(2xy) = 2y, \frac{\partial}{\partial y}(2yz) = 2z, \frac{\partial}{\partial z}(2xz) = 2x \Rightarrow \nabla \cdot \mathbf{F} = 2y + 2z + 2x \Rightarrow \text{Flux} = \iiint_{\mathbf{D}} (2x + 2y + 2z) dV$
 $= \int_0^1 \int_0^1 \int_0^1 (2x + 2y + 2z) dx dy dz = \int_0^1 \int_0^1 (1 + 2y + 2z) dy dz = \int_0^1 (2 + 2z) dz = 3$
54. $\frac{\partial}{\partial x}(xz) = z, \frac{\partial}{\partial y}(yz) = z, \frac{\partial}{\partial z}(1) = 0 \Rightarrow \nabla \cdot \mathbf{F} = 2z \Rightarrow \text{Flux} = \iiint_{\mathbf{D}} 2z r dr d\theta dz$
 $= \int_0^{2\pi} \int_0^4 \int_3^{\sqrt{25-r^2}} 2z dz r dr d\theta = \int_0^{2\pi} \int_0^4 r(16 - r^2) dr d\theta = \int_0^{2\pi} 64 d\theta = 128\pi$
55. $\frac{\partial}{\partial x}(-2x) = -2, \frac{\partial}{\partial y}(-3y) = -3, \frac{\partial}{\partial z}(z) = 1 \Rightarrow \nabla \cdot \mathbf{F} = -4; x^2 + y^2 + z^2 = 2$ and $x^2 + y^2 = z \Rightarrow z = 1$
 $\Rightarrow x^2 + y^2 = 1 \Rightarrow \text{Flux} = \iiint_{\mathbf{D}} -4 dV = -4 \int_0^{2\pi} \int_0^1 \int_{r^2}^{\sqrt{2-r^2}} dz r dr d\theta = -4 \int_0^{2\pi} \int_0^1 (r\sqrt{2-r^2} - r^3) dr d\theta$
 $= -4 \int_0^{2\pi} \left(-\frac{7}{12} + \frac{2}{3}\sqrt{2} \right) d\theta = \frac{2}{3}\pi(7 - 8\sqrt{2})$
56. $\frac{\partial}{\partial x}(6x + y) = 6, \frac{\partial}{\partial y}(-x - z) = 0, \frac{\partial}{\partial z}(4yz) = 4y \Rightarrow \nabla \cdot \mathbf{F} = 6 + 4y; z = \sqrt{x^2 + y^2} = r$
 $\Rightarrow \text{Flux} = \iiint_{\mathbf{D}} (6 + 4y) dV = \int_0^{\pi/2} \int_0^1 \int_0^r (6 + 4r \sin \theta) dz r dr d\theta = \int_0^{\pi/2} \int_0^1 (6r^2 + 4r^3 \sin \theta) dr d\theta$
 $= \int_0^{\pi/2} (2 + \sin \theta) d\theta = \pi + 1$
57. $\mathbf{F} = y\mathbf{i} + z\mathbf{j} + x\mathbf{k} \Rightarrow \nabla \cdot \mathbf{F} = 0 \Rightarrow \text{Flux} = \iint_{\mathbf{S}} \mathbf{F} \cdot \mathbf{n} d\sigma = \iiint_{\mathbf{D}} \nabla \cdot \mathbf{F} dV = 0$
58. $\mathbf{F} = 3xz^2\mathbf{i} + y\mathbf{j} - z^3\mathbf{k} \Rightarrow \nabla \cdot \mathbf{F} = 3z^2 + 1 - 3z^2 = 1 \Rightarrow \text{Flux} = \iint_{\mathbf{S}} \mathbf{F} \cdot \mathbf{n} d\sigma = \iiint_{\mathbf{D}} \nabla \cdot \mathbf{F} dV$
 $= \int_0^4 \int_0^{\sqrt{16-x^2}/2} \int_0^{y/2} 1 dz dy dx = \int_0^4 \left(\frac{16-x^2}{16} \right) dx = \left[x - \frac{x^3}{48} \right]_0^4 = \frac{8}{3}$
59. $\mathbf{F} = xy^2\mathbf{i} + x^2y\mathbf{j} + y\mathbf{k} \Rightarrow \nabla \cdot \mathbf{F} = y^2 + x^2 + 0 \Rightarrow \text{Flux} = \iint_{\mathbf{S}} \mathbf{F} \cdot \mathbf{n} d\sigma = \iiint_{\mathbf{D}} \nabla \cdot \mathbf{F} dV$
 $= \iiint_{\mathbf{D}} (x^2 + y^2) dV = \int_0^{2\pi} \int_0^1 \int_{-1}^1 r^2 dz r dr d\theta = \int_0^{2\pi} \int_0^1 2r^3 dr d\theta = \int_0^{2\pi} \frac{1}{2} d\theta = \pi$
60. (a) $\mathbf{F} = (3z + 1)\mathbf{k} \Rightarrow \nabla \cdot \mathbf{F} = 3 \Rightarrow \text{Flux across the hemisphere} = \iint_{\mathbf{S}} \mathbf{F} \cdot \mathbf{n} d\sigma = \iiint_{\mathbf{D}} \nabla \cdot \mathbf{F} dV$
 $= \iiint_{\mathbf{D}} 3 dV = 3 \left(\frac{1}{2} \right) \left(\frac{4}{3} \pi a^3 \right) = 2\pi a^3$
- (b) $f(x, y, z) = x^2 + y^2 + z^2 - a^2 = 0 \Rightarrow \nabla f = 2x\mathbf{i} + 2y\mathbf{j} + 2z\mathbf{k} \Rightarrow |\nabla f| = \sqrt{4x^2 + 4y^2 + 4z^2} = \sqrt{4a^2} = 2a$ since $a \geq 0 \Rightarrow \mathbf{n} = \frac{2x\mathbf{i} + 2y\mathbf{j} + 2z\mathbf{k}}{2a} = \frac{x\mathbf{i} + y\mathbf{j} + z\mathbf{k}}{a} \Rightarrow \mathbf{F} \cdot \mathbf{n} = (3z + 1) \left(\frac{z}{a} \right); \mathbf{p} = \mathbf{k} \Rightarrow \nabla f \cdot \mathbf{p} = \nabla f \cdot \mathbf{k} = 2z$

$$\begin{aligned} \Rightarrow |\nabla f \cdot \mathbf{p}| &= 2z \text{ since } z \geq 0 \Rightarrow d\sigma = \frac{|\nabla f|}{|\nabla f \cdot \mathbf{p}|} = \frac{2a}{2z} dA = \frac{a}{z} dA \Rightarrow \iint_S \mathbf{F} \cdot \mathbf{n} d\sigma = \iint_{R_{xy}} (3z+1) \left(\frac{z}{a}\right) \left(\frac{a}{z}\right) dA \\ &= \iint_{R_{xy}} (3z+1) dx dy = \iint_{R_{xy}} (3\sqrt{a^2 - x^2 - y^2} + 1) dx dy = \int_0^{2\pi} \int_0^a (3\sqrt{a^2 - r^2} + 1) r dr d\theta \\ &= \int_0^{2\pi} \left(\frac{a^2}{2} + a^3\right) d\theta = \pi a^2 + 2\pi a^3, \text{ which is the flux across the hemisphere. Across the base we find} \\ \mathbf{F} &= [3(0) + 1]\mathbf{k} = \mathbf{k} \text{ since } z = 0 \text{ in the } xy\text{-plane} \Rightarrow \mathbf{n} = -\mathbf{k} \text{ (outward normal)} \Rightarrow \mathbf{F} \cdot \mathbf{n} = -1 \Rightarrow \text{Flux across} \\ \text{the base} &= \iint_S \mathbf{F} \cdot \mathbf{n} d\sigma = \iint_{R_{xy}} -1 dx dy = -\pi a^2. \text{ Therefore, the total flux across the closed surface is} \\ &(\pi a^2 + 2\pi a^3) - \pi a^2 = 2\pi a^3. \end{aligned}$$

CHAPTER 16 ADDITIONAL AND ADVANCED EXERCISES

- $dx = (-2 \sin t + 2 \sin 2t) dt$ and $dy = (2 \cos t - 2 \cos 2t) dt$; Area $= \frac{1}{2} \oint_C x dy - y dx$
 $= \frac{1}{2} \int_0^{2\pi} [(2 \cos t - \cos 2t)(2 \cos t - 2 \cos 2t) - (2 \sin t - \sin 2t)(-2 \sin t + 2 \sin 2t)] dt$
 $= \frac{1}{2} \int_0^{2\pi} [6 - (6 \cos t \cos 2t + 6 \sin t \sin 2t)] dt = \frac{1}{2} \int_0^{2\pi} (6 - 6 \cos t) dt = 6\pi$
- $dx = (-2 \sin t - 2 \sin 2t) dt$ and $dy = (2 \cos t - 2 \cos 2t) dt$; Area $= \frac{1}{2} \oint_C x dy - y dx$
 $= \frac{1}{2} \int_0^{2\pi} [(2 \cos t + \cos 2t)(2 \cos t - 2 \cos 2t) - (2 \sin t - \sin 2t)(-2 \sin t - 2 \sin 2t)] dt$
 $= \frac{1}{2} \int_0^{2\pi} [2 - 2(\cos t \cos 2t - \sin t \sin 2t)] dt = \frac{1}{2} \int_0^{2\pi} (2 - 2 \cos 3t) dt = \frac{1}{2} [2t - \frac{2}{3} \sin 3t]_0^{2\pi} = 2\pi$
- $dx = \cos 2t dt$ and $dy = \cos t dt$; Area $= \frac{1}{2} \oint_C x dy - y dx = \frac{1}{2} \int_0^\pi (\frac{1}{2} \sin 2t \cos t - \sin t \cos 2t) dt$
 $= \frac{1}{2} \int_0^\pi [\sin t \cos^2 t - (\sin t)(2 \cos^2 t - 1)] dt = \frac{1}{2} \int_0^\pi (-\sin t \cos^2 t + \sin t) dt = \frac{1}{2} [\frac{1}{3} \cos^3 t - \cos t]_0^\pi = -\frac{1}{3} + 1 = \frac{2}{3}$
- $dx = (-2a \sin t - 2a \cos 2t) dt$ and $dy = (b \cos t) dt$; Area $= \frac{1}{2} \oint_C x dy - y dx$
 $= \frac{1}{2} \int_0^{2\pi} [(2ab \cos^2 t - ab \cos t \sin 2t) - (-2ab \sin^2 t - 2ab \sin t \cos 2t)] dt$
 $= \frac{1}{2} \int_0^{2\pi} [2ab - 2ab \cos^2 t \sin t + 2ab(\sin t)(2 \cos^2 t - 1)] dt = \frac{1}{2} \int_0^{2\pi} (2ab + 2ab \cos^2 t \sin t - 2ab \sin t) dt$
 $= \frac{1}{2} [2abt - \frac{2}{3} ab \cos^3 t + 2ab \cos t]_0^{2\pi} = 2\pi ab$
- (a) $\mathbf{F}(x, y, z) = z\mathbf{i} + x\mathbf{j} + y\mathbf{k}$ is $\mathbf{0}$ only at the point $(0, 0, 0)$, and $\text{curl } \mathbf{F}(x, y, z) = \mathbf{i} + \mathbf{j} + \mathbf{k}$ is never $\mathbf{0}$.

(b) $\mathbf{F}(x, y, z) = z\mathbf{i} + y\mathbf{k}$ is $\mathbf{0}$ only on the line $x = t, y = 0, z = 0$ and $\text{curl } \mathbf{F}(x, y, z) = \mathbf{i} + \mathbf{j}$ is never $\mathbf{0}$.

(c) $\mathbf{F}(x, y, z) = z\mathbf{i}$ is $\mathbf{0}$ only when $z = 0$ (the xy -plane) and $\text{curl } \mathbf{F}(x, y, z) = \mathbf{j}$ is never $\mathbf{0}$.
- $\mathbf{F} = yz^2\mathbf{i} + xz^2\mathbf{j} + 2xyz\mathbf{k}$ and $\mathbf{n} = \frac{x\mathbf{i} + y\mathbf{j} + z\mathbf{k}}{\sqrt{x^2 + y^2 + z^2}} = \frac{x\mathbf{i} + y\mathbf{j} + z\mathbf{k}}{R}$, so \mathbf{F} is parallel to \mathbf{n} when $yz^2 = \frac{cx}{R}, xz^2 = \frac{cy}{R}$,
and $2xyz = \frac{cz}{R} \Rightarrow \frac{yz^2}{x} = \frac{xz^2}{y} = 2xy \Rightarrow y^2 = x^2 \Rightarrow y = \pm x$ and $z^2 = \pm \frac{c}{R} = 2x^2 \Rightarrow z = \pm \sqrt{2}x$. Also,
 $x^2 + y^2 + z^2 = R^2 \Rightarrow x^2 + x^2 + 2x^2 = R^2 \Rightarrow 4x^2 = R^2 \Rightarrow x = \pm \frac{R}{2}$. Thus the points are: $(\frac{R}{2}, \frac{R}{2}, \frac{\sqrt{2}R}{2})$,
 $(\frac{R}{2}, \frac{R}{2}, -\frac{\sqrt{2}R}{2})$, $(-\frac{R}{2}, -\frac{R}{2}, \frac{\sqrt{2}R}{2})$, $(-\frac{R}{2}, -\frac{R}{2}, -\frac{\sqrt{2}R}{2})$, $(\frac{R}{2}, -\frac{R}{2}, \frac{\sqrt{2}R}{2})$, $(\frac{R}{2}, -\frac{R}{2}, -\frac{\sqrt{2}R}{2})$,
 $(-\frac{R}{2}, \frac{R}{2}, \frac{\sqrt{2}R}{2})$, $(-\frac{R}{2}, \frac{R}{2}, -\frac{\sqrt{2}R}{2})$
- Set up the coordinate system so that $(a, b, c) = (0, R, 0) \Rightarrow \delta(x, y, z) = \sqrt{x^2 + (y - R)^2 + z^2}$
 $= \sqrt{x^2 + y^2 + z^2 - 2Ry + R^2} = \sqrt{2R^2 - 2Ry}$; let $f(x, y, z) = x^2 + y^2 + z^2 - R^2$ and $\mathbf{p} = \mathbf{i}$
 $\Rightarrow \nabla f = 2x\mathbf{i} + 2y\mathbf{j} + 2z\mathbf{k} \Rightarrow |\nabla f| = 2\sqrt{x^2 + y^2 + z^2} = 2R \Rightarrow d\sigma = \frac{|\nabla f|}{|\nabla f \cdot \mathbf{i}|} dz dy = \frac{2R}{2x} dz dy$

$$\begin{aligned} \Rightarrow \text{Mass} &= \iint_S \delta(x, y, z) \, d\sigma = \iint_{R_{yz}} \sqrt{2R^2 - 2Ry} \left(\frac{R}{x}\right) \, dz \, dy = R \iint_{R_{yz}} \frac{\sqrt{2R^2 - 2Ry}}{\sqrt{R^2 - y^2 - z^2}} \, dz \, dy \\ &= 4R \int_{-R}^R \int_0^{\sqrt{R^2 - y^2}} \frac{\sqrt{2R^2 - 2Ry}}{\sqrt{R^2 - y^2 - z^2}} \, dz \, dy = 4R \int_{-R}^R \sqrt{2R^2 - 2Ry} \sin^{-1} \left(\frac{z}{\sqrt{R^2 - y^2}} \right) \Big|_0^{\sqrt{R^2 - y^2}} \, dy \\ &= 2\pi R \int_{-R}^R \sqrt{2R^2 - 2Ry} \, dy = 2\pi R \left(\frac{1}{3R} \right) (2R^2 - 2Ry)^{3/2} \Big|_{-R}^R = \frac{16\pi R^3}{3} \end{aligned}$$

8. $\mathbf{r}(r, \theta) = (r \cos \theta)\mathbf{i} + (r \sin \theta)\mathbf{j} + \theta\mathbf{k}$, $0 \leq r \leq 1$, $0 \leq \theta \leq 2\pi \Rightarrow \mathbf{r}_r \times \mathbf{r}_\theta = \begin{vmatrix} \mathbf{i} & \mathbf{j} & \mathbf{k} \\ \cos \theta & \sin \theta & 0 \\ -r \sin \theta & r \cos \theta & 1 \end{vmatrix}$

$$= (\sin \theta)\mathbf{i} - (\cos \theta)\mathbf{j} + r\mathbf{k} \Rightarrow |\mathbf{r}_r \times \mathbf{r}_\theta| = \sqrt{1 + r^2}; \delta = 2\sqrt{x^2 + y^2} = 2\sqrt{r^2 \cos^2 \theta + r^2 \sin^2 \theta} = 2r$$

$$\Rightarrow \text{Mass} = \iint_S \delta(x, y, z) \, d\sigma = \int_0^{2\pi} \int_0^1 2r\sqrt{1 + r^2} \, dr \, d\theta = \int_0^{2\pi} \left[\frac{2}{3} (1 + r^2)^{3/2} \right]_0^1 \, d\theta = \int_0^{2\pi} \frac{2}{3} (2\sqrt{2} - 1) \, d\theta$$

$$= \frac{4\pi}{3} (2\sqrt{2} - 1)$$

9. $M = x^2 + 4xy$ and $N = -6y \Rightarrow \frac{\partial M}{\partial x} = 2x + 4y$ and $\frac{\partial N}{\partial x} = -6 \Rightarrow \text{Flux} = \int_0^b \int_0^a (2x + 4y - 6) \, dx \, dy$

$$= \int_0^b (a^2 + 4ay - 6a) \, dy = a^2b + 2ab^2 - 6ab.$$

We want to minimize $f(a, b) = a^2b + 2ab^2 - 6ab = ab(a + 2b - 6)$. Thus, $f_a(a, b) = 2ab + 2b^2 - 6b = 0$ and $f_b(a, b) = a^2 + 4ab - 6a = 0 \Rightarrow b(2a + 2b - 6) = 0 \Rightarrow b = 0$ or $b = -a + 3$. Now $b = 0 \Rightarrow a^2 - 6a = 0 \Rightarrow a = 0$ or $a = 6 \Rightarrow (0, 0)$ and $(6, 0)$ are critical points. On the other hand, $b = -a + 3 \Rightarrow a^2 + 4a(-a + 3) - 6a = 0 \Rightarrow -3a^2 + 6a = 0 \Rightarrow a = 0$ or $a = 2 \Rightarrow (0, 3)$ and $(2, 1)$ are also critical points. The flux at $(0, 0) = 0$, the flux at $(6, 0) = 0$, the flux at $(0, 3) = 0$ and the flux at $(2, 1) = -4$. Therefore, the flux is minimized at $(2, 1)$ with value -4 .

10. A plane through the origin has equation $ax + by + cz = 0$. Consider first the case when $c \neq 0$. Assume the plane is given by $z = ax + by$ and let $f(x, y, z) = x^2 + y^2 + z^2 = 4$. Let C denote the circle of intersection of the plane with the sphere. By Stokes's Theorem, $\oint_C \mathbf{F} \cdot d\mathbf{r} = \iint_S \nabla \times \mathbf{F} \cdot \mathbf{n} \, d\sigma$, where \mathbf{n} is a unit normal to the plane. Let

$$\mathbf{r}(x, y) = x\mathbf{i} + y\mathbf{j} + (ax + by)\mathbf{k} \text{ be a parametrization of the surface. Then } \mathbf{r}_x \times \mathbf{r}_y = \begin{vmatrix} \mathbf{i} & \mathbf{j} & \mathbf{k} \\ 1 & 0 & a \\ 0 & 1 & b \end{vmatrix} = -a\mathbf{i} - b\mathbf{j} + \mathbf{k}$$

$$\Rightarrow d\sigma = |\mathbf{r}_x \times \mathbf{r}_y| \, dx \, dy = \sqrt{a^2 + b^2 + 1} \, dx \, dy. \text{ Also, } \nabla \times \mathbf{F} = \begin{vmatrix} \mathbf{i} & \mathbf{j} & \mathbf{k} \\ \frac{\partial}{\partial x} & \frac{\partial}{\partial y} & \frac{\partial}{\partial z} \\ z & x & y \end{vmatrix} = \mathbf{i} + \mathbf{j} + \mathbf{k} \text{ and } \mathbf{n} = \frac{a\mathbf{i} + b\mathbf{j} + \mathbf{k}}{\sqrt{a^2 + b^2 + 1}}$$

$$\Rightarrow \iint_S \nabla \times \mathbf{F} \cdot \mathbf{n} \, d\sigma = \iint_{R_{xy}} \frac{a+b-1}{\sqrt{a^2+b^2+1}} \sqrt{a^2+b^2+1} \, dx \, dy = \iint_{R_{xy}} (a+b-1) \, dx \, dy = (a+b-1) \iint_{R_{xy}} dx \, dy. \text{ Now}$$

$$x^2 + y^2 + (ax + by)^2 = 4 \Rightarrow \left(\frac{a^2+1}{4}\right)x^2 + \left(\frac{b^2+1}{4}\right)y^2 + \left(\frac{ab}{2}\right)xy = 1 \Rightarrow \text{the region } R_{xy} \text{ is the interior of the ellipse } Ax^2 + Bxy + Cy^2 = 1 \text{ in the } xy\text{-plane, where } A = \frac{a^2+1}{4}, B = \frac{ab}{2}, \text{ and } C = \frac{b^2+1}{4}.$$

By Exercise 47 in Section 10.3, the area of the ellipse is $\frac{2\pi}{\sqrt{4AC - B^2}} = \frac{4\pi}{\sqrt{a^2 + b^2 + 1}} \Rightarrow \oint_C \mathbf{F} \cdot d\mathbf{r} = h(a, b) = \frac{4\pi(a+b-1)}{\sqrt{a^2 + b^2 + 1}}$.

Thus we optimize $H(a, b) = \frac{(a+b-1)^2}{a^2+b^2+1}$: $\frac{\partial H}{\partial a} = \frac{2(a+b-1)(b^2+1+a-ab)}{(a^2+b^2+1)^2} = 0$ and

$$\frac{\partial H}{\partial b} = \frac{2(a+b-1)(a^2+1+b-ab)}{(a^2+b^2+1)^2} = 0 \Rightarrow a+b-1=0, \text{ or } b^2+1+a-ab=0 \text{ and } a^2+1+b-ab=0$$

$$\Rightarrow a+b-1=0, \text{ or } a^2-b^2+(b-a)=0 \Rightarrow a+b-1=0, \text{ or } (a-b)(a+b-1)=0 \Rightarrow a+b-1=0 \text{ or } a=b.$$

The critical values $a+b-1=0$ give a saddle. If $a=b$, then $0 = b^2 + 1 + a - ab \Rightarrow a^2 + 1 + a - a^2 = 0$

$$\Rightarrow a = -1 \Rightarrow b = -1. \text{ Thus, the point } (a, b) = (-1, -1) \text{ gives a local extremum for } \oint_C \mathbf{F} \cdot d\mathbf{r} \Rightarrow z = -x - y$$

$$\Rightarrow x + y + z = 0 \text{ is the desired plane, if } c \neq 0.$$

Note: Since $h(-1, -1)$ is negative, the circulation about \mathbf{n} is clockwise, so $-\mathbf{n}$ is the correct pointing normal for

the counterclockwise circulation. Thus $\iint_S \nabla \times \mathbf{F} \cdot (-\mathbf{n}) \, d\sigma$ actually gives the maximum circulation.

If $c = 0$, one can see that the corresponding problem is equivalent to the calculation above when $b = 0$, which does not lead to a local extreme.

11. (a) Partition the string into small pieces. Let $\Delta_i s$ be the length of the i^{th} piece. Let (x_i, y_i) be a point in the i^{th} piece. The work done by gravity in moving the i^{th} piece to the x -axis is approximately $W_i = (gx_i y_i \Delta_i s) y_i$ where $x_i y_i \Delta_i s$ is approximately the mass of the i^{th} piece. The total work done by gravity in moving the string to the x -axis is $\sum_i W_i = \sum_i gx_i y_i^2 \Delta_i s \Rightarrow \text{Work} = \int_C gxy^2 \, ds$
- (b) $\text{Work} = \int_C gxy^2 \, ds = \int_0^{\pi/2} g(2 \cos t)(4 \sin^2 t) \sqrt{4 \sin^2 t + 4 \cos^2 t} \, dt = 16g \int_0^{\pi/2} \cos t \sin^2 t \, dt$
 $= \left[16g \left(\frac{\sin^3 t}{3} \right) \right]_0^{\pi/2} = \frac{16}{3} g$
- (c) $\bar{x} = \frac{\int_C x(xy) \, ds}{\int_C xy \, ds}$ and $\bar{y} = \frac{\int_C y(xy) \, ds}{\int_C xy \, ds}$; the mass of the string is $\int_C xy \, ds$ and the weight of the string is $g \int_C xy \, ds$. Therefore, the work done in moving the point mass at (\bar{x}, \bar{y}) to the x -axis is $W = \left(g \int_C xy \, ds \right) \bar{y} = g \int_C xy^2 \, ds = \frac{16}{3} g$.
12. (a) Partition the sheet into small pieces. Let $\Delta_i \sigma$ be the area of the i^{th} piece and select a point (x_i, y_i, z_i) in the i^{th} piece. The mass of the i^{th} piece is approximately $x_i y_i \Delta_i \sigma$. The work done by gravity in moving the i^{th} piece to the xy -plane is approximately $(gx_i y_i \Delta_i \sigma) z_i = gx_i y_i z_i \Delta_i \sigma \Rightarrow \text{Work} = \iint_S gxyz \, d\sigma$.
- (b) $\iint_S gxyz \, d\sigma = g \iint_{R_{xy}} xy(1-x-y) \sqrt{1+(-1)^2+(-1)^2} \, dA = \sqrt{3}g \int_0^1 \int_0^{1-x} (xy - x^2y - xy^2) \, dy \, dx$
 $= \sqrt{3}g \int_0^1 \left[\frac{1}{2} xy^2 - \frac{1}{2} x^2 y^2 - \frac{1}{3} xy^3 \right]_0^{1-x} \, dx = \sqrt{3}g \int_0^1 \left[\frac{1}{6} x - \frac{1}{2} x^2 + \frac{1}{2} x^3 - \frac{1}{6} x^4 \right] \, dx$
 $= \sqrt{3}g \left[\frac{1}{12} x^2 - \frac{1}{6} x^3 + \frac{1}{6} x^4 - \frac{1}{30} x^5 \right]_0^1 = \sqrt{3}g \left(\frac{1}{12} - \frac{1}{30} \right) = \frac{\sqrt{3}g}{20}$
- (c) The center of mass of the sheet is the point $(\bar{x}, \bar{y}, \bar{z})$ where $\bar{z} = \frac{M_{xy}}{M}$ with $M_{xy} = \iint_S xyz \, d\sigma$ and $M = \iint_S xy \, d\sigma$. The work done by gravity in moving the point mass at $(\bar{x}, \bar{y}, \bar{z})$ to the xy -plane is $gM\bar{z} = gM \left(\frac{M_{xy}}{M} \right) = gM_{xy} = \iint_S gxyz \, d\sigma = \frac{\sqrt{3}g}{20}$.
13. (a) Partition the sphere $x^2 + y^2 + (z-2)^2 = 1$ into small pieces. Let $\Delta_i \sigma$ be the surface area of the i^{th} piece and let (x_i, y_i, z_i) be a point on the i^{th} piece. The force due to pressure on the i^{th} piece is approximately $w(4-z_i)\Delta_i \sigma$. The total force on S is approximately $\sum_i w(4-z_i)\Delta_i \sigma$. This gives the actual force to be $\iint_S w(4-z) \, d\sigma$.
- (b) The upward buoyant force is a result of the \mathbf{k} -component of the force on the ball due to liquid pressure. The force on the ball at (x, y, z) is $w(4-z)(-\mathbf{n}) = w(z-4)\mathbf{n}$, where \mathbf{n} is the outer unit normal at (x, y, z) . Hence the \mathbf{k} -component of this force is $w(z-4)\mathbf{n} \cdot \mathbf{k} = w(z-4)\mathbf{k} \cdot \mathbf{n}$. The (magnitude of the) buoyant force on the ball is obtained by adding up all these \mathbf{k} -components to obtain $\iint_S w(z-4)\mathbf{k} \cdot \mathbf{n} \, d\sigma$.
- (c) The Divergence Theorem says $\iint_S w(z-4)\mathbf{k} \cdot \mathbf{n} \, d\sigma = \iiint_D \text{div}(w(z-4)\mathbf{k}) \, dV = \iiint_D w \, dV$, where D is $x^2 + y^2 + (z-2)^2 \leq 1 \Rightarrow \iint_S w(z-4)\mathbf{k} \cdot \mathbf{n} \, d\sigma = w \iiint_D 1 \, dV = \frac{4}{3} \pi w$, the weight of the fluid if it were to occupy the region D .

14. The surface S is $z = \sqrt{x^2 + y^2}$ from $z = 1$ to $z = 2$. Partition S into small pieces and let $\Delta_i\sigma$ be the area of the i^{th} piece. Let (x_i, y_i, z_i) be a point on the i^{th} piece. Then the magnitude of the force on the i^{th} piece due to liquid pressure is approximately $F_i = w(2 - z_i)\Delta_i\sigma \Rightarrow$ the total force on S is approximately

$$\begin{aligned}\sum_i F_i &= \sum w(2 - z_i)\Delta_i\sigma \Rightarrow \text{the actual force is } \iint_S w(2 - z) \, d\sigma = \iint_{R_{xy}} w(2 - \sqrt{x^2 + y^2}) \sqrt{1 + \frac{x^2}{x^2 + y^2} + \frac{y^2}{x^2 + y^2}} \, dA \\ &= \iint_{R_{xy}} \sqrt{2} w (2 - \sqrt{x^2 + y^2}) \, dA = \int_0^{2\pi} \int_1^2 \sqrt{2} w (2 - r) r \, dr \, d\theta = \int_0^{2\pi} \sqrt{2} w [r^2 - \frac{1}{3} r^3]_1^2 \, d\theta = \int_0^{2\pi} \frac{2\sqrt{2}w}{3} \, d\theta \\ &= \frac{4\sqrt{2}\pi w}{3}\end{aligned}$$

15. Assume that S is a surface to which Stokes's Theorem applies. Then $\oint_C \mathbf{E} \cdot d\mathbf{r} = \iint_S (\nabla \times \mathbf{E}) \cdot \mathbf{n} \, d\sigma$
 $= \iint_S -\frac{\partial \mathbf{B}}{\partial t} \cdot \mathbf{n} \, d\sigma = -\frac{\partial}{\partial t} \iint_S \mathbf{B} \cdot \mathbf{n} \, d\sigma$. Thus the voltage around a loop equals the negative of the rate of change of magnetic flux through the loop.

16. According to Gauss's Law, $\iint_S \mathbf{F} \cdot \mathbf{n} \, d\sigma = 4\pi GmM$ for any surface enclosing the origin. But if $\mathbf{F} = \nabla \times \mathbf{H}$ then the integral over such a closed surface would have to be 0 by the Divergence Theorem since $\text{div } \mathbf{F} = 0$.

$$\begin{aligned}17. \oint_C f \nabla g \cdot d\mathbf{r} &= \iint_S \nabla \times (f \nabla g) \cdot \mathbf{n} \, d\sigma && \text{(Stokes's Theorem)} \\ &= \iint_S (f \nabla \times \nabla g + \nabla f \times \nabla g) \cdot \mathbf{n} \, d\sigma && \text{(Section 16.8, Exercise 19b)} \\ &= \iint_S [(f)(\mathbf{0}) + \nabla f \times \nabla g] \cdot \mathbf{n} \, d\sigma && \text{(Section 16.7, Equation 8)} \\ &= \iint_S (\nabla f \times \nabla g) \cdot \mathbf{n} \, d\sigma\end{aligned}$$

18. $\nabla \times \mathbf{F}_1 = \nabla \times \mathbf{F}_2 \Rightarrow \nabla \times (\mathbf{F}_2 - \mathbf{F}_1) = \mathbf{0} \Rightarrow \mathbf{F}_2 - \mathbf{F}_1$ is conservative $\Rightarrow \mathbf{F}_2 - \mathbf{F}_1 = \nabla f$; also, $\nabla \cdot \mathbf{F}_1 = \nabla \cdot \mathbf{F}_2 \Rightarrow \nabla \cdot (\mathbf{F}_2 - \mathbf{F}_1) = 0 \Rightarrow \nabla^2 f = 0$ (so f is harmonic). Finally, on the surface S , $\nabla f \cdot \mathbf{n} = (\mathbf{F}_2 - \mathbf{F}_1) \cdot \mathbf{n} = \mathbf{F}_2 \cdot \mathbf{n} - \mathbf{F}_1 \cdot \mathbf{n} = 0$. Now, $\nabla \cdot (f \nabla f) = \nabla f \cdot \nabla f + f \nabla^2 f$ so the Divergence Theorem gives $\iint_D |\nabla f|^2 \, dV + \iint_D f \nabla^2 f \, dV = \iint_D \nabla \cdot (f \nabla f) \, dV = \iint_S f \nabla f \cdot \mathbf{n} \, d\sigma = 0$, and since $\nabla^2 f = 0$ we have $\iint_D |\nabla f|^2 \, dV + 0 = 0 \Rightarrow \iint_D |\mathbf{F}_2 - \mathbf{F}_1|^2 \, dV = 0 \Rightarrow \mathbf{F}_2 - \mathbf{F}_1 = \mathbf{0} \Rightarrow \mathbf{F}_2 = \mathbf{F}_1$, as claimed.

$$19. \text{False; let } \mathbf{F} = y\mathbf{i} + x\mathbf{j} \neq \mathbf{0} \Rightarrow \nabla \cdot \mathbf{F} = \frac{\partial}{\partial x}(y) + \frac{\partial}{\partial y}(x) = 0 \text{ and } \nabla \times \mathbf{F} = \begin{vmatrix} \mathbf{i} & \mathbf{j} & \mathbf{k} \\ \frac{\partial}{\partial x} & \frac{\partial}{\partial y} & \frac{\partial}{\partial z} \\ x & y & 0 \end{vmatrix} = 0\mathbf{i} + 0\mathbf{j} + 0\mathbf{k} = \mathbf{0}$$

$$20. |\mathbf{r}_u \times \mathbf{r}_v|^2 = |\mathbf{r}_u|^2 |\mathbf{r}_v|^2 \sin^2 \theta = |\mathbf{r}_u|^2 |\mathbf{r}_v|^2 (1 - \cos^2 \theta) = |\mathbf{r}_u|^2 |\mathbf{r}_v|^2 - |\mathbf{r}_u|^2 |\mathbf{r}_v|^2 \cos^2 \theta = |\mathbf{r}_u|^2 |\mathbf{r}_v|^2 - (\mathbf{r}_u \cdot \mathbf{r}_v)^2 \Rightarrow |\mathbf{r}_u \times \mathbf{r}_v|^2 = \sqrt{EG - F^2} \Rightarrow d\sigma = |\mathbf{r}_u \times \mathbf{r}_v| \, du \, dv = \sqrt{EG - F^2} \, du \, dv$$

$$21. \mathbf{r} = x\mathbf{i} + y\mathbf{j} + z\mathbf{k} \Rightarrow \nabla \cdot \mathbf{r} = 1 + 1 + 1 = 3 \Rightarrow \iint_D \nabla \cdot \mathbf{r} \, dV = 3 \iint_D dV = 3V \Rightarrow V = \frac{1}{3} \iint_D \nabla \cdot \mathbf{r} \, dV = \frac{1}{3} \iint_S \mathbf{r} \cdot \mathbf{n} \, d\sigma, \text{ by the Divergence Theorem}$$

NOTES: